

# 9361 Home Cell V2.0

## 4 Channel Small Cell

### Getting Started Guide

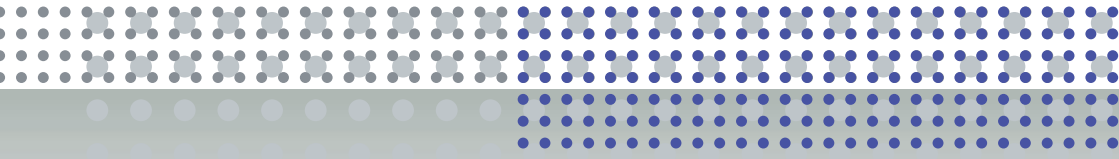

## SAFETY NOTES

**GENERAL:** Please read this Getting Started Guide carefully before using the 9361 Home Cell V2. The 9361 Home Cell V2's purpose is to provide improved mobile signal coverage inside your home. Do not use this device for any other purpose, as doing so may be dangerous.

**PLACEMENT:** The 9361 Home Cell V2 and all its components (including cables and power adaptor) should be placed in a dry, indoor area, at elevated heights such as on top of shelves, cabinets, etc. It should be kept away from any wet or damp environments; such as kitchens, bathrooms, laundry rooms or any other areas with exposure to moisture, sprays, drips, or running water. For the safety of stored data, it should not be placed near magnetic devices such as audio or video tapes, diskettes or credit cards. While in service, people should stand back at least 20 cm from the device's antenna and the antenna should not be collocated with any another antenna or transmitting device.

**MEDICAL DEVICES:** The 9361 Home Cell V2 contains a radio transmitter similar to a Wi-fi transmitter. Medical devices such as pacemakers and hearing aids may be affected when using this device. Please contact your General Practitioner for additional safety guidelines.

**EMERGENCY:** The 9361 Home Cell V2 does not operate during instances of power loss. To make emergency calls, please use a mobile or land line phones.

**POWER SUPPLY:** Only use the Power Adaptor provided with your device; do not attempt to use another power adaptor. Ensure that the power adaptor is always easily accessible and that the voltage specified corresponds to the power socket to which you connect it. In case of power loss (and therefore loss of service), all mobile calls, including emergency calls, will be redirected automatically to the default mobile (carrier) network. If you have no mobile network coverage at home and need to make an emergency call, please use a land line. In case of a thunderstorm, please disconnect the device to avoid damaging it.

**DISPOSAL & RECYCLING:** To facilitate disposal and/or recycling, please respect the sorting rules of your country or region for this kind of device. European regulations require the disposal of this device at sales points or at designated collection points such as drop-off centers, etc.



# SAFETY NOTES

<b>Model</b>	<b>TX Output Power</b>
9361 Home Cell V2.0 1900/850MHz 100mW	100mW
9361 Home Cell V2.0 1900/850MHz 20mW	20mW
9361 Home Cell V2.0 1700MHz 100mW	100mW
9361 Home Cell V2.0 1700MHz 20mW	20mW

## Federal Communication Commission Interference Statement

This equipment has been tested and found to comply with the limits for a Class B digital device, pursuant to Part 15 of the FCC Rules. These limits are designed to provide reasonable protection against harmful interference in a residential installation. This equipment generates, uses and can radiate radio frequency energy and, if not installed and used in accordance with the instructions, may cause harmful interference to radio communications. However, there is no guarantee that interference will not occur in a particular installation. If this equipment does cause harmful interference to radio or television reception, which can be determined by turning the equipment off and on, the user is encouraged to try to correct the interference by one of the following measures:

- Reorient or relocate the receiving antenna.
- Increase the separation between the equipment and receiver.
- Connect the equipment into an outlet on a circuit different from that to which the receiver is connected.
- Consult the dealer or an experienced radio/TV technician for help.

**FCC Caution:** Any changes or modifications not expressly approved by the party responsible for compliance could void the user's authority to operate this equipment.

This device complies with Part 15 of the FCC Rules. Operation is subject to the following two conditions: (1) This device may not cause harmful interference, and (2) this device must accept any interference received, including interference that may cause undesired operation.

## IMPORTANT NOTE:

### Radiation Exposure Statement:

This equipment complies with FCC radiation exposure limits set forth for an uncontrolled environment. This equipment should be installed and operated with minimum distance 20cm between the radiator & your body.

This transmitter must not be co-located or operating in conjunction with any other antenna or transmitter.

## SAFETY NOTES

### Industry Canada statement

This device complies with RSS-210 of the Industry Canada Rules. Operation is subject to the following two conditions: (1) This device may not cause harmful interference, and (2) this device must accept any interference received, including interference that may cause undesired operation.

French translation:

Ce dispositif est conforme à la norme CNR-210 d'Industrie Canada applicable aux appareils radio exempts de licence. Son fonctionnement est sujet aux deux conditions suivantes: (1) le dispositif ne doit pas produire de brouillage préjudiciable, et (2) ce dispositif doit accepter tout brouillage reçu, y compris un brouillage susceptible de provoquer un fonctionnement indésirable.

### IMPORTANT NOTE:

Radiation Exposure Statement:

This equipment complies with IC radiation exposure limits set forth for an uncontrolled environment. This equipment should be installed and operated with minimum distance 20cm between the radiator & your body.

French:

NOTE IMPORTANTE: (Pour l'utilisation de dispositifs mobiles)

Déclaration d'exposition aux radiations:

Cet équipement est conforme aux limites d'exposition aux rayonnements IC établies pour un environnement non contrôlé. Cet équipement doit être installé et utilisé avec un minimum de 20 cm de distance entre la source de rayonnement et votre corps.

# CONTENTS

Welcome .....	05
Unpacking your 9361 Home Cell V2 .....	06
Overview of the 9361 Home Cell V2 .....	06
9361 Home Cell V2 Status Indicators .....	08
Quick Setup.....	09
Final Checks & Making your First Call.....	15
Frequently Asked Questions (FAQ).....	16
Troubleshooting.....	17

Copyright © 2011 Alcatel-Lucent. All rights reserved.

The information presented is subject to change without notice. Alcatel-Lucent assumes no responsibility for inaccuracies contained herein.

## Notice of Liability

Every effort has been made to ensure that this guide contains accurate and current information. However Alcatel-Lucent and the author shall not be liable for any loss or damage suffered by readers as a result of any information contained herein.

## Trademarks

Alcatel-Lucent and the Alcatel-Lucent logo are registered trademarks of Alcatel-Lucent. All other trademarks are the property of their respective owners.

9361 Home Cell V2 - 4 Channel Small Cell Getting Started Guide: Edition 1, Published June 2011

## WELCOME

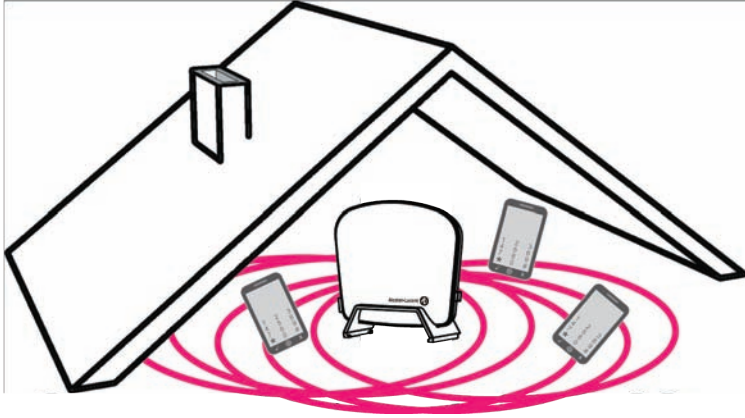

The Alcatel-Lucent 9361 Home Cell V2 provides enhanced mobile voice and data service within the home. It delivers high quality voice calls and faster, more reliable mobile data service.

The Alcatel-Lucent 9361 Home Cell V2 connects to your broadband Internet service to deliver extended indoor mobile network coverage. The mobile phone connectivity, signal quality, and data bandwidth within your home will greatly improve, especially if your home is in a remote area or out of adequate mobile phone tower range.

Inside this packaging you will find - the 9361 Home Cell V2 (similar to a Wi-fi access point) an Ethernet cable, power adaptor, and wall mounting kit. Unlike a Wi-fi access point, the 9361 Home Cell V2 has a zero touch set-up process. Just install as detailed in this guide and forget it's there because it connects to your mobile phone automatically whenever your phone is within range.

### Before you begin you need to make sure you have the following

- High Speed Internet service and an available Ethernet LAN port on your router
- An available (and nearby) power socket or electrical outlet
- 3G Mobile Phone and SIM card registered with your mobile operator for Home Cell Femtozone
- Home Cell SIM card provided by your mobile service provider (optional)

# UNPACKING YOUR 9361 HOME CELL V2

9361 Home Cell V2  
4 Channel Small Cell

Getting Started Guide (this document)

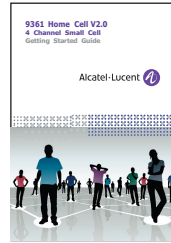
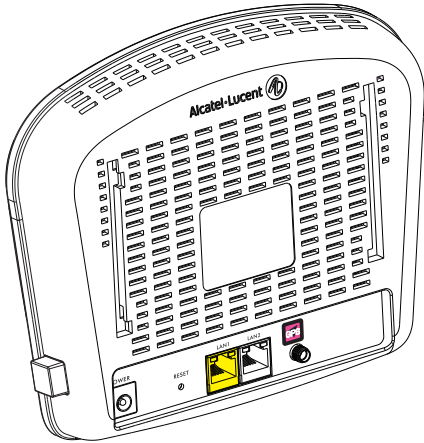

Stand

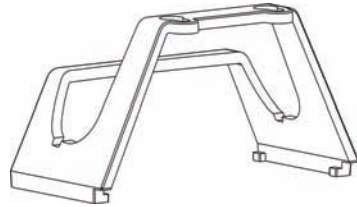

SIM Card (may be supplied if required)



Wall Mounting Kit

Cheese Head Screws (2)



Wall Anchors (2)



AC Power Adaptor

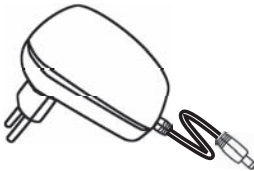

Ethernet Cable

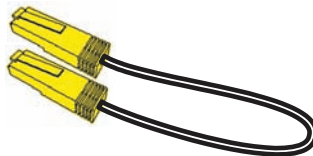

GPS Antenna (optional)

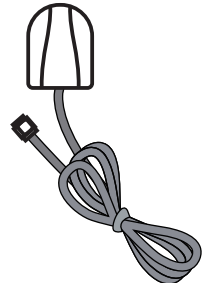

# OVERVIEW OF THE 9361 HOME CELL V2

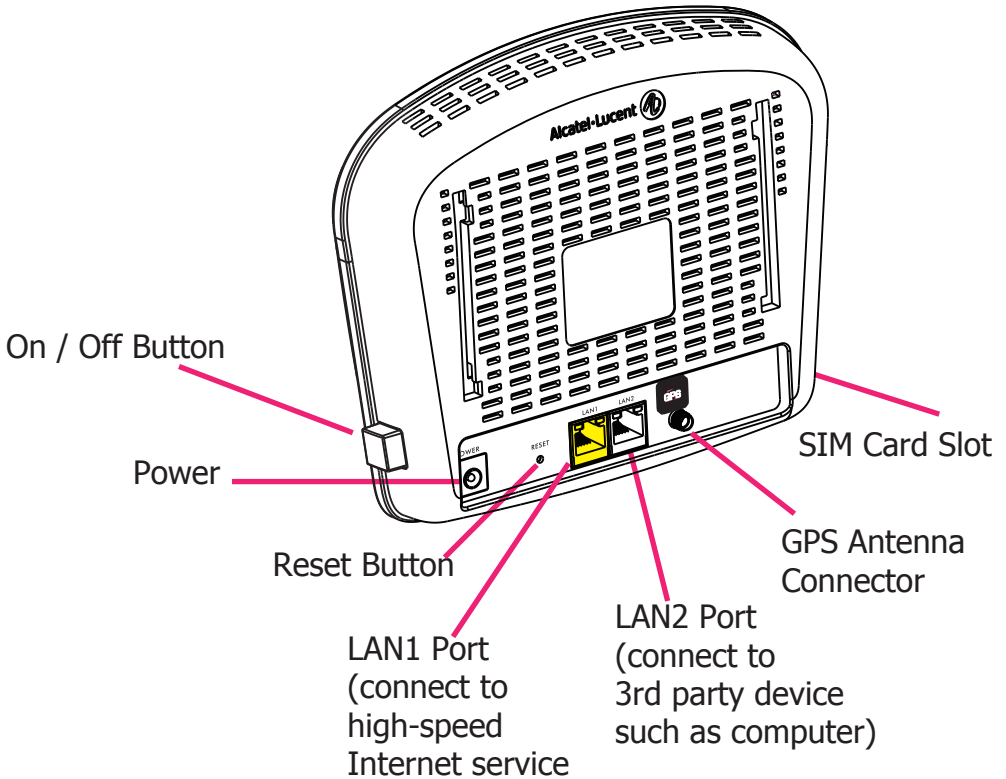
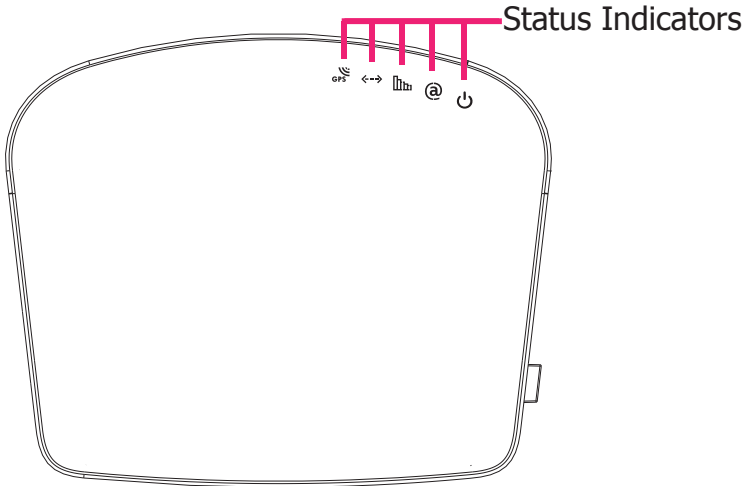



# 9361 HOME CELL V2 STATUS INDICATORS

Status indicators only become visible when the Alcatel-Lucent 9361 Home Cell V2 is powered and the appropriate feature is operational.

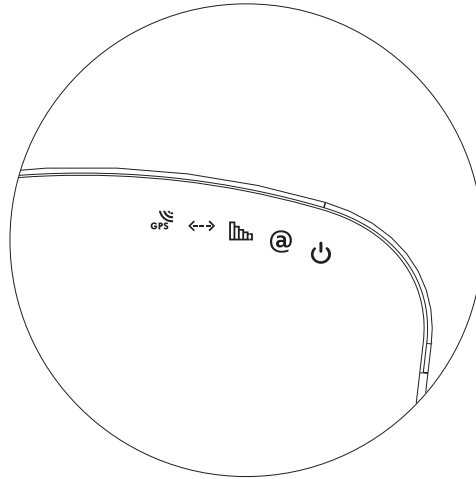

## **Power Status**

OFF: Device Powered Off  
ON: Device Powered On  
Blinking: Problem Detected



## **IP Connection Status**

OFF: Device not connected to IP network.  
ON: Device connected to IP network.  
Blinking: System is initializing (booting, connecting, registering, performing auto-configuration or network listening).



## **Active Call Status**

OFF: No active call(s).  
ON: One or more active calls in progress.  
Blinking: Maximum number of active calls in progress.



## **Device Active Status**

OFF: The LAN2 port has no connection to a 3rd party device.  
ON: The LAN2 port has a 3rd party device connected.



## **GPS Status**

OFF: GPS location detection is not required or has failed.  
ON: GPS has provided an accurate location fix.  
Blinking: GPS location detection is in progress.

## QUICK SETUP

Installing the Alcatel-Lucent 9361 Home Cell V2 is simple and can be done in around 10 minutes. The following instructions will guide you through the Quick Setup process.

### Step 1: Insert the SIM card (optional)

If your mobile operator provided a SIM card to use with the 9361 Home Cell V2, make sure the 9361 Home Cell V2 is switched off and then insert the SIM card into the SIM card slot on the side as shown next. The end with the cut-off corner goes in first with the cut-off corner pointing down.

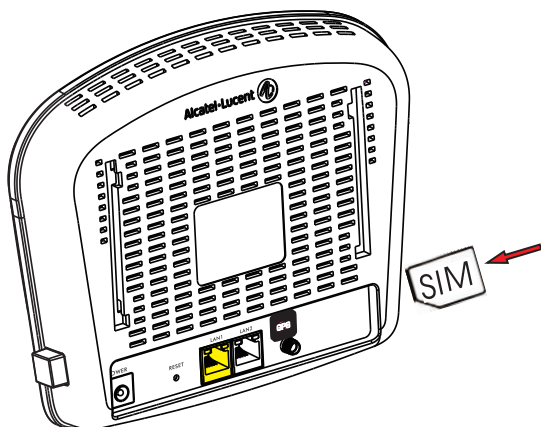

### Step 2: Find a central location in your home or office to install the device

The Alcatel-Lucent 9361 Home Cell V2 emits a radio signal similar to a Wi-fi router. The quality of the coverage you will experience depends on where the device is located and it should be placed:

- in a central area of your home
  - as high as possible; on top of tall furniture, shelves, cabinets, wall mounts, etc.
- The GPS antenna should be positioned horizontally for best GPS reception. The GPS antenna must have a clear view of the sky.

To improve coverage the following should be avoided

- Installing near other radio transmitters
- Installing near metallic devices
- Installing near a window
- Painting the antenna as this impairs or disables signal reception
- Pulling the cord when installing as this will cause a short or snap the wires

## Step 3: Use Stand "OR" Mount on wall

The 9361 Home Cell V2 can be either free standing on a flat, sturdy surface or wall mounted.

For a free standing installation, place the 9361 Home Cell V2 in the wall bracket/stand with the back of the 9361 Home Cell V2 facing the taller part of the wall bracket/stand as shown.

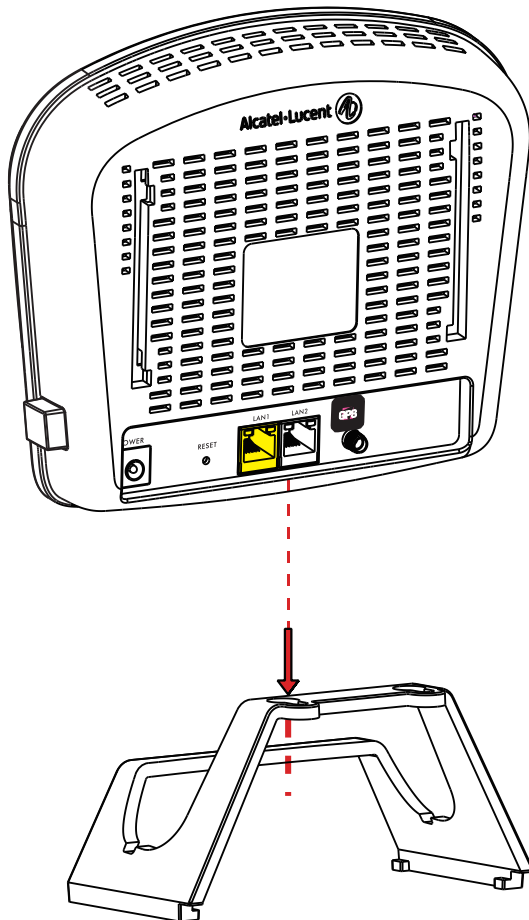

## QUICK SETUP

To wall mount the 9361 Home Cell V2, first fix the wall bracket/stand to the wall as shown in the below illustration. Use the stand's screw holes as guidelines to drill 2 fixing points. Use the 2 cheese head screws provided to mount the stand on the wall with the screw holes at the top. Pull the stand downwards so the screws lock into position.

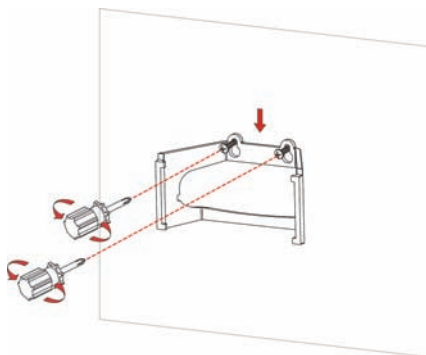

For a free standing installation, connect the cables to the 9361 Home Cell V2 after you place it in the wall bracket/stand.

For wall mounting, connect the cables to the 9361 Home Cell V2 before attaching the 9361 Home Cell V2 to the stand/bracket.

Connect one end of the provided yellow Ethernet cable to the yellow LAN1 port (LAN Back haul) on the 9361 Home Cell V2. If you are using the optional GPS antenna, remove the dust cap from the 9361 Home Cell V2's GPS connector. Then screw the antenna clockwise onto the GPS connector. Run the antenna close to a window.

Connect the provided AC power adaptor cord to the power port on the 9361 Home Cell V2.

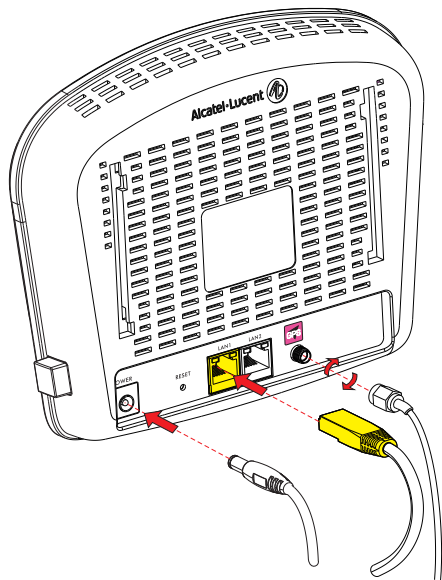

# QUICK SETUP

Insert the legs of the stand/bracket into the slots on the back of the 9361 Home Cell V2 and pull down to lock into position.

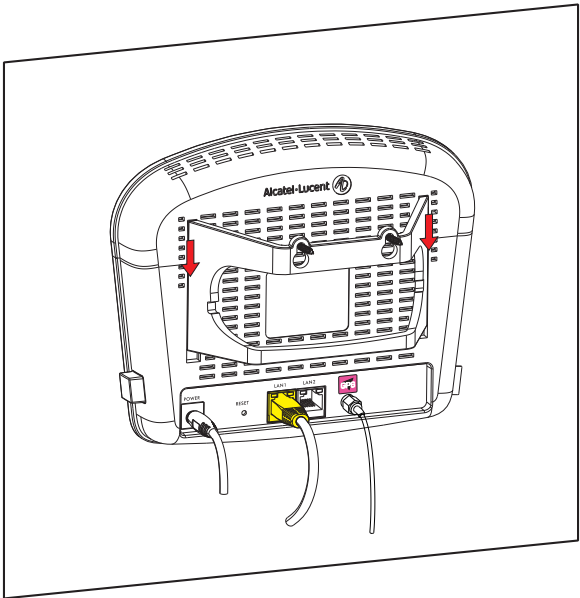
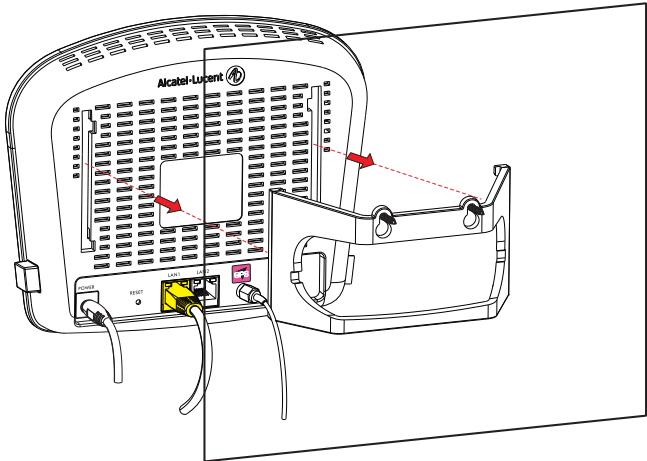

Note: The 9361 Home Cell V2 Base is less than 1 kg and can be easily mounted on any flat sturdy wall.

## QUICK SETUP

### Step 4: Connect the Ethernet cable:

Connect the yellow Ethernet cable to an available Ethernet port on your DSL/Cable router.

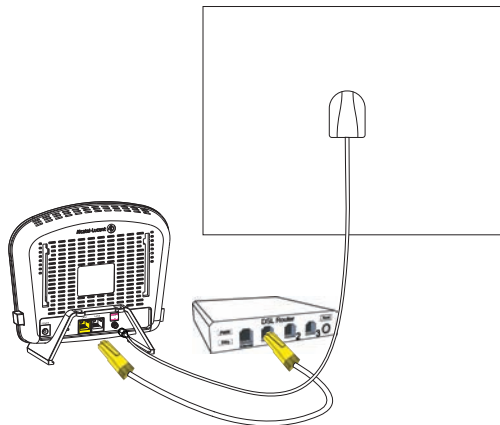

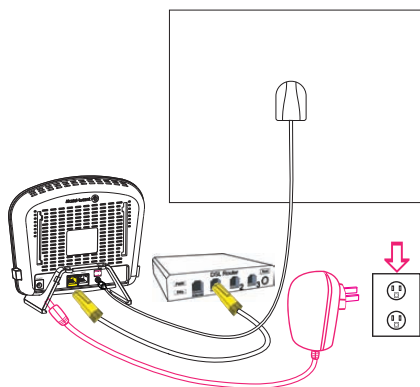

### Step 5: Connect the External Power Supply:

Connect the AC power adaptor cord to an available power socket.



Switch on the 9361 Home Cell V2. After a few seconds the power status  indicator lights up and the Ethernet port status indicators on both the 9361 Home Cell V2 and the broadband connection should light up green (flash green). If this does not happen, go to the troubleshooting section of this guide for help.

## Step 6: Broadband Connectivity

After approximately two minutes (for initial installation this may take up to 90 minutes if it is the first time you turn on), the 9361 Home Cell V2 connectivity  and GPS  indicators will begin to blink.

If the connectivity status indicator is off, go to the troubleshooting section of this guide for help.

## Step 7: Automatic Software Update:

After the device establishes a broadband connection to your Internet Service Provider (ISP), the 9361 Home Cell V2 automatically updates its software.

This process “takes” about 15 minutes and the connectivity status  indicator blinks.

After the device retrieves its software update package, it reboots automatically.

During reboot, the power  indicator is on.

## Step 8: Auto-configuration:

After rebooting, the 9361 Home Cell V2 automatically configures itself with the information you have provided to your ISP and mobile phone operator regarding phones or devices that are allowed to connect to your Femtozone service.

The connectivity  status indicator blinks and remains on when the auto configuration is complete.

When the device is ready to be used, the connectivity  status indicator is ON.

You are now ready to make your first call using your 9361 Home Cell V2.