



FCC TEST REPORT (PART 22)

REPORT NO.: RF110422E05

MODEL NO.: 9361 Home Cell V2.0 1900/850MHz 100mW

FCC ID: ZMYV2ACDB100

RECEIVED: Apr. 22, 2011

TESTED: Apr. 27 ~ May 12, 2011

ISSUED: May 17, 2011

APPLICANT: MitraStar Technology Corporation

ADDRESS: No. 6, Innovation Road II, Hsinchu Science
Park, Hsinchu 300, Taiwan (R.O.C.)

ISSUED BY: Bureau Veritas Consumer Products Services
(H.K.) Ltd., Taoyuan Branch

LAB ADDRESS: No. 47, 14th Ling, Chia Pau Tsuen, Lin Kou
Hsiang, Taipei Hsien 244, Taiwan, R.O.C.

TEST LOCATION: No. 19, Hwa Ya 2nd Rd, Wen Hwa Tsuen, Kwei
Shan Hsiang, Taoyuan Hsien 333, Taiwan, R.O.C.

This test report consists of 46 pages in total. It may be duplicated completely for legal use with the approval of the applicant. It should not be reproduced except in full, without the written approval of our laboratory. The client should not use it to claim product, certification, approval or endorsement by TAF or any government agency. The test results in the report only apply to the tested sample.





TABLE OF CONTENTS

RELEASE CONTROL RECORD.....	4
1 CERTIFICATION	5
2 SUMMARY OF TEST RESULTS	6
2.1 MEASUREMENT UNCERTAINTY	6
3 GENERAL INFORMATION.....	7
3.1 GENERAL DESCRIPTION OF EUT.....	7
3.2 DESCRIPTION OF TEST MODES.....	8
3.2.1 CONFIGURATION OF SYSTEM UNDER TEST	8
3.2.2 TEST MODE APPLICABILITY AND TESTED CHANNEL DETAIL.....	9
3.3 GENERAL DESCRIPTION OF APPLIED STANDARDS	11
3.4 DESCRIPTION OF SUPPORT UNITS.....	11
4 TEST TYPES AND RESULTS.....	12
4.1 OUTPUT POWER MEASUREMENT	12
4.1.1 LIMITS OF OUTPUT POWER MEASUREMENT.....	12
4.1.2 TEST INSTRUMENTS	13
4.1.3 TEST PROCEDURES.....	14
4.1.4 TEST SETUP	15
4.1.5 EUT OPERATING CONDITIONS.....	15
4.1.6 TEST RESULTS	16
4.2 FREQUENCY STABILITY MEASUREMENT	17
4.2.1 LIMITS OF FREQUENCY STABILITY MEASUREMENT.....	17
4.2.2 TEST INSTRUMENTS	17
4.2.3 TEST PROCEDURE	18
4.2.4 TEST SETUP	18
4.2.5 TEST RESULTS	19
4.3 OCCUPIED BANDWIDTH MEASUREMENT.....	20
4.3.1 LIMITS OF OCCUPIED BANDWIDTH MEASUREMENT	20
4.3.2 TEST INSTRUMENTS	20
4.3.3 TEST SETUP	20
4.3.4 TEST PROCEDURES.....	21
4.3.5 EUT OPERATING CONDITION	21
4.3.6 TEST RESULTS	22
4.4 BAND EDGE MEASUREMENT	23
4.4.1 LIMITS OF BAND EDGE MEASUREMENT.....	23
4.4.2 TEST INSTRUMENTS	23
4.4.3 TEST SETUP	23
4.4.4 TEST PROCEDURES.....	24
4.4.5 EUT OPERATING CONDITION	24
4.4.6 TEST RESULTS	25
4.5 CONDUCTED SPURIOUS EMISSIONS.....	26
4.5.1 LIMITS OF CONDUCTED SPURIOUS EMISSIONS MEASUREMENT	26
4.5.2 TEST INSTRUMENTS	26
4.5.3 TEST PROCEDURE	27
4.5.4 TEST SETUP	27
4.5.5 EUT OPERATING CONDITIONS.....	27
4.5.6 TEST RESULTS	28
4.6 RADIATED EMISSION MEASUREMENT (BELOW 1GHz).....	34
4.6.1 LIMITS OF RADIATED EMISSION MEASUREMENT	34
4.6.2 TEST INSTRUMENTS	34
4.6.3 TEST PROCEDURES.....	35



A D T

4.6.4	DEVIATION FROM TEST STANDARD	35
4.6.5	TEST SETUP	36
4.6.6	EUT OPERATING CONDITIONS	36
4.6.7	TEST RESULTS	37
4.7	RADIATED EMISSION MEASUREMENT (ABOVE 1GHz)	38
4.7.1	LIMITS OF RADIATED EMISSION MEASUREMENT	38
4.7.2	TEST INSTRUMENTS	38
4.7.3	TEST PROCEDURES	39
4.7.4	DEVIATION FROM TEST STANDARD	39
4.7.5	TEST SETUP	40
4.7.6	EUT OPERATING CONDITIONS	40
4.7.7	TEST RESULTS	41
5	PHOTOGRAPHS OF THE TEST CONFIGURATION.....	44
6	INFORMATION ON THE TESTING LABORATORIES.....	45
7	APPENDIX A – MODIFICATIONS RECORDERS FOR ENGINEERING CHANGES TO THE EUT BY THE LAB.....	46



RELEASE CONTROL RECORD

ISSUE NO.	REASON FOR CHANGE	DATE ISSUED
Original release	N/A	May 17, 2011



1 CERTIFICATION

PRODUCT : 3G Femtocell

MODEL NO. : 9361 Home Cell V2.0 1900/850MHz 100mW

BRAND : Alcatel-Lucent

APPLICANT : MitraStar Technology Corporation

TEST SAMPLE : ENGINEERING SAMPLE

TESTED : Apr. 27 ~ May 12, 2011

STANDARDS : **FCC Part 22, Subpart H**
ANSI C63.4-2003

The above equipment (model: 9361 Home Cell V2.0 1900/850MHz 100mW) has been tested by **Bureau Veritas Consumer Products Services (H.K.) Ltd., Taoyuan Branch**, and found compliance with the requirement of the above standards. The test record, data evaluation & Equipment Under Test (EUT) configurations represented herein are true and accurate accounts of the measurements of the sample's EMC characteristics under the conditions specified in this report.

PREPARED BY :  , DATE : May 17, 2011
Pettie Chen / Specialist

APPROVED BY :  , DATE : May 17, 2011
Gary Chang / Assistant Manager

2 SUMMARY OF TEST RESULTS

The EUT has been tested according to the following specifications:

APPLIED STANDARD: FCC Part 22 & Part 2			
STANDARD SECTION	TEST TYPE AND LIMIT	RESULT	REMARK
2.1046 22.913 (a)	Maximum Peak Output Power Limit: max. 7 watts e.r.p peak power	PASS	Meet the requirement of limit. Minimum passing margin is 21.7dBm at 871.4MHz.
2.1055	Frequency Stability AFC Freq. Error vs. Voltage AFC Freq. Error vs. Temperature Limit: max. ± 2.5 ppm	PASS	Meet the requirement of limit.
2.1049 (h)	Occupied Bandwidth	PASS	Meet the requirement of limit.
22.917	Band Edge Measurements	PASS	Meet the requirement of limit.
2.1051 22.917	Conducted Spurious Emissions	PASS	Meet the requirement of limit.
2.1053 22.917	Radiated Spurious Emissions	PASS	Meet the requirement of limit. Minimum passing margin is -19.0dB at 2674.8MHz.

2.1 MEASUREMENT UNCERTAINTY

Where relevant, the following measurement uncertainty levels have been estimated for tests performed on the EUT as specified in CISPR 16-4-2:

MEASUREMENT	FREQUENCY	UNCERTAINTY
Conducted emissions	9kHz~30MHz	2.44 dB
Radiated emissions	30MHz ~ 200MHz	2.93 dB
	200MHz ~1000MHz	2.95 dB
	1GHz ~ 18GHz	2.26 dB
	18GHz ~ 40GHz	1.94 dB

This uncertainty represents an expanded uncertainty expressed at approximately the 95% confidence level using a coverage factor of $k=2$.

3 GENERAL INFORMATION

3.1 GENERAL DESCRIPTION OF EUT

PRODUCT	3G Femtocell	
MODEL NO.	9361 Home Cell V2.0 1900/850MHz 100mW	
FCC ID	ZMYV2ACDB100	
NOMINAL VOLTAGE	12Vdc (adapter)	
MODULATION TYPE	WCDMA	BPSK
FREQUENCY RANGE	WCDMA	871.4MHz ~ 891.6MHz
RELEASE VERSION	WCDMA	Release 5 / 6
MAX. ERP POWER	WCDMA	0.1462Watts
ANTENNA TYPE	Fixed Internal antenna with 2.37dBi gain	
DATA CABLE	NA	
I/O PORTS	Refer to user's manual	
ACCESSORY DEVICES	NA	

NOTE:

- The EUT is a 3G Femtocell. The test data are separated into following test reports.

	TEST STANDARD	REFERENCE REPORT
WCDMA 850	FCC Part 22	RF110422E05
WCDMA 1900	FCC Part 24	RF110422E05-1

- The EUT were powered by the following adapter:

BRAND:	DVE
MODEL:	DSA-12G-12 FUS 120120
INPUT:	100-240Vac, 50/60Hz, 0.3A
OUTPUT:	12Vdc, 1A
POWER LINE:	2.0m non-shielded cable without core

- The EUT has no voice function.
- The above EUT information is declared by manufacturer and for more detailed features description, please refer to the manufacturer's specifications or User's Manual.

3.2 DESCRIPTION OF TEST MODES

FOR WCDMA:

102 channels are provided to this EUT. Therefore, the low, middle and high channels are chosen for testing.

	CHANNEL	FREQUENCY	TX MODE
LOW	4357	871.4 MHz	WCDMA
MIDDLE	4408	881.6 MHz	WCDMA
HIGH	4458	891.6 MHz	WCDMA

NOTE:

1. Below 1 GHz, the channel 4357, 4408 and 4458 were pre-tested in chamber. The channel 4458 was chosen for final test.
2. Above 1 GHz, the channel 4357, 4408 and 4458 were tested individually.
3. The channel space is 0.2MHz.
4. After pretest of output power and spurious emission under WCDMA-RMC & HSDPA & HSUPA mode, find the worst mode is WCDMA-RMC. Therefore, select WCDMA-RMC mode to do final test

3.2.1 CONFIGURATION OF SYSTEM UNDER TEST

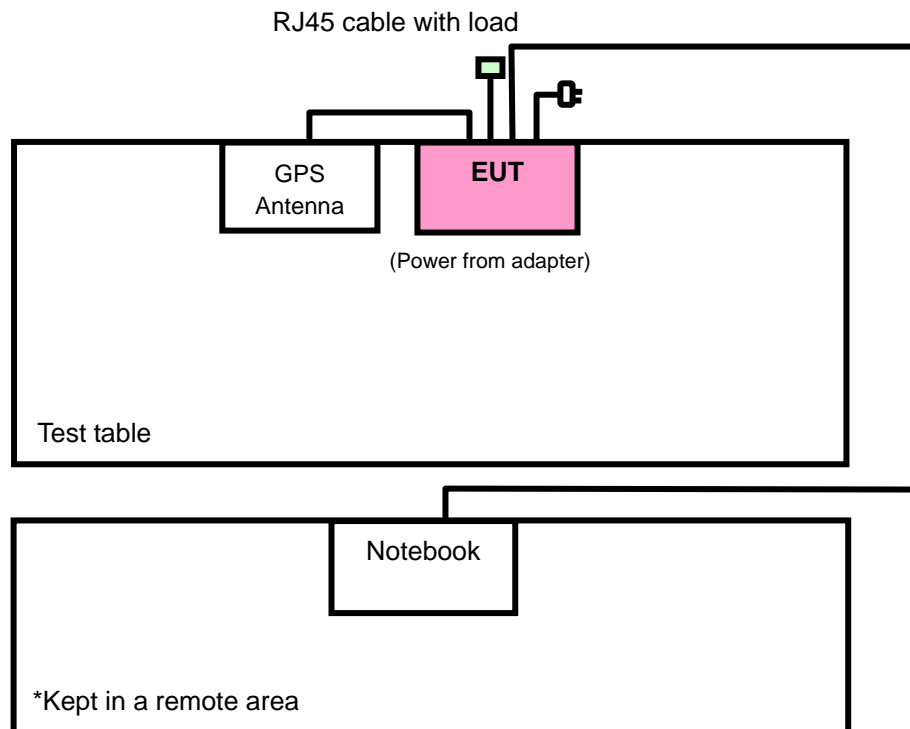

3.2.2 TEST MODE APPLICABILITY AND TESTED CHANNEL DETAIL

EUT CONFIGURE MODE	APPLICABLE TO							DESCRIPTION
	OP	FS	OB	BE	CE	RE<1G	RE≥1G	
-	√	√	√	√	√	√	√	-

Where **OP**: Output power **FS**: Frequency stability
OB: Occupied bandwidth **BE**: Band edge
CE: Conducted spurious emissions **RE<1G**: Radiated emission below 1GHz
RE≥1G: Radiated emission above 1GHz

OUTPUT POWER MEASUREMENT:

- Pre-Scan has been conducted to determine the worst-case mode from all possible combinations between available modulations, data rates, XYZ axis and antenna ports (if EUT with antenna diversity architecture).
- Following channel(s) was (were) selected for the final test as listed below.

AVAILABLE CHANNEL	TESTED CHANNEL	MODULATION TECHNOLOGY	AXIS
4357 to 4458	4357, 4408, 4458	WCDMA	Z

FREQUENCY STABILITY MEASUREMENT:

- Pre-Scan has been conducted to determine the worst-case mode from all possible combinations between available modulations and antenna ports (if EUT with antenna diversity architecture).
- Following channel(s) was (were) selected for the final test as listed below.

AVAILABLE CHANNEL	TESTED CHANNEL	MODULATION TECHNOLOGY
4357 to 4458	4458	WCDMA

OCCUPIED BANDWIDTH MEASUREMENT:

- This item includes all test value of each mode, but only includes spectrum plot of worst value of each mode.
- Pre-Scan has been conducted to determine the worst-case mode from all possible combinations between available modulations and antenna ports (if EUT with antenna diversity architecture).
- Following channel(s) was (were) selected for the final test as listed below.

AVAILABLE CHANNEL	TESTED CHANNEL	MODULATION TECHNOLOGY
4357 to 4458	4357, 4408, 4458	WCDMA

BAND EDGE MEASUREMENT:

- Pre-Scan has been conducted to determine the worst-case mode from all possible combinations between available modulations and antenna ports (if EUT with antenna diversity architecture).
- Following channel(s) was (were) selected for the final test as listed below.

AVAILABLE CHANNEL	TESTED CHANNEL	MODULATION TECHNOLOGY
4357 to 4458	4357, 4458	WCDMA

CONDUCTED SPURIOUS EMISSIONS MEASUREMENT:

- Pre-Scan has been conducted to determine the worst-case mode from all possible combinations between available modulations and antenna ports (if EUT with antenna diversity architecture).
- Following channel(s) was (were) selected for the final test as listed below.

AVAILABLE CHANNEL	TESTED CHANNEL	MODULATION TECHNOLOGY
4357 to 4458	4357, 4408, 4458	WCDMA

RADIATED EMISSION MEASUREMENT (BELOW 1 GHz):

- Pre-Scan has been conducted to determine the worst-case mode from all possible combinations between available modulations, data rates, XYZ axis and antenna ports (if EUT with antenna diversity architecture).
- Following channel(s) was (were) selected for the final test as listed below.

AVAILABLE CHANNEL	TESTED CHANNEL	MODULATION TECHNOLOGY	AXIS
4357 to 4458	4357	WCDMA	Z

RADIATED EMISSION MEASUREMENT (ABOVE 1 GHz):

- Pre-Scan has been conducted to determine the worst-case mode from all possible combinations between available modulations, data rates, XYZ axis and antenna ports (if EUT with antenna diversity architecture).
- Following channel(s) was (were) selected for the final test as listed below.

AVAILABLE CHANNEL	TESTED CHANNEL	MODULATION TECHNOLOGY	AXIS
4357 to 4458	4357, 4408, 4458	WCDMA	Z

TEST CONDITION:

APPLICABLE TO	ENVIRONMENTAL CONDITIONS	INPUT POWER (SYSTEM)	TESTED BY
OP	23deg. C, 62%RH, 1008 hPa	120Vac, 60Hz	Long Chen
FS	23deg. C, 62%RH, 1008 hPa	120Vac, 60Hz	Long Chen
OB	23deg. C, 62%RH, 1008 hPa	120Vac, 60Hz	Long Chen
EM	23deg. C, 62%RH, 1008 hPa	120Vac, 60Hz	Long Chen
BE	23deg. C, 62%RH, 1008 hPa	120Vac, 60Hz	Long Chen
CE	23deg. C, 62%RH, 1008 hPa	120Vac, 60Hz	Long Chen
RE < 1G	25deg. C, 68%RH, 1009 hPa	120Vac, 60Hz	Sun Lin
RE ≥ 1G	25deg. C, 68%RH, 1009 hPa	120Vac, 60Hz	Sun Lin

3.3 GENERAL DESCRIPTION OF APPLIED STANDARDS

The EUT is a RF product. According to the specifications of the manufacturer, it must comply with the requirements of the following standards:

FCC 47 CFR Part 2

FCC 47 CFR Part 22

ANSI C63.4-2003

ANSI/TIA/EIA-603-C 2004

All test items have been performed and recorded as per the above standards.

NOTE: The EUT is also considered as a kind of computer peripheral, because the connection to computer is necessary for typical use. It has been verified to comply with the requirements of FCC Part 15, Subpart B, Class B (DoC). The test report has been issued separately.

3.4 DESCRIPTION OF SUPPORT UNITS

The EUT has been tested as an independent unit together with other necessary accessories or support units. The following support units or accessories were used to form a representative test configuration during the tests.

NO.	PRODUCT	BRAND	MODEL NO.	SERIAL NO.	FCC ID
1	NOTEBOOK	DELL	D531	CN-0XM006-48643-8 1U-2973	QDS-BRCM1020

NO.	SIGNAL CABLE DESCRIPTION OF THE ABOVE SUPPORT UNITS
1	10m RJ45 cable without core

NOTE 1: All power cords of the above support units are non shielded (1.8m).

NOTE 2: Item 1 acted as a communication partners to transfer data.

4 TEST TYPES AND RESULTS

4.1 OUTPUT POWER MEASUREMENT

4.1.1 LIMITS OF OUTPUT POWER MEASUREMENT

The radiated peak output power shall be according to the specific rule Part 22.913 (a) that "Mobile / Portable station are limited to 7 watts e.r.p".

4.1.2 TEST INSTRUMENTS

DESCRIPTION & MANUFACTURER	MODEL NO.	SERIAL NO.	DATE OF CALIBRATION	DUE DATE OF CALIBRATION
Test Receiver ROHDE & SCHWARZ	ESCI	100424	Aug. 04, 2010	Aug. 03, 2011
Spectrum Analyzer ROHDE & SCHWARZ	FSP40	100041	Jul. 09, 2010	Jul. 08, 2011
BILOG Antenna SCHWARZBECK	VULB9168	9168-156	Apr. 12, 2011	Apr. 11, 2012
HORN Antenna SCHWARZBECK	BBHA 9120 D	9120D-209	Aug. 02, 2010	Aug. 01, 2011
HORN Antenna SCHWARZBECK	BBHA 9170	BBHA9170243	Dec. 27, 2010	Dec. 26, 2011
Preamplifier Agilent	8449B	3008A01910	Sep. 09, 2010	Sep. 08, 2011
Preamplifier Agilent	8447D	2944A10638	Nov. 03, 2010	Nov. 02, 2011
RF signal cable HUBER+SUHNNER	SUCOFLEX 104	218190/4 231241/4	May 14, 2010	May 13, 2011
RF signal cable Worken	8D-FB	Cable-HYCH9-01	Aug. 20, 2010	Aug. 19, 2011
Software	ADT_Radiated_ V7.6.15.9.2	NA	NA	NA
Antenna Tower EMCO	2070/2080	512.835.4684	NA	NA
Turn Table EMCO	2087-2.03	NA	NA	NA
Antenna Tower & Turn Table Controller EMCO	2090	NA	NA	NA

- NOTE:**
1. The calibration interval of the above test instruments is 12 months and the calibrations are traceable to NML/ROC and NIST/USA.
 2. The test was performed in HwaYa Chamber 9.
 3. The horn antenna and HP preamplifier (model: 8449B) are used only for the measurement of emission frequency above 1GHz if tested.
 4. The FCC Site Registration No. is 460141.
 5. The IC Site Registration No. is IC 7450F-4.

4.1.3 TEST PROCEDURES

EIRP / ERP MEASUREMENT:

- a. The power was measured with R&S Spectrum Analyzer. All measurements were done at 3 channels, 4357, 4408 and 4458 (WCDMA) (low, middle and high operational frequency range.) RWB and VBW is 5MHz for WCDMA mode.
- b. Substitution method is used for E.I.R.P measurement. In the semi-anechoic chamber, EUT placed on the 0.8m height of Turn Table, rotated the table around 360 degrees to search the maximum radiation power and receiver antenna shall be rotated vertical and horizontal polarization and moved height from 1m to 4m to find the maximum polar radiated power. The “Read Value” is the spectrum reading the maximum power value.
- c. The substitution horn antenna is substituted for EUT at the same position and signals generator export the CW signal to the substitution antenna via a tx cable. Rotated the Turn Table and moved receiving antenna to find the maximum radiation power. Adjust output power level of S.G to get a Value of spectrum reading equal to “Read Value” of step c. Record the power level of S.G
- d. $EIRP = \text{Output power level of S.G} - \text{TX cable loss} + \text{Antenna gain of substitution horn.}$
- e. E.R.P power can be calculated form E.I.R.P power by subtracting the gain of dipole,
 $E.R.P \text{ power} = E.I.P.R \text{ power} - 2.15\text{dBi.}$

4.1.4 TEST SETUP

EIRP / ERP MEASUREMENT:

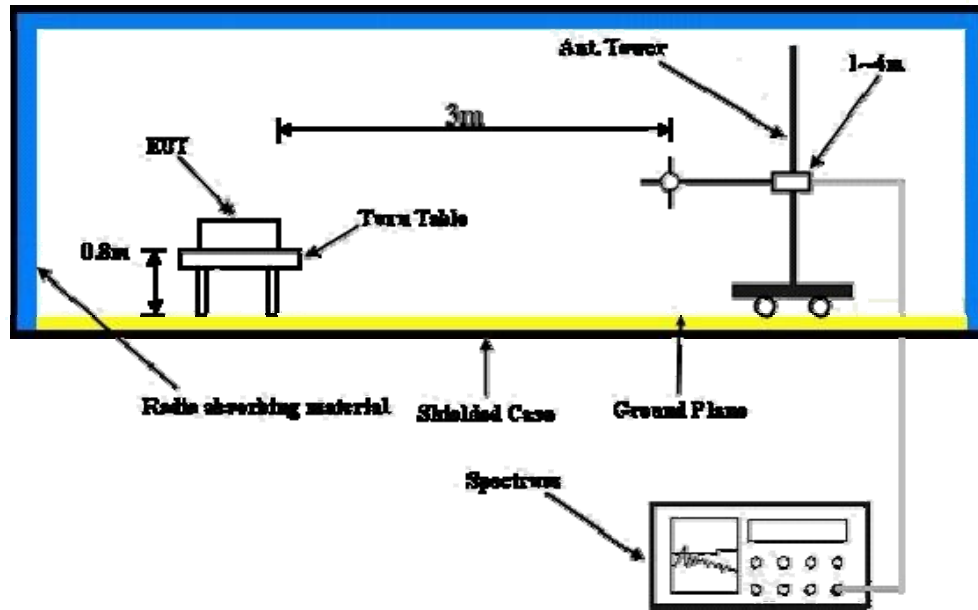

For the actual test configuration, please refer to the attached file (Test Setup Photo).

4.1.5 EUT OPERATING CONDITIONS

- Placed the EUT on the testing table.
- Prepared notebook to act as communication partner and placed it outside of testing area.
- Notebook sends commands to control EUT to transmit at specific frequency, modulation and output power level via telnet utility.

4.1.6 TEST RESULTS

ERP POWER					
CHANNEL NO.	FREQUENCY (MHz)	S.G VALUE (dBm)	CORRECTION FACTOR (dB)	OUTPUT POWER	
				dBm	Watt
4357	871.4	30.3	-8.6	21.7	0.1462
4408	881.6	29.7	-8.6	21.1	0.1274
4458	891.6	29.3	-8.7	20.6	0.1135

REMARKS: 1. Output Power (dBm) = S.G Value (dBm) + Correction Factor (dB).
 2. Correction Factor (dB) = Substitution Antenna Gain (dB) + Cable Loss (dB).

4.2 FREQUENCY STABILITY MEASUREMENT

4.2.1 LIMITS OF FREQUENCY STABILITY MEASUREMENT

According to the FCC part 22.863 shall be tested the frequency stability. The rule is defined that” The frequency stability shall be sufficient to ensure that the fundamental emission stays within the authorized frequency block.” The frequency error rate is according to the JTC standard that the frequency error rate shall be accurate to within 2.5ppm of the received frequency from the base station. The test extreme voltage is according to the 2.1055(d)(1) Vary primary supply voltage from 85 to 115 percent of the nominal value for other than hand carried battery equipment and the extreme temperature rule is comply with the 2.1055(a)(1) $-30^{\circ}\text{C} \sim 50^{\circ}\text{C}$.

4.2.2 TEST INSTRUMENTS

DESCRIPTION & MANUFACTURER	MODEL NO.	SERIAL NO.	DATE OF CALIBRATION	DUE DATE OF CALIBRATION
Spectrum Analyzer Agilent	E4446A	MY44360124	Dec. 29, 2010	Dec. 28, 2011
Hewlett Packard RF cable	8120-6192	01428251	NA	NA
RF cable	SUCOFLEX 104	257029	Jan. 27, 2011	Jan. 26, 2012
WIT Standard Temperature & Humidity Chamber	MHU-225AU	920842	Jun. 09, 2010	Jun. 08, 2011

NOTE: The calibration interval of the above test instruments is 12 months. And the calibrations are traceable to NML/ROC and NIST/USA.

4.2.3 TEST PROCEDURE

- a. Because of the measure the carrier frequency under the condition of the AFC lock, it shall be used the mobile station in the WCDMA link mode. This is accomplished with the use of the communication simulator station. The oven room could control the temperatures and humidity.
- b. Power must be removed when changing from one temperature to another or one voltage to another voltage. Power warm up is at least 15 min and power applied should perform before recording frequency error.
- c. EUT is connected the external power supply to control the host equipment power. The various Volts from the minimum 93.5 Volts to 126.5 Volts. Each step shall be record the frequency error rate.
- d. The temperature range step is 10 degrees in this test items. All temperature levels shall be hold the $\pm 0.5^{\circ}\text{C}$ during the measurement testing.
- e. The each temperature step shall be at least 0.5 hours, consider the EUT could be test under the stability condition.

NOTE: The frequency error was recorded frequency error from the communication simulator.

4.2.4 TEST SETUP

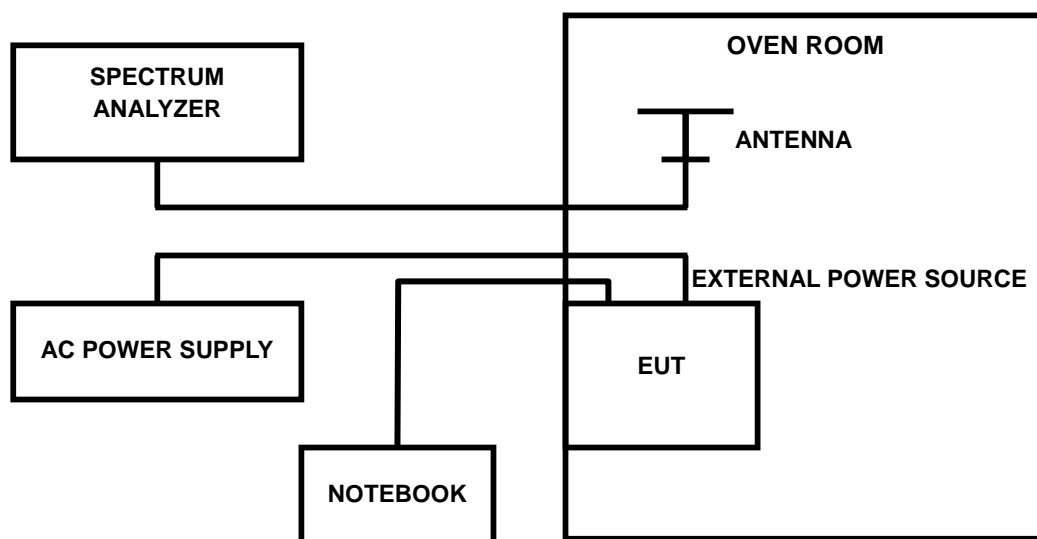

4.2.5 TEST RESULTS

AFC FREQUENCY ERROR vs. VOLTAGE			
VOLTAGE (Volts)	FREQUENCY ERROR (MHz)	FREQUENCY ERROR (ppm)	LIMIT (ppm)
93.5	891.600459	0.515	2.5
110.0	891.600456	0.511	2.5
126.5	891.600386	0.433	2.5

NOTE: The applicant defined the normal working voltage of the host equipment is from 93.5Vac to 126.5Vac.

AFC FREQUENCY ERROR vs. TEMP.			
TEMP. (°C)	FREQUENCY ERROR (MHz)	FREQUENCY ERROR (ppm)	LIMIT (ppm)
50	891.600533	0.598	2.5
40	891.600614	0.689	2.5
30	891.600487	0.546	2.5
20	891.600456	0.511	2.5
10	891.600605	0.679	2.5
0	891.600280	0.314	2.5
-10	891.600428	0.480	2.5
-20	891.600615	0.690	2.5
-30	891.600347	0.389	2.5

4.3 OCCUPIED BANDWIDTH MEASUREMENT

4.3.1 LIMITS OF OCCUPIED BANDWIDTH MEASUREMENT

The width of a frequency band such that, below the lower and above the upper frequency limits, the mean powers emitted are each equal to a specified percentage 0.5 %of the total mean power of a given emission.

4.3.2 TEST INSTRUMENTS

DESCRIPTION & MANUFACTURER	MODEL NO.	SERIAL NO.	DATE OF CALIBRATION	DUE DATE OF CALIBRATION
ROHDE & SCHWARZ Spectrum Analyzer	FSP40	100040	Jul. 09, 2010	Jul. 08, 2011
RF cable	SUCOFLEX 104	274403/4	Aug. 20, 2010	Aug. 19, 2011
RF cable	SUCOFLEX 104	250729/4	Aug. 19, 2010	Aug. 18, 2011
RF cable	SUCOFLEX 104	214377/4	Aug. 19, 2010	Aug. 18, 2011
JFW 20dB attenuation	50HF-020-SMA	NA	NA	NA

NOTE: The calibration interval of the above test instruments is 12 months. And the calibrations are traceable to NML/ROC and NIST/USA.

4.3.3 TEST SETUP

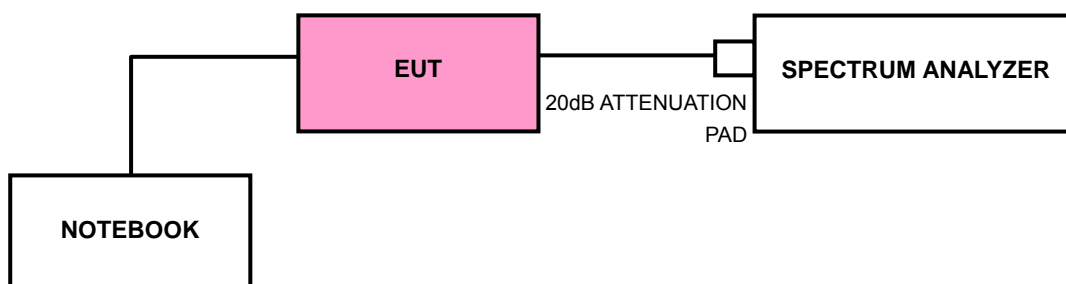

4.3.4 TEST PROCEDURES

- a. The power was measured with R&S Spectrum Analyzer. All measurements were done at 3 channels, 4357, 4408 and 4458 (WCDMA) (low, middle and high operational frequency range.)
- b. EUT connected to spectrum analyzer with a 20 dB attenuator.
- c. Notebook sends commands to control EUT to export maximum output power under transmission mode and specific channel frequency. Use OBW measurement function of Spectrum analyzer to measure 99 % occupied bandwidth.

4.3.5 EUT OPERATING CONDITION

Same as 4.1.5.

4.3.6 TEST RESULTS

CHANNEL	FREQUENCY (MHz)	99% OCCUPIED BANDWIDTH (MHz)
4357	871.4	4.12
4408	881.6	4.16
4458	891.6	4.14

CH 4408

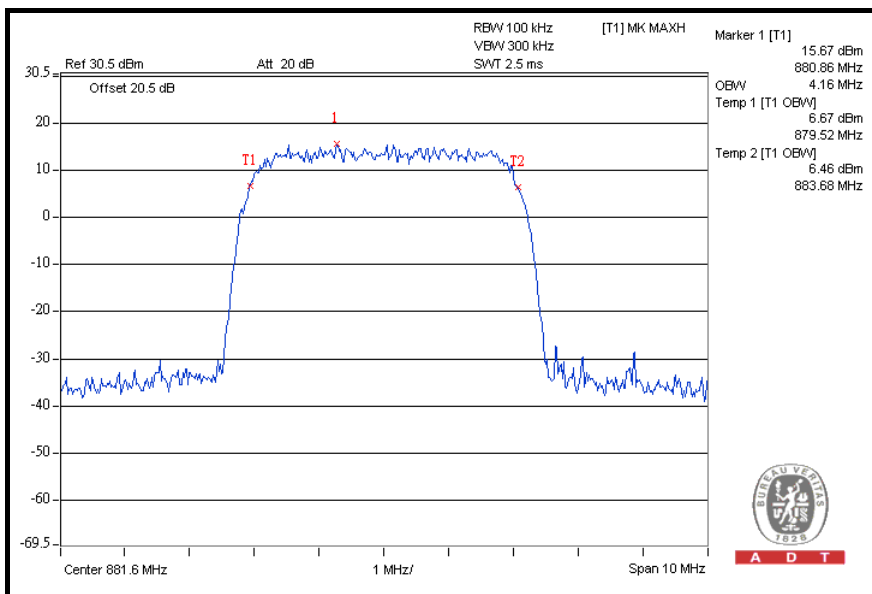

4.4 BAND EDGE MEASUREMENT

4.4.1 LIMITS OF BAND EDGE MEASUREMENT

According to FCC 22.917 specified that power of any emission outside of the authorized operating frequency ranges must be attenuated below the transmitting power (P) by a factor of at least $43 + 10 \log(P)$ dB. In the 1 MHz bands immediately outside and adjacent to the frequency block a resolution bandwidth of at least one percent of the emission bandwidth of the fundamental emission of the transmitter may be employed.

4.4.2 TEST INSTRUMENTS

DESCRIPTION & MANUFACTURER	MODEL NO.	SERIAL NO.	DATE OF CALIBRATION	DUE DATE OF CALIBRATION
ROHDE & SCHWARZ Spectrum Analyzer	FSP40	100040	Jul. 09, 2010	Jul. 08, 2011
RF cable	SUCOFLEX 104	274403/4	Aug. 20, 2010	Aug. 19, 2011
RF cable	SUCOFLEX 104	250729/4	Aug. 19, 2010	Aug. 18, 2011
RF cable	SUCOFLEX 104	214377/4	Aug. 19, 2010	Aug. 18, 2011
JFW 20dB attenuation	50HF-020-SMA	NA	NA	NA

NOTE: The calibration interval of the above test instruments is 12 months. And the calibrations are traceable to NML/ROC and NIST/USA.

4.4.3 TEST SETUP

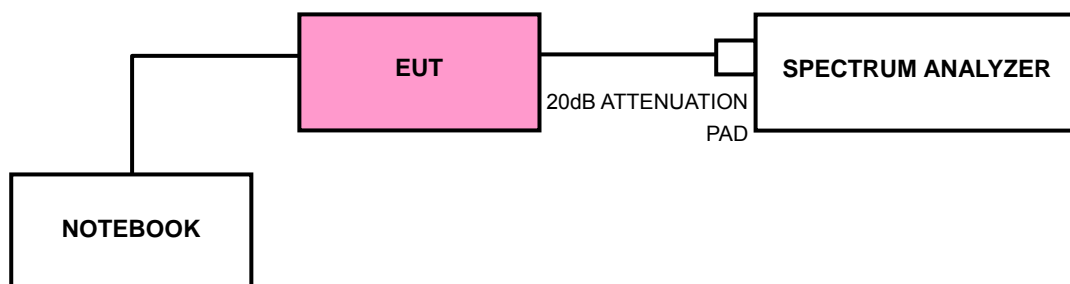

4.4.4 TEST PROCEDURES

- a. EUT connected to spectrum analyzer with a 20 dB attenuator
- b. Notebook sends commands to control EUT to transmit at specific frequency, modulation and output power level via telnet utility. The power was measured with R&S Spectrum Analyzer. All measurements were done at 2 channels (low and high operational frequency range.).
- c. This cable loss is the worst loss 0.5dB in the transmitted path track.
- d. The center frequency of spectrum is the band edge frequency and span is 10MHz. RB of the spectrum is 100kHz and VB of the spectrum is 300kHz (WCDMA).
- e. Record the max trace plot into the test report.

4.4.5 EUT OPERATING CONDITION

Same as 4.1.5

4.4.6 TEST RESULTS

LOWER BAND EDGE

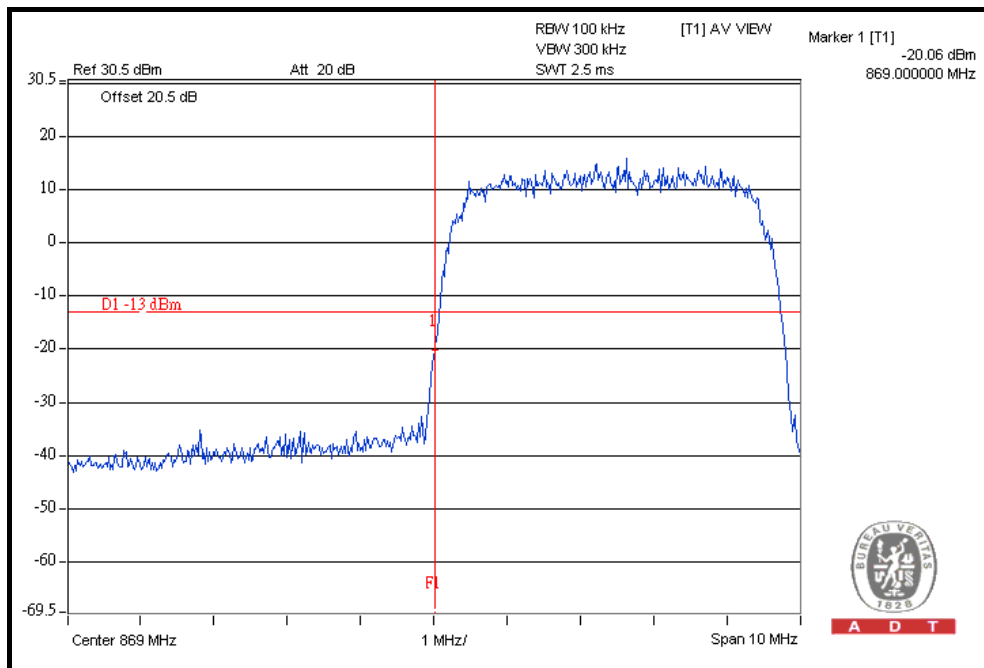

HIGHER BAND EDGE

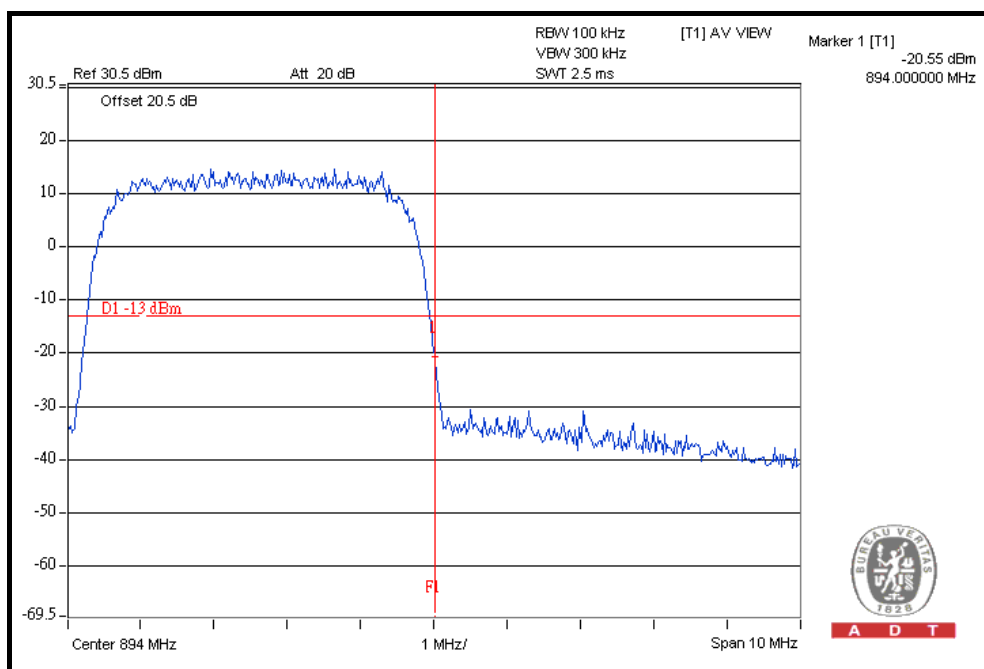

4.5 CONDUCTED SPURIOUS EMISSIONS

4.5.1 LIMITS OF CONDUCTED SPURIOUS EMISSIONS MEASUREMENT

In the FCC 22.917, On any frequency outside a licensee's frequency block within GPRS spectrum, the power of any emission shall be attenuated below the transmitter power (P) by at least $43 + 10 \log (P)$ dB. The emission limit equal to -13dBm .

4.5.2 TEST INSTRUMENTS

DESCRIPTION & MANUFACTURER	MODEL NO.	SERIAL NO.	DATE OF CALIBRATION	DUE DATE OF CALIBRATION
ROHDE & SCHWARZ Spectrum Analyzer	FSP40	100040	Jul. 09, 2010	Jul. 08, 2011
RF cable	SUCOFLEX 104	274403/4	Aug. 20, 2010	Aug. 19, 2011
RF cable	SUCOFLEX 104	250729/4	Aug. 19, 2010	Aug. 18, 2011
RF cable	SUCOFLEX 104	214377/4	Aug. 19, 2010	Aug. 18, 2011
JFW 20dB attenuation	50HF-020-SMA	NA	NA	NA

NOTE: The calibration interval of the above test instruments is 12 months. And the calibrations are traceable to NML/ROC and NIST/USA.

4.5.3 TEST PROCEDURE

- a. EUT connected to spectrum analyzer with a 20 dB attenuator
- b. Notebook sends commands to control EUT to transmit at specific frequency, modulation and output power level via telnet utility
- c. The EUT was set up for the maximum peak power with WCDMA link data modulation. The power was measured with R&S Spectrum Analyzer. All measurements were done at 3 channels, 4357, 4408 and 4458 (WCDMA) (low, middle and high operational frequency range.)
- d. When the spectrum scanned from 9kHz to 9GHz, it shall be connected to the band reject filter attenuated the carried frequency. The spectrum set RB=1MHz, VB=3MHz.

4.5.4 TEST SETUP

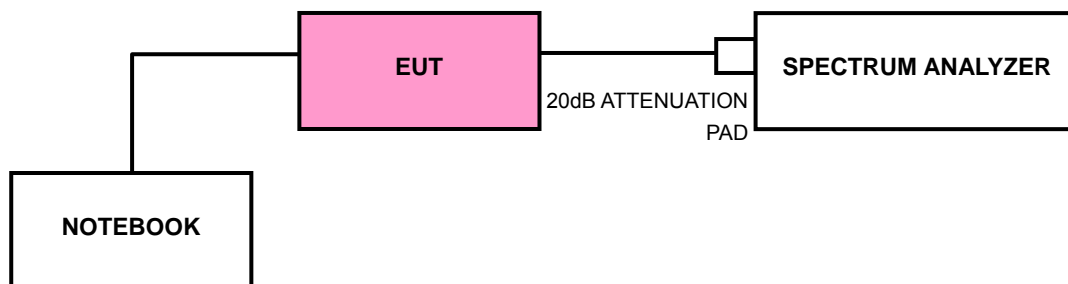

4.5.5 EUT OPERATING CONDITIONS

Same as 4.1.5

4.5.6 TEST RESULTS

CH 4357: 9kHz ~ 1GHz

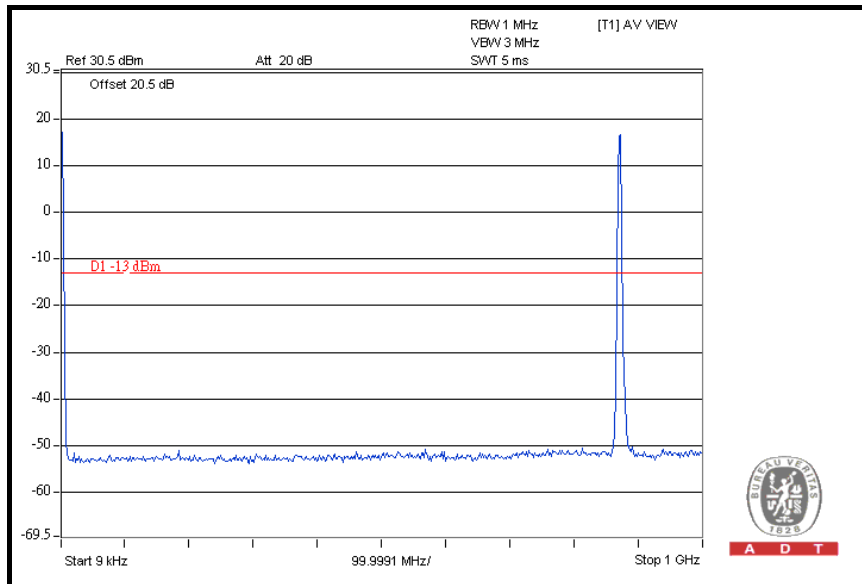

1GHz ~ 4GHz

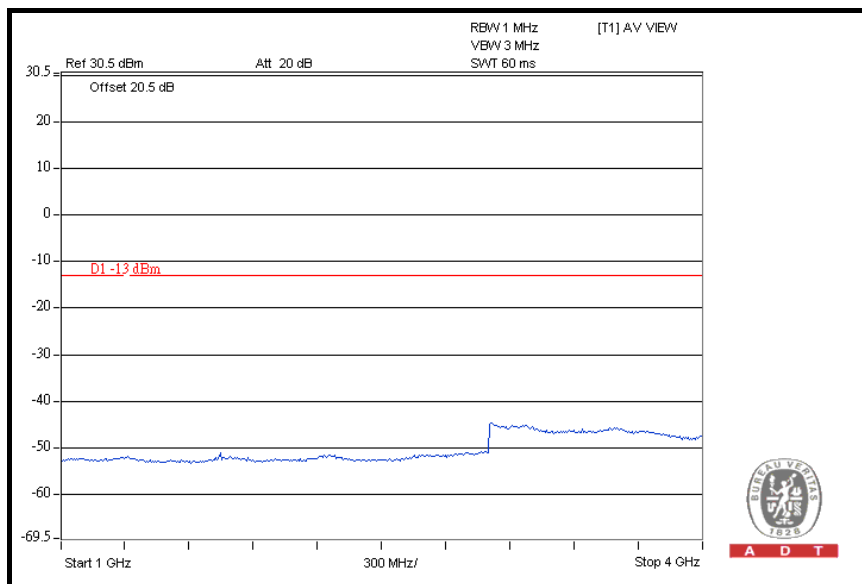

4GHz ~ 7GHz

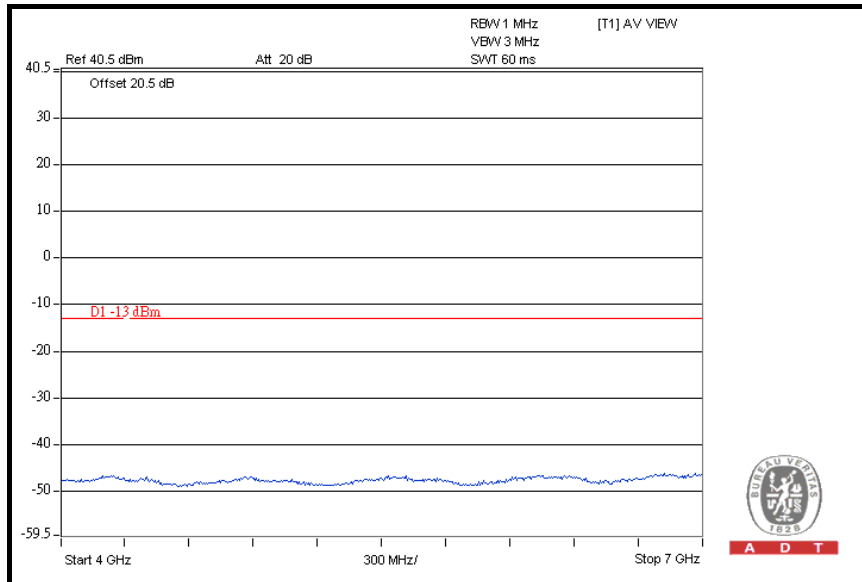

7GHz ~ 9GHz

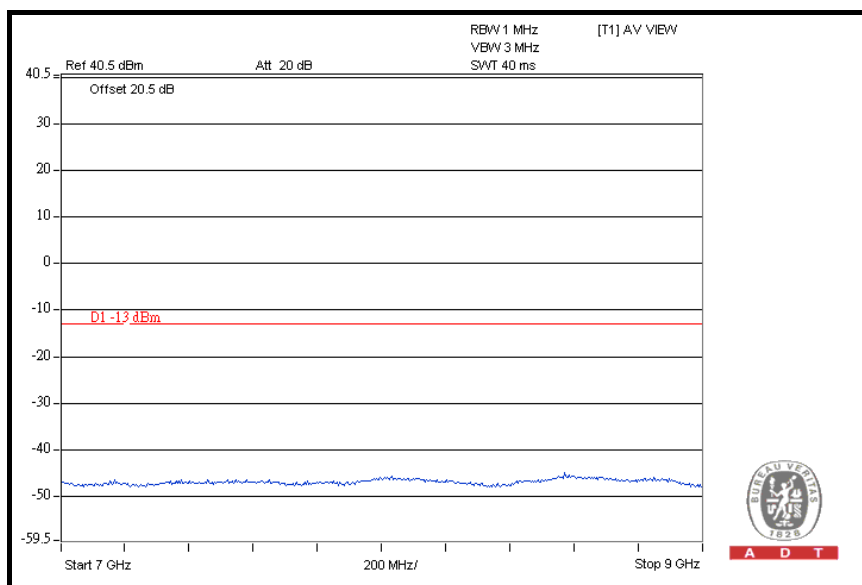

CH 4408: 9kHz ~ 1GHz

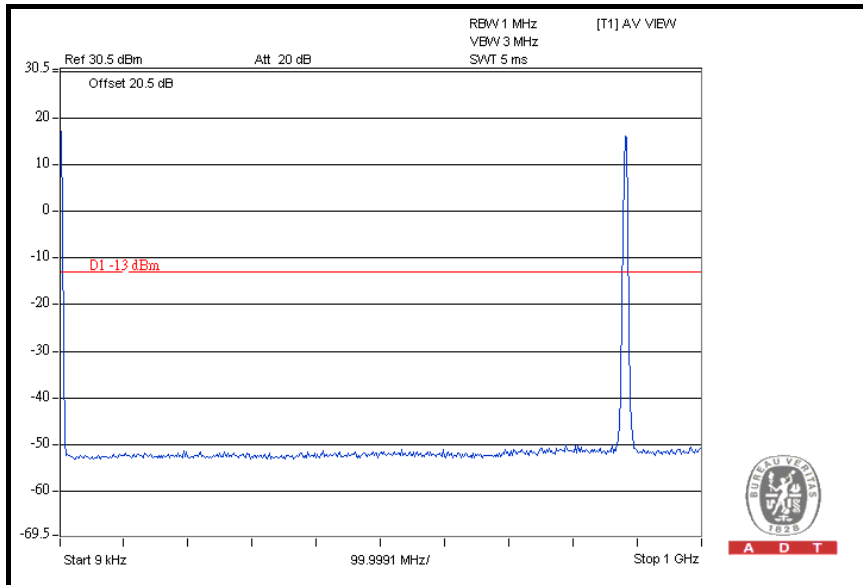

1GHz ~ 4GHz

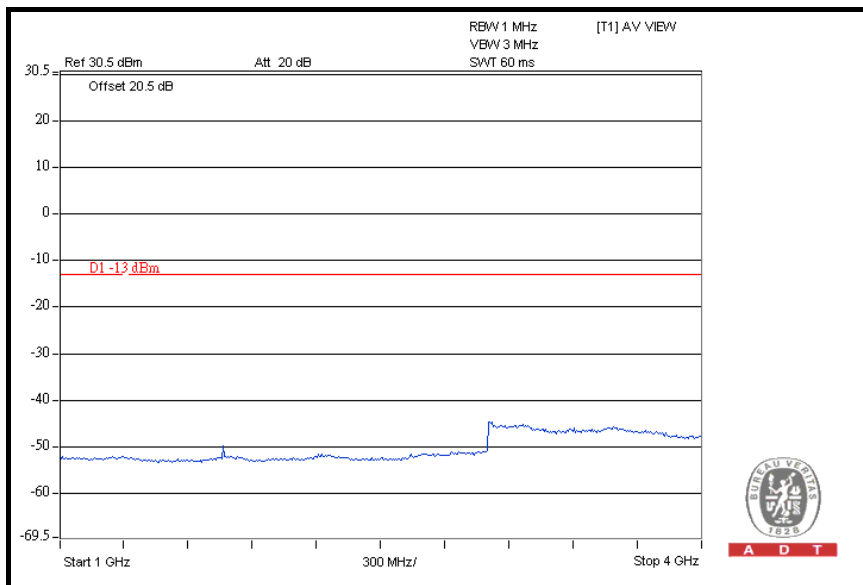

4GHz ~ 7GHz

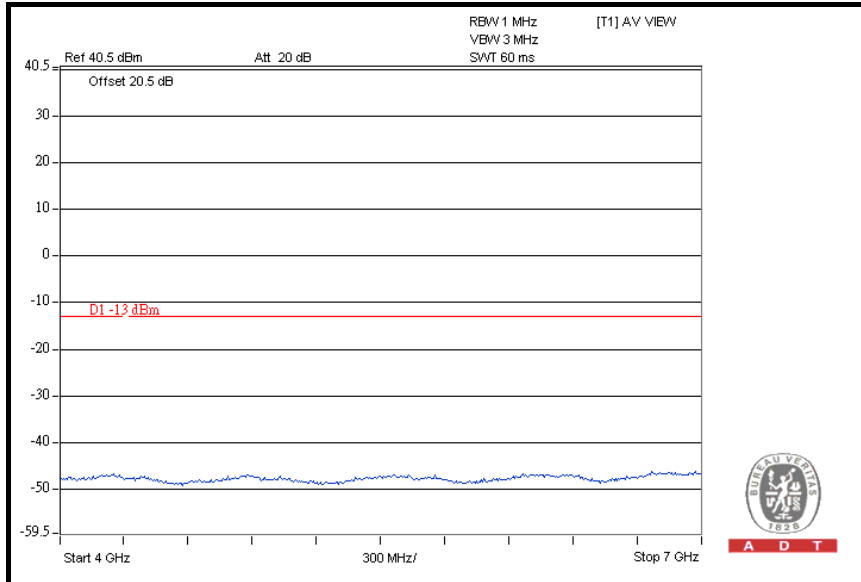

7GHz ~ 9GHz

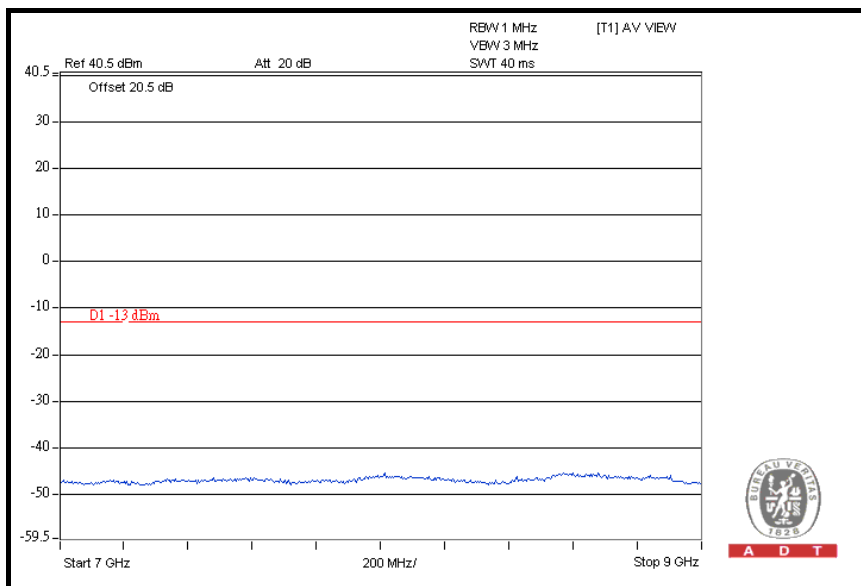



A D T

CH 4458: 9kHz ~ 1GHz

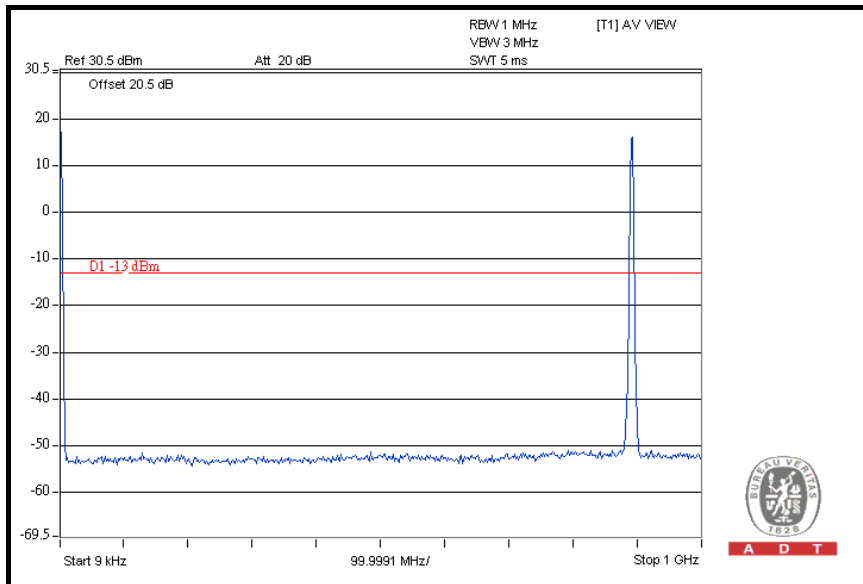

1GHz ~ 4GHz

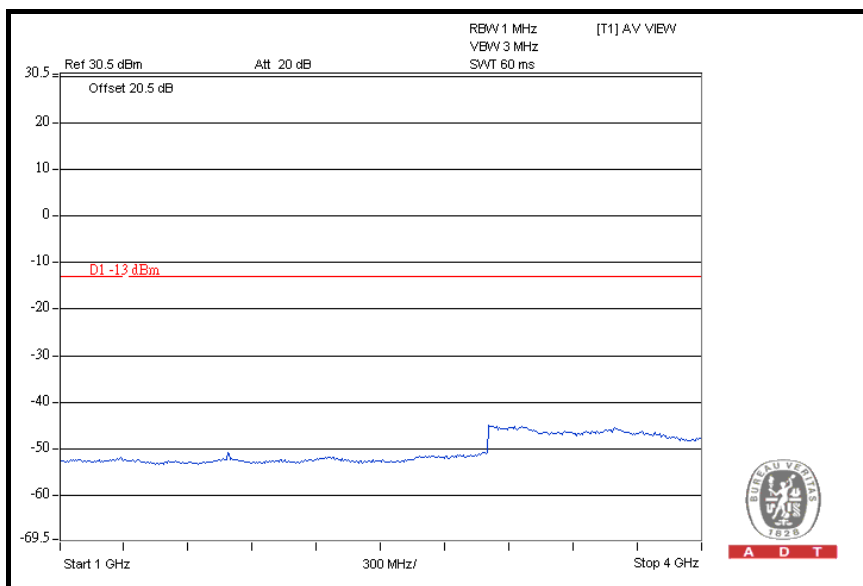

4GHz ~ 7GHz

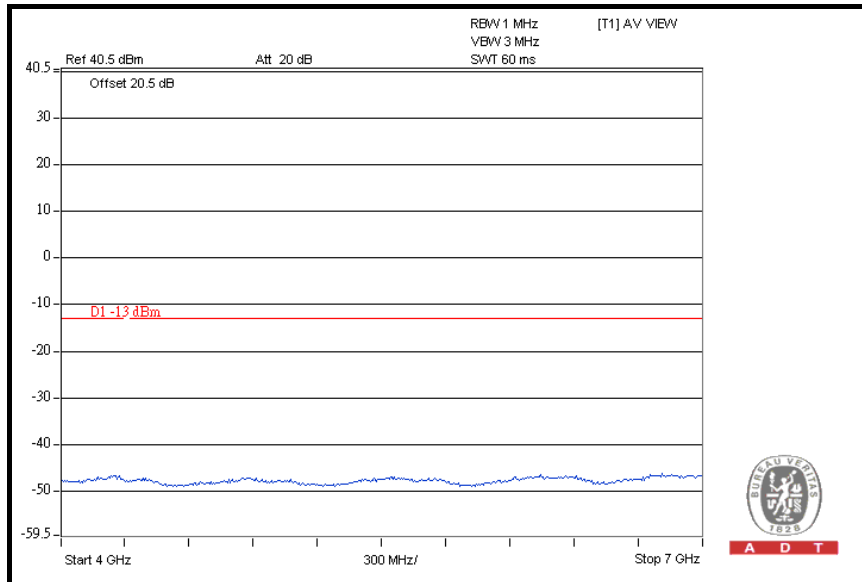

7GHz ~ 9GHz

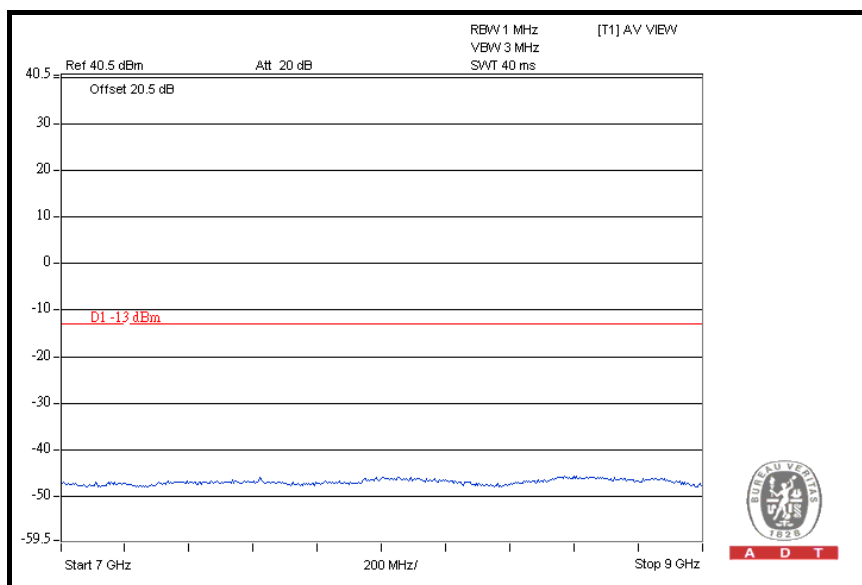

4.6 RADIATED EMISSION MEASUREMENT (BELOW 1GHz)

4.6.1 LIMITS OF RADIATED EMISSION MEASUREMENT

In the FCC 24.238(a), On any frequency outside a licensee's frequency block within USPCS spectrum, the power of any emission shall be attenuated below the transmitter power (P) by at least $43 + 10 \log (P)$ dB. The emission limit equal to -13 dBm. So the limit of emission is the same absolute specified line.

LIMIT (dBm)	EQUIVALENT FIELD STRENGTH AT 3m (dBuV/m) (NOTE)
-13	82.2

NOTE: The following formula is used to convert the equipment radiated power to field strength.

$$E = [1000000\sqrt{(30P)}] / 3 \text{ uV/m, where P is Watts.}$$

4.6.2 TEST INSTRUMENTS

Same as 4.1.2.

4.6.3 TEST PROCEDURES

- a. The EUT was placed on the top of a rotating table 0.8 meters above the ground at a 3 meters semi-anechoic chamber. The table was rotated 360 degrees to determine the position of the highest radiation.
- b. The EUT was set 3 meters away from the interference-receiving antenna, which was mounted on the top of a variable-height antenna tower.
- c. The antenna is a broadband antenna, and its height is varied from one meter to four meters above the ground to determine the maximum value of the field strength. Both horizontal and vertical polarizations of the antenna are set to make the measurement.
- d. For each suspected emission, the EUT was arranged to its worst case and then the antenna was tuned to heights from 1 meter to 4 meters and the rotatable table was turned from 0 degrees to 360 degrees to find the maximum reading.
- e. The test-receiver system was set to Peak Detect Function and Specified Bandwidth with Maximum Hold Mode.
- f. If the emission level of the EUT in peak mode was lower than the limit specified, then testing could be stopped and the peak values of the EUT would be reported. Otherwise the emissions would be re-tested one by one using peak, quasi-peak or average method as specified and then reported in a data sheet.

NOTE: The resolution bandwidth of spectrum analyzer is 1 MHz and the video bandwidth is 3 MHz.

4.6.4 DEVIATION FROM TEST STANDARD

No deviation

4.6.5 TEST SETUP

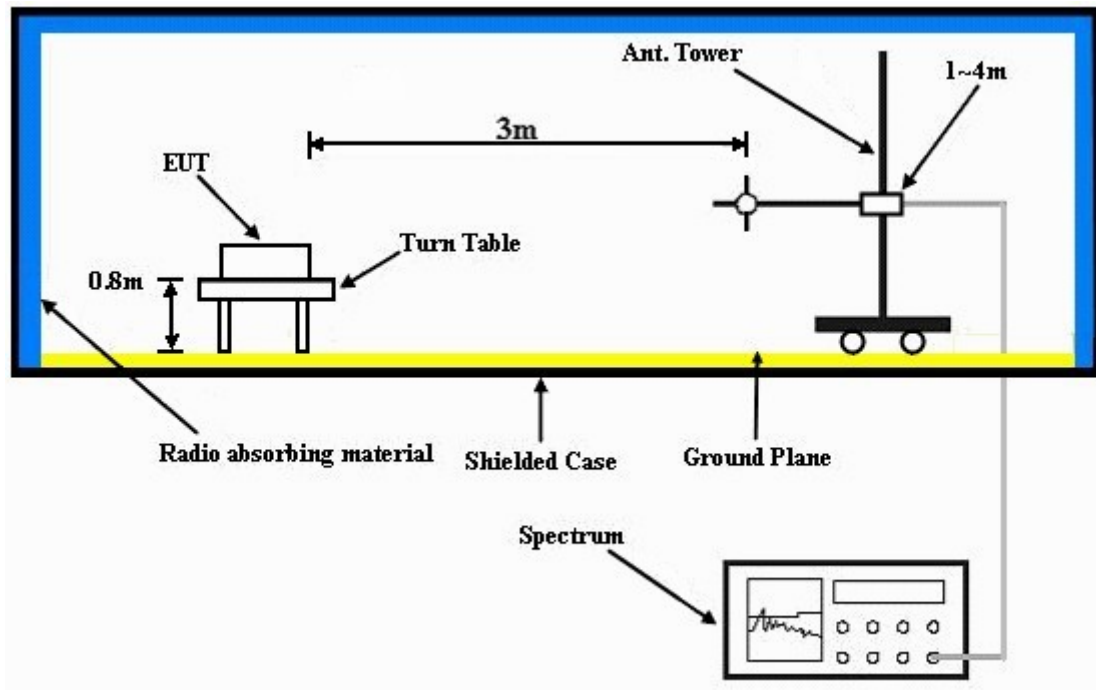

For the actual test configuration, please refer to the attached file (Test Setup Photo).

4.6.6 EUT OPERATING CONDITIONS

Same as 4.1.5

4.6.7 TEST RESULTS

MODE	TX channel 4357	FREQUENCY RANGE	Below 1000 MHz
ENVIRONMENTAL CONDITIONS	25deg. C, 68%RH, 1009hPa	INPUT POWER	120Vac, 60 Hz
TESTED BY	Sun Lin		

ANTENNA POLARITY & TEST DISTANCE: HORIZONTAL AT 3 M								
No.	Freq. (MHz)	Emission Level (dBuV/m)	Limit (dBuV/m)	Margin (dB)	Antenna Height (m)	Table Angle (Degree)	Raw Value (dBuV)	Correction Factor (dB/m)
1	121.36	41.2	82.2	-41.0	1.50 H	232	29.40	11.80
2	201.06	46.7	82.2	-35.5	1.25 H	25	35.70	11.00
3	249.66	41.7	82.2	-40.5	1.00 H	136	29.10	12.60
4	500.42	41.1	82.2	-41.1	1.50 H	58	21.90	19.20
5	677.31	36.1	82.2	-46.1	1.25 H	175	14.20	21.90
6	751.18	38.3	82.2	-43.9	1.00 H	49	15.10	23.20
ANTENNA POLARITY & TEST DISTANCE: VERTICAL AT 3 M								
No.	Freq. (MHz)	Emission Level (dBuV/m)	Limit (dBuV/m)	Margin (dB)	Antenna Height (m)	Table Angle (Degree)	Raw Value (dBuV)	Correction Factor (dB/m)
1	39.72	48.6	82.2	-33.6	1.00 V	226	35.00	13.60
2	109.70	37.1	82.2	-45.1	1.25 V	103	26.70	10.40
3	249.66	37.7	82.2	-44.5	1.00 V	109	25.10	12.60
4	401.28	34.7	82.2	-47.5	1.25 V	19	17.80	16.90
5	500.42	36.6	82.2	-45.6	2.00 V	115	17.40	19.20
6	751.18	37.1	82.2	-45.1	1.50 V	124	13.90	23.20

NOTE:

1. Emission level (dBuV/m) = Raw Value (dBuV) + Correction Factor (dB).
2. Correction Factor (dB/m) = Antenna Factor (dB/m) + Cable Factor (dB).
3. The other emission levels were very low against the limit.
4. Margin value = Emission level – Limit value.
5. This is valid for all 3 channels.

4.7 RADIATED EMISSION MEASUREMENT (ABOVE 1GHz)

4.7.1 LIMITS OF RADIATED EMISSION MEASUREMENT

In the FCC 22.917 (a), On any frequency outside a licensee's frequency block within GPRS spectrum, the power of any emission shall be attenuated below the transmitter power (P) by at least $43 + 10 \log (P)$ dB. The emission limit equal to -13dBm .

4.7.2 TEST INSTRUMENTS

Same as 4.1.2.

4.7.3 TEST PROCEDURES

- a. Substitution method is used for E.I.R.P measurement. In the semi-anechoic chamber, EUT placed on the 0.8m height of Turn Table, rotated the table around 360 degrees to search the maximum radiation power and receiver antenna shall be rotated vertical and horizontal polarization and moved height from 1m to 4m to find the maximum polar radiated power. The “Read Value” is the spectrum reading the maximum power value.
- b. The substitution horn antenna is substituted for EUT at the same position and signals generator export the CW signal to the substitution antenna via a TX cable. Rotated the Turn Table and moved receiving antenna to find the maximum radiation power. Adjust output power level of S.G to get a Value of spectrum reading equal to “Read Value” of step a. Record the power level of S.G
- c. $EIRP = \text{Output power level of S.G} - \text{TX cable loss} + \text{Antenna gain of substitution horn.}$
- d. E.R.P power can be calculated form E.I.R.P power by subtracting the gain of dipole, $E.R.P \text{ power} = E.I.P.R \text{ power} - 2.15\text{dBi.}$

NOTE: The resolution bandwidth and video bandwidth of test receiver/spectrum analyzer is 1MHz/3MHz.

4.7.4 DEVIATION FROM TEST STANDARD

No deviation

4.7.5 TEST SETUP

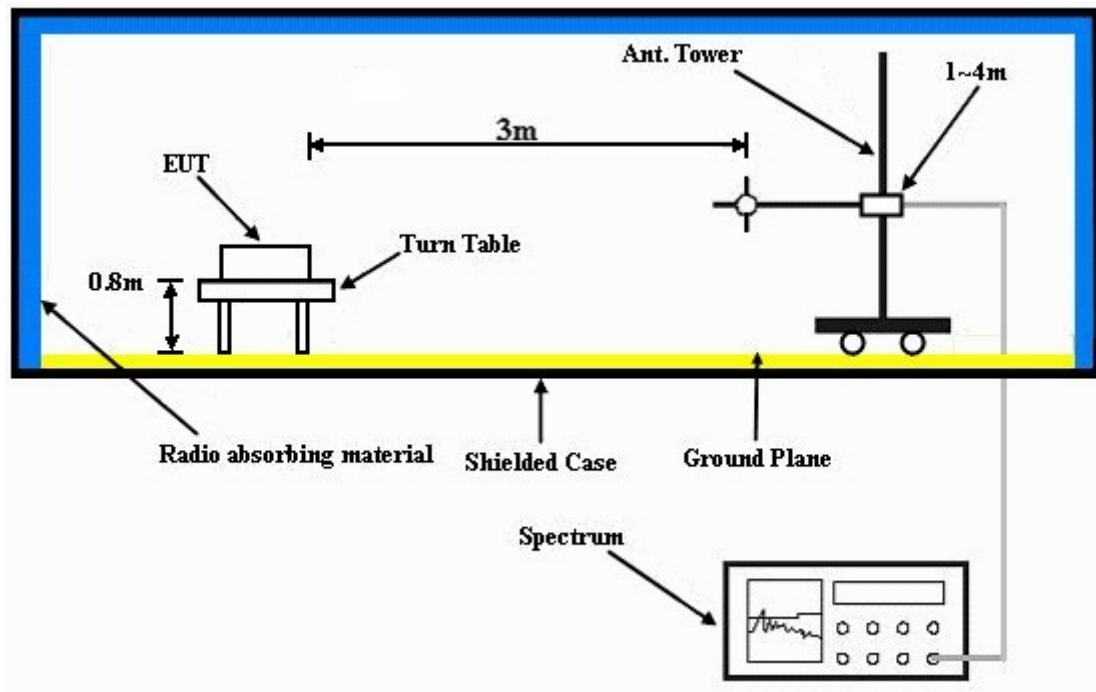

For the actual test configuration, please refer to the attached file (Test Setup Photo).

4.7.6 EUT OPERATING CONDITIONS

Same as 4.1.5

4.7.7 TEST RESULTS

MODE	TX channel 4357	FREQUENCY RANGE	Above 1000 MHz
INPUT POWER	120Vac, 60 Hz	ENVIRONMENTAL CONDITIONS	25deg. C, 68%RH, 1009hPa
TESTED BY	Sun Lin		

ANTENNA POLARITY & TEST DISTANCE: HORIZONTAL AT 3 M						
No.	Freq. (MHz)	Emission Level (dBuV)	Limit (dBm)	S.G Power Value (dBm)	Correction Factor (dB)	Power Value (dBm)
1	1742.8	53.3	-13.0	-48.9	7.9	-41.0
2	2614.2	57.2	-13.0	-45.8	8.5	-37.3
3	3485.6	49.8	-13.0	-54.6	10.0	-44.6
ANTENNA POLARITY & TEST DISTANCE: VERTICAL AT 3 M						
No.	Freq. (MHz)	Emission Level (dBuV)	Limit (dBm)	S.G Power Value (dBm)	Correction Factor (dB)	Power Value (dBm)
1	1742.8	52.4	-13.0	-49.8	7.9	-41.9
2	2614.2	45.0	-13.0	-58.0	8.5	-49.5
3	3485.6	43.2	-13.0	-61.2	10.0	-51.2

NOTE: Power Value (dBum) = S.G Power Value (dBm) + Correction Factor (dB).



A D T

MODE	TX channel 4408	FREQUENCY RANGE	Above 1000 MHz
INPUT POWER	120Vac, 60 Hz	ENVIRONMENTAL CONDITIONS	25deg. C, 68%RH, 1009hPa
TESTED BY	Sun Lin		

ANTENNA POLARITY & TEST DISTANCE: HORIZONTAL AT 3 M						
No.	Freq. (MHz)	Emission Level (dBuV)	Limit (dBm)	S.G Power Value (dBm)	Correction Factor (dB)	Power Value (dBm)
1	1763.2	55.1	-13.0	-47.4	8.3	-39.1
2	2644.8	58.9	-13.0	-43.8	8.5	-35.3
3	3526.4	50.7	-13.0	-53.4	10.0	-43.4
ANTENNA POLARITY & TEST DISTANCE: VERTICAL AT 3 M						
No.	Freq. (MHz)	Emission Level (dBuV)	Limit (dBm)	S.G Power Value (dBm)	Correction Factor (dB)	Power Value (dBm)
1	1763.2	56.7	-13.0	-45.8	8.3	-37.5
2	2644.8	48.6	-13.0	-54.1	8.5	-45.6
3	3526.4	45.4	-13.0	-58.7	10.0	-48.7

NOTE: Power Value (dBum) = S.G Power Value (dBm) + Correction Factor (dB).

MODE	TX channel 4458	FREQUENCY RANGE	Above 1000 MHz
INPUT POWER	120Vac, 60 Hz	ENVIRONMENTAL CONDITIONS	25deg. C, 68%RH, 1009hPa
TESTED BY	Sun Lin		

ANTENNA POLARITY & TEST DISTANCE: HORIZONTAL AT 3 M						
No.	Freq. (MHz)	Emission Level (dBuV)	Limit (dBm)	S.G Power Value (dBm)	Correction Factor (dB)	Power Value (dBm)
1	1783.2	55.3	-13.0	-47.1	8.3	-38.8
2	2674.8	62.0	-13.0	-40.6	8.6	-32.0
3	3566.4	55.8	-13.0	-48.2	9.9	-38.3
ANTENNA POLARITY & TEST DISTANCE: VERTICAL AT 3 M						
No.	Freq. (MHz)	Emission Level (dBuV)	Limit (dBm)	S.G Power Value (dBm)	Correction Factor (dB)	Power Value (dBm)
1	1783.2	53.6	-13.0	-48.8	8.3	-40.5
2	2674.8	48.8	-13.0	-53.8	8.6	-45.2
3	3566.4	45.5	-13.0	-58.5	9.9	-48.6

NOTE: Power Value (dBum) = S.G Power Value (dBm) + Correction Factor (dB).

5 PHOTOGRAPHS OF THE TEST CONFIGURATION

Please refer to the attached file (Test Setup Photo).



6 INFORMATION ON THE TESTING LABORATORIES

We, Bureau Veritas Consumer Products Services (H.K.) Ltd., Taoyuan Branch, were founded in 1988 to provide our best service in EMC, Radio, Telecom and Safety consultation. Our laboratories are accredited and approved according to ISO/IEC 17025.

Copies of accreditation certificates of our laboratories obtained from approval agencies can be downloaded from our web site: www.adt.com.tw/index.5.phtml.
If you have any comments, please feel free to contact us at the following:

Linko EMC/RF Lab:

Tel: 886-2-26052180

Fax: 886-2-26051924

Hsin Chu EMC/RF Lab:

Tel: 886-3-5935343

Fax: 886-3-5935342

Hwa Ya EMC/RF/Safety/Telecom Lab:

Tel: 886-3-3183232

Fax: 886-3-3185050

Web Site: www.adt.com.tw

The address and road map of all our labs can be found in our web site also.

7 APPENDIX A – MODIFICATIONS RECORDERS FOR ENGINEERING CHANGES TO THE EUT BY THE LAB

No any modifications are made to the EUT by the lab during the test.

---END---