

## FCC Test Report

**Report No.:** RF170411E14B-1

**FCC ID:** ZMYHGW500SN2A4Q

**Test Model:** HGW-500SN2A4-Q

**Received Date:** Oct. 30, 2017

**Test Date:** Nov. 18 to 21, 2017

**Issued Date:** Dec. 21, 2017

**Applicant:** MitraStar Technology Corporation

**Address:** No. 6, Innovation Rd II, Science-Based Industrial, Hsin-Chu, Taiwan

**Issued By:** Bureau Veritas Consumer Products Services (H.K.) Ltd., Taoyuan Branch  
Hsin Chu Laboratory

**Lab Address:** E-2, No.1, Li Hsin 1st Road, Hsinchu Science Park, Hsinchu City 300,  
Taiwan R.O.C.

**Test Location :** E-2, No.1, Li Hsin 1st Road, Hsinchu Science Park, Hsinchu City 300,  
Taiwan R.O.C.

**FCC Registration /  
Designation Number:** 723255 / TW2022



This report is for your exclusive use. Any copying or replication of this report to or for any other person or entity, or use of our name or trademark, is permitted only with our prior written permission. This report sets forth our findings solely with respect to the test samples identified herein. The results set forth in this report are not indicative or representative of the quality or characteristics of the lot from which a test sample was taken or any similar or identical product unless specifically and expressly noted. Our report includes all of the tests requested by you and the results thereof based upon the information that you provided to us. You have 60 days from date of issuance of this report to notify us of any material error or omission caused by our negligence, provided, however, that such notice shall be in writing and shall specifically address the issue you wish to raise. A failure to raise such issue within the prescribed time shall constitute your unqualified acceptance of the completeness of this report, the tests conducted and the correctness of the report contents. Unless specific mention, the uncertainty of measurement has been explicitly taken into account to declare the compliance or non-compliance to the specification. The report must not be used by the client to claim product certification, approval, or endorsement by TAF or any government agencies.

## Table of Contents

<b>Release Control Record</b> .....	<b>4</b>
<b>1 Certificate of Conformity</b> .....	<b>5</b>
<b>2 Summary of Test Results</b> .....	<b>6</b>
2.1 Measurement Uncertainty .....	6
2.2 Modification Record .....	6
<b>3 General Information</b> .....	<b>7</b>
3.1 General Description of EUT .....	7
3.2 Description of Test Modes .....	11
3.2.1 Test Mode Applicability and Tested Channel Detail .....	12
3.3 Duty Cycle of Test Signal .....	14
3.4 Description of Support Units .....	15
3.4.1 Configuration of System under Test .....	16
3.5 General Description of Applied Standard .....	17
<b>4 Test Types and Results</b> .....	<b>18</b>
4.1 Radiated Emission and Bandedge Measurement .....	18
4.1.1 Limits of Radiated Emission and Bandedge Measurement .....	18
4.1.2 Test Instruments .....	19
4.1.3 Test Procedure .....	20
4.1.4 Deviation from Test Standard .....	20
4.1.5 Test Setup .....	21
4.1.6 EUT Operating Condition .....	22
4.1.7 Test Results .....	23
4.2 Conducted Emission Measurement .....	43
4.2.1 Limits of Conducted Emission Measurement .....	43
4.2.2 Test Instruments .....	43
4.2.3 Test Procedure .....	44
4.2.4 Deviation from Test Standard .....	44
4.2.5 Test Setup .....	44
4.2.6 EUT Operating Condition .....	44
4.2.7 Test Results .....	45
4.3 Transmit Power Measurement .....	47
4.3.1 Limits of Transmit Power Measurement .....	47
4.3.2 Test Setup .....	47
4.3.3 Test Instruments .....	47
4.3.4 Test Procedure .....	47
4.3.5 Deviation from Test Standard .....	47
4.3.6 EUT Operating Condition .....	47
4.3.7 Test Result .....	48
4.4 Occupied Bandwidth Measurement .....	54
4.4.1 Test Setup .....	54
4.4.2 Test Instruments .....	54
4.4.3 Test Procedure .....	54
4.4.4 Test Results .....	55
4.5 Peak Power Spectral Density Measurement .....	65
4.5.1 Limits of Peak Power Spectral Density Measurement .....	65
4.5.2 Test Setup .....	65
4.5.3 Test Instruments .....	65
4.5.4 Test Procedure .....	66
4.5.5 Deviation from Test Standard .....	66
4.5.6 EUT Operating Condition .....	66
4.5.7 Test Results .....	67
4.6 Frequency Stability Measurement .....	77
4.6.1 Limits of Frequency Stability Measurement .....	77

4.6.2	Test Setup.....	77
4.6.3	Test Instruments .....	77
4.6.4	Test Procedure .....	77
4.6.5	Deviation from Test Standard .....	77
4.6.6	EUT Operating Condition .....	77
4.6.7	Test Results .....	78
4.7	6dB Bandwidth Measurement .....	79
4.7.1	Limits of 6dB Bandwidth Measurement.....	79
4.7.2	Test Setup.....	79
4.7.3	Test Instruments .....	79
4.7.4	Test Procedure .....	79
4.7.5	Deviation from Test Standard .....	79
4.7.6	EUT Operating Condition .....	79
4.7.7	Test Results .....	80
<b>5</b>	<b>Pictures of Test Arrangements.....</b>	<b>82</b>
	<b>Annex A- Radiated Out of Band Emission (OOBE) Measurement (For U-NII-3 band) .....</b>	<b>83</b>
	<b>Appendix – Information on the Testing Laboratories .....</b>	<b>87</b>

### Release Control Record

Issue No.	Description	Date Issued
RF170411E14B-1	Original release.	Dec. 21, 2017

## 1 Certificate of Conformity

**Product:** Base Port2 , Adaptador Wifi+ Dual

**Brand:** MitraStar

**Test Model:** HGW-500SN2A4-Q

**Sample Status:** ENGINEERING SAMPLE

**Applicant:** MitraStar Technology Corporation

**Test Date:** Nov. 18 to 21, 2017

**Standard:** 47 CFR FCC Part 15, Subpart E (Section 15.407)  
ANSI C63.10: 2013

The above equipment has been tested by **Bureau Veritas Consumer Products Services (H.K.) Ltd., Taoyuan Branch**, and found compliance with the requirement of the above standards. The test record, data evaluation & Equipment Under Test (EUT) configurations represented herein are true and accurate accounts of the measurements of the sample's EMC characteristics under the conditions specified in this report.

**Prepared by :** Mary Ko , **Date:** Dec. 21, 2017  
Mary Ko / Specialist

**Approved by :** May Chen , **Date:** Dec. 21, 2017  
May Chen / Manager

## 2 Summary of Test Results

47 CFR FCC Part 15, Subpart E (Section 15.407)			
FCC Clause	Test Item	Result	Remarks
15.407(b)(6)	AC Power Conducted Emissions	Pass	Meet the requirement of limit. Minimum passing margin is -10.41dB at 0.36875MHz.
15.407(b) (1/2/3/4(i/ii)/6)	Radiated Emissions & Band Edge Measurement*	Pass	Meet the requirement of limit. Minimum passing margin is -0.1dB at 5147.60MHz, 10360.00MHz, 10480.00MHz.
15.407(a)(1/2/3)	Max Average Transmit Power	Pass	Meet the requirement of limit.
---	Occupied Bandwidth Measurement	-	Reference only.
15.407(a)(1/2/3)	Peak Power Spectral Density	Pass	Meet the requirement of limit.
15.407(e)	6dB bandwidth	Pass	Meet the requirement of limit. (U-NII-3 Band only)
15.407(g)	Frequency Stability	Pass	Meet the requirement of limit.
15.203	Antenna Requirement	Pass	Antenna connector is i-pex(MHF) not a standard connector.

\*For U-NII-3 band compliance with rule part 15.407(b)(4)(i), the OOB test plots were recorded in Annex A.

### 2.1 Measurement Uncertainty

Where relevant, the following measurement uncertainty levels have been estimated for tests performed on the EUT as specified in CISPR 16-4-2:

Measurement	Frequency	Expanded Uncertainty (k=2) (±)
Conducted Emissions at mains ports	150kHz ~ 30MHz	1.84 dB
Radiated Emissions up to 1 GHz	30MHz ~ 1GHz	5.30 dB
Radiated Emissions above 1 GHz	1GHz ~ 6GHz	5.16 dB
	6GHz ~ 18GHz	4.91 dB
	18GHz ~ 40GHz	5.30 dB

### 2.2 Modification Record

There were no modifications required for compliance.

### 3 General Information

#### 3.1 General Description of EUT

Product	Base Port2 , Adaptador Wifi+ Dual
Brand	MitraStar
Test Model	HGW-500SN2A4-Q
FW version	WAS: ES_100WZA0b2_adapt_0418 IS: GL_s00.00_g002_100WZA0b4
Status of EUT	ENGINEERING SAMPLE
Power Supply Rating	DC 12V from power adapter
Modulation Type	CCK, DQPSK, DBPSK for DSSS 64QAM, 16QAM, QPSK, BPSK for OFDM 256QAM for OFDM in 11ac mode only
Modulation Technology	DSSS, OFDM
Transfer Rate	802.11a/b: up to 11Mbps 802.11g: up to 54Mbps 802.11n: up to 600Mbps 802.11ac: up to 1733.3Mbps
Operating Frequency	<b>2.4GHz:</b> 2.412 ~ 2.462GHz <b>5GHz:</b> 5.18 ~ 5.24GHz, 5.745 ~ 5.825GHz
Number of Channel	<b>2.4GHz:</b> 802.11b, 802.11g, 802.11n (HT20): 11 802.11n (HT40): 7 <b>5GHz:</b> 802.11a, 802.11n (HT20), 802.11ac (VHT20): 9 802.11n (HT40), 802.11ac (VHT40): 4 802.11ac (VHT80): 2
Output Power	<b>2.4GHz:</b> 996.099mW <b>5.18 ~ 5.24GHz:</b> <b>Master Mode</b> <b>CDD Mode:</b> 275.729mW <b>Beamforming Mode:</b> 242.761mW <b>Client Mode</b> <b>CDD Mode:</b> 173.739mW <b>Beamforming Mode:</b> 173.325mW <b>5.745 ~ 5.825GHz:</b> <b>CDD Mode:</b> 611.422mW <b>Beamforming Mode:</b> 611.422mW
Antenna Type	Refer to Note
Antenna Connector	Refer to Note
Accessory Device	Adapter x 1
Data Cable Supplied	RJ-45 cable (Unshielded, 1.5m)

Note:

1. Simultaneously transmission condition.

Condition	Technology	
1	WLAN 2.4GHz	WLAN 5GHz

**Note:** The emission of the simultaneous operation has been evaluated and no non-compliance was found.

2. The EUT must be supplied with a power adapter as following table:

No.	Brand	Model No.	Spec.
1	FRECOM	F12L30-120100SPAU	AC Input: 100-240Vac, 0.3A, 50/60Hz DC Output: 12V, 1A DC Output cable: Unshielded, 1.5m

3. The antennas provided to the EUT, please refer to the following table:

Frequency range (MHz)	Directional Antenna Gain (dBi)
2412 ~ 2462	5.502 (3.8 for 1TX)
5180 ~ 5240	7.59
5260 ~ 5320	7.62
5500 ~ 5580	6.86
5660 ~ 5700	6.86
5745 ~ 5825	6.66



4. The EUT incorporates a MIMO function:

2.4GHz Band			
MODULATION MODE	DATA RATE (MCS)	TX & RX CONFIGURATION	
802.11b	1 ~ 11Mbps	1TX	2RX
802.11g	6 ~ 54Mbps	1TX	2RX
802.11n (HT20)	MCS 0~7	2TX	2RX
	MCS 8~15	2TX	2RX
802.11n (HT40)	MCS 0~7	2TX	2RX
	MCS 8~15	2TX	2RX
5GHz Band			
MODULATION MODE	DATA RATE (MCS)	TX & RX CONFIGURATION	
802.11a	6 ~ 54Mbps	4TX	4RX
802.11n (HT20)	MCS 0~7	4TX	4RX
	MCS 8~15	4TX	4RX
	MCS 16~23	4TX	4RX
	MCS 24~31	4TX	4RX
802.11n (HT40)	MCS 0~7	4TX	4RX
	MCS 8~15	4TX	4RX
	MCS 16~23	4TX	4RX
	MCS 24~31	4TX	4RX
802.11ac (VHT20)	MCS 0~8 Nss=1	4TX	4RX
	MCS 0~8 Nss=2	4TX	4RX
	MCS 0~9 Nss=3	4TX	4RX
	MCS 0~8 Nss=4	4TX	4RX
802.11ac (VHT40)	MCS 0~9 Nss=1	4TX	4RX
	MCS 0~9 Nss=2	4TX	4RX
	MCS 0~9 Nss=3	4TX	4RX
	MCS 0~9 Nss=4	4TX	4RX
802.11ac (VHT80)	MCS 0~9 Nss=1	4TX	4RX
	MCS 0~9 Nss=2	4TX	4RX
	MCS 0~9 Nss=3	4TX	4RX
	MCS 0~9 Nss=4	4TX	4RX

Note:

1. All of modulation mode support beamforming function except 2.4GHz and 802.11a modulation mode.
2. The EUT support Beamforming and CDD mode, therefore both mode were investigated and the worst case scenario was identified. The worst case data were presented in test report.
3. The modulation and bandwidth are similar for 802.11n mode for 20MHz (40MHz) and 802.11ac mode for 20MHz (40MHz), therefore investigated worst case to representative mode in test report. (Final test mode refer section 3.2.1)

5. The power setting are list as below:

<b>CDD Mode - Master Mode</b>							
802.11a		802.11ac (VHT20)		802.11ac (VHT40)		802.11ac (VHT80)	
Frequency (MHz)	Power Setting	Frequency (MHz)	Power Setting	Frequency (MHz)	Power Setting	Frequency (MHz)	Power Setting
5180	18	5180	16	5190	16	5210	12
5200	16	5200	17	5230	17	5775	20
5240	16	5240	16	5755	21		
5745	21	5745	21	5795	21		
5785	21	5785	21				
5825	21	5825	21				
<b>CDD Mode - Client Mode</b>							
802.11a		802.11ac (VHT20)		802.11ac (VHT40)		802.11ac (VHT80)	
Frequency (MHz)	Power Setting	Frequency (MHz)	Power Setting	Frequency (MHz)	Power Setting	Frequency (MHz)	Power Setting
5180	16	5180	16	5190	15	5210	12
5200	16	5200	16	5230	15		
5240	16	5240	16				
<b>Beamforming Mode - Master Mode</b>							
802.11ac (VHT20)		802.11ac (VHT40)		802.11ac (VHT80)			
Frequency (MHz)	Power Setting	Frequency (MHz)	Power Setting	Frequency (MHz)	Power Setting		
5180	16	5190	16	5210	12		
5200	17	5230	17	5775	20		
5240	16	5755	21				
5745	21	5795	21				
5785	21						
5825	21						
<b>Beamforming Mode - Client Mode</b>							
802.11ac (VHT20)		802.11ac (VHT40)		802.11ac (VHT80)			
Frequency (MHz)	Power Setting	Frequency (MHz)	Power Setting	Frequency (MHz)	Power Setting		
5180	16	5190	15	5210	12		
5200	16	5230	15				
5240	16						

6. This device can support different category application which switched by access point mode and client mode by software.

7. The above EUT information is declared by manufacturer and for more detailed features description, please refer to the manufacturer's specifications or user's manual.

### 3.2 Description of Test Modes

#### FOR 5180 ~ 5240MHz

4 channels are provided for 802.11a, 802.11n (HT20), 802.11ac (VHT20):

Channel	Frequency	Channel	Frequency
36	5180 MHz	44	5220 MHz
40	5200 MHz	48	5240 MHz

2 channels are provided for 802.11n (HT40), 802.11ac (VHT40):

Channel	Frequency	Channel	Frequency
38	5190 MHz	46	5230 MHz

1 channel is provided for 802.11ac (VHT80):

Channel	Frequency
42	5210 MHz

#### FOR 5745 ~ 5825MHz:

5 channels are provided for 802.11a, 802.11n (HT20), 802.11ac (VHT20):

Channel	Frequency	Channel	Frequency
149	5745 MHz	161	5805 MHz
153	5765 MHz	165	5825 MHz
157	5785 MHz		

2 channels are provided for 802.11n (HT40), 802.11ac (VHT40):

Channel	Frequency	Channel	Frequency
151	5755 MHz	159	5795 MHz

1 channel is provided for 802.11ac (VHT80):

Channel	Frequency
155	5775 MHz

### 3.2.1 Test Mode Applicability and Tested Channel Detail

EUT Configure Mode	Applicable To				Description
	RE $\geq$ 1G	RE $<$ 1G	PLC	APCM	
-	√	√	√	√	-

Where **RE $\geq$ 1G**: Radiated Emission above 1GHz      **RE $<$ 1G**: Radiated Emission below 1GHz  
**PLC**: Power Line Conducted Emission      **APCM**: Antenna Port Conducted Measurement

#### **Radiated Emission Test (Above 1GHz):**

- Pre-Scan has been conducted to determine the worst-case mode from all possible combinations between available modulations, data rates and antenna ports (if EUT with antenna diversity architecture).
- Following channel(s) was (were) selected for the final test as listed below.

CDD Mode						
Mode	FREQ. Band (MHz)	Available Channel	Tested Channel	Modulation Technology	Modulation Type	Data Rate (Mbps)
802.11a	5180-5240	36 to 48	36, 40, 48	OFDM	BPSK	6
802.11ac (VHT20)		36 to 48	36, 40, 48	OFDM	BPSK	6.5
802.11ac (VHT40)		38 to 46	38, 46	OFDM	BPSK	13.5
802.11ac (VHT80)		42	42	OFDM	BPSK	29.3
802.11a	5745-5825	149 to 165	149, 157, 165	OFDM	BPSK	6
802.11ac (VHT20)		149 to 165	149, 157, 165	OFDM	BPSK	6.5
802.11ac (VHT40)		151 to 159	151, 159	OFDM	BPSK	13.5
802.11ac (VHT80)		155	155	OFDM	BPSK	29.3

#### **Radiated Emission Test (Below 1GHz):**

- Pre-Scan has been conducted to determine the worst-case mode from all possible combinations between available modulations, data rates and antenna ports (if EUT with antenna diversity architecture).
- Following channel(s) was (were) selected for the final test as listed below.

CDD Mode						
Mode	FREQ. Band (MHz)	Available Channel	Tested Channel	Modulation Technology	Modulation Type	Data Rate (Mbps)
802.11ac (VHT40)	5180-5240 5745-5825	38 to 46 151 to 159	151	OFDM	BPSK	13.5

### Power Line Conducted Emission Test:

- Pre-Scan has been conducted to determine the worst-case mode from all possible combinations between available modulations, data rates and antenna ports (if EUT with antenna diversity architecture).
- Following channel(s) was (were) selected for the final test as listed below.

CDD Mode						
Mode	FREQ. Band (MHz)	Available Channel	Tested Channel	Modulation Technology	Modulation Type	Data Rate (Mbps)
802.11ac (VHT40)	5180-5240 5745-5825	38 to 46 151 to 159	151	OFDM	BPSK	13.5

### Antenna Port Conducted Measurement:

- This item includes all test value of each mode, but only includes spectrum plot of worst value of each mode.
- Pre-Scan has been conducted to determine the worst-case mode from all possible combinations between available modulations, data rates and antenna ports (if EUT with antenna diversity architecture).
- Following channel(s) was (were) selected for the final test as listed below.

CDD Mode						
Mode	FREQ. Band (MHz)	Available Channel	Tested Channel	Modulation Technology	Modulation Type	Data Rate (Mbps)
802.11a	5180-5240	36 to 48	36, 40, 48	OFDM	BPSK	6
802.11ac (VHT20)		36 to 48	36, 40, 48	OFDM	BPSK	6.5
802.11ac (VHT40)		38 to 46	38, 46	OFDM	BPSK	13.5
802.11ac (VHT80)		42	42	OFDM	BPSK	29.3
802.11a	5745-5825	149 to 165	149, 157, 165	OFDM	BPSK	6
802.11ac (VHT20)		149 to 165	149, 157, 165	OFDM	BPSK	6.5
802.11ac (VHT40)		151 to 159	151, 159	OFDM	BPSK	13.5
802.11ac (VHT80)		155	155	OFDM	BPSK	29.3
Beamforming Mode (output power only)						
Mode	FREQ. Band (MHz)	Available Channel	Tested Channel	Modulation Technology	Modulation Type	Data Rate (Mbps)
802.11ac (VHT20)	5180-5240	36 to 48	36, 40, 48	OFDM	BPSK	6.5
802.11ac (VHT40)		38 to 46	38, 46	OFDM	BPSK	13.5
802.11ac (VHT80)		42	42	OFDM	BPSK	29.3
802.11ac (VHT20)	5745-5825	149 to 165	149, 157, 165	OFDM	BPSK	6.5
802.11ac (VHT40)		151 to 159	151, 159	OFDM	BPSK	13.5
802.11ac (VHT80)		155	155	OFDM	BPSK	29.3

### Test Condition:

Applicable To	Environmental Conditions	Input Power	Tested By
RE $\geq$ 1G	24deg. C, 69%RH	120Vac, 60Hz	Andy Ho
RE $<$ 1G	24deg. C, 68%RH	120Vac, 60Hz	Andy Ho
PLC	25deg. C, 75%RH	120Vac, 60Hz	Andy Ho
APCM	25deg. C, 60%RH	120Vac, 60Hz	Robert Cheng

### 3.3 Duty Cycle of Test Signal

If duty cycle of test signal is  $\geq 98\%$ , duty factor is not required.

If duty cycle of test signal is  $< 98\%$ , duty factor shall be considered.

**802.11a:** Duty cycle =  $1.364 \text{ ms} / 1.408 \text{ ms} = 0.969$ , Duty factor =  $10 * \log(1/0.969) = 0.14$

**802.11ac (VHT20):** Duty cycle =  $4.972 \text{ ms} / 5.028 \text{ ms} = 0.989$

**802.11ac (VHT40):** Duty cycle =  $5.975 \text{ ms} / 6.045 \text{ ms} = 0.988$

**802.11ac (VHT80):** Duty cycle =  $2.777 \text{ ms} / 2.821 \text{ ms} = 0.984$

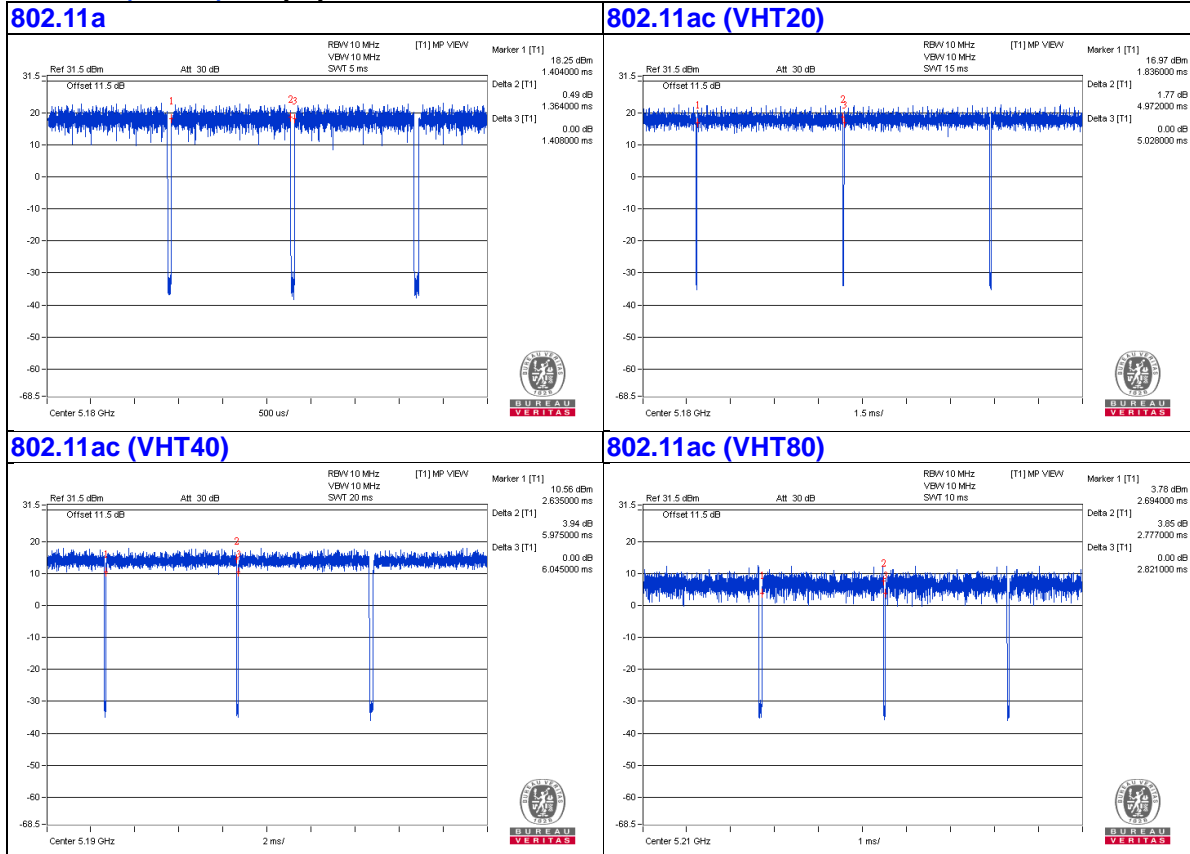

### 3.4 Description of Support Units

The EUT has been tested as an independent unit together with other necessary accessories or support units. The following support units or accessories were used to form a representative test configuration during the tests.

ID	Product	Brand	Model No.	Serial No.	FCC ID	Remarks
A.	Laptop	DELL	E5430	HYV4VY1	FCC DoC	Provided by Lab

Note:

1. All power cords of the above support units are non-shielded (1.8m).

ID	Descriptions	Qty.	Length (m)	Shielding (Yes/No)	Cores (Qty.)	Remarks
1.	RJ-45 Cable	1	10	No	0	Provided by Lab
2.	DC Cable	1	1.5	No	0	Supplied by client

### 3.4.1 Configuration of System under Test

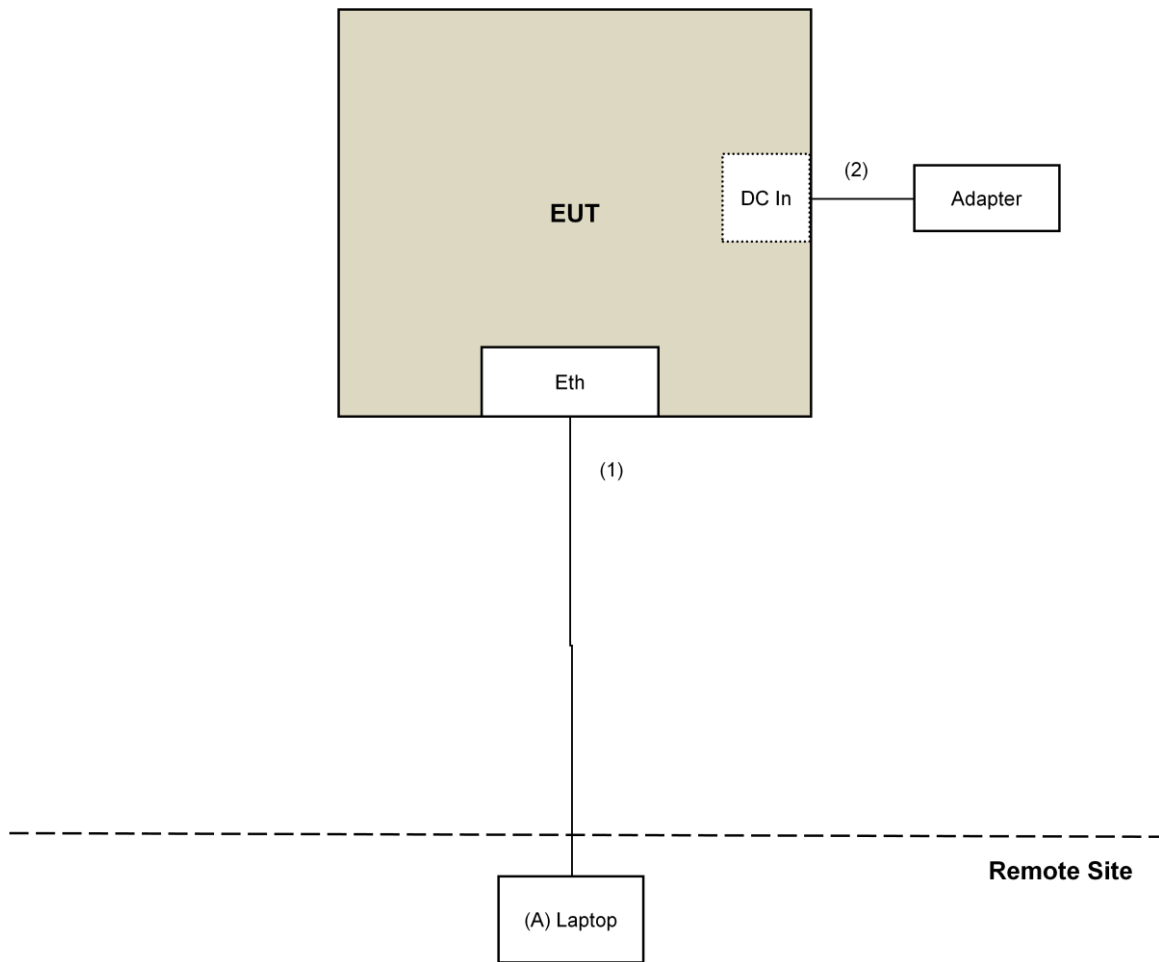



### 3.5 General Description of Applied Standard

The EUT is a RF Product. According to the specifications of the manufacturer, it must comply with the requirements of the following standards:

**FCC Part 15, Subpart E (15.407)**  
**KDB 789033 D02 General UNII Test Procedure New Rules v02**  
**KDB 662911 D01 Multiple Transmitter Output v02r01**  
**ANSI C63.10-2013**

All test items have been performed and recorded as per the above standards.

**NOTE:** The EUT has been verified to comply with the requirements of FCC Part 15, Subpart B, Class B (DoC). The test report has been issued separately.

## 4 Test Types and Results

### 4.1 Radiated Emission and Bandedge Measurement

#### 4.1.1 Limits of Radiated Emission and Bandedge Measurement

Radiated emissions which fall in the restricted bands must comply with the radiated emission limits specified as below table.

Frequencies (MHz)	Field Strength (microvolts/meter)	Measurement Distance (meters)
0.009 ~ 0.490	2400/F(kHz)	300
0.490 ~ 1.705	24000/F(kHz)	30
1.705 ~ 30.0	30	30
30 ~ 88	100	3
88 ~ 216	150	3
216 ~ 960	200	3
Above 960	500	3

#### NOTE:

1. The lower limit shall apply at the transition frequencies.
2. Emission level (dBuV/m) = 20 log Emission level (uV/m).
3. For frequencies above 1000MHz, the field strength limits are based on average detector, however, the peak field strength of any emission shall not exceed the maximum permitted average limits, specified above by more than 20dB under any condition of modulation.

Limits of unwanted emission out of the restricted bands

Applicable To		Limit	
789033 D02 General UNII Test Procedure New Rules v02		Field Strength at 3m	
		PK:74 (dBuV/m)	AV:54 (dBuV/m)
Frequency Band	Applicable To	EIRP Limit	Equivalent Field Strength at 3m
5150~5250 MHz	15.407(b)(1)	PK:-27 (dBm/MHz)	PK:68.2(dBuV/m)
5250~5350 MHz	15.407(b)(2)		
5470~5725 MHz	15.407(b)(3)		
5725~5850 MHz	<input checked="" type="checkbox"/> 15.407(b)(4)(i)	PK:-27 (dBm/MHz) <sup>*1</sup> PK:10 (dBm/MHz) <sup>*2</sup> PK:15.6 (dBm/MHz) <sup>*3</sup> PK:27 (dBm/MHz) <sup>*4</sup>	PK: 68.2(dBuV/m) <sup>*1</sup> PK:105.2 (dBuV/m) <sup>*2</sup> PK: 110.8(dBuV/m) <sup>*3</sup> PK:122.2 (dBuV/m) <sup>*4</sup>
	<input type="checkbox"/> 15.407(b)(4)(ii)	Emission limits in section 15.247(d)	
<sup>*1</sup> beyond 75 MHz or more above of the band edge.		<sup>*2</sup> below the band edge increasing linearly to 10 dBm/MHz at 25 MHz above.	
<sup>*3</sup> below the band edge increasing linearly to a level of 15.6 dBm/MHz at 5 MHz above.		<sup>*4</sup> from 5 MHz above or below the band edge increasing linearly to a level of 27 dBm/MHz at the band edge.	

#### Note:

The following formula is used to convert the equipment isotropic radiated power (eirp) to field strength:

$$E = \frac{1000000\sqrt{30P}}{3} \mu\text{V/m, where P is the eirp (Watts).}$$

## 4.1.2 Test Instruments

DESCRIPTION & MANUFACTURER	MODEL NO.	SERIAL NO.	CALIBRATED DATE	CALIBRATED UNTIL
Test Receiver Keysight	N9038A	MY54450088	July 08, 2017	July 07, 2018
Pre-Amplifier <sup>(*)</sup> EMCI	EMC001340	980142	Jan. 20, 2016	Jan. 19, 2018
Loop Antenna <sup>(*)</sup> Electro-Metrics	EM-6879	264	Dec. 16, 2016	Dec. 15, 2018
RF Cable	NA	LOOPCAB-001 LOOPCAB-002	Jan. 17, 2017	Jan. 16, 2018
Pre-Amplifier Mini-Circuits	ZFL-1000VH2B	AMP-ZFL-01	Nov. 09, 2017	Nov. 08, 2018
Trilog Broadband Antenna SCHWARZBECK	VULB 9168	9168-406	Dec. 13, 2016	Dec. 12, 2017
RF Cable	8D	966-4-1 966-4-2 966-4-3	Apr. 01, 2017	Mar. 31, 2018
Fixed attenuator Mini-Circuits	UNAT-5+	PAD-3m-4-01	Oct. 03, 2017	Oct. 02, 2018
Horn_Antenna SCHWARZBECK	BBHA 9120D	9120D-783	Dec. 27, 2016	Dec. 26, 2017
Pre-Amplifier EMCI	EMC12630SE	980385	Feb. 02, 2017	Feb. 01, 2018
RF Cable	EMC104-SM-SM-1200 EMC104-SM-SM-2000 EMC104-SM-SM-5000	160923 150318 150321	Feb. 02, 2017 Mar. 29, 2017 Mar. 29, 2017	Feb. 01, 2018 Mar. 28, 2018 Mar. 28, 2018
Pre-Amplifier EMCI	EMC184045SE	980387	Feb. 02, 2017	Feb. 01, 2018
Horn_Antenna SCHWARZBECK	BBHA 9170	BBHA9170608	Dec. 15, 2016	Dec. 14, 2017
RF Cable	SUCOFLEX 102	36432/2 36433/2	Jan. 15, 2017	Jan. 14, 2018
Software	ADT_Radiated_V8.7.08	NA	NA	NA
Antenna Tower & Turn Table Max-Full	MF-7802	MF780208410	NA	NA
Boresight Antenna Fixture	FBA-01	FBA-SIP02	NA	NA
Spectrum Analyzer R&S	FSV40	100964	July 1, 2017	June 30, 2018
Power meter Anritsu	ML2495A	1014008	May 11, 2017	May 10, 2018
Power sensor Anritsu	MA2411B	0917122	May 11, 2017	May 10, 2018
AC Power Source Extech Electronics	6205	1440452	NA	NA
Temperature & Humidity Chamber Giant Force	GTH-150-40-SP-AR	MAA0812-008	Jan. 11, 2017	Jan. 10, 2018
Digital Multimeter FLUKE	325	31130711WS	May 29, 2017	May 28, 2018

**Note:**

1. The calibration interval of the above test instruments is 12 months and the calibrations are traceable to NML/ROC and NIST/USA.
2. \*The calibration interval of the above test instruments is 24 months and the calibrations are traceable to NML/ROC and NIST/USA.
3. The test was performed in 966 Chamber No. 4.
4. Loop antenna was used for all emissions below 30 MHz.
5. The CANADA Site Registration No. is 20331-2
6. Tested Date: Nov. 18 to 21, 2017

#### 4.1.3 Test Procedure

##### **For Radiated emission below 30MHz**

- a. The EUT was placed on the top of a rotating table 0.8 meters above the ground at a 3 meter chamber room. The table was rotated 360 degrees to determine the position of the highest radiation.
- b. The EUT was set 3 meters away from the interference-receiving antenna, which was mounted on the top of a variable-height antenna tower.
- c. Both X and Y axes of the antenna are set to make the measurement.
- d. For each suspected emission, the EUT was arranged to its worst case and the rotatable table was turned from 0 degrees to 360 degrees to find the maximum reading.
- e. The test-receiver system was set to Quasi-Peak Detect Function and Specified Bandwidth with Maximum Hold Mode.

##### **NOTE:**

1. The resolution bandwidth and video bandwidth of test receiver/spectrum analyzer is 9kHz at frequency below 30MHz.

##### **For Radiated emission above 30MHz**

- a. The EUT was placed on the top of a rotating table 0.8 meters (for 30MHz ~ 1GHz) / 1.5 meters (for above 1GHz) above the ground at 3 meter chamber room for test. The table was rotated 360 degrees to determine the position of the highest radiation.
- b. The EUT was set 3 meters away from the interference-receiving antenna, which was mounted on the top of a variable-height antenna tower.
- c. The height of antenna is varied from one meter to four meters above the ground to determine the maximum value of the field strength. Both horizontal and vertical polarizations of the antenna are set to make the measurement.
- d. For each suspected emission, the EUT was arranged to its worst case and then the antenna was tuned to heights from 1 meter to 4 meters and the rotatable table was turned from 0 degrees to 360 degrees to find the maximum reading.
- e. The test-receiver system was set to quasi-peak detect function and specified bandwidth with maximum hold mode when the test frequency is below 1 GHz.
- f. The test-receiver system was set to peak and average detect function and specified bandwidth with maximum hold mode when the test frequency is above 1 GHz. If the peak reading value also meets average limit, measurement with the average detector is unnecessary.

##### **Note:**

1. The resolution bandwidth and video bandwidth of test receiver/spectrum analyzer is 120kHz for Quasi-peak detection (QP) at frequency below 1GHz.
2. The resolution bandwidth of test receiver/spectrum analyzer is 1 MHz and the video bandwidth is 3 MHz for Peak detection (PK) at frequency above 1GHz.
3. The resolution bandwidth of test receiver/spectrum analyzer is 1MHz and the video bandwidth is  $\geq 1/T$  (Duty cycle < 98%) or 10Hz (Duty cycle  $\geq 98\%$ ) for Average detection (AV) at frequency above 1GHz.
4. All modes of operation were investigated and the worst-case emissions are reported.

#### 4.1.4 Deviation from Test Standard

No deviation.

#### 4.1.5 Test Setup

##### For Radiated emission below 30MHz

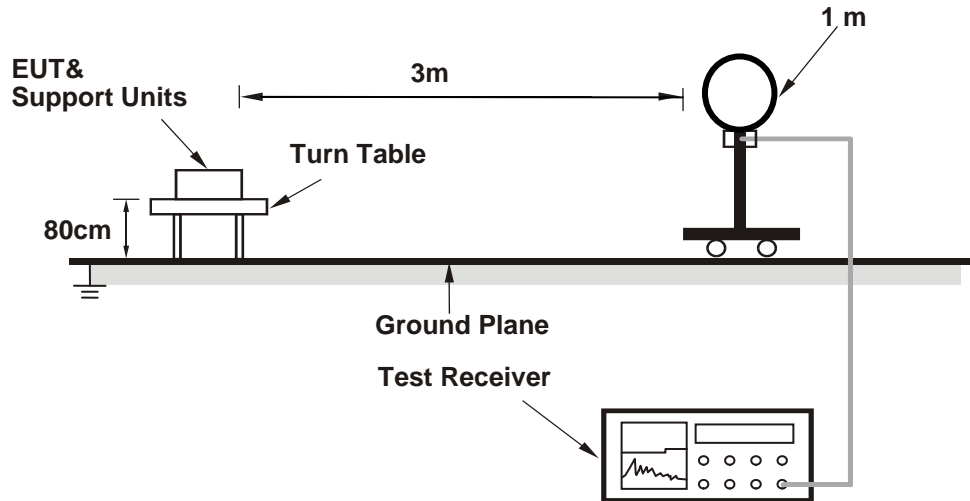

##### For Radiated emission 30MHz to 1GHz

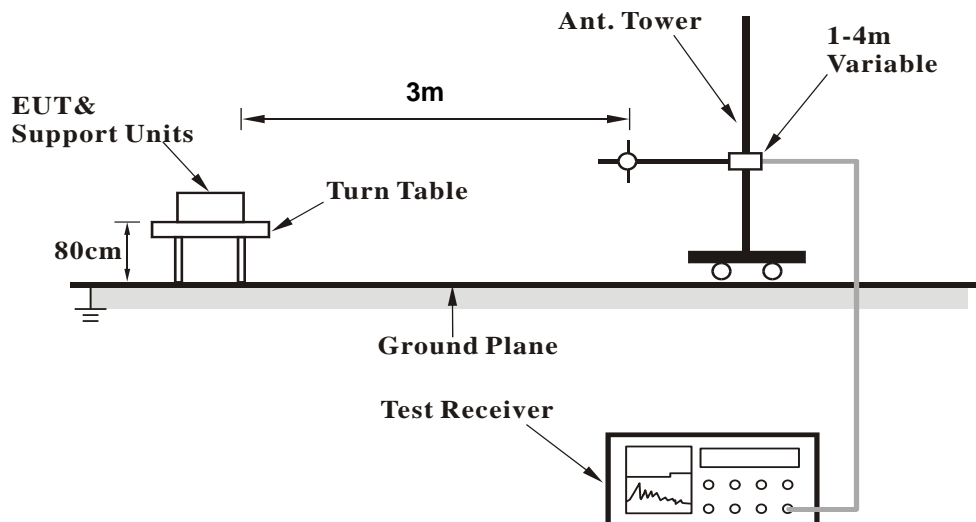

### For Radiated emission above 1GHz

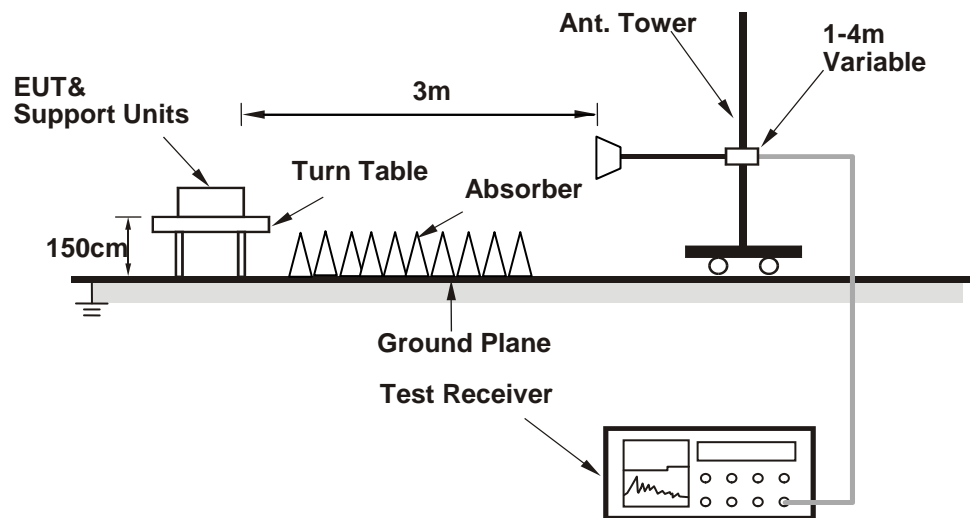

For the actual test configuration, please refer to the attached file (Test Setup Photo).

#### 4.1.6 EUT Operating Condition

- a. Connected the EUT with the Laptop which is placed on remote site.
- b. Controlling software (QTN Pasted Command.txt) has been activated to set the EUT on specific status.

4.1.7 Test Results

Above 1GHz Data:

802.11a

<b>CHANNEL</b>	TX Channel 36	<b>DETECTOR FUNCTION</b>	Peak (PK)
<b>FREQUENCY RANGE</b>	1GHz ~ 40GHz		Average (AV)

ANTENNA POLARITY & TEST DISTANCE: HORIZONTAL AT 3 M								
NO.	FREQ. (MHz)	EMISSION LEVEL (dBuV/m)	LIMIT (dBuV/m)	MARGIN (dB)	ANTENNA HEIGHT (m)	TABLE ANGLE (Degree)	RAW VALUE (dBuV)	CORRECTION FACTOR (dB/m)
1	5150.00	58.8 PK	74.0	-15.2	1.13 H	284	54.8	4.0
2	5150.00	45.9 AV	54.0	-8.1	1.13 H	284	41.9	4.0
3	*5180.00	111.8 PK			1.13 H	284	107.8	4.0
4	*5180.00	103.0 AV			1.13 H	284	99.0	4.0
5	#6906.00	54.8 PK	74.0	-19.2	3.12 H	286	46.2	8.6
6	#6906.00	47.3 AV	54.0	-6.7	3.12 H	286	38.7	8.6
7	#10360.00	66.4 PK	74.0	-7.6	1.86 H	267	52.8	13.6
8	#10360.00	53.7 AV	54.0	-0.3	1.86 H	267	40.1	13.6
9	15540.00	45.2 PK	74.0	-28.8	1.62 H	351	32.0	13.2
10	15540.00	34.3 AV	54.0	-19.7	1.62 H	351	21.1	13.2

ANTENNA POLARITY & TEST DISTANCE: VERTICAL AT 3 M								
NO.	FREQ. (MHz)	EMISSION LEVEL (dBuV/m)	LIMIT (dBuV/m)	MARGIN (dB)	ANTENNA HEIGHT (m)	TABLE ANGLE (Degree)	RAW VALUE (dBuV)	CORRECTION FACTOR (dB/m)
1	5150.00	63.0 PK	74.0	-11.0	1.23 V	291	59.0	4.0
2	5150.00	52.1 AV	54.0	-1.9	1.23 V	291	48.1	4.0
3	*5180.00	117.9 PK			1.23 V	291	113.9	4.0
4	*5180.00	108.6 AV			1.23 V	291	104.6	4.0
5	#10360.00	67.6 PK	74.0	-6.4	1.82 V	360	54.0	13.6
<b>6</b>	<b>#10360.00</b>	<b>53.9 AV</b>	<b>54.0</b>	<b>-0.1</b>	<b>1.82 V</b>	<b>360</b>	<b>40.3</b>	<b>13.6</b>
7	15540.00	49.4 PK	74.0	-24.6	3.18 V	258	36.2	13.2
8	15540.00	37.6 AV	54.0	-16.4	3.18 V	258	24.4	13.2

REMARKS:

- Emission Level(dBuV/m) = Raw Value(dBuV) + Correction Factor(dB/m)
- Correction Factor(dB/m) = Antenna Factor(dB/m) + Cable Factor(dB) – Pre-Amplifier Factor(dB)
- The other emission levels were very low against the limit.
- Margin value = Emission Level – Limit value
- " \* ": Fundamental frequency.
- " # ": The radiated frequency is out of the restricted band.

<b>CHANNEL</b>	TX Channel 40	<b>DETECTOR FUNCTION</b>	Peak (PK)
<b>FREQUENCY RANGE</b>	1GHz ~ 40GHz		Average (AV)

**ANTENNA POLARITY & TEST DISTANCE: HORIZONTAL AT 3 M**

NO.	FREQ. (MHz)	EMISSION LEVEL (dBuV/m)	LIMIT (dBuV/m)	MARGIN (dB)	ANTENNA HEIGHT (m)	TABLE ANGLE (Degree)	RAW VALUE (dBuV)	CORRECTION FACTOR (dB/m)
1	5150.00	52.9 PK	74.0	-21.1	1.11 H	292	48.9	4.0
2	5150.00	39.9 AV	54.0	-14.1	1.11 H	292	35.9	4.0
3	*5200.00	109.5 PK			1.18 H	292	105.5	4.0
4	*5200.00	101.4 AV			1.18 H	292	97.4	4.0
5	5359.00	53.5 PK	74.0	-20.5	1.18 H	292	49.1	4.4
6	5359.00	41.6 AV	54.0	-12.4	1.18 H	292	37.2	4.4
7	#10400.00	63.7 PK	74.0	-10.3	1.78 H	201	50.1	13.6
8	#10400.00	50.1 AV	54.0	-3.9	1.78 H	201	36.5	13.6
9	15600.00	45.9 PK	74.0	-28.1	1.59 H	353	32.5	13.4
10	15600.00	34.7 AV	54.0	-19.3	1.59 H	353	21.3	13.4

**ANTENNA POLARITY & TEST DISTANCE: VERTICAL AT 3 M**

NO.	FREQ. (MHz)	EMISSION LEVEL (dBuV/m)	LIMIT (dBuV/m)	MARGIN (dB)	ANTENNA HEIGHT (m)	TABLE ANGLE (Degree)	RAW VALUE (dBuV)	CORRECTION FACTOR (dB/m)
1	5150.00	57.1 PK	74.0	-16.9	2.51 V	319	53.1	4.0
2	5150.00	46.1 AV	54.0	-7.9	2.51 V	319	42.1	4.0
3	*5200.00	115.6 PK			2.51 V	319	111.6	4.0
4	*5200.00	107.0 AV			2.51 V	319	103.0	4.0
5	5359.00	57.7 PK	74.0	-16.3	2.51 V	319	53.3	4.4
6	5359.00	47.8 AV	54.0	-6.2	2.51 V	319	43.4	4.4
7	#10400.00	66.0 PK	74.0	-8.0	1.08 V	47	52.4	13.6
8	#10400.00	53.4 AV	54.0	-0.6	1.08 V	47	39.8	13.6
9	15600.00	50.0 PK	74.0	-24.0	3.18 V	245	36.6	13.4
10	15600.00	37.9 AV	54.0	-16.1	3.18 V	245	24.5	13.4

**REMARKS:**

1. Emission Level(dBuV/m) = Raw Value(dBuV) + Correction Factor(dB/m)
2. Correction Factor(dB/m) = Antenna Factor(dB/m) + Cable Factor(dB) – Pre-Amplifier Factor(dB)
3. The other emission levels were very low against the limit.
4. Margin value = Emission Level – Limit value
5. " \* ": Fundamental frequency.
6. " # ": The radiated frequency is out of the restricted band.



<b>CHANNEL</b>	TX Channel 48	<b>DETECTOR FUNCTION</b>	Peak (PK)
<b>FREQUENCY RANGE</b>	1GHz ~ 40GHz		Average (AV)

**ANTENNA POLARITY & TEST DISTANCE: HORIZONTAL AT 3 M**

NO.	FREQ. (MHz)	EMISSION LEVEL (dBuV/m)	LIMIT (dBuV/m)	MARGIN (dB)	ANTENNA HEIGHT (m)	TABLE ANGLE (Degree)	RAW VALUE (dBuV)	CORRECTION FACTOR (dB/m)
1	*5240.00	110.9 PK			1.14 H	307	106.7	4.2
2	*5240.00	102.2 AV			1.14 H	307	98.0	4.2
3	5400.00	52.4 PK	74.0	-21.6	1.14 H	307	48.0	4.4
4	5400.00	40.3 AV	54.0	-13.7	1.14 H	307	35.9	4.4
5	#6986.67	51.5 PK	74.0	-22.5	1.14 H	307	42.7	8.8
6	#6986.67	43.6 AV	54.0	-10.4	1.14 H	307	34.8	8.8
7	#10480.00	64.1 PK	74.0	-9.9	1.76 H	196	50.4	13.7
8	#10480.00	50.6 AV	54.0	-3.4	1.76 H	196	36.9	13.7
9	15720.00	46.0 PK	74.0	-28.0	1.55 H	348	32.0	14.0
10	15720.00	34.8 AV	54.0	-19.2	1.55 H	348	20.8	14.0

**ANTENNA POLARITY & TEST DISTANCE: VERTICAL AT 3 M**

NO.	FREQ. (MHz)	EMISSION LEVEL (dBuV/m)	LIMIT (dBuV/m)	MARGIN (dB)	ANTENNA HEIGHT (m)	TABLE ANGLE (Degree)	RAW VALUE (dBuV)	CORRECTION FACTOR (dB/m)
1	*5240.00	117.0 PK			1.03 V	218	112.8	4.2
2	*5240.00	107.8 AV			1.03 V	218	103.6	4.2
3	5400.00	56.4 PK	74.0	-17.6	1.03 V	266	52.0	4.4
4	5400.00	46.5 AV	54.0	-7.5	1.03 V	266	42.1	4.4
5	#6986.67	55.6 PK	74.0	-18.4	2.43 V	283	46.8	8.8
6	#6986.67	49.6 AV	54.0	-4.4	2.43 V	283	40.8	8.8
7	#10480.00	68.4 PK	74.0	-5.6	1.50 V	182	54.7	13.7
<b>8</b>	<b>#10480.00</b>	<b>53.9 AV</b>	<b>54.0</b>	<b>-0.1</b>	<b>1.50 V</b>	<b>182</b>	<b>40.2</b>	<b>13.7</b>
9	15720.00	49.8 PK	74.0	-24.2	3.14 V	247	35.8	14.0
10	15720.00	37.7 AV	54.0	-16.3	3.14 V	247	23.7	14.0

**REMARKS:**

- Emission Level(dBuV/m) = Raw Value(dBuV) + Correction Factor(dB/m)
- Correction Factor(dB/m) = Antenna Factor(dB/m) + Cable Factor(dB) – Pre-Amplifier Factor(dB)
- The other emission levels were very low against the limit.
- Margin value = Emission Level – Limit value
- " \* ": Fundamental frequency.
- " # ": The radiated frequency is out of the restricted band.

<b>CHANNEL</b>	TX Channel 149	<b>DETECTOR FUNCTION</b>	Peak (PK)
<b>FREQUENCY RANGE</b>	1GHz ~ 40GHz		Average (AV)

**ANTENNA POLARITY & TEST DISTANCE: HORIZONTAL AT 3 M**

NO.	FREQ. (MHz)	EMISSION LEVEL (dBuV/m)	LIMIT (dBuV/m)	MARGIN (dB)	ANTENNA HEIGHT (m)	TABLE ANGLE (Degree)	RAW VALUE (dBuV)	CORRECTION FACTOR (dB/m)
1	*5745.00	114.4 PK			1.00 H	360	109.4	5.0
2	*5745.00	105.4 AV			1.00 H	360	100.4	5.0
3	11490.00	58.4 PK	74.0	-15.6	1.22 H	195	44.3	14.1
4	11490.00	46.3 AV	54.0	-7.7	1.22 H	195	32.2	14.1
5	#17235.00	61.3 PK	74.0	-12.7	1.77 H	97	43.0	18.3
6	#17235.00	49.9 AV	54.0	-4.1	1.77 H	97	31.6	18.3

**ANTENNA POLARITY & TEST DISTANCE: VERTICAL AT 3 M**

NO.	FREQ. (MHz)	EMISSION LEVEL (dBuV/m)	LIMIT (dBuV/m)	MARGIN (dB)	ANTENNA HEIGHT (m)	TABLE ANGLE (Degree)	RAW VALUE (dBuV)	CORRECTION FACTOR (dB/m)
1	*5745.00	119.6 PK			1.50 V	152	114.6	5.0
2	*5745.00	110.9 AV			1.50 V	152	105.9	5.0
3	11490.00	64.6 PK	74.0	-9.4	1.91 V	143	50.5	14.1
4	11490.00	52.7 AV	54.0	-1.3	1.91 V	143	38.6	14.1
5	#17235.00	63.5 PK	74.0	-10.5	1.78 V	162	45.2	18.3
6	#17235.00	50.6 AV	54.0	-3.4	1.78 V	162	32.3	18.3

**REMARKS:**

1. Emission Level(dBuV/m) = Raw Value(dBuV) + Correction Factor(dB/m)
2. Correction Factor(dB/m) = Antenna Factor(dB/m) + Cable Factor(dB) – Pre-Amplifier Factor(dB)
3. The other emission levels were very low against the limit.
4. Margin value = Emission Level – Limit value
5. " \* ": Fundamental frequency.
6. " # ": The radiated frequency is out of the restricted band.

<b>CHANNEL</b>	TX Channel 157	<b>DETECTOR FUNCTION</b>	Peak (PK)
<b>FREQUENCY RANGE</b>	1GHz ~ 40GHz		Average (AV)

**ANTENNA POLARITY & TEST DISTANCE: HORIZONTAL AT 3 M**

NO.	FREQ. (MHz)	EMISSION LEVEL (dBuV/m)	LIMIT (dBuV/m)	MARGIN (dB)	ANTENNA HEIGHT (m)	TABLE ANGLE (Degree)	RAW VALUE (dBuV)	CORRECTION FACTOR (dB/m)
1	*5785.00	114.7 PK			1.01 H	360	109.7	5.0
2	*5785.00	105.5 AV			1.01 H	360	100.5	5.0
3	11570.00	58.5 PK	74.0	-15.5	1.26 H	206	44.5	14.0
4	11570.00	46.2 AV	54.0	-7.8	1.26 H	206	32.2	14.0
5	#17355.00	61.4 PK	74.0	-12.6	1.83 H	102	42.5	18.9
6	#17355.00	50.0 AV	54.0	-4.0	1.83 H	102	31.1	18.9

**ANTENNA POLARITY & TEST DISTANCE: VERTICAL AT 3 M**

NO.	FREQ. (MHz)	EMISSION LEVEL (dBuV/m)	LIMIT (dBuV/m)	MARGIN (dB)	ANTENNA HEIGHT (m)	TABLE ANGLE (Degree)	RAW VALUE (dBuV)	CORRECTION FACTOR (dB/m)
1	*5785.00	119.1 PK			1.03 V	91	114.1	5.0
2	*5785.00	110.4 AV			1.03 V	91	105.4	5.0
3	11570.00	64.8 PK	74.0	-9.2	1.27 V	176	50.8	14.0
4	11570.00	52.6 AV	54.0	-1.4	1.27 V	176	38.6	14.0
5	#17355.00	63.0 PK	74.0	-11.0	1.81 V	146	44.1	18.9
6	#17355.00	50.2 AV	54.0	-3.8	1.81 V	146	31.3	18.9

**REMARKS:**

1. Emission Level(dBuV/m) = Raw Value(dBuV) + Correction Factor(dB/m)
2. Correction Factor(dB/m) = Antenna Factor(dB/m) + Cable Factor(dB) – Pre-Amplifier Factor(dB)
3. The other emission levels were very low against the limit.
4. Margin value = Emission Level – Limit value
5. " \* ": Fundamental frequency.
6. " # ": The radiated frequency is out of the restricted band.

<b>CHANNEL</b>	TX Channel 165	<b>DETECTOR FUNCTION</b>	Peak (PK)
<b>FREQUENCY RANGE</b>	1GHz ~ 40GHz		Average (AV)

**ANTENNA POLARITY & TEST DISTANCE: HORIZONTAL AT 3 M**

NO.	FREQ. (MHz)	EMISSION LEVEL (dBuV/m)	LIMIT (dBuV/m)	MARGIN (dB)	ANTENNA HEIGHT (m)	TABLE ANGLE (Degree)	RAW VALUE (dBuV)	CORRECTION FACTOR (dB/m)
1	*5825.00	113.7 PK			1.50 H	360	108.5	5.2
2	*5825.00	104.8 AV			1.50 H	360	99.6	5.2
3	11650.00	58.7 PK	74.0	-15.3	1.19 H	207	44.6	14.1
4	11650.00	46.3 AV	54.0	-7.7	1.19 H	207	32.2	14.1
5	#17475.00	61.4 PK	74.0	-12.6	1.78 H	83	41.7	19.7
6	#17475.00	50.1 AV	54.0	-3.9	1.78 H	83	30.4	19.7

**ANTENNA POLARITY & TEST DISTANCE: VERTICAL AT 3 M**

NO.	FREQ. (MHz)	EMISSION LEVEL (dBuV/m)	LIMIT (dBuV/m)	MARGIN (dB)	ANTENNA HEIGHT (m)	TABLE ANGLE (Degree)	RAW VALUE (dBuV)	CORRECTION FACTOR (dB/m)
1	*5825.00	119.6 PK			2.40 V	327	114.4	5.2
2	*5825.00	110.7 AV			2.40 V	327	105.5	5.2
3	11650.00	66.8 PK	74.0	-7.2	1.50 V	177	52.7	14.1
4	11650.00	53.5 AV	54.0	-0.5	1.50 V	177	39.4	14.1
5	#17475.00	63.0 PK	74.0	-11.0	1.75 V	171	43.3	19.7
6	#17475.00	50.3 AV	54.0	-3.7	1.75 V	171	30.6	19.7

**REMARKS:**

1. Emission Level(dBuV/m) = Raw Value(dBuV) + Correction Factor(dB/m)
2. Correction Factor(dB/m) = Antenna Factor(dB/m) + Cable Factor(dB) – Pre-Amplifier Factor(dB)
3. The other emission levels were very low against the limit.
4. Margin value = Emission Level – Limit value
5. " \* ": Fundamental frequency.
6. " # ": The radiated frequency is out of the restricted band.

802.11ac (VHT20)

<b>CHANNEL</b>	TX Channel 36	<b>DETECTOR FUNCTION</b>	Peak (PK)
<b>FREQUENCY RANGE</b>	1GHz ~ 40GHz		Average (AV)

ANTENNA POLARITY & TEST DISTANCE: HORIZONTAL AT 3 M								
NO.	FREQ. (MHz)	EMISSION LEVEL (dBuV/m)	LIMIT (dBuV/m)	MARGIN (dB)	ANTENNA HEIGHT (m)	TABLE ANGLE (Degree)	RAW VALUE (dBuV)	CORRECTION FACTOR (dB/m)
1	5150.00	54.4 PK	74.0	-19.6	1.55 H	357	50.4	4.0
2	5150.00	38.1 AV	54.0	-15.9	1.55 H	357	34.1	4.0
3	*5180.00	107.9 PK			1.55 H	357	103.9	4.0
4	*5180.00	98.1 AV			1.55 H	357	94.1	4.0
5	#10360.00	65.8 PK	74.0	-8.2	1.87 H	271	52.2	13.6
6	#10360.00	53.3 AV	54.0	-0.7	1.87 H	271	39.7	13.6
7	15540.00	45.5 PK	74.0	-28.5	1.65 H	351	32.3	13.2
8	15540.00	34.8 AV	54.0	-19.2	1.65 H	351	21.6	13.2

ANTENNA POLARITY & TEST DISTANCE: VERTICAL AT 3 M								
NO.	FREQ. (MHz)	EMISSION LEVEL (dBuV/m)	LIMIT (dBuV/m)	MARGIN (dB)	ANTENNA HEIGHT (m)	TABLE ANGLE (Degree)	RAW VALUE (dBuV)	CORRECTION FACTOR (dB/m)
1	5150.00	58.6 PK	74.0	-15.4	1.50 V	219	54.6	4.0
2	5150.00	44.2 AV	54.0	-9.8	1.50 V	219	40.2	4.0
3	*5180.00	114.0 PK			1.50 V	219	110.0	4.0
4	*5180.00	103.7 AV			1.50 V	219	99.7	4.0
5	#10360.00	69.0 PK	74.0	-5.0	1.00 V	49	55.4	13.6
<b>6</b>	<b>#10360.00</b>	<b>53.9 AV</b>	<b>54.0</b>	<b>-0.1</b>	<b>1.00 V</b>	<b>49</b>	<b>40.3</b>	<b>13.6</b>
7	15540.00	49.3 PK	74.0	-24.7	3.14 V	253	36.1	13.2
8	15540.00	37.3 AV	54.0	-16.7	3.14 V	253	24.1	13.2

**REMARKS:**

- Emission Level(dBuV/m) = Raw Value(dBuV) + Correction Factor(dB/m)
- Correction Factor(dB/m) = Antenna Factor(dB/m) + Cable Factor(dB) – Pre-Amplifier Factor(dB)
- The other emission levels were very low against the limit.
- Margin value = Emission Level – Limit value
- " \* ": Fundamental frequency.
- " # ": The radiated frequency is out of the restricted band.

<b>CHANNEL</b>	TX Channel 40	<b>DETECTOR FUNCTION</b>	Peak (PK)
<b>FREQUENCY RANGE</b>	1GHz ~ 40GHz		Average (AV)

**ANTENNA POLARITY & TEST DISTANCE: HORIZONTAL AT 3 M**

NO.	FREQ. (MHz)	EMISSION LEVEL (dBuV/m)	LIMIT (dBuV/m)	MARGIN (dB)	ANTENNA HEIGHT (m)	TABLE ANGLE (Degree)	RAW VALUE (dBuV)	CORRECTION FACTOR (dB/m)
1	5150.00	50.0 PK	74.0	-24.0	1.52 H	360	46.0	4.0
2	5150.00	37.5 AV	54.0	-16.5	1.52 H	360	33.5	4.0
3	*5200.00	109.0 PK			1.52 H	360	105.0	4.0
4	*5200.00	100.0 AV			1.52 H	360	96.0	4.0
5	5439.90	52.3 PK	74.0	-21.7	1.52 H	360	47.8	4.5
6	5439.90	39.7 AV	54.0	-14.3	1.52 H	360	35.2	4.5
7	#10400.00	64.3 PK	74.0	-9.7	1.83 H	203	50.7	13.6
8	#10400.00	50.4 AV	54.0	-3.6	1.83 H	203	36.8	13.6
9	15600.00	46.2 PK	74.0	-27.8	1.60 H	353	32.8	13.4
10	15600.00	35.1 AV	54.0	-18.9	1.60 H	353	21.7	13.4

**ANTENNA POLARITY & TEST DISTANCE: VERTICAL AT 3 M**

NO.	FREQ. (MHz)	EMISSION LEVEL (dBuV/m)	LIMIT (dBuV/m)	MARGIN (dB)	ANTENNA HEIGHT (m)	TABLE ANGLE (Degree)	RAW VALUE (dBuV)	CORRECTION FACTOR (dB/m)
1	5150.00	54.2 PK	74.0	-19.8	2.21 V	328	50.2	4.0
2	5150.00	43.6 AV	54.0	-10.4	2.21 V	328	39.6	4.0
3	*5200.00	115.1 PK			2.21 V	328	111.1	4.0
4	*5200.00	105.6 AV			2.21 V	328	101.6	4.0
5	5439.90	56.5 PK	74.0	-17.5	2.21 V	328	52.0	4.5
6	5439.90	45.9 AV	54.0	-8.1	2.21 V	328	41.4	4.5
7	#10400.00	68.7 PK	74.0	-5.3	2.00 V	54	55.1	13.6
8	#10400.00	53.6 AV	54.0	-0.4	2.00 V	54	40.0	13.6
9	15600.00	49.2 PK	74.0	-24.8	3.16 V	259	35.8	13.4
10	15600.00	37.4 AV	54.0	-16.6	3.16 V	259	24.0	13.4

**REMARKS:**

1. Emission Level(dBuV/m) = Raw Value(dBuV) + Correction Factor(dB/m)
2. Correction Factor(dB/m) = Antenna Factor(dB/m) + Cable Factor(dB) – Pre-Amplifier Factor(dB)
3. The other emission levels were very low against the limit.
4. Margin value = Emission Level – Limit value
5. " \* ": Fundamental frequency.
6. " # ": The radiated frequency is out of the restricted band.

<b>CHANNEL</b>	TX Channel 48	<b>DETECTOR FUNCTION</b>	Peak (PK)
<b>FREQUENCY RANGE</b>	1GHz ~ 40GHz		Average (AV)

**ANTENNA POLARITY & TEST DISTANCE: HORIZONTAL AT 3 M**

NO.	FREQ. (MHz)	EMISSION LEVEL (dBuV/m)	LIMIT (dBuV/m)	MARGIN (dB)	ANTENNA HEIGHT (m)	TABLE ANGLE (Degree)	RAW VALUE (dBuV)	CORRECTION FACTOR (dB/m)
1	*5240.00	108.9 PK			1.48 H	354	104.7	4.2
2	*5240.00	100.1 AV			1.48 H	354	95.9	4.2
3	5350.00	52.3 PK	74.0	-21.7	1.48 H	354	47.9	4.4
4	5350.00	38.4 AV	54.0	-15.6	1.48 H	354	34.0	4.4
5	#10480.00	64.2 PK	74.0	-9.8	1.80 H	208	50.5	13.7
6	#10480.00	50.7 AV	54.0	-3.3	1.80 H	208	37.0	13.7
7	15720.00	45.3 PK	74.0	-28.7	1.60 H	351	31.3	14.0
8	15720.00	34.4 AV	54.0	-19.6	1.60 H	351	20.4	14.0

**ANTENNA POLARITY & TEST DISTANCE: VERTICAL AT 3 M**

NO.	FREQ. (MHz)	EMISSION LEVEL (dBuV/m)	LIMIT (dBuV/m)	MARGIN (dB)	ANTENNA HEIGHT (m)	TABLE ANGLE (Degree)	RAW VALUE (dBuV)	CORRECTION FACTOR (dB/m)
1	*5240.00	115.0 PK			2.49 V	325	110.8	4.2
2	*5240.00	105.7 AV			2.49 V	325	101.5	4.2
3	5350.00	56.5 PK	74.0	-17.5	2.49 V	325	52.1	4.4
4	5350.00	44.5 AV	54.0	-9.5	2.49 V	325	40.1	4.4
5	#10480.00	71.0 PK	74.0	-3.0	1.00 V	277	57.3	13.7
<b>6</b>	<b>#10480.00</b>	<b>53.9 AV</b>	<b>54.0</b>	<b>-0.1</b>	<b>1.00 V</b>	<b>277</b>	<b>40.2</b>	<b>13.7</b>
7	15720.00	49.0 PK	74.0	-25.0	3.09 V	265	35.0	14.0
8	15720.00	36.9 AV	54.0	-17.1	3.09 V	265	22.9	14.0

**REMARKS:**

1. Emission Level(dBuV/m) = Raw Value(dBuV) + Correction Factor(dB/m)
2. Correction Factor(dB/m) = Antenna Factor(dB/m) + Cable Factor(dB) – Pre-Amplifier Factor(dB)
3. The other emission levels were very low against the limit.
4. Margin value = Emission Level – Limit value
5. " \* ": Fundamental frequency.
6. " # ": The radiated frequency is out of the restricted band.

<b>CHANNEL</b>	TX Channel 149	<b>DETECTOR FUNCTION</b>	Peak (PK)
<b>FREQUENCY RANGE</b>	1GHz ~ 40GHz		Average (AV)

**ANTENNA POLARITY & TEST DISTANCE: HORIZONTAL AT 3 M**

NO.	FREQ. (MHz)	EMISSION LEVEL (dBuV/m)	LIMIT (dBuV/m)	MARGIN (dB)	ANTENNA HEIGHT (m)	TABLE ANGLE (Degree)	RAW VALUE (dBuV)	CORRECTION FACTOR (dB/m)
1	*5745.00	115.4 PK			1.16 H	360	110.4	5.0
2	*5745.00	104.5 AV			1.16 H	360	99.5	5.0
3	11490.00	57.8 PK	74.0	-16.2	1.24 H	185	43.7	14.1
4	11490.00	46.0 AV	54.0	-8.0	1.24 H	185	31.9	14.1
5	#17235.00	58.6 PK	74.0	-15.4	1.82 H	82	40.3	18.3
6	#17235.00	45.4 AV	54.0	-8.6	1.82 H	82	27.1	18.3

**ANTENNA POLARITY & TEST DISTANCE: VERTICAL AT 3 M**

NO.	FREQ. (MHz)	EMISSION LEVEL (dBuV/m)	LIMIT (dBuV/m)	MARGIN (dB)	ANTENNA HEIGHT (m)	TABLE ANGLE (Degree)	RAW VALUE (dBuV)	CORRECTION FACTOR (dB/m)
1	*5745.00	120.8 PK			2.30 V	322	115.8	5.0
2	*5745.00	110.3 AV			2.30 V	322	105.3	5.0
3	11490.00	63.4 PK	74.0	-10.6	1.84 V	148	49.3	14.1
4	11490.00	50.1 AV	54.0	-3.9	1.84 V	148	36.0	14.1
5	#17235.00	59.3 PK	74.0	-14.7	1.79 V	175	41.0	18.3
6	#17235.00	45.9 AV	54.0	-8.1	1.79 V	175	27.6	18.3

**REMARKS:**

1. Emission Level(dBuV/m) = Raw Value(dBuV) + Correction Factor(dB/m)
2. Correction Factor(dB/m) = Antenna Factor(dB/m) + Cable Factor(dB) – Pre-Amplifier Factor(dB)
3. The other emission levels were very low against the limit.
4. Margin value = Emission Level – Limit value
5. " \* ": Fundamental frequency.
6. " # ": The radiated frequency is out of the restricted band.



<b>CHANNEL</b>	TX Channel 157	<b>DETECTOR FUNCTION</b>	Peak (PK)
<b>FREQUENCY RANGE</b>	1GHz ~ 40GHz		Average (AV)

**ANTENNA POLARITY & TEST DISTANCE: HORIZONTAL AT 3 M**

NO.	FREQ. (MHz)	EMISSION LEVEL (dBuV/m)	LIMIT (dBuV/m)	MARGIN (dB)	ANTENNA HEIGHT (m)	TABLE ANGLE (Degree)	RAW VALUE (dBuV)	CORRECTION FACTOR (dB/m)
1	*5785.00	115.0 PK			1.19 H	354	110.0	5.0
2	*5785.00	104.1 AV			1.19 H	354	99.1	5.0
3	11570.00	58.2 PK	74.0	-15.8	1.22 H	206	44.2	14.0
4	11570.00	46.2 AV	54.0	-7.8	1.22 H	206	32.2	14.0
5	#17355.00	58.3 PK	74.0	-15.7	1.74 H	107	39.4	18.9
6	#17355.00	45.2 AV	54.0	-8.8	1.74 H	107	26.3	18.9

**ANTENNA POLARITY & TEST DISTANCE: VERTICAL AT 3 M**

NO.	FREQ. (MHz)	EMISSION LEVEL (dBuV/m)	LIMIT (dBuV/m)	MARGIN (dB)	ANTENNA HEIGHT (m)	TABLE ANGLE (Degree)	RAW VALUE (dBuV)	CORRECTION FACTOR (dB/m)
1	*5785.00	120.1 PK			2.34 V	325	115.1	5.0
2	*5785.00	110.0 AV			2.34 V	325	105.0	5.0
3	11570.00	64.8 PK	74.0	-9.2	1.45 V	188	50.8	14.0
4	11570.00	51.5 AV	54.0	-2.5	1.45 V	188	37.5	14.0
5	#17355.00	59.3 PK	74.0	-14.7	1.74 V	160	40.4	18.9
6	#17355.00	46.1 AV	54.0	-7.9	1.74 V	160	27.2	18.9

**REMARKS:**

1. Emission Level(dBuV/m) = Raw Value(dBuV) + Correction Factor(dB/m)
2. Correction Factor(dB/m) = Antenna Factor(dB/m) + Cable Factor(dB) – Pre-Amplifier Factor(dB)
3. The other emission levels were very low against the limit.
4. Margin value = Emission Level – Limit value
5. " \* ": Fundamental frequency.
6. " # ": The radiated frequency is out of the restricted band.

<b>CHANNEL</b>	TX Channel 165	<b>DETECTOR FUNCTION</b>	Peak (PK)
<b>FREQUENCY RANGE</b>	1GHz ~ 40GHz		Average (AV)

**ANTENNA POLARITY & TEST DISTANCE: HORIZONTAL AT 3 M**

NO.	FREQ. (MHz)	EMISSION LEVEL (dBuV/m)	LIMIT (dBuV/m)	MARGIN (dB)	ANTENNA HEIGHT (m)	TABLE ANGLE (Degree)	RAW VALUE (dBuV)	CORRECTION FACTOR (dB/m)
1	*5825.00	114.8 PK			1.16 H	349	109.6	5.2
2	*5825.00	104.1 AV			1.16 H	349	98.9	5.2
3	11650.00	58.9 PK	74.0	-15.1	1.23 H	206	44.8	14.1
4	11650.00	46.8 AV	54.0	-7.2	1.23 H	206	32.7	14.1
5	#17475.00	57.8 PK	74.0	-16.2	1.83 H	83	38.1	19.7
6	#17475.00	45.1 AV	54.0	-8.9	1.83 H	83	25.4	19.7

**ANTENNA POLARITY & TEST DISTANCE: VERTICAL AT 3 M**

NO.	FREQ. (MHz)	EMISSION LEVEL (dBuV/m)	LIMIT (dBuV/m)	MARGIN (dB)	ANTENNA HEIGHT (m)	TABLE ANGLE (Degree)	RAW VALUE (dBuV)	CORRECTION FACTOR (dB/m)
1	*5825.00	120.3 PK			2.29 V	334	115.1	5.2
2	*5825.00	110.8 AV			2.29 V	334	105.6	5.2
3	11650.00	65.3 PK	74.0	-8.7	1.50 V	180	51.2	14.1
4	11650.00	51.8 AV	54.0	-2.2	1.50 V	180	37.7	14.1
5	#17475.00	58.6 PK	74.0	-15.4	1.80 V	160	38.9	19.7
6	#17475.00	45.6 AV	54.0	-8.4	1.80 V	160	25.9	19.7

**REMARKS:**

- Emission Level(dBuV/m) = Raw Value(dBuV) + Correction Factor(dB/m)
- Correction Factor(dB/m) = Antenna Factor(dB/m) + Cable Factor(dB) – Pre-Amplifier Factor(dB)
- The other emission levels were very low against the limit.
- Margin value = Emission Level – Limit value
- " \* ": Fundamental frequency.
- " # ": The radiated frequency is out of the restricted band.

**802.11ac (VHT40)**

<b>CHANNEL</b>	TX Channel 38	<b>DETECTOR FUNCTION</b>	Peak (PK)
<b>FREQUENCY RANGE</b>	1GHz ~ 40GHz		Average (AV)

**ANTENNA POLARITY & TEST DISTANCE: HORIZONTAL AT 3 M**

NO.	FREQ. (MHz)	EMISSION LEVEL (dBuV/m)	LIMIT (dBuV/m)	MARGIN (dB)	ANTENNA HEIGHT (m)	TABLE ANGLE (Degree)	RAW VALUE (dBuV)	CORRECTION FACTOR (dB/m)
1	5147.60	64.0 PK	74.0	-10.0	1.11 H	351	60.0	4.0
2	5147.60	47.8 AV	54.0	-6.2	1.11 H	351	43.8	4.0
3	*5190.00	104.3 PK			1.11 H	351	100.3	4.0
4	*5190.00	95.3 AV			1.11 H	351	91.3	4.0
5	5350.00	49.9 PK	74.0	-24.1	1.11 H	351	45.5	4.4
6	5350.00	37.4 AV	54.0	-16.6	1.11 H	351	33.0	4.4
7	#6920.00	51.9 PK	74.0	-22.1	1.11 H	351	43.3	8.6
8	#6920.00	45.5 AV	54.0	-8.5	1.11 H	351	36.9	8.6
9	#10380.00	62.1 PK	74.0	-11.9	1.83 H	213	48.5	13.6
10	#10380.00	47.6 AV	54.0	-6.4	1.83 H	213	34.0	13.6
11	15570.00	46.9 PK	74.0	-27.1	1.65 H	354	33.6	13.3
12	15570.00	35.6 AV	54.0	-18.4	1.65 H	354	22.3	13.3

**ANTENNA POLARITY & TEST DISTANCE: VERTICAL AT 3 M**

NO.	FREQ. (MHz)	EMISSION LEVEL (dBuV/m)	LIMIT (dBuV/m)	MARGIN (dB)	ANTENNA HEIGHT (m)	TABLE ANGLE (Degree)	RAW VALUE (dBuV)	CORRECTION FACTOR (dB/m)
1	5147.60	68.2 PK	74.0	-5.8	1.50 V	217	64.2	4.0
2	5147.60	53.9 AV	54.0	-0.1	1.50 V	217	49.9	4.0
3	*5190.00	110.4 PK			1.50 V	217	106.4	4.0
4	*5190.00	100.9 AV			1.50 V	217	96.9	4.0
5	5350.00	54.0 PK	74.0	-20.0	1.50 V	217	49.6	4.4
6	5350.00	41.7 AV	54.0	-12.3	1.50 V	217	37.3	4.4
7	#6920.00	56.1 PK	74.0	-17.9	2.50 V	287	47.5	8.6
8	#6920.00	51.1 AV	54.0	-2.9	2.50 V	287	42.5	8.6
9	#10380.00	66.4 PK	74.0	-7.6	3.97 V	357	52.8	13.6
10	#10380.00	51.4 AV	54.0	-2.6	3.97 V	357	37.8	13.6
11	15570.00	49.5 PK	74.0	-24.5	3.11 V	258	36.2	13.3
12	15570.00	37.6 AV	54.0	-16.4	3.11 V	258	24.3	13.3

**REMARKS:**

1. Emission Level(dBuV/m) = Raw Value(dBuV) + Correction Factor(dB/m)
2. Correction Factor(dB/m) = Antenna Factor(dB/m) + Cable Factor(dB) – Pre-Amplifier Factor(dB)
3. The other emission levels were very low against the limit.
4. Margin value = Emission Level – Limit value
5. " \* ": Fundamental frequency.
6. " # ": The radiated frequency is out of the restricted band.

<b>CHANNEL</b>	TX Channel 46	<b>DETECTOR FUNCTION</b>	Peak (PK)
<b>FREQUENCY RANGE</b>	1GHz ~ 40GHz		Average (AV)

**ANTENNA POLARITY & TEST DISTANCE: HORIZONTAL AT 3 M**

NO.	FREQ. (MHz)	EMISSION LEVEL (dBuV/m)	LIMIT (dBuV/m)	MARGIN (dB)	ANTENNA HEIGHT (m)	TABLE ANGLE (Degree)	RAW VALUE (dBuV)	CORRECTION FACTOR (dB/m)
1	5150.00	51.6 PK	74.0	-22.4	1.25 H	343	47.6	4.0
2	5150.00	37.8 AV	54.0	-16.2	1.25 H	343	33.8	4.0
3	*5230.00	105.2 PK			1.25 H	343	101.0	4.2
4	*5230.00	96.2 AV			1.25 H	343	92.0	4.2
5	5350.00	48.9 PK	74.0	-25.1	1.25 H	343	44.5	4.4
6	5350.00	37.6 AV	54.0	-16.4	1.25 H	343	33.2	4.4
7	#10460.00	64.0 PK	74.0	-10.0	1.84 H	198	50.3	13.7
8	#10460.00	49.9 AV	54.0	-4.1	1.84 H	198	36.2	13.7
9	15690.00	46.4 PK	74.0	-27.6	1.59 H	360	32.4	14.0
10	15690.00	35.2 AV	54.0	-18.8	1.59 H	360	21.2	14.0

**ANTENNA POLARITY & TEST DISTANCE: VERTICAL AT 3 M**

NO.	FREQ. (MHz)	EMISSION LEVEL (dBuV/m)	LIMIT (dBuV/m)	MARGIN (dB)	ANTENNA HEIGHT (m)	TABLE ANGLE (Degree)	RAW VALUE (dBuV)	CORRECTION FACTOR (dB/m)
1	5150.00	55.7 PK	74.0	-18.3	2.62 V	321	51.7	4.0
2	5150.00	41.4 AV	54.0	-12.6	2.62 V	321	37.4	4.0
3	*5230.00	111.3 PK			2.62 V	321	107.1	4.2
4	*5230.00	101.8 AV			2.62 V	321	97.6	4.2
5	5350.00	53.0 PK	74.0	-21.0	2.62 V	321	48.6	4.4
6	5350.00	41.3 AV	54.0	-12.7	2.62 V	321	36.9	4.4
7	#10460.00	68.7 PK	74.0	-5.3	3.90 V	357	55.0	13.7
8	#10460.00	53.2 AV	54.0	-0.8	3.90 V	357	39.5	13.7
9	15690.00	48.9 PK	74.0	-25.1	3.12 V	248	34.9	14.0
10	15690.00	37.0 AV	54.0	-17.0	3.12 V	248	23.0	14.0

**REMARKS:**

1. Emission Level(dBuV/m) = Raw Value(dBuV) + Correction Factor(dB/m)
2. Correction Factor(dB/m) = Antenna Factor(dB/m) + Cable Factor(dB) – Pre-Amplifier Factor(dB)
3. The other emission levels were very low against the limit.
4. Margin value = Emission Level – Limit value
5. " \* ": Fundamental frequency.
6. " # ": The radiated frequency is out of the restricted band.

<b>CHANNEL</b>	TX Channel 151	<b>DETECTOR FUNCTION</b>	Peak (PK)
<b>FREQUENCY RANGE</b>	1GHz ~ 40GHz		Average (AV)

**ANTENNA POLARITY & TEST DISTANCE: HORIZONTAL AT 3 M**

NO.	FREQ. (MHz)	EMISSION LEVEL (dBuV/m)	LIMIT (dBuV/m)	MARGIN (dB)	ANTENNA HEIGHT (m)	TABLE ANGLE (Degree)	RAW VALUE (dBuV)	CORRECTION FACTOR (dB/m)
1	*5755.00	111.0 PK			1.27 H	20	106.0	5.0
2	*5755.00	101.1 AV			1.27 H	20	96.1	5.0
3	11510.00	58.1 PK	74.0	-15.9	1.24 H	219	44.1	14.0
4	11510.00	46.4 AV	54.0	-7.6	1.24 H	219	32.4	14.0
5	#17265.00	57.6 PK	74.0	-16.4	1.74 H	112	39.1	18.5
6	#17265.00	44.3 AV	54.0	-9.7	1.74 H	112	25.8	18.5

**ANTENNA POLARITY & TEST DISTANCE: VERTICAL AT 3 M**

NO.	FREQ. (MHz)	EMISSION LEVEL (dBuV/m)	LIMIT (dBuV/m)	MARGIN (dB)	ANTENNA HEIGHT (m)	TABLE ANGLE (Degree)	RAW VALUE (dBuV)	CORRECTION FACTOR (dB/m)
1	*5755.00	117.5 PK			2.11 V	325	112.5	5.0
2	*5755.00	108.0 AV			2.11 V	325	103.0	5.0
3	11510.00	59.1 PK	74.0	-14.9	1.16 V	113	45.1	14.0
4	11510.00	49.2 AV	54.0	-4.8	1.16 V	113	35.2	14.0
5	#17265.00	58.9 PK	74.0	-15.1	1.79 V	186	40.4	18.5
6	#17265.00	45.7 AV	54.0	-8.3	1.79 V	186	27.2	18.5

**REMARKS:**

1. Emission Level(dBuV/m) = Raw Value(dBuV) + Correction Factor(dB/m)
2. Correction Factor(dB/m) = Antenna Factor(dB/m) + Cable Factor(dB) – Pre-Amplifier Factor(dB)
3. The other emission levels were very low against the limit.
4. Margin value = Emission Level – Limit value
5. " \* ": Fundamental frequency.
6. " # ": The radiated frequency is out of the restricted band.

<b>CHANNEL</b>	TX Channel 159	<b>DETECTOR FUNCTION</b>	Peak (PK)
<b>FREQUENCY RANGE</b>	1GHz ~ 40GHz		Average (AV)

**ANTENNA POLARITY & TEST DISTANCE: HORIZONTAL AT 3 M**

NO.	FREQ. (MHz)	EMISSION LEVEL (dBuV/m)	LIMIT (dBuV/m)	MARGIN (dB)	ANTENNA HEIGHT (m)	TABLE ANGLE (Degree)	RAW VALUE (dBuV)	CORRECTION FACTOR (dB/m)
1	*5795.00	110.4 PK			1.25 H	21	105.3	5.1
2	*5795.00	100.0 AV			1.25 H	21	94.9	5.1
3	11590.00	58.3 PK	74.0	-15.7	1.25 H	212	44.3	14.0
4	11590.00	46.1 AV	54.0	-7.9	1.25 H	212	32.1	14.0
5	#17385.00	59.1 PK	74.0	-14.9	1.77 H	107	40.0	19.1
6	#17385.00	45.1 AV	54.0	-8.9	1.77 H	107	26.0	19.1

**ANTENNA POLARITY & TEST DISTANCE: VERTICAL AT 3 M**

NO.	FREQ. (MHz)	EMISSION LEVEL (dBuV/m)	LIMIT (dBuV/m)	MARGIN (dB)	ANTENNA HEIGHT (m)	TABLE ANGLE (Degree)	RAW VALUE (dBuV)	CORRECTION FACTOR (dB/m)
1	*5795.00	117.4 PK			2.08 V	331	112.3	5.1
2	*5795.00	107.9 AV			2.08 V	331	102.8	5.1
3	11590.00	63.1 PK	74.0	-10.9	1.05 V	233	49.1	14.0
4	11590.00	51.0 AV	54.0	-3.0	1.05 V	233	37.0	14.0
5	#17385.00	59.6 PK	74.0	-14.4	1.73 V	189	40.5	19.1
6	#17385.00	46.2 AV	54.0	-7.8	1.73 V	189	27.1	19.1

**REMARKS:**

1. Emission Level(dBuV/m) = Raw Value(dBuV) + Correction Factor(dB/m)
2. Correction Factor(dB/m) = Antenna Factor(dB/m) + Cable Factor(dB) – Pre-Amplifier Factor(dB)
3. The other emission levels were very low against the limit.
4. Margin value = Emission Level – Limit value
5. " \* ": Fundamental frequency.
6. " # ": The radiated frequency is out of the restricted band.

**802.11ac (VHT80)**

<b>CHANNEL</b>	TX Channel 42	<b>DETECTOR FUNCTION</b>	Peak (PK)
<b>FREQUENCY RANGE</b>	1GHz ~ 40GHz		Average (AV)

**ANTENNA POLARITY & TEST DISTANCE: HORIZONTAL AT 3 M**

NO.	FREQ. (MHz)	EMISSION LEVEL (dBuV/m)	LIMIT (dBuV/m)	MARGIN (dB)	ANTENNA HEIGHT (m)	TABLE ANGLE (Degree)	RAW VALUE (dBuV)	CORRECTION FACTOR (dB/m)
1	5147.70	59.5 PK	74.0	-14.5	1.25 H	320	55.5	4.0
2	5147.70	47.4 AV	54.0	-6.6	1.25 H	320	43.4	4.0
3	*5210.00	98.6 PK			1.25 H	320	94.5	4.1
4	*5210.00	90.2 AV			1.25 H	320	86.1	4.1
5	5350.00	49.3 PK	74.0	-24.7	1.25 H	320	44.9	4.4
6	5350.00	37.3 AV	54.0	-16.7	1.25 H	320	32.9	4.4
7	#10420.00	62.2 PK	74.0	-11.8	1.76 H	209	48.6	13.6
8	#10420.00	47.5 AV	54.0	-6.5	1.76 H	209	33.9	13.6
9	15630.00	47.9 PK	74.0	-26.1	1.66 H	342	34.3	13.6
10	15630.00	36.5 AV	54.0	-17.5	1.66 H	342	22.9	13.6

**ANTENNA POLARITY & TEST DISTANCE: VERTICAL AT 3 M**

NO.	FREQ. (MHz)	EMISSION LEVEL (dBuV/m)	LIMIT (dBuV/m)	MARGIN (dB)	ANTENNA HEIGHT (m)	TABLE ANGLE (Degree)	RAW VALUE (dBuV)	CORRECTION FACTOR (dB/m)
1	5147.70	63.7 PK	74.0	-10.3	2.26 V	327	59.7	4.0
2	5147.70	53.6 AV	54.0	-0.4	2.26 V	327	49.6	4.0
3	*5210.00	104.7 PK			2.26 V	327	100.6	4.1
4	*5210.00	95.8 AV			2.26 V	327	91.7	4.1
5	5350.00	53.5 PK	74.0	-20.5	2.26 V	327	49.1	4.4
6	5350.00	42.1 AV	54.0	-11.9	2.26 V	327	37.7	4.4
7	#10420.00	63.4 PK	74.0	-10.6	1.50 V	26	49.8	13.6
8	#10420.00	48.9 AV	54.0	-5.1	1.50 V	26	35.3	13.6
9	15630.00	49.1 PK	74.0	-24.9	3.16 V	247	35.5	13.6
10	15630.00	36.7 AV	54.0	-17.3	3.16 V	247	23.1	13.6

**REMARKS:**

1. Emission Level(dBuV/m) = Raw Value(dBuV) + Correction Factor(dB/m)
2. Correction Factor(dB/m) = Antenna Factor(dB/m) + Cable Factor(dB) – Pre-Amplifier Factor(dB)
3. The other emission levels were very low against the limit.
4. Margin value = Emission Level – Limit value
5. " \* ": Fundamental frequency.
6. " # ": The radiated frequency is out of the restricted band.

<b>CHANNEL</b>	TX Channel 155	<b>DETECTOR FUNCTION</b>	Peak (PK)
<b>FREQUENCY RANGE</b>	1GHz ~ 40GHz		Average (AV)

**ANTENNA POLARITY & TEST DISTANCE: HORIZONTAL AT 3 M**

NO.	FREQ. (MHz)	EMISSION LEVEL (dBuV/m)	LIMIT (dBuV/m)	MARGIN (dB)	ANTENNA HEIGHT (m)	TABLE ANGLE (Degree)	RAW VALUE (dBuV)	CORRECTION FACTOR (dB/m)
1	*5775.00	106.8 PK			1.02 H	18	101.8	5.0
2	*5775.00	98.1 AV			1.02 H	18	93.1	5.0
3	11550.00	53.1 PK	74.0	-20.9	1.83 H	212	39.1	14.0
4	11550.00	41.4 AV	54.0	-12.6	1.83 H	212	27.4	14.0
5	#17325.00	47.4 PK	74.0	-26.6	1.63 H	356	28.8	18.6
6	#17325.00	36.4 AV	54.0	-17.6	1.63 H	356	17.8	18.6

**ANTENNA POLARITY & TEST DISTANCE: VERTICAL AT 3 M**

NO.	FREQ. (MHz)	EMISSION LEVEL (dBuV/m)	LIMIT (dBuV/m)	MARGIN (dB)	ANTENNA HEIGHT (m)	TABLE ANGLE (Degree)	RAW VALUE (dBuV)	CORRECTION FACTOR (dB/m)
1	*5775.00	113.7 PK			2.34 V	153	108.7	5.0
2	*5775.00	103.9 AV			2.34 V	153	98.9	5.0
3	11550.00	55.3 PK	74.0	-18.7	1.35 V	133	41.3	14.0
4	11550.00	43.6 AV	54.0	-10.4	1.35 V	133	29.6	14.0
5	#17325.00	49.6 PK	74.0	-24.4	3.17 V	242	31.0	18.6
6	#17325.00	37.2 AV	54.0	-16.8	3.17 V	242	18.6	18.6

**REMARKS:**

1. Emission Level(dBuV/m) = Raw Value(dBuV) + Correction Factor(dB/m)
2. Correction Factor(dB/m) = Antenna Factor(dB/m) + Cable Factor(dB) – Pre-Amplifier Factor(dB)
3. The other emission levels were very low against the limit.
4. Margin value = Emission Level – Limit value
5. " \* ": Fundamental frequency.
6. " # ": The radiated frequency is out of the restricted band.



### Below 1GHz Data:

#### 802.11ac (VHT40)

<b>CHANNEL</b>	TX Channel 151	<b>DETECTOR FUNCTION</b>	Quasi-Peak (QP)
<b>FREQUENCY RANGE</b>	9kHz ~ 1GHz		

#### ANTENNA POLARITY & TEST DISTANCE: HORIZONTAL AT 3 M

NO.	FREQ. (MHz)	EMISSION LEVEL (dBuV/m)	LIMIT (dBuV/m)	MARGIN (dB)	ANTENNA HEIGHT (m)	TABLE ANGLE (Degree)	RAW VALUE (dBuV)	CORRECTION FACTOR (dB/m)
1	250.00	43.9 QP	46.0	-2.1	1.00 H	224	53.1	-9.2
2	400.03	39.3 QP	46.0	-6.7	1.00 H	118	44.3	-5.0
3	574.99	40.9 QP	46.0	-5.1	1.50 H	119	42.0	-1.1
4	625.00	40.6 QP	46.0	-5.4	1.00 H	241	40.4	0.2
5	724.98	37.6 QP	46.0	-8.4	1.50 H	278	36.4	1.2
6	874.99	37.4 QP	46.0	-8.6	1.00 H	150	33.6	3.8

#### REMARKS:

1. Emission Level(dBuV/m) = Raw Value(dBuV) + Correction Factor(dB/m)
2. Correction Factor(dB/m) = Antenna Factor(dB/m) + Cable Factor(dB) – Pre-Amplifier Factor(dB)
3. The other emission levels were very low against the limit.
4. Margin value = Emission Level – Limit value

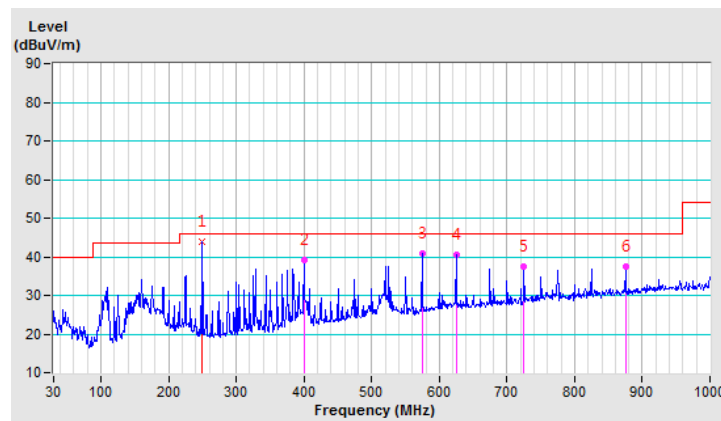

<b>CHANNEL</b>	TX Channel 151	<b>DETECTOR FUNCTION</b>	Quasi-Peak (QP)
<b>FREQUENCY RANGE</b>	9kHz ~ 1GHz		

**ANTENNA POLARITY & TEST DISTANCE: VERTICAL AT 3 M**

NO.	FREQ. (MHz)	EMISSION LEVEL (dBuV/m)	LIMIT (dBuV/m)	MARGIN (dB)	ANTENNA HEIGHT (m)	TABLE ANGLE (Degree)	RAW VALUE (dBuV)	CORRECTION FACTOR (dB/m)
1	47.82	35.5 QP	40.0	-4.5	1.00 V	249	43.3	-7.8
2	250.00	40.4 QP	46.0	-5.6	1.50 V	173	49.6	-9.2
3	400.01	35.3 QP	46.0	-10.7	1.50 V	224	40.3	-5.0
4	574.99	38.7 QP	46.0	-7.3	1.50 V	249	39.8	-1.1
5	725.00	37.1 QP	46.0	-8.9	1.50 V	360	35.9	1.2
6	924.99	36.9 QP	46.0	-9.1	1.00 V	244	32.4	4.5

**REMARKS:**

1. Emission Level(dBuV/m) = Raw Value(dBuV) + Correction Factor(dB/m)
2. Correction Factor(dB/m) = Antenna Factor(dB/m) + Cable Factor(dB) – Pre-Amplifier Factor(dB)
3. The other emission levels were very low against the limit.
4. Margin value = Emission Level – Limit value

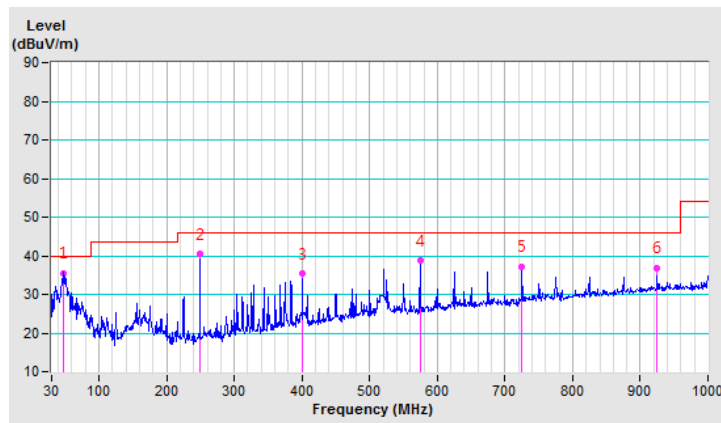

## 4.2 Conducted Emission Measurement

### 4.2.1 Limits of Conducted Emission Measurement

Frequency (MHz)	Conducted Limit (dBuV)	
	Quasi-peak	Average
0.15 - 0.5	66 - 56	56 - 46
0.50 - 5.0	56	46
5.0 - 30.0	60	50

Note: 1. The lower limit shall apply at the transition frequencies.

2. The limit decreases in line with the logarithm of the frequency in the range of 0.15 to 0.50MHz.

### 4.2.2 Test Instruments

DESCRIPTION & MANUFACTURER	MODEL NO.	SERIAL NO.	CALIBRATED DATE	CALIBRATED UNTIL
Test Receiver R&S	ESCS 30	847124/029	Nov. 01, 2017	Oct. 31, 2018
Line-Impedance Stabilization Network (for EUT) R&S	ESH3-Z5	848773/004	Nov. 15, 20167	Nov. 14, 2018
Line-Impedance Stabilization Network (for Peripheral) R&S	ENV216	100072	June 03, 2017	June 02, 2018
50 ohms Terminator	N/A	EMC-02	Sep. 22, 2017	Sep. 21, 2018
RF Cable	5D-FB	COCCAB-001	Sep. 29, 2017	Sep. 28, 2018
10 dB PAD Mini-Circuits	HAT-10+	CONATT-004	June 18, 2017	June 17, 2018
Software BVADT	BVADT_Cond_ V7.3.7.4	NA	NA	NA

**Note:**

1. The calibration interval of the above test instruments are 12 months and the calibrations are traceable to NML/ROC and NIST/USA.
2. The test was performed in Shielded Room No. 1.
- 3 Tested Date: Nov. 21, 2017

#### 4.2.3 Test Procedure

- The EUT was placed 0.4 meters from the conducting wall of the shielded room with EUT being connected to the power mains through a line impedance stabilization network (LISN). Other support units were connected to the power mains through another LISN. The two LISNs provide 50 ohm/ 50uH of coupling impedance for the measuring instrument.
- Both lines of the power mains connected to the EUT were checked for maximum conducted interference.
- The frequency range from 150kHz to 30MHz was searched. Emission levels under (Limit - 20dB) was not recorded.

**NOTE:** All modes of operation were investigated and the worst-case emissions are reported.

#### 4.2.4 Deviation from Test Standard

No deviation.

#### 4.2.5 Test Setup

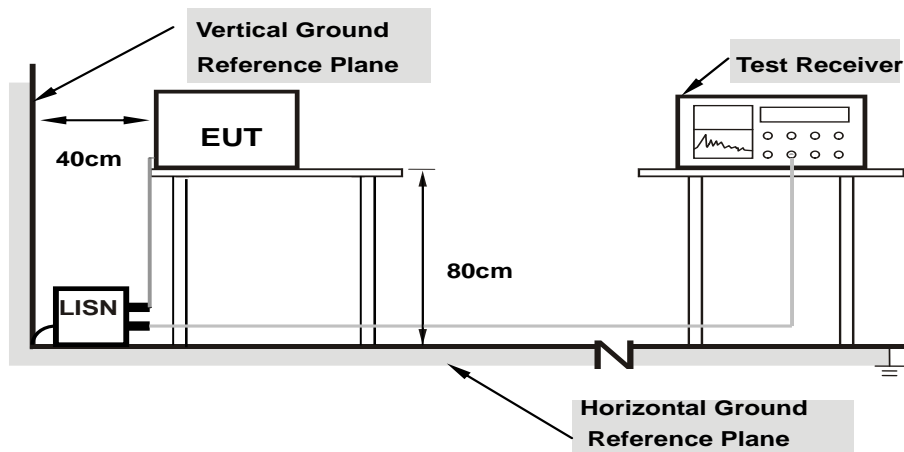

**Note: 1.Support units were connected to second LISN.**

For the actual test configuration, please refer to the attached file (Test Setup Photo).

#### 4.2.6 EUT Operating Condition

Same as 4.1.6.

#### 4.2.7 Test Results

Phase	Line (L)	Detector Function	Quasi-Peak (QP) / Average (AV)
-------	----------	-------------------	--------------------------------

No	Freq. [MHz]	Corr. Factor	Reading Value [dB (uV)]		Emission Level [dB (uV)]		Limit [dB (uV)]		Margin (dB)	
		(dB)	Q.P.	AV.	Q.P.	AV.	Q.P.	AV.	Q.P.	AV.
	1	0.15781	10.08	41.37	31.85	51.45	41.93	65.58	55.58	-14.13
2	0.17734	10.08	36.77	27.01	46.85	37.09	64.61	54.61	-17.76	-17.52
<b>3</b>	<b>0.36875</b>	<b>10.11</b>	<b>34.16</b>	<b>28.01</b>	<b>44.27</b>	<b>38.12</b>	<b>58.53</b>	<b>48.53</b>	<b>-14.26</b>	<b>-10.41</b>
4	1.26953	10.17	29.76	21.18	39.93	31.35	56.00	46.00	-16.07	-14.65
5	2.07422	10.18	27.94	19.97	38.12	30.15	56.00	46.00	-17.88	-15.85
6	7.31641	10.60	25.62	19.95	36.22	30.55	60.00	50.00	-23.78	-19.45

#### REMARKS:

1. Q.P. and AV. are abbreviations of quasi-peak and average individually.
2. The emission levels of other frequencies were very low against the limit.
3. Margin value = Emission level - Limit value
4. Correction factor = Insertion loss + Cable loss
5. Emission Level = Correction Factor + Reading Value.

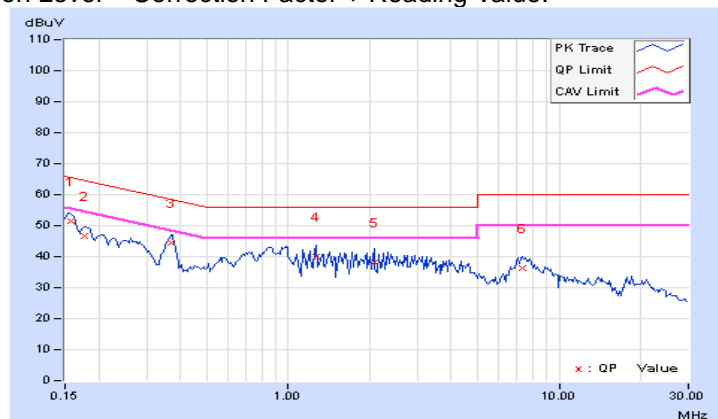

Phase	Neutral (N)	Detector Function	Quasi-Peak (QP) / Average (AV)
-------	-------------	-------------------	--------------------------------

No	Freq. [MHz]	Corr.	Reading Value		Emission Level		Limit		Margin	
		Factor	[dB (uV)]		[dB (uV)]		[dB (uV)]		(dB)	
	(dB)	Q.P.	AV.	Q.P.	AV.	Q.P.	AV.	Q.P.	AV.	
1	0.15781	10.07	39.68	29.42	49.75	39.49	65.58	55.58	-15.83	-16.09
2	0.36484	10.11	31.44	23.91	41.55	34.02	58.62	48.62	-17.07	-14.60
3	0.93516	10.13	24.29	16.85	34.42	26.98	56.00	46.00	-21.58	-19.02
4	2.48047	10.22	24.00	17.87	34.22	28.09	56.00	46.00	-21.78	-17.91
5	7.47656	10.52	23.52	17.64	34.04	28.16	60.00	50.00	-25.96	-21.84
6	14.89844	11.00	16.30	11.08	27.30	22.08	60.00	50.00	-32.70	-27.92

#### REMARKS:

1. Q.P. and AV. are abbreviations of quasi-peak and average individually.
2. The emission levels of other frequencies were very low against the limit.
3. Margin value = Emission level - Limit value
4. Correction factor = Insertion loss + Cable loss
5. Emission Level = Correction Factor + Reading Value.

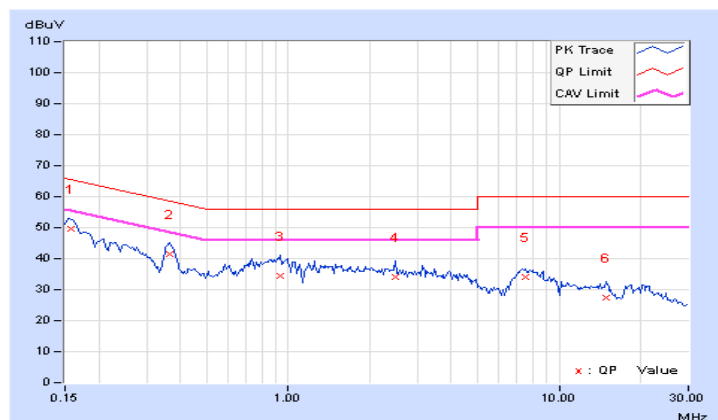

### 4.3 Transmit Power Measurement

#### 4.3.1 Limits of Transmit Power Measurement

Operation Band	EUT Category		Limit
U-NII-1		Outdoor Access Point	1 Watt (30 dBm) (Max. e.i.r.p $\leq$ 125mW(21 dBm) at any elevation angle above 30 degrees as measured from the horizon)
		Fixed point-to-point Access Point	1 Watt (30 dBm)
	√	Indoor Access Point	1 Watt (30 dBm)
	√	Client device	250mW (24 dBm)
U-NII-2A			250mW (24 dBm) or 11 dBm+10 log B*
U-NII-2C			250mW (24 dBm) or 11 dBm+10 log B*
U-NII-3		√	1 Watt (30 dBm)

\*B is the 26 dB emission bandwidth in megahertz

Per KDB 662911 Method of conducted output power measurement on IEEE 802.11 devices,

Array Gain = 0 dB (i.e., no array gain) for  $N_{ANT} \leq 4$ ;

Array Gain = 0 dB (i.e., no array gain) for channel widths  $\geq 40$  MHz for any  $N_{ANT}$ ;

Array Gain =  $5 \log(N_{ANT}/N_{SS})$  dB or 3 dB, whichever is less for 20-MHz channel widths with  $N_{ANT} \geq 5$ .

For power measurements on all other devices: Array Gain =  $10 \log(N_{ANT}/N_{SS})$  dB.

#### 4.3.2 Test Setup

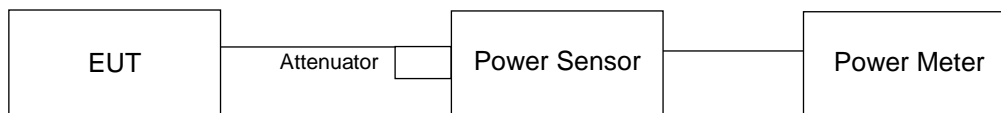

#### 4.3.3 Test Instruments

Refer to section 4.1.2 to get information of above instrument.

#### 4.3.4 Test Procedure

Method PM is used to perform output power measurement, trigger and gating function of wide band power meter is enabled to measure max output power of TX on burst. Duty factor is not added to measured value.

#### 4.3.5 Deviation from Test Standard

No deviation.

#### 4.3.6 EUT Operating Condition

The software provided by client to enable the EUT under transmission condition continuously at lowest, middle and highest channel frequencies individually.

## 4.3.7 Test Result

**U-NII-1**
**Master**
**CDD Mode**
**802.11a**

Chan.	Chan. Freq. (MHz)	Maximum Conducted Power (dBm)				Total Power (mW)	Total Power (dBm)	Limit (dBm)	Pass / Fail
		Chain 0	Chain 1	Chain 2	Chain 3				
36	5180	18.90	18.25	18.40	17.93	275.729	24.40	28.41	Pass
40	5200	17.24	16.42	15.88	15.82	173.739	22.40	28.41	Pass
48	5240	16.94	16.11	16.29	15.79	170.754	22.32	28.41	Pass

**Note:** 1. Directional gain = 7.59dBi > 6dBi, so the power limit shall be reduced to  $30-(7.59-6) = 28.41$  dBm.

**802.11ac (VHT20)**

Chan.	Chan. Freq. (MHz)	Maximum Conducted Power (dBm)				Total Power (mW)	Total Power (dBm)	Limit (dBm)	Pass / Fail
		Chain 0	Chain 1	Chain 2	Chain 3				
36	5180	17.05	16.21	16.09	15.85	171.585	22.34	28.41	Pass
40	5200	18.13	17.12	17.48	16.80	220.375	23.43	28.41	Pass
48	5240	16.83	16.56	16.25	15.76	173.325	22.39	28.41	Pass

**Note:** 1. Directional gain = 7.59dBi > 6dBi, so the power limit shall be reduced to  $30-(7.59-6) = 28.41$  dBm.

**802.11ac (VHT40)**

Chan.	Chan. Freq. (MHz)	Maximum Conducted Power (dBm)				Total Power (mW)	Total Power (dBm)	Limit (dBm)	Pass / Fail
		Chain 0	Chain 1	Chain 2	Chain 3				
38	5190	17.49	16.53	16.24	16.05	183.428	22.63	28.41	Pass
46	5230	18.48	18.02	17.32	17.40	242.761	23.85	28.41	Pass

**Note:** 1. Directional gain = 7.59dBi > 6dBi, so the power limit shall be reduced to  $30-(7.59-6) = 28.41$  dBm.

**802.11ac (VHT80)**

Chan.	Chan. Freq. (MHz)	Maximum Conducted Power (dBm)				Total Power (mW)	Total Power (dBm)	Limit (dBm)	Pass / Fail
		Chain 0	Chain 1	Chain 2	Chain 3				
42	5210	13.31	12.66	11.64	11.81	69.638	18.43	28.41	Pass

**Note:** 1. Directional gain = 7.59dBi > 6dBi, so the power limit shall be reduced to  $30-(7.59-6) = 28.41$  dBm.



**Client**  
**CDD Mode**  
**802.11a**

Chan.	Chan. Freq. (MHz)	Maximum Conducted Power (dBm)				Total Power (mW)	Total Power (dBm)	Limit (dBm)	Pass / Fail
		Chain 0	Chain 1	Chain 2	Chain 3				
36	5180	16.72	16.13	16.09	15.64	165.297	22.18	22.41	Pass
40	5200	17.24	16.42	15.88	15.82	173.739	22.40	22.41	Pass
48	5240	16.94	16.11	16.29	15.79	170.754	22.32	22.41	Pass

**Note:** 1. Directional gain = 7.59dBi > 6dBi, so the power limit shall be reduced to  $24 - (7.59 - 6) = 22.41$  dBm.

**802.11ac (VHT20)**

Chan.	Chan. Freq. (MHz)	Maximum Conducted Power (dBm)				Total Power (mW)	Total Power (dBm)	Limit (dBm)	Pass / Fail
		Chain 0	Chain 1	Chain 2	Chain 3				
36	5180	17.05	16.21	16.09	15.85	171.585	22.34	22.41	Pass
40	5200	16.93	16.02	16.25	15.48	166.799	22.22	22.41	Pass
48	5240	16.83	16.56	16.25	15.76	173.325	22.39	22.41	Pass

**Note:** 1. Directional gain = 7.59dBi > 6dBi, so the power limit shall be reduced to  $24 - (7.59 - 6) = 22.41$  dBm.

**802.11ac (VHT40)**

Chan.	Chan. Freq. (MHz)	Maximum Conducted Power (dBm)				Total Power (mW)	Total Power (dBm)	Limit (dBm)	Pass / Fail
		Chain 0	Chain 1	Chain 2	Chain 3				
38	5190	16.37	15.41	15.09	14.72	140.038	21.46	22.41	Pass
46	5230	16.16	15.71	15.02	14.83	140.722	21.48	22.41	Pass

**Note:** 1. Directional gain = 7.59dBi > 6dBi, so the power limit shall be reduced to  $24 - (7.59 - 6) = 22.41$  dBm.

**802.11ac (VHT80)**

Chan.	Chan. Freq. (MHz)	Maximum Conducted Power (dBm)				Total Power (mW)	Total Power (dBm)	Limit (dBm)	Pass / Fail
		Chain 0	Chain 1	Chain 2	Chain 3				
42	5210	13.31	12.66	11.64	11.81	69.638	18.43	22.41	69.638

**Note:** 1. Directional gain = 7.59dBi > 6dBi, so the power limit shall be reduced to  $24 - (7.59 - 6) = 22.41$  dBm.

**Master**  
**Beamforming Mode**  
**802.11ac (VHT20)**

Chan.	Chan. Freq. (MHz)	Maximum Conducted Power (dBm)				Total Power (mW)	Total Power (dBm)	Limit (dBm)	Pass / Fail
		Chain 0	Chain 1	Chain 2	Chain 3				
36	5180	17.05	16.21	16.09	15.85	171.585	22.34	28.41	Pass
40	5200	18.13	17.12	17.48	16.80	220.375	23.43	28.41	Pass
48	5240	16.83	16.56	16.25	15.76	173.325	22.39	28.41	Pass

**Note:** 1. Directional gain = 7.59dBi > 6dBi , so the power limit shall be reduced to  $30-(7.59-6) = 28.41$ dBm.

**802.11ac (VHT40)**

Chan.	Chan. Freq. (MHz)	Maximum Conducted Power (dBm)				Total Power (mW)	Total Power (dBm)	Limit (dBm)	Pass / Fail
		Chain 0	Chain 1	Chain 2	Chain 3				
38	5190	17.49	16.53	16.24	16.05	183.428	22.63	28.41	Pass
46	5230	18.48	18.02	17.32	17.40	242.761	23.85	28.41	Pass

**Note:** 1. Directional gain = 7.59dBi > 6dBi , so the power limit shall be reduced to  $30-(7.59-6) = 28.41$ dBm.

**802.11ac (VHT80)**

Chan.	Chan. Freq. (MHz)	Maximum Conducted Power (dBm)				Total Power (mW)	Total Power (dBm)	Limit (dBm)	Pass / Fail
		Chain 0	Chain 1	Chain 2	Chain 3				
42	5210	13.31	12.66	11.64	11.81	69.638	18.43	28.41	Pass

**Note:** 1. Directional gain = 7.59dBi > 6dBi , so the power limit shall be reduced to  $30-(7.59-6) = 28.41$ dBm.

**Client Mode**  
**Beamforming Mode**  
**802.11ac (VHT20)**

Chan.	Chan. Freq. (MHz)	Maximum Conducted Power (dBm)				Total Power (mW)	Total Power (dBm)	Limit (dBm)	Pass / Fail
		Chain 0	Chain 1	Chain 2	Chain 3				
36	5180	17.05	16.21	16.09	15.85	171.585	22.34	22.41	Pass
40	5200	16.93	16.02	16.25	15.48	166.799	22.22	22.41	Pass
48	5240	16.83	16.56	16.25	15.76	173.325	22.39	22.41	Pass

**Note:** 1. Directional gain = 7.59dBi > 6dBi , so the power limit shall be reduced to  $24-(7.59-6) = 22.41$ dBm.

**802.11ac (VHT40)**

Chan.	Chan. Freq. (MHz)	Maximum Conducted Power (dBm)				Total Power (mW)	Total Power (dBm)	Limit (dBm)	Pass / Fail
		Chain 0	Chain 1	Chain 2	Chain 3				
38	5190	16.37	15.41	15.09	14.72	140.038	21.46	22.41	Pass
46	5230	16.16	15.71	15.02	14.83	140.722	21.48	22.41	Pass

**Note:** 1. Directional gain = 7.59dBi > 6dBi , so the power limit shall be reduced to  $24-(7.59-6) = 22.41$ dBm.

**802.11ac (VHT80)**

Chan.	Chan. Freq. (MHz)	Maximum Conducted Power (dBm)				Total Power (mW)	Total Power (dBm)	Limit (dBm)	Pass / Fail
		Chain 0	Chain 1	Chain 2	Chain 3				
42	5210	13.31	12.66	11.64	11.81	69.638	18.43	22.41	Pass

**Note:** 1. Directional gain = 7.59dBi > 6dBi , so the power limit shall be reduced to  $24-(7.59-6) = 22.41$ dBm.

**U-NII-3**  
**CDD Mode**  
**802.11a**

Chan.	Chan. Freq. (MHz)	Maximum Conducted Power (dBm)				Total Power (mW)	Total Power (dBm)	Limit (dBm)	Pass / Fail
		Chain 0	Chain 1	Chain 2	Chain 3				
149	5745	22.01	20.97	20.88	20.71	524.104	27.19	29.34	Pass
157	5785	21.72	21.28	20.87	20.79	525	27.20	29.34	Pass
165	5825	21.76	20.75	20.79	20.56	502.531	27.01	29.34	Pass

**Note:** 1. Directional gain = 6.66dBi > 6dBi, so the power limit shall be reduced to  $30-(6.66-6) = 29.34$ dBm.

**802.11ac (VHT20)**

Chan.	Chan. Freq. (MHz)	Maximum Conducted Power (dBm)				Total Power (mW)	Total Power (dBm)	Limit (dBm)	Pass / Fail
		Chain 0	Chain 1	Chain 2	Chain 3				
149	5745	21.81	21.12	20.91	20.89	527.179	27.22	29.34	Pass
157	5785	21.77	21.03	21.23	20.82	530.599	27.25	29.34	Pass
165	5825	21.62	20.84	20.98	20.75	510.714	27.08	29.34	Pass

**Note:** 1. Directional gain = 6.66dBi > 6dBi, so the power limit shall be reduced to  $30-(6.66-6) = 29.34$ dBm.

**802.11ac (VHT40)**

Chan.	Chan. Freq. (MHz)	Maximum Conducted Power (dBm)				Total Power (mW)	Total Power (dBm)	Limit (dBm)	Pass / Fail
		Chain 0	Chain 1	Chain 2	Chain 3				
151	5755	22.51	21.67	21.81	21.29	611.422	27.86	29.34	Pass
159	5795	22.44	21.45	21.57	21.30	593.47	27.73	29.34	Pass

**Note:** 1. Directional gain = 6.66dBi > 6dBi, so the power limit shall be reduced to  $30-(6.66-6) = 29.34$ dBm.

**802.11ac (VHT80)**

Chan.	Chan. Freq. (MHz)	Maximum Conducted Power (dBm)				Total Power (mW)	Total Power (dBm)	Limit (dBm)	Pass / Fail
		Chain 0	Chain 1	Chain 2	Chain 3				
155	5775	20.98	20.55	20.24	19.85	441.102	26.45	29.34	Pass

**Note:** 1. Directional gain = 6.66dBi > 6dBi, so the power limit shall be reduced to  $30-(6.66-6) = 29.34$ dBm.

## Beamforming Mode

### 802.11ac (VHT20)

Chan.	Chan. Freq. (MHz)	Maximum Conducted Power (dBm)				Total Power (mW)	Total Power (dBm)	Limit (dBm)	Pass / Fail
		Chain 0	Chain 1	Chain 2	Chain 3				
149	5745	21.81	21.12	20.91	20.89	527.179	27.22	29.34	Pass
157	5785	21.77	21.03	21.23	20.82	530.599	27.25	29.34	Pass
165	5825	21.62	20.84	20.98	20.75	510.714	27.08	29.34	Pass

**Note:** 1. Directional gain = 6.66dBi > 6dBi , so the power limit shall be reduced to  $30-(6.66-6) = 29.34$ dBm.

### 802.11ac (VHT40)

Chan.	Chan. Freq. (MHz)	Maximum Conducted Power (dBm)				Total Power (mW)	Total Power (dBm)	Limit (dBm)	Pass / Fail
		Chain 0	Chain 1	Chain 2	Chain 3				
151	5755	22.51	21.67	21.81	21.29	611.422	27.86	29.34	Pass
159	5795	22.44	21.45	21.57	21.30	593.47	27.73	29.34	Pass

**Note:** 1. Directional gain = 6.66dBi > 6dBi , so the power limit shall be reduced to  $30-(6.66-6) = 29.34$ dBm.

### 802.11ac (VHT80)

Chan.	Chan. Freq. (MHz)	Maximum Conducted Power (dBm)				Total Power (mW)	Total Power (dBm)	Limit (dBm)	Pass / Fail
		Chain 0	Chain 1	Chain 2	Chain 3				
155	5775	20.98	20.55	20.24	19.85	441.102	26.45	29.34	Pass

**Note:** 1. Directional gain = 6.66dBi > 6dBi , so the power limit shall be reduced to  $30-(6.66-6) = 29.34$ dBm.

## 4.4 Occupied Bandwidth Measurement

### 4.4.1 Test Setup



### 4.4.2 Test Instruments

Refer to section 4.1.2 to get information of above instrument.

### 4.4.3 Test Procedure

The transmitter output was connected to the spectrum analyzer through an attenuator. The bandwidth of the fundamental frequency was measured by spectrum analyzer with resolution bandwidth in the range of 1% to 5% of the anticipated emission bandwidth, and a video bandwidth at least 3x the resolution bandwidth and set the detector to SAMPLE. The width of a frequency band such that, below the lower and above the upper frequency limits, the mean powers emitted are each equal to a specified percentage 0.5 %of the total mean power of a given emission.

#### 4.4.4 Test Results

##### U-NII-1

##### Master Mode

##### 802.11a

Channel	Channel Frequency (MHz)	Occupied Bandwidth (MHz)			
		Chain 0	Chain 1	Chain 2	Chain 3
36	5180	16.80	17.04	16.92	17.04
40	5200	16.92	16.80	16.92	17.04
48	5240	17.04	17.04	16.80	16.80

##### 802.11ac (VHT20)

Channel	Channel Frequency (MHz)	Occupied Bandwidth (MHz)			
		Chain 0	Chain 1	Chain 2	Chain 3
36	5180	18.12	18.12	17.88	18.00
40	5200	18.00	18.12	18.12	18.12
48	5240	18.00	18.12	18.12	18.00

##### 802.11ac (VHT40)

Channel	Channel Frequency (MHz)	Occupied Bandwidth (MHz)			
		Chain 0	Chain 1	Chain 2	Chain 3
38	5190	36.96	37.20	36.96	37.20
46	5230	36.96	36.72	36.72	36.72

##### 802.11ac (VHT80)

Channel	Channel Frequency (MHz)	Occupied Bandwidth (MHz)			
		Chain 0	Chain 1	Chain 2	Chain 3
42	5210	75.36	75.36	75.84	75.36

### Spectrum Plot of Worst Value

**802.11a / Chain 0 : CH48**

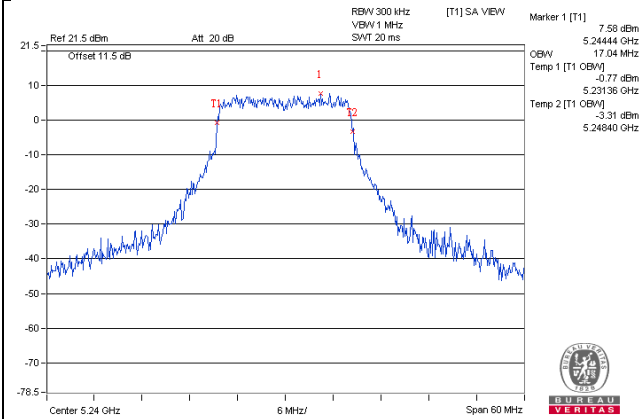

**802.11ac (VHT20) / Chain 0 : CH36**

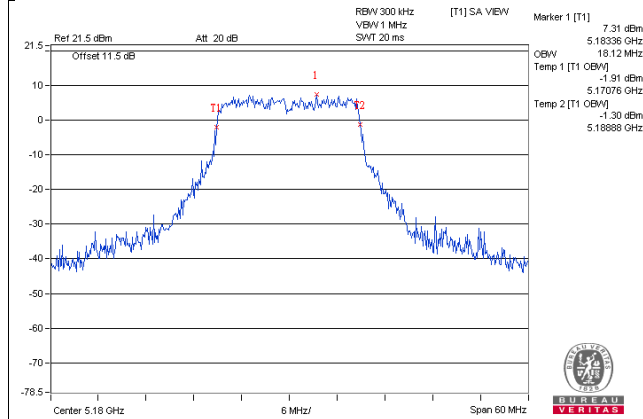

**802.11ac (VHT40) / Chain 1 : CH38**

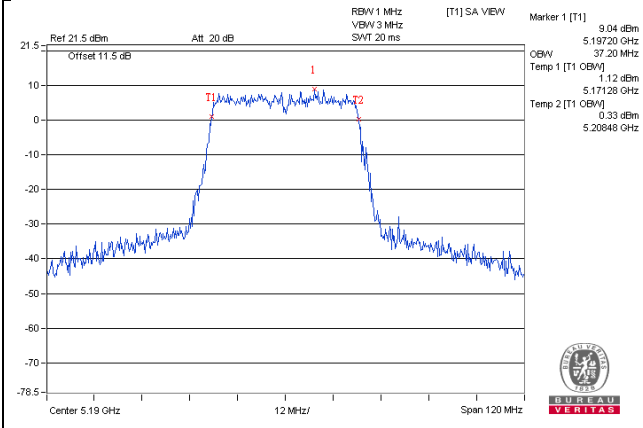

**802.11ac (VHT80) / Chain 2 : CH42**

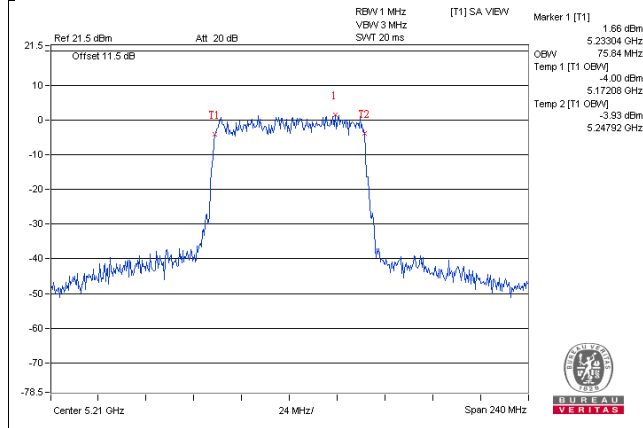



**Client Mode**
**802.11a**

Channel	Channel Frequency (MHz)	Occupied Bandwidth (MHz)			
		Chain 0	Chain 1	Chain 2	Chain 3
36	5180	17.04	16.80	16.92	16.92
40	5200	16.92	16.80	16.92	17.04
48	5240	17.04	17.04	16.80	16.80

**802.11ac (VHT20)**

Channel	Channel Frequency (MHz)	Occupied Bandwidth (MHz)			
		Chain 0	Chain 1	Chain 2	Chain 3
36	5180	18.12	18.12	17.88	18.00
40	5200	18.24	18.00	18.24	18.00
48	5240	18.00	18.12	18.12	18.00

**802.11ac (VHT40)**

Channel	Channel Frequency (MHz)	Occupied Bandwidth (MHz)			
		Chain 0	Chain 1	Chain 2	Chain 3
38	5190	36.72	36.96	36.96	36.72
46	5230	36.72	36.96	36.72	36.72

**802.11ac (VHT80)**

Channel	Channel Frequency (MHz)	Occupied Bandwidth (MHz)			
		Chain 0	Chain 1	Chain 2	Chain 3
42	5210	75.36	75.36	75.84	75.36

### Spectrum Plot of Worst Value

**802.11a / Chain 0 : CH36**

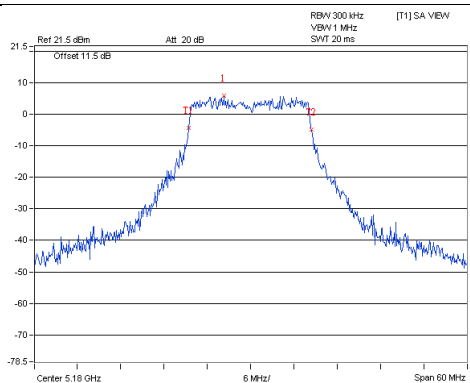

**802.11a (VHT20) / Chain 0 : CH40**

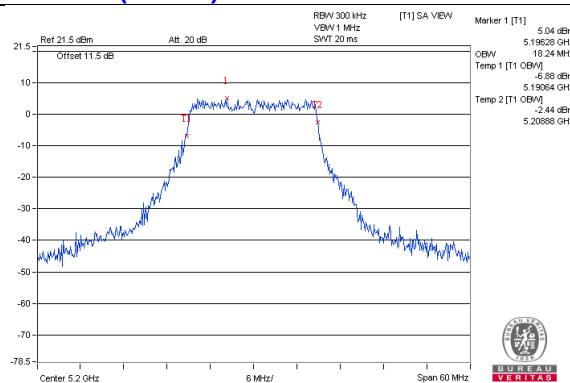

**802.11ac (VHT40) / Chain 1 : CH38**

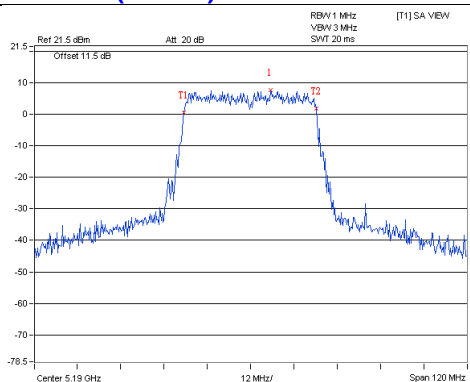

**802.11ac (VHT80) / Chain 2 : CH42**

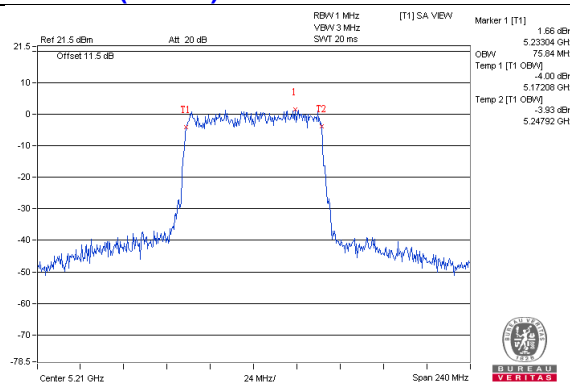

**U-NII-3**  
**802.11a**

Channel	Channel Frequency (MHz)	Occupied Bandwidth (MHz)			
		Chain 0	Chain 1	Chain 2	Chain 3
149	5745	17.40	17.28	17.76	17.40
157	5785	17.64	17.52	18.84	17.52
165	5825	17.76	17.76	18.96	17.40

**802.11ac (VHT20)**

Channel	Channel Frequency (MHz)	Occupied Bandwidth (MHz)			
		Chain 0	Chain 1	Chain 2	Chain 3
149	5745	18.60	18.36	19.44	18.24
157	5785	18.72	18.48	19.92	18.12
165	5825	18.60	18.48	20.88	18.48

**802.11ac (VHT40)**

Channel	Channel Frequency (MHz)	Occupied Bandwidth (MHz)			
		Chain 0	Chain 1	Chain 2	Chain 3
151	5755	37.44	37.68	43.44	37.20
159	5795	38.16	37.44	46.08	38.16

**802.11ac (VHT80)**

Channel	Channel Frequency (MHz)	Occupied Bandwidth (MHz)			
		Chain 0	Chain 1	Chain 2	Chain 3
155	5775	75.36	75.84	76.32	76.32

### Spectrum Plot of Worst Value

**802.11a / Chain 2 : CH165**

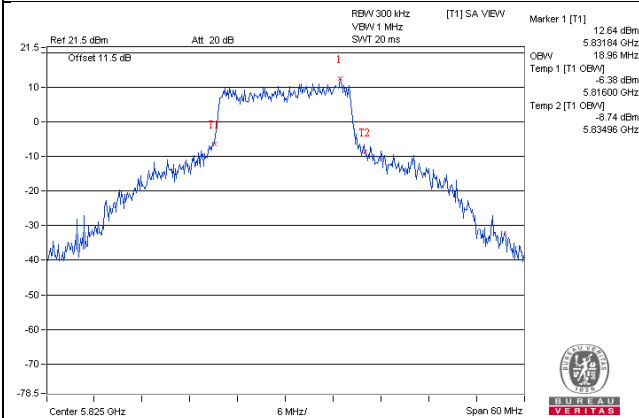

**802.11ac (VHT20) / Chain 2 : CH165**

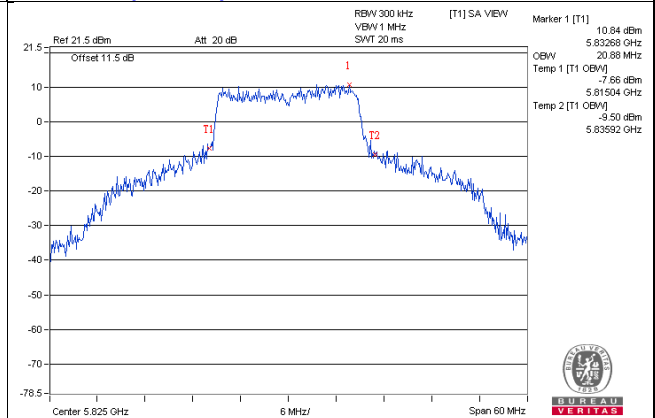

**802.11ac (VHT40) / Chain 2 : CH159**

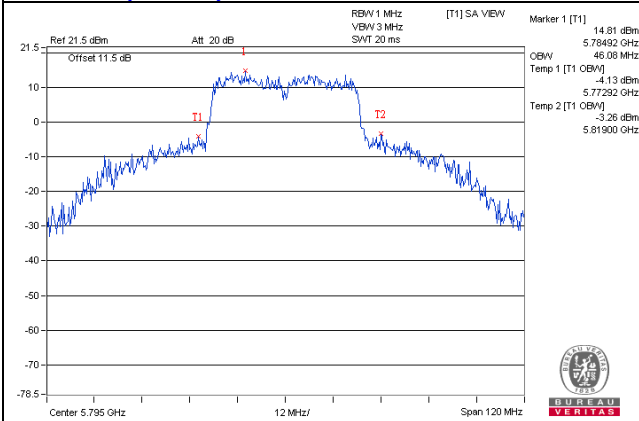

**802.11ac (VHT80) / Chain 2 : CH155**

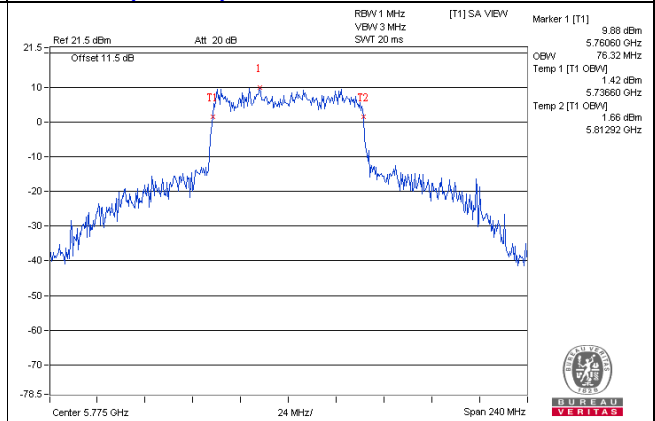

### Spectrum Plot for near by DFS band (DFS is required, if 99% OCP straddle into U-NII-2A band)

**802.11a / Chain 0 : CH48**

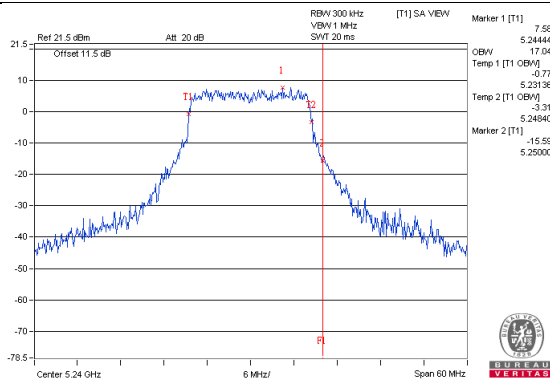

**802.11a / Chain 1 : CH48**

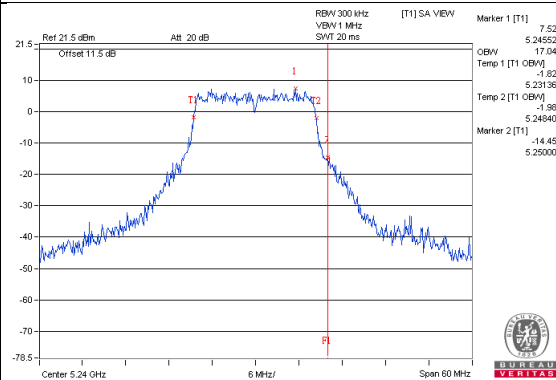

**802.11a / Chain 2 : CH48**

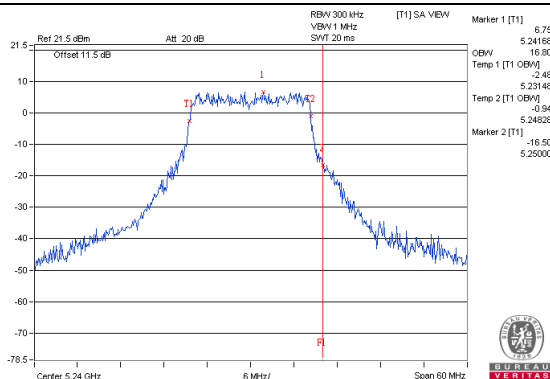

**802.11a / Chain 3 : CH48**

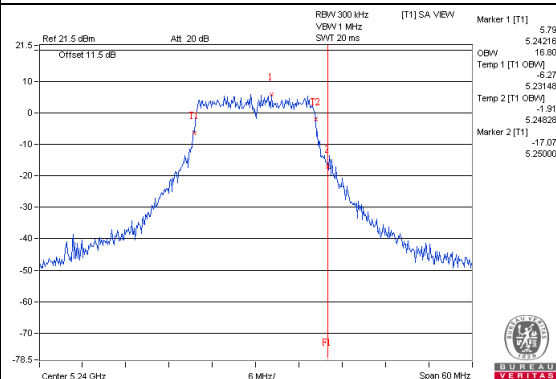

**802.11ac (VHT20) / Chain 0 : CH48**

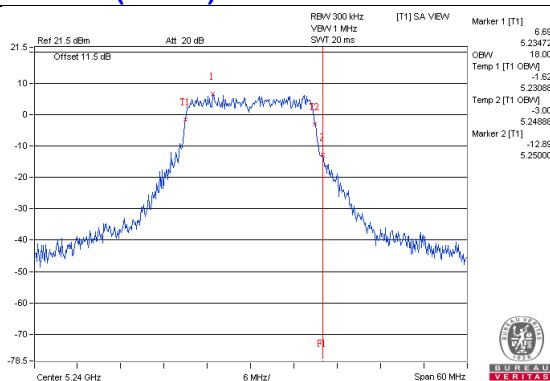

**802.11ac (VHT20) / Chain 1 : CH48**

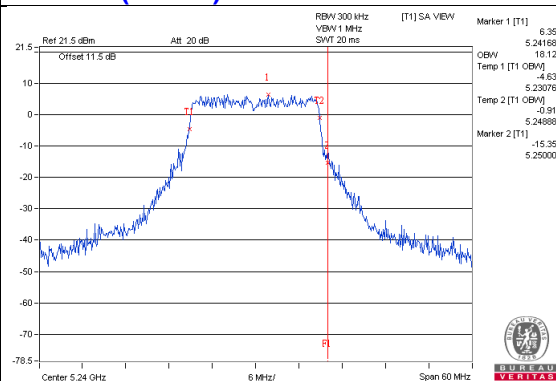

**802.11ac (VHT20) / Chain 2 : CH48**

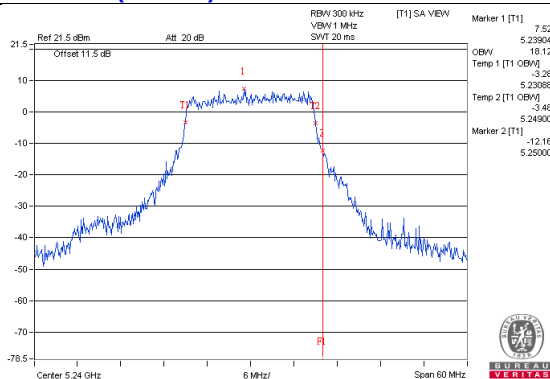

**802.11ac (VHT20) / Chain 3 : CH48**

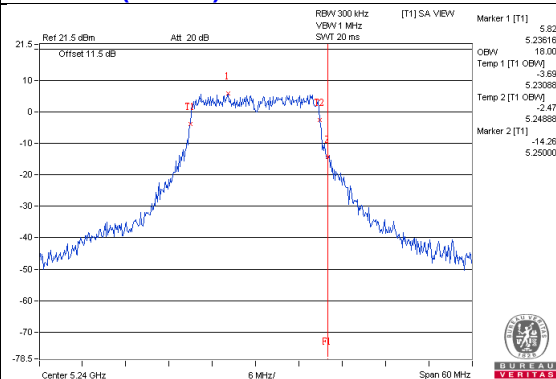

### Spectrum Plot for near by DFS band (DFS is required, if 99% OCP straddle into U-NII-2A band)

**802.11ac (VHT40) / Chain 0 : CH46**

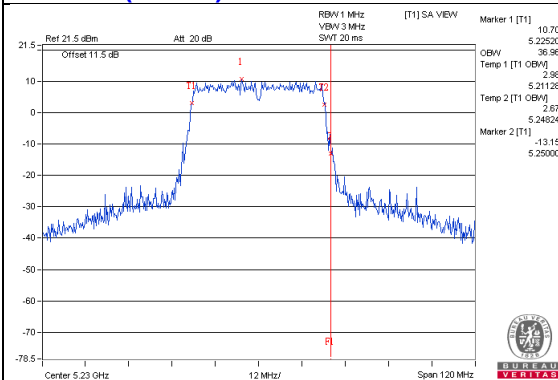

**802.11ac (VHT40) / Chain 1 : CH46**

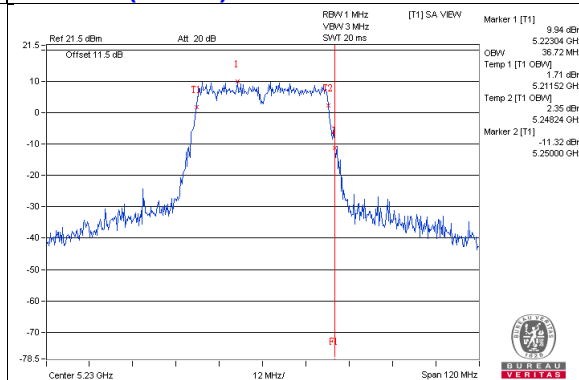

**802.11ac (VHT40) / Chain 2 : CH46**

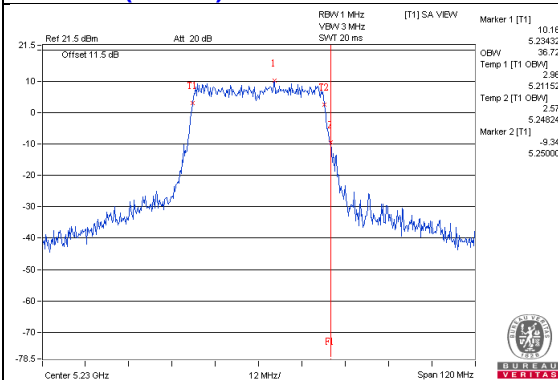

**802.11ac (VHT40) / Chain 3 : CH46**

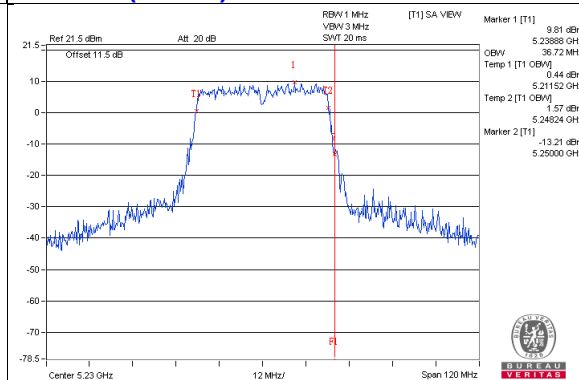

**802.11ac (VHT80) / Chain 0 : CH42**

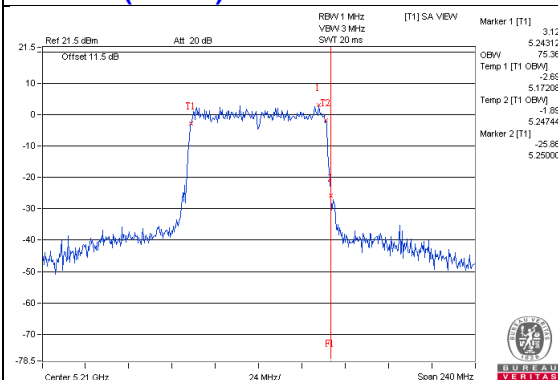

**802.11ac (VHT80) / Chain 1 : CH42**

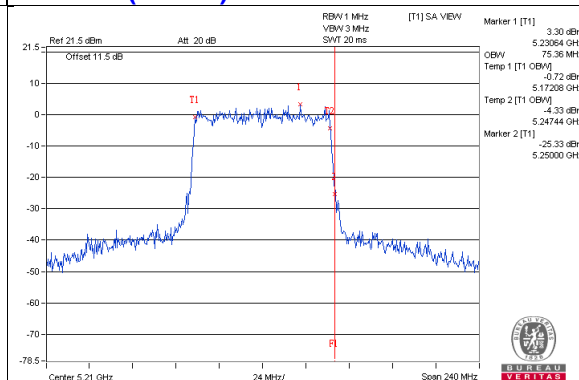

**802.11ac (VHT80) / Chain 2 : CH42**

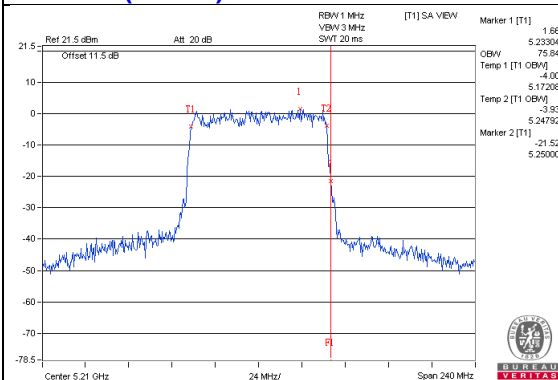

**802.11ac (VHT80) / Chain 3 : CH42**

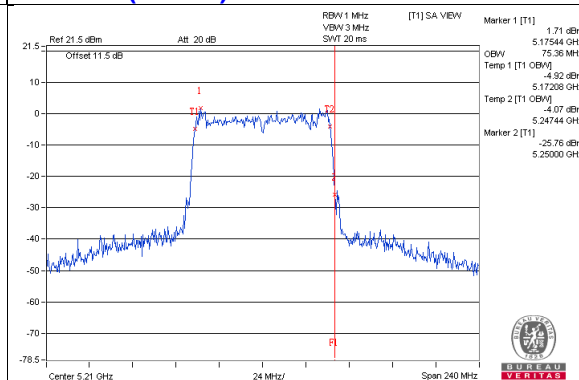

### Spectrum Plot for near by DFS band (DFS is required, if 99% OCP straddle into U-NII-2C band)

**802.11a / Chain 0 : CH149**

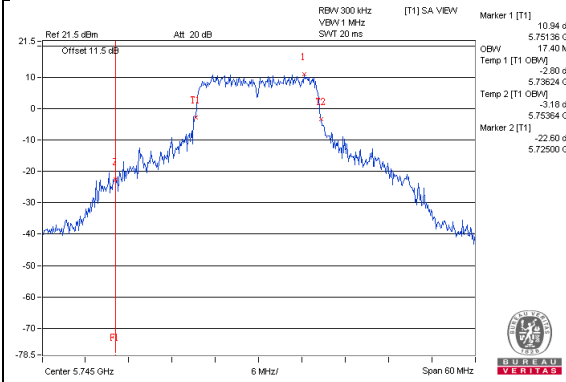

**802.11a / Chain 1 : CH149**

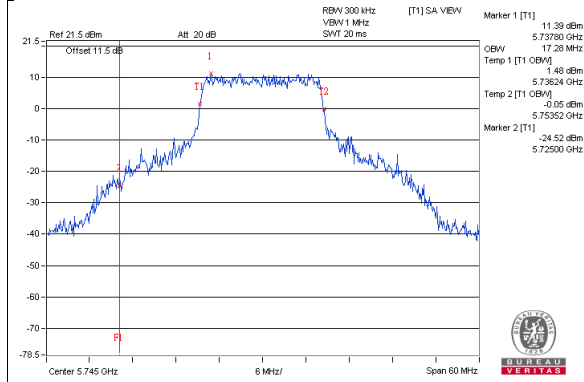

**802.11a / Chain 2 : CH149**

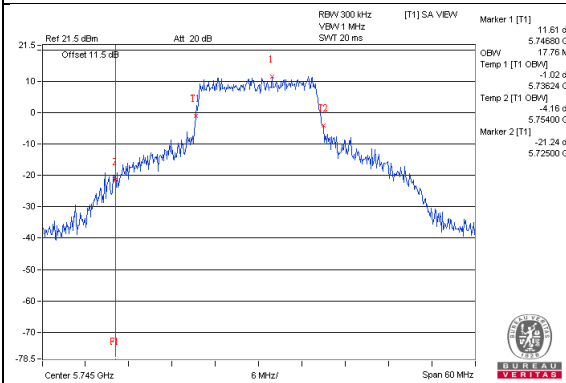

**802.11a / Chain 3 : CH149**

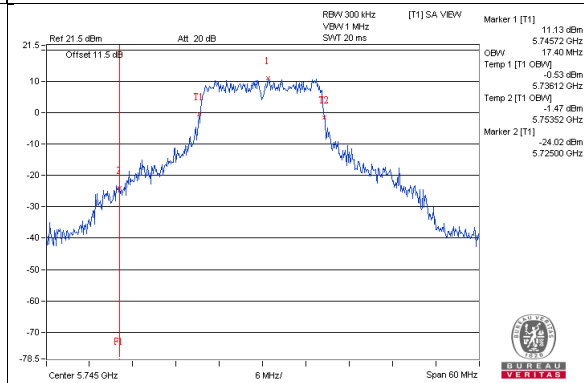

**802.11ac (VHT20) / Chain 0 : CH149**

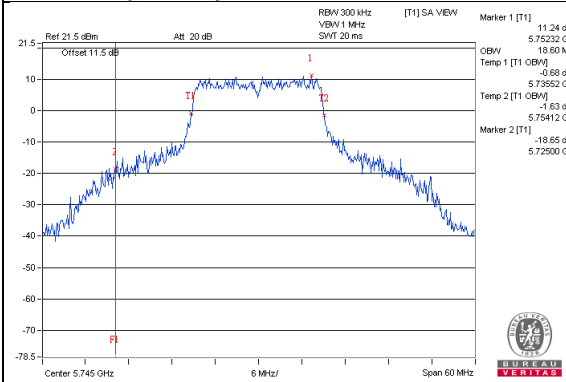

**802.11ac (VHT20) / Chain 1 : CH149**

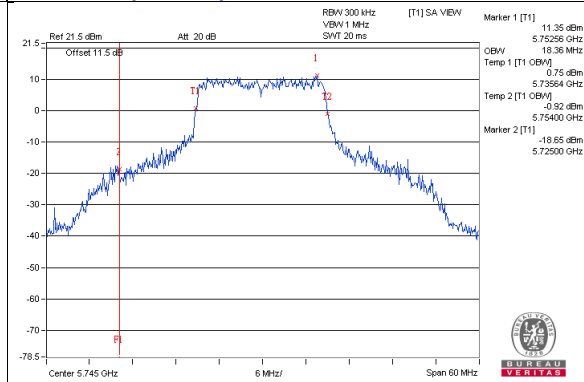

**802.11ac (VHT20) / Chain 2 : CH149**

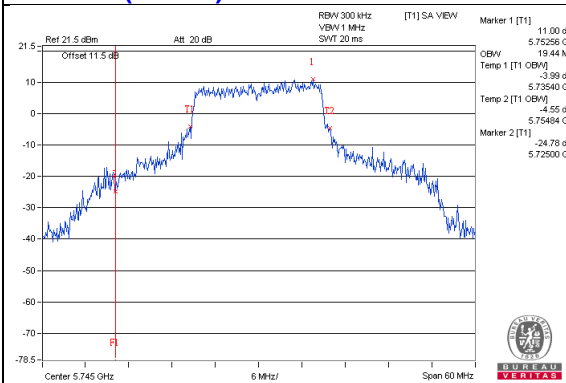

**802.11ac (VHT20) / Chain 3 : CH149**

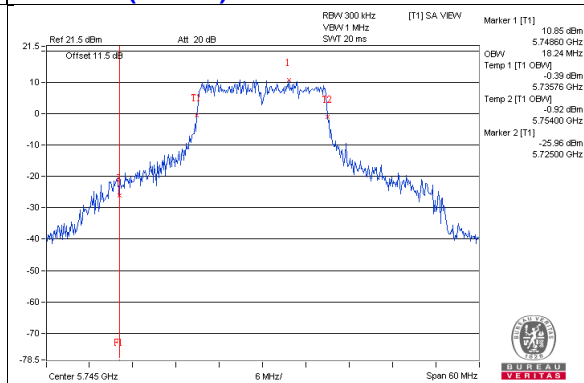

### Spectrum Plot for near by DFS band (DFS is required, if 99% OCP straddle into U-NII-2C band)

**802.11ac (VHT40) / Chain 0 : CH151**

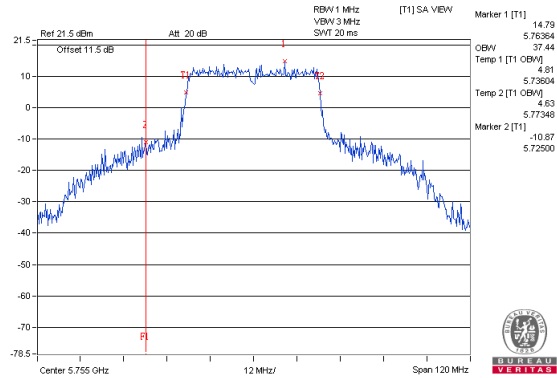

**802.11ac (VHT40) / Chain 1 : CH151**

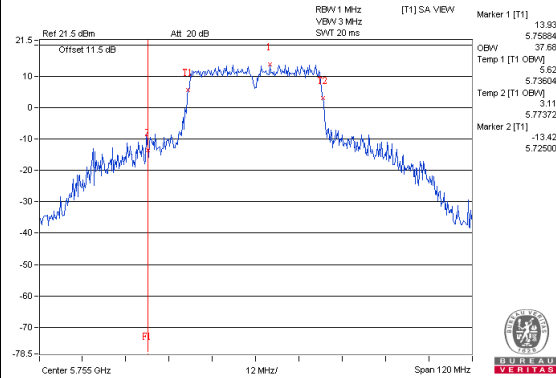

**802.11ac (VHT40) / Chain 2 : CH151**

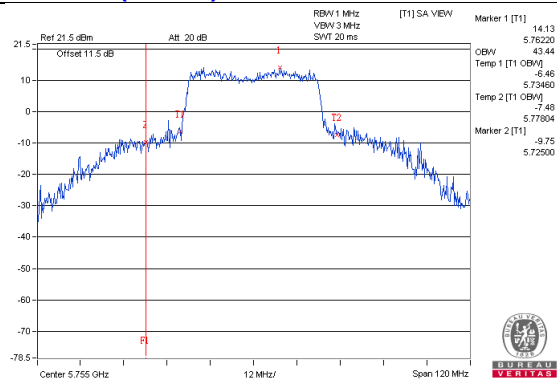

**802.11ac (VHT40) / Chain 3 : CH151**

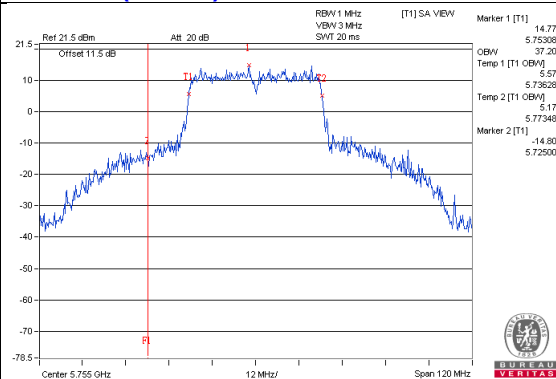

**802.11ac (VHT80) / Chain 0 : CH155**

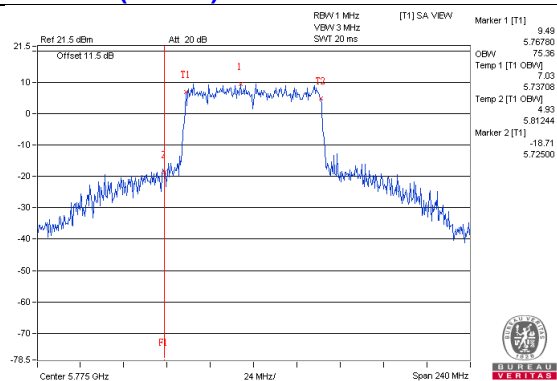

**802.11ac (VHT80) / Chain 1 : CH155**

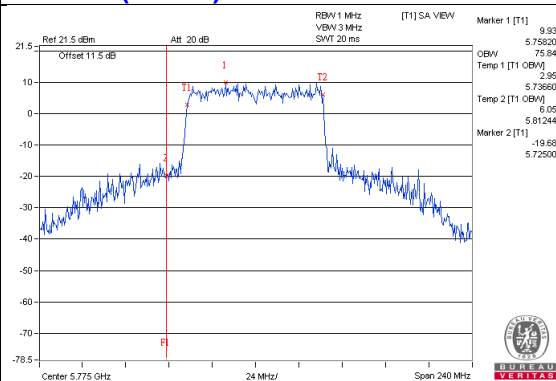

**802.11ac (VHT80) / Chain 2 : CH155**

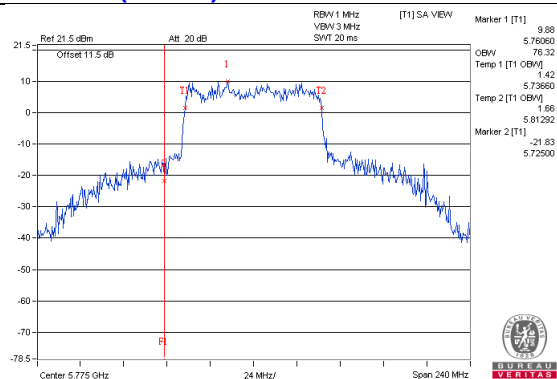

**802.11ac (VHT80) / Chain 3 : CH155**

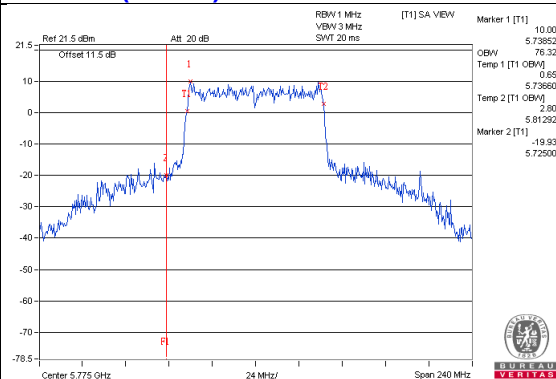



## 4.5 Peak Power Spectral Density Measurement

### 4.5.1 Limits of Peak Power Spectral Density Measurement

Operation Band	EUT Category		Limit
U-NII-1		Outdoor Access Point	17dBm/ MHz
		Fixed point-to-point Access Point	
	√	Indoor Access Point	11dBm/ MHz
	√	Client device	
U-NII-2A			11dBm/ MHz
U-NII-2C			11dBm/ MHz
U-NII-3	√		30dBm/ 500kHz

### 4.5.2 Test Setup

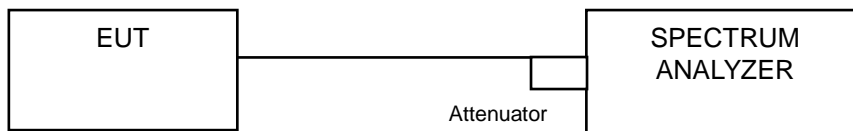

### 4.5.3 Test Instruments

Refer to section 4.1.2 to get information of above instrument.

#### 4.5.4 Test Procedure

##### **802.11ac (VHT20) , 802.11ac (VHT40), 802.11ac (VHT80)**

###### **For U-NII-1:**

Using method SA-1

1. Set span to encompass the entire emission bandwidth (EBW) of the signal.
2. Set RBW = 1 MHz, Set VBW  $\geq$  3 MHz, Detector = RMS
3. Sweep time = auto, trigger set to "free run".
4. Trace average at least 100 traces in power averaging mode.
5. Record the max value

###### **For U-NII-3:**

1. Set span to encompass the entire emission bandwidth (EBW) of the signal.
2. Set RBW = 300 kHz, Set VBW  $\geq$  1 MHz, Detector = RMS
3. Use the peak marker function to determine the maximum power level in any 300 kHz band segment within the fundamental EBW.
4. Scale the observed power level to an equivalent value in 500 kHz by adjusting (reducing) the measured power by a bandwidth correction factor (BWCF) where  $BWCF = 10\log(500 \text{ kHz}/300\text{kHz})$
5. Sweep time = auto, trigger set to "free run".
6. Trace average at least 100 traces in power averaging mode.
7. Record the max value

##### **802.11a**

###### **For U-NII-1:**

Using method SA-2

1. Set span to encompass the entire emission bandwidth (EBW) of the signal.
2. Set RBW = 1 MHz, Set VBW  $\geq$  3 MHz, Detector = RMS
3. Sweep time = auto, trigger set to "free run".
4. Trace average at least 100 traces in power averaging mode.
5. Record the max value and add  $10 \log (1/\text{duty cycle})$

###### **For U-NII-3:**

1. Set span to encompass the entire emission bandwidth (EBW) of the signal.
2. Set RBW = 300 kHz, Set VBW  $\geq$  1 MHz, Detector = RMS
3. Use the peak marker function to determine the maximum power level in any 300 kHz band segment within the fundamental EBW.
4. Scale the observed power level to an equivalent value in 500 kHz by adjusting (reducing) the measured power by a bandwidth correction factor (BWCF) where  $BWCF = 10\log(500 \text{ kHz}/300\text{kHz})$
5. Sweep time = auto, trigger set to "free run".
6. Trace average at least 100 traces in power averaging mode.
7. Record the max value and add  $10 \log (1/\text{duty cycle})$

#### 4.5.5 Deviation from Test Standard

No deviation.

#### 4.5.6 EUT Operating Condition

Same as Item 4.3.6.

#### 4.5.7 Test Results

##### For U-NII-1: Master Mode 802.11a

Chan.	Chan. Freq. (MHz)	PSD W/O Duty Factor (dBm)				Duty Factor (dB)	Total PSD With Duty Factor (dBm)	MAX. Limit (dBm/MHz)	Pass / Fail
		Chain 0	Chain 1	Chain 2	Chain 3				
36	5180	3.31	3.70	3.23	3.65	0.14	9.64	15.41	Pass
40	5200	2.85	1.41	1.73	0.50	0.14	7.86	15.41	Pass
48	5240	3.07	2.41	1.85	0.96	0.14	8.30	15.41	Pass

- Note:**
- Method a) of power density measurement of KDB 662911 is using for calculating total power density. Total power density is summing entire spectra across corresponding frequency bins on the various outputs by computer.
  - Directional gain = 7.59dBi > 6dBi , so the power density limit shall be reduced to  $17-(7.59-6) = 15.41\text{dBm}$ .
  - Refer to section 3.3 for duty cycle spectrum plot.

##### 802.11ac (VHT20)

Chan.	Chan. Freq. (MHz)	PSD (dBm/MHz)				Total Power Density (dBm/MHz)	MAX. Limit (dBm/MHz)	Pass / Fail
		Chain 0	Chain 1	Chain 2	Chain 3			
36	5180	2.87	2.20	2.23	1.93	8.34	15.41	Pass
40	5200	3.93	3.14	2.84	3.21	9.32	15.41	Pass
48	5240	1.98	2.21	2.75	1.55	8.16	15.41	Pass

- Note:**
- Method a) of power density measurement of KDB 662911 is using for calculating total power density. Total power density is summing entire spectra across corresponding frequency bins on the various outputs by computer.
  - Directional gain = 7.59dBi > 6dBi , so the power density limit shall be reduced to  $17-(7.59-6) = 15.41\text{dBm}$ .

##### 802.11ac (VHT40)

Chan.	Chan. Freq. (MHz)	PSD (dBm/MHz)				Total Power Density (dBm/MHz)	MAX. Limit (dBm/MHz)	Pass / Fail
		Chain 0	Chain 1	Chain 2	Chain 3			
38	5190	-0.77	-1.56	-1.39	-1.63	4.70	15.41	Pass
46	5230	0.45	-0.22	-0.15	-0.41	5.95	15.41	Pass

- Note:**
- Method a) of power density measurement of KDB 662911 is using for calculating total power density. Total power density is summing entire spectra across corresponding frequency bins on the various outputs by computer.
  - Directional gain = 7.59dBi > 6dBi , so the power density limit shall be reduced to  $17-(7.59-6) = 15.41\text{dBm}$ .

**802.11ac (VHT80)**

Chan.	Chan. Freq. (MHz)	PSD (dBm/MHz)				Total Power Density (dBm/MHz)	MAX. Limit (dBm/MHz)	Pass / Fail
		Chain 0	Chain 1	Chain 2	Chain 3			
42	5210	-6.27	-6.90	-8.34	-8.48	-1.37	15.41	Pass

- Note:** 1. Method a) of power density measurement of KDB 662911 is using for calculating total power density. Total power density is summing entire spectra across corresponding frequency bins on the various outputs by computer.
2. Directional gain = 7.59dBi > 6dBi , so the power density limit shall be reduced to  $17-(7.59-6) = 15.41\text{dBm}$ .

### Spectrum Plot of Worst Value

**802.11a / Chain 1 : CH36**

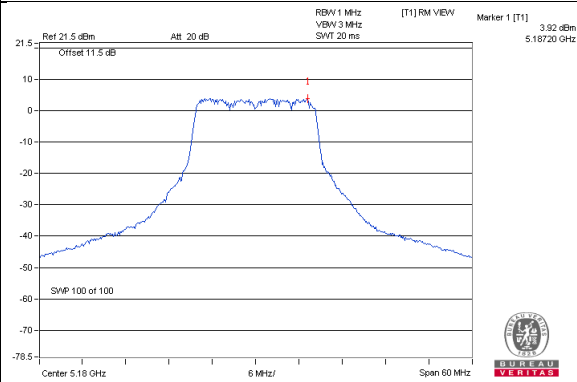

**802.11a (VHT20) / Chain 0 : CH40**

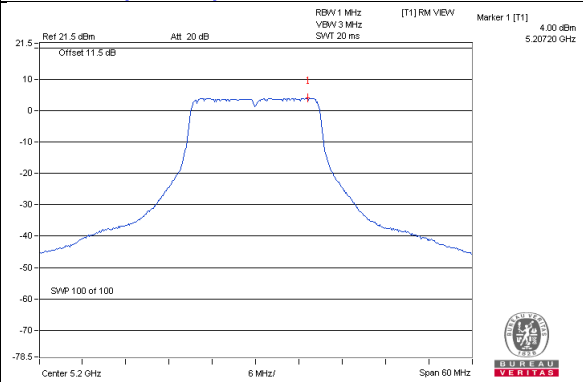

**802.11ac (VHT40) / Chain 0 : CH46**

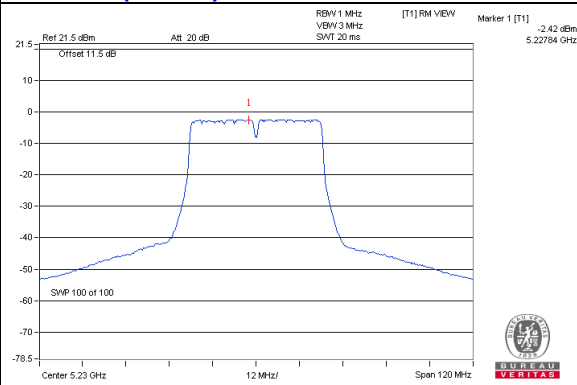

**802.11ac (VHT80) / Chain 0 : CH42**

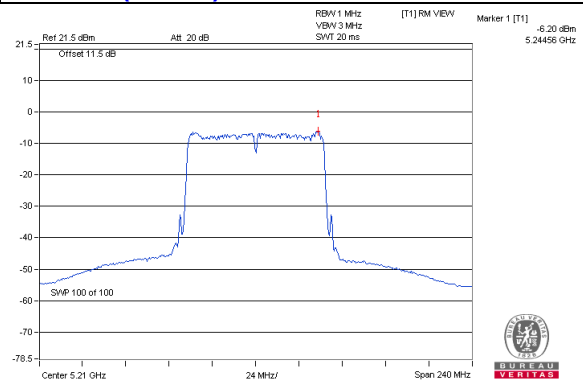

**Client Mode**
**802.11a**

Chan.	Chan. Freq. (MHz)	PSD W/O Duty Factor (dBm)				Duty Factor (dB)	Total PSD With Duty Factor (dBm)	MAX. Limit (dBm/MHz)	Pass / Fail
		Chain 0	Chain 1	Chain 2	Chain 3				
36	5180	1.11	1.32	1.30	1.18	0.14	7.39	9.41	Pass
40	5200	2.85	1.41	1.73	0.50	0.14	7.86	9.41	Pass
48	5240	3.07	2.41	1.85	0.96	0.14	8.30	9.41	Pass

- Note:**
- Method a) of power density measurement of KDB 662911 is using for calculating total power density. Total power density is summing entire spectra across corresponding frequency bins on the various outputs by computer.
  - Directional gain = 7.59dBi > 6dBi , so the power density limit shall be reduced to  $11-(7.59-6) = 9.41\text{dBm}$ .
  - Refer to section 3.3 for duty cycle spectrum plot.

**802.11ac (VHT20)**

Chan.	Chan. Freq. (MHz)	PSD (dBm/MHz)				Total Power Density (dBm/MHz)	MAX. Limit (dBm/MHz)	Pass / Fail
		Chain 0	Chain 1	Chain 2	Chain 3			
36	5180	2.87	2.20	2.23	1.93	8.34	9.41	Pass
40	5200	1.19	1.53	1.24	0.45	7.14	9.41	Pass
48	5240	1.98	2.21	2.75	1.55	8.16	9.41	Pass

- Note:**
- Method a) of power density measurement of KDB 662911 is using for calculating total power density. Total power density is summing entire spectra across corresponding frequency bins on the various outputs by computer.
  - Directional gain = 7.59dBi > 6dBi , so the power density limit shall be reduced to  $11-(7.59-6) = 9.41\text{dBm}$ .

**802.11ac (VHT40)**

Chan.	Chan. Freq. (MHz)	PSD (dBm/MHz)				Total Power Density (dBm/MHz)	MAX. Limit (dBm/MHz)	Pass / Fail
		Chain 0	Chain 1	Chain 2	Chain 3			
38	5190	-2.71	-2.55	-2.48	-3.64	3.20	9.41	Pass
46	5230	-2.44	-2.30	-2.18	-2.29	3.72	9.41	Pass

- Note:**
- Method a) of power density measurement of KDB 662911 is using for calculating total power density. Total power density is summing entire spectra across corresponding frequency bins on the various outputs by computer.
  - Directional gain = 7.59dBi > 6dBi , so the power density limit shall be reduced to  $11-(7.59-6) = 9.41\text{dBm}$ .

### 802.11ac (VHT80)

Chan.	Chan. Freq. (MHz)	PSD (dBm/MHz)				Total Power Density (dBm/MHz)	MAX. Limit (dBm/MHz)	Pass / Fail
		Chain 0	Chain 1	Chain 2	Chain 3			
42	5210	-6.27	-6.90	-8.34	-8.48	-1.37	9.41	Pass

- Note:**
- Method a) of power density measurement of KDB 662911 is using for calculating total power density. Total power density is summing entire spectra across corresponding frequency bins on the various outputs by computer.
  - Directional gain = 7.59dBi > 6dBi , so the power density limit shall be reduced to  $11-(7.59-6) = 9.41\text{dBm}$ .

### Spectrum Plot of Worst Value

**802.11a / Chain 0 : CH48**

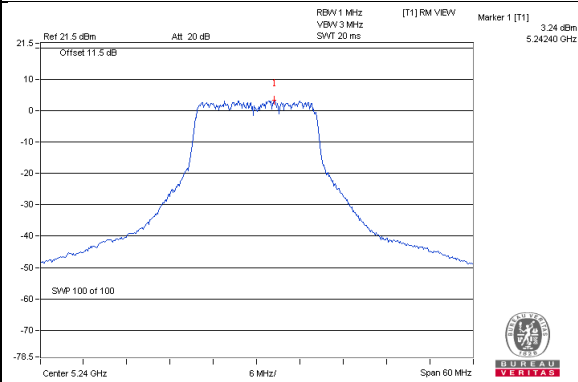

**802.11a (VHT20) / Chain 0 : CH36**

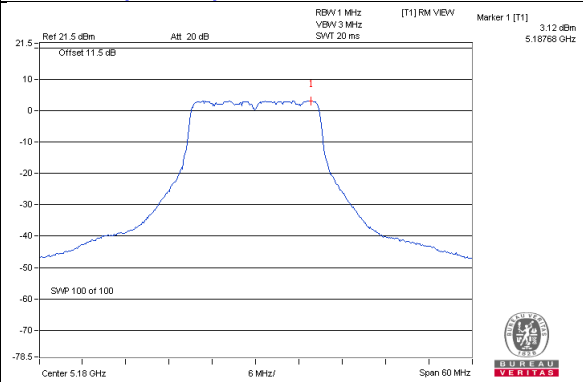

**802.11ac (VHT40) / Chain 2 : CH46**

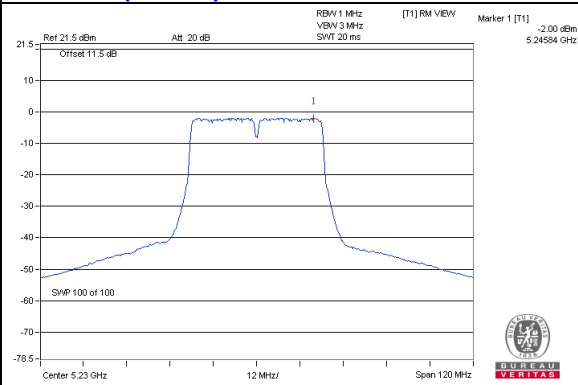

**802.11ac (VHT80) / Chain 0 : CH42**

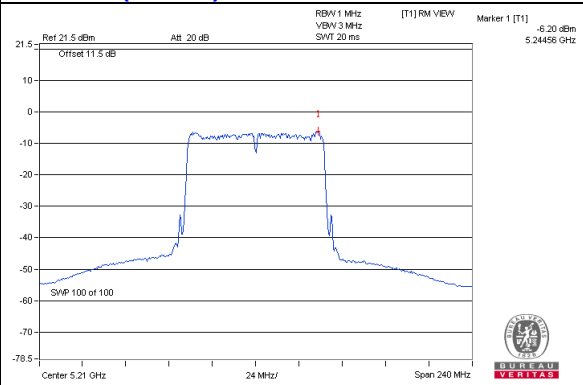



**For U-NII-3:**

**802.11a**

TX chain	Chan.	Chan. Freq. (MHz)	PSD W/O Duty Factor		10 log (N=4) dB	Duty Factor (dB)	Total PSD With Duty Factor (dBm/500kHz)	Limit (dBm/500kHz)	Pass /Fail
			(dBm/300kHz)	(dBm/500kHz)					
0	149	5745	-1.34	0.88	6.02	0.14	7.04	29.34	Pass
	157	5785	-1.31	0.91	6.02	0.14	7.07	29.34	Pass
	165	5825	-1.73	0.49	6.02	0.14	6.65	29.34	Pass
1	149	5745	-1.13	1.09	6.02	0.14	7.25	29.34	Pass
	157	5785	-1.07	1.15	6.02	0.14	7.31	29.34	Pass
	165	5825	-1.62	0.60	6.02	0.14	6.76	29.34	Pass
2	149	5745	-1.29	0.93	6.02	0.14	7.09	29.34	Pass
	157	5785	-1.97	0.25	6.02	0.14	6.41	29.34	Pass
	165	5825	-2.23	-0.01	6.02	0.14	6.15	29.34	Pass
3	149	5745	-1.80	0.42	6.02	0.14	6.58	29.34	Pass
	157	5785	-1.68	0.54	6.02	0.14	6.70	29.34	Pass
	165	5825	-1.79	0.43	6.02	0.14	6.59	29.34	Pass

Note: 1. Directional gain = 6.66dBi > 6dBi , so the power density limit shall be reduced to  $30-(6.66-6) = 29.34\text{dBm}$ .

2. Refer to section 3.3 for duty cycle spectrum plot.

### 802.11ac (VHT20)

TX chain	Channel	Freq. (MHz)	PSD (dBm/300kHz)	PSD (dBm/500kHz)	10 log (N=4) dB	Total PSD (dBm/500kHz)	Limit (dBm/500kHz)	Pass /Fail
0	149	5745	-1.17	1.05	6.02	7.07	29.34	Pass
	157	5785	-1.36	0.86	6.02	6.88	29.34	Pass
	165	5825	-1.68	0.54	6.02	6.56	29.34	Pass
1	149	5745	-1.27	0.95	6.02	6.97	29.34	Pass
	157	5785	-1.33	0.89	6.02	6.91	29.34	Pass
	165	5825	-1.77	0.45	6.02	6.47	29.34	Pass
2	149	5745	-1.09	1.13	6.02	7.15	29.34	Pass
	157	5785	-0.82	1.40	6.02	7.42	29.34	Pass
	165	5825	-0.62	1.60	6.02	7.62	29.34	Pass
3	149	5745	-1.45	0.77	6.02	6.79	29.34	Pass
	157	5785	-1.80	0.42	6.02	6.44	29.34	Pass
	165	5825	-1.96	0.26	6.02	6.28	29.34	Pass

Note: 1. Directional gain = 6.66dBi > 6dBi , so the power density limit shall be reduced to  $30-(6.66-6) = 29.34$ dBm.

### 802.11ac (VHT40)

TX chain	Channel	Freq. (MHz)	PSD (dBm/300kHz)	PSD (dBm/500kHz)	10 log (N=4) dB	Total PSD (dBm/500kHz)	Limit (dBm/500kHz)	Pass /Fail
0	151	5755	-4.29	-2.07	6.02	3.95	29.34	Pass
	159	5795	-4.39	-2.17	6.02	3.85	29.34	Pass
1	151	5755	-4.22	-2.00	6.02	4.02	29.34	Pass
	159	5795	-4.55	-2.33	6.02	3.69	29.34	Pass
2	151	5755	-3.73	-1.51	6.02	4.51	29.34	Pass
	159	5795	-3.61	-1.39	6.02	4.63	29.34	Pass
3	151	5755	-4.47	-2.25	6.02	3.77	29.34	Pass
	159	5795	-4.99	-2.77	6.02	3.25	29.34	Pass

Note: 1. Directional gain = 6.66dBi > 6dBi , so the power density limit shall be reduced to  $30-(6.66-6) = 29.34$ dBm.

### 802.11ac (VHT80)

TX chain	Channel	Freq. (MHz)	PSD (dBm/300kHz)	PSD (dBm/500kHz)	10 log (N=4) dB	Total PSD (dBm/500kHz)	Limit (dBm/500kHz)	Pass /Fail
0	155	5775	-8.47	-6.25	6.02	-0.23	29.34	Pass
1	155	5775	-8.47	-6.25	6.02	-0.23	29.34	Pass
2	155	5775	-7.99	-5.77	6.02	0.25	29.34	Pass
3	155	5775	-9.09	-6.87	6.02	-0.85	29.34	Pass

Note: 1. Directional gain = 6.66dBi > 6dBi , so the power density limit shall be reduced to  $30-(6.66-6) = 29.34\text{dBm}$ .

### Spectrum Plot of Worst Value

**802.11a / Chain 1 : CH157**

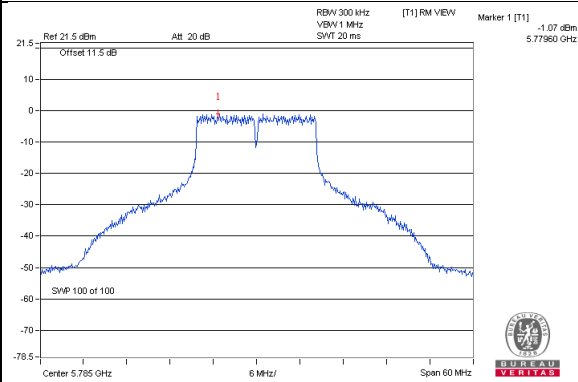

**802.11a (VHT20) / Chain 2 : CH165**

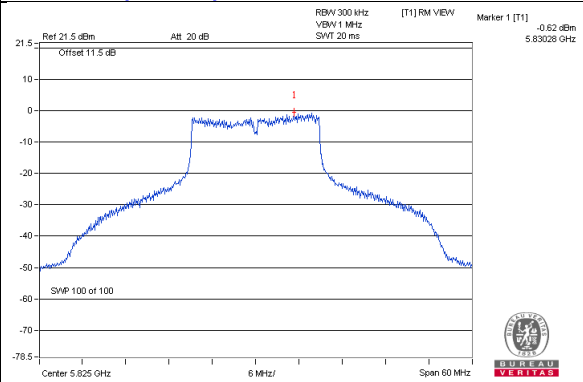

**802.11ac (VHT40) / Chain 2 : CH159**

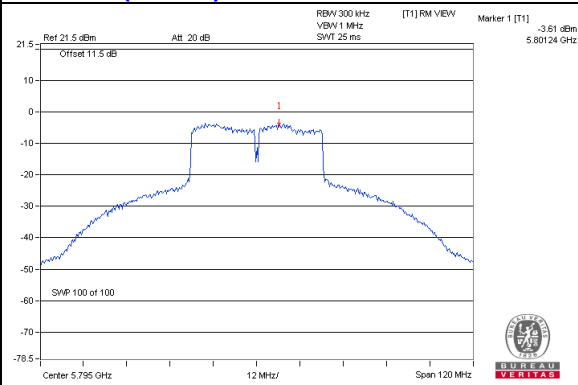

**802.11ac (VHT80) / Chain 2 : CH155**

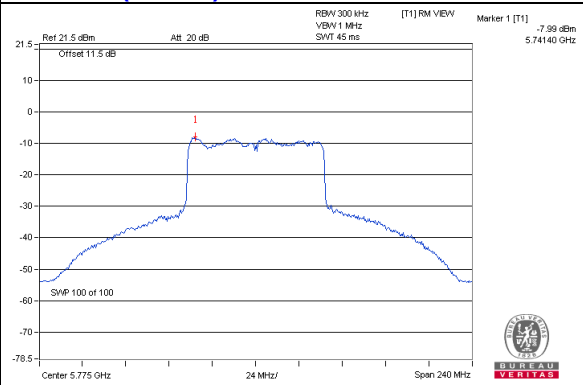

## 4.6 Frequency Stability Measurement

### 4.6.1 Limits of Frequency Stability Measurement

The frequency of the carrier signal shall be maintained within band of operation

### 4.6.2 Test Setup

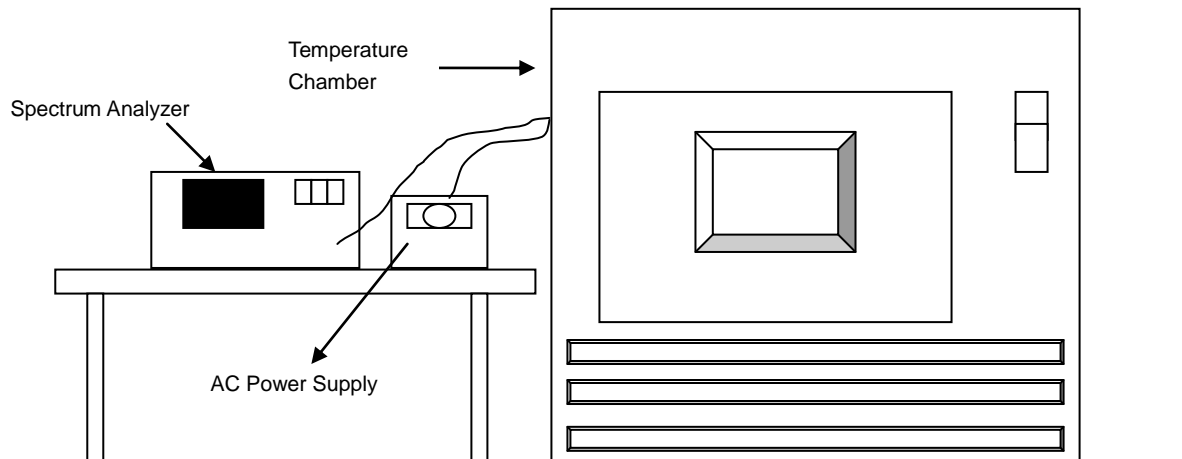

### 4.6.3 Test Instruments

Refer to section 4.1.2 to get information of above instrument.

### 4.6.4 Test Procedure

- The EUT was placed inside the environmental test chamber and powered by nominal AC voltage.
- Turn the EUT on and couple its output to a spectrum analyzer.
- Turn the EUT off and set the chamber to the highest temperature specified.
- Allow sufficient time (approximately 30 min) for the temperature of the chamber to stabilize, turn the EUT on and measure the operating frequency after 2, 5, and 10 Minutes.
- Repeat step 2 and 3 with the temperature chamber set to the lowest temperature.
- The test chamber was allowed to stabilize at +20 degree C for a minimum of 30 Minutes. The supply voltage was then adjusted on the EUT from 85% to 115% and the frequency record.

### 4.6.5 Deviation from Test Standard

No deviation.

### 4.6.6 EUT Operating Condition

Set the EUT transmit at un-modulation mode to test frequency stability.

#### 4.6.7 Test Results

Frequency Stability Versus Temp.									
Operating Frequency: 5180 MHz									
TEMP. (°C)	Power Supply (Vac)	0 Minute		2 Minutes		5 Minutes		10 Minutes	
		Measured Frequency (MHz)	Pass/Fail	Measured Frequency (MHz)	Pass/Fail	Measured Frequency (MHz)	Pass/Fail	Measured Frequency (MHz)	Pass/Fail
50	120	5180.0224	PASS	5180.0241	PASS	5180.0233	PASS	5180.0213	PASS
40	120	5179.9804	PASS	5179.9766	PASS	5179.9791	PASS	5179.9769	PASS
30	120	5179.9994	PASS	5179.9993	PASS	5179.996	PASS	5179.9972	PASS
20	120	5179.9862	PASS	5179.9844	PASS	5179.9818	PASS	5179.9849	PASS
10	120	5179.9873	PASS	5179.9878	PASS	5179.9884	PASS	5179.9891	PASS
0	120	5180.0076	PASS	5180.0089	PASS	5180.0086	PASS	5180.0088	PASS
-10	120	5180.0232	PASS	5180.0254	PASS	5180.0276	PASS	5180.0268	PASS
-20	120	5179.9902	PASS	5179.9932	PASS	5179.99	PASS	5179.9949	PASS
-30	120	5180.0036	PASS	5180.0049	PASS	5180.003	PASS	5180.0066	PASS

Frequency Stability Versus Voltage									
Operating Frequency: 5180 MHz									
TEMP. (°C)	Power Supply (Vac)	0 Minute		2 Minutes		5 Minutes		10 Minutes	
		Measured Frequency (MHz)	Pass/Fail	Measured Frequency (MHz)	Pass/Fail	Measured Frequency (MHz)	Pass/Fail	Measured Frequency (MHz)	Pass/Fail
20	138	5179.9872	PASS	5179.9836	PASS	5179.9816	PASS	5179.9845	PASS
	120	5179.9862	PASS	5179.9844	PASS	5179.9818	PASS	5179.9849	PASS
	102	5179.9857	PASS	5179.9835	PASS	5179.9826	PASS	5179.9844	PASS

## 4.7 6dB Bandwidth Measurement

### 4.7.1 Limits of 6dB Bandwidth Measurement

The minimum of 6dB Bandwidth Measurement is 0.5MHz.

### 4.7.2 Test Setup

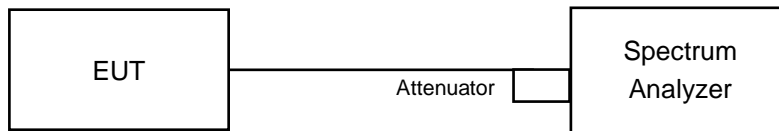

### 4.7.3 Test Instruments

Refer to section 4.1.2 to get information of above instrument.

### 4.7.4 Test Procedure

#### MEASUREMENT PROCEDURE REF

- a. Set resolution bandwidth (RBW) = 100kHz
- b. Set the video bandwidth (VBW)  $\geq 3 \times$  RBW, Detector = Peak.
- c. Trace mode = max hold.
- d. Sweep = auto couple.
- e. Measure the maximum width of the emission that is constrained by the frequencies associated with the two amplitude points (upper and lower) that are attenuated by 6 dB relative to the maximum level measured in the fundamental emission

### 4.7.5 Deviation from Test Standard

No deviation.

### 4.7.6 EUT Operating Condition

The software provided by client to enable the EUT under transmission condition continuously at lowest, middle and highest channel frequencies individually.

#### 4.7.7 Test Results

##### 802.11a

Channel	Frequency (MHz)	6dB Bandwidth (MHz)				Minimum Limit (MHz)	Pass / Fail
		Chain 0	Chain 1	Chain 2	Chain 3		
149	5745	16.42	16.43	16.43	16.43	0.5	PASS
157	5785	16.41	16.41	16.42	16.44	0.5	PASS
165	5825	16.41	16.41	16.42	16.42	0.5	PASS

##### 802.11ac (VHT20)

Channel	Frequency (MHz)	6dB Bandwidth (MHz)				Minimum Limit (MHz)	Pass / Fail
		Chain 0	Chain 1	Chain 2	Chain 3		
149	5745	17.66	17.69	17.68	17.69	0.5	PASS
157	5785	17.67	17.68	17.69	17.69	0.5	PASS
165	5825	17.67	17.69	17.67	17.71	0.5	PASS

##### 802.11ac (VHT40)

Channel	Frequency (MHz)	6dB Bandwidth (MHz)				Minimum Limit (MHz)	Pass / Fail
		Chain 0	Chain 1	Chain 2	Chain 3		
151	5755	36.48	36.48	36.38	36.47	0.5	PASS
159	5795	36.52	36.49	36.39	36.45	0.5	PASS

##### 802.11ac (VHT80)

Channel	Frequency (MHz)	6dB Bandwidth (MHz)				Minimum Limit (MHz)	Pass / Fail
		Chain 0	Chain 1	Chain 2	Chain 3		
155	5775	74.62	75.66	75.44	75.34	0.5	PASS



Spectrum Plot of Worst Value

802.11a\_Chain 0 / CH157

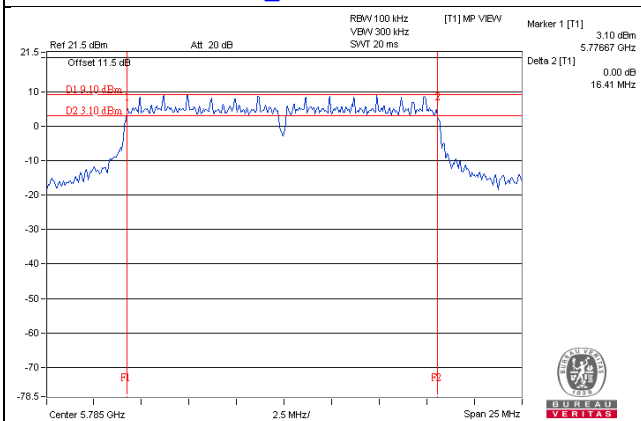

802.11ac (VHT20)\_Chain 0 / CH149

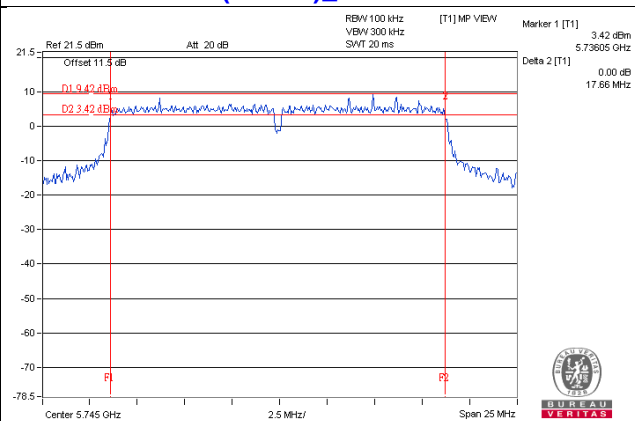

802.11ac (VHT40)\_Chain 2 / CH151

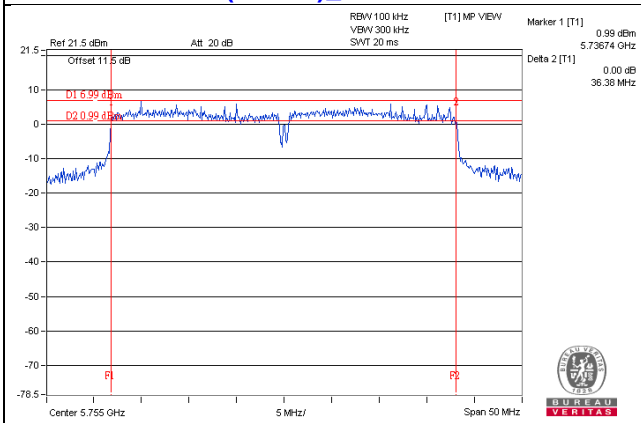

802.11ac (VHT80)\_Chain 0 / CH155

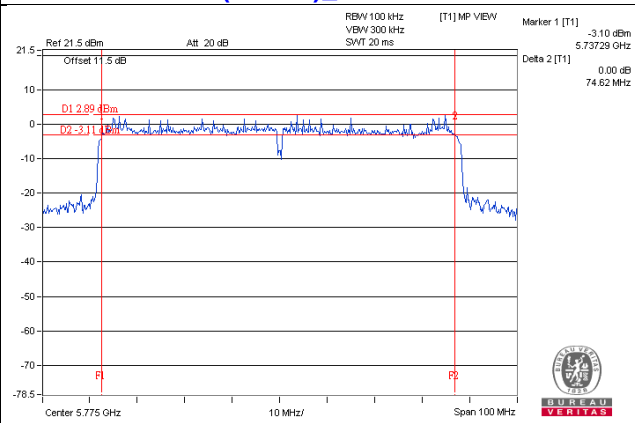

## 5 Pictures of Test Arrangements

Please refer to the attached file (Test Setup Photo).

### Annex A- Radiated Out of Band Emission (OOBE) Measurement (For U-NII-3 band)

802.11a

**CH 149 5745 MHz**

**Horizontal**

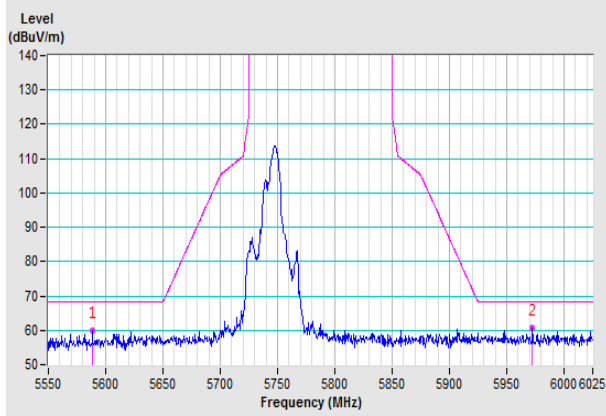

**Vertical**

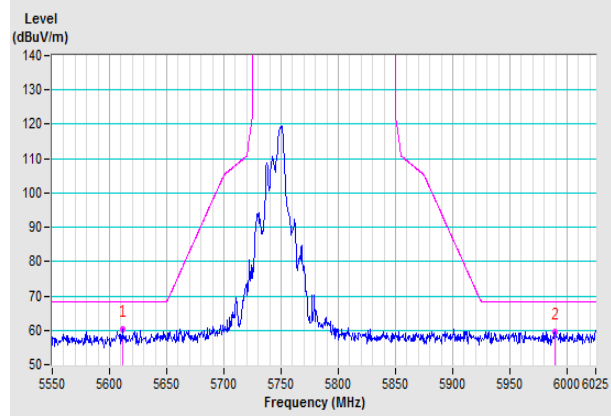

**CH 157 5785 MHz**

**Horizontal**

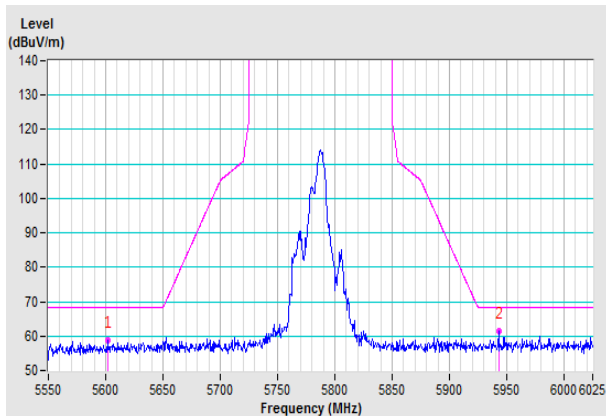

**Vertical**

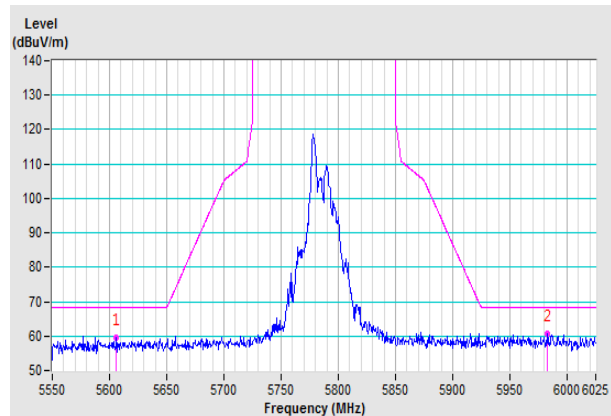

**CH 165 5825 MHz**

**Horizontal**

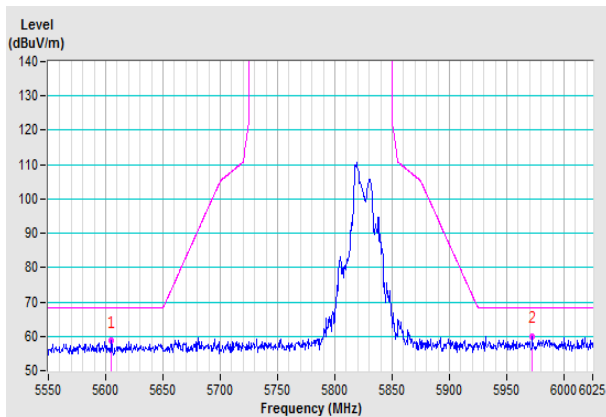

**Vertical**

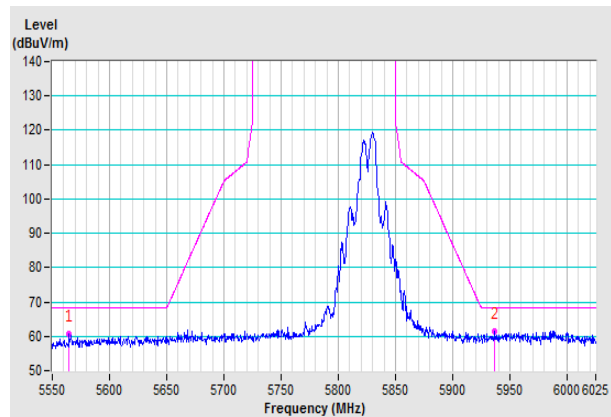

802.11ac (VHT20)

CH 149 5745 MHz

Horizontal

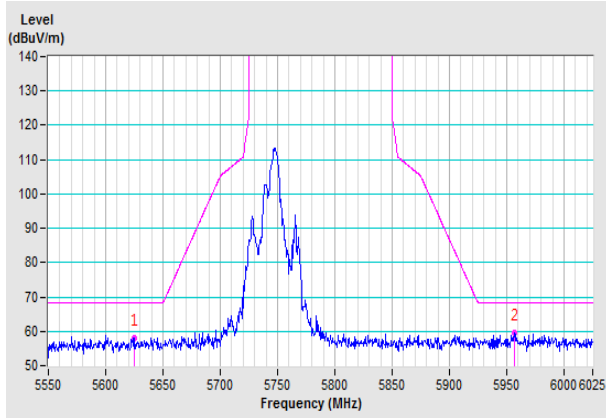

Vertical

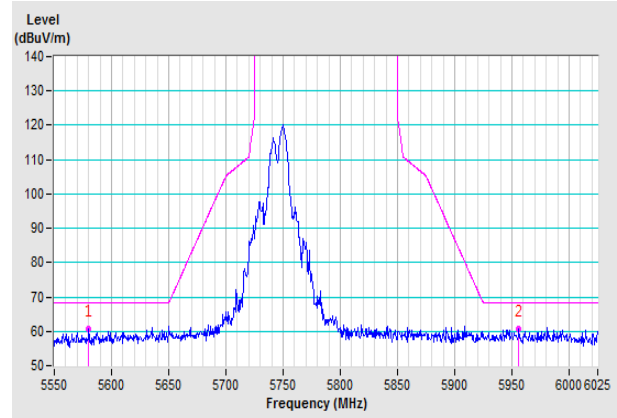

CH 157 5785 MHz

Horizontal

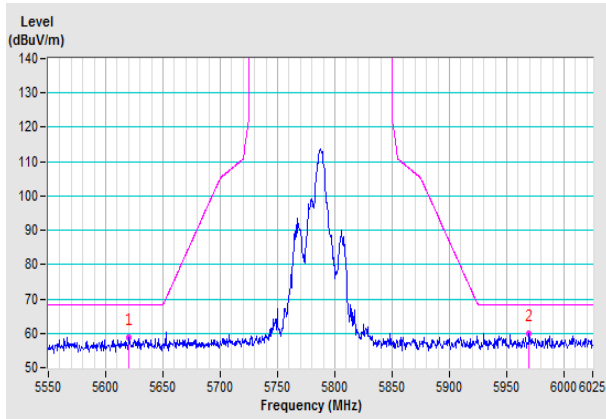

Vertical

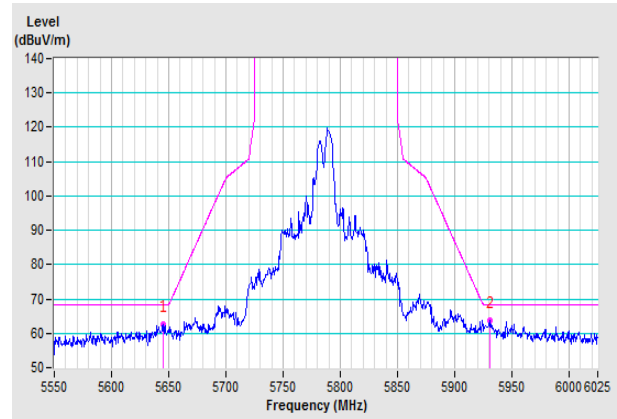

CH 165 5825 MHz

Horizontal

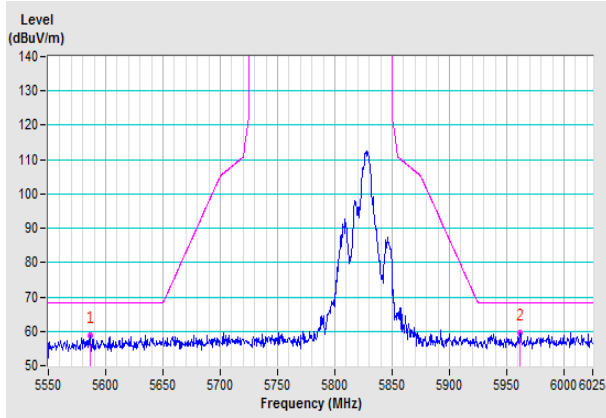

Vertical

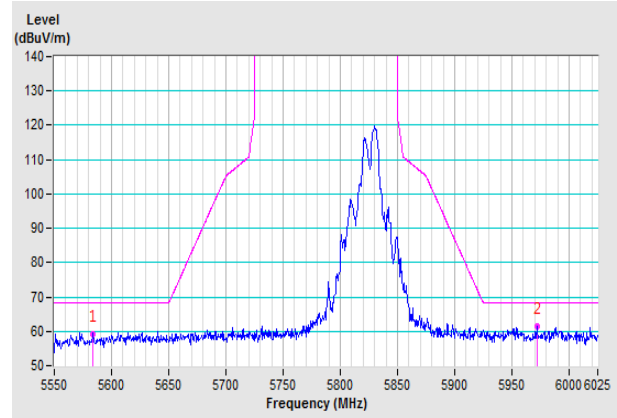

802.11ac (VHT40)

CH 151 5755 MHz

Horizontal

Vertical

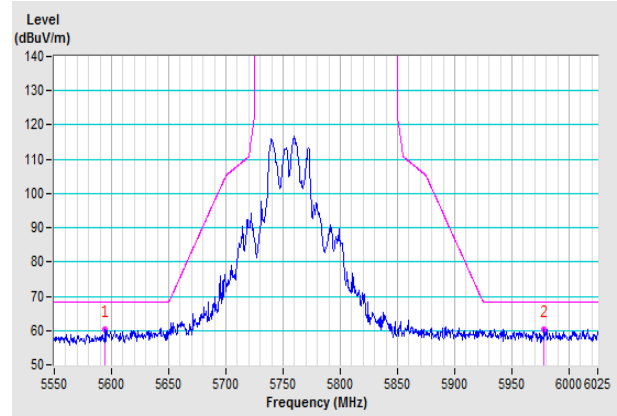
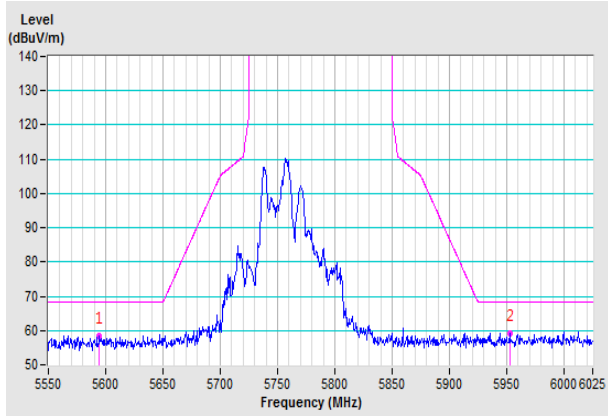

CH 159 5795 MHz

Horizontal

Vertical

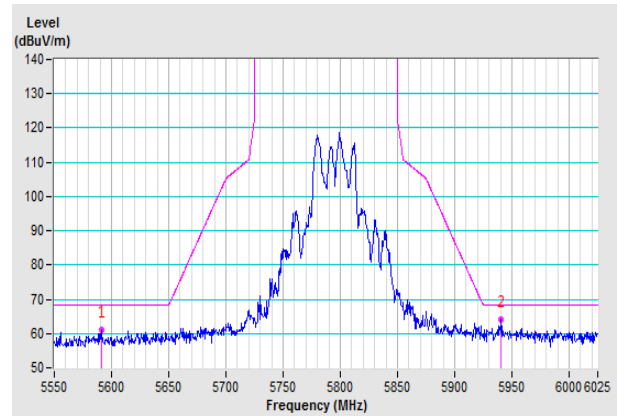
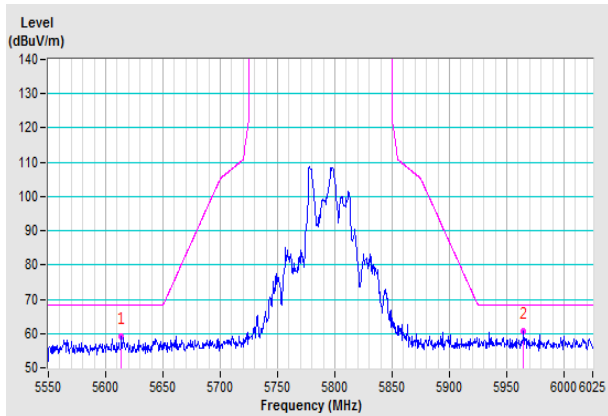

802.11ac (VHT80)

CH 155 5775 MHz

Horizontal

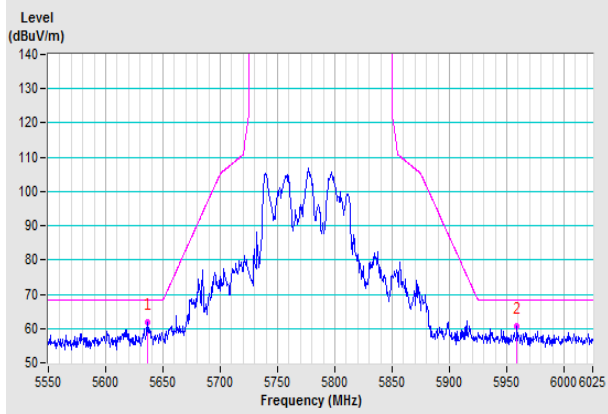

Vertical

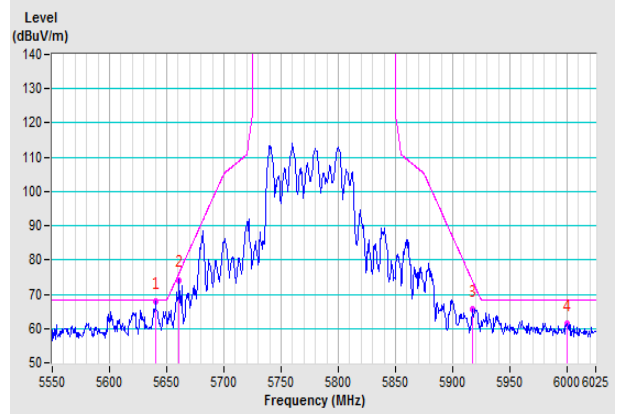

## Appendix – Information on the Testing Laboratories

We, Bureau Veritas Consumer Products Services (H.K.) Ltd., Taoyuan Branch, were founded in 1988 to provide our best service in EMC, Radio, Telecom and Safety consultation. Our laboratories are FCC recognized accredited test firms and accredited according to ISO/IEC 17025.

If you have any comments, please feel free to contact us at the following:

**Linko EMC/RF Lab**

Tel: 886-2-26052180

Fax: 886-2-26051924

**Hsin Chu EMC/RF/Telecom Lab**

Tel: 886-3-6668565

Fax: 886-3-6668323

**Hwa Ya EMC/RF/Safety Lab**

Tel: 886-3-3183232

Fax: 886-3-3270892

**Email:** [service.adt@tw.bureauveritas.com](mailto:service.adt@tw.bureauveritas.com)

**Web Site:** [www.bureauveritas-adt.com](http://www.bureauveritas-adt.com)

The address and road map of all our labs can be found in our web site also.

--- END ---