



# TEST REPORT

**APPLICANT** : Fibocom Wireless Inc.  
**PRODUCT NAME** : LTE Module  
**MODEL NAME** : SC218-NA  
**BRAND NAME** : Fibocom  
**FCC ID** : ZMOSC218NA  
**STANDARD(S)** : 47 CFR Part 15 Subpart E  
**RECEIPT DATE** : 2023-08-29  
**TEST DATE** : 2023-09-07 to 2023-10-07  
**ISSUE DATE** : 2023-10-23



Edited by: Peng Mi  
Peng Mi (Rapporteur)  
Approved by: Shen Junsheng  
Shen Junsheng (Supervisor)

**NOTE:** This document is issued by Shenzhen Morlab Communications Technology Co., Ltd., the test report shall not be reproduced except in full without prior written permission of the company. The test results apply only to the particular sample(s) tested and to the specific tests carried out which is available on request for validation and information confirmed at our website.





# DIRECTORY

- 1. Summary of Test Result ..... 4
- 1.1. Testing Applied Standards ..... 5
- 1.2. Test Equipment List ..... 6
- 1.3. Measurement Uncertainty ..... 8
- 1.4. Testing Laboratory ..... 8
- 2. General Description ..... 9
- 2.1. Information of Applicant and Manufacturer ..... 9
- 2.2. Information of EUT ..... 9
- 2.3. Channel List of EUT ..... 10
- 2.4. Test Configuration of EUT ..... 11
- 2.5. Test Conditions ..... 11
- 2.6. Test Setup Layout Diagram ..... 12
- 3. Test Results ..... 15
- 3.1. Antenna Requirement ..... 15
- 3.2. Duty Cycle of Test Signal ..... 16
- 3.3. Maximum Conducted Output Power ..... 17
- 3.4. Emission Bandwidth ..... 19
- 3.5. Peak Power Spectral Density ..... 21
- 3.6. Frequency Stability ..... 22
- 3.7. Dynamic Frequency Selection ..... 23
- 3.8. Conducted Emission ..... 28
- 3.9. Restricted Frequency Bands ..... 29
- 3.10. Radiated Emission ..... 31
- Annex A Test Data and Result ..... 33



Change History		
Version	Date	Reason for change
1.0	2023-10-23	First edition

# 1. Summary of Test Result

No.	Section	Description	Test Date	Test Engineer	Result	Method Determination /Remark
1	15.203	Antenna Requirement	N/A	N/A	PASS	No deviation
2	ANSI C63.10	Duty Cycle of the Test Signal	Sep. 19, 2023	He Yuyang	PASS	No deviation
3	15.407(a)	Maximum Conducted Output Power	Sep. 19, 2023	He Yuyang	PASS	No deviation
4	15.407(a)(e)	Emission Bandwidth	Sep. 19, 2023	He Yuyang	PASS	No deviation
5	15.407(a)	Peak Power Spectral Density	Sep. 19, 2023	He Yuyang	PASS	No deviation
6	15.407(g)	Frequency Stability	Sep. 19, 2023	He Yuyang	PASS	No deviation
7	15.407(h)	DFS	Sep. 19, 2023	He Yuyang	PASS	No deviation
8	15.207	Conducted Emission	Sep. 18, 2023	Wang Deyong	PASS	No deviation
9	15.407(b)	Restricted Frequency Bands	Oct. 07, 2023	Gao Jianrou	PASS	No deviation
10	15.407(b)	Radiated Emission	Oct. 07, 2023	Gao Jianrou	PASS	No deviation

**Note 1:** The tests of Conducted Emission and Radiated Emission were performed according to the method of measurements prescribed in ANSI C63.102013.

**Note 2:** These RF tests were performed according to the method of measurements prescribed in KDB789033 D02 v02r01.

**Note 3:** These RF tests were performed according to the method of measurements prescribed in KDB 905462 D02 UNII DFS Compliance Procedures New Rules v02.

**Note 4:** Additions to, deviation, or exclusions from the method shall be judged in the "method determination" column of add, deviate or exclude from the specific method shall be explained in the "Remark" of the above table.

**Note 5:** When the test result is a critical value, we will use the measurement uncertainty give the judgment result based on the 95% confidence intervals.



## 1.1. Testing Applied Standards

According to the specifications of the manufacturer, the EUT must comply with the requirements of the following standards:

- 47 CFR Part 15 Subpart E Radio Frequency Devices



## 1.2. Test Equipment List

### 1.2.1 Conducted Test Equipments

Equipment Name	Serial No.	Type	Manufacturer	Cal. Date	Due Date
EXA Signal Analyzer	MY53470836	N9010A	Agilent	2023.02.27	2024.02.26
USB Wideband Power Sensor	MY54180008	U2021XA	Agilent	2022.10.11	2023.10.10
				2023.09.19	2024.09.18
Temperature Chamber	12108015	DTL-003S 101	YOMA	2022.10.10	2023.10.09
				2023.09.19	2024.09.18
RF Cable (30MHz-26GHz)	CB01	RF01	Morlab	N/A	N/A
Coaxial Cable	CB02	RF02	Morlab	N/A	N/A
SMA Connector	CN01	RF03	HUBER-SUHNER	N/A	N/A
Attenuator	MTJ6004-10	10dB	MTJ cooperation	N/A	N/A

### 1.2.2 Conducted Emission Test Equipments

Equipment Name	Serial No.	Type	Manufacturer	Cal. Date	Due Date
Receiver	MY56400093	N9038A	KEYSIGHT	2023.02.09	2024.02.08
LISN	8127449	NSLK 8127	Schwarzbeck	2023.02.21	2024.02.20
Pulse Limiter (10dB)	VTSD 9561 F-B #206	VTSD 9561-F	Schwarzbeck	2023.06.27	2024.06.26
RF Coaxial Cable (DC-100MHz)	BNC	MRE04	Qualwave	N/A	N/A

### 1.2.3 List of Software Used

Description	Manufacturer	Software Version
Test System	MaiWei	2.0.0.0
Morlab EMCR	Morlab	V1.2
TS+ -[JS32-CE]	Tonscend	V2.5.0.0

**1.2.4 Radiated Test Equipments**

Equipment Name	Serial No.	Type	Manufacturer	Cal. Date	Due Date
Receiver	MY54130016	N9038A	Agilent	2023.06.21	2024.06.20
Test Antenna - Bi-Log	9163-519	VULB 9163	Schwarzbeck	2022.05.25	2025.05.24
Test Antenna - Loop	1519-022	FMZB1519	Schwarzbeck	2022.02.11	2025.02.10
Test Antenna – Horn	01774	BBHA 9120D	Schwarzbeck	2022.07.13	2025.07.12
Test Antenna – Horn	BBHA9170 #773	BBHA9170	Schwarzbeck	2022.07.14	2025.07.13
Preamplifier (10MHz-6GHz)	46732	S10M100L38 02	LUCIX CORP.	2023.06.27	2024.06.26
Preamplifier (2GHz-18GHz)	61171/61172	S020180L32 03	LUCIX CORP.	2023.06.27	2024.06.26
Preamplifier (18GHz-40GHz)	DS77209	DCLNA0118-40C-S	Decentest	2023.07.04	2024.07.03
RF Coaxial Cable (DC-18GHz)	MRE001	PE330	Pasternack	2023.06.27	2024.06.26
RF Coaxial Cable (DC-18GHz)	MRE002	CLU18	Pasternack	2023.06.27	2024.06.26
RF Coaxial Cable (DC-18GHz)	MRE003	CLU18	Pasternack	2023.06.27	2024.06.26
RF Coaxial Cable (DC-40GHz)	22290045	QA360-40-K K-0.5	Qualwave	2023.07.04	2024.07.03
RF Coaxial Cable (DC-40GHz)	22290046	QA360-40-K KF-2	Qualwave	2023.07.04	2024.07.03
RF Coaxial Cable (DC-18GHz)	22120181	QA500-18-N N-5	Qualwave	2023.07.04	2024.07.03
Notch Filter	N/A	WRCG-5150-5350	Wainwright	N/A	N/A
Notch Filter	N/A	WRCG-5470-5725	Wainwright	N/A	N/A
Notch Filter	N/A	WRCG-5725-5850	Wainwright	N/A	N/A
Anechoic Chamber	N/A	9m*6m*6m	CRT	2022.05.10	2025.05.09



### 1.3. Measurement Uncertainty

Test Items	Uncertainty	Remark
Peak Output Power	±2.22dB	Confidence levels of 95%
Power Spectral Density	±2.22dB	Confidence levels of 95%
Bandwidth	±5%	Confidence levels of 95%
Restricted Frequency Bands	±5%	Confidence levels of 95%
Radiated Emission	±2.95dB	Confidence levels of 95%
Conducted Emission	±2.44dB	Confidence levels of 95%

### 1.4. Testing Laboratory

<b>Laboratory Name</b>	Shenzhen Morlab Communications Technology Co., Ltd.
<b>Laboratory Address</b>	FL.3, Building A, FeiYang Science Park, No.8 LongChang Road, Block 67, BaoAn District, ShenZhen, GuangDong Province, P. R. China
<b>Telephone</b>	+86 755 36698555
<b>Facsimile</b>	+86 755 36698525
<b>FCC Designation Number</b>	CN1192
<b>FCC Test Firm Registration Number</b>	226174





## 2. General Description

### 2.1. Information of Applicant and Manufacturer

<b>Applicant</b>	Fibocom Wireless Inc.
<b>Applicant Address</b>	1101, Tower A, Building 6, Shenzhen International Innovation Valley, Dashi 1st Rd, Nanshan, Shenzhen, China
<b>Manufacturer</b>	Fibocom Wireless Inc.
<b>Manufacturer Address</b>	1101, Tower A, Building 6, Shenzhen International Innovation Valley, Dashi 1st Rd, Nanshan, Shenzhen, China

### 2.2. Information of EUT

<b>Product Name:</b>	LTE Module
<b>Sample No.:</b>	1#
<b>Hardware Version:</b>	V1.1
<b>Software Version:</b>	SC218-T6.00.03
<b>Modulation Technology:</b>	OFDM
<b>Modulation Mode:</b>	802.11a, 802.11n (HT20), 802.11n (HT40) 802.11ac (VHT20), 802.11ac (VHT40), 802.11ac (VHT80)
<b>Operating Frequency Range:</b>	5180MHz-5240MHz; 5260MHz-5320MHz; 5500MHz-5720MHz; 5745MHz-5825MHz
<b>Antenna Type:</b>	Fixed External Antenna
<b>Antenna Gain:</b>	2.00dBi

**Note 1:** We use the dedicated software to control the EUT continuous transmission.

**Note 2:** For a more detailed description, please refer to Specification or User's Manual supplied by the applicant and/or manufacturer.

## 2.3. Channel List of EUT

<b>(U-NII-1) 5180MHz-5240MHz</b>				
Bandwidth	Channel	Frequency (MHz)	Channel	Frequency (MHz)
20MHz	<b>36</b>	<b>5180</b>	40	5200
	<b>44</b>	<b>5220</b>	<b>48</b>	<b>5240</b>
40MHz	<b>38</b>	<b>5190</b>	<b>46</b>	<b>5230</b>
80MHz	<b>42</b>	<b>5210</b>		
<b>(U-NII-2A) 5260MHz-5320MHz</b>				
Bandwidth	Channel	Frequency (MHz)	Channel	Frequency (MHz)
20MHz	<b>52</b>	<b>5260</b>	56	5280
	<b>60</b>	<b>5300</b>	<b>64</b>	<b>5320</b>
40MHz	<b>54</b>	<b>5270</b>	<b>62</b>	<b>5310</b>
80MHz	<b>58</b>	<b>5290</b>		
<b>(U-NII-2C) 5500MHz-5720MHz</b>				
Bandwidth	Channel	Frequency (MHz)	Channel	Frequency (MHz)
20MHz	<b>100</b>	<b>5500</b>	105	5520
			108	5540
			116	5580
			124	5620
			132	5660
			140	5700
40MHz	<b>102</b>	<b>5510</b>	110	5550
			118	5590
			134	5670
80MHz	<b>106</b>	<b>5530</b>	<b>122</b>	<b>5610</b>
	<b>138</b>	<b>5690</b>		
<b>(U-NII-3) 5745MHz-5825MHz</b>				
Bandwidth	Channel	Frequency (MHz)	Channel	Frequency (MHz)
20MHz	<b>149</b>	<b>5745</b>	153	5765
	<b>157</b>	<b>5785</b>	161	5805
	<b>165</b>	<b>5825</b>		
40MHz	<b>151</b>	<b>5775</b>	<b>159</b>	<b>5795</b>
80MHz	<b>155</b>	<b>5775</b>		

**Note 1:** The black bold channels were selected for test.



## 2.4. Test Configuration of EUT

### 2.4.1. Modulation Type and Data Rate of EUT

Mode	Bandwidth (MHz)	Modulation Technology	Modulation Type	Data Rate	RU Size
802.11a	20	OFDM	<b>DBPSK</b>	6/9/12/18/24/36/ 48/54Mbps	N/A
			DQPSK		
			CCK		
802.11n	20/40 (HT20/40)	OFDM	<b>BPSK</b>	<b>MCS0~MCS7</b>	N/A
			QPSK		
			16QAM		
			64QAM		
802.11ac	20/40/80 (VHT20/40/80)	OFDM	<b>BPSK</b>	<b>MCS0~MCS9</b>	N/A
			QPSK		
			16QAM		
			64QAM		
			256QAM		

**Note1:** The worst-case mode (bold face) in all data rates has been determined during the pre-scan, only the test data of the worst-case were recorded in this report.

## 2.5. Test Conditions

Temperature (°C)	15-35
Relative Humidity (%)	30-60
Atmospheric Pressure (kPa)	86-106

## 2.6. Test Setup Layout Diagram

### 2.6.1. Conducted Measurement

For power item that BW below 80MHz system:



For power item that BW equal or above 80MHz and other items:

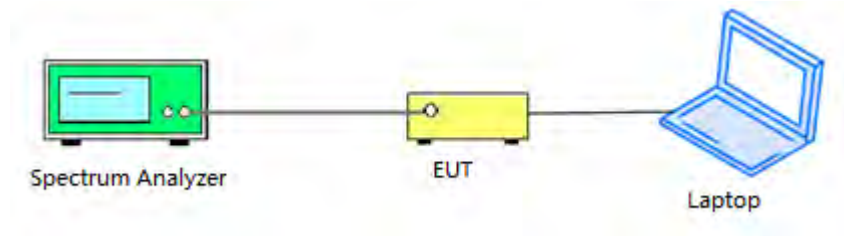

### 2.6.2. Conducted Emission Measurement



### 2.6.3.Radiation Measurement

1) For radiated emissions from 9kHz to 30MHz



2) For radiated emissions from 30MHz to 1GHz



3) For radiated emissions above 1GHz





## 3. Test Results

### 3.1. Antenna Requirement

#### 3.1.1. Requirement

According to FCC 15.203, an intentional radiator shall be designed to ensure that no antenna other than that furnished by the responsible party shall be used with the device. The use of a permanently attached antenna or of an antenna that uses a unique coupling to the intentional radiator shall be considered sufficient to comply with the provisions of this section.

#### 3.1.2. Test Result

The EUT has a permanently and irreplaceable attached antenna. Please refer to the EUT internal photos.



## 3.2. Duty Cycle of Test Signal

### 3.2.1. Requirement

Preferably, all measurements of maximum conducted (average) output power will be performed with the EUT transmitting continuously (i.e., with a duty cycle of greater than or equal to 98%). When continuous operation cannot be realized, then the use of sweep triggering/signal gating techniques can be used to ensure that measurements are made only during transmissions at the maximum power control level. Such sweep triggering/signal gating techniques will require knowledge of the minimum transmission duration ( $T$ ) over which the transmitter is on and is transmitting at its maximum power control level for the tested mode of operation. Sweep triggering/signal gating techniques can then be used if the measurement/sweep time of the analyzer can be set such that it does not exceed  $T$  at any time that data are being acquired (i.e., no transmitter OFF-time is to be considered).

When continuous transmission cannot be achieved and sweep triggering/signal gating cannot be implemented, alternative procedures are provided that can be used to measure the average power; however, they will require an additional measurement of the transmitter duty cycle ( $D$ ). Within this sub clause, the duty cycle refers to the fraction of time over which the transmitter is ON and is transmitting at its maximum power control level. The duty cycle is considered to be constant if variations are less than  $\pm 2\%$ ; otherwise, the duty cycle is considered to be non constant.

### 3.2.2. Test Result

Refer to Annex A.1 in this report.





### 3.3. Maximum Conducted Output Power

#### 3.3.1. Requirement

(1) For client devices in the 5.15-5.25 GHz band, the maximum conducted output power over the frequency band of operation shall not exceed 250mW provided the maximum antenna gain does not exceed 6dBi.

(2) For the 5.25-5.35 GHz and 5.47-5.725 GHz bands, the maximum conducted output power over the frequency bands of operation shall not exceed the lesser of 250mW or  $11\text{dBm} + 10 \log B$ , where B is the 26 dB emission bandwidth in megahertz.

(3) For the band 5.725-5.85 GHz, the maximum conducted output power over the frequency band of operation shall not exceed 1 W.

If transmitting antennas of directional gain greater than 6dBi are used, the maximum conducted output power shall be reduced by the amount in dB that the directional gain of the antenna exceeds 6dBi.

(4) According to KDB662911D01 Measure-and-sum technique, the conducted emission level (e.g., transmit power or power in specified bandwidth) is measured at each antenna port. The measured results at the various antenna ports are then summed mathematically to determine the total emission level from the device. Summing is performed in units that are directly proportional to power.

(5) According to KDB 662911 D01, the directional gain =  $G_{\text{ANT}} + 10\log(N_{\text{ANT}})\text{dBi}$ , where  $G_{\text{ANT}}$  is the antenna gain in dBi,  $N_{\text{ANT}}$  is the number of outputs.

#### 3.3.2. Test Procedures

The EUT (Equipment under the test) which is coupled to the USB Wideband Power Sensor; the RF load attached to the EUT antenna terminal is 50Ohm; the path loss as the factor is calibrated to correct the reading, all test result in USB Wideband Power Sensor.

##### For ac (VHT80) mode power

The EUT (Equipment under the test) is coupled to the Spectrum analyzer; the RF load attached to the EUT antenna terminal is 50Ohm; the path loss as the factor is calibrated to correct the reading, all test result in Spectrum analyzer.



### **3.3.3. Test Setup Layout**

Refer to chapter 2.6.1 in this report.

### **3.3.4. Test Result**

Refer to Annex A.2 in this report.



## 3.4. Emission Bandwidth

### 3.4.1. Requirement

For purposes of this subpart the emission bandwidth shall be determined by measuring the width of the signal between two points, one below the carrier center frequency and one above the carrier center frequency, that are 26 dB down relative to the maximum level of the modulated carrier. Determination of the emissions bandwidth is based on the use of measurement instrumentation employing a peak detector function with an instrument resolution bandwidth approximately equal to 1.0 percent of the emission bandwidth of the device under measurement. Within the 5.725-5.85 GHz band, the minimum 6 dB bandwidth of U-NII devices shall be at least 500 kHz.

### 3.4.1. Test Procedures

1. KDB 789033 Section C) 1) Emission Bandwidth was used in order to prove compliance
  - a) Set RBW = approximately 1% of the emission bandwidth.
  - b) Set VBW > RBW.
  - c) Detector = Peak.
  - d) Trace mode = max hold.
  - e) Measure the maximum width of the emission that is 26 dB down from the peak of the emission. Compare this with the RBW setting of the analyzer. Readjust RBW and repeat measurement as needed until the RBW/EBW ratio is approximately 1%.
2. KDB 789033 Section C) 2) minimum emission bandwidth for the band 5.725-5.85GHz was used in order to prove compliance.

Section 15.407(e) specifies the minimum 6 dB emission bandwidth of at least 500 KHz for theband5.715-5.85 GHz. The following procedure shall be used for measuring this bandwidth:

  - a) Set RBW = 100 kHz.
  - b) Set video bandwidth (VBW)  $\geq 3 \times$  RBW.
  - c) Detector = Peak.
  - d) Trace mode = max hold.
  - e) Sweep = auto couple.
  - f) Allow the trace to stabilize.
  - g) Measure the maximum width of the emission that is constrained by the frequencies associated with the two outermost amplitude points (upper and lower frequencies) that are attenuated by 6 dB relative to the maximum level measured in the fundamental emission.



### **3.4.2. Test Setup Layout**

Refer to chapter 2.6.1 in this report.

### **3.4.3. Test Result**

Refer to Annex A.3 in this report.





## 3.5. Peak Power Spectral Density

### 3.5.1. Requirement

(1) For client devices in the 5.15-5.25 GHz band, the maximum power spectral density shall not exceed 11dBm in any 1 megahertz band.

(2) For the 5.25-5.35 GHz and 5.47-5.725 GHz bands, the maximum power spectral density shall not exceed 11dBm in any 1 megahertz band.

(3) For the band 5.725-5.85 GHz, the maximum power spectral density shall not exceed 30dBm in any 500kHz band.

If transmitting antennas of directional gain greater than 6dBi are used, the maximum power spectral density shall be reduced by the amount in dB that the directional gain of the antenna exceeds 6dBi.

(4) According to KDB662911D01 Measure-and-sum technique, the conducted emission level (e.g., transmit power or power in specified bandwidth) is measured at each antenna port. The measured results at the various antenna ports are then summed mathematically to determine the total emission level from the device. Summing is performed in units that are directly proportional to power.

(5) According to KDB 662911 D01, the directional gain =  $G_{ANT} + 10\log(N_{ANT})$  dBi, where  $G_{ANT}$  is the antenna gain in dBi,  $N_{ANT}$  is the number of outputs.

### 3.5.2. Test Procedures

KDB 789033 Section F) Maximum Power Spectral Density (PSD) Method SA-3 was used in order to prove compliance

- 1) Set span to encompass the entire 26-dB emission bandwidth
- 2) Set RBW = 1MHz. Set VBW  $\geq$  3MHz
- 3) Number of points in sweep  $\geq$  2 Span / RBW. Sweep time = auto
- 4) Detector = Average
- 5) Trace mode=Max hold

Record the max value

### 3.5.3. Test Setup Layout

Refer to chapter 2.6.1 in this report.

### 3.5.4. Test Result

Refer to Annex A.4 in this report.



## 3.6. Frequency Stability

### 3.6.1. Requirement

Manufacturers of U-NII devices are responsible for ensuring frequency stability such that an emission is maintained within the band of operation under all conditions of normal operation as specified in the user's manual.

### 3.6.2. Test Procedures

The EUT was placed inside of an environmental chamber as the temperature in the chamber was varied between 5°C to 40°C. The temperature was incremented by 10° intervals and the unit was allowed to stabilize at each temperature before each measurement. The center frequency of the transmitting channel was evaluated at each temperature and the frequency deviation from the channel's center frequency was recorded. Data for the worst case channel is shown below.

### 3.6.3. Test Result

Refer to Annex A.5 in this report.



### 3.7. Dynamic Frequency Selection

#### 3.7.1. Requirement

According to FCC section 15.407(h), (1) Transmit power control (TPC). U-NII devices operating in the 5.25-5.35 GHz band and the 5.47-5.725 GHz band shall employ a TPC mechanism. The U-NII device is required to have the capability to operate at least 6 dB below the mean EIRP value of 30 dBm. A TPC mechanism is not required for systems with an e.i.r.p. of less than 500 mW. (2) Radar Detection Function of Dynamic Frequency Selection (DFS). U-NII devices operating with any part of its 26 dB emission bandwidth in the 5.25-5.35 GHz and 5.47-5.725 GHz bands shall employ a DFS radar detection mechanism to detect the presence of radar systems and to avoid co-channel operation with radar systems. Operators shall only use equipment with a DFS mechanism that is turned on when operating in these bands. The device must sense for radar signals at 100 percent of its emission bandwidth. The minimum DFS detection threshold for devices with a maximum e.i.r.p. of 200 mW to 1 W is -64 dBm. For devices that operate with less than 200 mW e.i.r.p. and a power spectral density of less than 10 dBm in a 1 MHz band, the minimum detection threshold is -62 dBm. The detection threshold is the received power averaged over 1 microsecond referenced to a 0 dBi antenna. For the initial channel setting, the manufacturers shall be permitted to provide for either random channel selection or manual channel selection.

A U-NII network will employ a DFS function to detect signals from radar systems and to avoid co-channel operation with these systems. This applies to the 5250-5350 MHz and/or 5470-5725 MHz bands.1

Within the context of the operation of the DFS function, a U-NII device will operate in either Master Mode or Client Mode. U-NII devices operating in Client Mode can only operate in a network controlled by a U-NII device operating in Master Mode.2

Tables 1 and 2 shown below summarize the information contained in sections 5.1.1 and 5.1.2.

**Table 1: Applicability of DFS Requirements Prior to Use of a Channel**

Requirement	Operational Mode		
	Master	Client Without Radar Detection	Client With Radar Detection
Non-Occupancy Period	Yes	Not required	Yes
DFS Detection Threshold	Yes	Not required	Yes
Channel Availability Check Time	Yes	Not required	Not required
U-NII Detection Bandwidth	Yes	Not required	Yes

**Table 2: Applicability of DFS requirements during normal operation**

Requirement	Operational Mode	
	Master	Client Without Radar Detection



DFS Detection Threshold	Yes	Not required
Channel Closing Transmission Time	Yes	Yes
Channel Move Time	Yes	Yes
U-NII Detection Bandwidth	Yes	Not required

Additional requirements for devices with multiple bandwidth modes	Master Device or Client with Radar Detection	Client Without Radar Detection
U-NII Detection Bandwidth and Statistical Performance Check	All BW modes must be tested	Not required
Channel Move Time and Channel Closing Transmission Time	Test using widest BW mode available	Test using the widest BW mode available for the link
All other tests	Any single BW mode	Not required
Note: Frequencies selected for statistical performance check (Section 7.8.4) should include several frequencies within the radar detection bandwidth and frequencies near the edge of the radar detection bandwidth. For 802.11 devices it is suggested to select frequencies in each of the bonded 20 MHz channels and the channel center frequency.		

The operational behavior and individual DFS requirements that are associated with these modes are as follows:

**Master Devices**

- a) The Master Device will use DFS in order to detect Radar Waveforms with received signal strength above the DFS Detection Threshold in the 5250 – 5350 MHz and 5470 – 5725 MHz bands. DFS is not required in the 5150 – 5250 MHz or 5725 – 5825 MHz bands.
- b) Before initiating a network on a Channel, the Master Device will perform a Channel Availability Check for specified time duration (Channel Availability Check Time) to ensure that there is no radar system operating on the Channel, using DFS described under subsection a) above.
- c) The Master Device initiates a U-NII network by transmitting control signals that will enable other U-NII devices to Associate with the Master Device.
- d) During normal operation, the Master Device will monitor the Channel (In-Service Monitoring) to ensure that there is no radar system operating on the Channel, using DFS described under a).
- e) If the Master Device has detected a Radar Waveform during In-Service Monitoring as described under d), the Operating Channel of the U-NII network is no longer an Available Channel. The Master Device will instruct all associated Client Device(s) to stop transmitting on this Channel within the Channel Move Time. The transmissions during the Channel Move Time will be limited to the Channel Closing Transmission Time.
- f) Once the Master Device has detected a Radar Waveform it will not utilize the Channel for the duration of the Non-Occupancy Period. 3.
- g) If the Master Device delegates the In-Service Monitoring to a Client Device, then the





combination will be tested to the requirements described under d) through f) above.

**Client Devices**

- a) A Client Device will not transmit before having received appropriate control signals from a Master Device.
- b) A Client Device will stop all its transmissions whenever instructed by a Master Device to which it is associated and will meet the Channel Move Time and Channel Closing Transmission Time requirements. The Client Device will not resume any transmissions until it has again received control signals from a Master Device.
- c) If a Client Device is performing In-Service Monitoring and detects a Radar Waveform above the DFS Detection Threshold, it will inform the Master Device. This is equivalent to the Master Device detecting the Radar Waveform and d) through f) of section 5.1.1 apply.
- d) Irrespective of Client Device or Master Device detection the Channel Move Time and Channel Closing Transmission Time requirements remain the same.
- e) The client test frequency must be monitored to ensure no transmission of any type has occurred for 30 minutes. Note: If the client moves with the master, the device is considered compliant if nothing appears in the client non-occupancy period test. For devices that shut down (rather than moving channels), no beacons should appear.

**DFS Detection Thresholds**

Table 3 below provides the DFS Detection Thresholds for Master Devices as well as Client Devices incorporating In-Service Monitoring.

**Table 3: DFS Detection Thresholds for Master Devices and Client Devices with Radar Detection**

Maximum Transmit Power	Value (See Notes 1, 2, and 3)
EIRP ≥ 200 mill watt	-64 dBm
EIRP < 200 mill watt and power spectral density < 10 dBm/MHz	-62 dBm
EIRP < 200 mill watt that do not meet the power spectral density requirement	-64 dBm
<p>Note 1: This is the level at the input of the receiver assuming a 0 dBi receive antenna.</p> <p>Note 2: Throughout these test procedures an additional 1 dB has been added to the amplitude of the test transmission waveforms to account for variations in measurement equipment. This will ensure that the test signal is at or above the detection threshold level to trigger a DFS response.</p> <p>Note3: EIRP is based on the highest antenna gain. For MIMO devices refer to KDB Publication 662911 D01.</p>	

**Response Requirements**

Table 4 provides the response requirements for Master and Client Devices incorporating DFS.

**Table 4: DFS Response Requirement Values**

Parameter	Value
-----------	-------

Non-occupancy period	Minimum 30 minutes
Channel Availability Check Time	60 seconds
Channel Move Time	10 seconds See Note 1.
Channel Closing Transmission Time	200 milliseconds + an aggregate of 60 milliseconds over remaining 10 second period. See Notes 1 and 2.
U-NII Detection Bandwidth	Minimum 100% of the U-NII 99% transmission power bandwidth. See Note 3.

**Note 1:** Channel Move Time and the Channel Closing Transmission Time should be performed with Radar Type 0. The measurement timing begins at the end of the Radar Type 0 burst.

**Note 2:** The Channel Closing Transmission Time is comprised of 200 milliseconds starting at the beginning of the Channel Move Time plus any additional intermittent control signals required to facilitate a Channel move (an aggregate of 60 milliseconds) during the remainder of the 10 second period. The aggregate duration of control signals will not count quiet periods in between transmissions.

**Note 3:** During the U-NII Detection Bandwidth detection test, radar type 0 should be used. For each frequency step the minimum percentage of detection is 90 percent. Measurements are performed with no data traffic.

### 3.7.2. Test Description

According to Section 7.2 of KDB 905462 D02 V01R01

#### 1. Setup for Master with injection at the Master

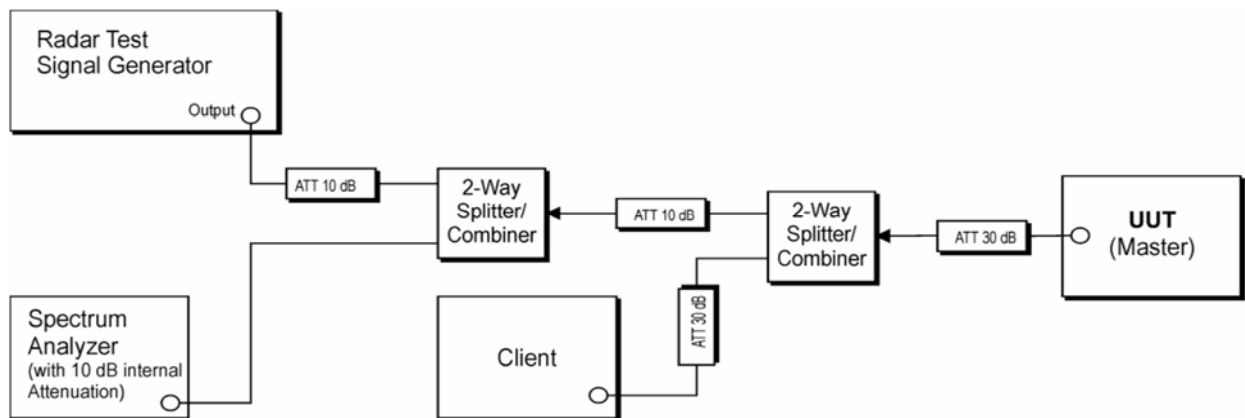

(Example Conducted Setup where UUT is a Master and Radar Test Waveforms are injected into the Master)

#### 2. Setup for Client with injection at the Master

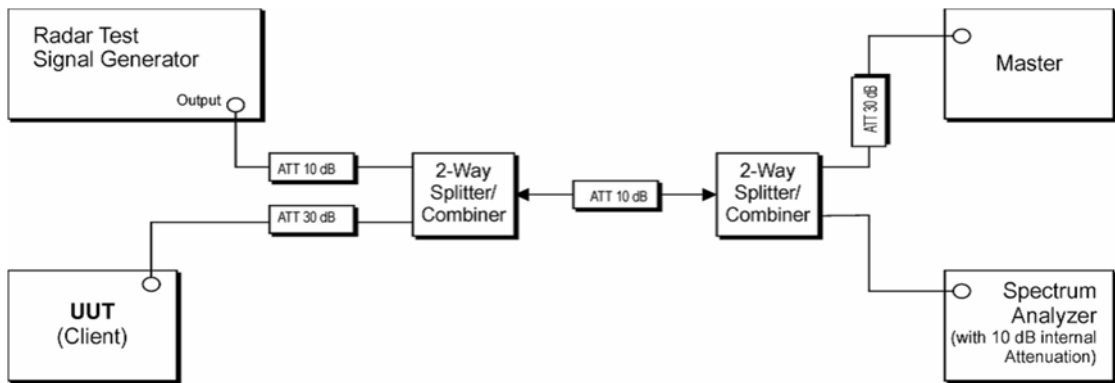

(Example Conducted Setup where UUT is a Client and Radar Test Waveforms are injected into the Master)

3. Setup for Client with injection at the Client

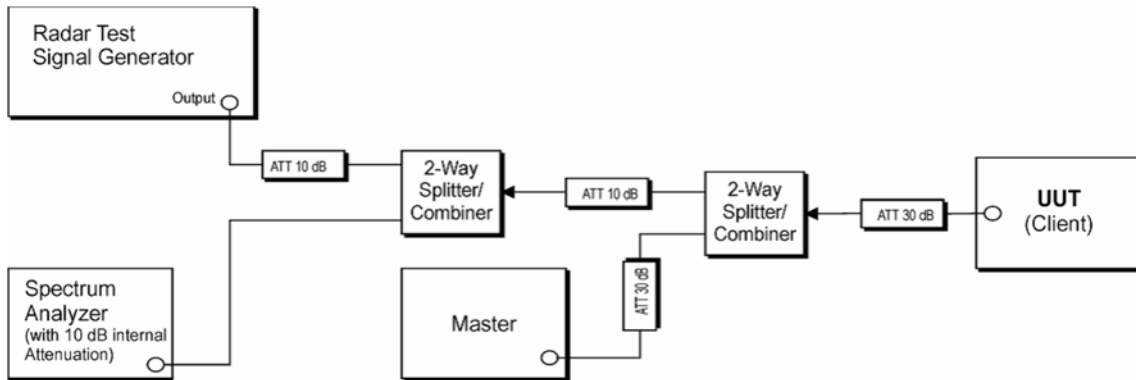

(Example Conducted Setup where UUT is a Client and Radar Test Waveforms are injected into the Client)

3.7.3. Information of Companion Device

Product Name:	Router
Manufacturer:	ASUS
FCC ID:	MSQ-RTAXJF00
Device Type:	Master Device
Operating Mode:	Master Mode
Serial No:	M3IAJF201046
Antenna Gain:	2.0dBi

3.7.4. Test Result

Refer to Annex A.6 in this report.



### 3.8. Conducted Emission

#### 3.8.1. Requirement

According to FCC section 15.207, for an intentional radiator that is designed to be connected to the public utility (AC) power line, the radio frequency voltage that is conducted back onto the AC power line on any frequency within the band 150kHz to 30MHz shall not exceed the limits in the following table, as measured using a 50μH/50Ω line impedance stabilization network (LISN).

Frequency Range (MHz)	Conducted Limit (dBμV)	
	Quai-peak	Average
0.15 - 0.50	66 to 56	56 to 46
0.50 - 5	56	46
5 - 30	60	50

Note:

- (a) The lower limit shall apply at the band edges.
- (b) The limit decreases linearly with the logarithm of the frequency in the range 0.15 - 0.50MHz.

#### 3.8.2. Test Procedures

The Table-top EUT was placed upon a non-metallic table 0.8m above the horizontal metal reference ground plane. EUT was connected to LISN and LISN was connected to reference Ground Plane. EUT was 80cm from LISN. The set-up and test methods were according to ANSI C63.10: 2013.

#### 3.8.3. Test Setup Layout

Refer to chapter 2.6.2 in this report.

#### 3.8.4. Test Result

Refer to Annex A.7 in this report.



### 3.9. Restricted Frequency Bands

#### 3.9.1. Requirement

The peak emissions outside of the frequency bands of operation shall be attenuated in accordance with the following limits:

- (1) For transmitters operating in the 5.15–5.25 GHz band: all emissions outside of the 5.15–5.35 GHz band shall not exceed an EIRP of -27dBm/MHz.
- (2) For transmitters operating in the 5.25–5.35 GHz band: all emissions outside of the 5.15–5.35 GHz band shall not exceed an EIRP of -27dBm/MHz.
- (3) For transmitters operating in the 5.47–5.725 GHz band: all emissions outside of the 5.47–5.725 GHz band shall not exceed an EIRP of -27dBm/MHz.
- (4) For transmitters operating in the 5.725-5.85 GHz band:
  - (i) All emissions shall be limited to a level of -27 dBm/MHz at 75 MHz or more above or below the band edge increasing linearly to 10 dBm/MHz at 25 MHz above or below the band edge, and from 25 MHz above or below the band edge increasing linearly to a level of 15.6 dBm/MHz at 5 MHz above or below the band edge, and from 5 MHz above or below the band edge increasing linearly to a level of 27 dBm/MHz at the band edge.

The following formula is used to convert the equipment isotropic radiated power(e.i.r.p.) to field strength (dBμV/m);

$$E = 1000000 \times \sqrt{30P} / 3 \mu\text{V/m}$$

where P is the EIRP in Watts

Therefore: -27 dBm/MHz = 68.23 dBuV/m



Unwanted emissions below 1 GHz must comply with the general field strength limits set forth in § 15.209. According to FCC section 15.209 (a), except as provided elsewhere in this subpart, the emissions from an intentional radiator shall not exceed the field strength levels specified in the following table:

Frequency (MHz)	Field Strength ( $\mu\text{V}/\text{m}$ )	Measurement Distance (m)
0.009 - 0.490	2400/F(kHz)	300
0.490 - 1.705	24000/F(kHz)	30
1.705 - 30.0	30	30
30 - 88	100	3
88 - 216	150	3
216 - 960	200	3
Above 960	500	3

For Above 1000MHz, the emission limit in this paragraph is based on measurement instrumentation employing an average detector, measurement using instrumentation with a peak detector function, corresponding to 20dB above the maximum permitted average limit. In addition, radiated emissions which fall in the restricted bands, as defined in Section 15.205(a), also should comply with the radiated emission limits specified in Section 15.209(a)(above table).

### 3.9.2. Test Procedures

The EUT is located in a 3m Semi-Anechoic Chamber; the antenna factors, cable loss and so on of the site as factors are calculated to correct the reading.

KDB 789033 Section H) 3)5)6(d)) was used in order to prove compliance

For the Test Antenna:

Test Antenna is 3m away from the EUT. Test Antenna height is varied from 1m to 4m above the ground to determine the maximum value of the field strength.

### 3.9.3. Test Setup Layout

Refer to chapter 2.6.3 in this report.

### 3.9.4. Test Result

Refer to Annex A.8 in this report.



### 3.10. Radiated Emission

#### 3.10.1.Requirement

The peak emissions outside of the frequency bands of operation shall be attenuated in accordance with the following limits:

- (1) For transmitters operating in the 5.15–5.25 GHz band: all emissions outside of the 5.15–5.35 GHz band shall not exceed an EIRP of -27dBm/MHz.
- (2) For transmitters operating in the 5.25–5.35 GHz band: all emissions outside of the 5.15–5.35 GHz band shall not exceed an EIRP of -27dBm/MHz.
- (3) For transmitters operating in the 5.47–5.725 GHz band: all emissions outside of the 5.47–5.725 GHz band shall not exceed an EIRP of -27dBm/MHz.
- (4) For transmitters operating in the 5.725-5.85 GHz band: All emissions within the frequency range from the band edge to 10 MHz above or below the band edge shall not exceed an e.i.r.p. of -17 dBm/MHz; for frequencies 10 MHz or greater above or below the band edge, emissions shall not exceed an e.i.r.p. of -27 dBm/MHz.

The following formula is used to convert the equipment isotropic radiated power(e.i.r.p.) to field strength (dBμV/m);

$$E = 1000000 \times \sqrt{\frac{30P}{3}} \mu\text{V/m}$$

where P is the EIRP in Watts

Therefore: -27 dBm/MHz = 68.23 dBuV/m

Unwanted emissions below 1 GHz must comply with the general field strength limits set forth in § 15.209. According to FCC section 15.209 (a), except as provided elsewhere in this subpart, the emissions from an intentional radiator shall not exceed the field strength levels specified in the following table:

Frequency (MHz)	Field Strength (μV/m)	Measurement Distance (m)
0.009 - 0.490	2400/F(kHz)	300
0.490 - 1.705	24000/F(kHz)	30
1.705 - 30.0	30	30
30 - 88	100	3
88 - 216	150	3
216 - 960	200	3
Above 960	500	3



For Above 1000MHz, the emission limit in this paragraph is based on measurement instrumentation employing an average detector, measurement using instrumentation with a peak detector function, corresponding to 20dB above the maximum permitted average limit. In addition, radiated emissions which fall in the restricted bands, as defined in Section 15.205(a), also should comply with the radiated emission limits specified in Section 15.209(a)(above table).

### 3.10.2. Test Procedures

The EUT is placed on a non-conducting table 80 cm above the ground plane for measurement below 1GHz; 1.5 m above the ground plane for measurement above 1GHz. The antenna to EUT distance is 3meters. The EUT is configured in accordance with ANSI C63.10. The EUT is set to transmit in a continuous mode.

For measurements below 30MHz, the emission limits shown in the above table are based on measurements employing a CISPR quasi-peak detector except for the frequency bands 9kHz-90 kHz, 110kHz-490 kHz. Radiated emission limits in these two bands are based on measurements employing an average detector.

For measurements below 1GHz the resolution bandwidth is set to 100kHz for peak detection measurements or 120kHz for quasi-peak detection measurements. Peak detection is used unless otherwise noted as quasi-peak.

For measurements above 1GHz the resolution bandwidth is set to 1MHz, the video band width is set to 3MHz for peak measurements and as applicable for average measurements.

The EUT is rotated through 360 degrees to maximize emissions received. The antenna is scanned from 1 to 4 meters above the ground plane to further maximize the emission. Measurements are made with the antenna polarized in both the vertical and the horizontal positions. For measurements above 1 GHz, keeping the measurement antenna aimed at the source of emissions at each frequency of significant emissions, with polarization oriented for maximum response.

### 3.10.3. Test Setup Layout

Refer to chapter 2.6.3 in this report.

### 3.10.4. Test Result

Refer to Annex A.9 in this report.





# Annex A Test Data and Result

## A.1. Duty Cycle of Test Signal

Condition	Mode	Frequency (MHz)	Antenna	Duty Cycle (%)	Correction Factor (dB)	1/T (kHz)
NVNT	a	5180	Ant1	98.26	0.08	0.49
NVNT	a	5220	Ant1	98.26	0.08	0.49
NVNT	a	5240	Ant1	98.16	0.08	0.49
NVNT	a	5260	Ant1	98.16	0.08	0.49
NVNT	a	5300	Ant1	98.26	0.08	0.49
NVNT	a	5320	Ant1	98.26	0.08	0.49
NVNT	a	5500	Ant1	98.26	0.08	0.49
NVNT	a	5580	Ant1	98.16	0.08	0.49
NVNT	a	5600	Ant1	98.26	0.08	0.49
NVNT	a	5720	Ant1	98.16	0.08	0.49
NVNT	a	5745	Ant1	98.26	0.08	0.49
NVNT	a	5785	Ant1	98.16	0.08	0.49
NVNT	a	5825	Ant1	98.26	0.08	0.49
NVNT	n20	5180	Ant1	97.93	0.09	0.59
NVNT	n20	5220	Ant1	97.93	0.09	0.59
NVNT	n20	5240	Ant1	97.93	0.09	0.59
NVNT	n20	5260	Ant1	97.93	0.09	0.59
NVNT	n20	5300	Ant1	97.93	0.09	0.59
NVNT	n20	5320	Ant1	97.93	0.09	0.59
NVNT	n20	5500	Ant1	97.93	0.09	0.59
NVNT	n20	5580	Ant1	97.93	0.09	0.59
NVNT	n20	5600	Ant1	97.93	0.09	0.59
NVNT	n20	5720	Ant1	97.93	0.09	0.59
NVNT	n20	5745	Ant1	97.82	0.1	0.59
NVNT	n20	5785	Ant1	97.93	0.09	0.59
NVNT	n20	5825	Ant1	97.93	0.09	0.59
NVNT	n40	5190	Ant1	95.89	0.18	1.19
NVNT	n40	5230	Ant1	95.88	0.18	1.19
NVNT	n40	5270	Ant1	95.89	0.18	1.19
NVNT	n40	5310	Ant1	95.66	0.19	1.19
NVNT	n40	5510	Ant1	95.89	0.18	1.19
NVNT	n40	5550	Ant1	95.88	0.18	1.19
NVNT	n40	5630	Ant1	95.89	0.18	1.19



NVNT	n40	5710	Ant1	95.88	0.18	1.19
NVNT	n40	5755	Ant1	95.88	0.18	1.19
NVNT	n40	5795	Ant1	95.88	0.18	1.19
NVNT	ac20	5180	Ant1	97.94	0.09	0.58
NVNT	ac20	5220	Ant1	97.83	0.1	0.58
NVNT	ac20	5240	Ant1	97.83	0.1	0.58
NVNT	ac20	5260	Ant1	97.83	0.1	0.58
NVNT	ac20	5300	Ant1	97.83	0.1	0.58
NVNT	ac20	5320	Ant1	97.94	0.09	0.58
NVNT	ac20	5500	Ant1	97.94	0.09	0.58
NVNT	ac20	5580	Ant1	97.94	0.09	0.58
NVNT	ac20	5600	Ant1	97.94	0.09	0.58
NVNT	ac20	5720	Ant1	97.83	0.1	0.58
NVNT	ac20	5745	Ant1	97.94	0.09	0.58
NVNT	ac20	5785	Ant1	97.94	0.09	0.58
NVNT	ac20	5825	Ant1	97.83	0.1	0.58
NVNT	ac40	5190	Ant1	95.92	0.18	1.18
NVNT	ac40	5230	Ant1	95.92	0.18	1.18
NVNT	ac40	5270	Ant1	95.7	0.19	1.18
NVNT	ac40	5310	Ant1	95.7	0.19	1.18
NVNT	ac40	5510	Ant1	95.92	0.18	1.18
NVNT	ac40	5550	Ant1	95.7	0.19	1.18
NVNT	ac40	5630	Ant1	95.92	0.18	1.18
NVNT	ac40	5710	Ant1	95.92	0.18	1.18
NVNT	ac40	5755	Ant1	95.7	0.19	1.18
NVNT	ac40	5795	Ant1	95.7	0.19	1.18
NVNT	ac80	5210	Ant1	92	0.36	2.42
NVNT	ac80	5290	Ant1	92.44	0.34	2.4
NVNT	ac80	5530	Ant1	92	0.36	2.42
NVNT	ac80	5610	Ant1	92	0.36	2.42
NVNT	ac80	5690	Ant1	92	0.36	2.42
NVNT	ac80	5775	Ant1	92.44	0.34	2.4



Test Graphs

Duty Cycle NVNT a 5180MHz Ant1

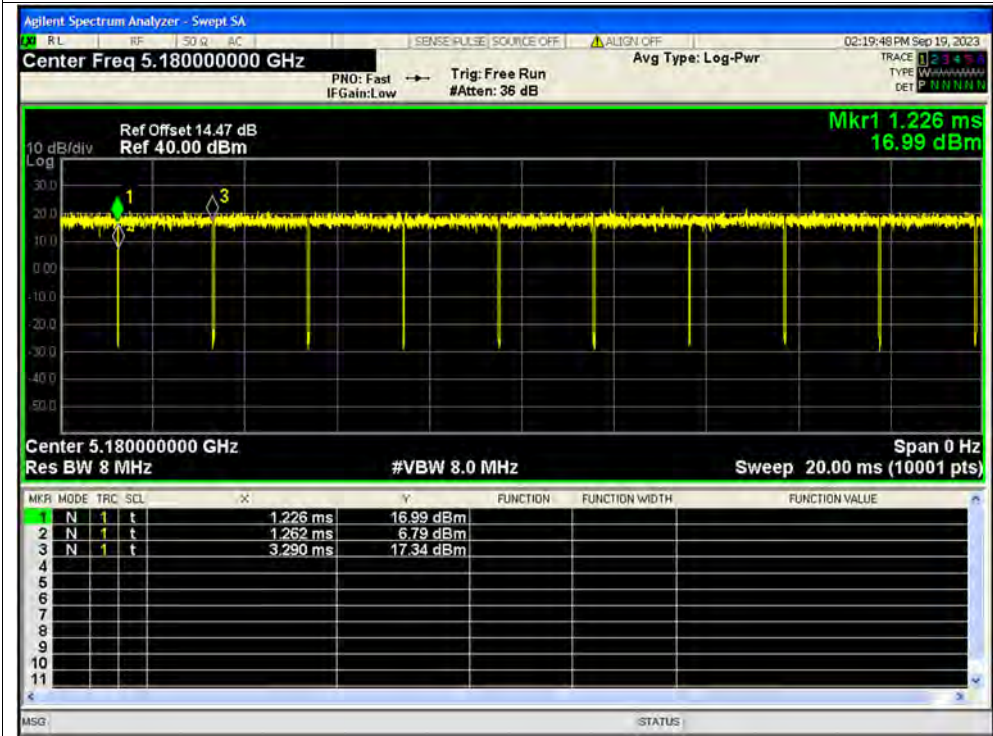

Duty Cycle NVNT a 5220MHz Ant1

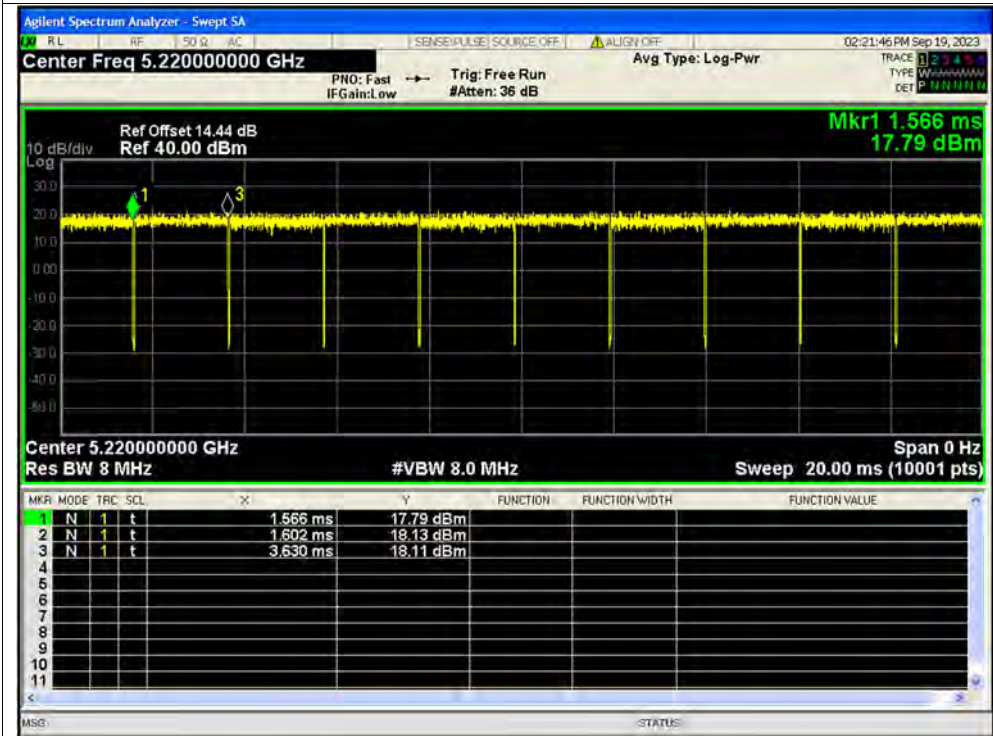



Duty Cycle NVNT a 5240MHz Ant1

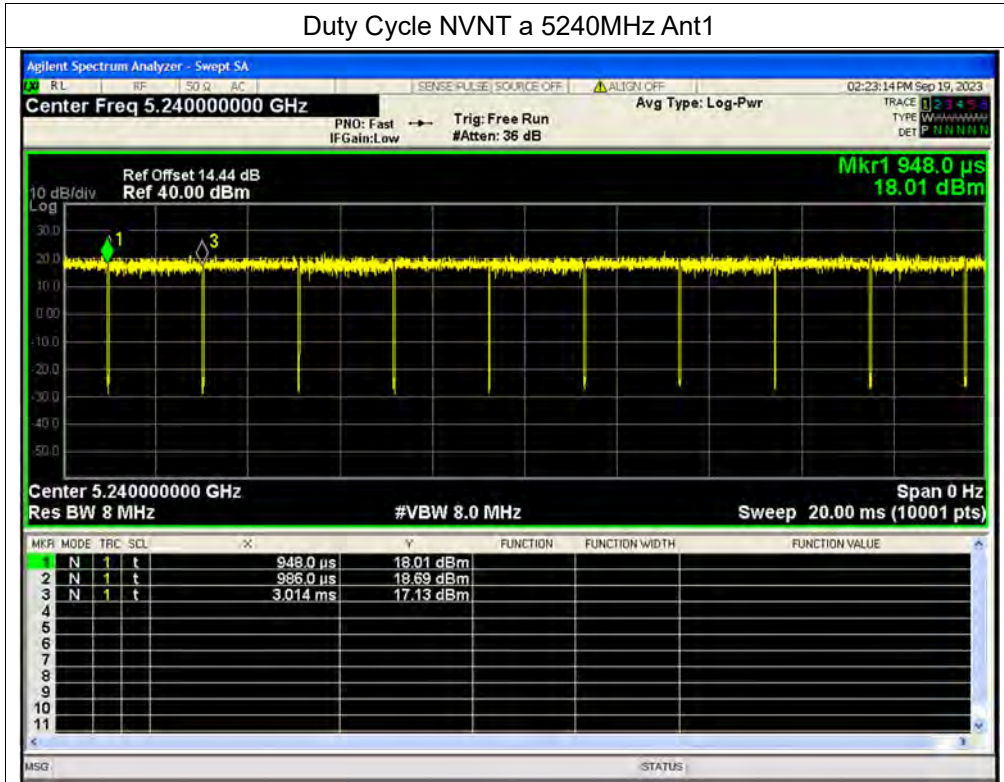

Duty Cycle NVNT a 5260MHz Ant1

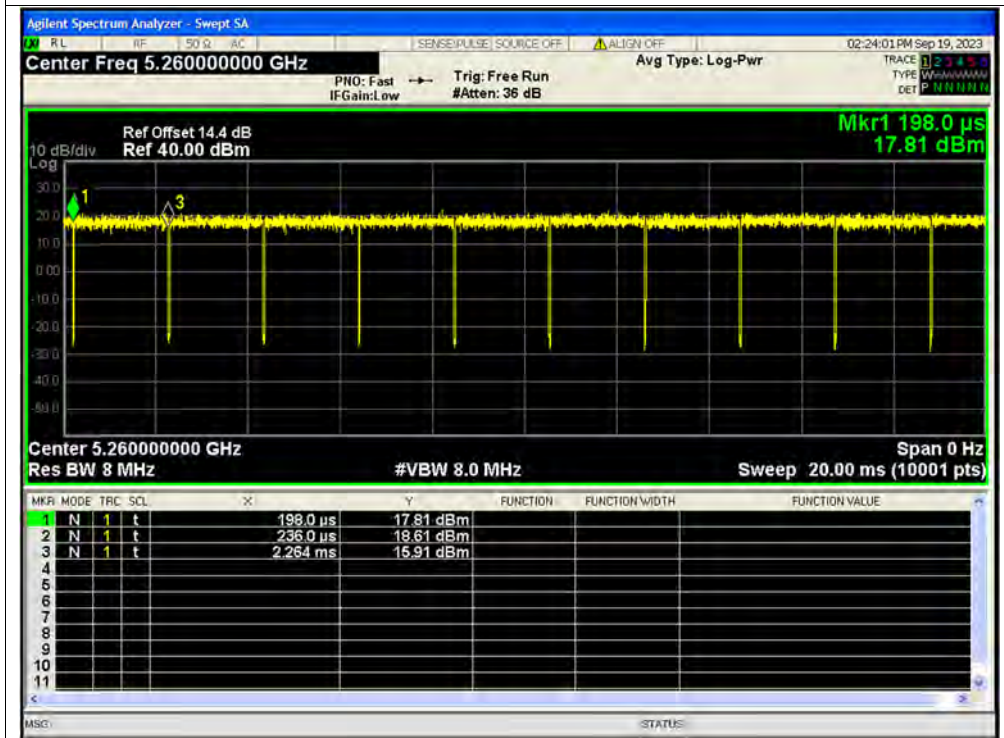





Duty Cycle NVNT a 5300MHz Ant1

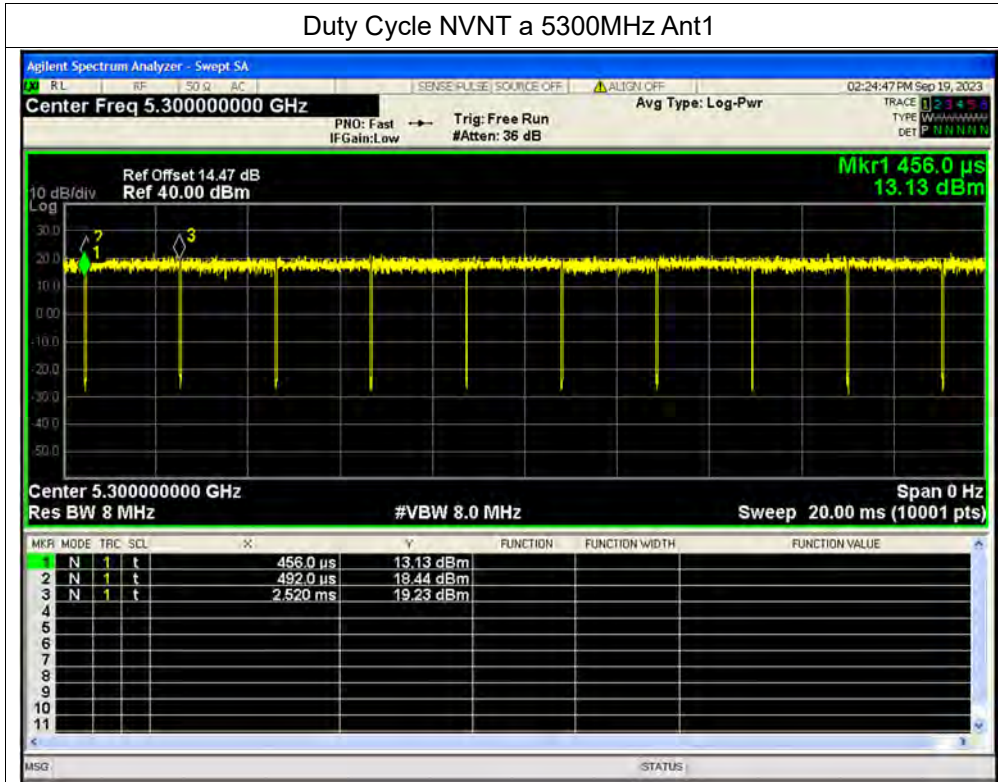

Duty Cycle NVNT a 5320MHz Ant1

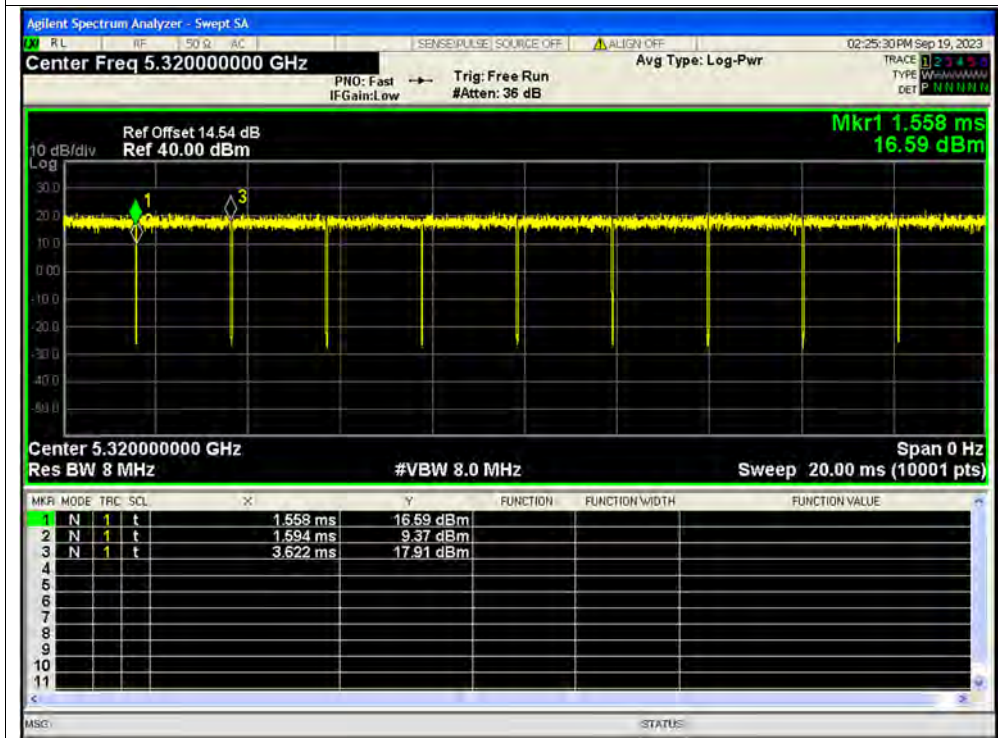



Duty Cycle NVNT a 5500MHz Ant1

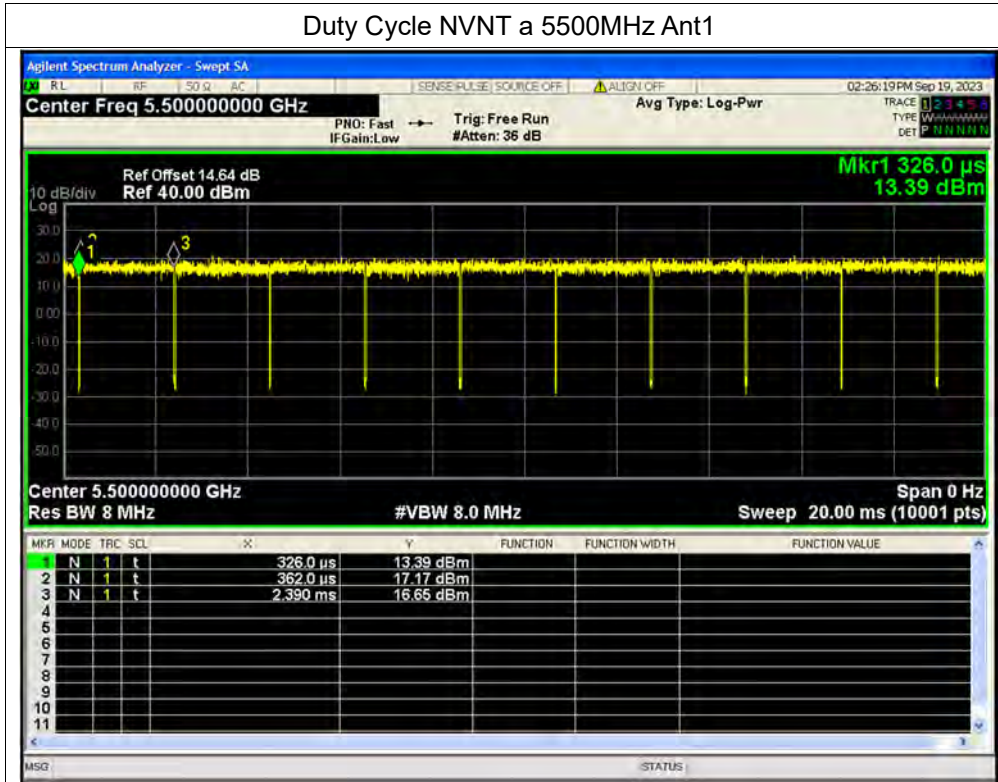

Duty Cycle NVNT a 5580MHz Ant1

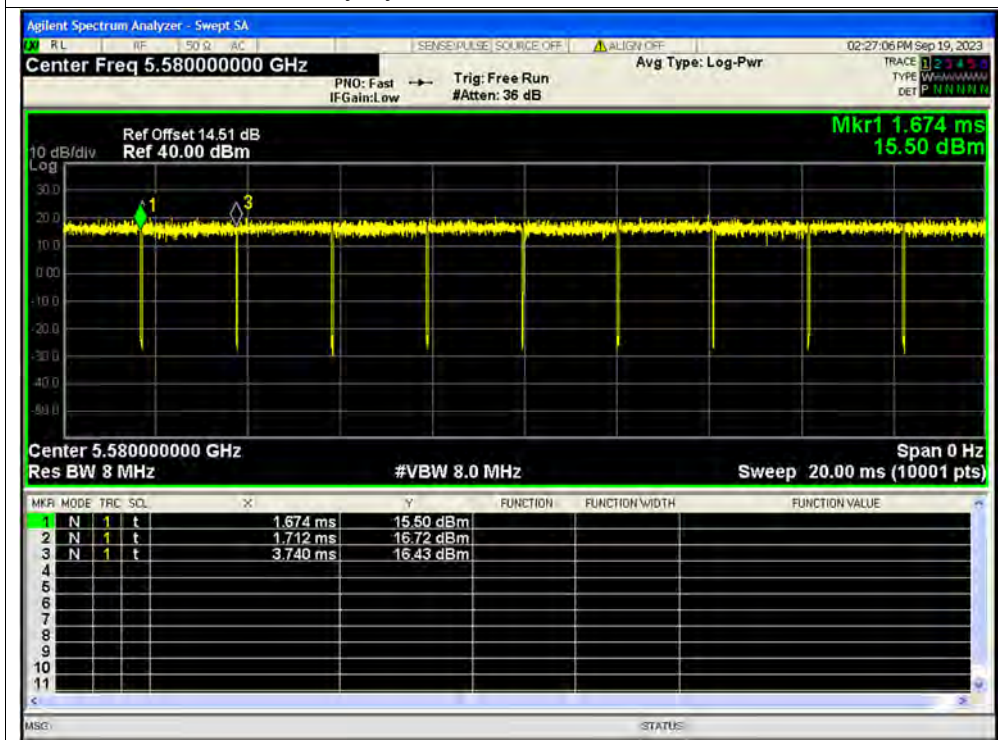



Duty Cycle NVNT a 5600MHz Ant1

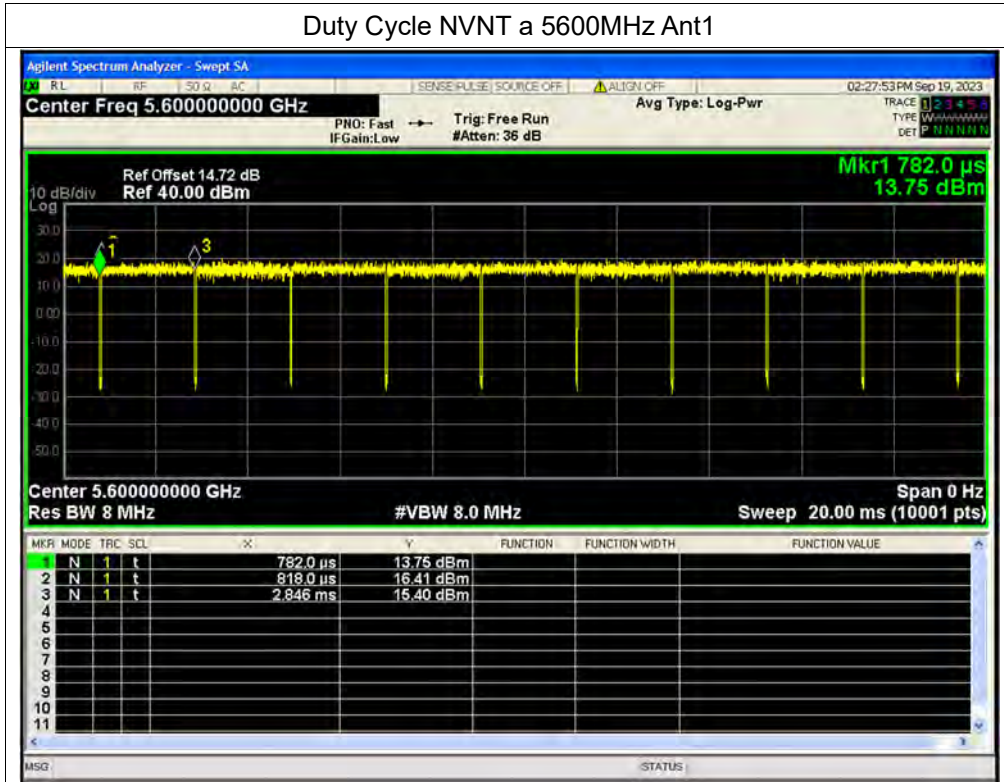

Duty Cycle NVNT a 5720MHz Ant1

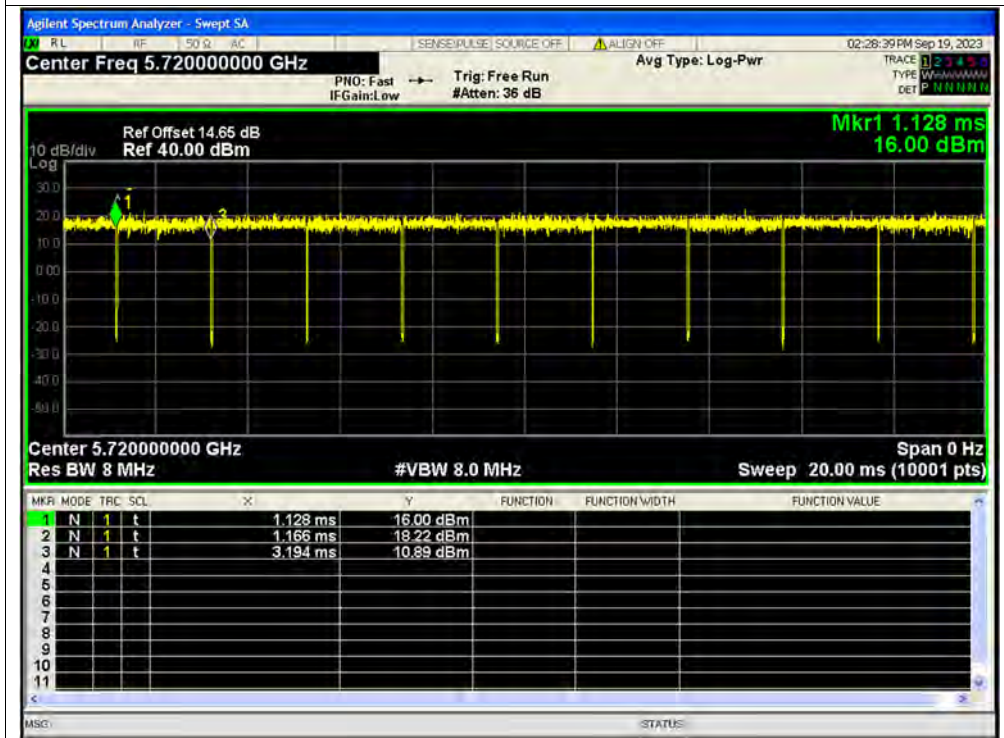





Duty Cycle NVNT a 5745MHz Ant1

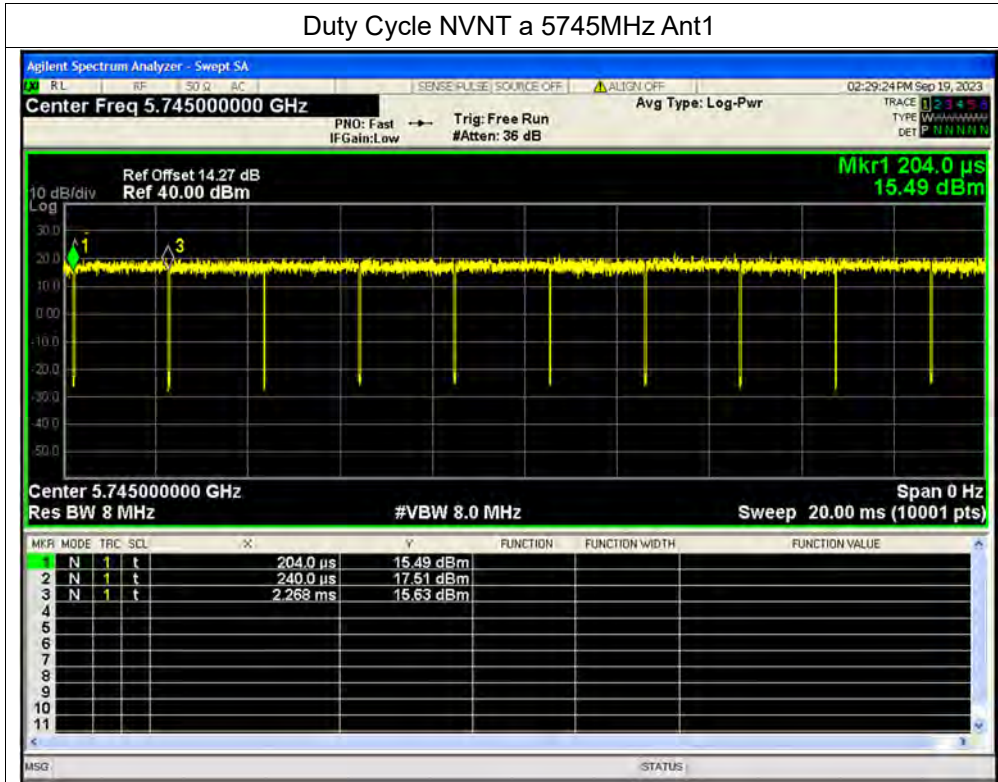

Duty Cycle NVNT a 5785MHz Ant1

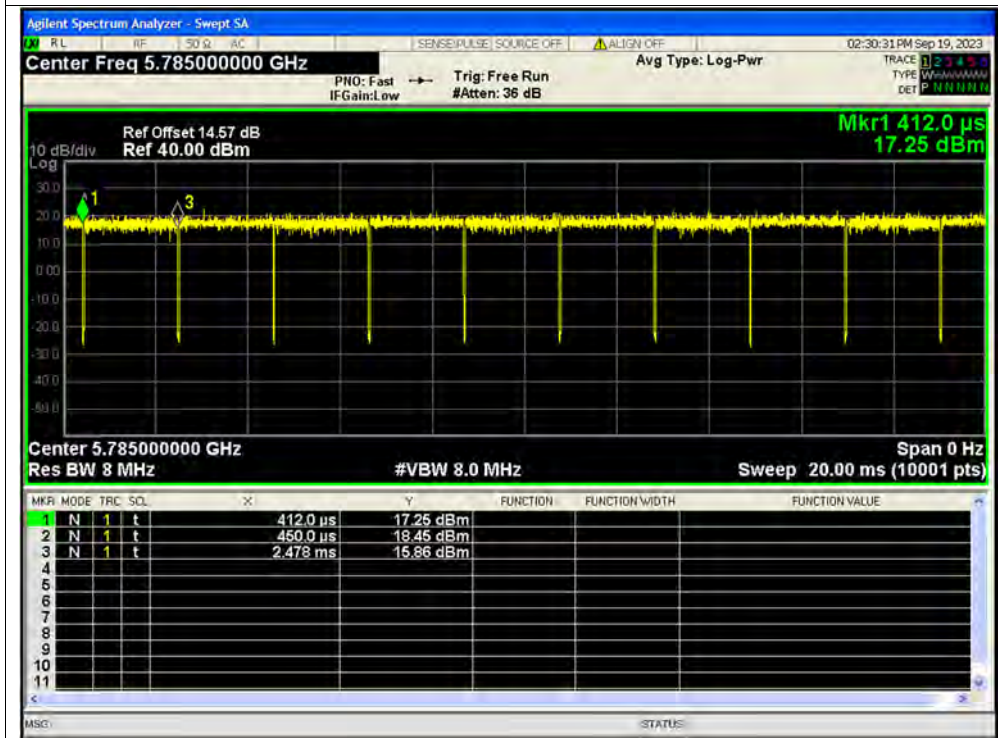





Duty Cycle NVNT a 5825MHz Ant1

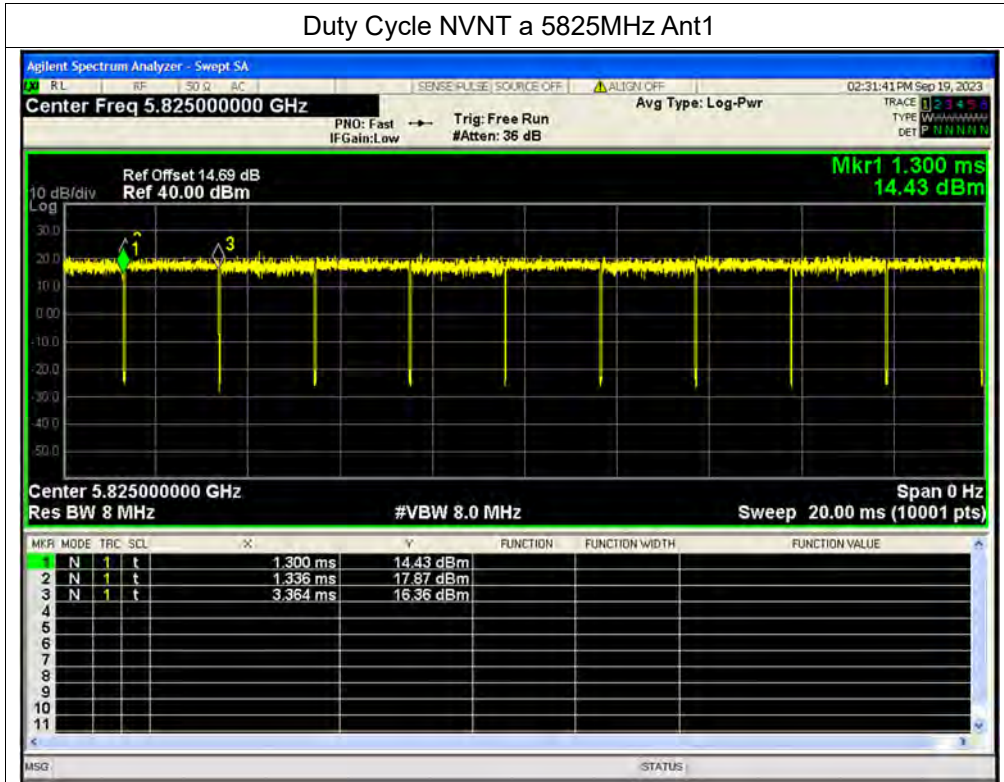

Duty Cycle NVNT n20 5180MHz Ant1

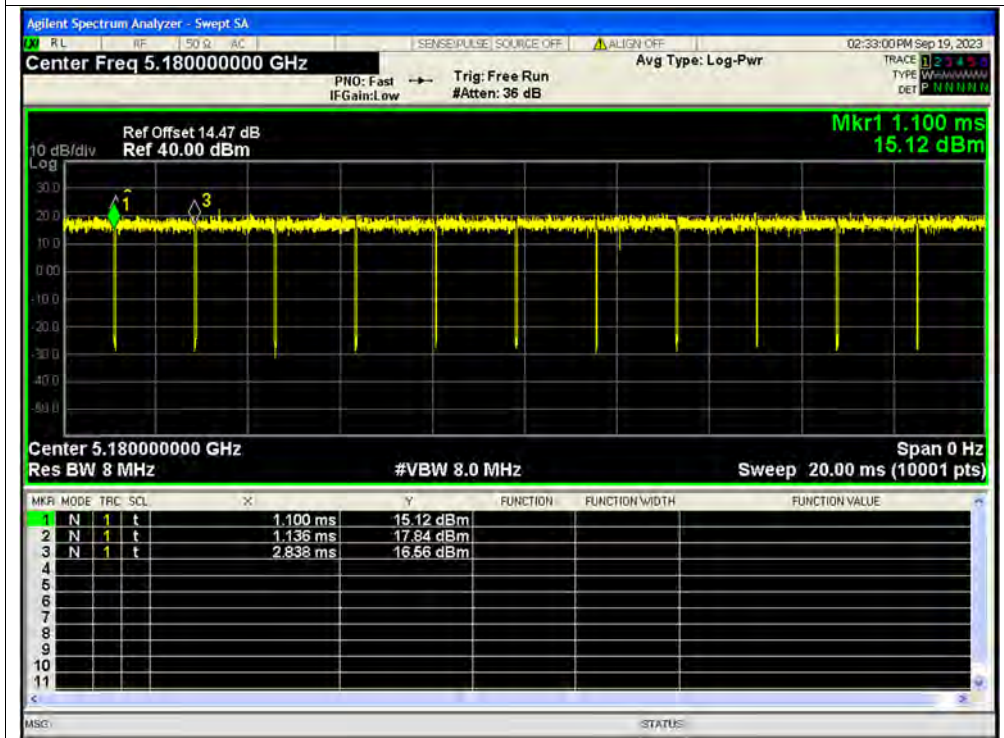



Duty Cycle NVNT n20 5220MHz Ant1

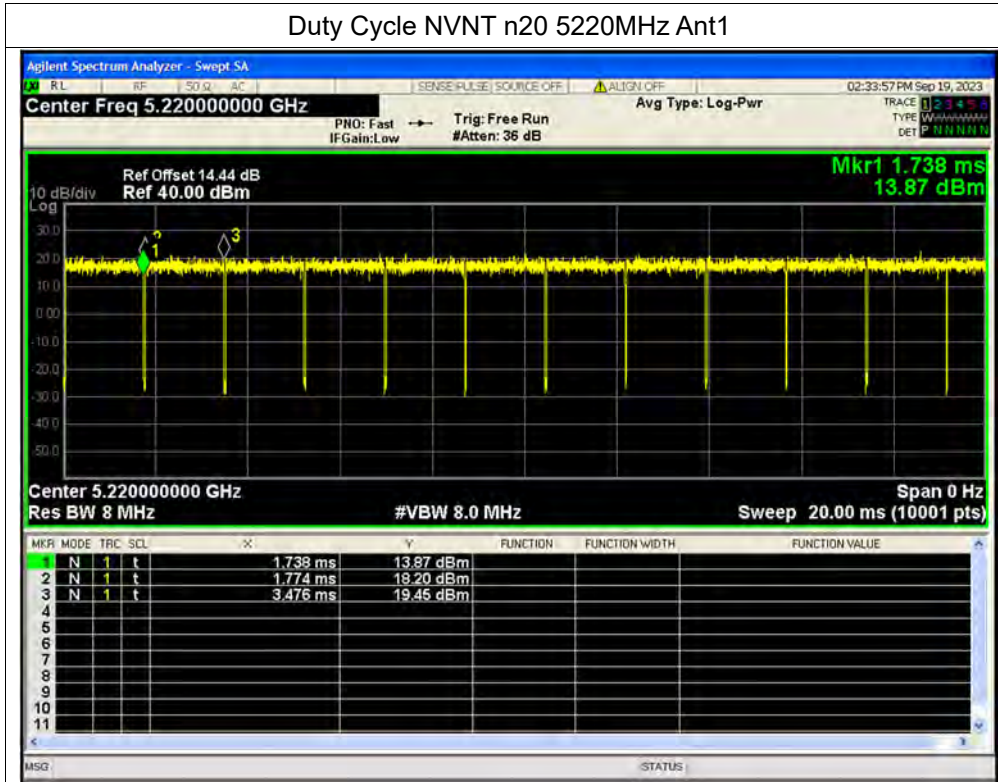

Duty Cycle NVNT n20 5240MHz Ant1

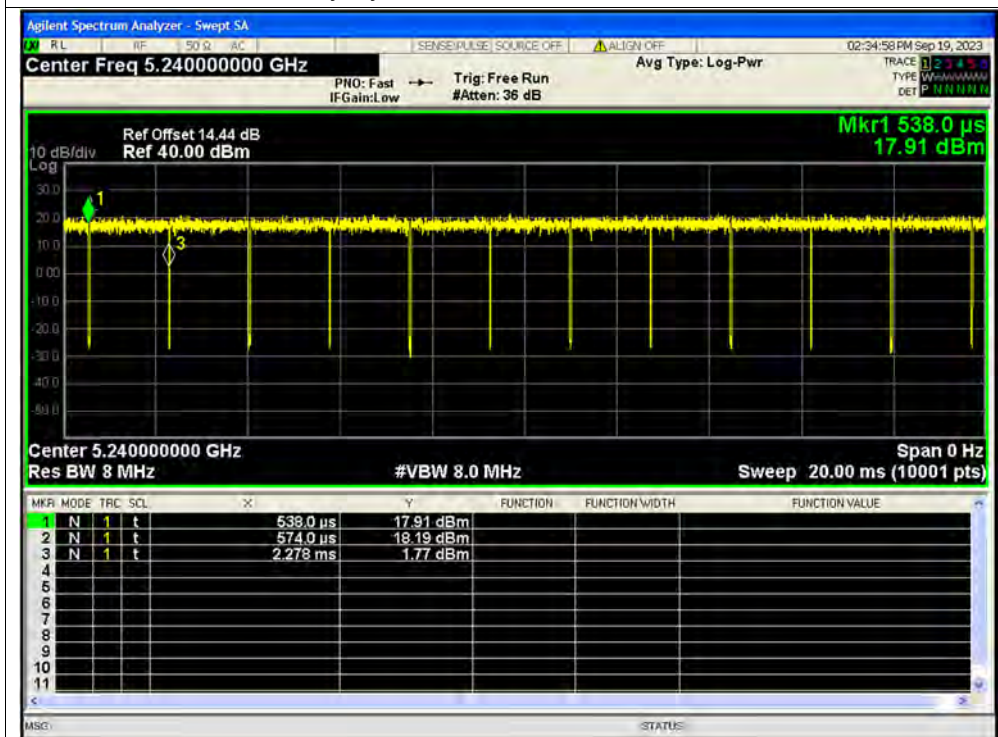



Duty Cycle NVNT n20 5260MHz Ant1

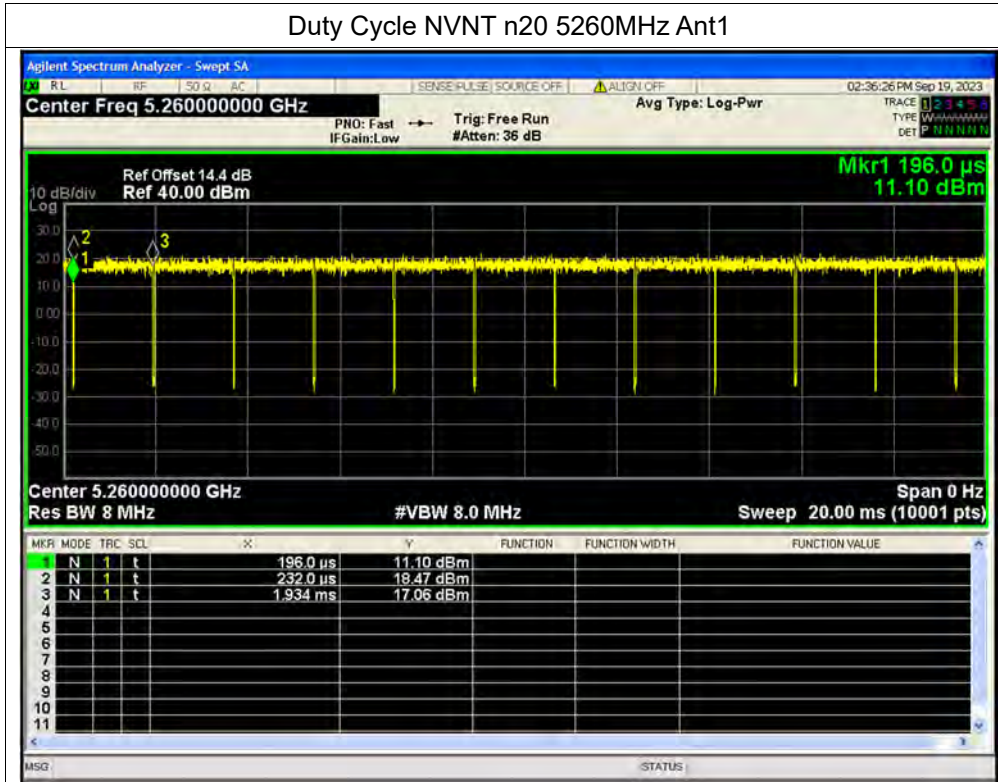

Duty Cycle NVNT n20 5300MHz Ant1

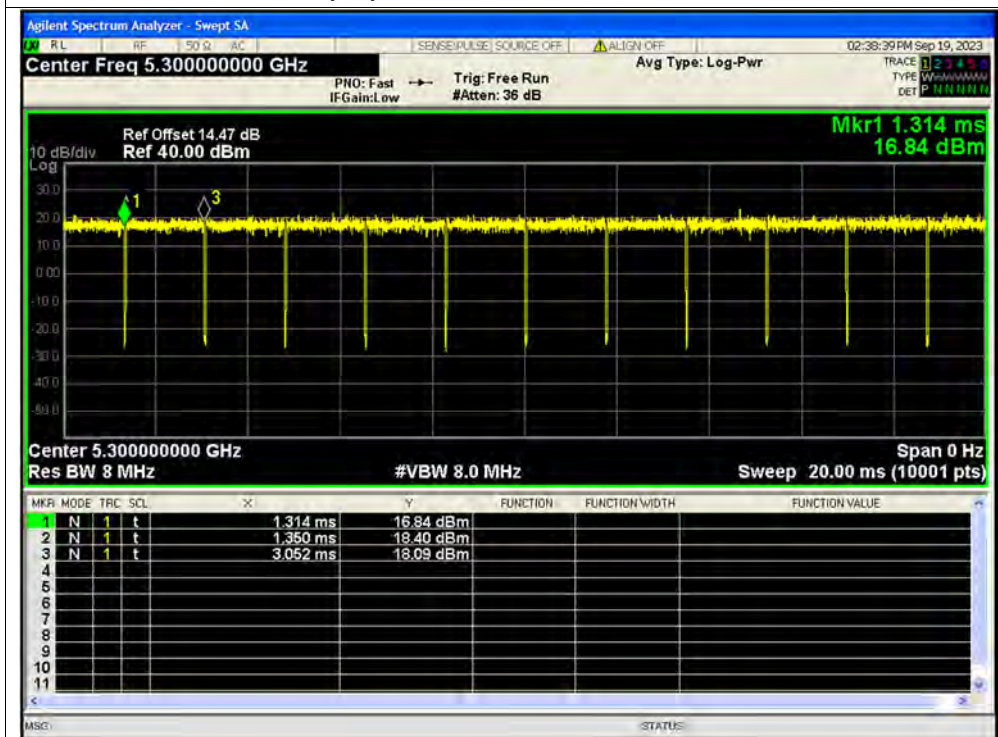





Duty Cycle NVNT n20 5320MHz Ant1

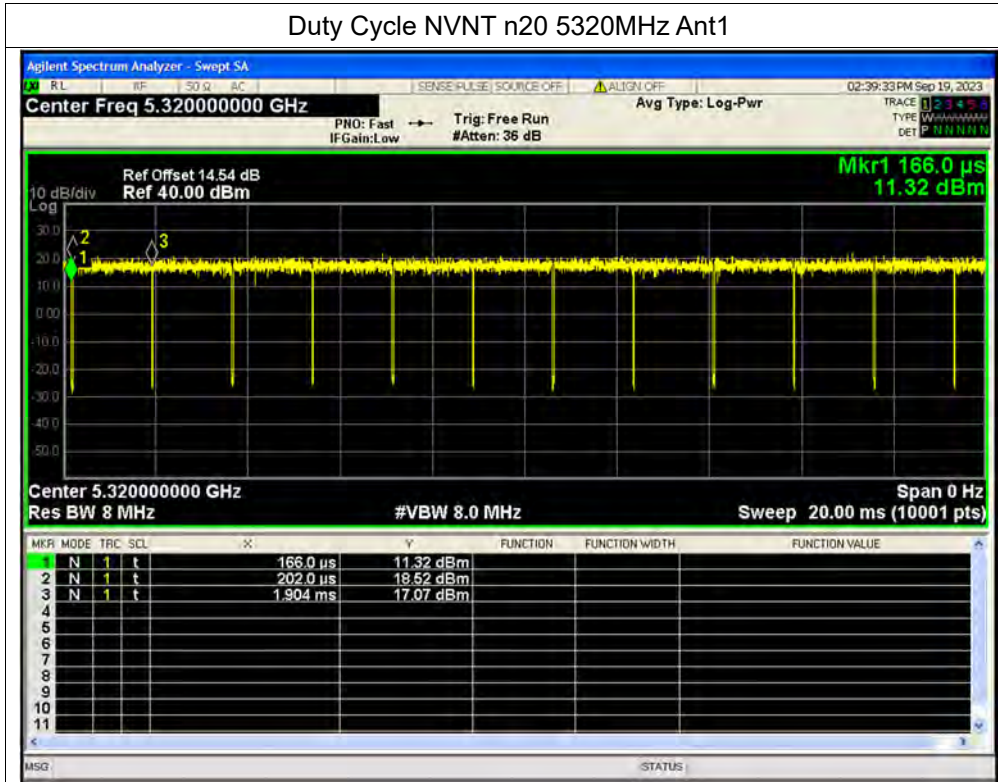

Duty Cycle NVNT n20 5500MHz Ant1

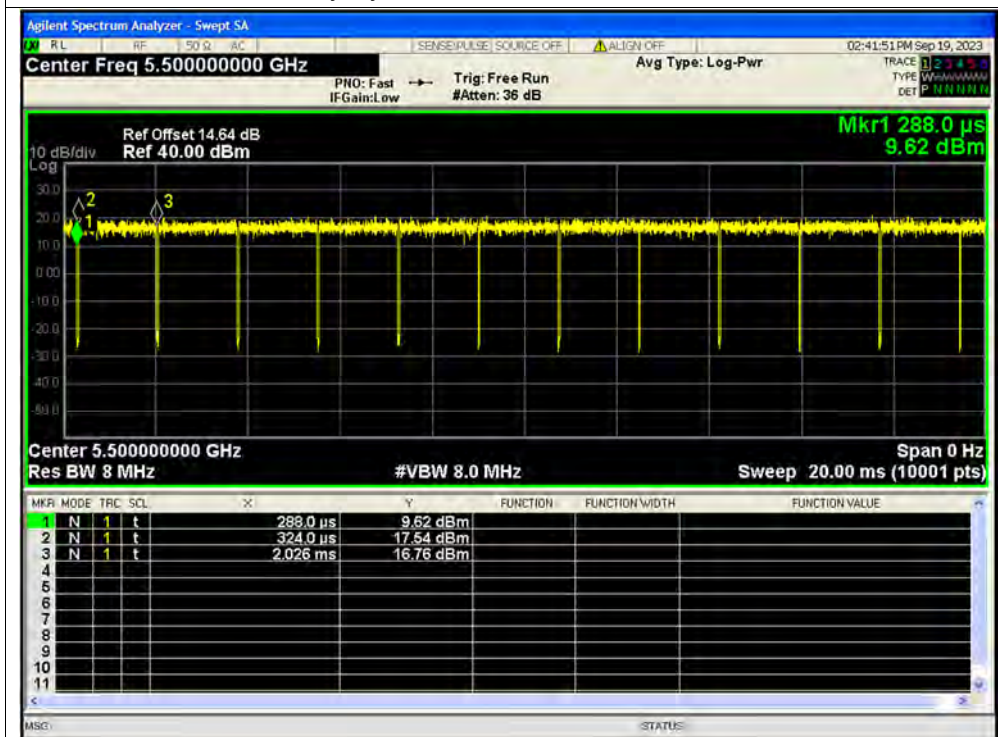



Duty Cycle NVNT n20 5580MHz Ant1

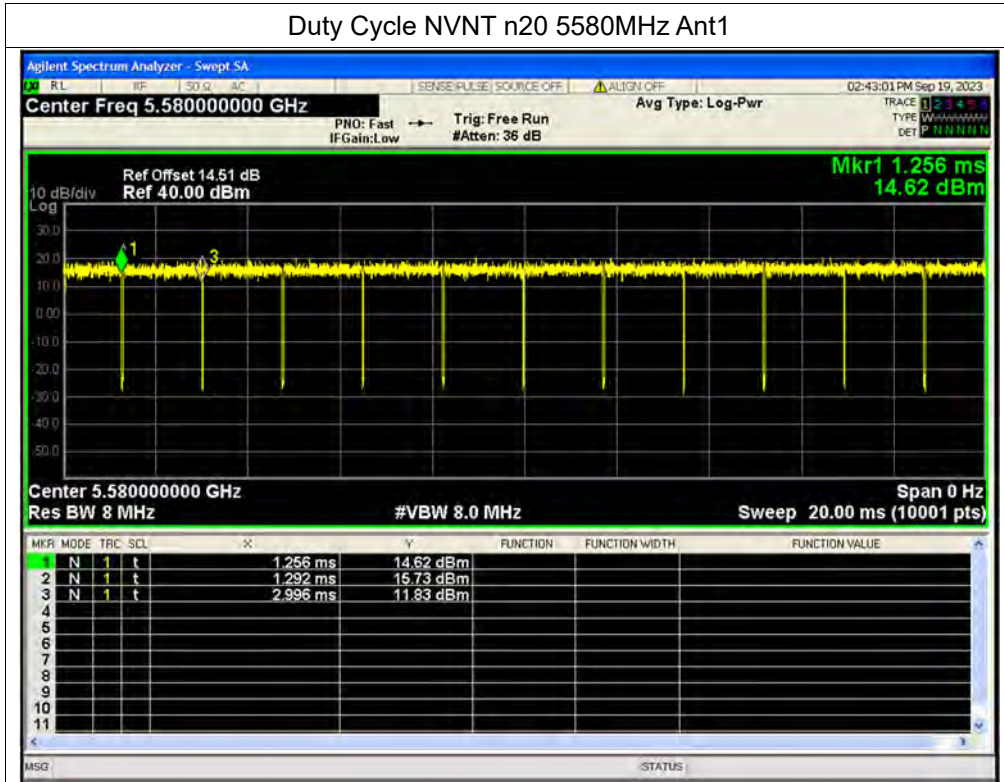

Duty Cycle NVNT n20 5600MHz Ant1

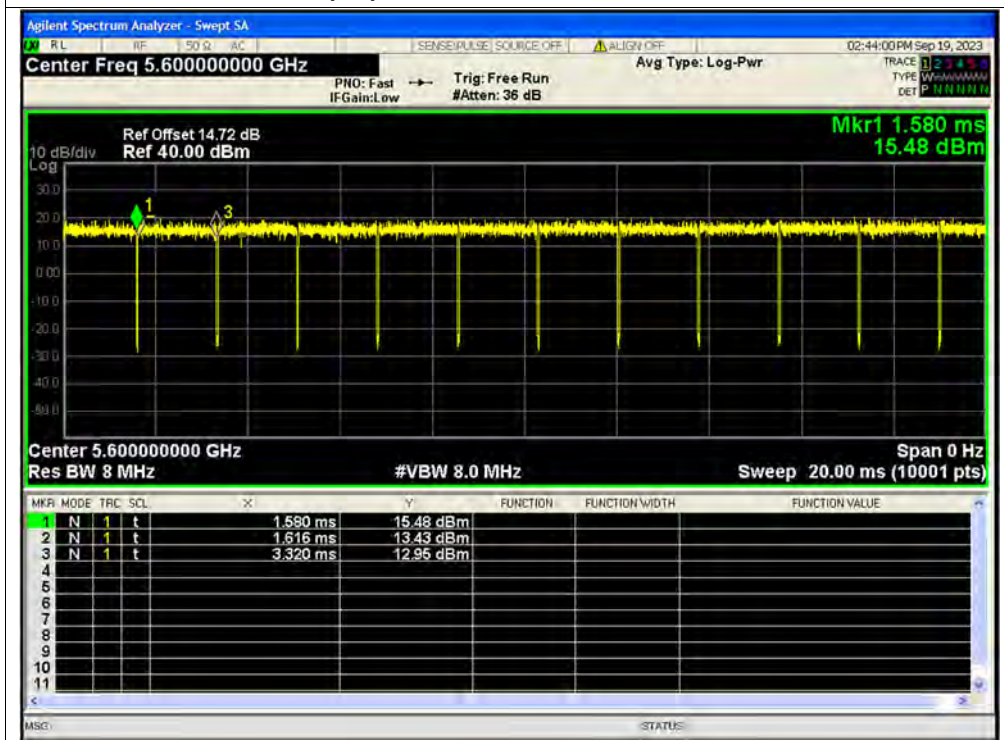



Duty Cycle NVNT n20 5720MHz Ant1

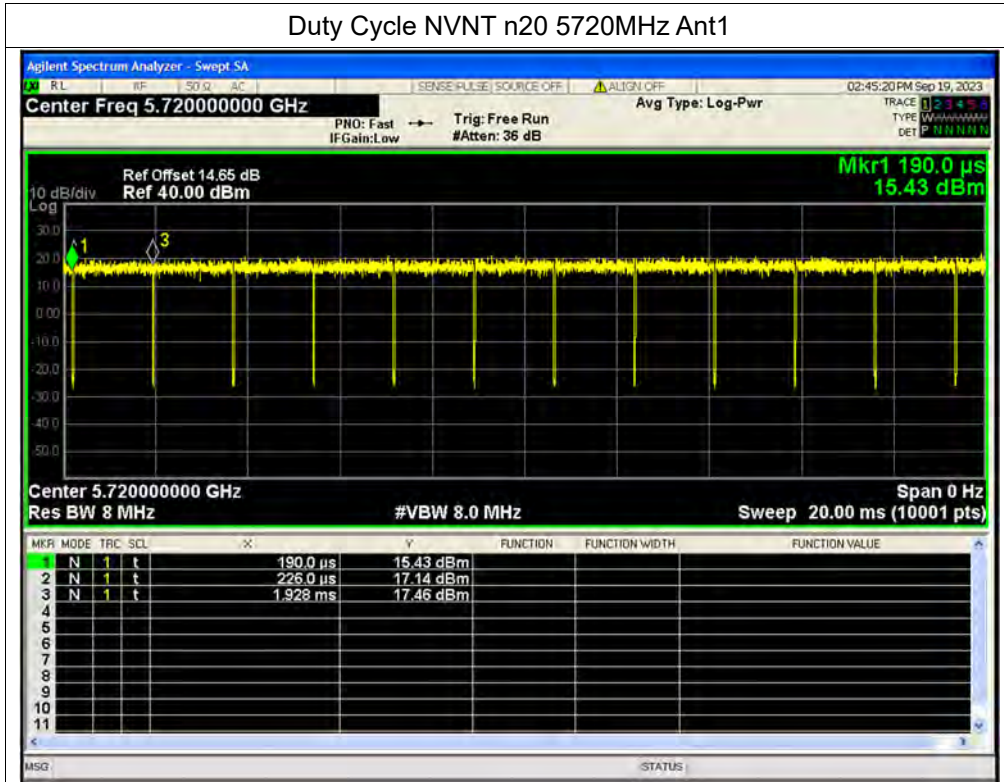

Duty Cycle NVNT n20 5745MHz Ant1

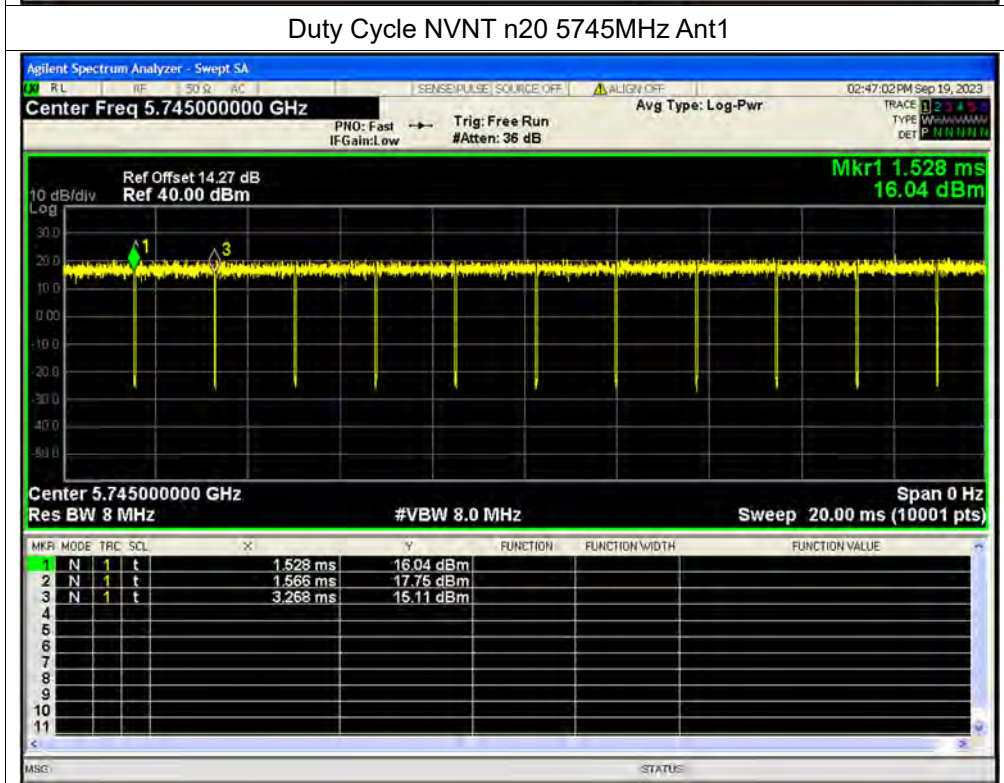





Duty Cycle NVNT n20 5785MHz Ant1

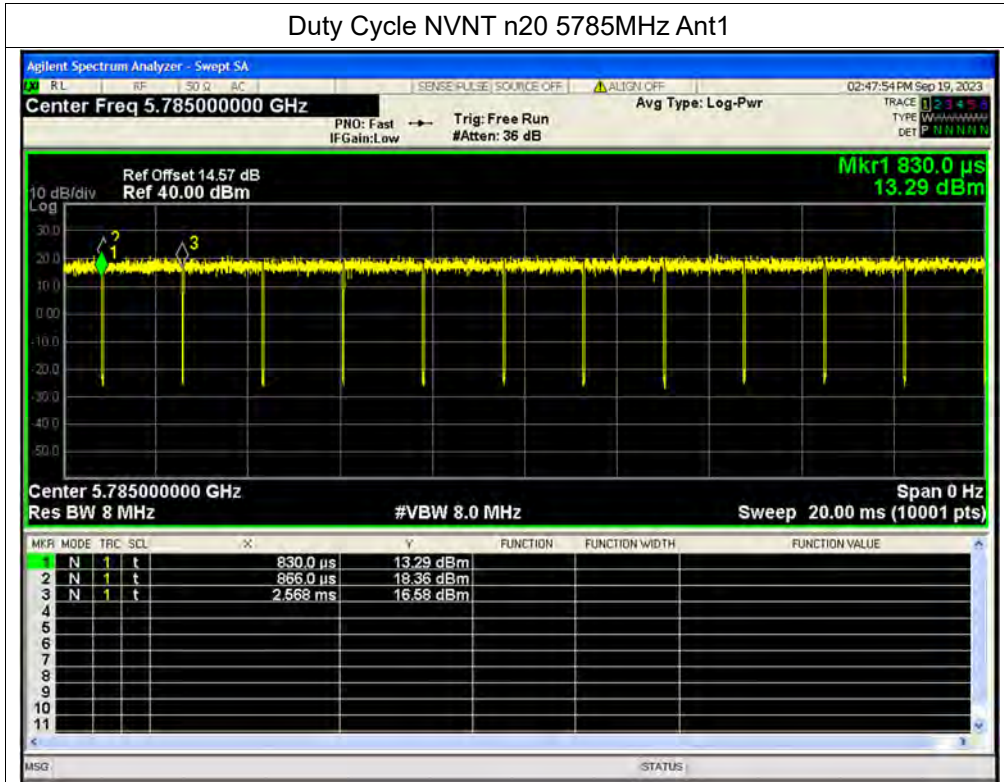

Duty Cycle NVNT n20 5825MHz Ant1

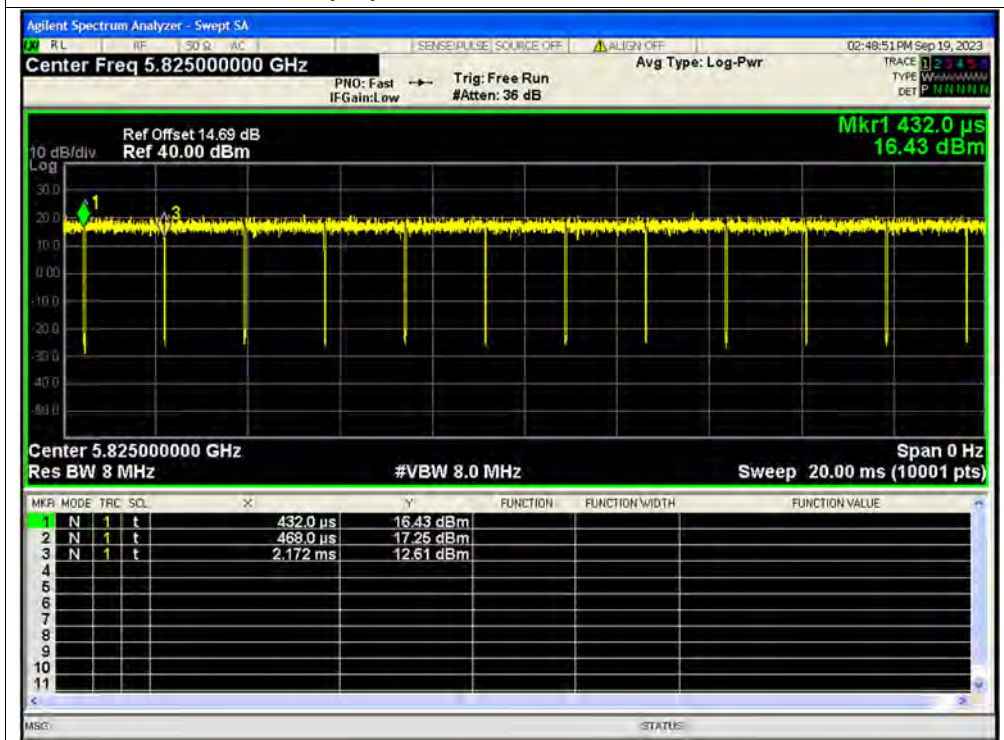



Duty Cycle NVNT n40 5190MHz Ant1

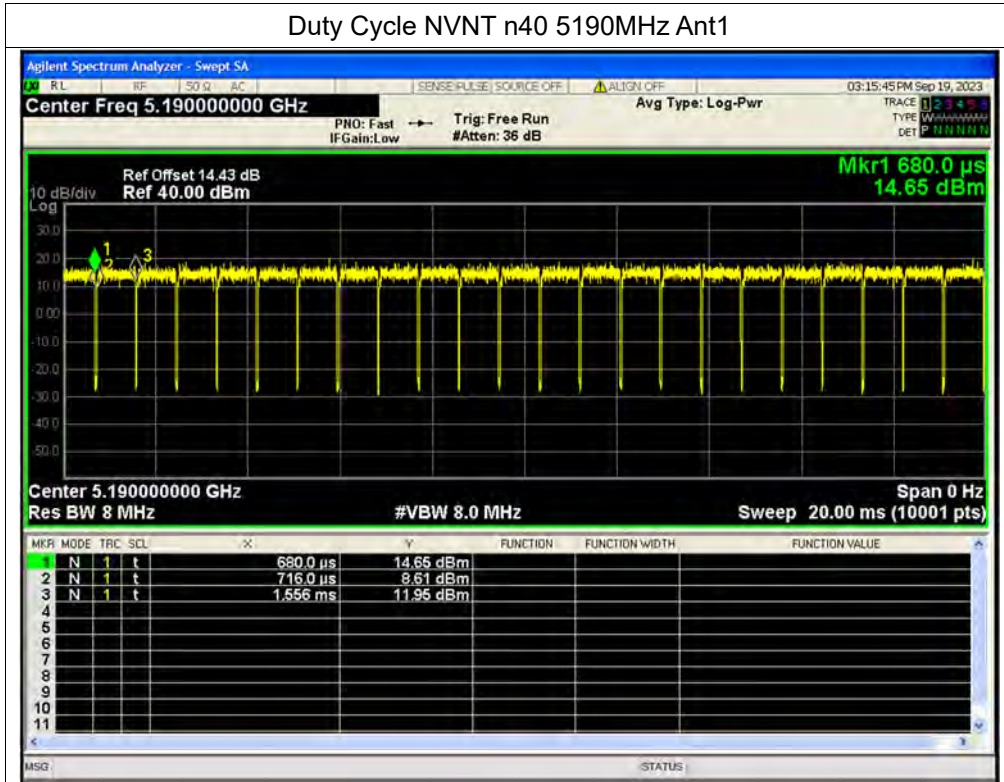

Duty Cycle NVNT n40 5230MHz Ant1

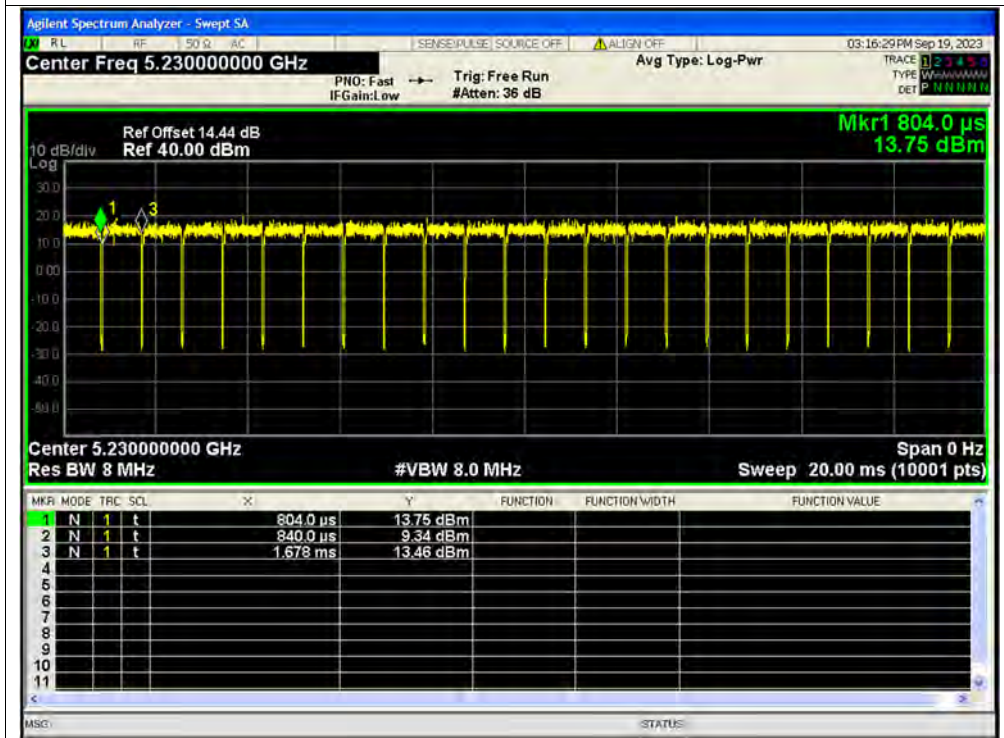





Duty Cycle NVNT n40 5270MHz Ant1

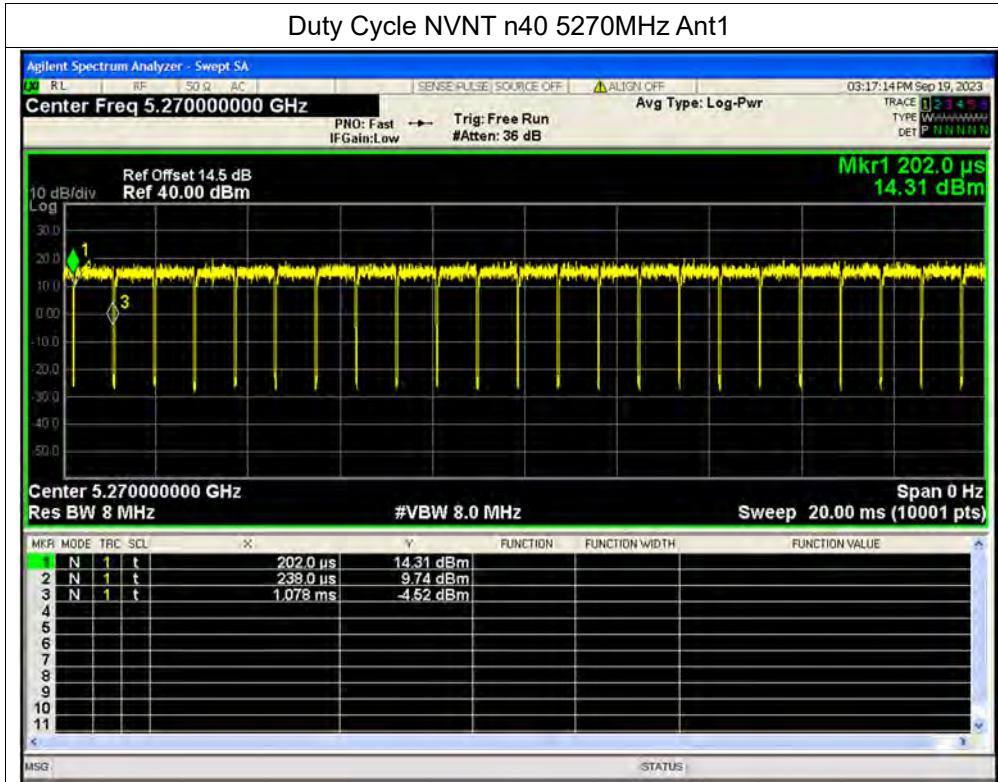

Duty Cycle NVNT n40 5310MHz Ant1

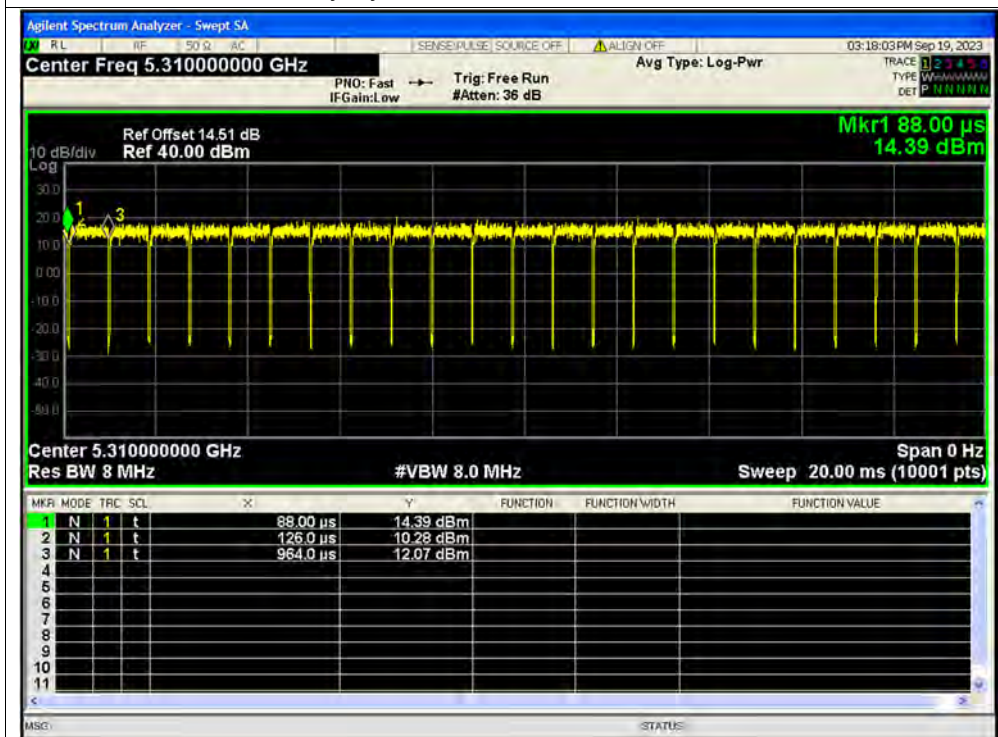



Duty Cycle NVNT n40 5510MHz Ant1

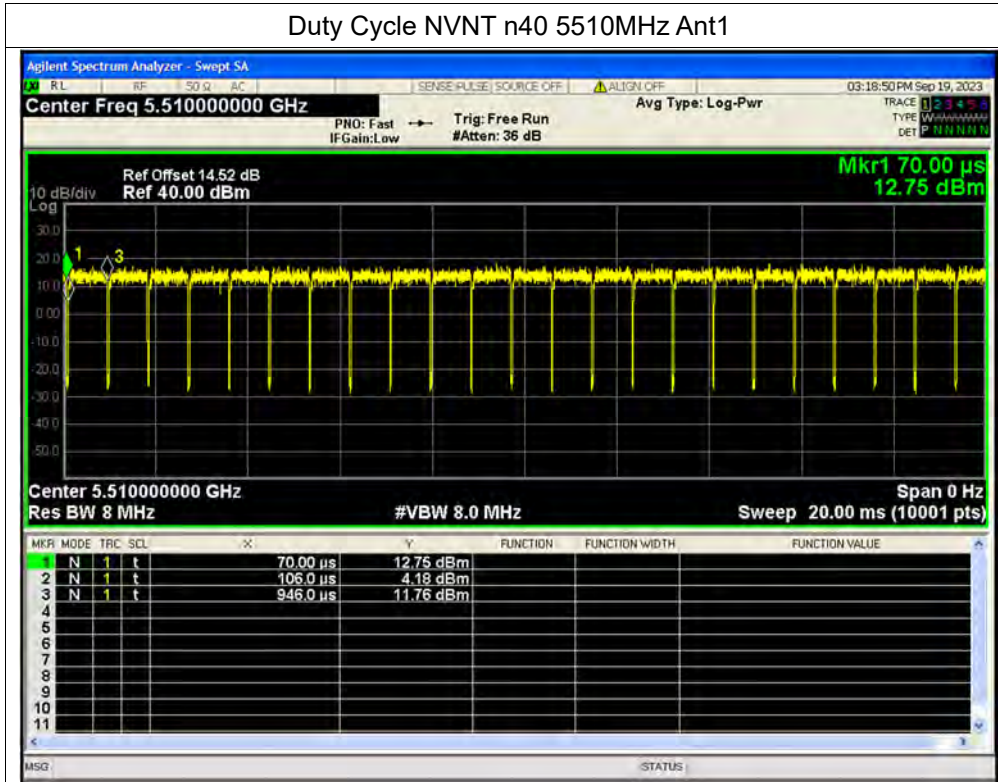

Duty Cycle NVNT n40 5550MHz Ant1

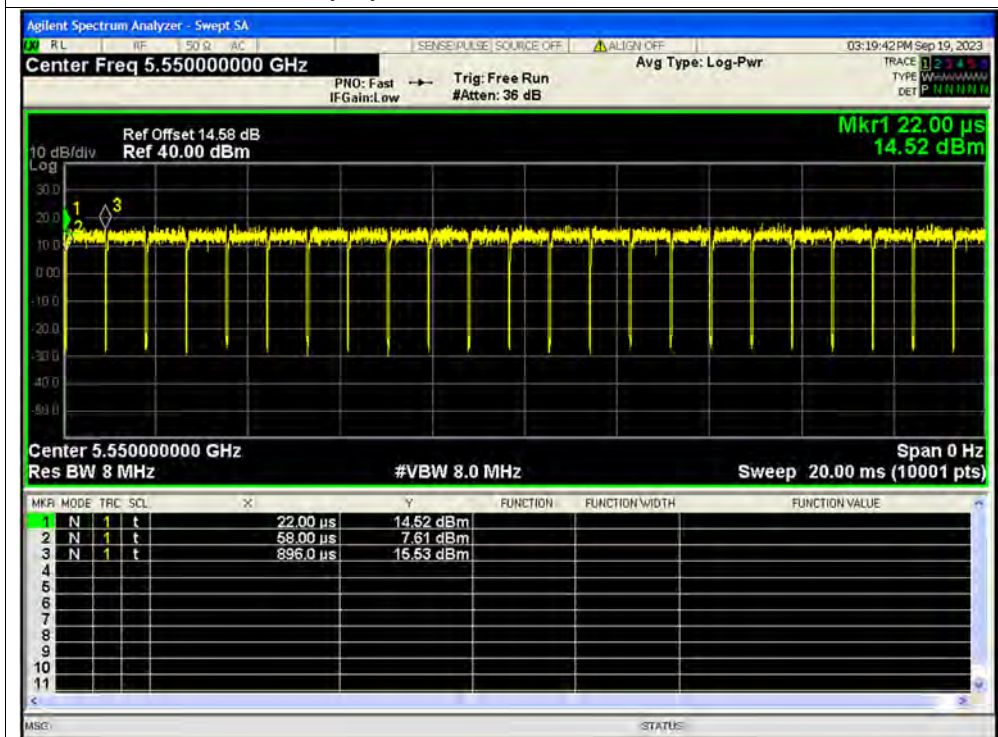





Duty Cycle NVNT n40 5630MHz Ant1

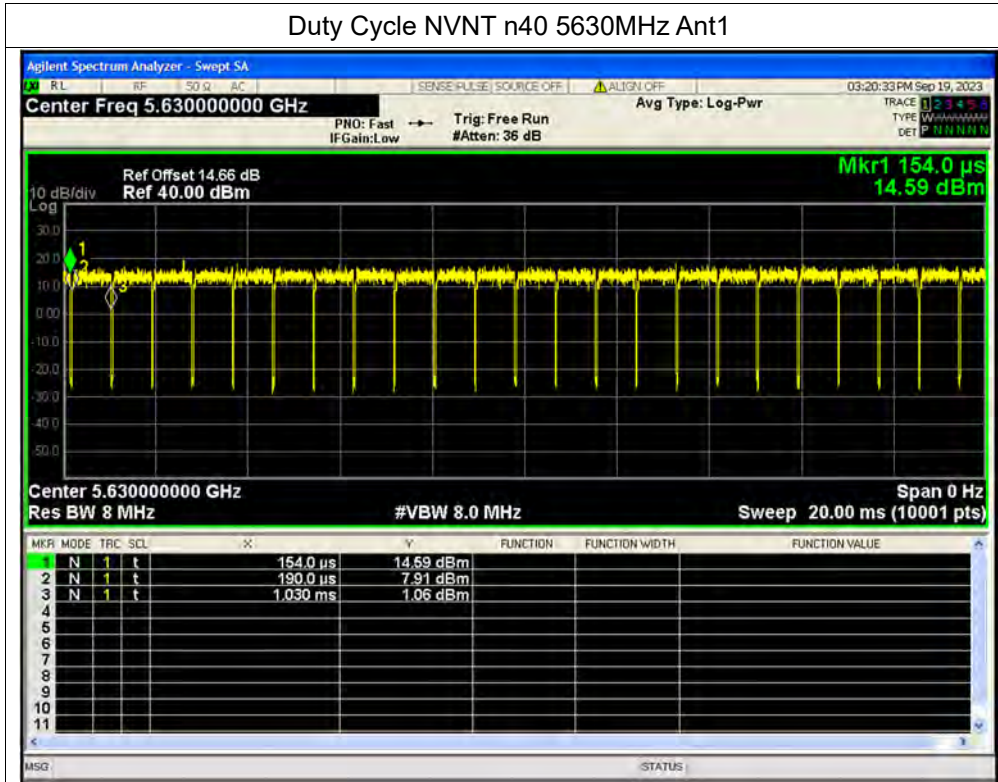

Duty Cycle NVNT n40 5710MHz Ant1

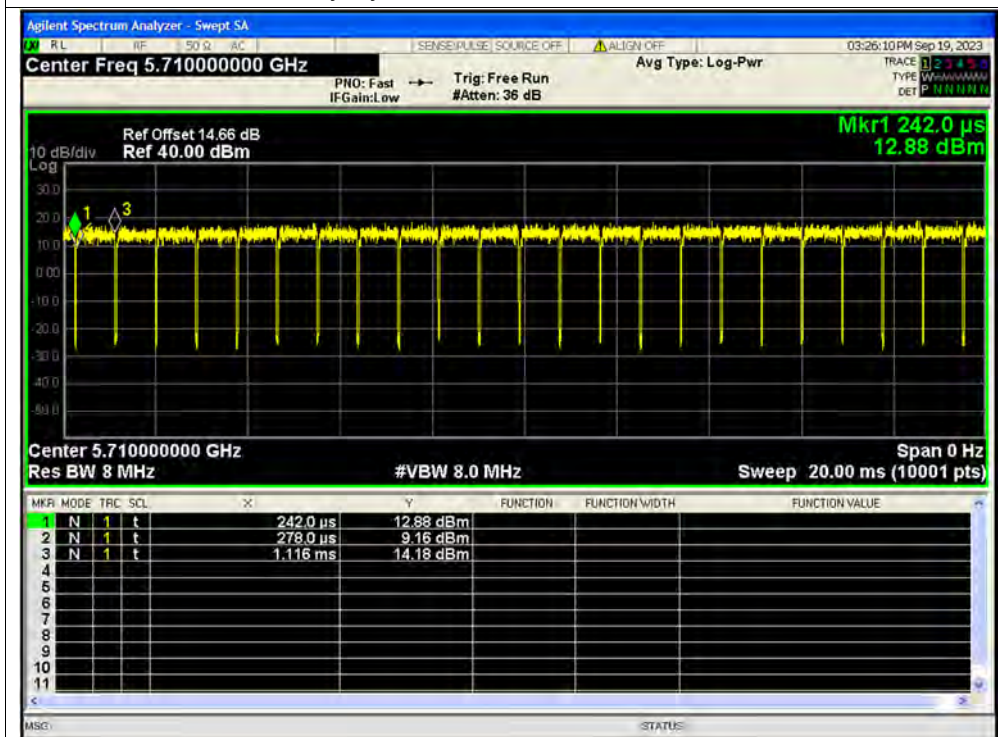



Duty Cycle NVNT n40 5755MHz Ant1

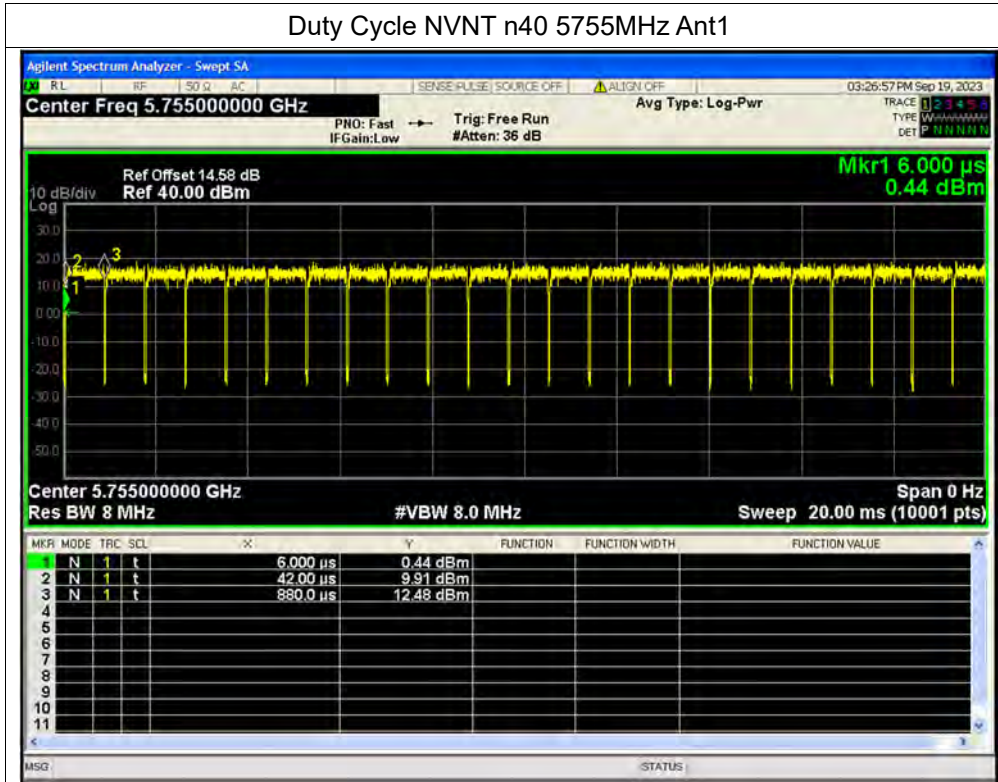

Duty Cycle NVNT n40 5795MHz Ant1

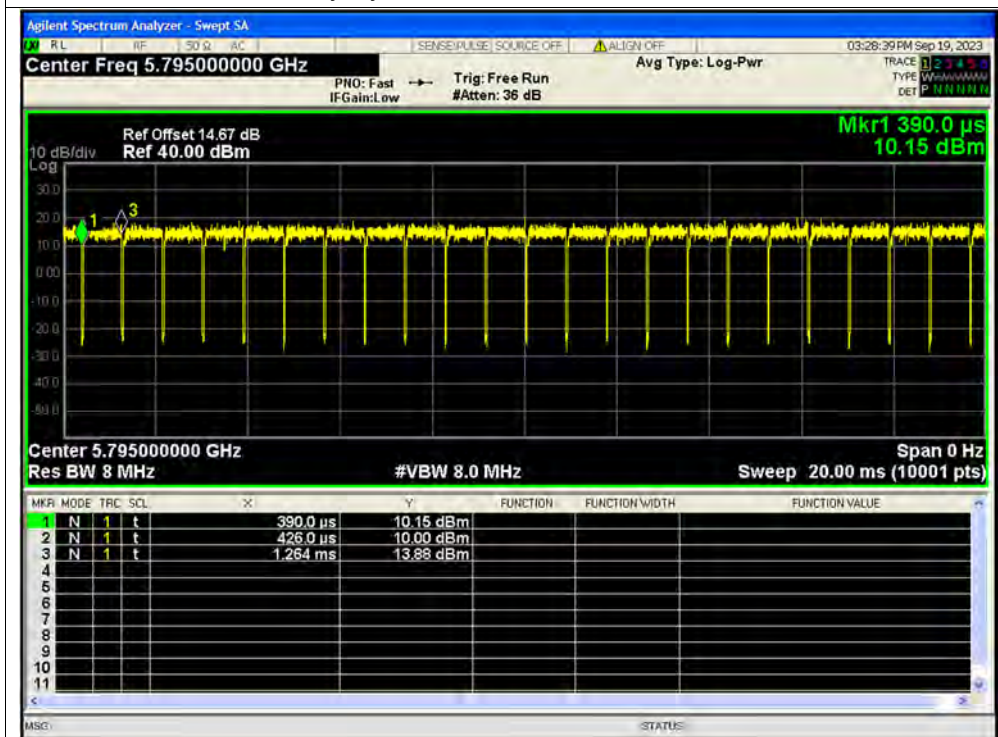





Duty Cycle NVNT ac20 5180MHz Ant1

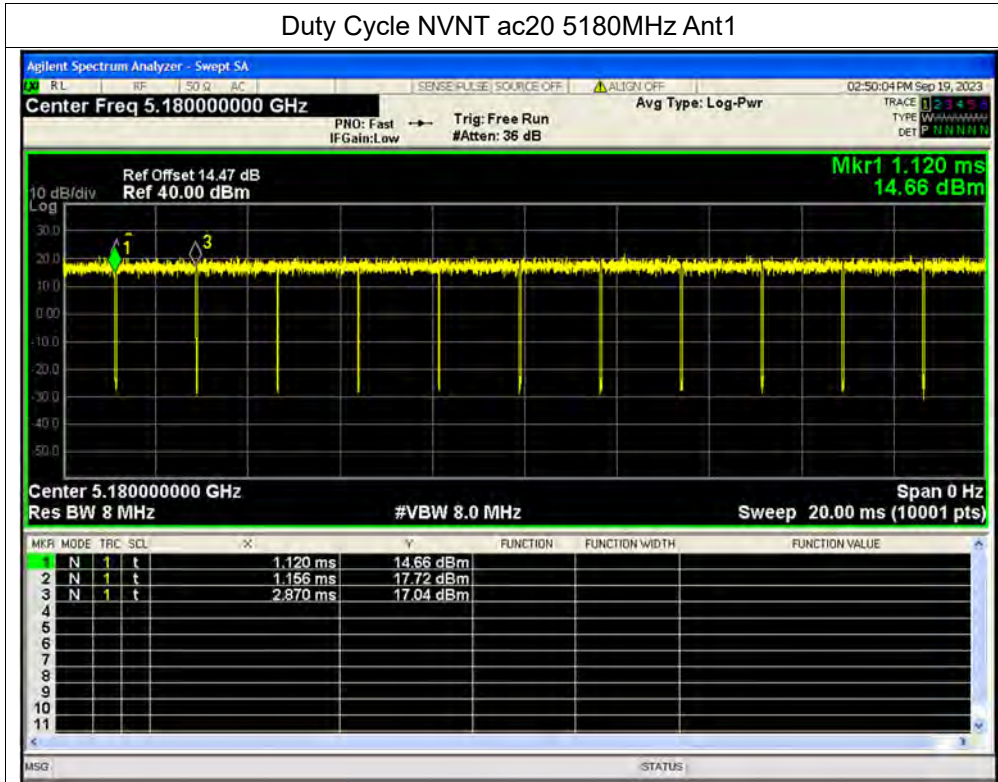

Duty Cycle NVNT ac20 5220MHz Ant1

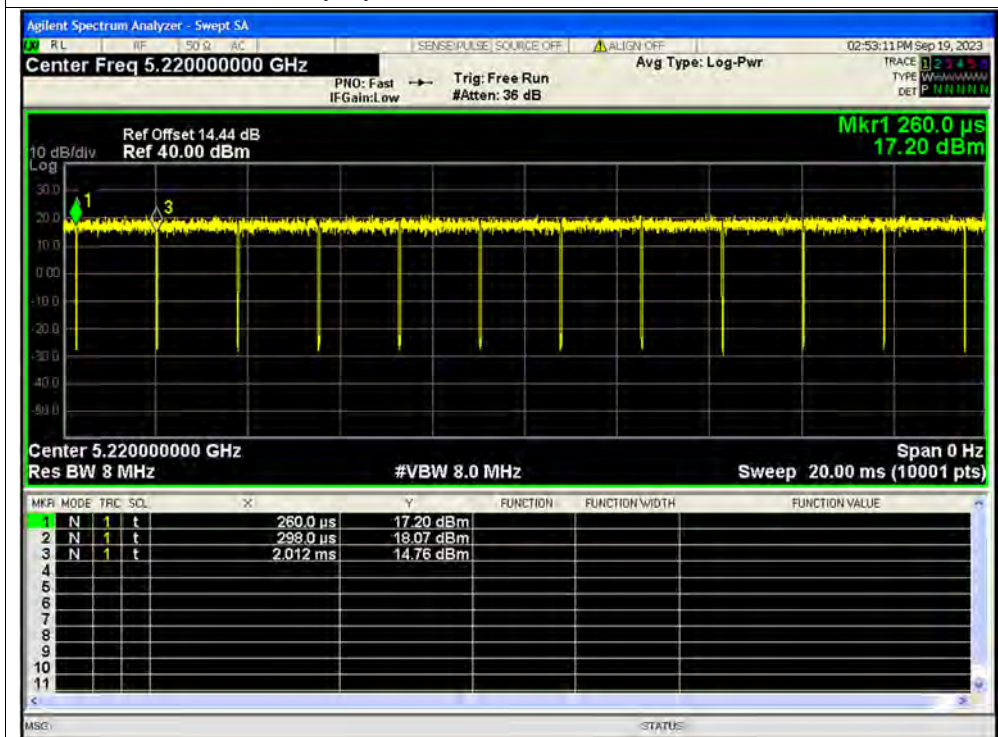



Duty Cycle NVNT ac20 5240MHz Ant1

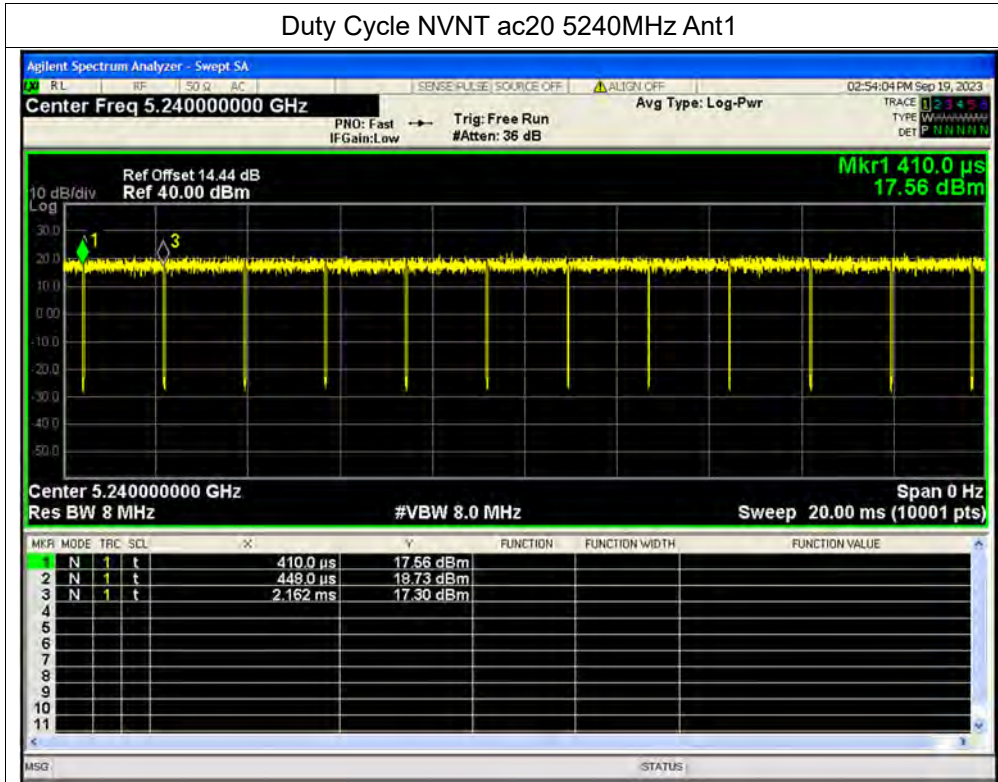

Duty Cycle NVNT ac20 5260MHz Ant1

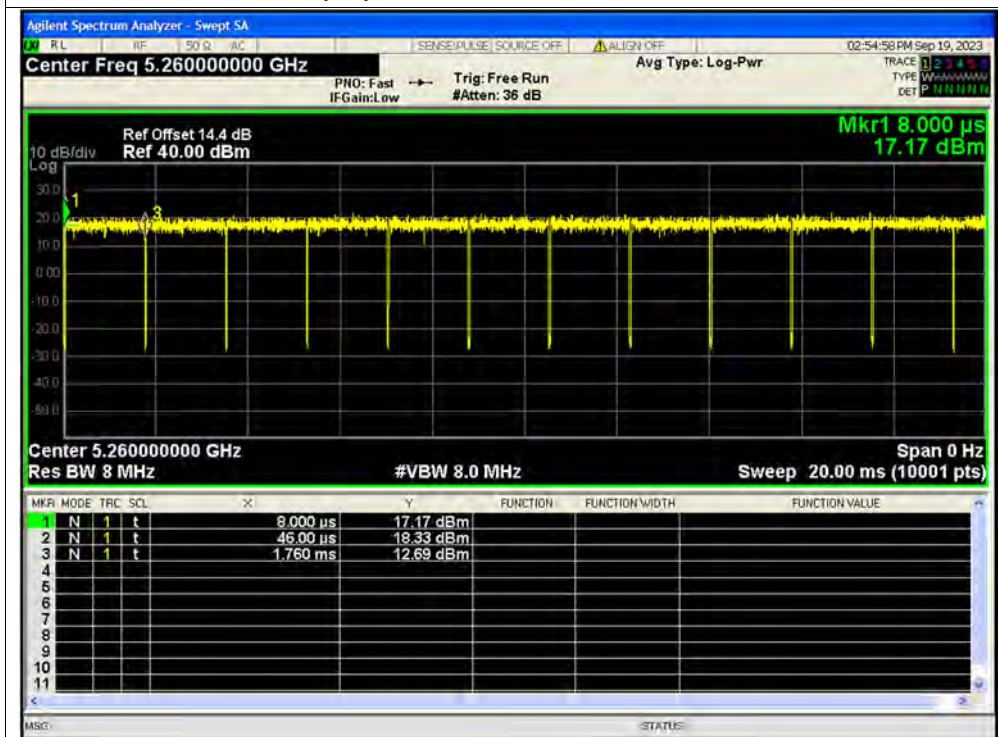



Duty Cycle NVNT ac20 5300MHz Ant1

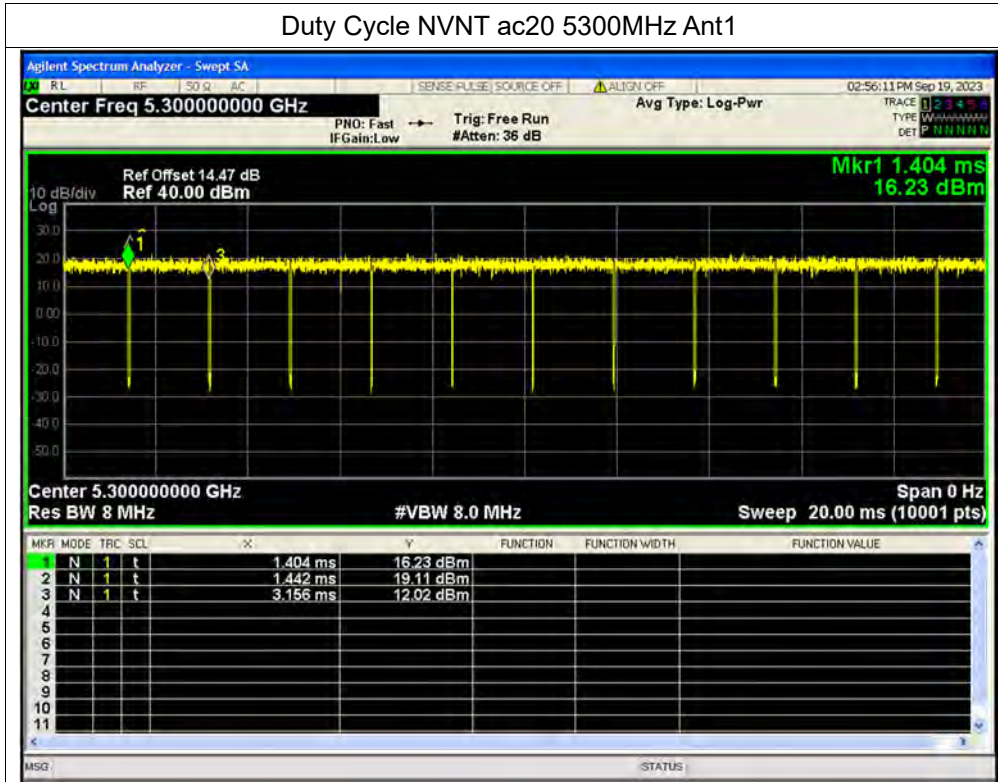

Duty Cycle NVNT ac20 5320MHz Ant1

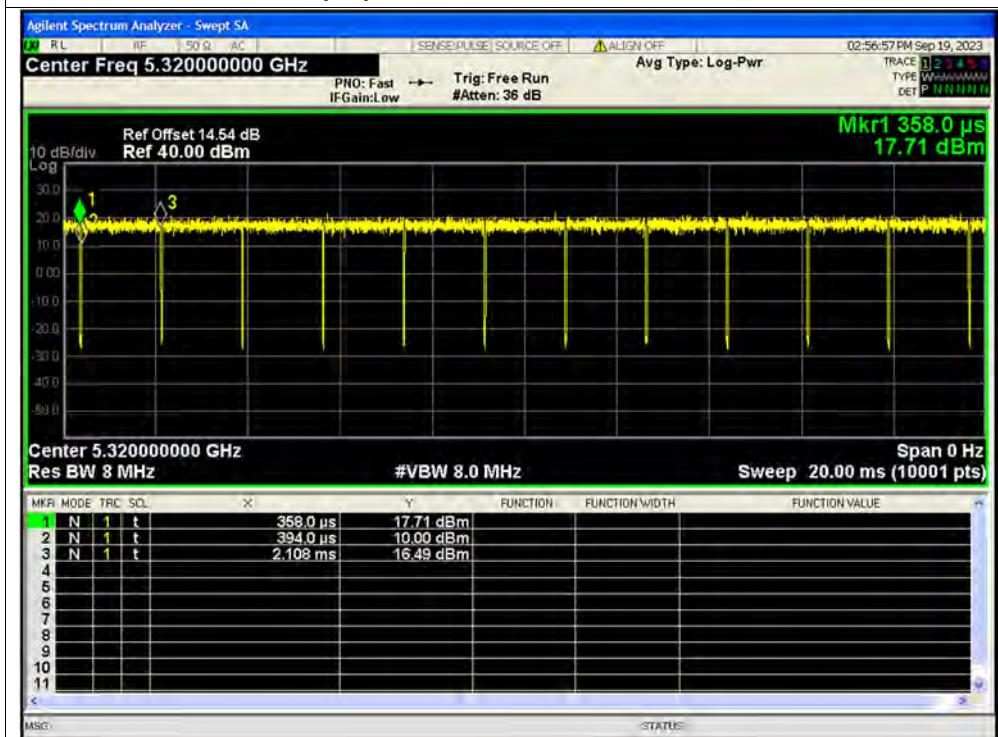





Duty Cycle NVNT ac20 5500MHz Ant1

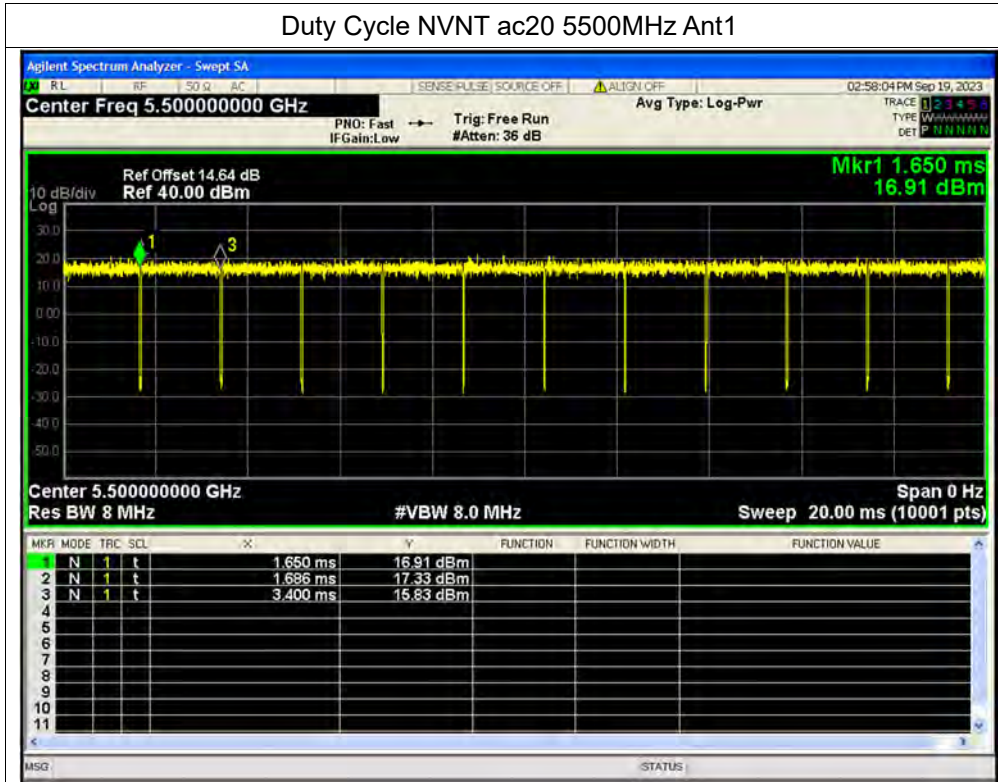

Duty Cycle NVNT ac20 5580MHz Ant1

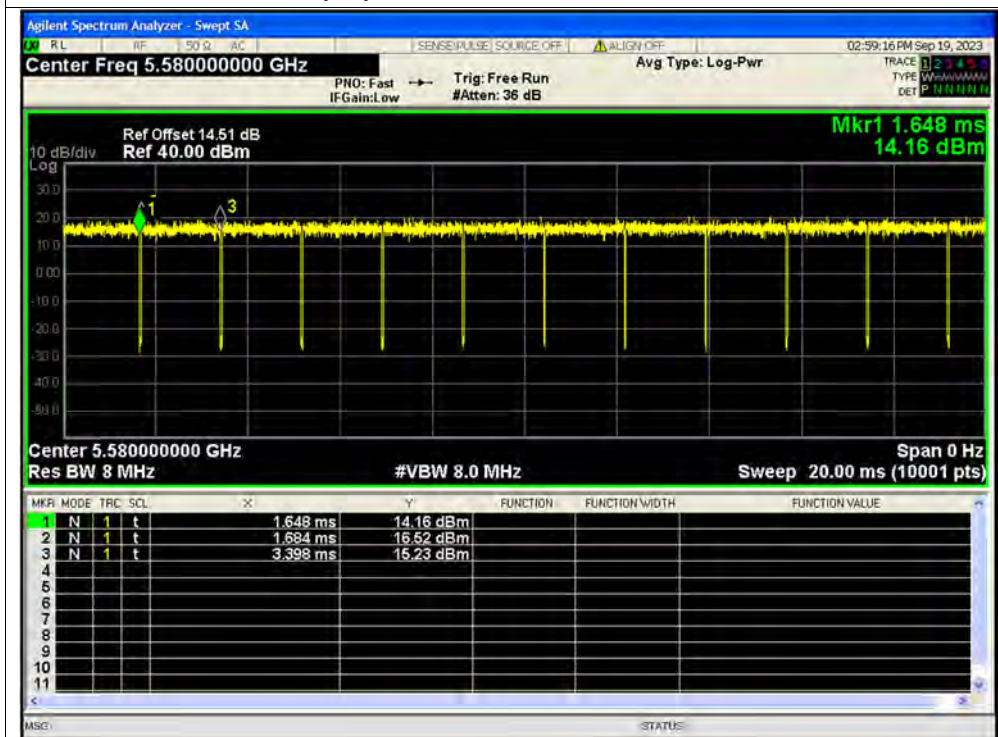





Duty Cycle NVNT ac20 5600MHz Ant1

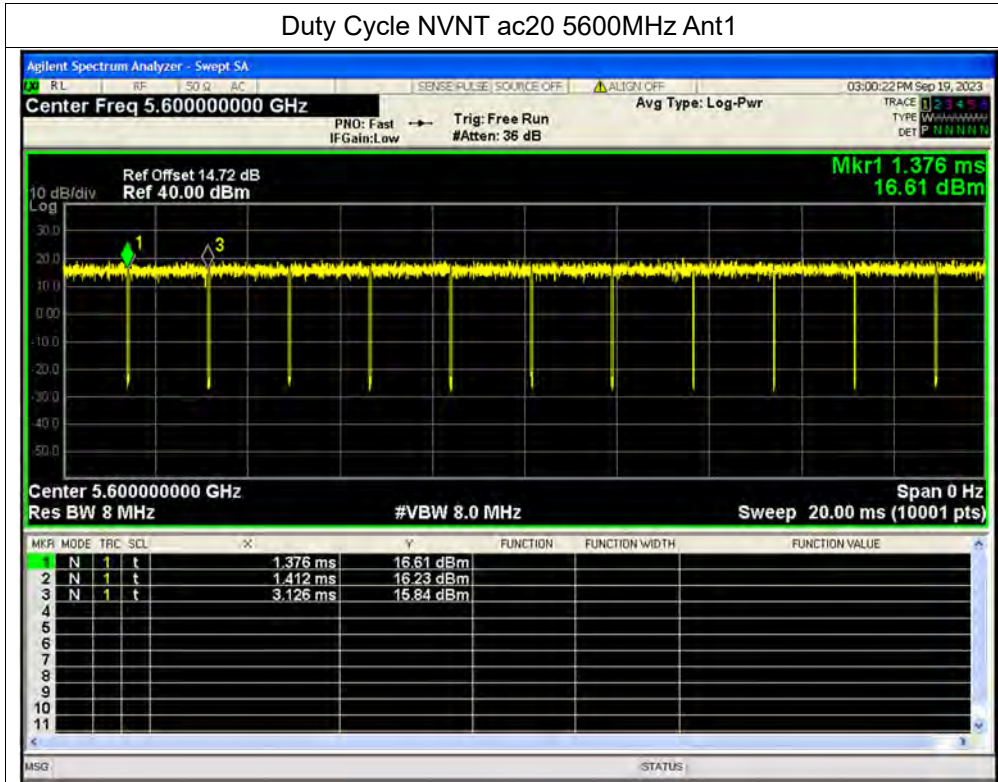

Duty Cycle NVNT ac20 5720MHz Ant1

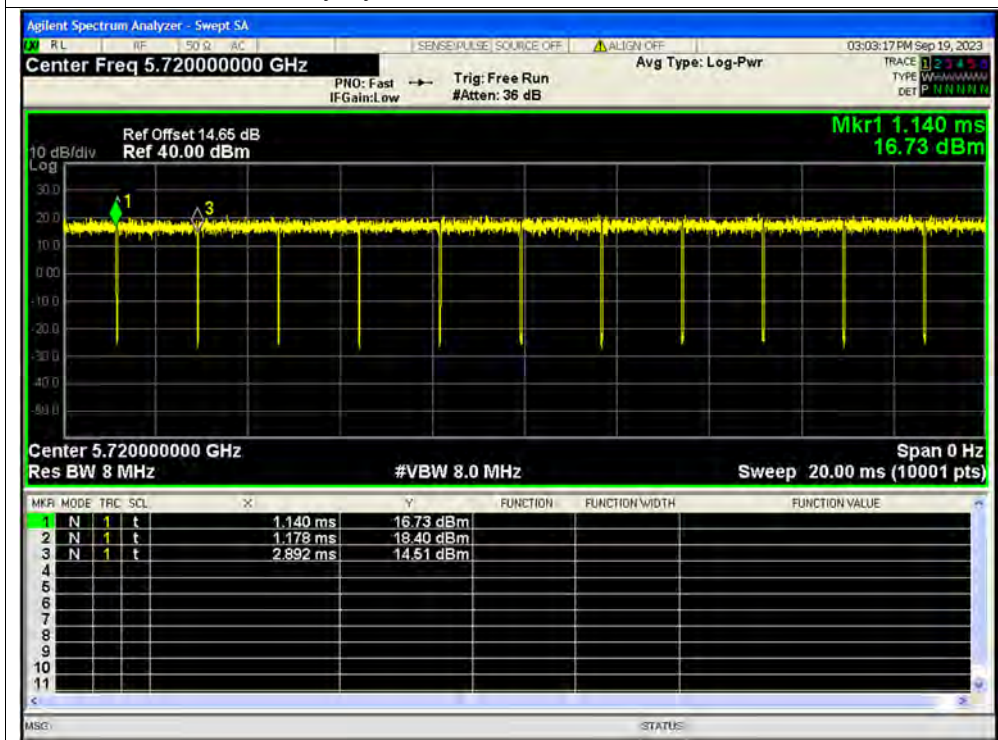



Duty Cycle NVNT ac20 5745MHz Ant1

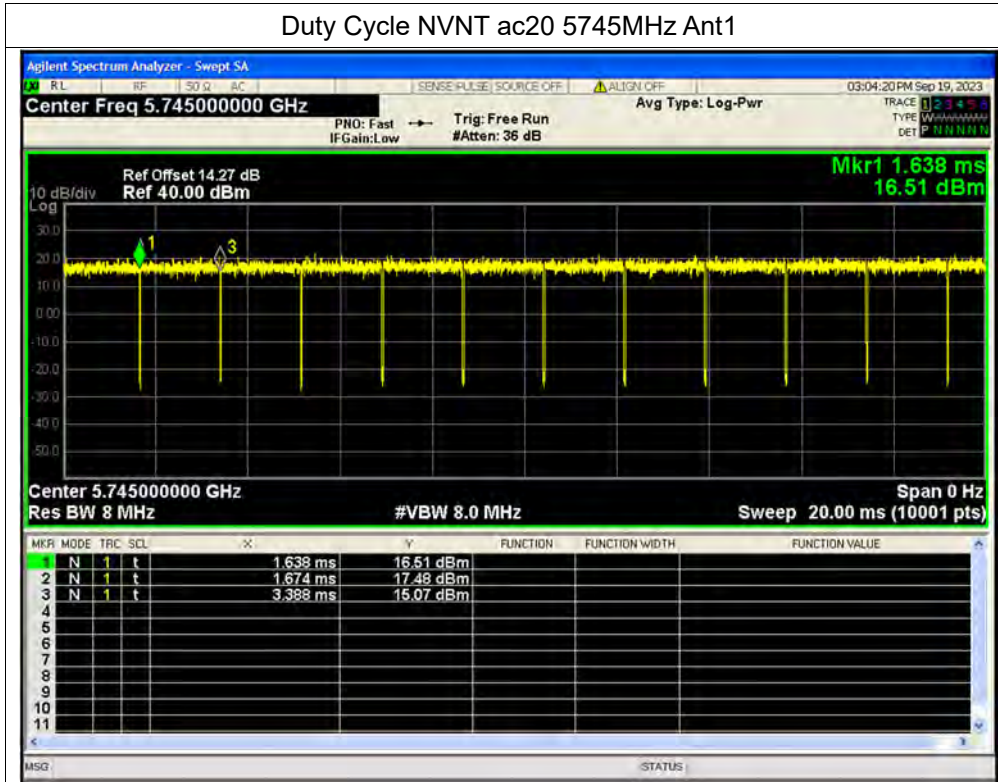

Duty Cycle NVNT ac20 5785MHz Ant1

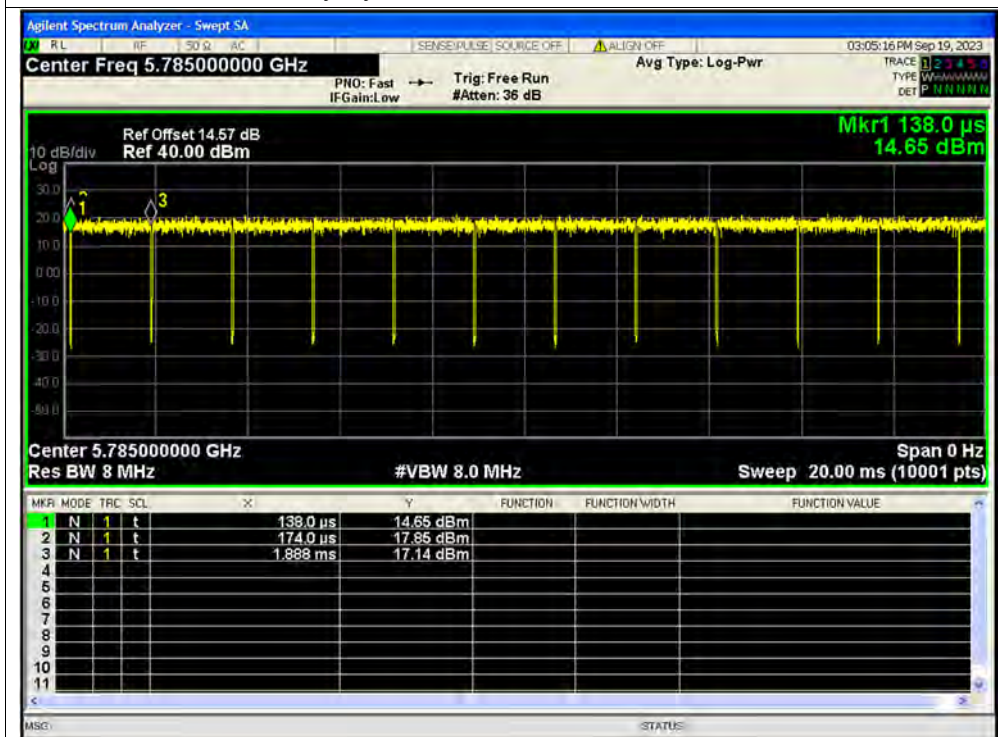



Duty Cycle NVNT ac20 5825MHz Ant1

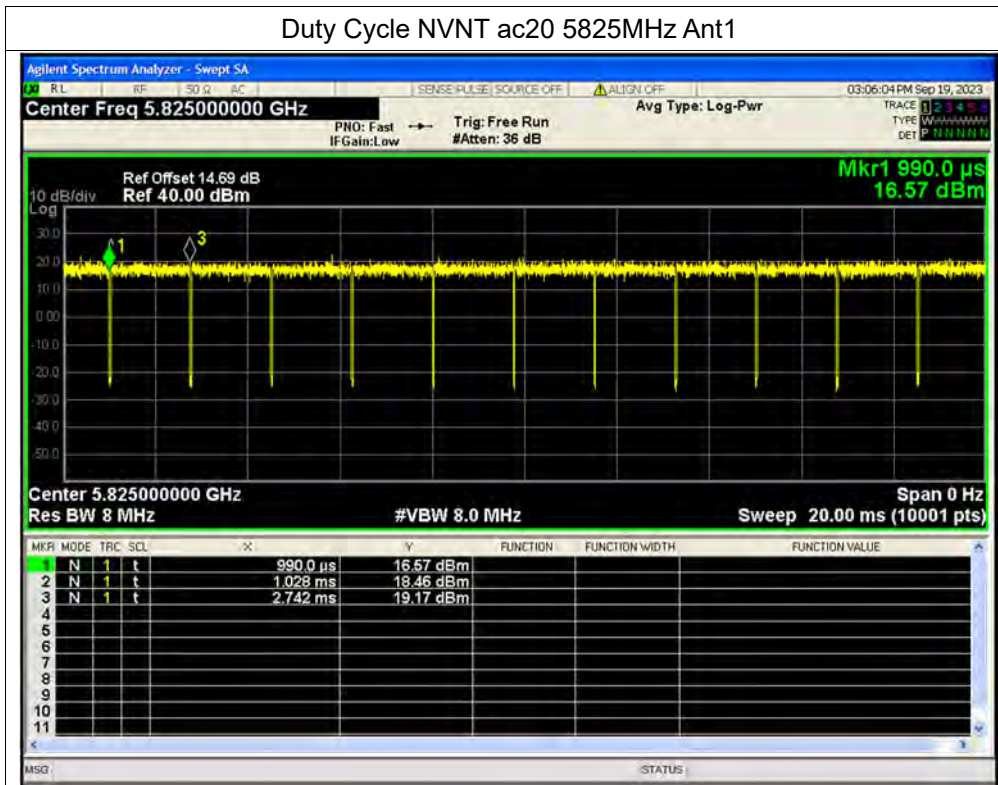

Duty Cycle NVNT ac40 5190MHz Ant1

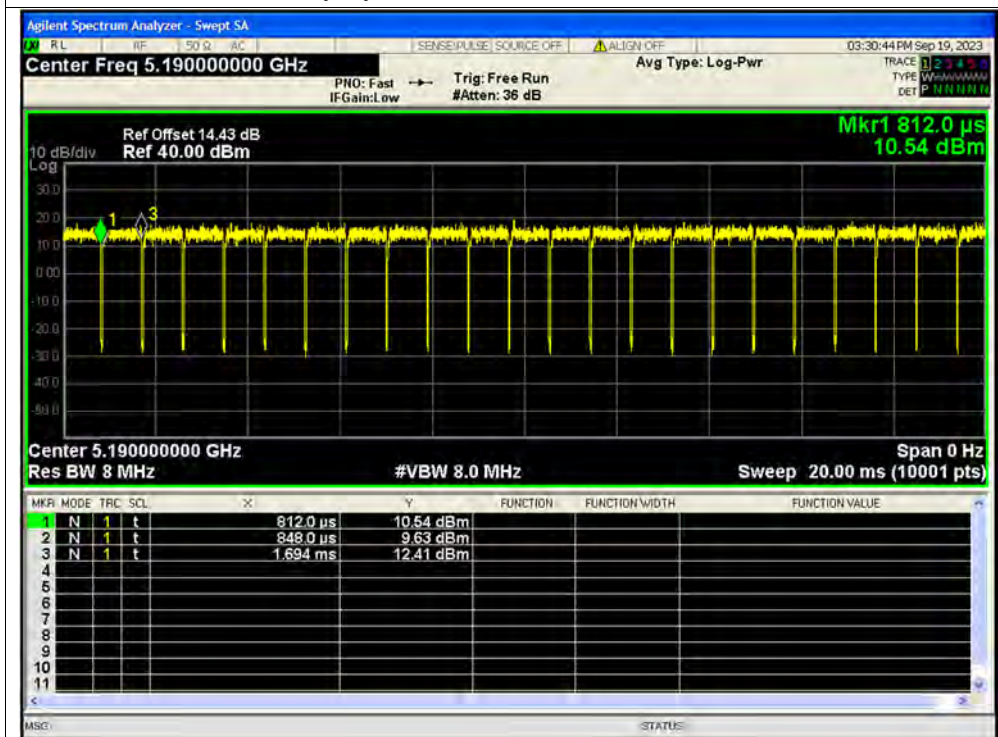





Duty Cycle NVNT ac40 5230MHz Ant1

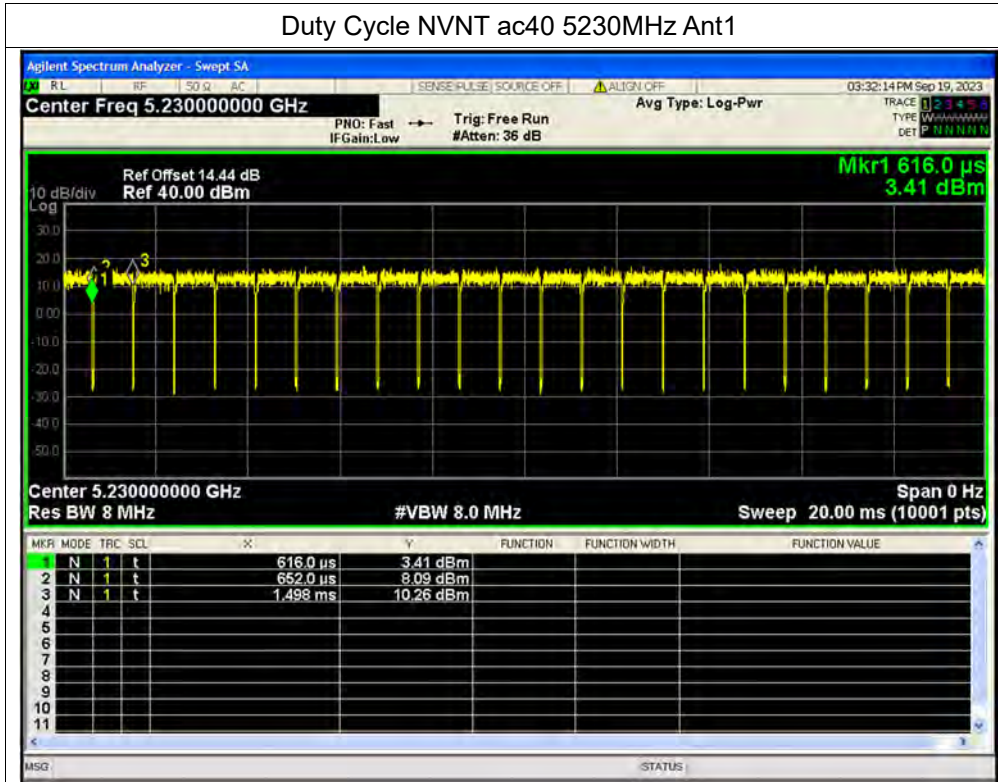

Duty Cycle NVNT ac40 5270MHz Ant1

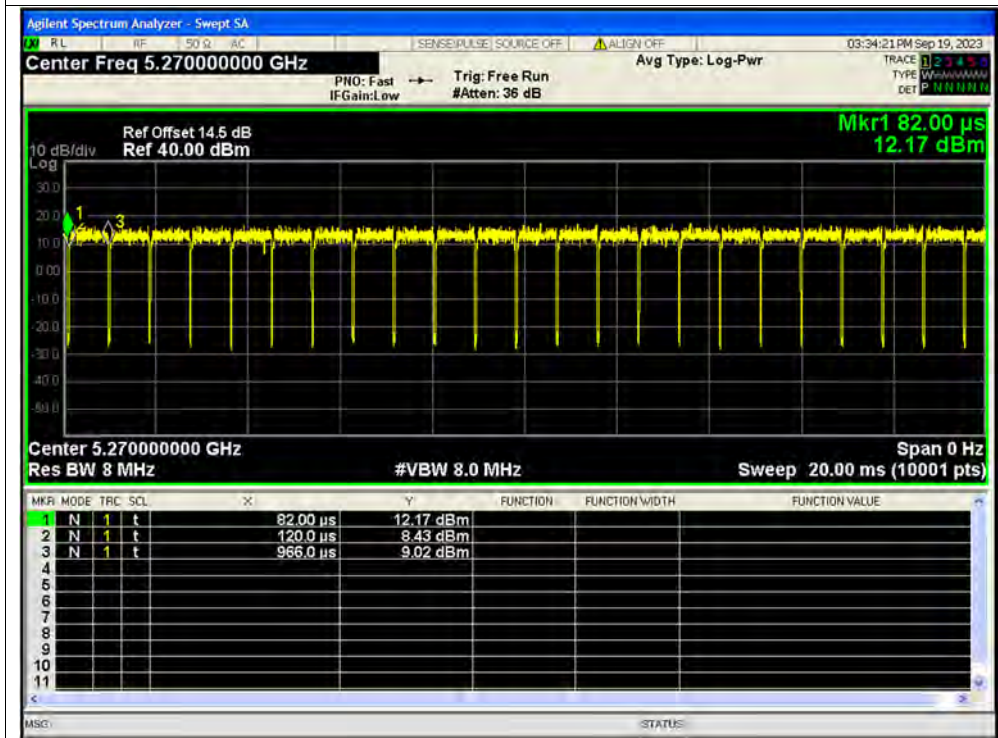



Duty Cycle NVNT ac40 5310MHz Ant1

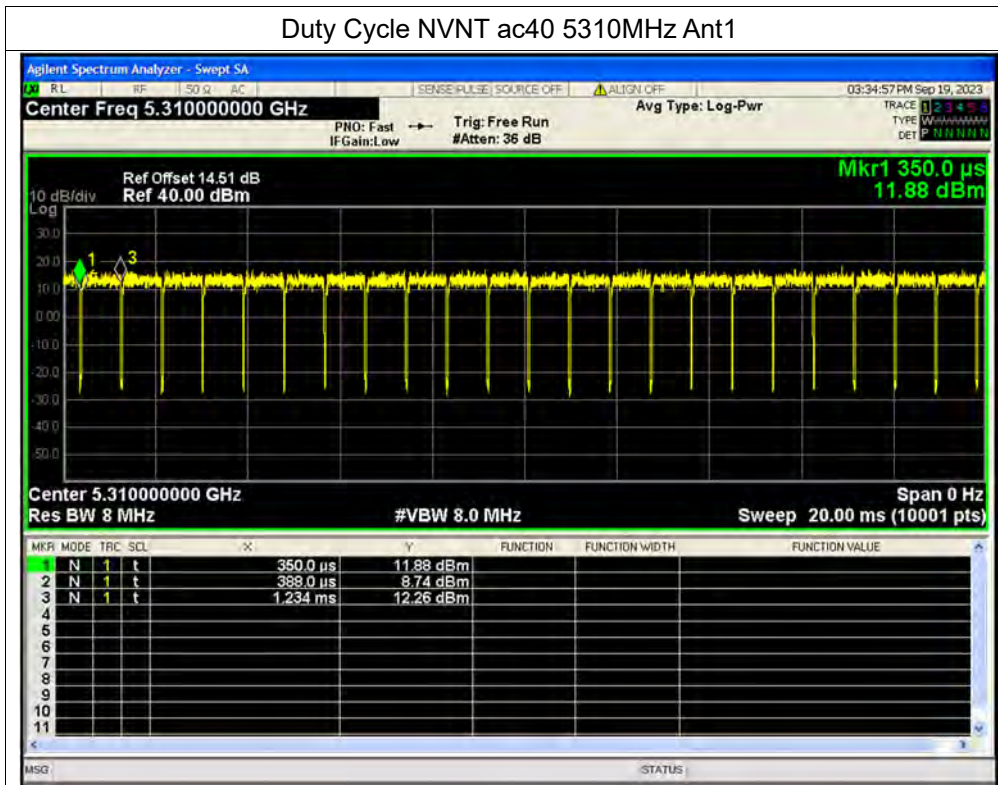

Duty Cycle NVNT ac40 5510MHz Ant1

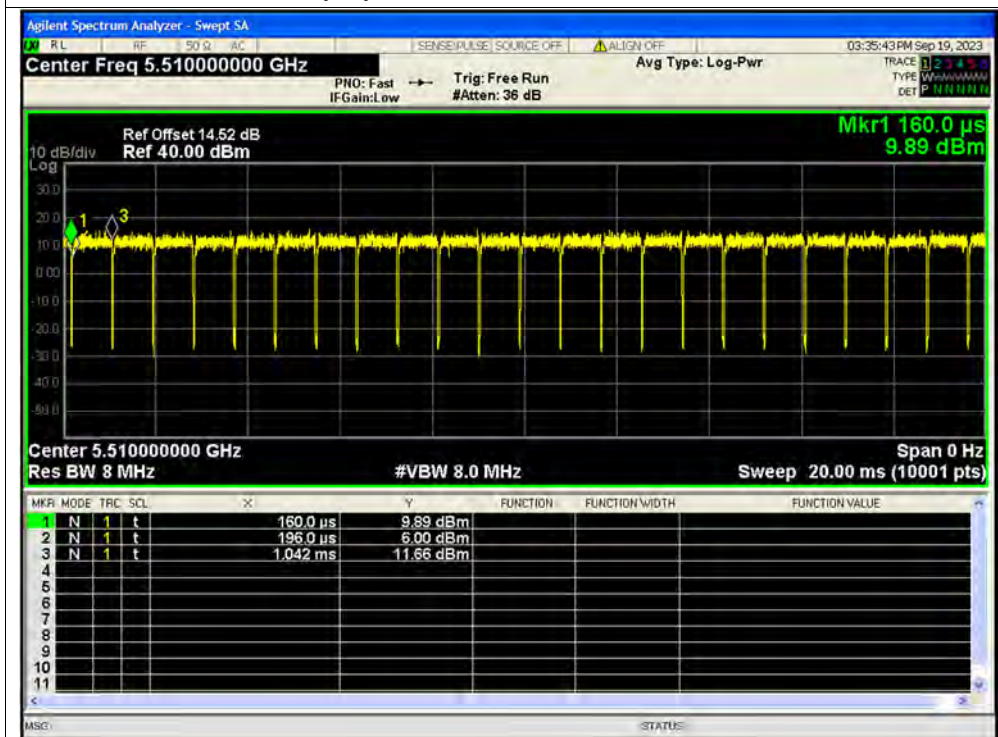





Duty Cycle NVNT ac40 5550MHz Ant1

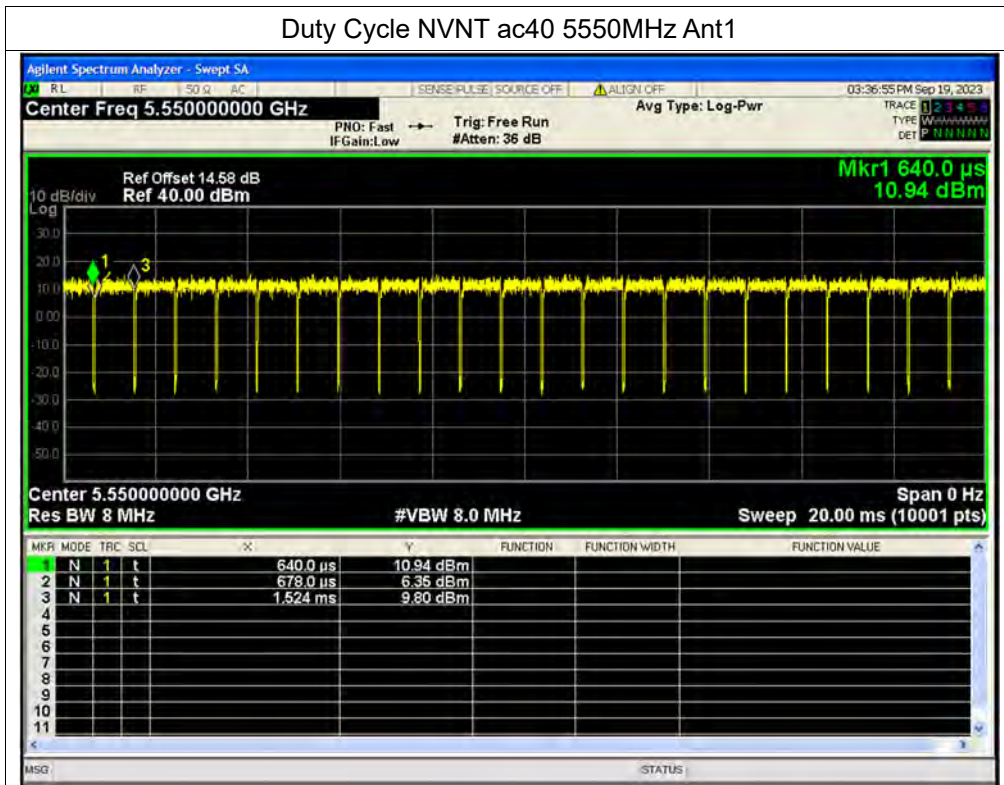

Duty Cycle NVNT ac40 5630MHz Ant1

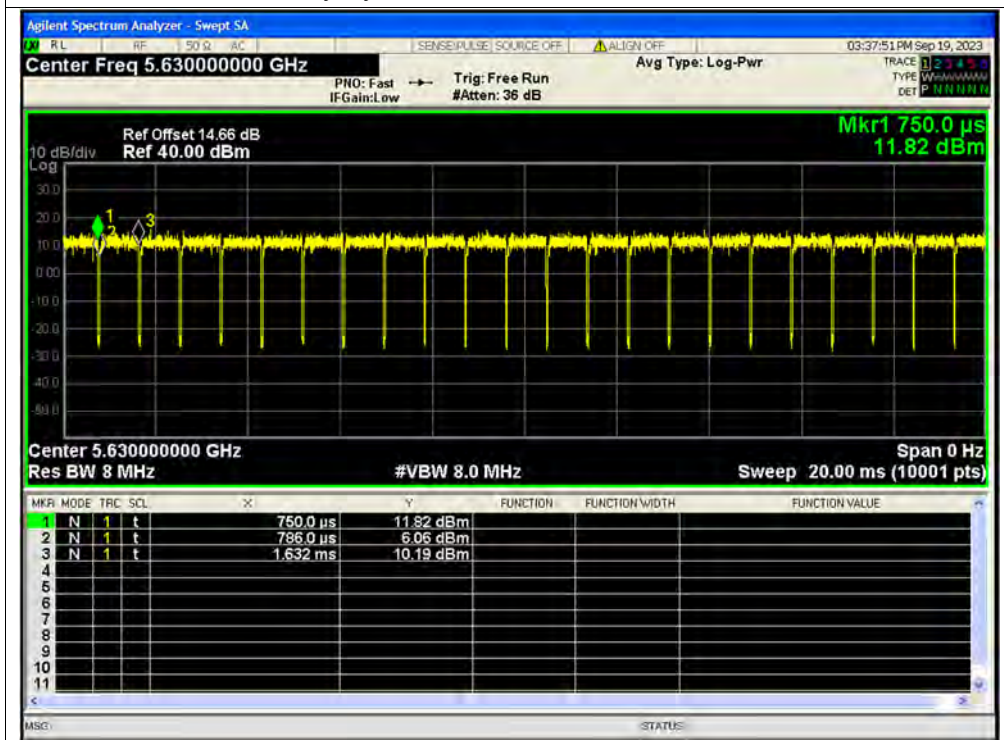



Duty Cycle NVNT ac40 5710MHz Ant1

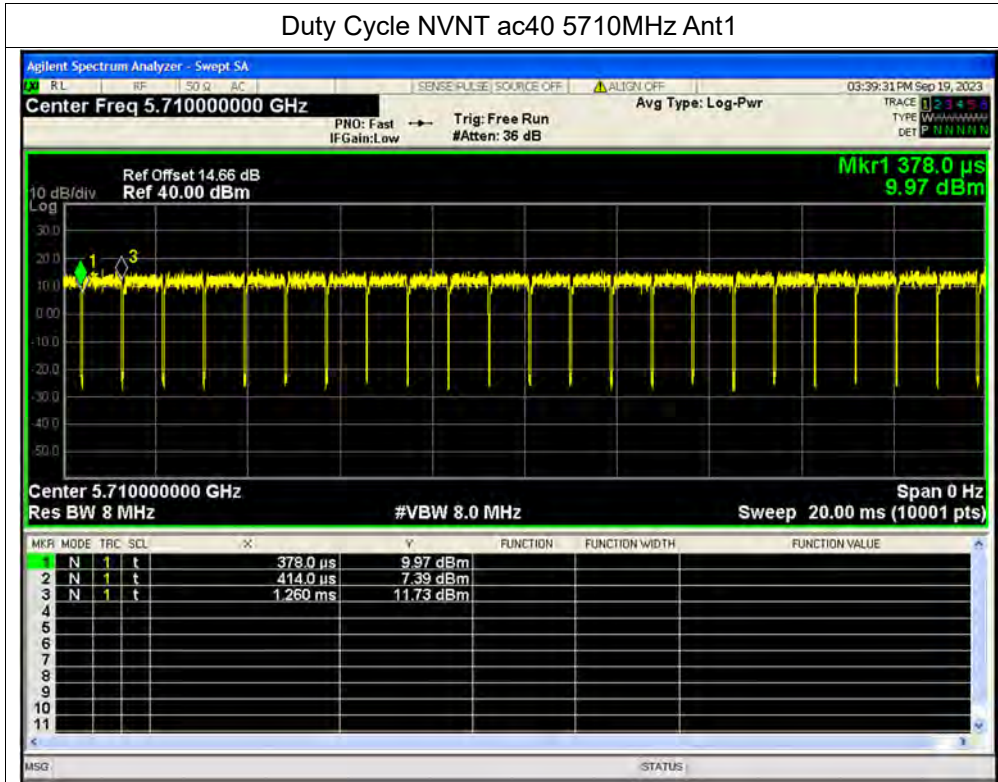

Duty Cycle NVNT ac40 5755MHz Ant1

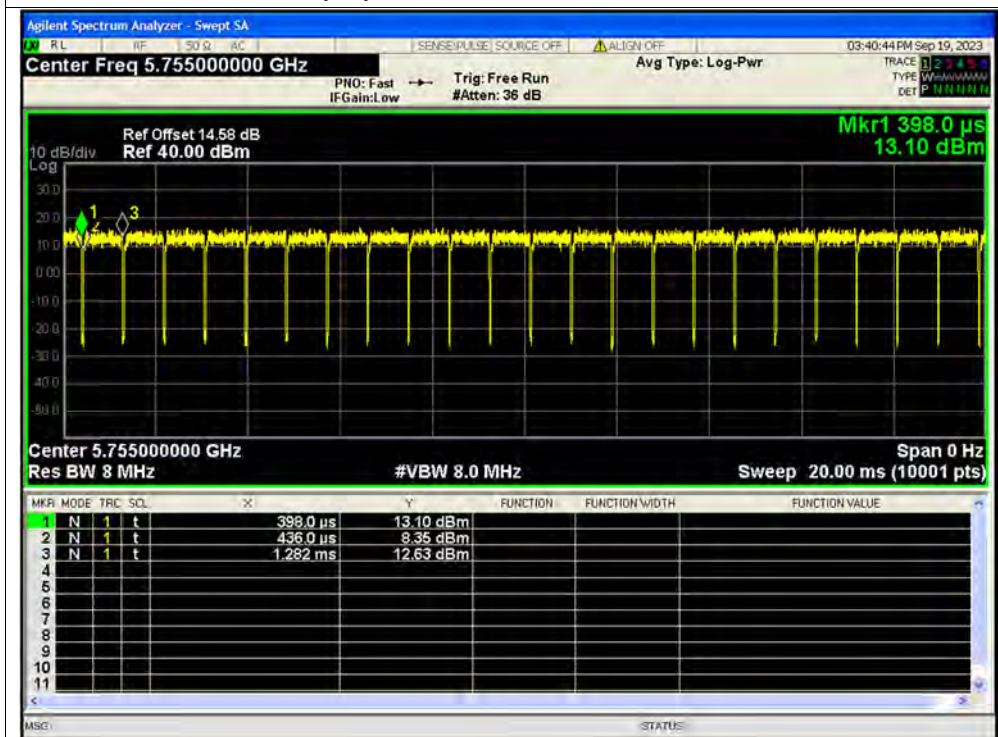





Duty Cycle NVNT ac40 5795MHz Ant1

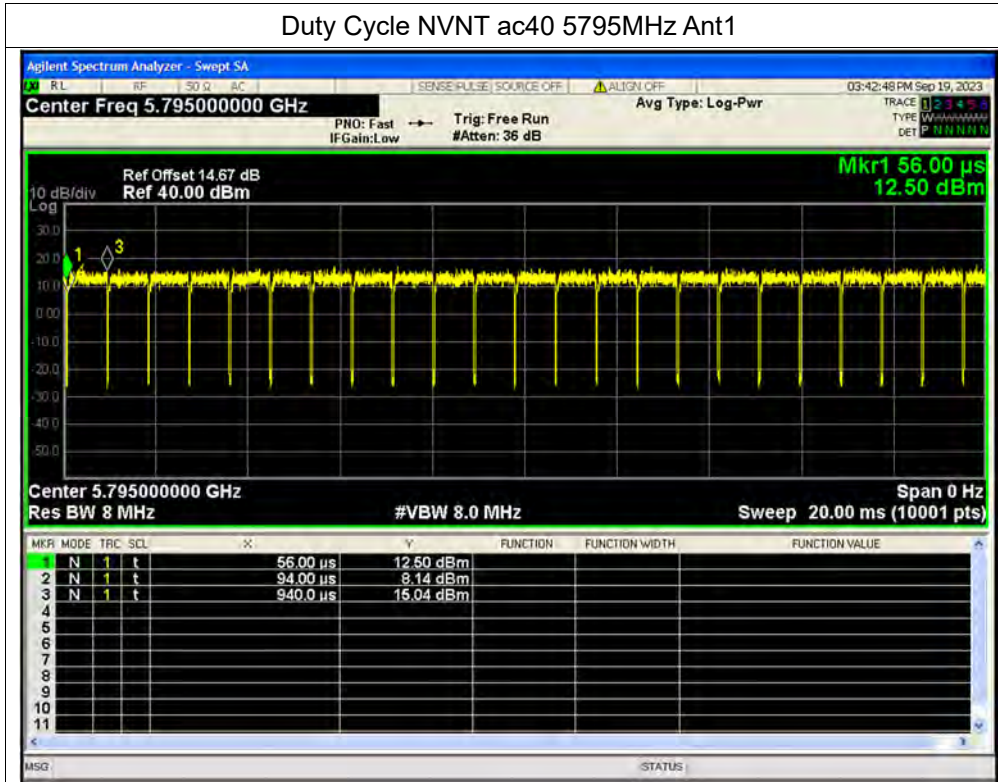

Duty Cycle NVNT ac80 5210MHz Ant1

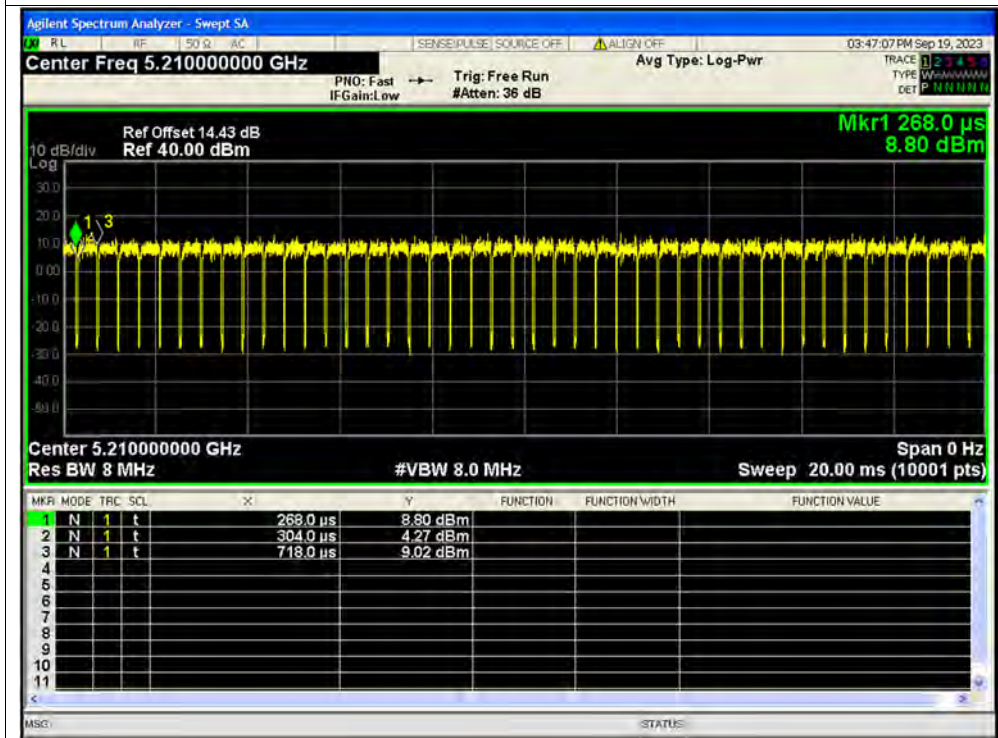





Duty Cycle NVNT ac80 5290MHz Ant1

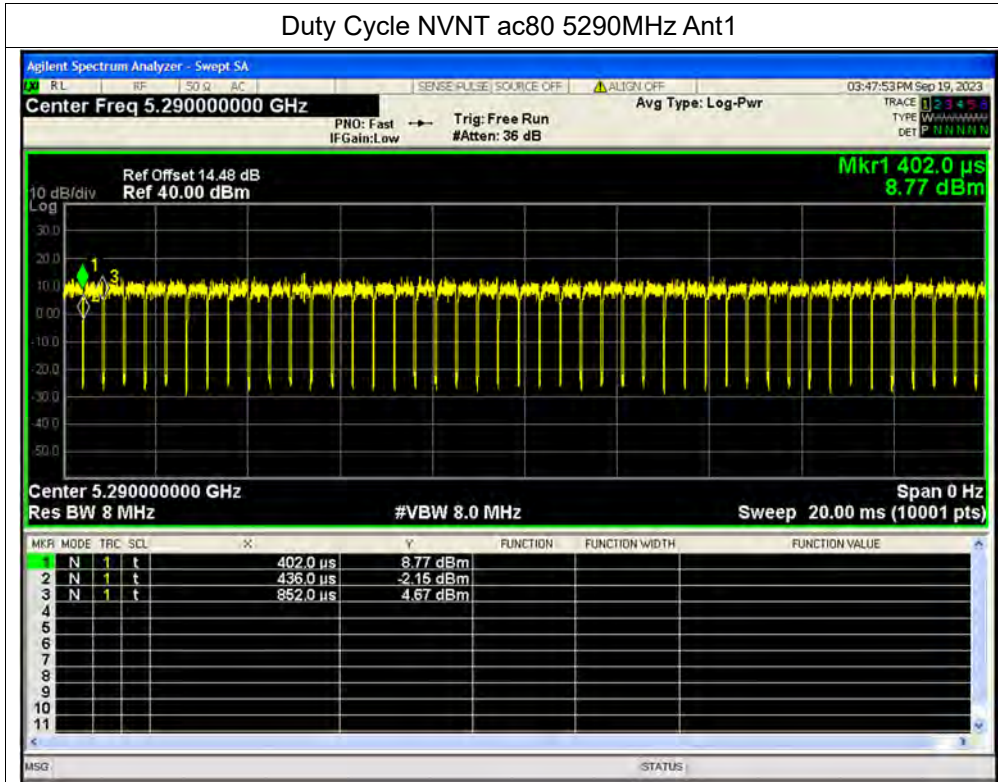

Duty Cycle NVNT ac80 5530MHz Ant1

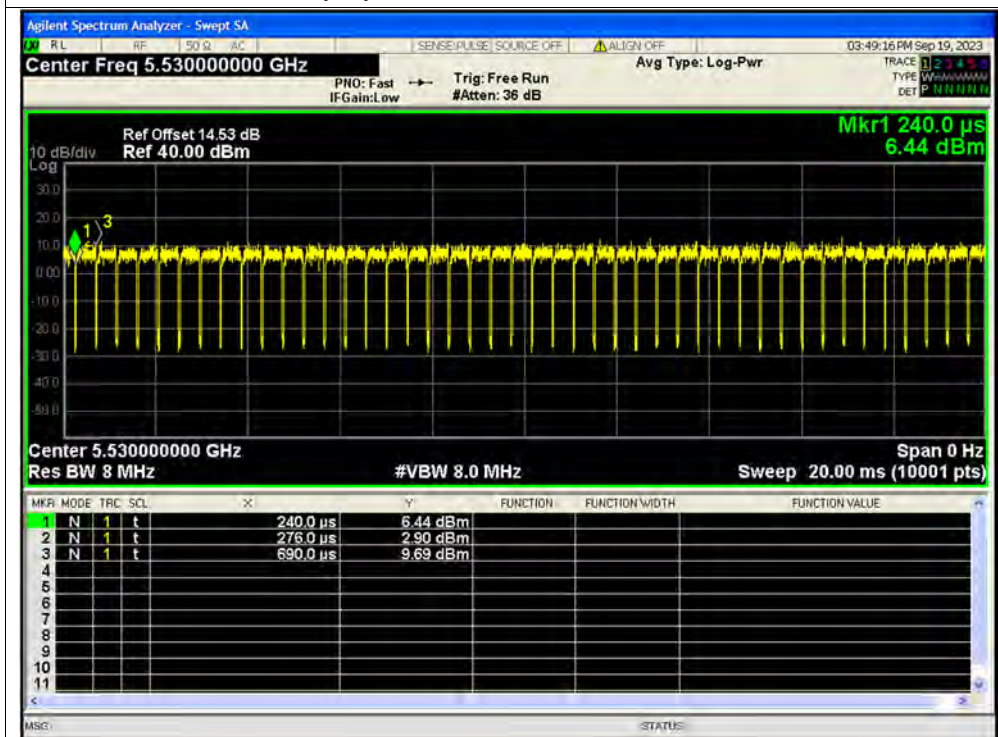



Duty Cycle NVNT ac80 5610MHz Ant1

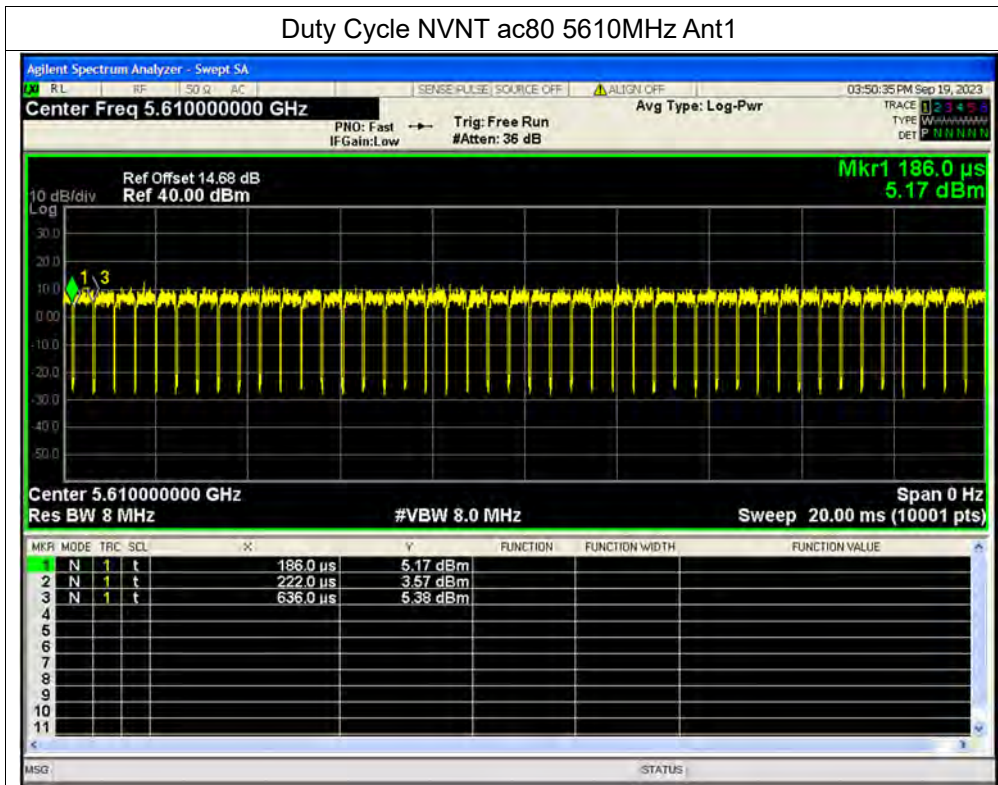

Duty Cycle NVNT ac80 5690MHz Ant1

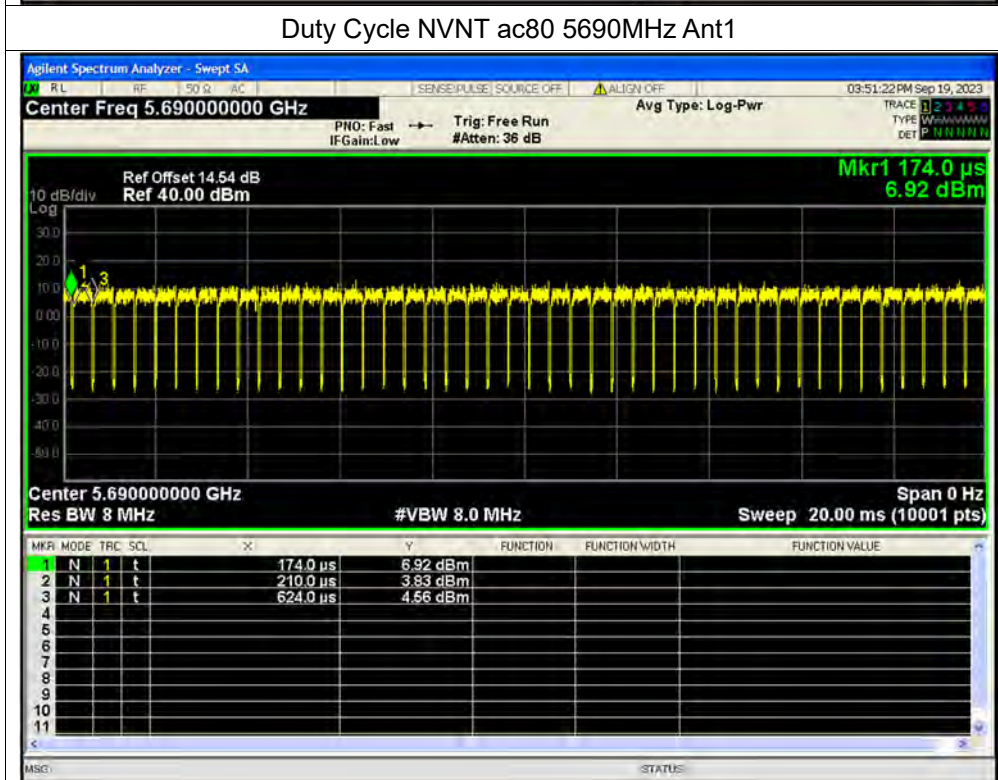

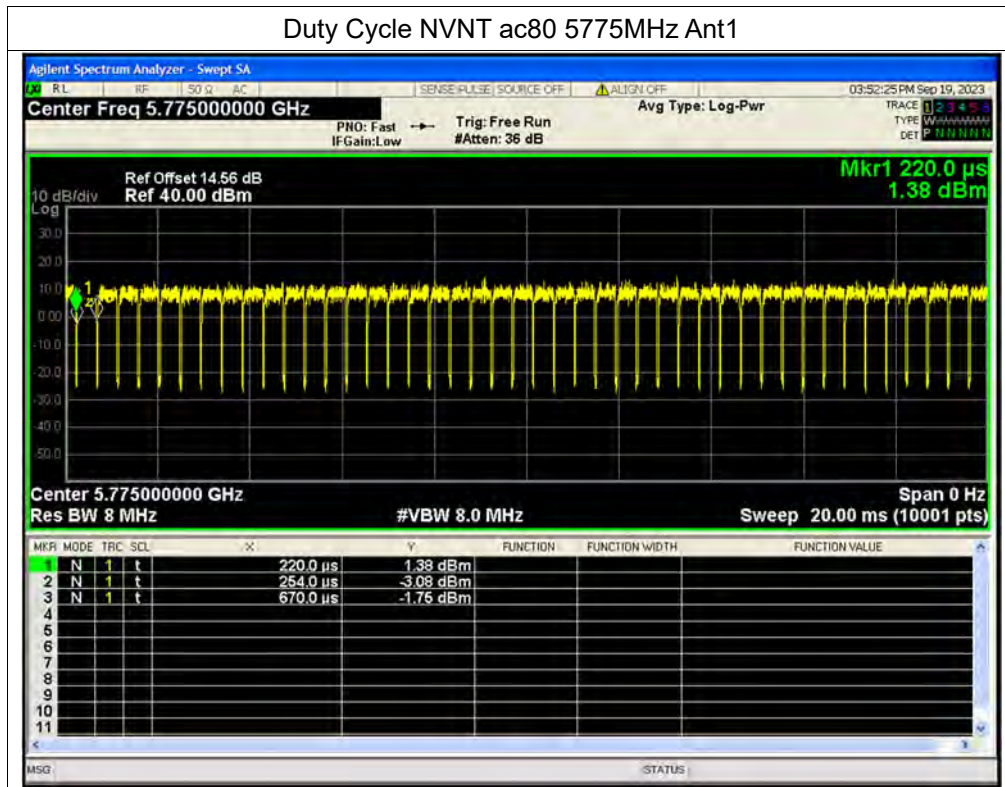



**A.2. Maximum Conducted Output Power**

Condition	Mode	Frequency (MHz)	Antenna	Total Conducted Power (dBm)	Total Conducted Power (W)	Limit (dBm)	Verdict
NVNT	a	5180	Ant1	15.53	0.03573	24	Pass
NVNT	a	5220	Ant1	16.7	0.04677	24	Pass
NVNT	a	5240	Ant1	16.43	0.04395	24	Pass
NVNT	a	5260	Ant1	16.59	0.0456	24	Pass
NVNT	a	5300	Ant1	16.1	0.04074	24	Pass
NVNT	a	5320	Ant1	15.34	0.0342	24	Pass
NVNT	a	5500	Ant1	15.78	0.03784	24	Pass
NVNT	a	5580	Ant1	15.75	0.03758	24	Pass
NVNT	a	5600	Ant1	16.07	0.04046	24	Pass
NVNT	a	5720	Ant1	16.68	0.04656	24	Pass
NVNT	a	5745	Ant1	16.48	0.04446	30	Pass
NVNT	a	5785	Ant1	16.58	0.0455	30	Pass
NVNT	a	5825	Ant1	16.28	0.04246	30	Pass
NVNT	n20	5180	Ant1	16.33	0.04295	24	Pass
NVNT	n20	5220	Ant1	16.54	0.04508	24	Pass
NVNT	n20	5240	Ant1	16.32	0.04285	24	Pass
NVNT	n20	5260	Ant1	16.49	0.04457	24	Pass
NVNT	n20	5300	Ant1	15.95	0.03936	24	Pass
NVNT	n20	5320	Ant1	15.25	0.0335	24	Pass
NVNT	n20	5500	Ant1	15.64	0.03664	24	Pass
NVNT	n20	5580	Ant1	15.52	0.03565	24	Pass
NVNT	n20	5600	Ant1	15.85	0.03846	24	Pass
NVNT	n20	5720	Ant1	16.54	0.04508	24	Pass
NVNT	n20	5745	Ant1	16.5	0.04467	30	Pass
NVNT	n20	5785	Ant1	16.48	0.04446	30	Pass
NVNT	n20	5825	Ant1	16.06	0.04036	30	Pass
NVNT	n40	5190	Ant1	15.52	0.03565	24	Pass
NVNT	n40	5230	Ant1	16.56	0.04529	24	Pass
NVNT	n40	5270	Ant1	16.45	0.04416	24	Pass
NVNT	n40	5310	Ant1	11.31	0.01352	24	Pass
NVNT	n40	5510	Ant1	10.95	0.01245	24	Pass
NVNT	n40	5550	Ant1	15.85	0.03846	24	Pass
NVNT	n40	5630	Ant1	16.54	0.04508	24	Pass



NVNT	n40	5710	Ant1	16.81	0.04797	24	Pass
NVNT	n40	5755	Ant1	17.03	0.05047	30	Pass
NVNT	n40	5795	Ant1	16.73	0.0471	30	Pass
NVNT	ac20	5180	Ant1	16.29	0.04256	24	Pass
NVNT	ac20	5220	Ant1	16.39	0.04355	24	Pass
NVNT	ac20	5240	Ant1	16.31	0.04276	24	Pass
NVNT	ac20	5260	Ant1	16.46	0.04426	24	Pass
NVNT	ac20	5300	Ant1	16.01	0.0399	24	Pass
NVNT	ac20	5320	Ant1	15.18	0.03296	24	Pass
NVNT	ac20	5500	Ant1	15.61	0.03639	24	Pass
NVNT	ac20	5580	Ant1	15.57	0.03606	24	Pass
NVNT	ac20	5600	Ant1	15.81	0.03811	24	Pass
NVNT	ac20	5720	Ant1	16.54	0.04508	24	Pass
NVNT	ac20	5745	Ant1	16.36	0.04325	30	Pass
NVNT	ac20	5785	Ant1	16.47	0.04436	30	Pass
NVNT	ac20	5825	Ant1	16.09	0.04064	30	Pass
NVNT	ac40	5190	Ant1	14.76	0.02992	24	Pass
NVNT	ac40	5230	Ant1	14.88	0.03076	24	Pass
NVNT	ac40	5270	Ant1	14.59	0.02877	24	Pass
NVNT	ac40	5310	Ant1	14.26	0.02667	24	Pass
NVNT	ac40	5510	Ant1	13.94	0.02477	24	Pass
NVNT	ac40	5550	Ant1	13.94	0.02477	24	Pass
NVNT	ac40	5630	Ant1	14.58	0.02871	24	Pass
NVNT	ac40	5710	Ant1	14.93	0.03112	24	Pass
NVNT	ac40	5755	Ant1	15.42	0.03483	30	Pass
NVNT	ac40	5795	Ant1	14.97	0.03141	30	Pass
NVNT	ac80	5210	Ant1	9.03	0.008	24	Pass
NVNT	ac80	5290	Ant1	10.84	0.01213	24	Pass
NVNT	ac80	5530	Ant1	8.66	0.00735	24	Pass
NVNT	ac80	5610	Ant1	13.23	0.02104	24	Pass
NVNT	ac80	5690	Ant1	13.71	0.0235	24	Pass
NVNT	ac80	5775	Ant1	14	0.02512	30	Pass

**A.3. Emission Bandwidth**

Condition	Mode	Frequency (MHz)	Antenna	-26 dB Bandwidth (MHz)
NVNT	a	5180	Ant1	23.893
NVNT	a	5220	Ant1	24.589
NVNT	a	5240	Ant1	24.113
NVNT	a	5260	Ant1	25.695
NVNT	a	5300	Ant1	25.253
NVNT	a	5320	Ant1	24.919
NVNT	a	5500	Ant1	24.818
NVNT	a	5580	Ant1	23.358
NVNT	a	5600	Ant1	24.267
NVNT	a	5720	Ant1	24.699
NVNT	n20	5180	Ant1	25.137
NVNT	n20	5220	Ant1	24.662
NVNT	n20	5240	Ant1	24.458
NVNT	n20	5260	Ant1	26.63
NVNT	n20	5300	Ant1	25.59
NVNT	n20	5320	Ant1	26.157
NVNT	n20	5500	Ant1	25.239
NVNT	n20	5580	Ant1	25.226
NVNT	n20	5600	Ant1	25.054
NVNT	n20	5720	Ant1	25.416
NVNT	n40	5190	Ant1	41.101
NVNT	n40	5230	Ant1	41.06
NVNT	n40	5270	Ant1	45.865
NVNT	n40	5310	Ant1	41.507
NVNT	n40	5510	Ant1	41.149
NVNT	n40	5550	Ant1	41.401
NVNT	n40	5630	Ant1	40.436
NVNT	n40	5710	Ant1	41.607
NVNT	ac20	5180	Ant1	24.435
NVNT	ac20	5220	Ant1	23.866
NVNT	ac20	5240	Ant1	25.814
NVNT	ac20	5260	Ant1	25.288
NVNT	ac20	5300	Ant1	25.821
NVNT	ac20	5320	Ant1	26.799
NVNT	ac20	5500	Ant1	24.49
NVNT	ac20	5580	Ant1	23.86



NVNT	ac20	5600	Ant1	25.035
NVNT	ac20	5720	Ant1	24.404
NVNT	ac40	5190	Ant1	41.184
NVNT	ac40	5230	Ant1	40.331
NVNT	ac40	5270	Ant1	40.728
NVNT	ac40	5310	Ant1	40.895
NVNT	ac40	5510	Ant1	41.127
NVNT	ac40	5550	Ant1	41.415
NVNT	ac40	5630	Ant1	41.642
NVNT	ac40	5710	Ant1	41.281
NVNT	ac80	5210	Ant1	82.149
NVNT	ac80	5290	Ant1	81.578
NVNT	ac80	5530	Ant1	82.491
NVNT	ac80	5610	Ant1	82.742
NVNT	ac80	5690	Ant1	82.131





Condition	Mode	Frequency (MHz)	Antenna	-6 dB Bandwidth (MHz)	Limit -6 dB Bandwidth (MHz)	Verdict
NVNT	a	5745	Ant1	14.404	0.5	Pass
NVNT	a	5785	Ant1	14.742	0.5	Pass
NVNT	a	5825	Ant1	15.472	0.5	Pass
NVNT	n20	5745	Ant1	17.105	0.5	Pass
NVNT	n20	5785	Ant1	15.121	0.5	Pass
NVNT	n20	5825	Ant1	15.344	0.5	Pass
NVNT	n40	5755	Ant1	35.526	0.5	Pass
NVNT	n40	5795	Ant1	35.513	0.5	Pass
NVNT	ac20	5745	Ant1	15.156	0.5	Pass
NVNT	ac20	5785	Ant1	16.792	0.5	Pass
NVNT	ac20	5825	Ant1	17.252	0.5	Pass
NVNT	ac40	5755	Ant1	35.472	0.5	Pass
NVNT	ac40	5795	Ant1	35.46	0.5	Pass
NVNT	ac80	5775	Ant1	75.123	0.5	Pass



Test Graphs

-26dB Bandwidth NVNT a 5180MHz Ant1

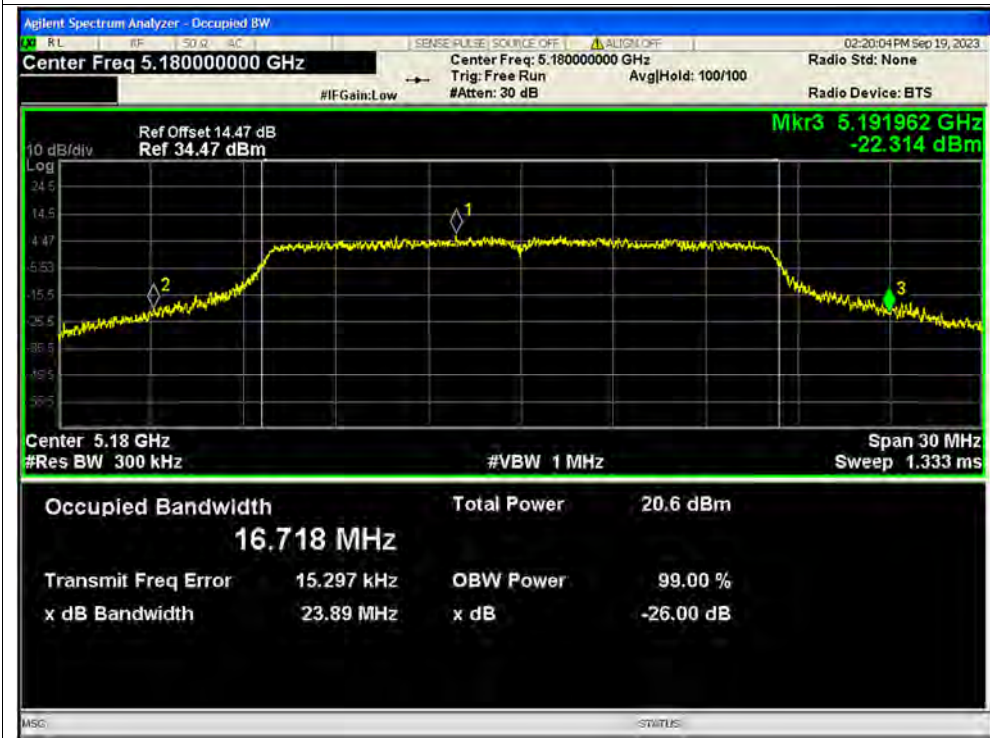

-26dB Bandwidth NVNT a 5220MHz Ant1

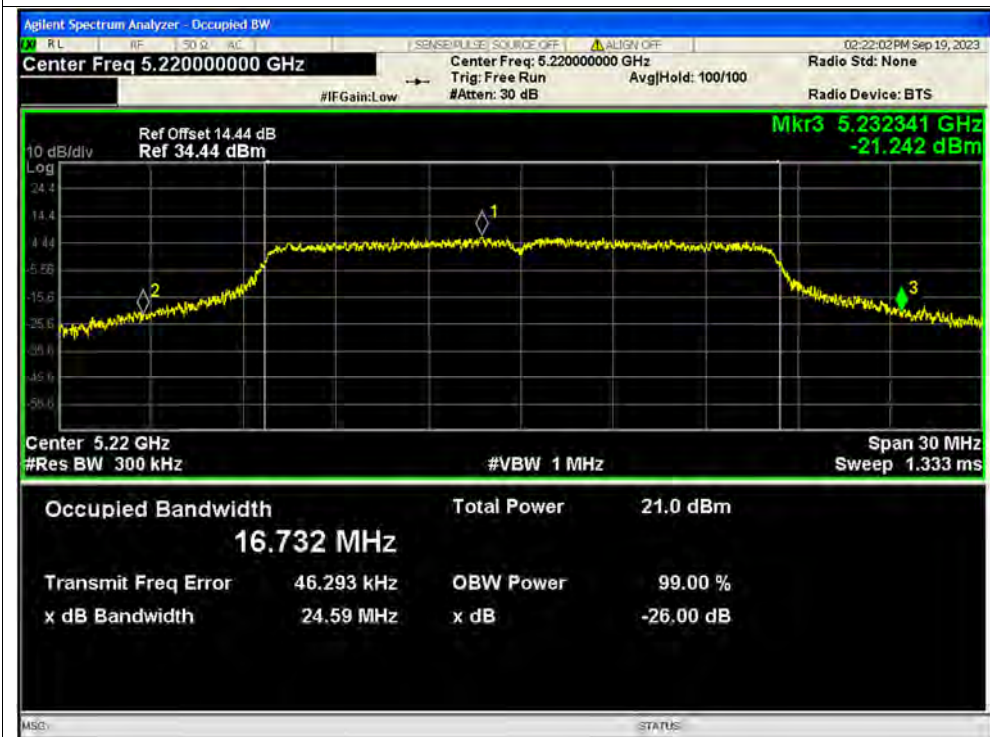



-26dB Bandwidth NVNT a 5240MHz Ant1

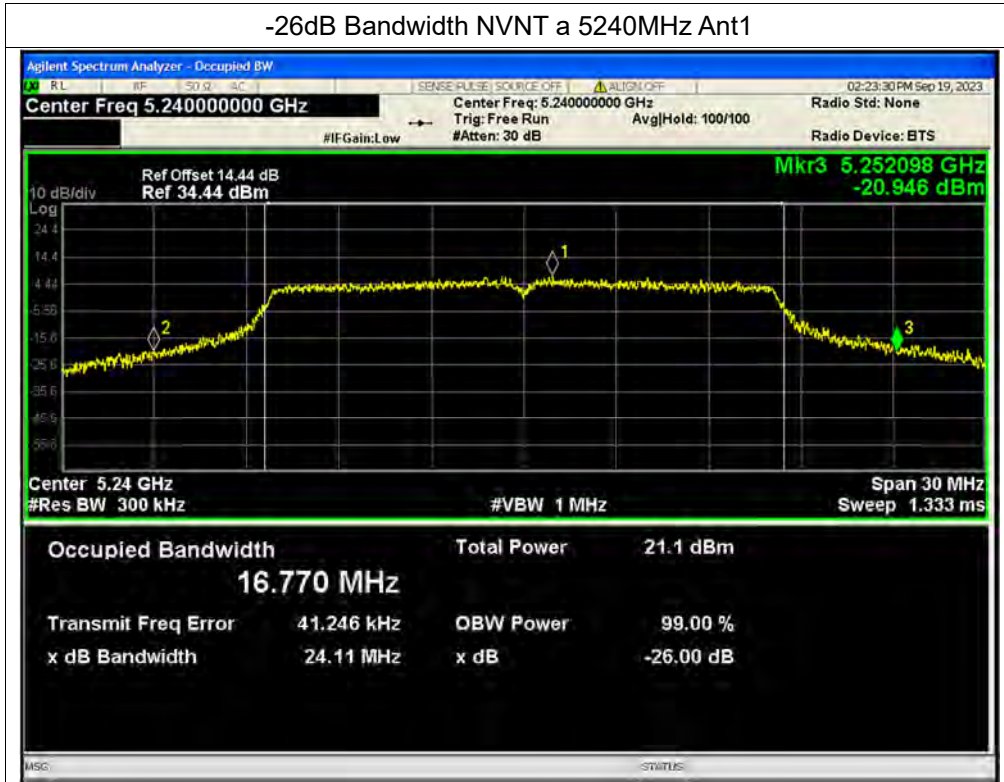

-26dB Bandwidth NVNT a 5260MHz Ant1

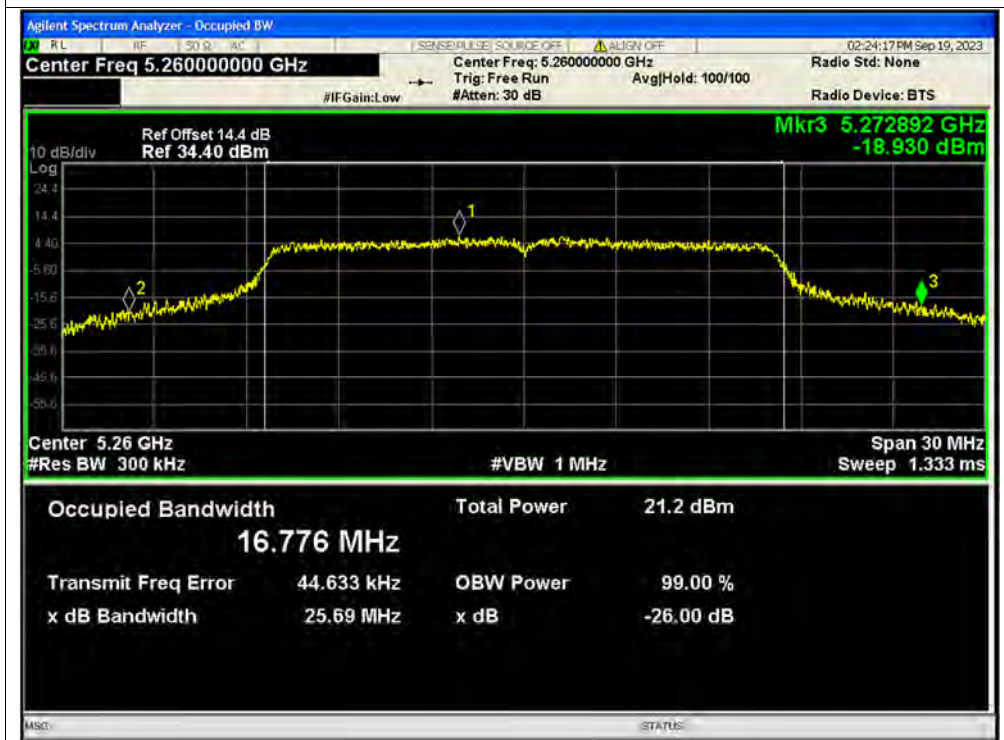



-26dB Bandwidth NVNT a 5300MHz Ant1

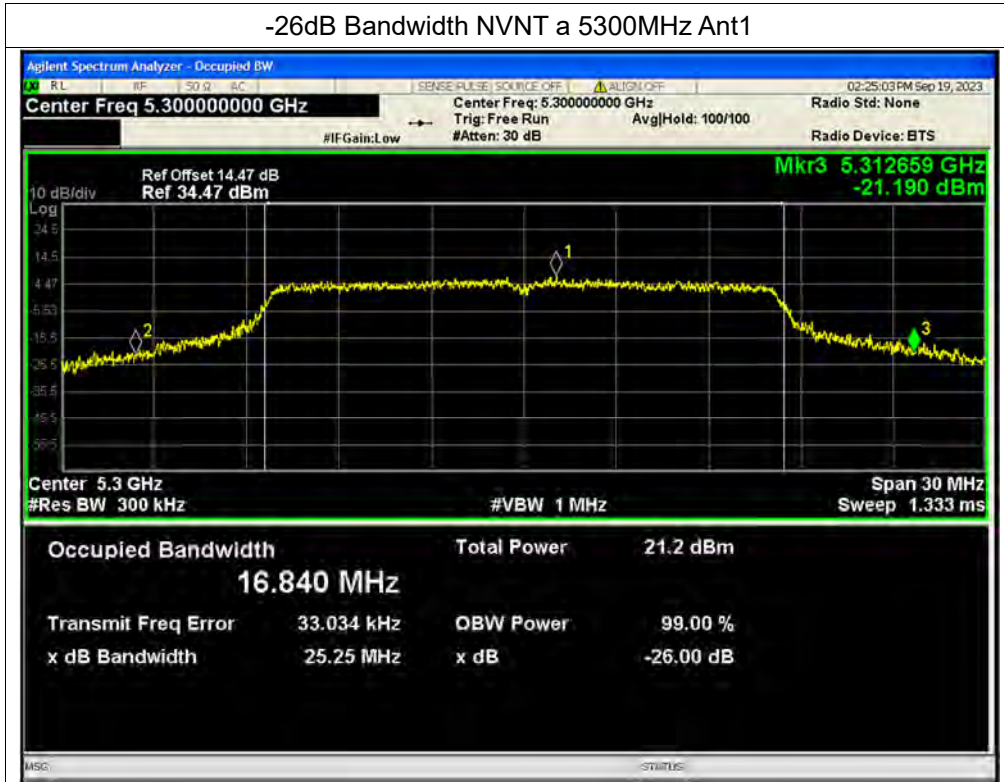

-26dB Bandwidth NVNT a 5320MHz Ant1

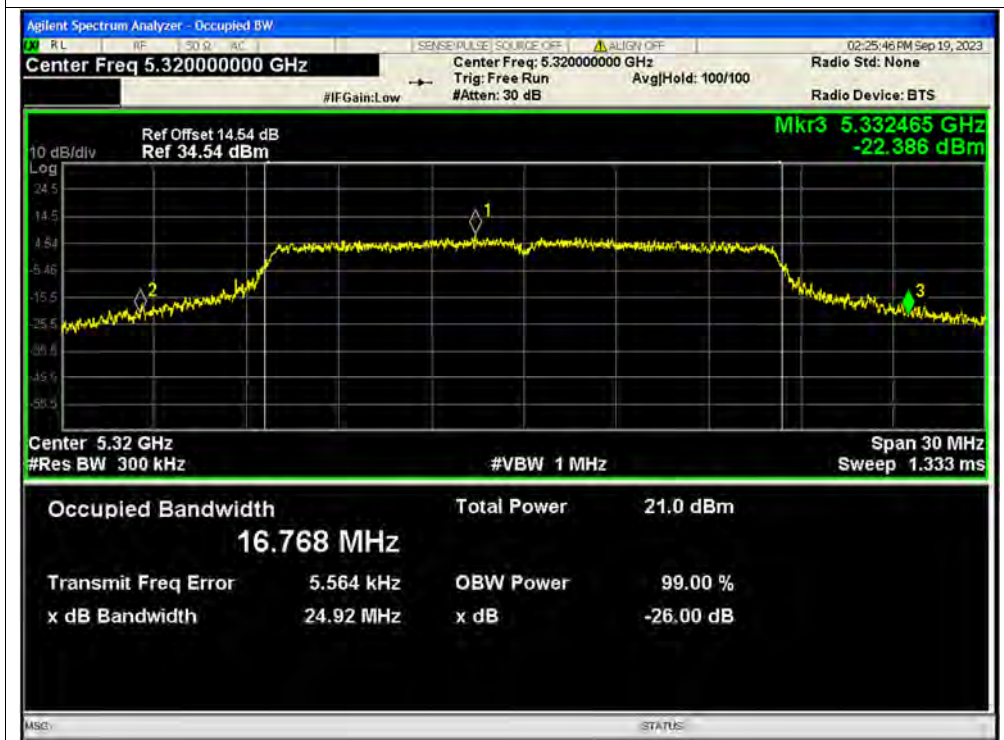





-26dB Bandwidth NVNT a 5500MHz Ant1

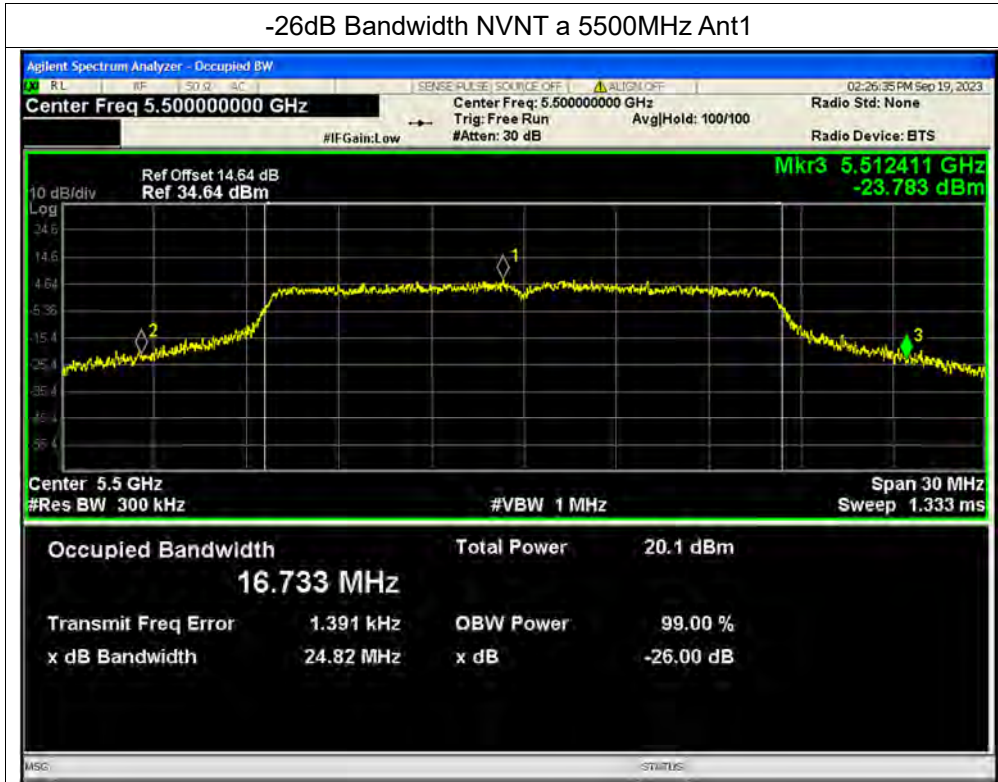

-26dB Bandwidth NVNT a 5580MHz Ant1

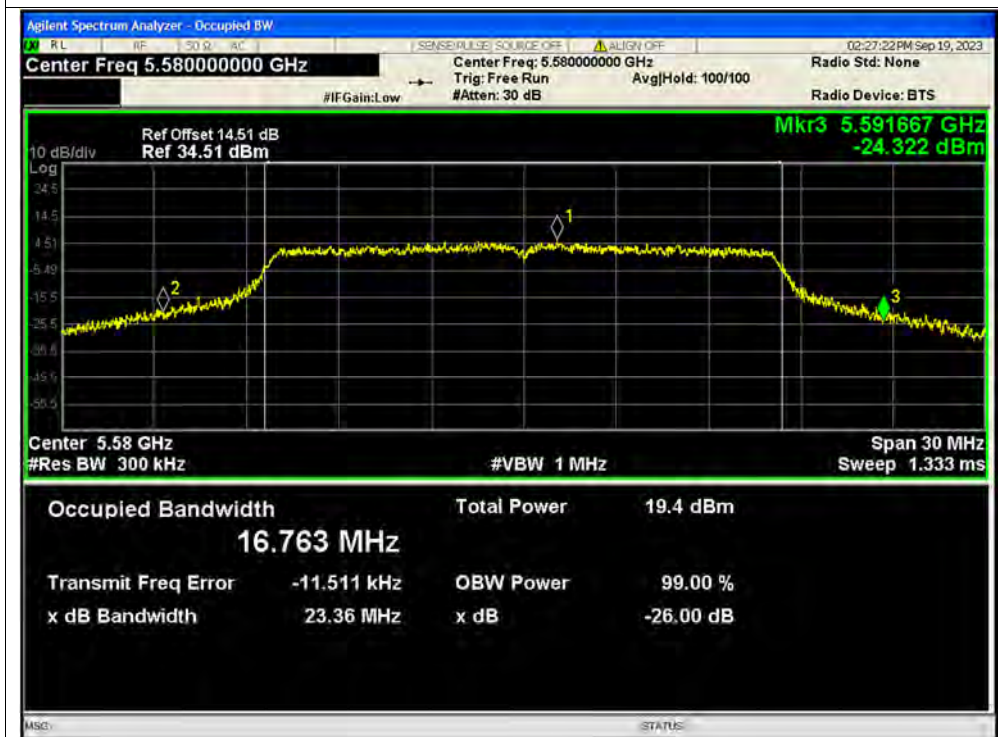



-26dB Bandwidth NVNT a 5600MHz Ant1

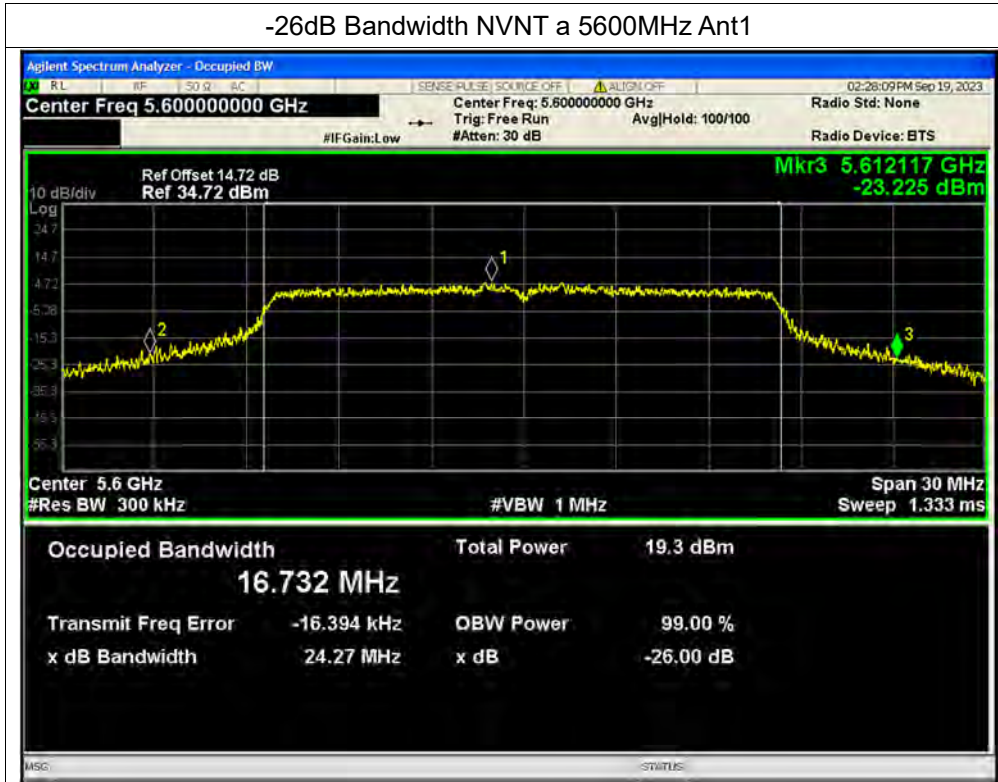

-26dB Bandwidth NVNT a 5720MHz Ant1





-26dB Bandwidth NVNT n20 5180MHz Ant1

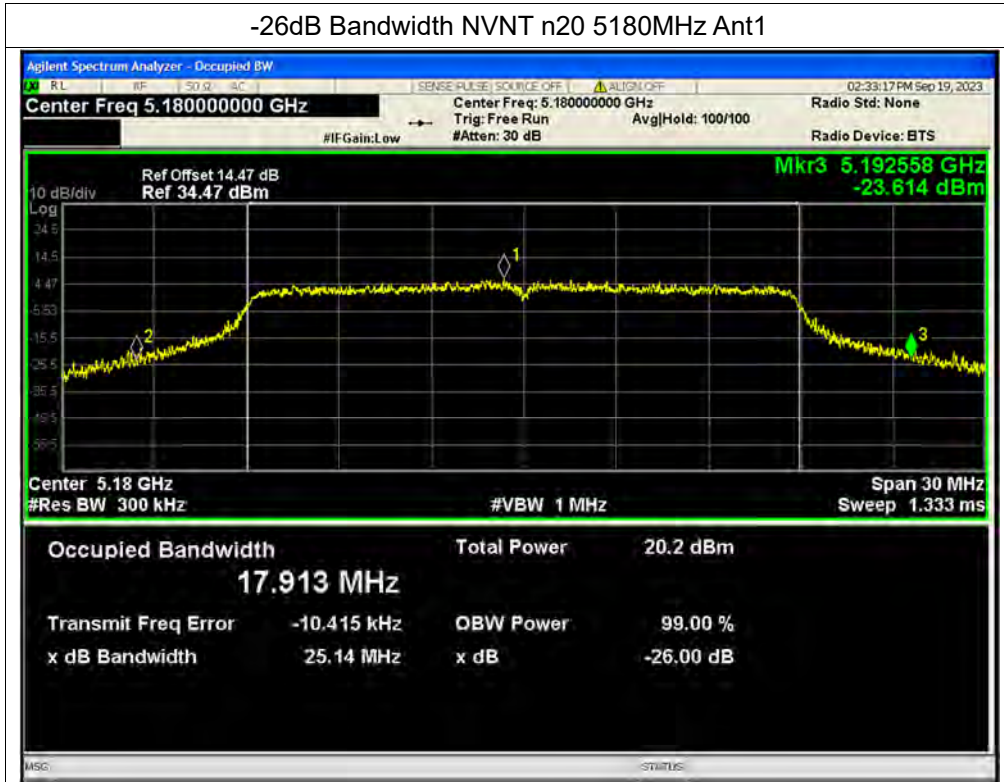

-26dB Bandwidth NVNT n20 5220MHz Ant1







-26dB Bandwidth NVNT n20 5240MHz Ant1

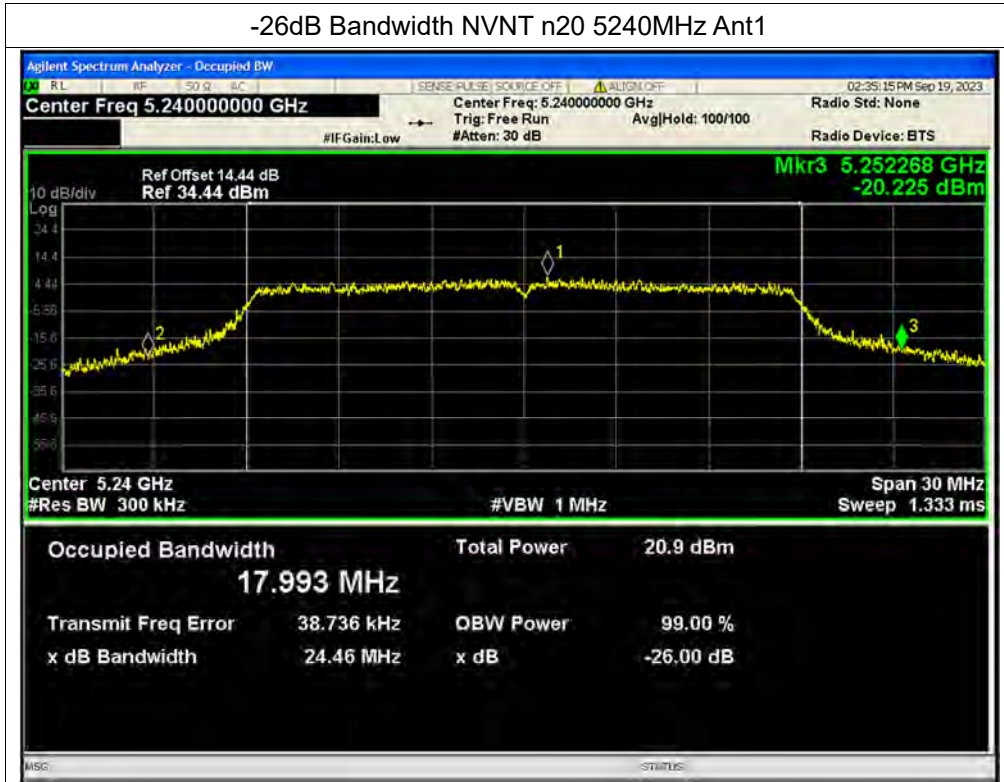

-26dB Bandwidth NVNT n20 5260MHz Ant1

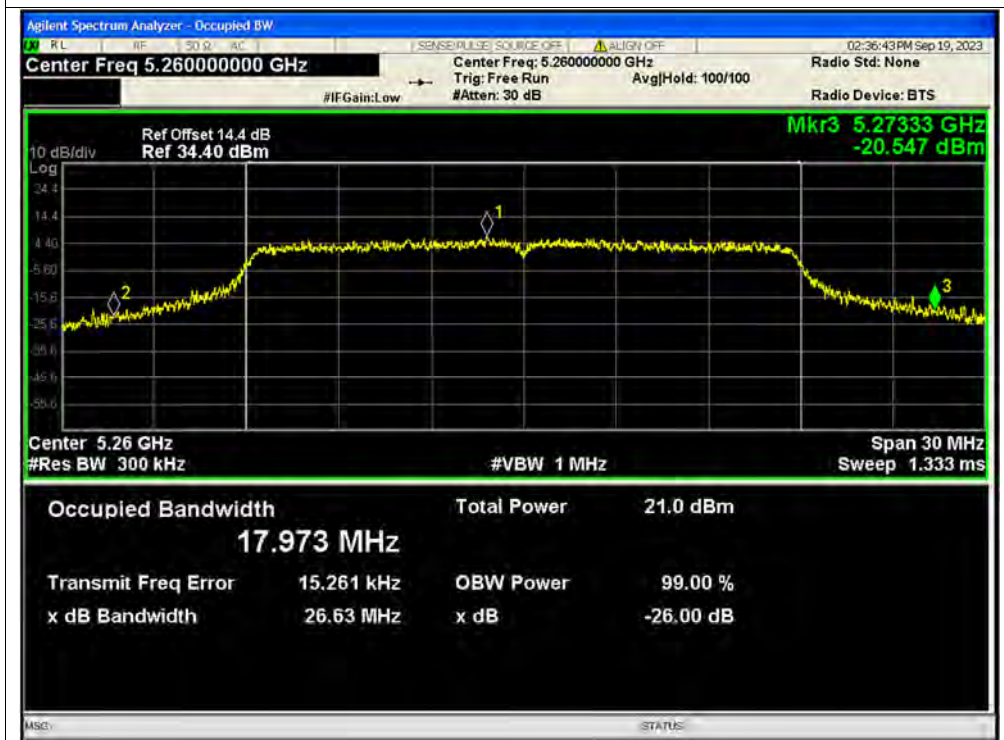





-26dB Bandwidth NVNT n20 5300MHz Ant1

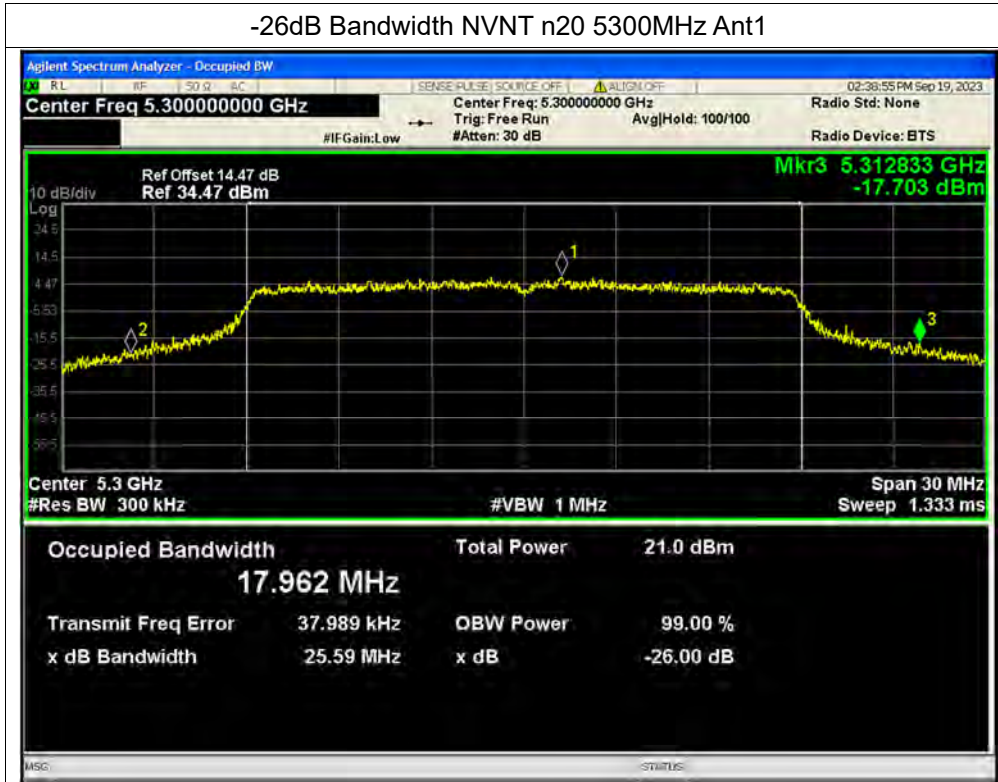

-26dB Bandwidth NVNT n20 5320MHz Ant1

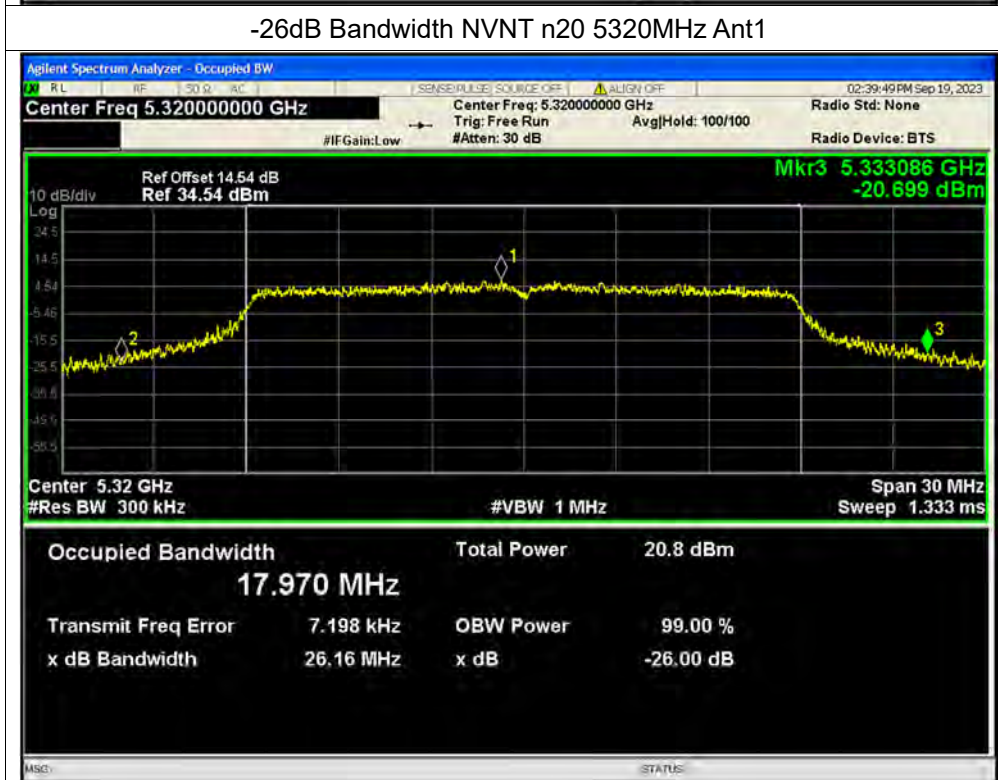



-26dB Bandwidth NVNT n20 5500MHz Ant1

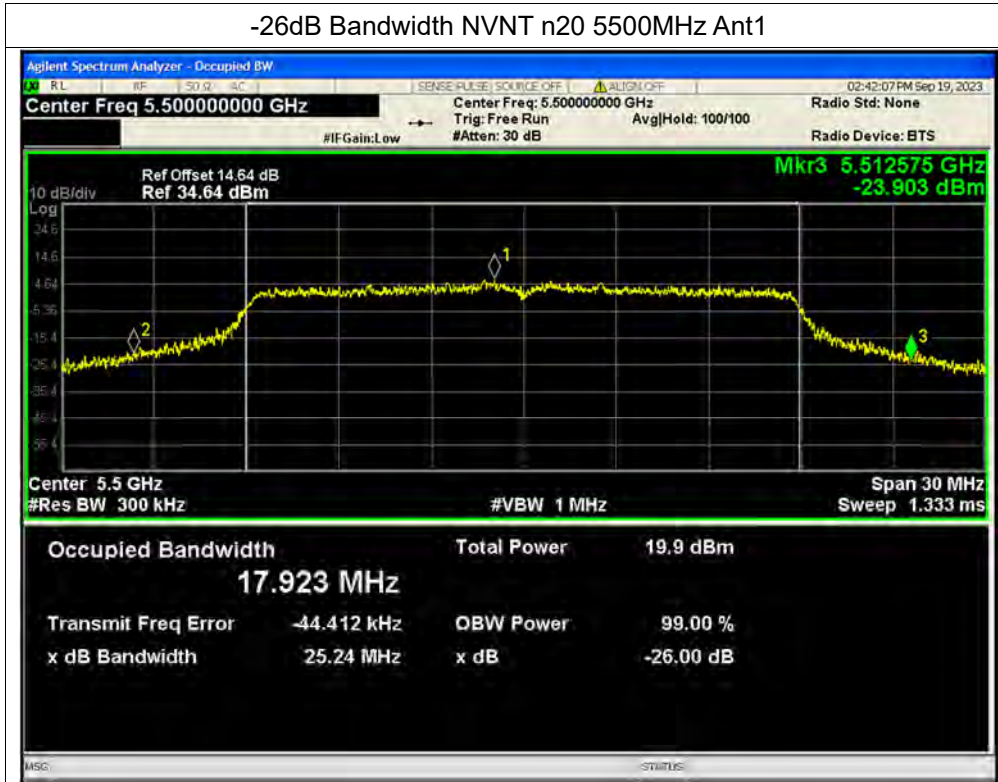

-26dB Bandwidth NVNT n20 5580MHz Ant1





-26dB Bandwidth NVNT n20 5600MHz Ant1

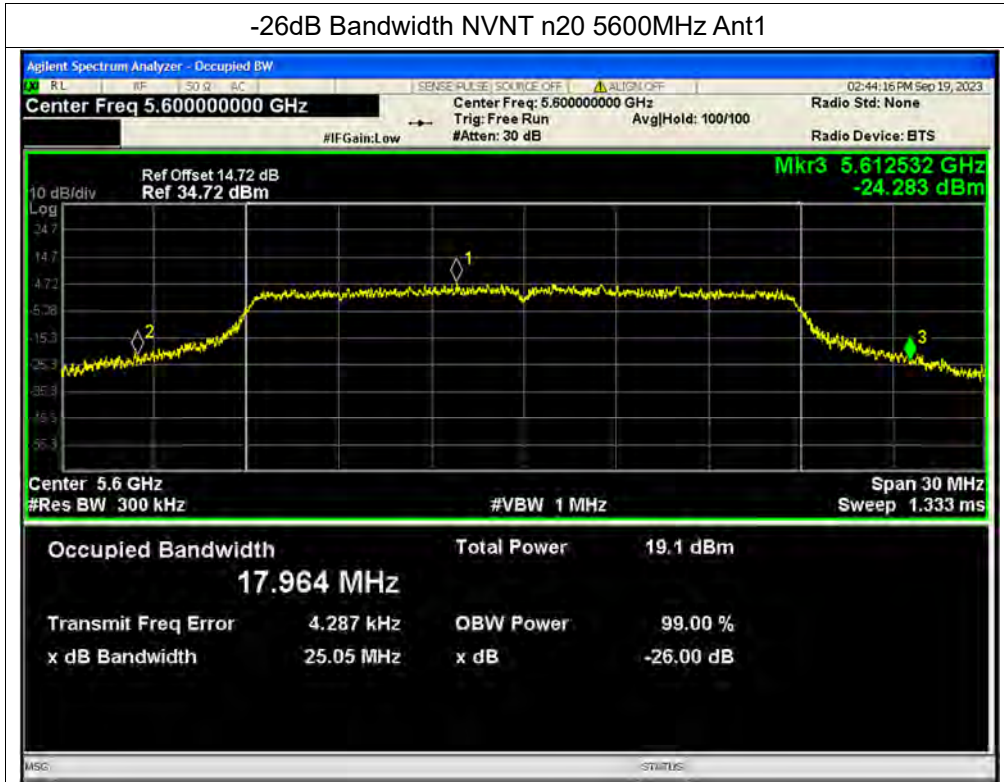

-26dB Bandwidth NVNT n20 5720MHz Ant1







-26dB Bandwidth NVNT n40 5190MHz Ant1

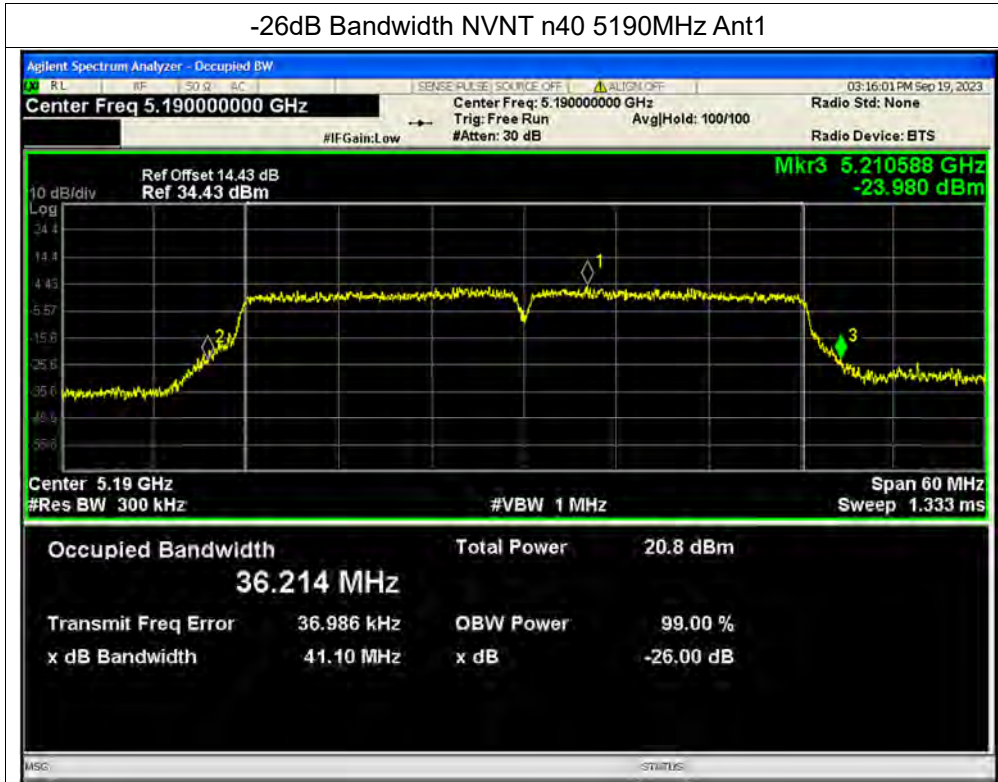

-26dB Bandwidth NVNT n40 5230MHz Ant1

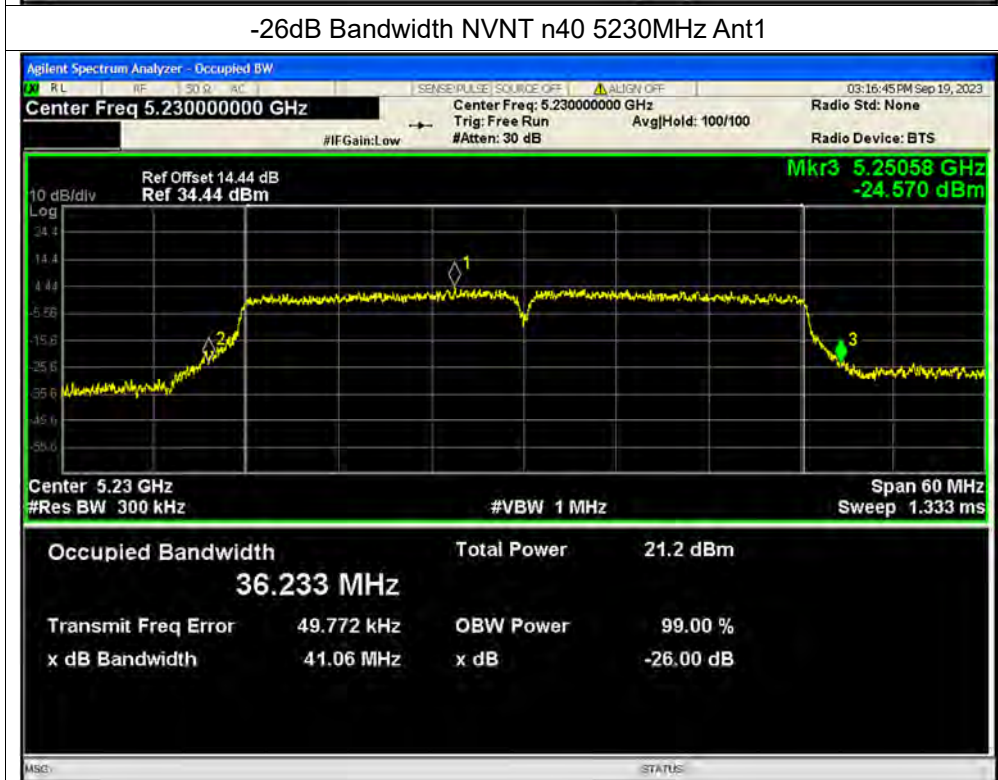





-26dB Bandwidth NVNT n40 5270MHz Ant1

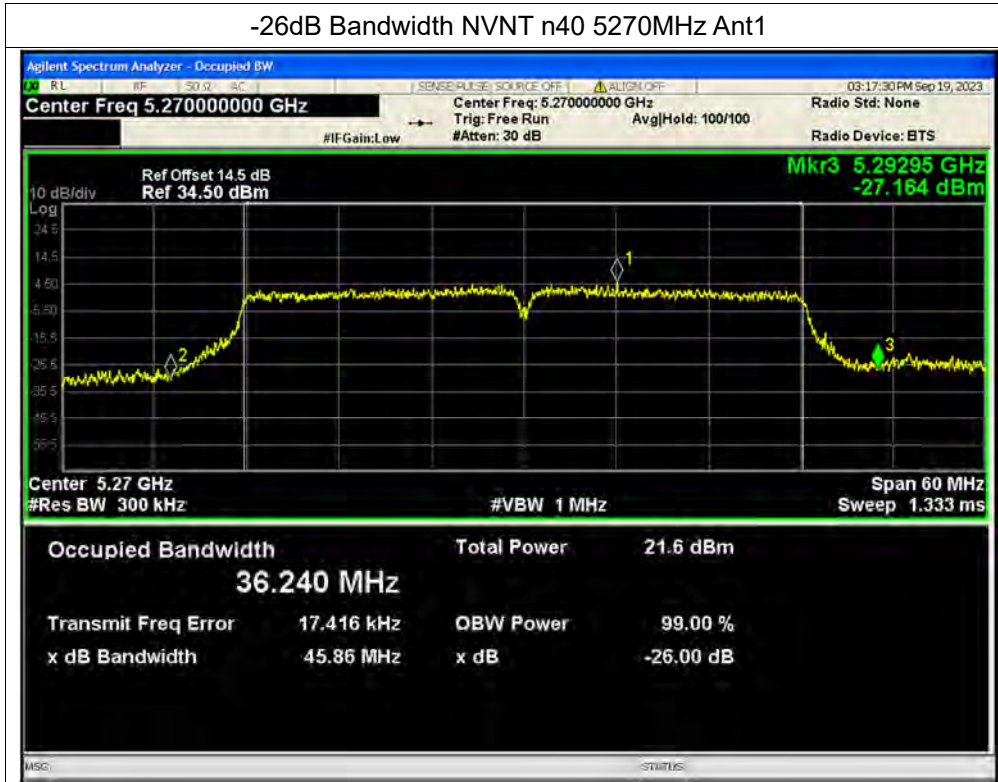

-26dB Bandwidth NVNT n40 5310MHz Ant1

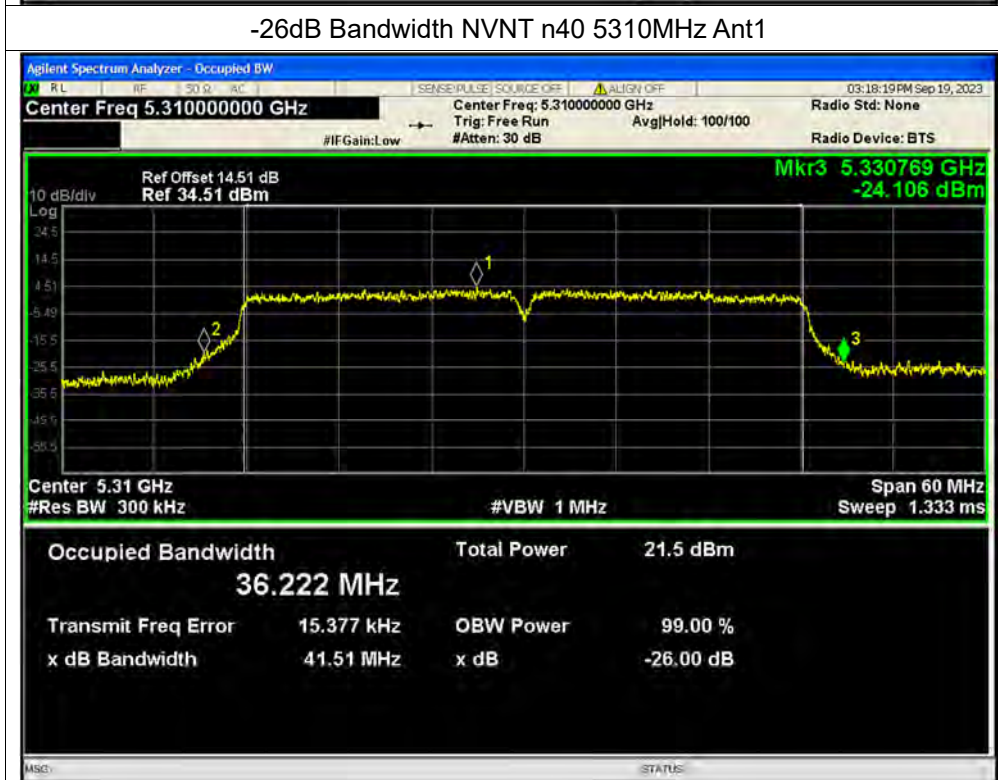



-26dB Bandwidth NVNT n40 5510MHz Ant1

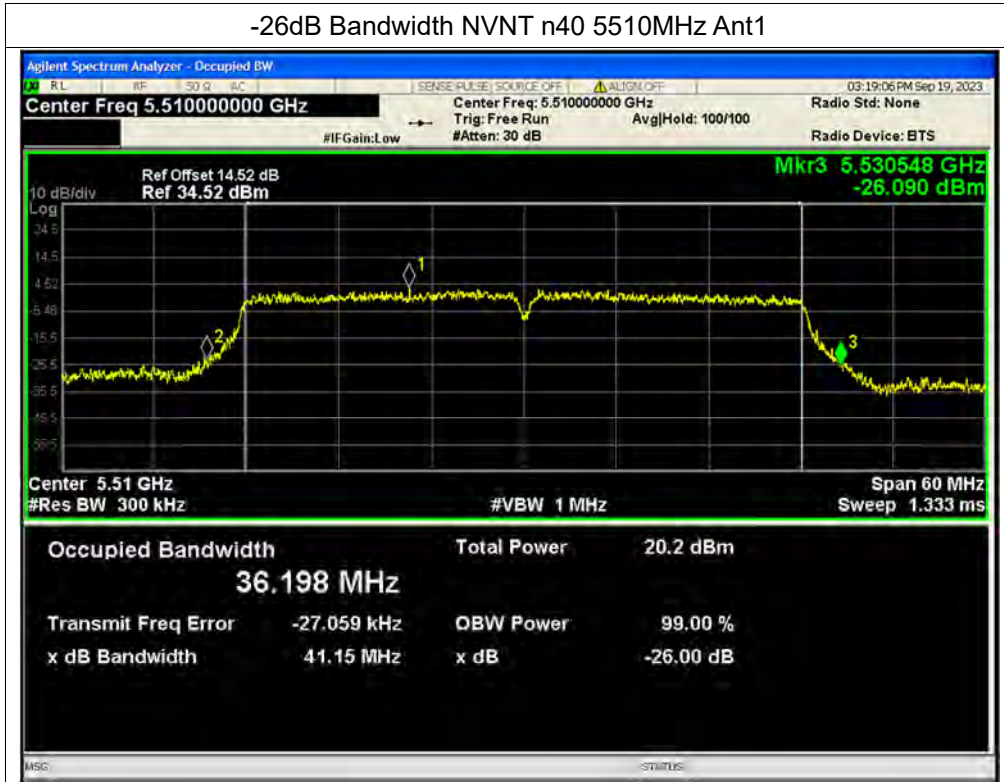

-26dB Bandwidth NVNT n40 5550MHz Ant1

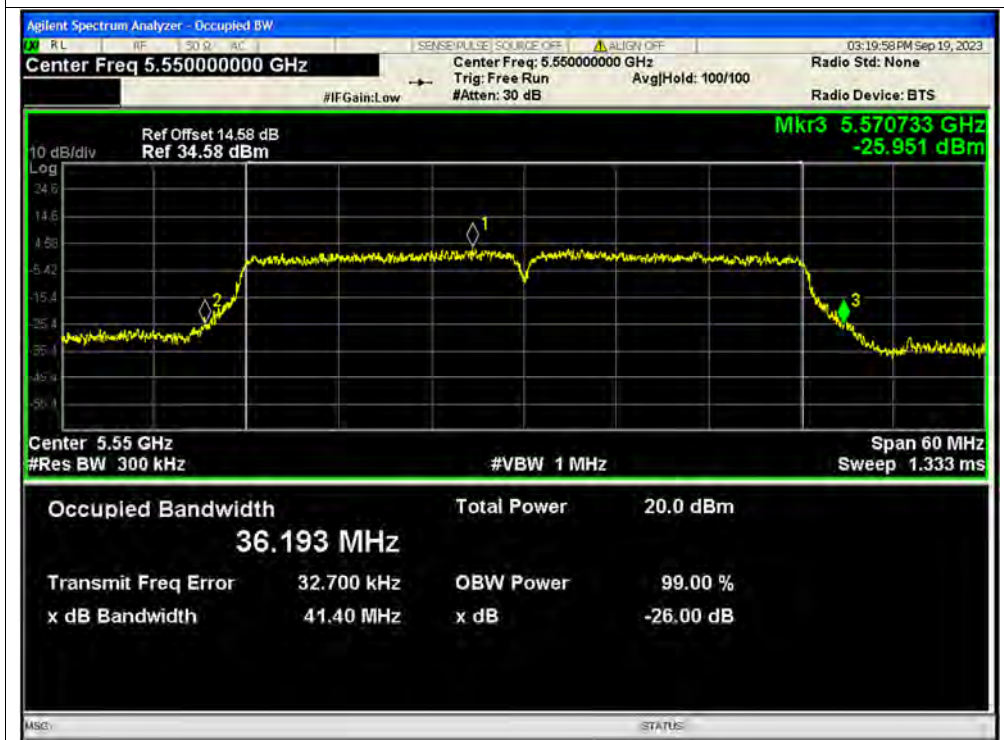



-26dB Bandwidth NVNT n40 5630MHz Ant1

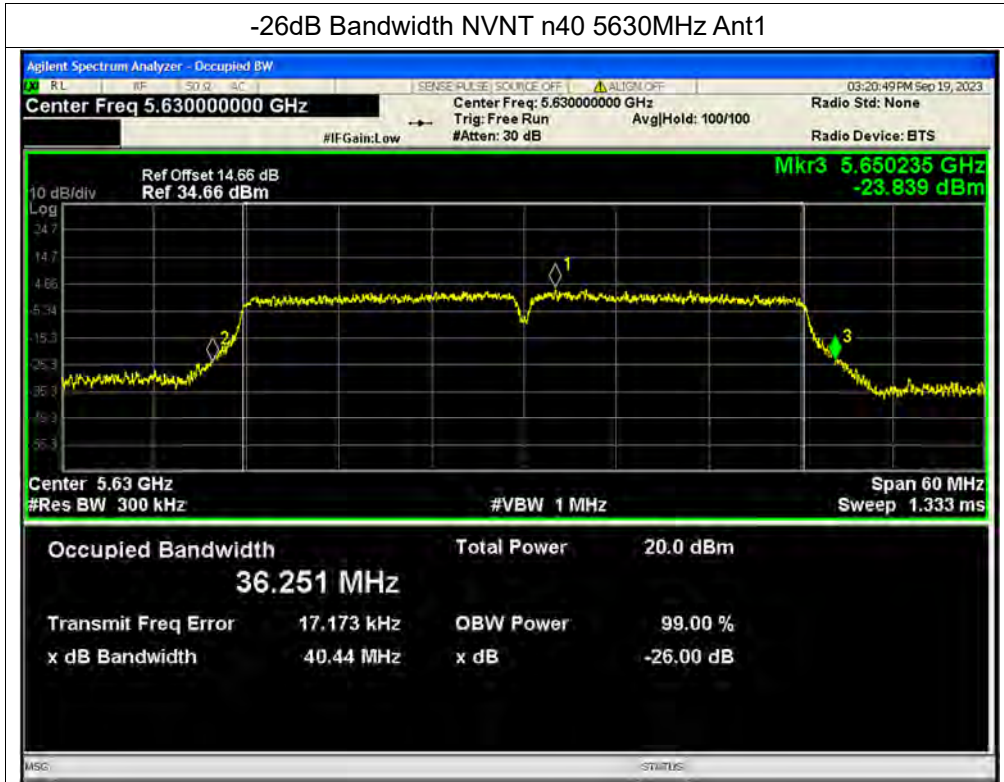

-26dB Bandwidth NVNT n40 5710MHz Ant1

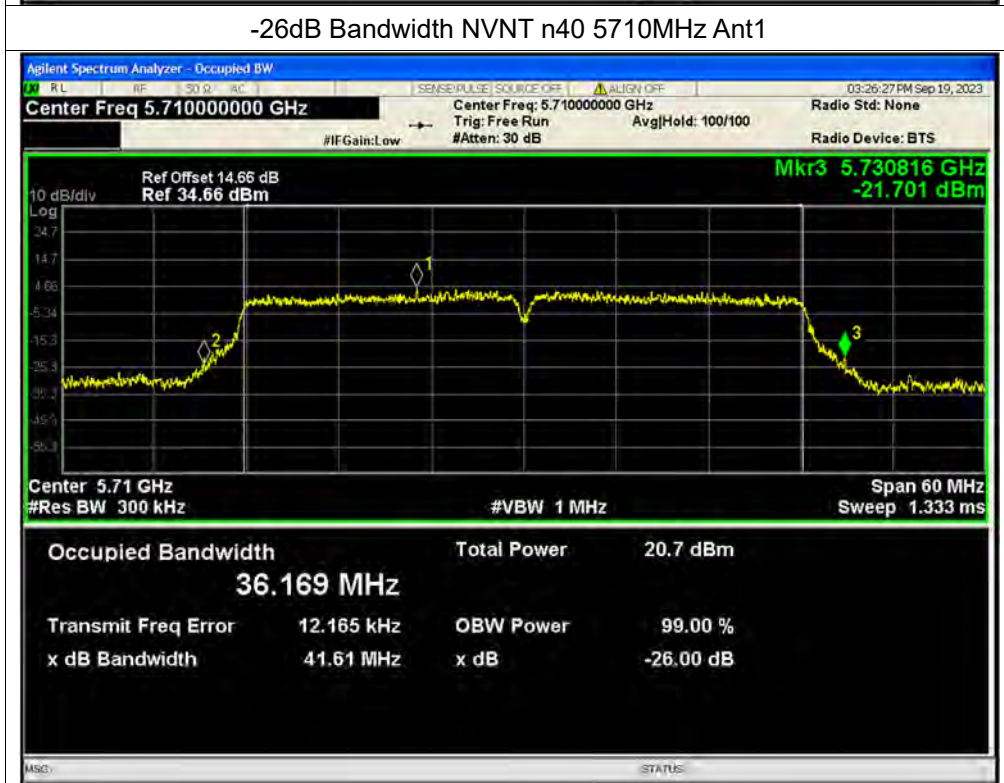





-26dB Bandwidth NVNT ac20 5180MHz Ant1

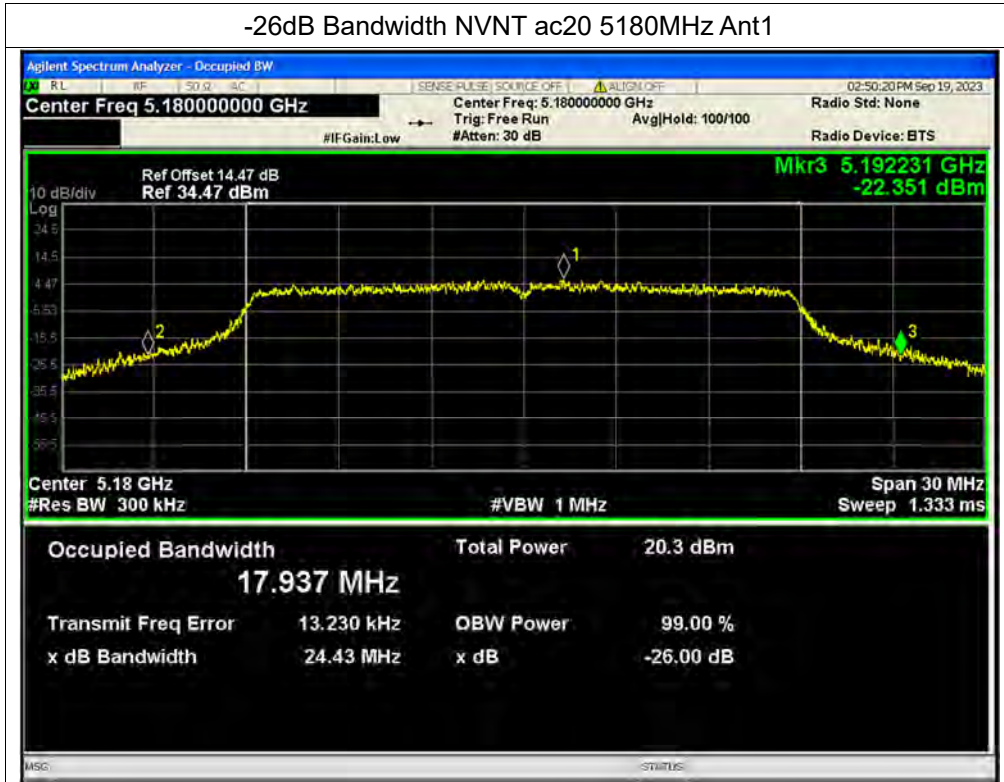

-26dB Bandwidth NVNT ac20 5220MHz Ant1

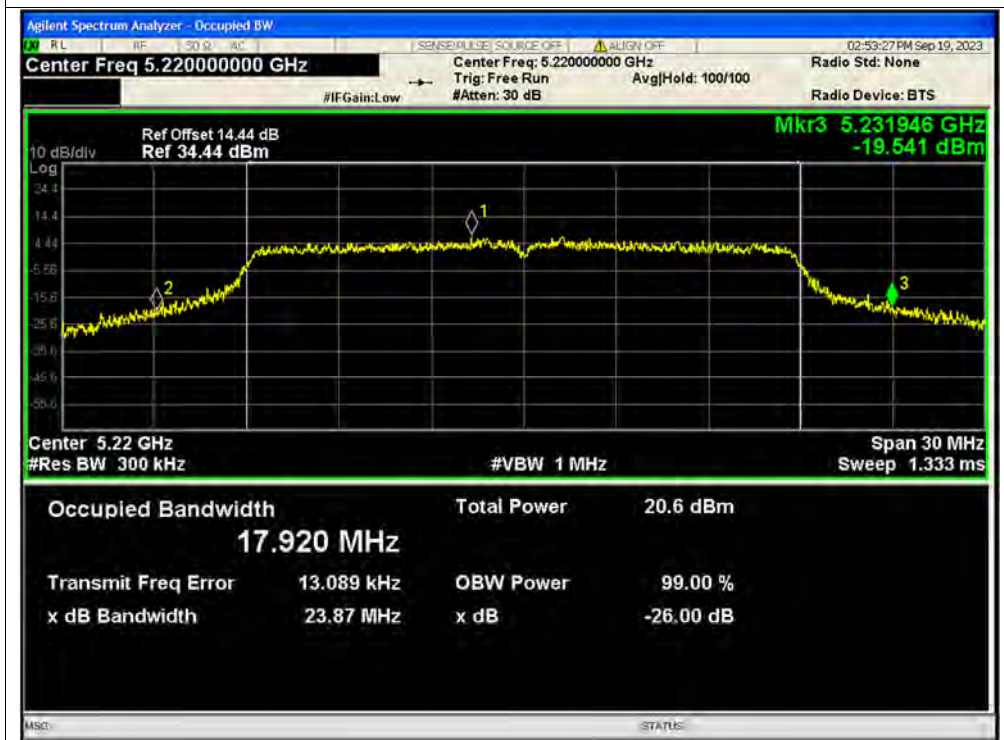





-26dB Bandwidth NVNT ac20 5240MHz Ant1

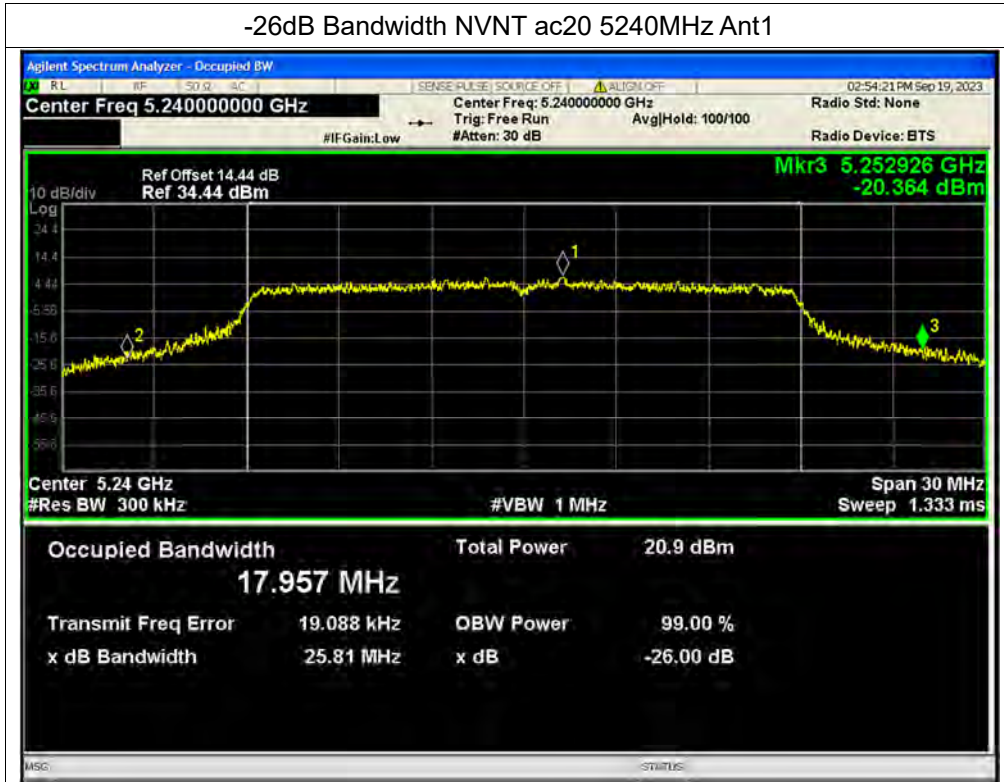

-26dB Bandwidth NVNT ac20 5260MHz Ant1





-26dB Bandwidth NVNT ac20 5300MHz Ant1



-26dB Bandwidth NVNT ac20 5320MHz Ant1





-26dB Bandwidth NVNT ac20 5500MHz Ant1

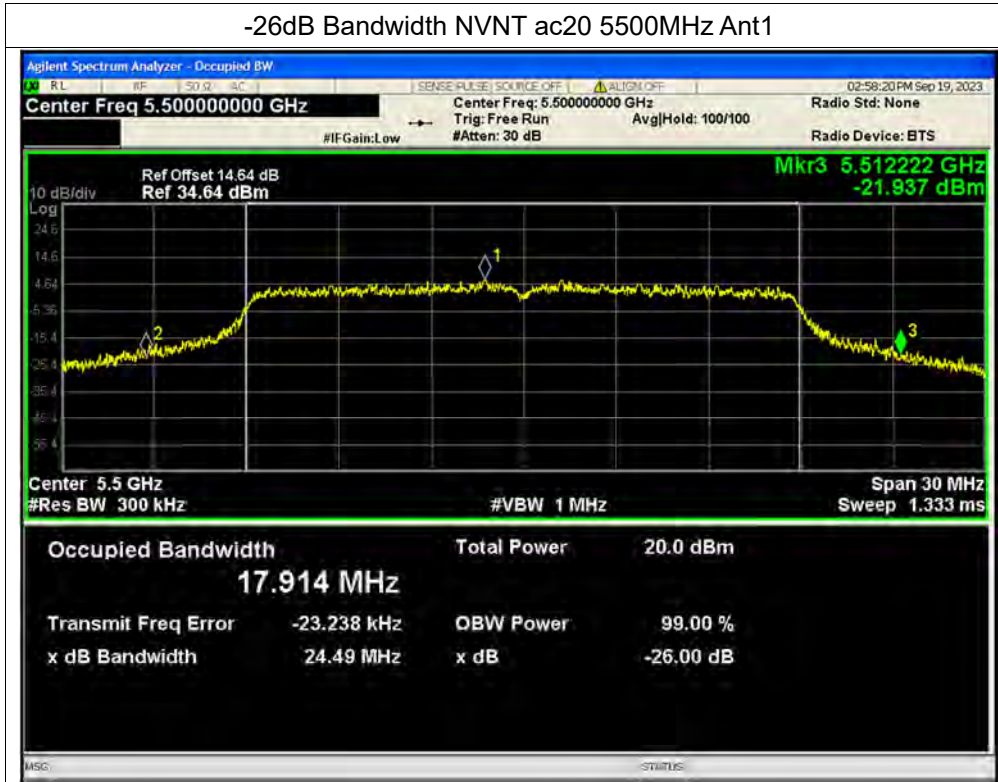

-26dB Bandwidth NVNT ac20 5580MHz Ant1

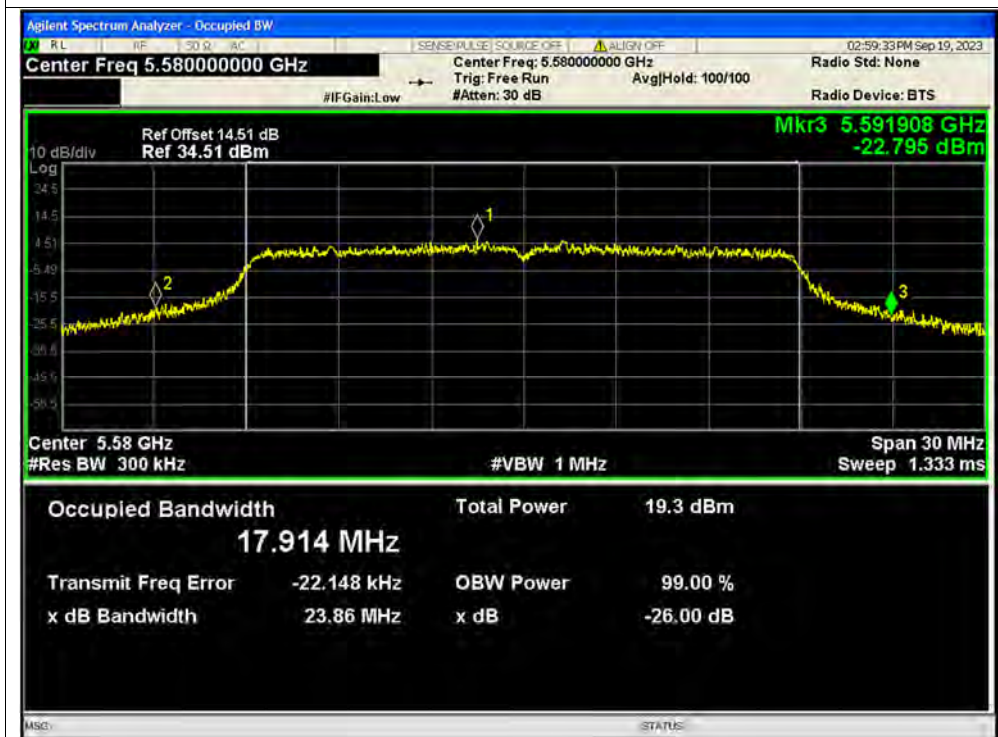





-26dB Bandwidth NVNT ac20 5600MHz Ant1

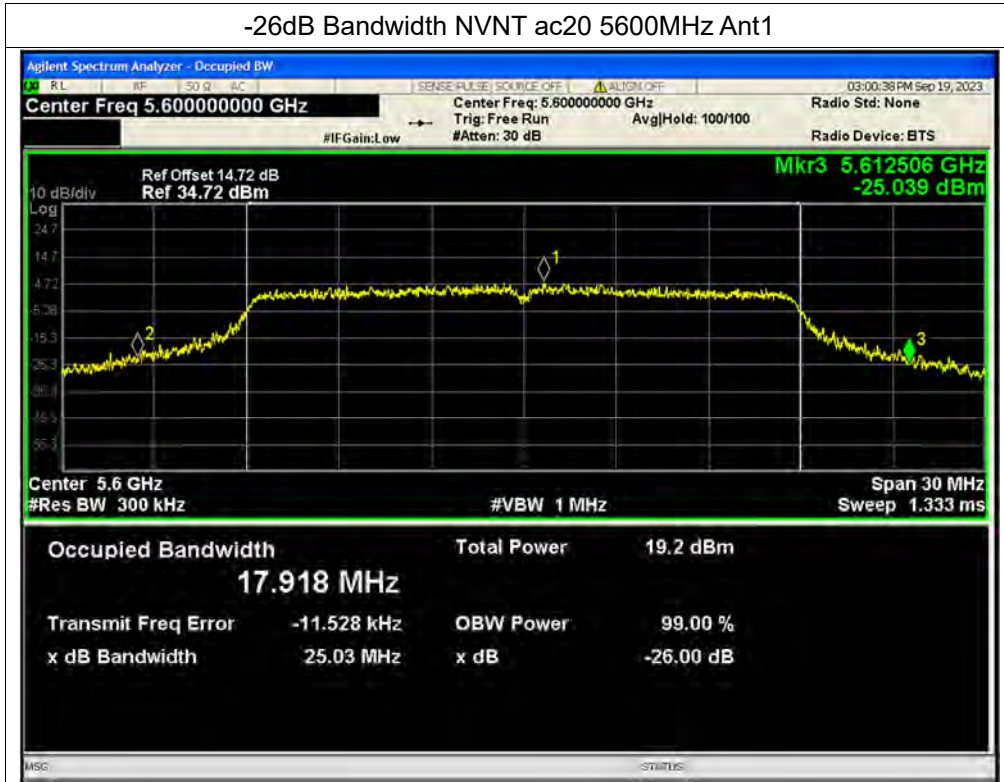

-26dB Bandwidth NVNT ac20 5720MHz Ant1

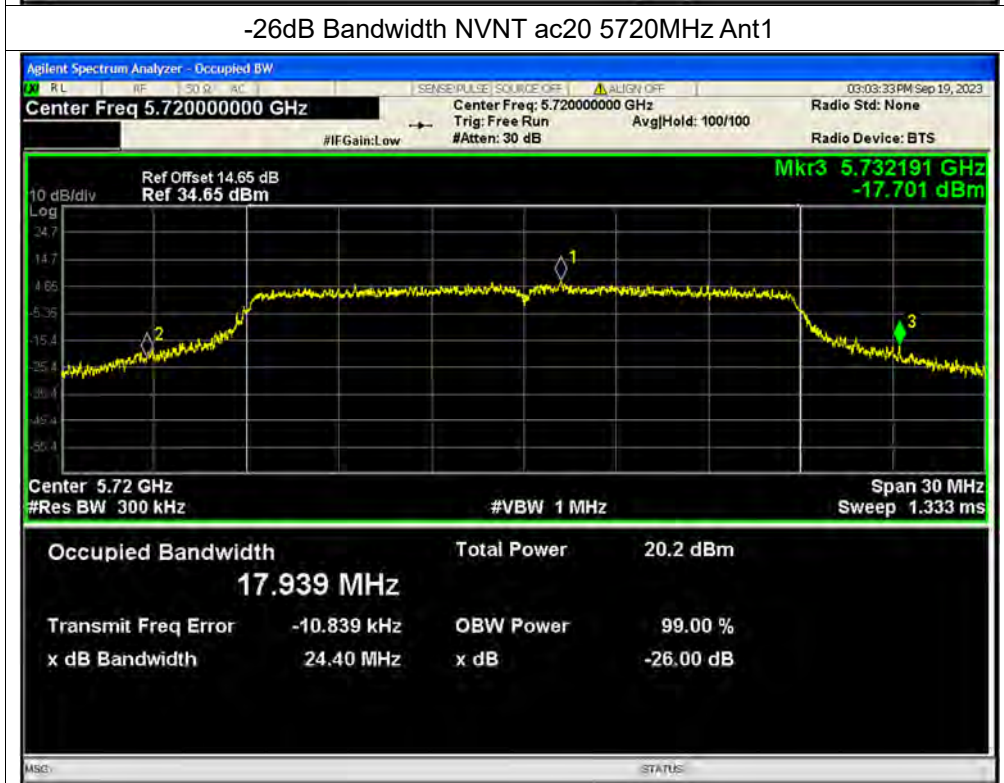





-26dB Bandwidth NVNT ac40 5190MHz Ant1

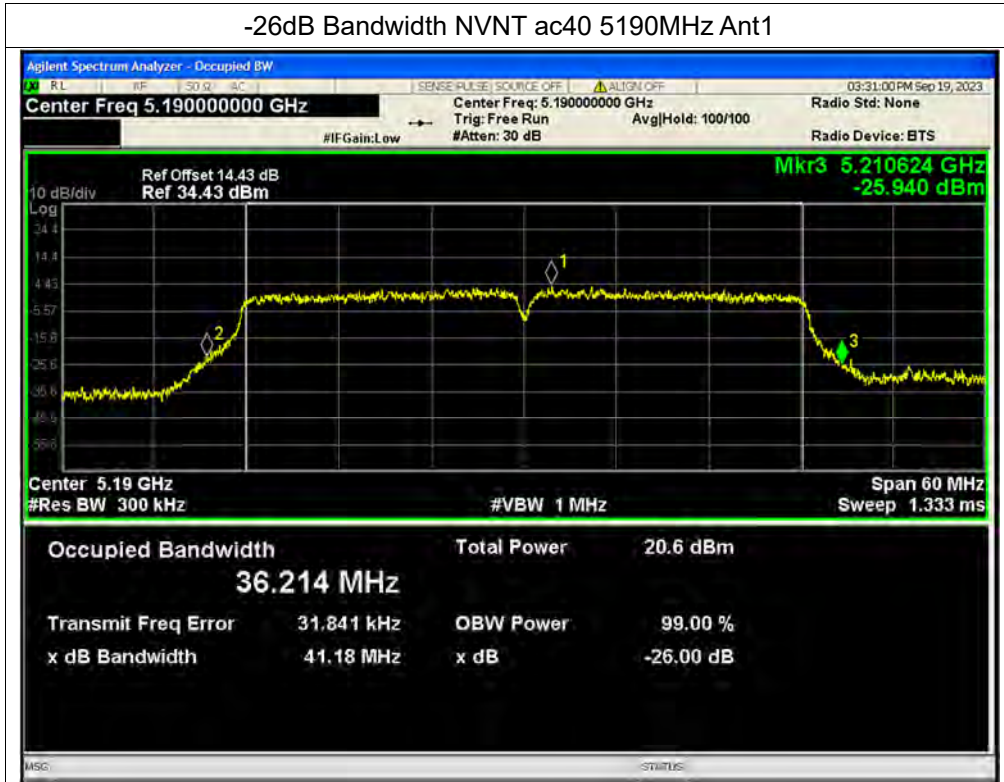

-26dB Bandwidth NVNT ac40 5230MHz Ant1

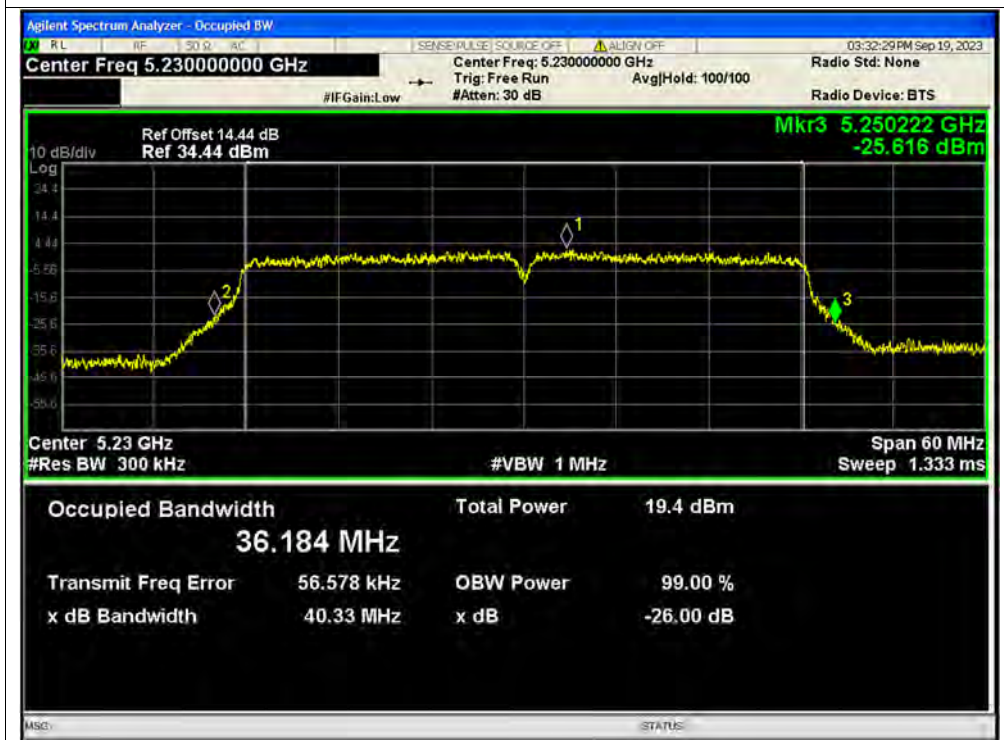



-26dB Bandwidth NVNT ac40 5270MHz Ant1

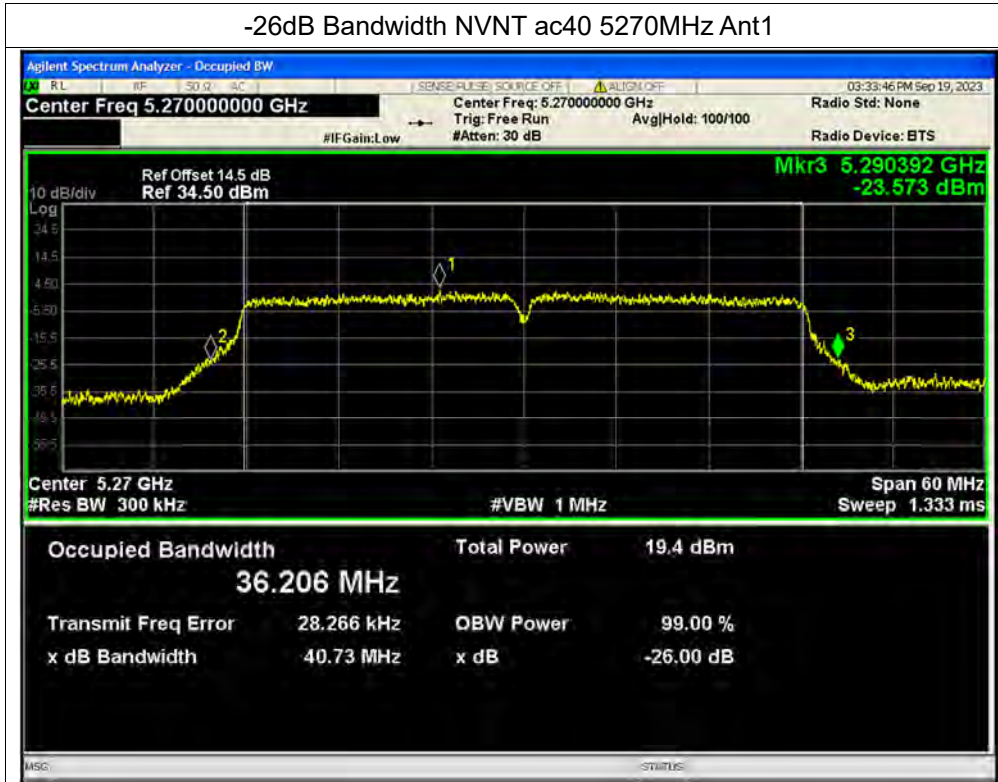

-26dB Bandwidth NVNT ac40 5310MHz Ant1

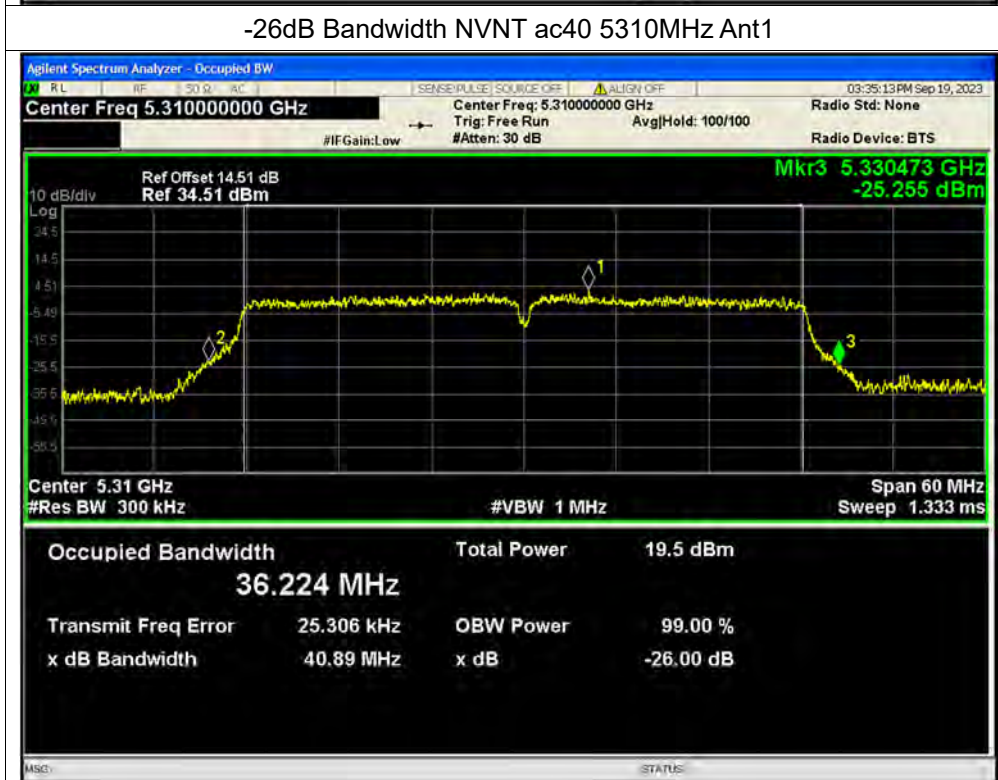



-26dB Bandwidth NVNT ac40 5510MHz Ant1

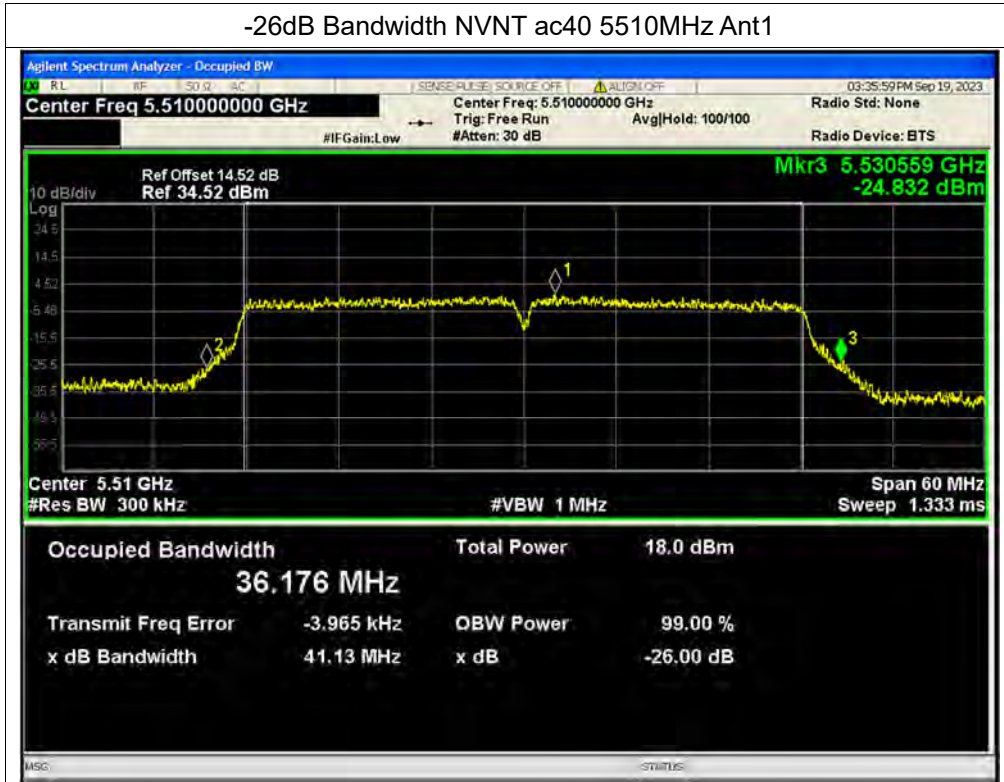

-26dB Bandwidth NVNT ac40 5550MHz Ant1

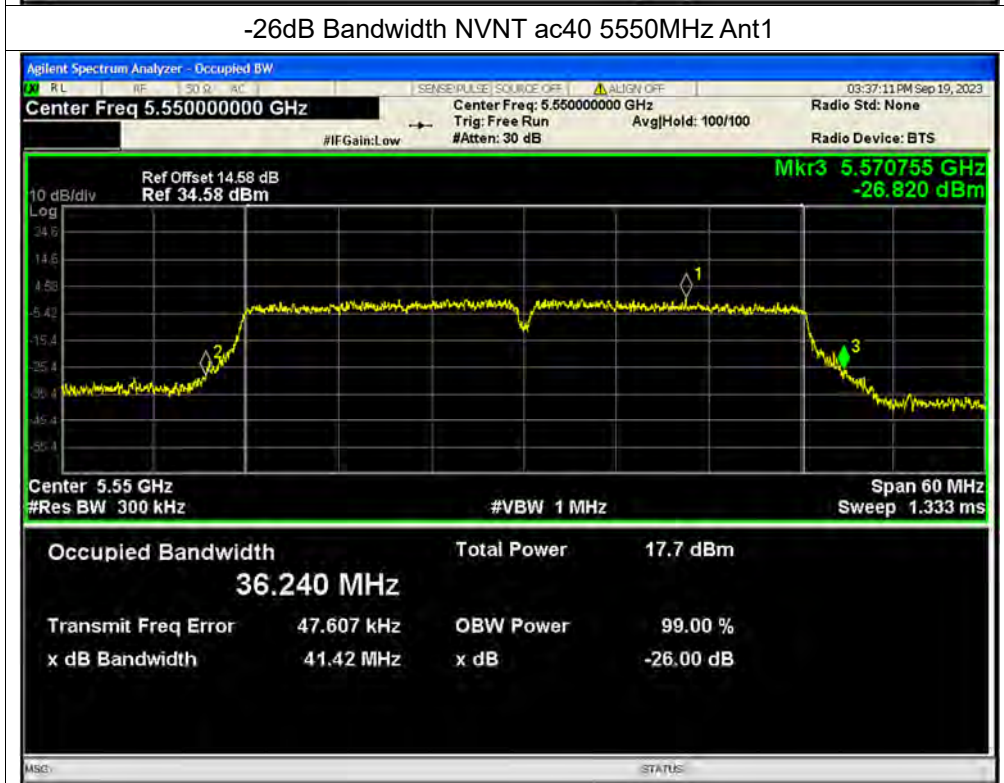





-26dB Bandwidth NVNT ac40 5630MHz Ant1

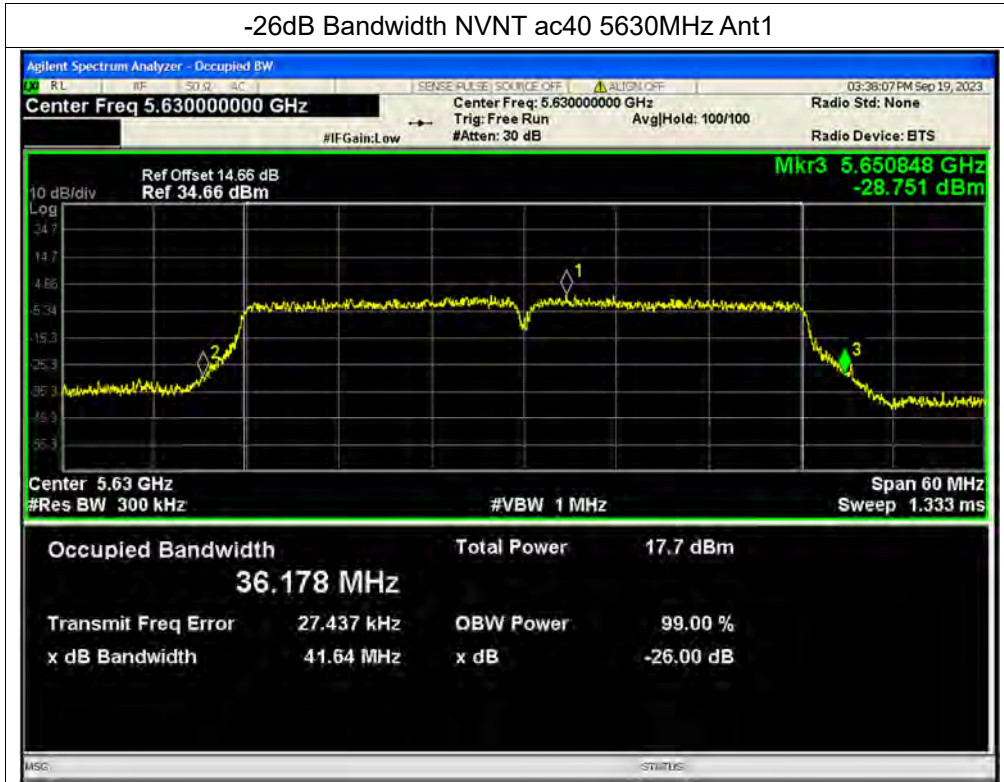

-26dB Bandwidth NVNT ac40 5710MHz Ant1

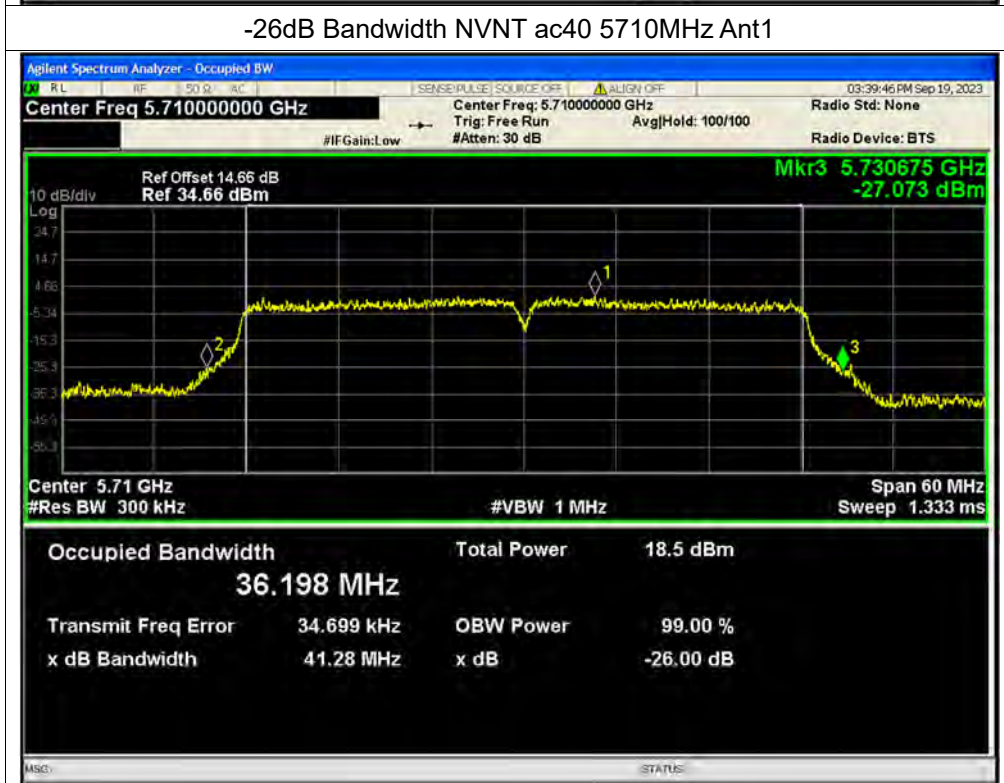





-26dB Bandwidth NVNT ac80 5210MHz Ant1

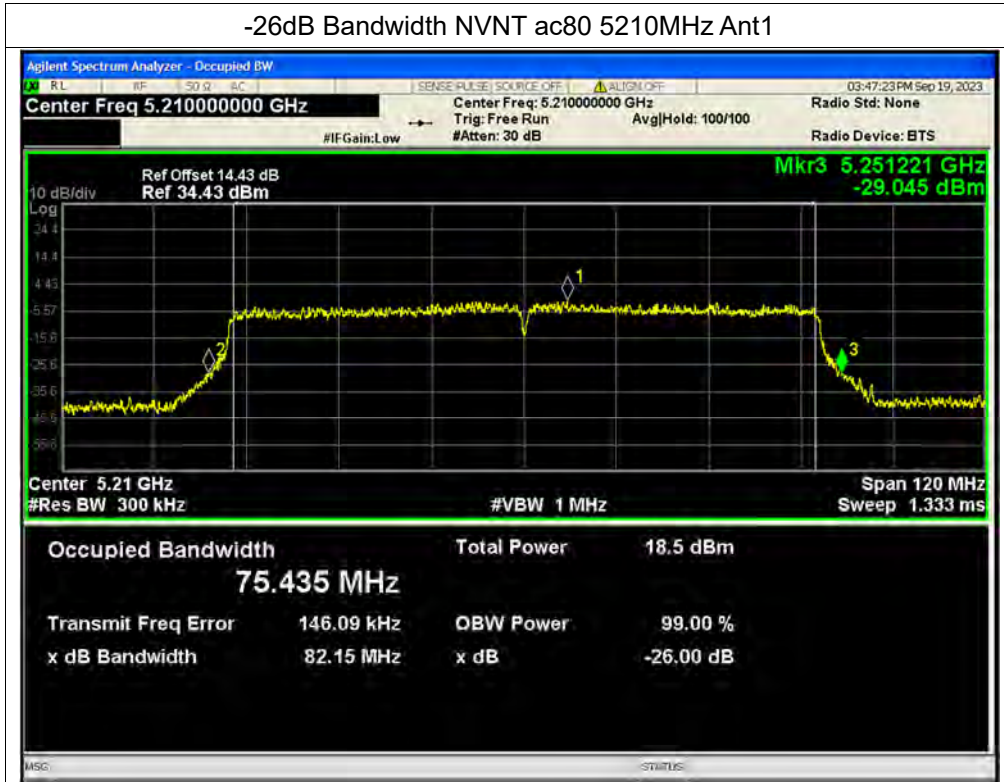

-26dB Bandwidth NVNT ac80 5290MHz Ant1

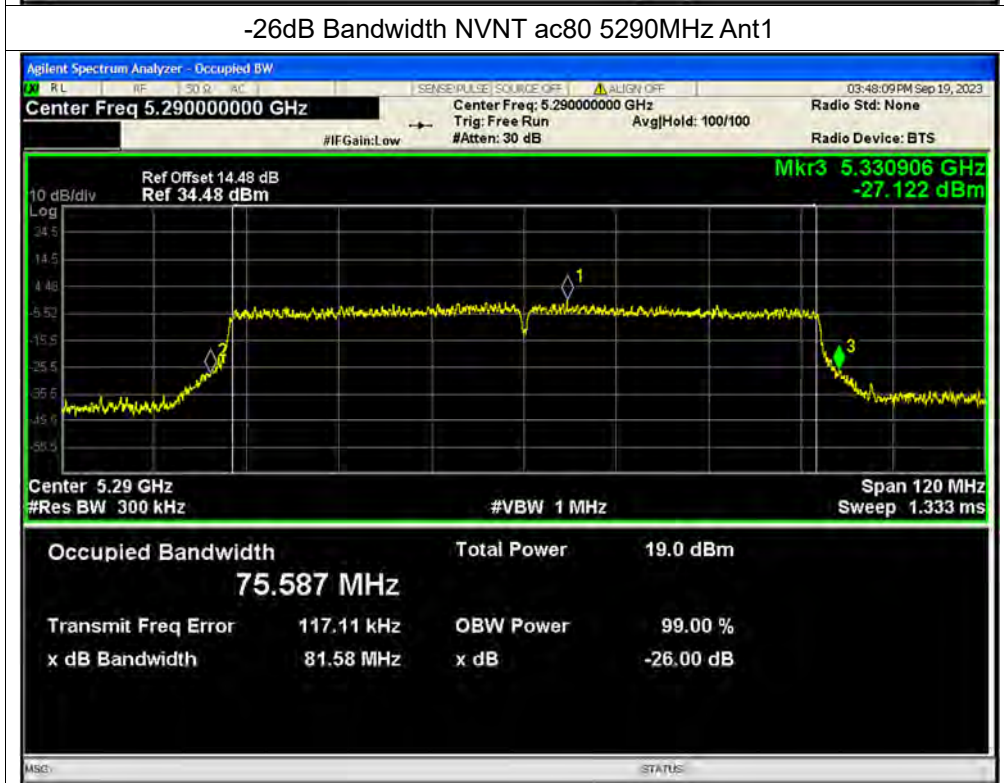



-26dB Bandwidth NVNT ac80 5530MHz Ant1

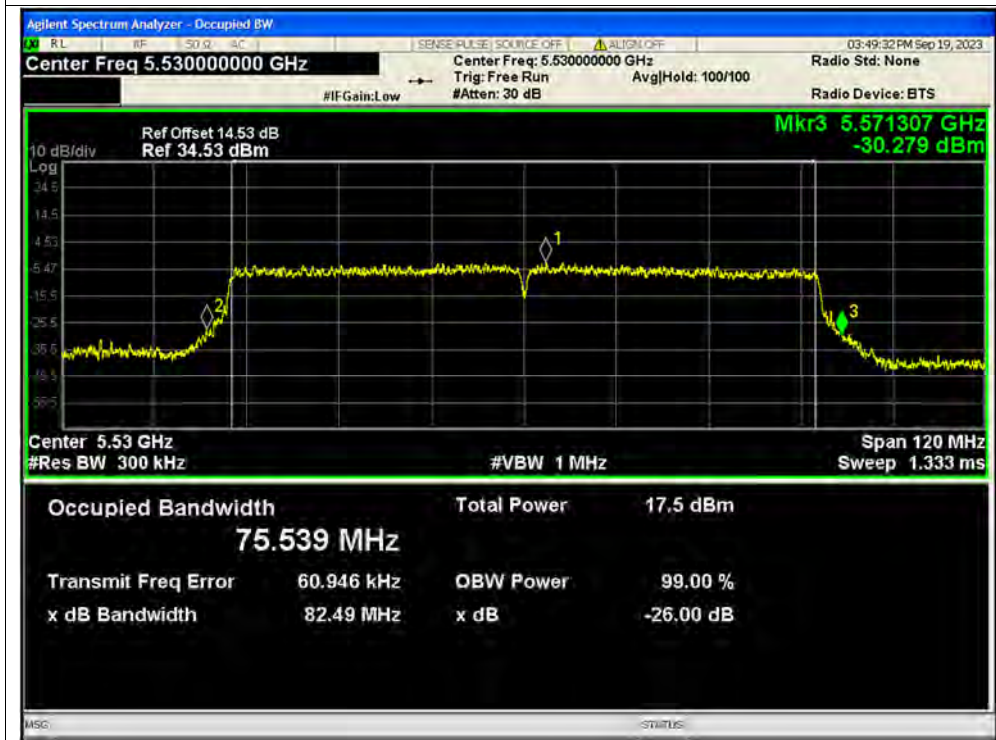

-26dB Bandwidth NVNT ac80 5610MHz Ant1

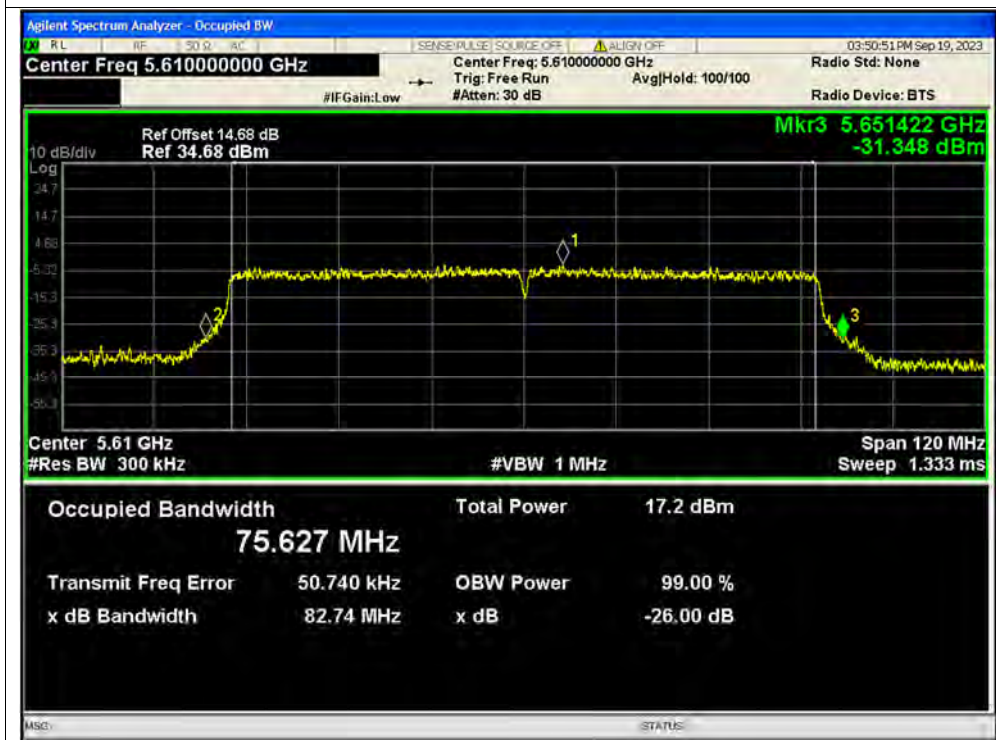

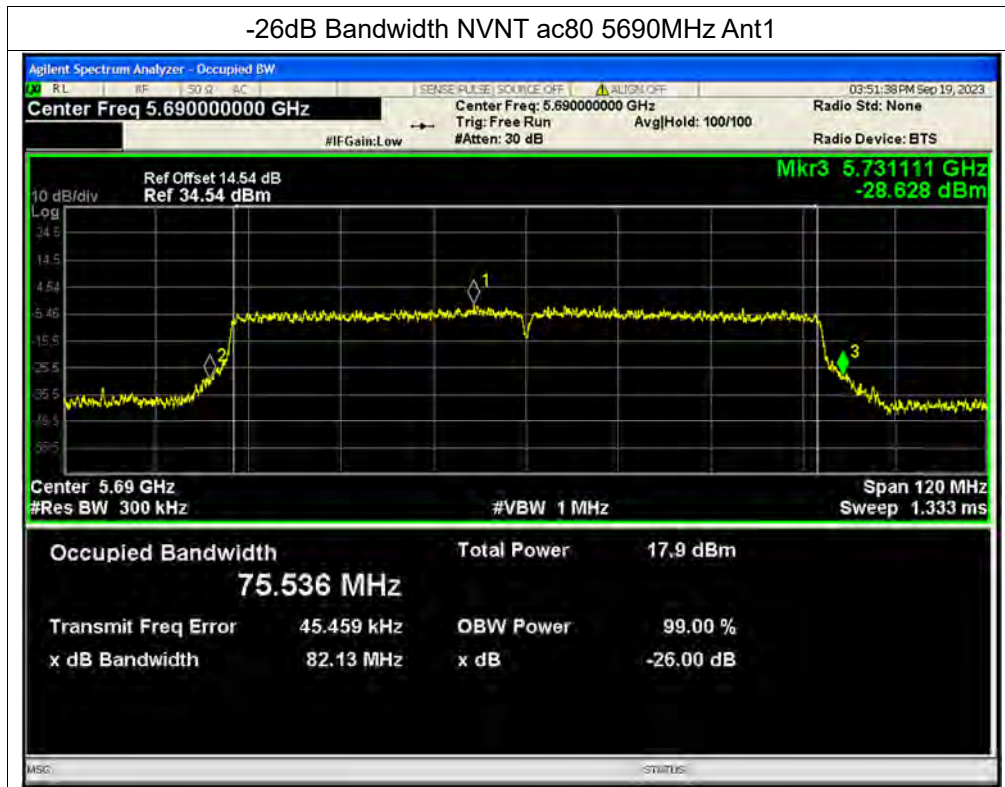





Test Graphs

-6dB Bandwidth NVNT a 5745MHz Ant1

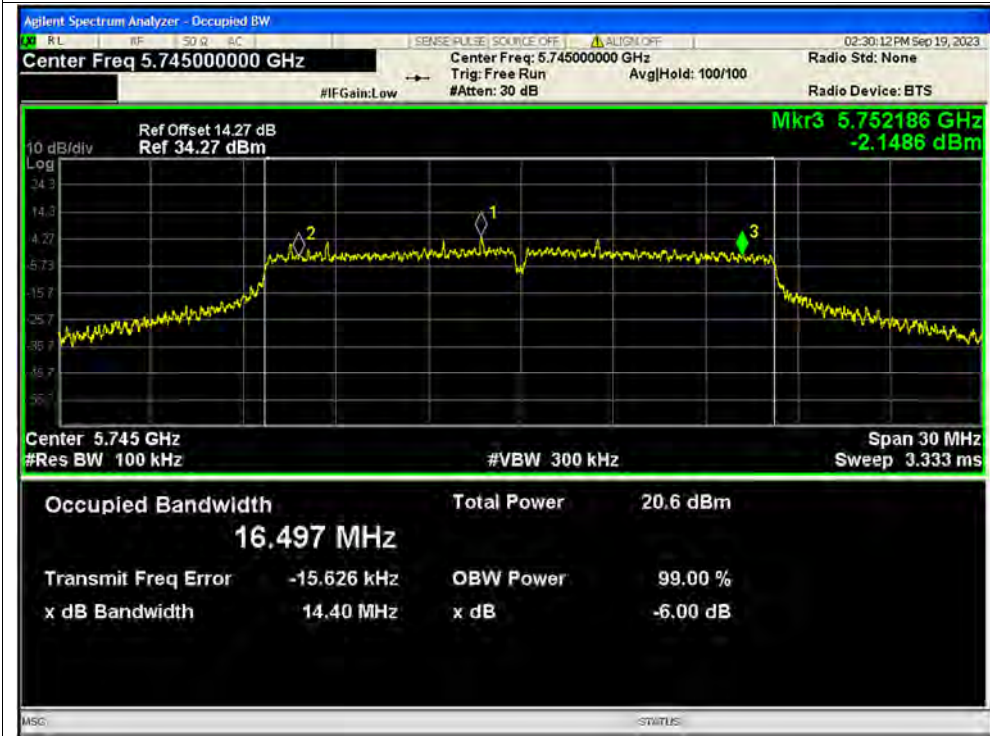

-6dB Bandwidth NVNT a 5785MHz Ant1







-6dB Bandwidth NVNT a 5825MHz Ant1

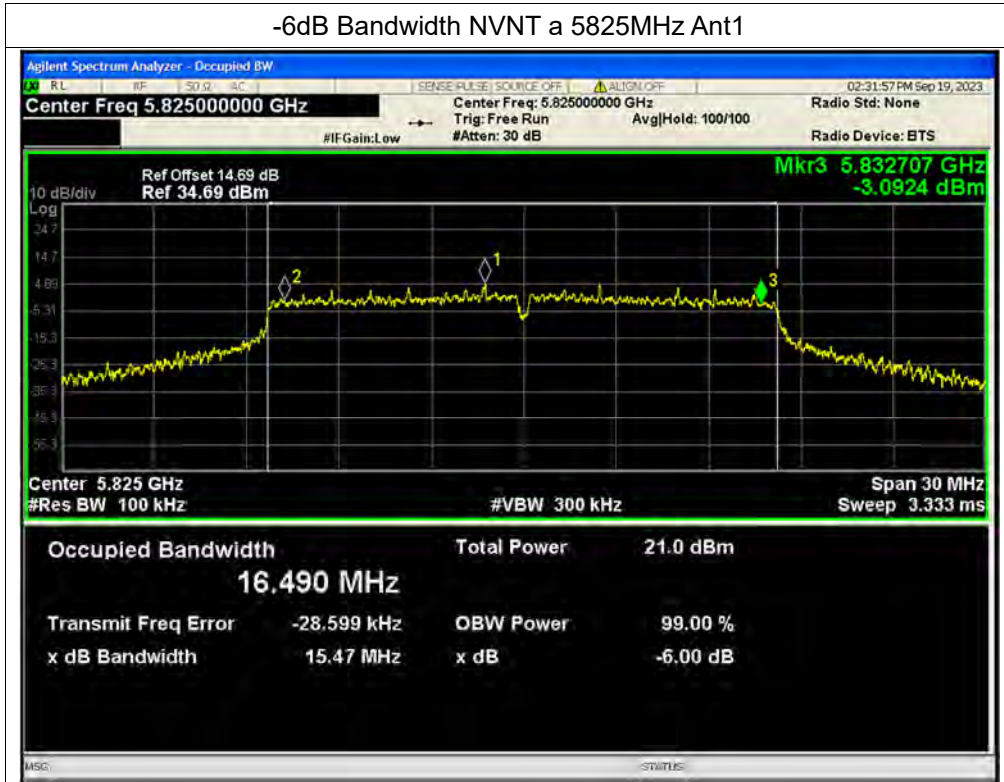

-6dB Bandwidth NVNT n20 5745MHz Ant1





-6dB Bandwidth NVNT n20 5785MHz Ant1

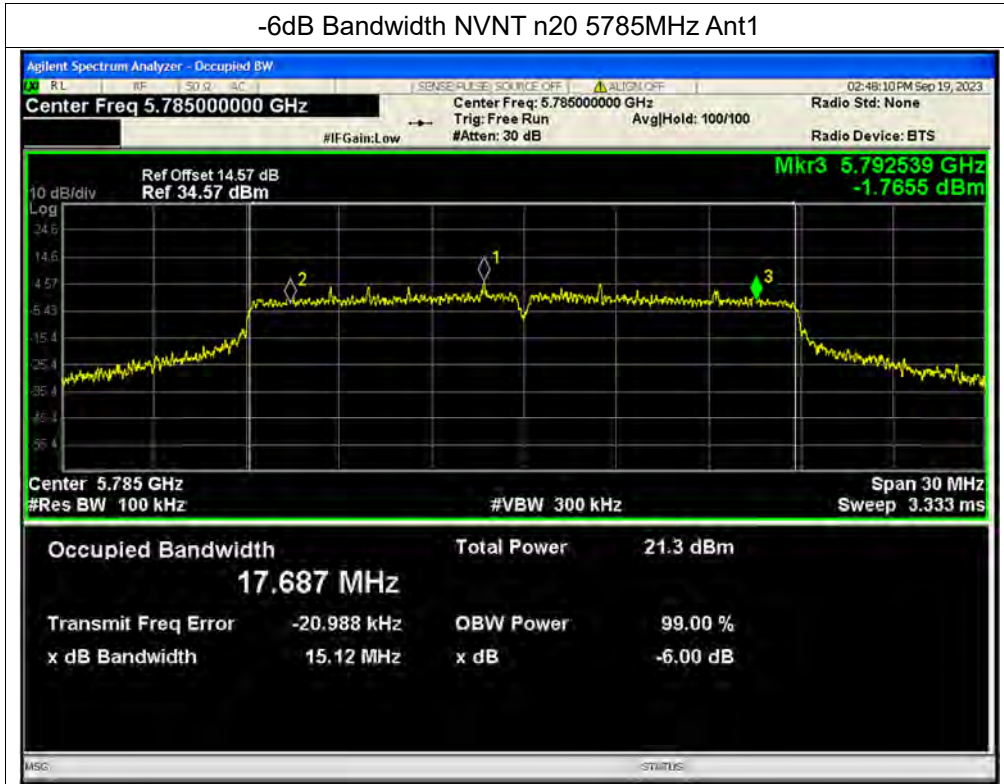

-6dB Bandwidth NVNT n20 5825MHz Ant1





-6dB Bandwidth NVNT n40 5755MHz Ant1

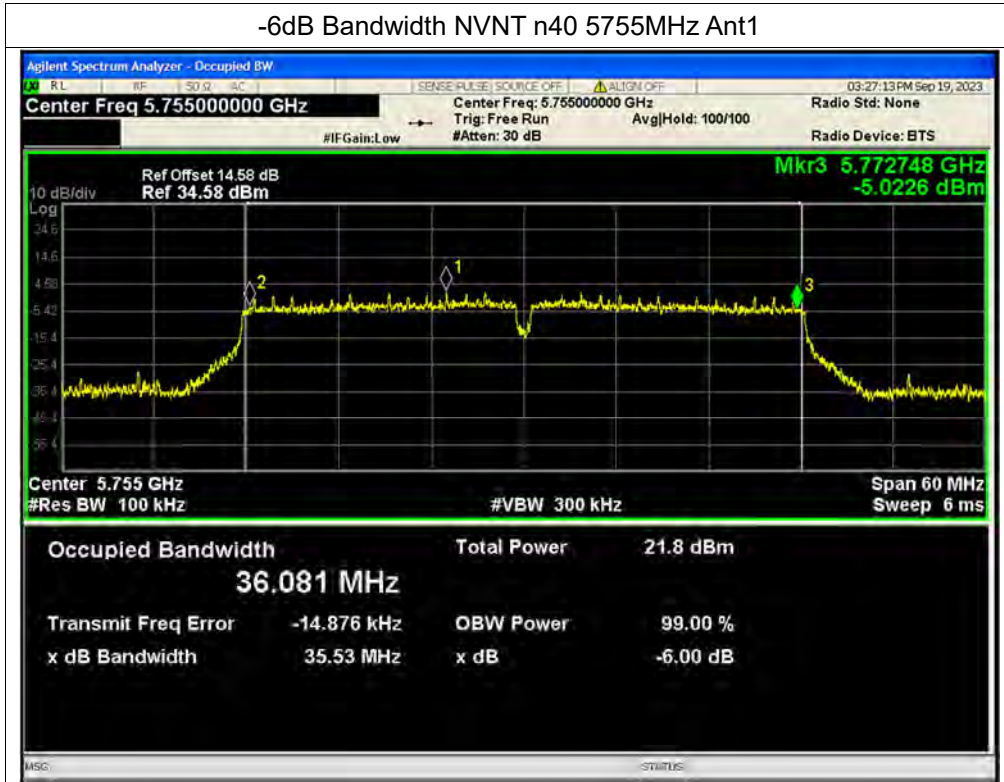

-6dB Bandwidth NVNT n40 5795MHz Ant1

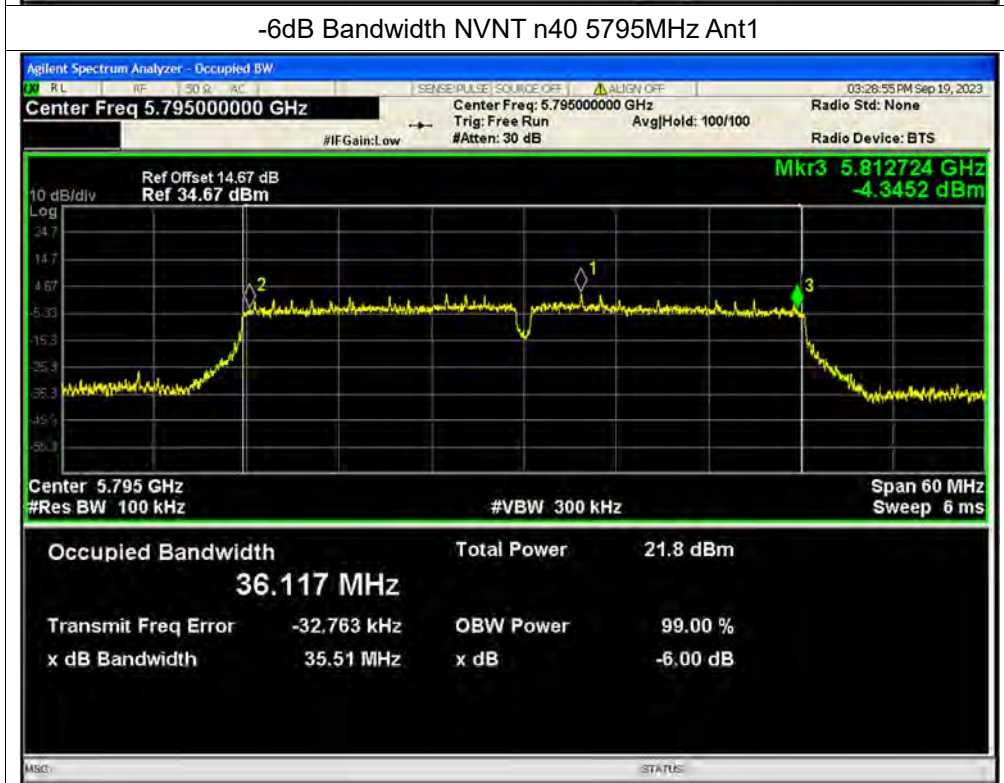





-6dB Bandwidth NVNT ac20 5745MHz Ant1

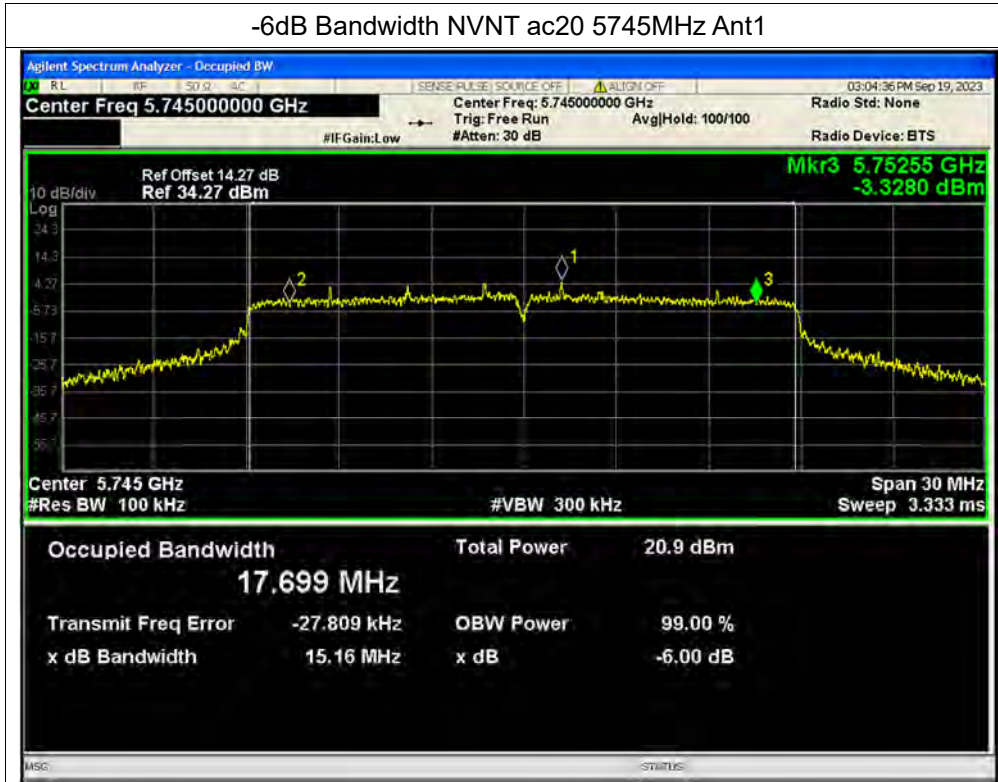

-6dB Bandwidth NVNT ac20 5785MHz Ant1







-6dB Bandwidth NVNT ac20 5825MHz Ant1

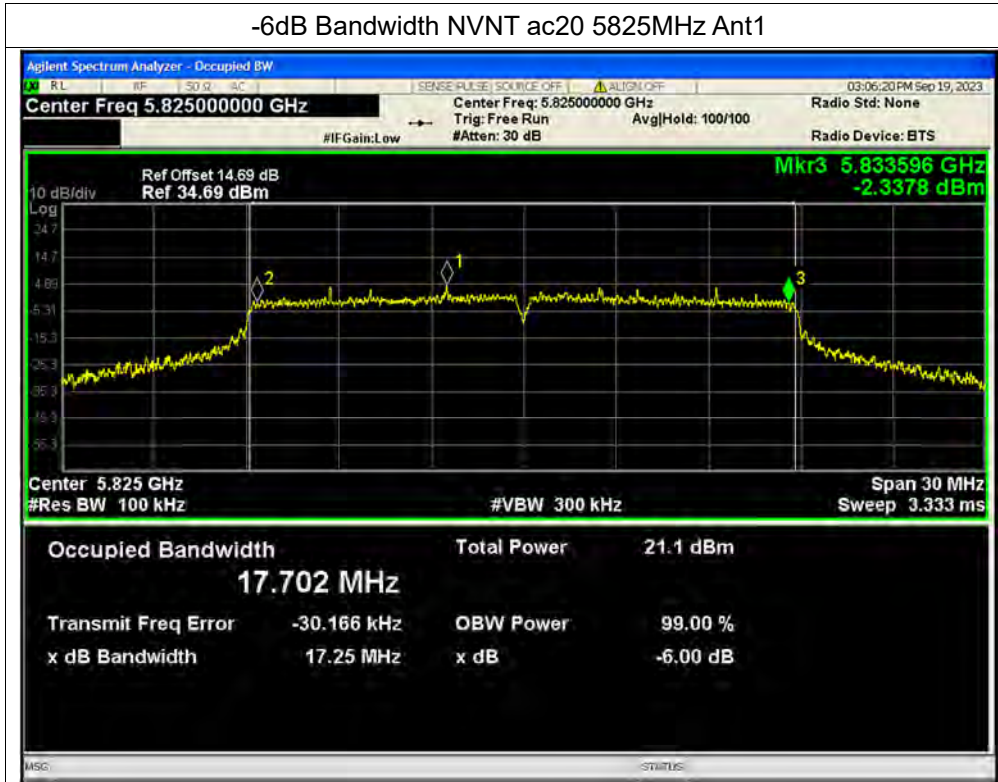

-6dB Bandwidth NVNT ac40 5755MHz Ant1

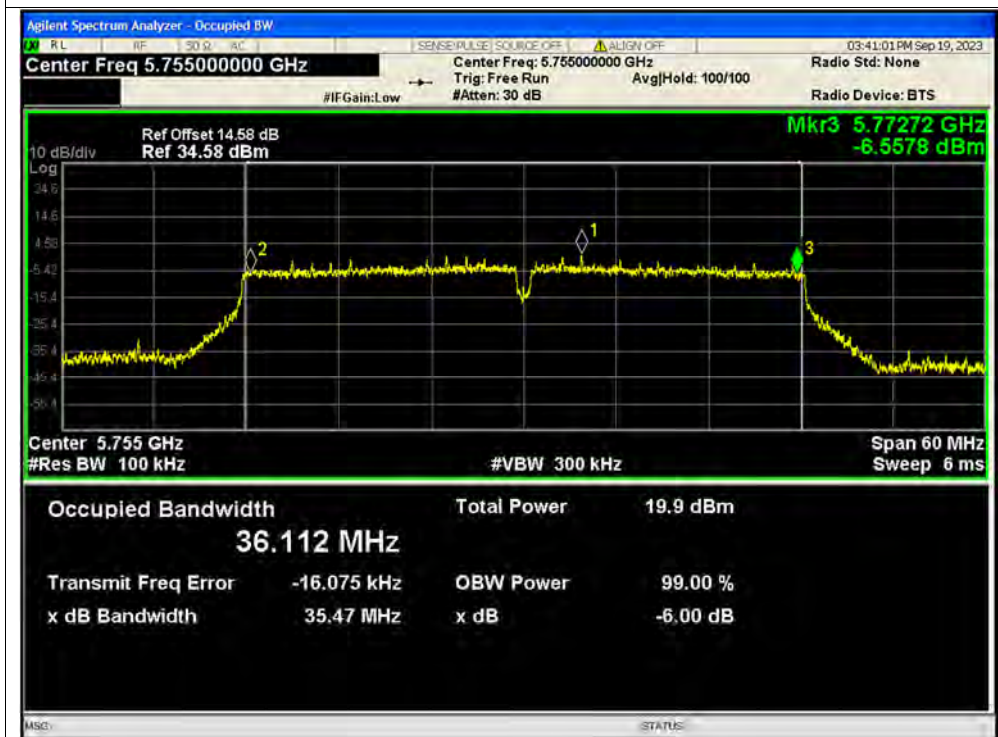



-6dB Bandwidth NVNT ac40 5795MHz Ant1

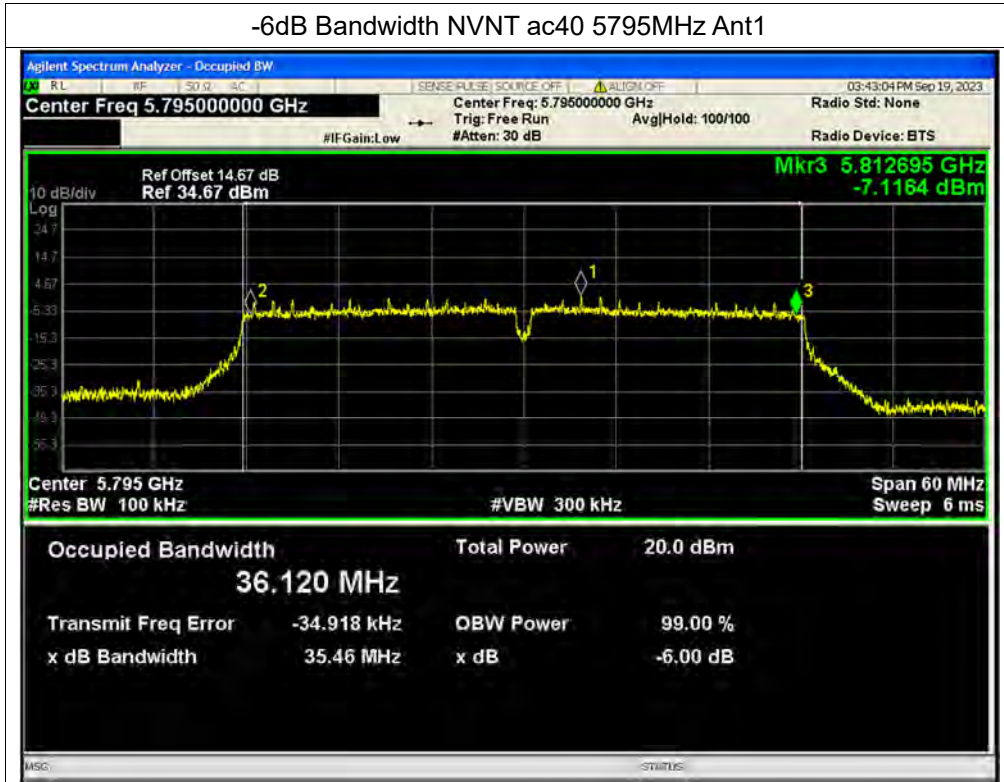

-6dB Bandwidth NVNT ac80 5775MHz Ant1

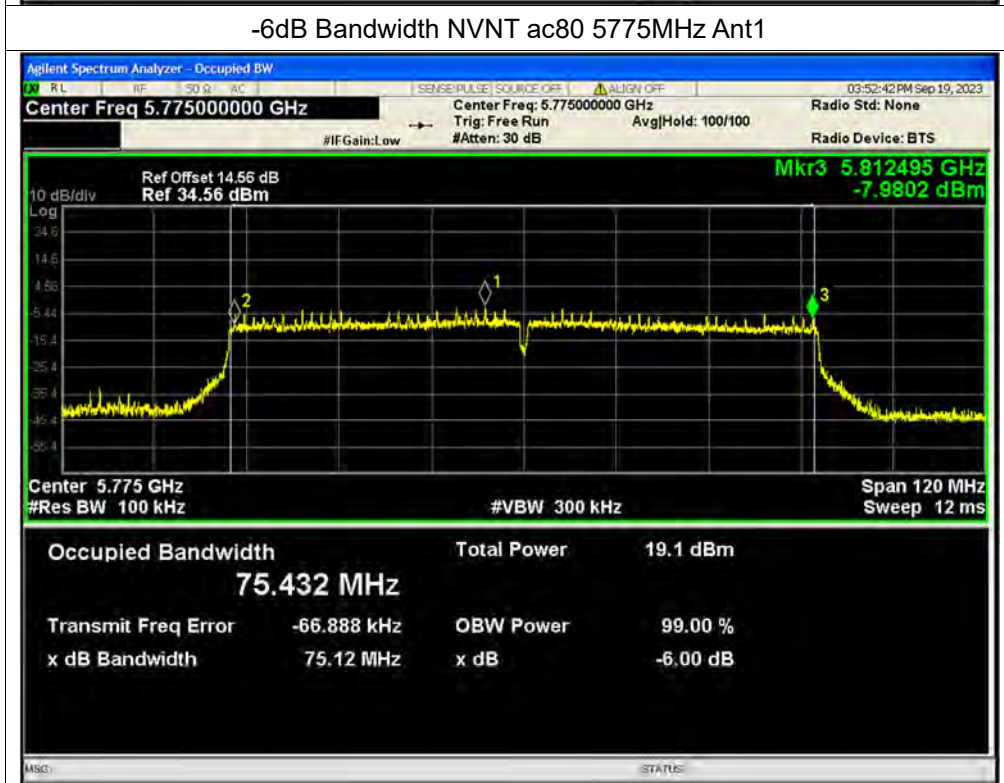

**A.4. Peak Power Spectral Density**

Condition	Mode	Frequency (MHz)	Antenna	Conducted PSD (dBm)	Duty Factor (dB)	Total PSD (dBm)	Limit (dBm)	Verdict
NVNT	a	5180	Ant1	4.08	0.08	4.16	11	Pass
NVNT	a	5220	Ant1	4.42	0.08	4.5	11	Pass
NVNT	a	5240	Ant1	4.59	0.08	4.67	11	Pass
NVNT	a	5260	Ant1	4.6	0.08	4.68	11	Pass
NVNT	a	5300	Ant1	4.73	0.08	4.81	11	Pass
NVNT	a	5320	Ant1	4.52	0.08	4.6	11	Pass
NVNT	a	5500	Ant1	3.59	0.08	3.67	11	Pass
NVNT	a	5580	Ant1	2.93	0.08	3.01	11	Pass
NVNT	a	5600	Ant1	2.97	0.08	3.05	11	Pass
NVNT	a	5720	Ant1	3.87	0.08	3.95	11	Pass
NVNT	a	5745	Ant1	1.24	0.08	1.32	30	Pass
NVNT	a	5785	Ant1	1.65	0.08	1.73	30	Pass
NVNT	a	5825	Ant1	1.36	0.08	1.44	30	Pass
NVNT	n20	5180	Ant1	3.54	0.09	3.63	11	Pass
NVNT	n20	5220	Ant1	4.02	0.09	4.11	11	Pass
NVNT	n20	5240	Ant1	4.3	0.09	4.39	11	Pass
NVNT	n20	5260	Ant1	4.32	0.09	4.41	11	Pass
NVNT	n20	5300	Ant1	4.29	0.09	4.38	11	Pass
NVNT	n20	5320	Ant1	4.02	0.09	4.11	11	Pass
NVNT	n20	5500	Ant1	3.22	0.09	3.31	11	Pass
NVNT	n20	5580	Ant1	2.61	0.09	2.7	11	Pass
NVNT	n20	5600	Ant1	2.36	0.09	2.45	11	Pass
NVNT	n20	5720	Ant1	3.64	0.09	3.73	11	Pass
NVNT	n20	5745	Ant1	0.81	0.1	0.91	30	Pass
NVNT	n20	5785	Ant1	1.06	0.09	1.15	30	Pass
NVNT	n20	5825	Ant1	0.87	0.09	0.96	30	Pass
NVNT	n40	5190	Ant1	1.08	0.18	1.26	11	Pass
NVNT	n40	5230	Ant1	1.4	0.18	1.58	11	Pass
NVNT	n40	5270	Ant1	1.76	0.18	1.94	11	Pass
NVNT	n40	5310	Ant1	1.63	0.19	1.82	11	Pass
NVNT	n40	5510	Ant1	0.47	0.18	0.65	11	Pass
NVNT	n40	5550	Ant1	0.34	0.18	0.52	11	Pass
NVNT	n40	5630	Ant1	0.3	0.18	0.48	11	Pass
NVNT	n40	5710	Ant1	0.81	0.18	0.99	11	Pass



NVNT	n40	5755	Ant1	-1.55	0.18	-1.37	30	Pass
NVNT	n40	5795	Ant1	-1.45	0.18	-1.27	30	Pass
NVNT	ac20	5180	Ant1	3.68	0.09	3.77	11	Pass
NVNT	ac20	5220	Ant1	3.94	0.1	4.04	11	Pass
NVNT	ac20	5240	Ant1	4.21	0.1	4.31	11	Pass
NVNT	ac20	5260	Ant1	4.39	0.1	4.49	11	Pass
NVNT	ac20	5300	Ant1	4.39	0.1	4.49	11	Pass
NVNT	ac20	5320	Ant1	4.12	0.09	4.21	11	Pass
NVNT	ac20	5500	Ant1	3.24	0.09	3.33	11	Pass
NVNT	ac20	5580	Ant1	2.57	0.09	2.66	11	Pass
NVNT	ac20	5600	Ant1	2.49	0.09	2.58	11	Pass
NVNT	ac20	5720	Ant1	3.66	0.1	3.76	11	Pass
NVNT	ac20	5745	Ant1	0.73	0.09	0.82	30	Pass
NVNT	ac20	5785	Ant1	1.14	0.09	1.23	30	Pass
NVNT	ac20	5825	Ant1	0.93	0.1	1.03	30	Pass
NVNT	ac40	5190	Ant1	0.85	0.18	1.03	11	Pass
NVNT	ac40	5230	Ant1	-0.46	0.18	-0.28	11	Pass
NVNT	ac40	5270	Ant1	-0.33	0.19	-0.14	11	Pass
NVNT	ac40	5310	Ant1	-0.34	0.19	-0.15	11	Pass
NVNT	ac40	5510	Ant1	-1.68	0.18	-1.5	11	Pass
NVNT	ac40	5550	Ant1	-2.05	0.19	-1.86	11	Pass
NVNT	ac40	5630	Ant1	-2.02	0.18	-1.84	11	Pass
NVNT	ac40	5710	Ant1	-1.39	0.18	-1.21	11	Pass
NVNT	ac40	5755	Ant1	-3.37	0.19	-3.18	30	Pass
NVNT	ac40	5795	Ant1	-3.45	0.19	-3.26	30	Pass
NVNT	ac80	5210	Ant1	-5.03	0.36	-4.67	11	Pass
NVNT	ac80	5290	Ant1	-4.38	0.34	-4.04	11	Pass
NVNT	ac80	5530	Ant1	-5.94	0.36	-5.57	11	Pass
NVNT	ac80	5610	Ant1	-6.07	0.36	-5.71	11	Pass
NVNT	ac80	5690	Ant1	-5.18	0.36	-4.82	11	Pass
NVNT	ac80	5775	Ant1	-7.32	0.34	-6.98	30	Pass



Test Graphs

PSD NVNT a 5180MHz Ant1

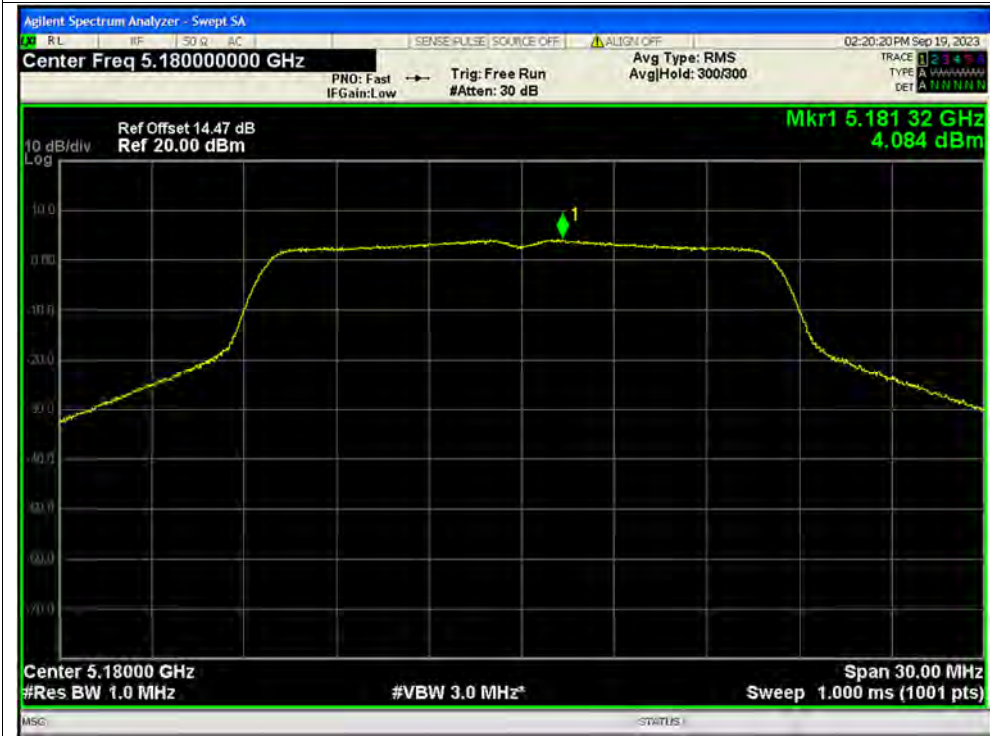

PSD NVNT a 5220MHz Ant1

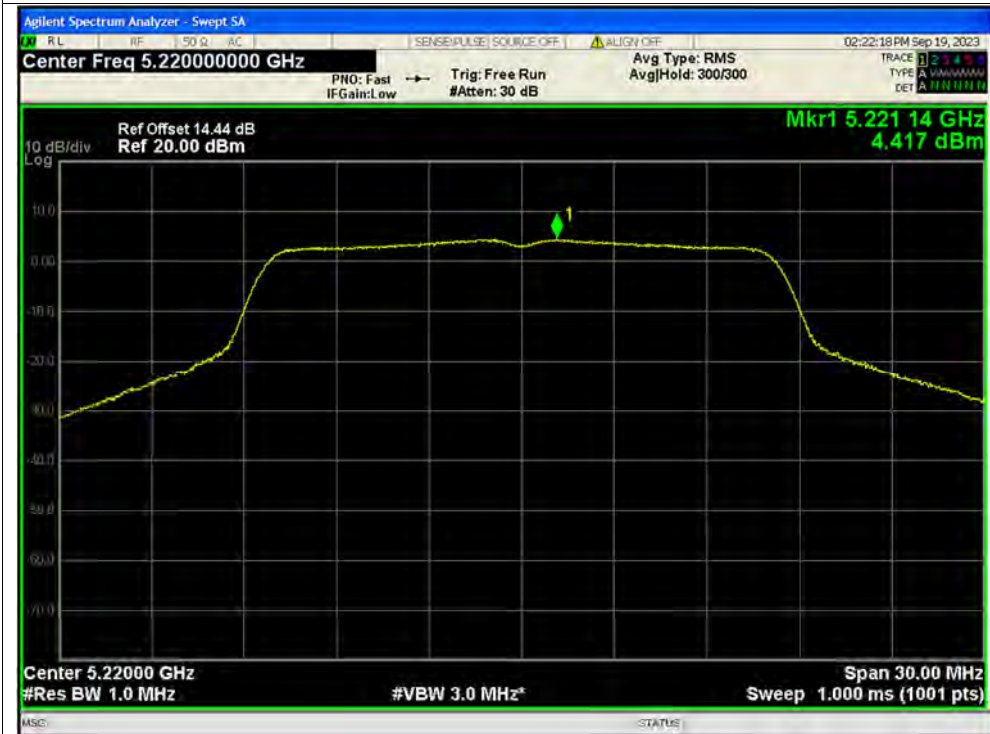



PSD NVNT a 5240MHz Ant1



PSD NVNT a 5260MHz Ant1

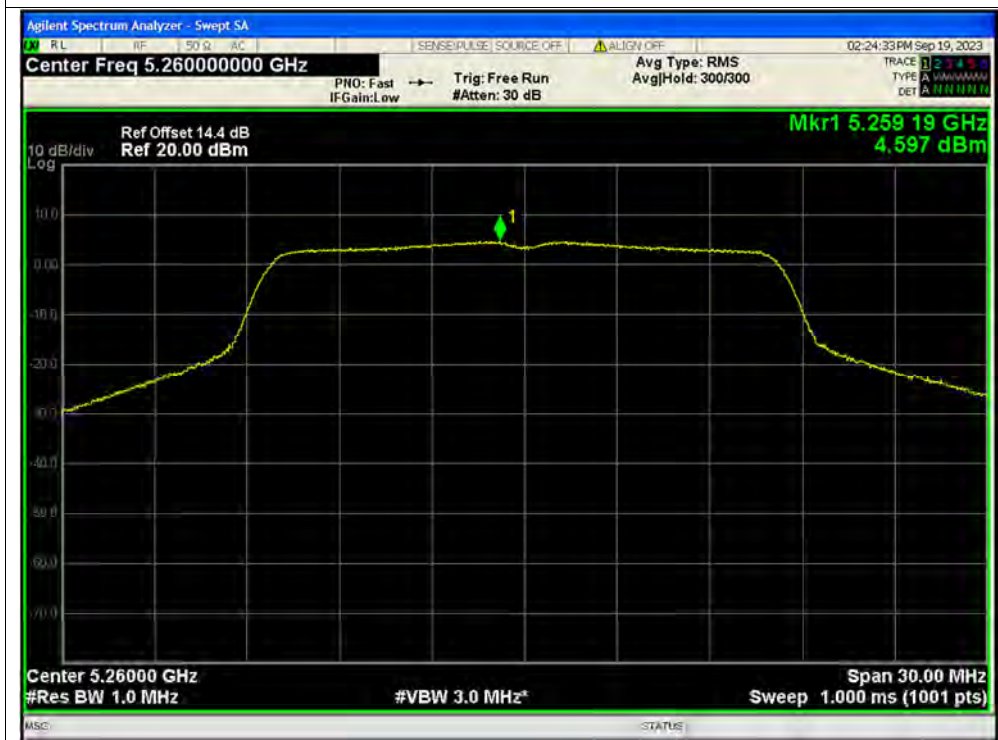



PSD NVNT a 5300MHz Ant1

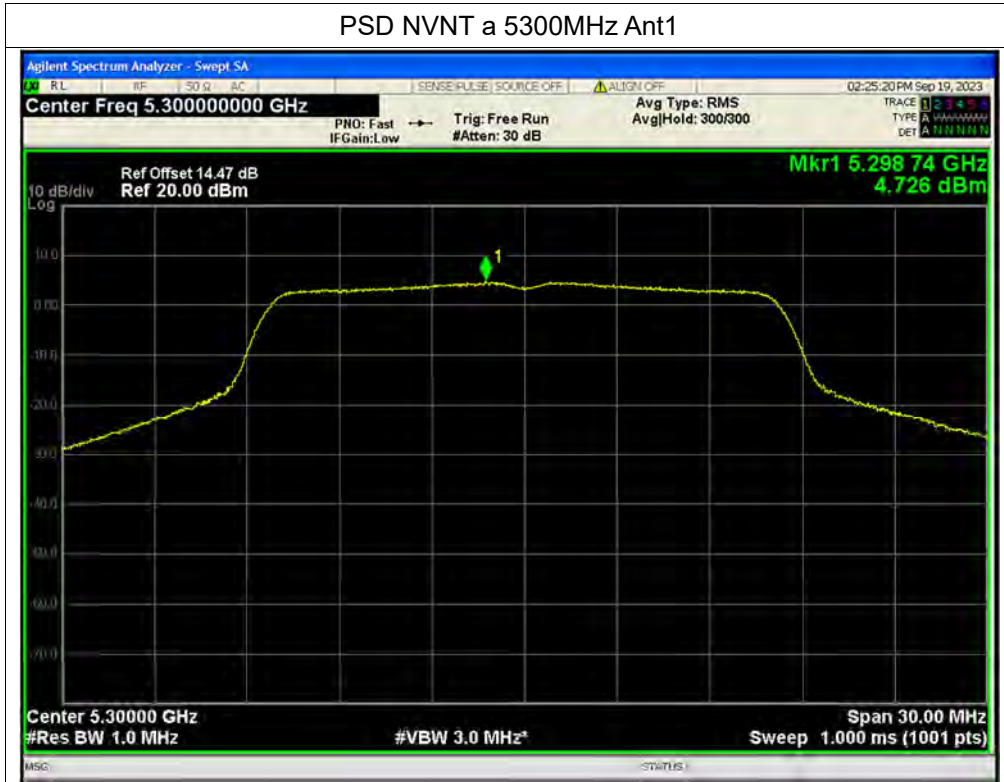

PSD NVNT a 5320MHz Ant1

