



# SGS-CSTC Standards Technical Services Co., Ltd. Shenzhen Branch

Report No.: SZCR240200055101  
Rev.: 01  
Page: 1 of 53

## TEST REPORT

**Application No.:** SZCR2402000551MO  
**Applicant:** Fibocom Wireless Inc  
**Address of Applicant:** 1101, Tower A, Building 6, Shenzhen International Innovation Valley, Dashi 1st Rd, Nanshan, Shenzhen, China  
**Manufacturer:** Fibocom Wireless Inc  
**Address of Manufacturer:** 1101, Tower A, Building 6, Shenzhen International Innovation Valley, Dashi 1st Rd, Nanshan, Shenzhen, China  
**EUT Description:** 5G RedCap Module  
**Model No.:** FG132-GL  
**Trade Mark:** Fibocom  
**FCC ID:** ZMOFG132GL  
**Standards:** 47 CFR Part 2  
47 CFR Part 22  
47 CFR Part 24  
47 CFR Part 27  
47 CFR Part 90  
47 CFR Part 96  
**Date of Receipt:** 2024/02/21  
**Date of Test:** 2024/03/01 to 2024/04/22  
**Date of Issue:** 2024/04/28

<b>Test Result :</b>	<b>PASS *</b>
----------------------	---------------

\* In the configuration tested, the EUT detailed in this report complied with the standards specified above.

Authorized Signature:

Keny Xu  
Laboratory Manager



Unless otherwise agreed in writing, this document is issued by the Company subject to its General Conditions of Service printed overleaf, available on request or accessible at <https://www.sgs.com/en/Terms-and-Conditions>. Attention is drawn to the limitation of liability, indemnification and jurisdiction issues defined therein. Any holder of this document is advised that information contained hereon reflects the Company's findings at the time of its intervention only and within the limits of Client's instructions, if any. The Company's sole responsibility is to its Client and this document does not exonerate parties to a transaction from exercising all their rights and obligations under the transaction documents. This document cannot be reproduced except in full, without prior written approval of the Company. Any unauthorized alteration, forgery or falsification of the content or appearance of this document is unlawful and offenders may be prosecuted to the fullest extent of the law. Unless otherwise stated the results shown in this test report refer only to the sample(s) tested and such sample(s) are retained for 30 days only.  
**Attention: To check the authenticity of testing /inspection report & certificate, please contact us at telephone: (86-755) 8307 1443, or email: CN.Doccheck@sgs.com**

No.1 Workshop, M-10, Middle Section, Science & Technology Park, Nanshan District, Shenzhen, Guangdong, China 518057 t (86-755) 26012053 www.sgsgroup.com.cn  
中国·广东·深圳市南山区科技园中区M-10栋1号厂房 邮编: 518057 t (86-755) 26012053 sgs.china@sgs.com





**SGS-CSTC Standards Technical Services Co., Ltd.**  
**Shenzhen Branch**

Report No.: SZCR240200055101  
 Rev.: 01  
 Page: 2 of 53

**1 Version**

Revision Record				
Version	Chapter	Date	Modifier	Remark
01		2024/04/28		Original

<b>Prepared By</b>	 <hr/> (Jack Huang) / Test Engineer
<b>Checked By</b>	 <hr/> (Flora Wang) / Reviewer



Unless otherwise agreed in writing, this document is issued by the Company subject to its General Conditions of Service printed overleaf, available on request or accessible at <https://www.sgs.com/en/Terms-and-Conditions>. Attention is drawn to the limitation of liability, indemnification and jurisdiction issues defined therein. Any holder of this document is advised that information contained hereon reflects the Company's findings at the time of its intervention only and within the limits of Client's instructions, if any. The Company's sole responsibility is to its Client and this document does not exonerate parties to a transaction from exercising all their rights and obligations under the transaction documents. This document cannot be reproduced except in full, without prior written approval of the Company. Any unauthorized alteration, forgery or falsification of the content or appearance of this document is unlawful and offenders may be prosecuted to the fullest extent of the law. Unless otherwise stated the results shown in this test report refer only to the sample(s) tested and such sample(s) are retained for 30 days only.  
**Attention: To check the authenticity of testing /inspection report & certificate, please contact us at telephone: (86-755) 8307 1443, or email: CN.Doccheck@sgs.com**

No.1 Workshop, M-10, Middle Section, Science & Technology Park, Nanshan District, Shenzhen, Guangdong, China 518057 t (86-755) 26012053 www.sgsgroup.com.cn  
 中国·广东·深圳市南山区科技园中区M-10栋1号厂房 邮编: 518057 t (86-755) 26012053 sgs.china@sgs.com

 Report No.: SZCR240200055101  
 Rev.: 01  
 Page: 3 of 53

## Contents

1	Version .....	2
2	Test Summary .....	5
2.1	LTE Band 5/26(824~849 MHz)/26(814~849 MHz) .....	5
2.2	LTE Band 2 /25 .....	6
2.3	LTE Band 4 /66 .....	7
2.4	LTE Band 7/38/41 .....	8
2.5	LTE Band 12/17 .....	10
2.6	LTE Band 13 .....	11
2.7	LTE Band 14 .....	12
2.8	LTE Band 26(814~824 MHz) .....	14
2.9	LTE Band 30 .....	15
2.10	LTE Band 42 .....	17
2.11	LTE Band 43 .....	18
2.12	LTE Band 71 .....	19
2.13	LTE Band 42/ LTE Band 43/ LTE Band 48 .....	20
3	General Information .....	22
3.1	Details of Client .....	22
3.2	Test Location .....	22
3.3	Test Facility .....	22
3.4	General Description of EUT .....	23
3.5	Test Mode .....	24
3.6	Test Environment .....	24
3.7	Description of Support Units .....	24
3.8	Technical Specification .....	25
3.9	Test Frequencies .....	27
4	Description of Tests .....	37
4.1	Conducted Output Power .....	37
4.2	Effective (Isotropic) Radiated Power of Transmitter .....	38
4.3	EIRP Power Density .....	39
4.4	Occupied Bandwidth .....	40

 SGS-CSTC Standards Technical Services Co., Ltd.  
 Shenzhen Branch Wireless Laboratory

Unless otherwise agreed in writing, this document is issued by the Company subject to its General Conditions of Service printed overleaf, available on request or accessible at <https://www.sgs.com/en/Terms-and-Conditions>. Attention is drawn to the limitation of liability, indemnification and jurisdiction issues defined therein. Any holder of this document is advised that information contained hereon reflects the Company's findings at the time of its intervention only and within the limits of Client's instructions, if any. The Company's sole responsibility is to its Client and this document does not exonerate parties to a transaction from exercising all their rights and obligations under the transaction documents. This document cannot be reproduced except in full, without prior written approval of the Company. Any unauthorized alteration, forgery or falsification of the content or appearance of this document is unlawful and offenders may be prosecuted to the fullest extent of the law. Unless otherwise stated the results shown in this test report refer only to the sample(s) tested and such sample(s) are retained for 30 days only.

Attention: To check the authenticity of testing /inspection report & certificate, please contact us at telephone: (86-755) 8307 1443, or email: CN.Doccheck@sgs.com

No.1 Workshop, M-10, Middle Section, Science & Technology Park, Nanshan District, Shenzhen, Guangdong, China 518057 t (86-755) 26012053 www.sgsgroup.com.cn  
 中国·广东·深圳市南山区科技园中区M-10栋1号厂房 邮编: 518057 t (86-755) 26012053 sgs.china@sgs.com



# SGS-CSTC Standards Technical Services Co., Ltd. Shenzhen Branch

Report No.: SZCR240200055101  
Rev.: 01  
Page: 4 of 53

4.5	Band Edge at Antenna Terminals .....	41
4.6	Spurious And Harmonic Emissions at Antenna Terminal.....	42
4.7	Peak-Average Ratio .....	43
4.8	Field Strength of Spurious Radiation.....	44
4.9	Frequency Stability / Temperature Variation .....	45
4.10	Test Setups.....	46
4.10.1	Test Setup 1 .....	46
4.10.2	Test Setup 2 .....	46
4.10.3	Test Setup 3 .....	47
4.11	Test Conditions .....	48
5	Main Test Instruments .....	50
6	Measurement Uncertainty.....	52
7	Appendixes.....	53



SGS-CSTC Standards Technical Services Co., Ltd.  
Shenzhen Branch Inspection & Testing Services  
Shenzhen Branch Wireless Laboratory

Unless otherwise agreed in writing, this document is issued by the Company subject to its General Conditions of Service printed overleaf, available on request or accessible at <https://www.sgs.com/en/Terms-and-Conditions>. Attention is drawn to the limitation of liability, indemnification and jurisdiction issues defined therein. Any holder of this document is advised that information contained hereon reflects the Company's findings at the time of its intervention only and within the limits of Client's instructions, if any. The Company's sole responsibility is to its Client and this document does not exonerate parties to a transaction from exercising all their rights and obligations under the transaction documents. This document cannot be reproduced except in full, without prior written approval of the Company. Any unauthorized alteration, forgery or falsification of the content or appearance of this document is unlawful and offenders may be prosecuted to the fullest extent of the law. Unless otherwise stated the results shown in this test report refer only to the sample(s) tested and such sample(s) are retained for 30 days only.

Attention: To check the authenticity of testing /inspection report & certificate, please contact us at telephone: (86-755) 8307 1443, or email: CN.Doccheck@sgs.com

No.1 Workshop, M-10, Middle Section, Science & Technology Park, Nanshan District, Shenzhen, Guangdong, China 518057 t (86-755) 26012053 www.sgs.com.cn  
中国·广东·深圳市南山区科技园中区M-10栋1号厂房 邮编: 518057 t (86-755) 26012053 sgs.china@sgs.com



# SGS-CSTC Standards Technical Services Co., Ltd. Shenzhen Branch

Report No.: SZCR240200055101  
Rev.: 01  
Page: 5 of 53

## 2 Test Summary

### 2.1 LTE Band 5/26(824~849 MHz)/26(814~849 MHz)

Test Item	FCC Rule No.	Requirements	Test Result	Verdict
Effective (Isotropic) Radiated Power Output Data	§2.1046, §22.913(a)(5)	ERP ≤ 7 W	Section 1 of Appendix B.3&B.11&B42	Pass
Peak-Average Ratio	§22.913(d)	Limit≤13 dB	Section 4 of Appendix B.3&B.11 B42	Pass
Bandwidth	§2.1049	OBW: No limit. EBW: No limit.	Section 3 of Appendix B.3&B.11 B42	Pass
Band Edges Compliance	§2.1051, §22.917(a)	≤ -13 dBm/1%*EBW, in 1 MHz bands immediately outside and adjacent to the frequency block.	Section 5 of Appendix B.3&B.11 B42	Pass
Spurious Emission at Antenna Terminals	§2.1051, §22.917(a)	FCC: ≤ -13 dBm/100 kHz, from 9 kHz to 10th harmonics but outside authorized operating frequency ranges.	Section 5 of Appendix B.3&B.11 B42	Pass
Field Strength of Spurious Radiation	§2.1053, §22.917(a)	FCC: ≤ -13 dBm/100 kHz.	Section 6 of Appendix B.3&B.11	Pass
Frequency Stability	§2.1055(a)(1)(b) §2.1055(d)(1)§22.355	±2.5ppm.	Section 2 of Appendix B.3&B.11 B42	Pass



SGS-CSTC Standards Technical Services Co., Ltd.  
Shenzhen Branch Inspection & Testing Services  
Shenzhen Branch Wireless Laboratory

Unless otherwise agreed in writing, this document is issued by the Company subject to its General Conditions of Service printed overleaf, available on request or accessible at <https://www.sgs.com/en/Terms-and-Conditions>. Attention is drawn to the limitation of liability, indemnification and jurisdiction issues defined therein. Any holder of this document is advised that information contained hereon reflects the Company's findings at the time of its intervention only and within the limits of Client's instructions, if any. The Company's sole responsibility is to its Client and this document does not exonerate parties to a transaction from exercising all their rights and obligations under the transaction documents. This document cannot be reproduced except in full, without prior written approval of the Company. Any unauthorized alteration, forgery or falsification of the content or appearance of this document is unlawful and offenders may be prosecuted to the fullest extent of the law. Unless otherwise stated the results shown in this test report refer only to the sample(s) tested and such sample(s) are retained for 30 days only.  
**Attention: To check the authenticity of testing /inspection report & certificate, please contact us at telephone: (86-755) 8307 1443, or email: CN.Doccheck@sgs.com**

No.1 Workshop, M-10, Middle Section, Science & Technology Park, Nanshan District, Shenzhen, Guangdong, China 518057 t (86-755) 26012053 www.sgs.com.cn  
中国·广东·深圳市南山区科技园中区M-10栋1号厂房 邮编: 518057 t (86-755) 26012053 sgs.china@sgs.com





# SGS-CSTC Standards Technical Services Co., Ltd. Shenzhen Branch

Report No.: SZCR240200055101  
Rev.: 01  
Page: 6 of 53

## 2.2 LTE Band 2 /25

Test Item	FCC Rule No.	Requirements	Test Result	Verdict
Effective (Isotropic) Radiated Power Output Data	§2.1046, §24.232(c)	EIRP ≤ 2 W	Section 1 of Appendix B.1&B.9	Pass
Peak-Average Ratio	§24.232(d)	Limit≤13 dB	Section 4 of Appendix B.1&B.9	Pass
Bandwidth	§2.1049	OBW: No limit. EBW: No limit.	Section 3 of Appendix B.1&B.9	Pass
Band Edges Compliance	§2.1051, §24.238(a)	≤ -13 dBm/1%*EBW, in 1 MHz bands immediately outside and adjacent to the frequency block.	Section 5 of Appendix B.1&B.9	Pass
Spurious Emission at Antenna Terminals	§2.1051, §24.238(a)	≤ -13 dBm/1 MHz, from 9 kHz to 10 <sup>th</sup> harmonics but outside authorized operating frequency ranges.	Section 5 of Appendix B.1&B.9	Pass
Field Strength of Spurious Radiation	§2.1053, §24.238(a)	≤ -13 dBm/1 MHz.	Section 6 of Appendix B.1&B.9	Pass
Frequency Stability	§2.1055(a)(1)(b) §2.1055(d)(1)§24.235	Within authorized bands of operation/frequency block.	Section 2 of Appendix B.1&B.9	Pass



SGS-CSTC Standards Technical Services Co., Ltd.  
Shenzhen Branch Inspection & Testing Services

Unless otherwise agreed in writing, this document is issued by the Company subject to its General Conditions of Service printed overleaf, available on request or accessible at <https://www.sgs.com/en/Terms-and-Conditions>. Attention is drawn to the limitation of liability, indemnification and jurisdiction issues defined therein. Any holder of this document is advised that information contained hereon reflects the Company's findings at the time of its intervention only and within the limits of Client's instructions, if any. The Company's sole responsibility is to its Client and this document does not exonerate parties to a transaction from exercising all their rights and obligations under the transaction documents. This document cannot be reproduced except in full, without prior written approval of the Company. Any unauthorized alteration, forgery or falsification of the content or appearance of this document is unlawful and offenders may be prosecuted to the fullest extent of the law. Unless otherwise stated the results shown in this test report refer only to the sample(s) tested and such sample(s) are retained for 30 days only.  
**Attention: To check the authenticity of testing /inspection report & certificate, please contact us at telephone: (86-755) 8307 1443, or email: CN.Doccheck@sgs.com**

No.1 Workshop, M-10, Middle Section, Science & Technology Park, Nanshan District, Shenzhen, Guangdong, China 518057 t (86-755) 26012053 www.sgs.com.cn  
中国·广东·深圳市南山区科技园中区M-10栋1号厂房 邮编: 518057 t (86-755) 26012053 sgs.china@sgs.com



# SGS-CSTC Standards Technical Services Co., Ltd. Shenzhen Branch

Report No.: SZCR240200055101  
Rev.: 01  
Page: 7 of 53

## 2.3 LTE Band 4 /66

Test Item	FCC Rule No.	Requirements	Test Result	Verdict
Effective (Isotropic) Radiated Power Output Data	§2.1046, §27.50(d)(4)	$EIRP \leq 1\text{ W}$	Section 1 of Appendix B.2&B.18	Pass
Peak-Average Ratio	§27.50(d)(5)	Limit $\leq$ 13 dB	Section 4 of Appendix B.2&B.18	Pass
Bandwidth	§2.1049	OBW: No limit. EBW: No limit.	Section 3 of Appendix B.2&B.18	Pass
Band Edges Compliance	§2.1051, §27.53(h)	$\leq -13\text{ dBm}/1\%*EBW$ , in 1 MHz bands immediately outside and adjacent to the frequency block.	Section 5 of Appendix B.2&B.18	Pass
Spurious Emission at Antenna Terminals	§2.1051, §27.53(h)	$\leq -13\text{ dBm}/1\text{ MHz}$ , from 9 kHz to 10 <sup>th</sup> harmonics but outside authorized operating frequency ranges.	Section 5 of Appendix B.2&B.18	Pass
Field Strength of Spurious Radiation	§2.1053, §27.53(h)	$\leq -13\text{ dBm}/1\text{ MHz}$ .	Section 6 of Appendix B.2&B.18	Pass
Frequency Stability	§2.1055(a)(1)(b) §2.1055(d)(1)§27.54	Within authorized bands of operation/frequency block.	Section 2 of Appendix B.2&B.18	Pass



SGS-CSTC Standards Technical Services Co., Ltd.  
Shenzhen Branch Inspection & Testing Services

Unless otherwise agreed in writing, this document is issued by the Company subject to its General Conditions of Service printed overleaf, available on request or accessible at <https://www.sgs.com/en/Terms-and-Conditions>. Attention is drawn to the limitation of liability, indemnification and jurisdiction issues defined therein. Any holder of this document is advised that information contained hereon reflects the Company's findings at the time of its intervention only and within the limits of Client's instructions, if any. The Company's sole responsibility is to its Client and this document does not exonerate parties to a transaction from exercising all their rights and obligations under the transaction documents. This document cannot be reproduced except in full, without prior written approval of the Company. Any unauthorized alteration, forgery or falsification of the content or appearance of this document is unlawful and offenders may be prosecuted to the fullest extent of the law. Unless otherwise stated the results shown in this test report refer only to the sample(s) tested and such sample(s) are retained for 30 days only.  
Attention: To check the authenticity of testing /inspection report & certificate, please contact us at telephone: (86-755) 8307 1443, or email: CN.Doccheck@sgs.com

No.1 Workshop, M-10, Middle Section, Science & Technology Park, Nanshan District, Shenzhen, Guangdong, China 518057 t (86-755) 26012053 www.sgs.com.cn  
中国·广东·深圳市南山区科技园中区M-10栋1号厂房 邮编: 518057 t (86-755) 26012053 sgs.china@sgs.com



# SGS-CSTC Standards Technical Services Co., Ltd. Shenzhen Branch

Report No.: SZCR240200055101  
Rev.: 01  
Page: 8 of 53

## 2.4 LTE Band 7/38/41

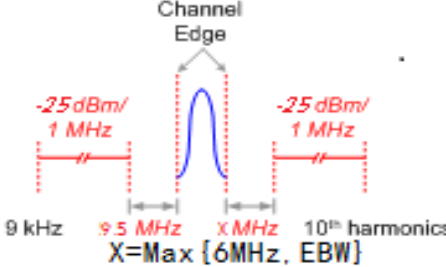
Test Item	FCC Rule No.	Requirements	Test Result	Verdict
Effective (Isotropic) Radiated Power Output Data	§2.1046, §27.50(h)(2)	EIRP ≤ 2W	Section 1 of Appendix B.4&B.13&B.14	Pass
Peak-Average Ratio	---	≤13 dB	Section 4 of Appendix B.4&B.13&B.14	Pass
Bandwidth	§2.1049	OBW: No limit. EBW: No limit.	Section 3 of Appendix B.4&B.13&B.14	Pass
Band Edges Compliance	§2.1051, §27.53(m4)	For mobile digital stations, the attenuation factor shall be not less than 40 + 10 log (P) dB on all frequencies between the channel edge and 5 megahertz from the channel edge, 43 + 10 log (P) dB on all frequencies between 5 megahertz and X megahertz from the channel edge, and 55 + 10 log (P) dB on all frequencies more than X megahertz from the channel edge, where X is the greater of 6 megahertz or the actual emission bandwidth as defined in paragraph (m)(6) of this section. In addition, the attenuation factor shall not be less than 43 + 10 log (P) dB on all frequencies between 2490.5 MHz and 2496 MHz and 55 + 10 log (P) dB at or below 2490.5 MHz.	Section 5 of Appendix B.4&B.13&B.14	Pass
Spurious Emission at Antenna Terminals	§2.1051, §27.53(m)	 <p>Channel Edge -25 dBm/1 MHz -25 dBm/1 MHz 9 kHz 9.5 MHz X MHz 10<sup>th</sup> harmonics X = Max {6MHz, EBW}</p>	Section 5 of Appendix B.4&B.13&B.14	Pass



SGS-CSTC Standards Technical Services Co., Ltd.  
Shenzhen Branch

Unless otherwise agreed in writing, this document is issued by the Company subject to its General Conditions of Service printed overleaf, available on request or accessible at <https://www.sgs.com/en/Terms-and-Conditions>. Attention is drawn to the limitation of liability, indemnification and jurisdiction issues defined therein. Any holder of this document is advised that information contained hereon reflects the Company's findings at the time of its intervention only and within the limits of Client's instructions, if any. The Company's sole responsibility is to its Client and this document does not exonerate parties to a transaction from exercising all their rights and obligations under the transaction documents. This document cannot be reproduced except in full, without prior written approval of the Company. Any unauthorized alteration, forgery or falsification of the content or appearance of this document is unlawful and offenders may be prosecuted to the fullest extent of the law. Unless otherwise stated the results shown in this test report refer only to the sample(s) tested and such sample(s) are retained for 30 days only.  
Attention: To check the authenticity of testing /inspection report & certificate, please contact us at telephone: (86-755) 8307 1443, or email: CN.Doccheck@sgs.com

No.1 Workshop, M-10, Middle Section, Science & Technology Park, Nanshan District, Shenzhen, Guangdong, China 518057 t (86-755) 26012053 www.sgs.com.cn  
中国·广东·深圳市南山区科技园中区M-10栋1号厂房 邮编: 518057 t (86-755) 26012053 sgs.china@sgs.com





# SGS-CSTC Standards Technical Services Co., Ltd. Shenzhen Branch

Report No.: SZCR240200055101  
Rev.: 01  
Page: 9 of 53

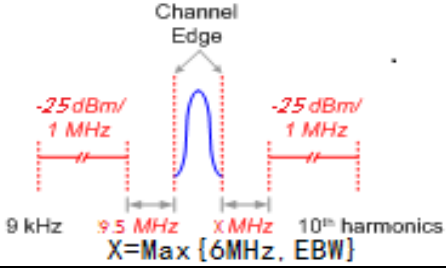
Field Strength of Spurious Radiation	§2.1053, §27.53(m)		Section 6 of Appendix B.4&B.13&B.14	Pass
Frequency Stability	§2.1055(a)(1)(b) §2.1055(d)(1)§27.54	Within authorized bands of operation/frequency block.	Section 2 of Appendix B.4&B.13&B.14	Pass



SGS-CSTC Standards Technical Services Co., Ltd.  
Shenzhen Branch, Inspection & Testing Services  
Shenzhen Branch, Wireless Laboratory

Unless otherwise agreed in writing, this document is issued by the Company subject to its General Conditions of Service printed overleaf, available on request or accessible at <https://www.sgs.com/en/Terms-and-Conditions>. Attention is drawn to the limitation of liability, indemnification and jurisdiction issues defined therein. Any holder of this document is advised that information contained hereon reflects the Company's findings at the time of its intervention only and within the limits of Client's instructions, if any. The Company's sole responsibility is to its Client and this document does not exonerate parties to a transaction from exercising all their rights and obligations under the transaction documents. This document cannot be reproduced except in full, without prior written approval of the Company. Any unauthorized alteration, forgery or falsification of the content or appearance of this document is unlawful and offenders may be prosecuted to the fullest extent of the law. Unless otherwise stated the results shown in this test report refer only to the sample(s) tested and such sample(s) are retained for 30 days only.

Attention: To check the authenticity of testing /inspection report & certificate, please contact us at telephone: (86-755) 8307 1443, or email: CN.Doccheck@sgs.com

No.1 Workshop, M-10, Middle Section, Science & Technology Park, Nanshan District, Shenzhen, Guangdong, China 518057 t (86-755) 26012053 www.sgs.com.cn  
中国·广东·深圳市南山区科技园中区M-10栋1号厂房 邮编: 518057 t (86-755) 26012053 sgs.china@sgs.com



# SGS-CSTC Standards Technical Services Co., Ltd. Shenzhen Branch

Report No.: SZCR240200055101  
Rev.: 01  
Page: 10 of 53

## 2.5 LTE Band 12/17

Test Item	FCC Rule No.	Requirements	Test Result	Verdict
Effective (Isotropic) Radiated Power Output Data	§2.1046 §27.50(c)(10)	ERP ≤ 3 W.	Section 1 of Appendix B.5&B.8	Pass
Peak-Average Ratio	---	Limit≤13 dB	Section 4 of Appendix B.5&B.8	Pass
Bandwidth	§2.1049	OBW: No limit. EBW: No limit.	Section 3 of Appendix B.5&B.8	Pass
Band Edges Compliance	§2.1051, §27.53(g)	≤ -13 dBm/1%*EBW, in 1 MHz bands immediately outside and adjacent to the frequency block.	Section 5 of Appendix B.5&B.8	Pass
Spurious Emission at Antenna Terminals	§2.1051, §27.53(g)	FCC: ≤ -13 dBm/100 kHz, from 9 kHz to 10 <sup>th</sup> harmonics but outside authorized operating frequency ranges.	Section 5 of Appendix B.5&B.8	Pass
Field Strength of Spurious Radiation	§2.1053, §27.53(g)	FCC: ≤ -13 dBm/100 kHz.	Section 6 of Appendix B.5&B.8	Pass
Frequency Stability	§2.1055(a)(1)(b) §2.1055(d)(1)§27.54	Within authorized bands of operation/frequency block.	Section 2 of Appendix B.5&B.8	Pass



Unless otherwise agreed in writing, this document is issued by the Company subject to its General Conditions of Service printed overleaf, available on request or accessible at <https://www.sgs.com/en/Terms-and-Conditions>. Attention is drawn to the limitation of liability, indemnification and jurisdiction issues defined therein. Any holder of this document is advised that information contained hereon reflects the Company's findings at the time of its intervention only and within the limits of Client's instructions, if any. The Company's sole responsibility is to its Client and this document does not exonerate parties to a transaction from exercising all their rights and obligations under the transaction documents. This document cannot be reproduced except in full, without prior written approval of the Company. Any unauthorized alteration, forgery or falsification of the content or appearance of this document is unlawful and offenders may be prosecuted to the fullest extent of the law. Unless otherwise stated the results shown in this test report refer only to the sample(s) tested and such sample(s) are retained for 30 days only.  
Attention: To check the authenticity of testing /inspection report & certificate, please contact us at telephone: (86-755) 8307 1443, or email: CN.Doccheck@sgs.com

SGS-CSTC Standards Technical Services Co., Ltd.  
Shenzhen Branch Inspection & Testing Services  
Shenzhen Branch Wireless Laboratory

No.1 Workshop, M-10, Middle Section, Science & Technology Park, Nanshan District, Shenzhen, Guangdong, China 518057 t (86-755) 26012053 www.sgs.com.cn  
中国·广东·深圳市南山区科技园中区M-10栋1号厂房 邮编: 518057 t (86-755) 26012053 sgs.china@sgs.com



# SGS-CSTC Standards Technical Services Co., Ltd. Shenzhen Branch

Report No.: SZCR240200055101  
Rev.: 01  
Page: 11 of 53

## 2.6 LTE Band 13

Test Item	FCC Rule No.	Requirements	Test Result	Verdict
Effective (Isotropic) Radiated Power Output Data	§2.1046, §27.50(b)(10)	ERP ≤ 3 W.	Section 1 of Appendix B.6	Pass
Peak-Average Ratio	---	Limits ≤ 13 dB	Section 4 of Appendix B.6	Pass
Bandwidth	§2.1049,	OBW: No limit. EBW: No limit.	Section 3 of Appendix B.6	Pass
Band Edges Compliance	§2.1051, §27.53(c)	≤ -13 dBm/1%*EBW, in 1 MHz bands immediately outside and adjacent to the frequency block.	Section 5 of Appendix B.6	Pass
Spurious Emission at Antenna Terminals	§2.1051, §27.53(c) §27.53(f)	≤ -13 dBm/100 kHz, from 9 kHz to 10 <sup>th</sup> harmonics but outside authorized operating frequency ranges. On all frequencies between 763–775 MHz and 793–805 MHz, by a factor not less than 65 + 10 log (P) dB in a 6.25 kHz band segment, for mobile and portable stations. For operations in the 746-758 MHz, 775-788 MHz, and 805-806 MHz bands, emissions in the band 1559-1610 MHz shall be limited to -70 dBW/MHz equivalent isotropically radiated power (EIRP) for wideband signals, and -80 dBW EIRP for discrete emissions of less than 700 Hz bandwidth.	Section 5 of Appendix B.6	Pass
Field Strength of Spurious Radiation	§2.1053, §27.53(c) §27.53(f)	FCC: ≤ -13 dBm/100 kHz. For operations in the 746-758 MHz, 775-788 MHz, and 805-806 MHz bands, emissions in the band 1559-1610 MHz shall be limited to -70 dBW/MHz equivalent isotropically radiated power (EIRP) for wideband signals, and -80 dBW EIRP for discrete emissions of less than 700 Hz bandwidth.	Section 6 of Appendix B.6	Pass
Frequency Stability	§2.1055(a)(1)(b) §2.1055(d)(1) §27.54	Within authorized bands of operation/frequency block.	Section 2 of Appendix B.6	Pass



SGS-CSTC Standards Technical Services Co., Ltd.  
Shenzhen Branch, Inspection & Testing Services

Unless otherwise agreed in writing, this document is issued by the Company subject to its General Conditions of Service printed overleaf, available on request or accessible at <https://www.sgs.com/en/Terms-and-Conditions>. Attention is drawn to the limitation of liability, indemnification and jurisdiction issues defined therein. Any holder of this document is advised that information contained hereon reflects the Company's findings at the time of its intervention only and within the limits of Client's instructions, if any. The Company's sole responsibility is to its Client and this document does not exonerate parties to a transaction from exercising all their rights and obligations under the transaction documents. This document cannot be reproduced except in full, without prior written approval of the Company. Any unauthorized alteration, forgery or falsification of the content or appearance of this document is unlawful and offenders may be prosecuted to the fullest extent of the law. Unless otherwise stated the results shown in this test report refer only to the sample(s) tested and such sample(s) are retained for 30 days only.  
Attention: To check the authenticity of testing /inspection report & certificate, please contact us at telephone: (86-755) 8307 1443, or email: CN.Doccheck@sgs.com

No.1 Workshop, M-10, Middle Section, Science & Technology Park, Nanshan District, Shenzhen, Guangdong, China 518057 t (86-755) 26012053 www.sgs.com.cn  
中国·广东·深圳市南山区科技园中区M-10栋1号厂房 邮编: 518057 t (86-755) 26012053 sgs.china@sgs.com



# SGS-CSTC Standards Technical Services Co., Ltd. Shenzhen Branch

Report No.: SZCR240200055101  
Rev.: 01  
Page: 12 of 53

## 2.7 LTE Band 14

Test Item	FCC Rule No.	Requirements	Test Result	Verdict
Effective (Isotropic) Radiated Power Output Data	§2.1046 §90.542(a)	ERP ≤ 3 W.	Section 1 of Appendix B.7	Pass
Peak-Average Ratio	---	Limit≤13 dB	Section 4 of Appendix B.7	Pass
Bandwidth	§2.1049	OBW: No limit. EBW: No limit.	Section 3 of Appendix B.7	Pass
Emission Mask	§2.1051 §90.210(b)	Transmitters designed for operation under this part on frequencies other than listed in this section must meet the emission mask requirements of Emission Mask B. Equipment operating under this part on frequencies allocated to but shared with the Federal Government, must meet the applicable Federal Government technical standards (b) Emission Mask B. For transmitters that are equipped with an audio low-pass filter, the power of any emission must be attenuated below the unmodulated carrier power (P) as follows: (1) On any frequency removed from the assigned frequency by more than 50 percent, but not more than 100 percent of the authorized bandwidth: At least 25 dB.(2) On any frequency removed from the assigned frequency by more than 100 percent, but not more than 250 percent of the authorized bandwidth: At least 35 dB..(3) On any frequency removed from the assigned frequency by more than 250 percent of the authorized bandwidth: At least 43 + 10 log (P) dB.	Section 5 of Appendix B.7	Pass
Band Edges Compliance	§2.1051 §90.543(e)(2)(3)	(1) On all frequencies between 769-775 MHz and 799-805 MHz, by a factor not less than 76 + 10 log (P) dB in a 6.25 kHz band segment, for	Section 5 of Appendix B.7	Pass



SGS-CSTC Standards Technical Services Co., Ltd.  
Shenzhen Branch  
Shenzhen Branch Wireless Laboratory

Unless otherwise agreed in writing, this document is issued by the Company subject to its General Conditions of Service printed overleaf, available on request or accessible at <https://www.sgs.com/en/Terms-and-Conditions>. Attention is drawn to the limitation of liability, indemnification and jurisdiction issues defined therein. Any holder of this document is advised that information contained hereon reflects the Company's findings at the time of its intervention only and within the limits of Client's instructions, if any. The Company's sole responsibility is to its Client and this document does not exonerate parties to a transaction from exercising all their rights and obligations under the transaction documents. This document cannot be reproduced except in full, without prior written approval of the Company. Any unauthorized alteration, forgery or falsification of the content or appearance of this document is unlawful and offenders may be prosecuted to the fullest extent of the law. Unless otherwise stated the results shown in this test report refer only to the sample(s) tested and such sample(s) are retained for 30 days only.  
**Attention: To check the authenticity of testing /inspection report & certificate, please contact us at telephone: (86-755) 8307 1443, or email: CN.Doccheck@sgs.com**

No.1 Workshop, M-10, Middle Section, Science & Technology Park, Nanshan District, Shenzhen, Guangdong, China 518057 t (86-755) 26012053 www.sgs.com.cn  
中国·广东·深圳市南山区科技园中区M-10栋1号厂房 邮编: 518057 t (86-755) 26012053 sgs.china@sgs.com





# SGS-CSTC Standards Technical Services Co., Ltd. Shenzhen Branch

Report No.: SZCR240200055101  
Rev.: 01  
Page: 13 of 53

		base and fixed stations.(2) On all frequencies between 769-775 MHz and 799-805 MHz, by a factor not less than $65 + 10 \log (P)$ dB in a 6.25 kHz band segment, for mobile and portable stations.(3) On any frequency between 775-788 MHz, above 805 MHz, and below 758 MHz, by at least $43 + 10 \log (P)$ dB.		
Spurious Emission at Antenna Terminals	§2.1051, §90.543(c) §90.543(f)	FCC: $\leq -13$ dBm/100 kHz, from 9 kHz to 10th harmonics but outside authorized operating frequency ranges. For operations in the 758–775 MHz and 788–805 MHz bands, all emissions including harmonics in the band 1559–1610 MHz shall be limited to -70 dBW/ MHz equivalent isotropically radiated power (EIRP) for wideband signals, and -80 dBW EIRP for discrete emissions of less than 700 Hz bandwidth.	Section 5 of Appendix B.7	Pass
Field Strength of Spurious Radiation	§2.1053, §90.543(c) §90.543(f)	FCC: $\leq -13$ dBm/100 kHz. For operations in the 758–775 MHz and 788–805 MHz bands, all emissions including harmonics in the band 1559–1610 MHz shall be limited to -70 dBW/ MHz equivalent isotropically radiated power (EIRP) for wideband signals, and -80 dBW EIRP for discrete emissions of less than 700 Hz bandwidth.	Section 7 of Appendix B.7	Pass
Frequency Stability	§2.1055(a)(1)(b) §2.1055(d)(1)§90.213	Within authorized bands of operation/frequency block.	Section 2 of Appendix B.7	Pass



SGS-CSTC Standards Technical Services Co., Ltd.  
Shenzhen Branch Inspection & Testing Services  
Shenzhen Branch Wireless Laboratory

Unless otherwise agreed in writing, this document is issued by the Company subject to its General Conditions of Service printed overleaf, available on request or accessible at <https://www.sgs.com/en/Terms-and-Conditions>. Attention is drawn to the limitation of liability, indemnification and jurisdiction issues defined therein. Any holder of this document is advised that information contained hereon reflects the Company's findings at the time of its intervention only and within the limits of Client's instructions, if any. The Company's sole responsibility is to its Client and this document does not exonerate parties to a transaction from exercising all their rights and obligations under the transaction documents. This document cannot be reproduced except in full, without prior written approval of the Company. Any unauthorized alteration, forgery or falsification of the content or appearance of this document is unlawful and offenders may be prosecuted to the fullest extent of the law. Unless otherwise stated the results shown in this test report refer only to the sample(s) tested and such sample(s) are retained for 30 days only.  
**Attention: To check the authenticity of testing /inspection report & certificate, please contact us at telephone: (86-755) 8307 1443, or email: CN.Doccheck@sgs.com**

No.1 Workshop, M-10, Middle Section, Science & Technology Park, Nanshan District, Shenzhen, Guangdong, China 518057 t (86-755) 26012053 www.sgs.com.cn  
中国·广东·深圳市南山区科技园中区M-10栋1号厂房 邮编: 518057 t (86-755) 26012053 sgs.china@sgs.com





# SGS-CSTC Standards Technical Services Co., Ltd. Shenzhen Branch

Report No.: SZCR240200055101  
Rev.: 01  
Page: 14 of 53

## 2.8 LTE Band 26(814~824 MHz)/26(814~849 MHz)

Test Item	FCC Rule No.	Requirements	Test Result	Verdict
Transmitter Conducted Power Output	§2.1046, §90.635(b)	< 100 W.	Section 1 of Appendix B.10	Pass
Peak-Average Ratio	---	Limit≤13 dB	Section 4 of Appendix B.10	Pass
Bandwidth	§2.1049	OBW: No limit. EBW: No limit.	Section 3 of Appendix B.10	Pass
Emission Mask	§2.1051 § 90.691(a)	For any frequency removed from the EA licensee's frequency block by up to and including 37.5 kHz, the power of any emission shall be attenuated below the transmitter power (P) in watts by at least 116 Log <sub>10</sub> (f/6.1) decibels or 50+10Log <sub>10</sub> (P) decibels or 80 decibels, whichever is the lesser attenuation, where f is the frequency removed from the center of the outer channel in the block in kilohertz and where f is greater than 12.5 kHz.	Section 5 of Appendix B.10	Pass
Spurious Emission at Antenna Terminals	§2.1051, §90.691	< 43 + 10Log <sub>10</sub> (P[Watts]) for all out-of-band emissions	Section 5 of Appendix B.10	Pass
Field Strength of Spurious Radiation	§2.1053, §90.691	< 43 + 10Log <sub>10</sub> (P[Watts]) for all out-of-band emissions	Section 6 of Appendix B.10	Pass
Frequency Stability	§2.1055(a)(1)(b) §2.1055(d)(1)§90.213	Within authorized bands of operation/frequency block.	Section 2 of Appendix B.10	Pass



SGS-CSTC Standards Technical Services Co., Ltd.  
Shenzhen Branch Inspection & Testing Laboratory

Unless otherwise agreed in writing, this document is issued by the Company subject to its General Conditions of Service printed overleaf, available on request or accessible at <https://www.sgs.com/en/Terms-and-Conditions>. Attention is drawn to the limitation of liability, indemnification and jurisdiction issues defined therein. Any holder of this document is advised that information contained hereon reflects the Company's findings at the time of its intervention only and within the limits of Client's instructions, if any. The Company's sole responsibility is to its Client and this document does not exonerate parties to a transaction from exercising all their rights and obligations under the transaction documents. This document cannot be reproduced except in full, without prior written approval of the Company. Any unauthorized alteration, forgery or falsification of the content or appearance of this document is unlawful and offenders may be prosecuted to the fullest extent of the law. Unless otherwise stated the results shown in this test report refer only to the sample(s) tested and such sample(s) are retained for 30 days only.  
Attention: To check the authenticity of testing /inspection report & certificate, please contact us at telephone: (86-755) 8307 1443, or email: CN.Doccheck@sgs.com

No.1 Workshop, M-10, Middle Section, Science & Technology Park, Nanshan District, Shenzhen, Guangdong, China 518057 t (86-755) 26012053 www.sgsgroup.com.cn  
中国·广东·深圳市南山区科技园中区M-10栋1号厂房 邮编: 518057 t (86-755) 26012053 sgs.china@sgs.com



# SGS-CSTC Standards Technical Services Co., Ltd. Shenzhen Branch

Report No.: SZCR240200055101  
Rev.: 01  
Page: 15 of 53

## 2.9 LTE Band 30

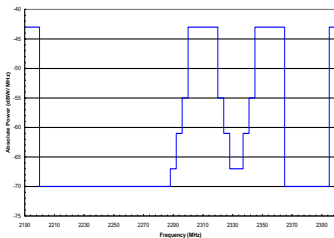
Test Item	FCC Rule No.	Requirements	Test Result	Verdict
Effective (Isotropic) Radiated Power Output Data	§2.1046, §27.50(a)(3)	EIRP ≤ 50mW/1MHz EIRP ≤ 250mW/5MHz	Section 1 of Appendix B.12	Pass
Peak-Average Ratio	---	FCC: Limit≤13 dB	Section 4 of Appendix B.12	Pass
Bandwidth	§2.1049,	OBW: No limit. EBW: No limit.	Section 3 of Appendix B.12	Pass
Band Edges Compliance	§2.1051, §27.53(a)(4)	≤ -13 dBm/1%*EBW, in 1 MHz bands immediately outside and adjacent to the frequency block.	Section 5 of Appendix B.12	Pass
Spurious Emission at Antenna Terminals	§2.1051, §27.53(a)(4)	<p>Figure 1: Unwanted Emissions for Mobile, Portable, and Low Power Fixed Subscriber Equipment</p>  <p>For mobile and portable stations operating in the 2305-2315 MHz and 2350-2360 MHz bands:</p> <p>(i) By a factor of not less than: 43 + 10 log (P) dB on all frequencies between 2305 and 2320 MHz and on all frequencies between 2345 and 2360 MHz that are outside the licensed band(s) of operation, not less than 55 + 10 log (P) dB on all frequencies between 2320 and 2324 MHz and on all frequencies between 2341 and 2345 MHz, not less than 61 + 10 log (P) dB on all frequencies between 2324 and 2328 MHz and on all frequencies between 2337 and 2341 MHz, and not less than 67 + 10 log (P) dB on all frequencies between 2328 and 2337 MHz;</p> <p>(ii) By a factor of not less than 43 + 10 log (P) dB on all frequencies between 2300 and 2305 MHz, 55</p>	Section 5 of Appendix B.12	Pass



Unless otherwise agreed in writing, this document is issued by the Company subject to its General Conditions of Service printed overleaf, available on request or accessible at <https://www.sgs.com/en/Terms-and-Conditions>. Attention is drawn to the limitation of liability, indemnification and jurisdiction issues defined therein. Any holder of this document is advised that information contained hereon reflects the Company's findings at the time of its intervention only and within the limits of Client's instructions, if any. The Company's sole responsibility is to its Client and this document does not exonerate parties to a transaction from exercising all their rights and obligations under the transaction documents. This document cannot be reproduced except in full, without prior written approval of the Company. Any unauthorized alteration, forgery or falsification of the content or appearance of this document is unlawful and offenders may be prosecuted to the fullest extent of the law. Unless otherwise stated the results shown in this test report refer only to the sample(s) tested and such sample(s) are retained for 30 days only.

Attention: To check the authenticity of testing /inspection report & certificate, please contact us at telephone: (86-755) 8307 1443, or email: CN.Doccheck@sgs.com

No.1 Workshop, M-10, Middle Section, Science & Technology Park, Nanshan District, Shenzhen, Guangdong, China 518057 t (86-755) 26012053 www.sgs.com.cn  
中国·广东·深圳市南山区科技园中区M-10栋1号厂房 邮编: 518057 t (86-755) 26012053 sgs.china@sgs.com



# SGS-CSTC Standards Technical Services Co., Ltd. Shenzhen Branch

Report No.: SZCR240200055101  
Rev.: 01  
Page: 16 of 53

		+ 10 log (P) dB on all frequencies between 2296 and 2300 MHz, 61 + 10 log (P) dB on all frequencies between 2292 and 2296 MHz, 67 + 10 log (P) dB on all frequencies between 2288 and 2292 MHz, and 70 + 10 log (P) dB below 2288 MHz;(iii) By a factor of not less than 43 + 10 log (P) dB on all frequencies between 2360 and 2365 MHz, and not less than 70 + 10 log (P) dB above 2365 MHz.		
Field Strength of Spurious Radiation	§2.1053, §27.53(a)(4)	≤ -40dBm/MHz.	Section 6 of Appendix B.12	Pass
Frequency Stability	§2.1055(a)(1)(b) §2.1055(d)(1)§27.54	within the range of the operating frequency blocks	Section 2 of Appendix B.12	Pass



SGS-CSTC Standards Technical Services Co., Ltd.  
Shenzhen Branch  
Inspection & Testing Services  
Wireless Laboratory

Unless otherwise agreed in writing, this document is issued by the Company subject to its General Conditions of Service printed overleaf, available on request or accessible at <https://www.sgs.com/en/Terms-and-Conditions>. Attention is drawn to the limitation of liability, indemnification and jurisdiction issues defined therein. Any holder of this document is advised that information contained hereon reflects the Company's findings at the time of its intervention only and within the limits of Client's instructions, if any. The Company's sole responsibility is to its Client and this document does not exonerate parties to a transaction from exercising all their rights and obligations under the transaction documents. This document cannot be reproduced except in full, without prior written approval of the Company. Any unauthorized alteration, forgery or falsification of the content or appearance of this document is unlawful and offenders may be prosecuted to the fullest extent of the law. Unless otherwise stated the results shown in this test report refer only to the sample(s) tested and such sample(s) are retained for 30 days only.  
**Attention: To check the authenticity of testing /inspection report & certificate, please contact us at telephone: (86-755) 8307 1443, or email: CN.Doccheck@sgs.com**

No.1 Workshop, M-10, Middle Section, Science & Technology Park, Nanshan District, Shenzhen, Guangdong, China 518057 t (86-755) 26012053 www.sgs.com.cn  
中国·广东·深圳市南山区科技园中区M-10栋1号厂房 邮编: 518057 t (86-755) 26012053 sgs.china@sgs.com



# SGS-CSTC Standards Technical Services Co., Ltd. Shenzhen Branch

Report No.: SZCR240200055101  
Rev.: 01  
Page: 17 of 53

## 2.10 LTE Band 42

Test Item	FCC Rule No.	Requirements	Test Result	Verdict
Effective (Isotropic) Radiated Power Output Data	§2.1046, §27.50(k)(3)	EIRP ≤ 30dBm	Section 1 of Appendix B.15	Pass
Peak-Average Ratio	§27.50(k)(4)	Limit≤13 dB	Section 4 of Appendix B.15	Pass
Bandwidth	§2.1049	OBW: No limit. EBW: No limit.	Section 3 of Appendix B.15	Pass
Band Edges Compliance	§2.1051, §27.53(n)(2)	For mobile operations in the 3450-3550 MHz band, the conducted power of any emission outside the licensee's authorized bandwidth shall not exceed -13 dBm/MHz.	Section 5 of Appendix B.15	Pass
Spurious Emission at Antenna Terminals	§2.1051, §27.53(n)(2)	For mobile operations in the 3450-3550 MHz band, the conducted power of any emission outside the licensee's authorized bandwidth shall not exceed -13 dBm/MHz.	Section 5 of Appendix B.15	Pass
Field Strength of Spurious Radiation	§2.1053, §27.53(n)(2)	For mobile operations in the 3450-3550 MHz band, the conducted power of any emission outside the licensee's authorized bandwidth shall not exceed -13 dBm/MHz.	Section 7 of Appendix B.15	Pass
Frequency Stability	§2.1055(a)(1)(b) §2.1055(d)(1)§27.54	Within authorized bands of operation/ frequency block.	Section 2 of Appendix B.15	Pass



SGS-CSTC Standards Technical Services Co., Ltd.  
Shenzhen Branch Inspection & Testing Services  
Shenzhen Branch Wireless Laboratory

Unless otherwise agreed in writing, this document is issued by the Company subject to its General Conditions of Service printed overleaf, available on request or accessible at <https://www.sgs.com/en/Terms-and-Conditions>. Attention is drawn to the limitation of liability, indemnification and jurisdiction issues defined therein. Any holder of this document is advised that information contained hereon reflects the Company's findings at the time of its intervention only and within the limits of Client's instructions, if any. The Company's sole responsibility is to its Client and this document does not exonerate parties to a transaction from exercising all their rights and obligations under the transaction documents. This document cannot be reproduced except in full, without prior written approval of the Company. Any unauthorized alteration, forgery or falsification of the content or appearance of this document is unlawful and offenders may be prosecuted to the fullest extent of the law. Unless otherwise stated the results shown in this test report refer only to the sample(s) tested and such sample(s) are retained for 30 days only.  
**Attention: To check the authenticity of testing /inspection report & certificate, please contact us at telephone: (86-755) 8307 1443, or email: CN.Doccheck@sgs.com**

No.1 Workshop, M-10, Middle Section, Science & Technology Park, Nanshan District, Shenzhen, Guangdong, China 518057 t (86-755) 26012053 www.sgs.com.cn  
中国·广东·深圳市南山区科技园中区M-10栋1号厂房 邮编: 518057 t (86-755) 26012053 sgs.china@sgs.com





# SGS-CSTC Standards Technical Services Co., Ltd. Shenzhen Branch

Report No.: SZCR240200055101  
Rev.: 01  
Page: 18 of 53

## 2.11 LTE Band 43

Test Item	FCC Rule No.	Requirements	Test Result	Verdict
Effective (Isotropic) Radiated Power Output Data	§2.1046, §27.50(j)(3)	EIRP ≤ 1W	Section 1 of Appendix B.16	Pass
Peak-Average Ratio	§27.50(j)(4)	≤13 dB	Section 4 of Appendix B.16	Pass
Bandwidth	§2.1049	OBW: No limit. EBW: No limit.	Section 3 of Appendix B.16	Pass
Band Edges Compliance	§2.1051, §27.53(l)(2)	(2) For mobile operations in the 3700-3980 MHz band, the conducted power of any emission outside the licensee's authorized bandwidth shall not exceed -13 dBm/MHz. Compliance with this paragraph (l)(2) is based on the use of measurement instrumentation employing a resolution bandwidth of 1 megahertz or greater. However, in the 1 megahertz bands immediately outside and adjacent to the licensee's frequency block, the minimum resolution bandwidth for the measurement shall be either one percent of the emission bandwidth of the fundamental emission of the transmitter or 350 kHz. In the bands between 1 and 5 MHz removed from the licensee's frequency block, the minimum resolution bandwidth for the measurement shall be 500 kHz.	Section 5 of Appendix B.16	Pass
Spurious Emission at Antenna Terminals	§2.1051, §27.53(l)(2)	not exceed -13 dBm/MHz.	Section 5 of Appendix B.16	Pass
Field Strength of Spurious Radiation	§2.1053, §27.53(l)(2)	not exceed -13 dBm/MHz	Section 7 of Appendix B.16	Pass
Frequency Stability	§2.1055(a)(1)(b) §2.1055(d)(1)§27.54	Within authorized bands of operation/frequency block.	Section 2 of Appendix B.16	Pass



SGS-CSTC Standards Technical Services Co., Ltd.  
Shenzhen Branch  
Wireless Laboratory

Unless otherwise agreed in writing, this document is issued by the Company subject to its General Conditions of Service printed overleaf, available on request or accessible at <https://www.sgs.com/en/Terms-and-Conditions>. Attention is drawn to the limitation of liability, indemnification and jurisdiction issues defined therein. Any holder of this document is advised that information contained hereon reflects the Company's findings at the time of its intervention only and within the limits of Client's instructions, if any. The Company's sole responsibility is to its Client and this document does not exonerate parties to a transaction from exercising all their rights and obligations under the transaction documents. This document cannot be reproduced except in full, without prior written approval of the Company. Any unauthorized alteration, forgery or falsification of the content or appearance of this document is unlawful and offenders may be prosecuted to the fullest extent of the law. Unless otherwise stated the results shown in this test report refer only to the sample(s) tested and such sample(s) are retained for 30 days only.  
**Attention: To check the authenticity of testing /inspection report & certificate, please contact us at telephone: (86-755) 8307 1443, or email: CN.Doccheck@sgs.com**

No.1 Workshop, M-10, Middle Section, Science & Technology Park, Nanshan District, Shenzhen, Guangdong, China 518057 t (86-755) 26012053 www.sgs.com.cn  
中国·广东·深圳市南山区科技园中区M-10栋1号厂房 邮编: 518057 t (86-755) 26012053 sgs.china@sgs.com





# SGS-CSTC Standards Technical Services Co., Ltd. Shenzhen Branch

Report No.: SZCR240200055101  
Rev.: 01  
Page: 19 of 53

## 2.12 LTE Band 71

Test Item	FCC Rule No.	Requirements	Test Result	Verdict
Effective (Isotropic) Radiated Power Output Data	§2.1046 §27.50(c)(10)	ERP ≤ 3 W	Section 1 of Appendix B.19	Pass
Peak-Average Ratio	---	Limit ≤ 13 dB	Section 4 of Appendix B.19	Pass
Bandwidth	§2.1049	OBW: No limit. EBW: No limit.	Section 3 of Appendix B.19	Pass
Band Edges Compliance	§2.1051, §27.53(g)	≤ -13 dBm/1%*EBW, in 1 MHz bands immediately outside and adjacent to the frequency block.	Section 5 of Appendix B.19	Pass
Spurious Emission at Antenna Terminals	§2.1051, §27.53(g)	≤ -13 dBm/1 MHz, from 9 kHz to 10 <sup>th</sup> harmonics but outside authorized operating frequency ranges.	Section 5 of Appendix B.19	Pass
Field Strength of Spurious Radiation	§2.1053, §27.53(g)	≤ -13 dBm/1 MHz.	Section 6 of Appendix B.19	Pass
Frequency Stability	§2.1055(a)(1)(b) §2.1055(d)(1)§27.54	within the authorized bands of operation.	Section 2 of Appendix B.19	Pass



SGS-CSTC Standards Technical Services Co., Ltd.  
Shenzhen Branch Inspection & Testing Services  
Shenzhen Branch Wireless Laboratory

Unless otherwise agreed in writing, this document is issued by the Company subject to its General Conditions of Service printed overleaf, available on request or accessible at <https://www.sgs.com/en/Terms-and-Conditions>. Attention is drawn to the limitation of liability, indemnification and jurisdiction issues defined therein. Any holder of this document is advised that information contained hereon reflects the Company's findings at the time of its intervention only and within the limits of Client's instructions, if any. The Company's sole responsibility is to its Client and this document does not exonerate parties to a transaction from exercising all their rights and obligations under the transaction documents. This document cannot be reproduced except in full, without prior written approval of the Company. Any unauthorized alteration, forgery or falsification of the content or appearance of this document is unlawful and offenders may be prosecuted to the fullest extent of the law. Unless otherwise stated the results shown in this test report refer only to the sample(s) tested and such sample(s) are retained for 30 days only.  
**Attention: To check the authenticity of testing /inspection report & certificate, please contact us at telephone: (86-755) 8307 1443, or email: CN.Doccheck@sgs.com**

No.1 Workshop, M-10, Middle Section, Science & Technology Park, Nanshan District, Shenzhen, Guangdong, China 518057 t (86-755) 26012053 www.sgsgroup.com.cn  
中国·广东·深圳市南山区科技园中区M-10栋1号厂房 邮编: 518057 t (86-755) 26012053 sgs.china@sgs.com



# SGS-CSTC Standards Technical Services Co., Ltd. Shenzhen Branch

Report No.: SZCR240200055101  
Rev.: 01  
Page: 20 of 53

## 2.13 LTE Band 42/ LTE Band 43/ LTE Band 48

Test Item	FCC Rule No.	Requirements	Test Result	Verdict
Effective (Isotropic) Radiated Power Output Data	§2.1046, §96.41	EIRP $\leq$ 23dBm/10MHz	Section 1 of Appendix B.40&B.41&B.17	Pass
Peak-Average Ratio	§96.41	FCC: Limit $\leq$ 13 dB	Section 4 of Appendix B.40&B.41&B.17	Pass
Bandwidth	§2.1049	OBW: No limit. EBW: No limit.	Section 3 of Appendix B.40&B.41&B.17	Pass
Adjacent Channel Leakage Ratio	§96.41	the Adjacent Channel Leakage Ratio for End User Devices shall be at least 30 dB.	Section 6 of Appendix B.40&B.41&B.17	Pass
Band Edges Compliance	§2.1051, §96.41	for channel and frequency assignments made by a CBSD to End User Devices, the conducted power of any End User Device emission outside the fundamental emission (whether in or outside of the authorized band) shall not exceed -13 dBm/MHz within 0 to B megahertz (where B is the bandwidth in megahertz of the assigned channel or multiple contiguous channels of the End User Device) above the upper CBSD-assigned channel edge and within 0 to B megahertz below the lower CBSD-assigned channel edge.	Section 5 of Appendix B.40&B.41&B.17	Pass
Spurious Emission at Antenna Terminals	§2.1051, §96.41	for channel and frequency assignments made by a CBSD to End User Devices, the conducted power of any End User Device emission outside the fundamental emission (whether in or outside of the authorized band) shall not exceed -13 dBm/MHz within 0 to B megahertz (where B is the bandwidth in megahertz of the assigned channel or multiple contiguous channels of the End User Device) above the upper CBSD-assigned channel edge and within 0 to B megahertz below the lower CBSD-assigned channel edge. At all frequencies greater than B megahertz above the upper CBSD assigned channel edge and less than B megahertz below the lower CBSD-	Section 5 of Appendix B.40&B.41&B.17	Pass



SGS-CSTC Standards Technical Services Co., Ltd.  
Shenzhen Branch, Wireless Laboratory

Unless otherwise agreed in writing, this document is issued by the Company subject to its General Conditions of Service printed overleaf, available on request or accessible at <https://www.sgs.com/en/Terms-and-Conditions>. Attention is drawn to the limitation of liability, indemnification and jurisdiction issues defined therein. Any holder of this document is advised that information contained hereon reflects the Company's findings at the time of its intervention only and within the limits of Client's instructions, if any. The Company's sole responsibility is to its Client and this document does not exonerate parties to a transaction from exercising all their rights and obligations under the transaction documents. This document cannot be reproduced except in full, without prior written approval of the Company. Any unauthorized alteration, forgery or falsification of the content or appearance of this document is unlawful and offenders may be prosecuted to the fullest extent of the law. Unless otherwise stated the results shown in this test report refer only to the sample(s) tested and such sample(s) are retained for 30 days only.  
**Attention: To check the authenticity of testing /inspection report & certificate, please contact us at telephone: (86-755) 8307 1443, or email: CN.Doccheck@sgs.com**

No.1 Workshop, M-10, Middle Section, Science & Technology Park, Nanshan District, Shenzhen, Guangdong, China 518057 t (86-755) 26012053 www.sgs.com.cn  
中国·广东·深圳市南山区科技园中区M-10栋1号厂房 邮编: 518057 t (86-755) 26012053 sgs.china@sgs.com



# SGS-CSTC Standards Technical Services Co., Ltd. Shenzhen Branch

Report No.: SZCR240200055101  
Rev.: 01  
Page: 21 of 53

		assigned channel edge, the conducted power of any End User Device emission shall not exceed -25 dBm/MHz. (2) Additional protection levels. Notwithstanding paragraph (e)(1) of this section, for CBSDs and End User Devices, the conducted power of emissions below 3540 MHz or above 3710 MHz shall not exceed -25 dBm/MHz, and the conducted power of emissions below 3530 MHz or above 3720 MHz shall not exceed -40dBm/MHz.		
Field Strength of Spurious Radiation	§2.1053, §96.41	for channel and frequency assignments made by a CBSD to End User Devices, the conducted power of any End User Device emission outside the fundamental emission (whether in or outside of the authorized band) shall not exceed -13 dBm/MHz within 0 to B megahertz (where B is the bandwidth in megahertz of the assigned channel or multiple contiguous channels of the End User Device) above the upper CBSD-assigned channel edge and within 0 to B megahertz below the lower CBSD-assigned channel edge. At all frequencies greater than B megahertz above the upper CBSD assigned channel edge and less than B megahertz below the lower CBSD-assigned channel edge, the conducted power of any End User Device emission shall not exceed -25 dBm/MHz. (2) Additional protection levels. Notwithstanding paragraph (e)(1) of this section, for CBSDs and End User Devices, the conducted power of emissions below 3540 MHz or above 3710 MHz shall not exceed -25 dBm/MHz, and the conducted power of emissions below 3530 MHz or above 3720 MHz shall not exceed -40dBm/MHz.	Section 7 of Appendix B.40&B.41&B.17	Pass
Frequency Stability	§2.1055, §96.41	Within authorized bands of operation/ frequency block.	Section 2 of Appendix B.40&B.41&B.17	Pass

Remark:

According to the declaration letter from client.

Packaging method:	LGA	MINIPCIE	M.2
-------------------	-----	----------	-----

LGA conducted all tests, while MINIPIE and M.2 conducted RSE tests, and the report only reflected the worst mode data.



SGS-CSTC Standards Technical Services Co., Ltd.  
Shenzhen Branch, Inspection & Testing Services  
Shenzhen Branch, Wireless Laboratory

Unless otherwise agreed in writing, this document is issued by the Company subject to its General Conditions of Service printed overleaf, available on request or accessible at <https://www.sgs.com/en/Terms-and-Conditions>. Attention is drawn to the limitation of liability, indemnification and jurisdiction issues defined therein. Any holder of this document is advised that information contained hereon reflects the Company's findings at the time of its intervention only and within the limits of Client's instructions, if any. The Company's sole responsibility is to its Client and this document does not exonerate parties to a transaction from exercising all their rights and obligations under the transaction documents. This document cannot be reproduced except in full, without prior written approval of the Company. Any unauthorized alteration, forgery or falsification of the content or appearance of this document is unlawful and offenders may be prosecuted to the fullest extent of the law. Unless otherwise stated the results shown in this test report refer only to the sample(s) tested and such sample(s) are retained for 30 days only.  
**Attention: To check the authenticity of testing /inspection report & certificate, please contact us at telephone: (86-755) 8307 1443, or email: CN.Doccheck@sgs.com**

No.1 Workshop, M-10, Middle Section, Science & Technology Park, Nanshan District, Shenzhen, Guangdong, China 518057 t (86-755) 26012053 www.sgsgroup.com.cn  
中国·广东·深圳市南山区科技园中区M-10栋1号厂房 邮编: 518057 t (86-755) 26012053 sgs.china@sgs.com



# SGS-CSTC Standards Technical Services Co., Ltd. Shenzhen Branch

Report No.: SZCR240200055101  
Rev.: 01  
Page: 22 of 53

## 3 General Information

### 3.1 Details of Client

Applicant:	Fibocom Wireless Inc
Address of Applicant:	1101, Tower A, Building 6, Shenzhen International Innovation Valley, Dashi 1st Rd, Nanshan, Shenzhen, China
Manufacturer:	Fibocom Wireless Inc
Address of Manufacturer:	1101, Tower A, Building 6, Shenzhen International Innovation Valley, Dashi 1st Rd, Nanshan, Shenzhen, China

### 3.2 Test Location

Company:	SGS-CSTC Standards Technical Services Co., Ltd. Shenzhen Branch
Address:	No. 1 Workshop, M-10, Middle section, Science & Technology Park, Nanshan District, Shenzhen, Guangdong, China
Post code:	518057
Test engineer:	Jinhua Wei, Xing Guo

### 3.3 Test Facility

The test facility is recognized, certified, or accredited by the following organizations:

- **A2LA (Certificate No. 3816.01)**

SGS-CSTC Standards Technical Services Co., Ltd. Shenzhen Branch is accredited by the American Association for Laboratory Accreditation(A2LA). Certificate No. 3816.01.

- **VCCI**

The 3m Fully-anechoic chamber for above 1GHz, 10m Semi-anechoic chamber for below 1GHz, Shielded Room for Mains Port Conducted Interference Measurement and Telecommunication Port Conducted Interference Measurement of SGS-CSTC Standards Technical Services Co., Ltd. have been registered in accordance with the Regulations for Voluntary Control Measures with Registration No.: G-20026, R-14188, C-12383 and T-11153 respectively.

- **Innovation, Science and Economic Development Canada**

SGS-CSTC Standards Technical Services Co., Ltd. Shenzhen Branch has been recognized by ISED as an accredited testing laboratory.

CAB identifier: CN0006.

IC#: 4620C.

- **FCC –Designation Number: CN1336**

SGS-CSTC Standards Technical Services Co., Ltd. Shenzhen Branch has been recognized as an accredited testing laboratory.

Designation Number: CN1336.

Test Firm Registration Number: 787754



SGS-CSTC Standards Technical Services Co., Ltd.  
Shenzhen Branch Inspection & Testing Services  
Shenzhen Branch Inspection & Testing Services

Unless otherwise agreed in writing, this document is issued by the Company subject to its General Conditions of Service printed overleaf, available on request or accessible at <https://www.sgs.com/en/Terms-and-Conditions>. Attention is drawn to the limitation of liability, indemnification and jurisdiction issues defined therein. Any holder of this document is advised that information contained hereon reflects the Company's findings at the time of its intervention only and within the limits of Client's instructions, if any. The Company's sole responsibility is to its Client and this document does not exonerate parties to a transaction from exercising all their rights and obligations under the transaction documents. This document cannot be reproduced except in full, without prior written approval of the Company. Any unauthorized alteration, forgery or falsification of the content or appearance of this document is unlawful and offenders may be prosecuted to the fullest extent of the law. Unless otherwise stated the results shown in this test report refer only to the sample(s) tested and such sample(s) are retained for 30 days only.

Attention: To check the authenticity of testing /inspection report & certificate, please contact us at telephone: (86-755) 8307 1443, or email: CN.Doccheck@sgs.com

No.1 Workshop, M-10, Middle Section, Science & Technology Park, Nanshan District, Shenzhen, Guangdong, China 518057 t (86-755) 26012053 www.sgsgroup.com.cn  
中国·广东·深圳市南山区科技园中区M-10栋1号厂房 邮编: 518057 t (86-755) 26012053 sgs.china@sgs.com





# SGS-CSTC Standards Technical Services Co., Ltd. Shenzhen Branch

Report No.: SZCR240200055101  
Rev.: 01  
Page: 23 of 53

## 3.4 General Description of EUT

EUT Description:	5G RedCap Module			
Model No.:	FG132-GL			
Trade Mark:	Fibocom			
Hardware Version:	V1.0			
Software Version:	19003.1000.00.02.01.12			
Power Supply:	DC3.8V			
IMEI:	RF Conducted	863581070002709		
	RSE	863581070005827		
Antenna Type:	<input checked="" type="checkbox"/> External, <input type="checkbox"/> Integrated			
HPUE Power Class:	Class 2: LTE Band 38; LTE Band 41; LTE Band 42; LTE Band 43;			
Antenna Gain:	LTE Band 2:	2.85dBi (Ant0)	LTE Band 4:	2.98dBi (Ant0)
	LTE Band 5:	1.32dBi (Ant0)	LTE Band 7:	2.21dBi (Ant0)
	LTE Band 12:	1.61dBi (Ant0)	LTE Band 13:	1.83dBi (Ant0)
	LTE Band 14:	2.19dBi (Ant0)	LTE Band 17:	1.61dBi (Ant0)
	LTE Band 25:	2.85dBi (Ant0)	LTE Band 26:	1.32dBi (Ant0)
	LTE Band 30:	0.22dBi (Ant0)	LTE Band 38:	1.71dBi (Ant0)
	LTE Band 41:	2.21dBi (Ant0)	LTE Band 42:	-0.13dBi (Ant0)
	LTE Band 43:	-0.13dBi (Ant0)	LTE Band 48:	-0.13dBi (Ant0)
	LTE Band 66:	2.98dBi (Ant0)	LTE Band 71:	1.61dBi (Ant0)
	Note: The antenna gain are derived from the gain information report provided by the manufacturer.			
RF Cable:	9kHz ~ 30MHz (0.3dB)	30MHz ~ 1000MHz (0.6dB)	1000MHz ~ 2000MHz (0.8dB)	
	2000MHz ~ 4000MHz (1.1dB)	4000MHz ~ 6000MHz (1.8dB)	6000MHz ~ 12750MHz (2.6dB)	
	Above 12750MHz (3.5dB)			
Remark:	As above information is provided and confirmed by the applicant. SGS is not liable to the accuracy, suitability, reliability or/and integrity of the information.			



SGS-CSTC Standards Technical Services Co., Ltd.  
Shenzhen Branch

Unless otherwise agreed in writing, this document is issued by the Company subject to its General Conditions of Service printed overleaf, available on request or accessible at <https://www.sgs.com/en/Terms-and-Conditions>. Attention is drawn to the limitation of liability, indemnification and jurisdiction issues defined therein. Any holder of this document is advised that information contained hereon reflects the Company's findings at the time of its intervention only and within the limits of Client's instructions, if any. The Company's sole responsibility is to its Client and this document does not exonerate parties to a transaction from exercising all their rights and obligations under the transaction documents. This document cannot be reproduced except in full, without prior written approval of the Company. Any unauthorized alteration, forgery or falsification of the content or appearance of this document is unlawful and offenders may be prosecuted to the fullest extent of the law. Unless otherwise stated the results shown in this test report refer only to the sample(s) tested and such sample(s) are retained for 30 days only.

Attention: To check the authenticity of testing /inspection report & certificate, please contact us at telephone: (86-755) 8307 1443, or email: CN.Doccheck@sgs.com

No.1 Workshop, M-10, Middle Section, Science & Technology Park, Nanshan District, Shenzhen, Guangdong, China 518057 t (86-755) 26012053 www.sgs.com.cn  
中国·广东·深圳市南山区科技园中区M-10栋1号厂房 邮编: 518057 t (86-755) 26012053 sgs.china@sgs.com





# SGS-CSTC Standards Technical Services Co., Ltd. Shenzhen Branch

Report No.: SZCR240200055101  
Rev.: 01  
Page: 24 of 53

## 3.5 Test Mode

Test Mode	Test Modes Description
LTE/TM1	LTE system, QPSK modulation
LTE/TM2	LTE system, 16QAM modulation
LTE/TM3	LTE system, 64QAM modulation
Remark: The test mode(s) are selected according to relevant radio technology specifications.	

## 3.6 Test Environment

Environment Parameter	101.0 kPa Selected Values During Tests	
Relative Humidity	44-60 % RH Ambient	
Value	Temperature(°C)	Voltage(V)
NTNV	22~25	3.8
LTLV	-30	3.3
LTHV	-30	4.3
HTLV	50	3.3
HTHV	50	4.3
Remark: NV: Normal Voltage                      LV: Low Extreme Test Voltage                      HV: High Extreme Test Voltage NT: Normal Temperature                      LT: Low Extreme Test Temperature                      HT: High Extreme Test Temperature		

## 3.7 Description of Support Units

Description	Manufacturer	Model No.
Mother board	Fibocom	ADP-FG132-GL-00-00_V1.0
USB cable	Ugreen	6A
Adapter	Apple	A1443
Remark: all above the information of table are provided by client.		



Unless otherwise agreed in writing, this document is issued by the Company subject to its General Conditions of Service printed overleaf, available on request or accessible at <https://www.sgs.com/en/Terms-and-Conditions>. Attention is drawn to the limitation of liability, indemnification and jurisdiction issues defined therein. Any holder of this document is advised that information contained hereon reflects the Company's findings at the time of its intervention only and within the limits of Client's instructions, if any. The Company's sole responsibility is to its Client and this document does not exonerate parties to a transaction from exercising all their rights and obligations under the transaction documents. This document cannot be reproduced except in full, without prior written approval of the Company. Any unauthorized alteration, forgery or falsification of the content or appearance of this document is unlawful and offenders may be prosecuted to the fullest extent of the law. Unless otherwise stated the results shown in this test report refer only to the sample(s) tested and such sample(s) are retained for 30 days only.  
**Attention: To check the authenticity of testing /inspection report & certificate, please contact us at telephone: (86-755) 8307 1443, or email: CN.Doccheck@sgs.com**

SGS-CSTC Standards Technical Services Co., Ltd.  
Shenzhen Branch

No.1 Workshop, M-10, Middle Section, Science & Technology Park, Nanshan District, Shenzhen, Guangdong, China 518057 t (86-755) 26012053 www.sgs.com.cn  
中国·广东·深圳市南山区科技园中区M-10栋1号厂房 邮编: 518057 t (86-755) 26012053 sgs.china@sgs.com

 Report No.: SZCR240200055101  
 Rev.: 01  
 Page: 25 of 53

### 3.8 Technical Specification

Characteristics	Description				
Radio System Type	<input checked="" type="checkbox"/> LTE				
Supported Frequency Range	Band	TX	RX		
	LTE Band 2	1850 to 1910 MHz	1930 to 1990 MHz		
	LTE Band 4	1710 to 1755 MHz	2110 to 2155 MHz		
	LTE Band 5	824 to 849 MHz	869 to 894 MHz		
	LTE Band 7	2500 to 2570 MHz	2620 to 2690 MHz		
	LTE Band 12	699 to 716 MHz	729 to 746 MHz		
	LTE Band 13	777 to 787 MHz	746 to 756 MHz		
	LTE Band 14	788 to 798 MHz	758 to 768 MHz		
	LTE Band 17	704 to 716 MHz	734 to 746 MHz		
	LTE Band 25	1850 to 1915MHz	1930 to 1995 MHz		
	LTE Band 26 (814 to 824 MHz )	814 to 824MHz	859 to 869 MHz		
	LTE Band 26 (824 to 849 MHz )	824 to 849 MHz	869 to 894 MHz		
	LTE Band 30	2305 to 2315 MHz	2350 to 2360 MHz		
	LTE Band 38	2570 to 2620 MHz	2570 to 2620 MHz		
	LTE Band 41	2496 to 2690MHz	2496 to 2690MHz		
	LTE Band 42	3450 to 3550 MHz	3450 to 3550 MHz		
	LTE Band 42_ Part96	3550 to 3600 MHz	3550 to 3600 MHz		
	LTE Band 43	3700 to 3800 MHz	3700 to 3800 MHz		
	LTE Band 43_ Part96	3600 to 3700 MHz	3600 to 3700 MHz		
	LTE Band 48	3550 to 3700 MHz	3550 to 3700 MHz		
LTE Band 66	1710 to 1780 MHz	2110 to 2200 MHz			
LTE Band 71	663 to 698 MHz	617 to 652 MHz			
Supported Channel Bandwidth	LTE Band 2	<input checked="" type="checkbox"/> 1.4 MHz	<input checked="" type="checkbox"/> 3 MHz	<input checked="" type="checkbox"/> 5 MHz	<input checked="" type="checkbox"/> 10 MHz
		<input checked="" type="checkbox"/> 15 MHz	<input checked="" type="checkbox"/> 20 MHz		
	LTE Band 4	<input checked="" type="checkbox"/> 1.4 MHz	<input checked="" type="checkbox"/> 3 MHz	<input checked="" type="checkbox"/> 5 MHz	<input checked="" type="checkbox"/> 10 MHz
		<input checked="" type="checkbox"/> 15 MHz	<input checked="" type="checkbox"/> 20 MHz		
	LTE Band 5	<input checked="" type="checkbox"/> 1.4 MHz	<input checked="" type="checkbox"/> 3 MHz	<input checked="" type="checkbox"/> 5 MHz	<input checked="" type="checkbox"/> 10 MHz



Unless otherwise agreed in writing, this document is issued by the Company subject to its General Conditions of Service printed overleaf, available on request or accessible at <https://www.sgs.com/en/Terms-and-Conditions>. Attention is drawn to the limitation of liability, indemnification and jurisdiction issues defined therein. Any holder of this document is advised that information contained hereon reflects the Company's findings at the time of its intervention only and within the limits of Client's instructions, if any. The Company's sole responsibility is to its Client and this document does not exonerate parties to a transaction from exercising all their rights and obligations under the transaction documents. This document cannot be reproduced except in full, without prior written approval of the Company. Any unauthorized alteration, forgery or falsification of the content or appearance of this document is unlawful and offenders may be prosecuted to the fullest extent of the law. Unless otherwise stated the results shown in this test report refer only to the sample(s) tested and such sample(s) are retained for 30 days only.

Attention: To check the authenticity of testing /inspection report & certificate, please contact us at telephone: (86-755) 8307 1443, or email: CN.Doccheck@sgs.com

 SGS-CSTC Standards Technical Services Co., Ltd.  
 Shenzhen Branch

 No.1 Workshop, M-10, Middle Section, Science & Technology Park, Nanshan District, Shenzhen, Guangdong, China 518057 t (86-755) 26012053 www.sgs.com.cn  
 中国·广东·深圳市南山区科技园中区M-10栋1号厂房 邮编: 518057 t (86-755) 26012053 sgs.china@sgs.com



# SGS-CSTC Standards Technical Services Co., Ltd. Shenzhen Branch

Report No.: SZCR240200055101  
Rev.: 01  
Page: 26 of 53

LTE Band 7	<input checked="" type="checkbox"/> 5 MHz	<input checked="" type="checkbox"/> 10 MHz	<input checked="" type="checkbox"/> 15 MHz	<input checked="" type="checkbox"/> 20 MHz
LTE Band 12	<input checked="" type="checkbox"/> 1.4 MHz	<input checked="" type="checkbox"/> 3 MHz	<input checked="" type="checkbox"/> 5 MHz	<input checked="" type="checkbox"/> 10 MHz
LTE Band 13	<input checked="" type="checkbox"/> 5 MHz	<input checked="" type="checkbox"/> 10 MHz		
LTE Band 14	<input checked="" type="checkbox"/> 5 MHz	<input checked="" type="checkbox"/> 10 MHz		
LTE Band 17	<input checked="" type="checkbox"/> 5 MHz	<input checked="" type="checkbox"/> 10 MHz		
LTE Band 25	<input checked="" type="checkbox"/> 1.4 MHz	<input checked="" type="checkbox"/> 3 MHz	<input checked="" type="checkbox"/> 5 MHz	<input checked="" type="checkbox"/> 10 MHz
	<input checked="" type="checkbox"/> 15 MHz	<input checked="" type="checkbox"/> 20 MHz		
LTE Band 26(814-824)	<input checked="" type="checkbox"/> 1.4 MHz	<input checked="" type="checkbox"/> 3 MHz	<input checked="" type="checkbox"/> 5 MHz	<input checked="" type="checkbox"/> 10 MHz
LTE Band 26(824-849)	<input checked="" type="checkbox"/> 1.4 MHz	<input checked="" type="checkbox"/> 3 MHz	<input checked="" type="checkbox"/> 5 MHz	<input checked="" type="checkbox"/> 10 MHz
	<input checked="" type="checkbox"/> 15 MHz			
LTE Band30	<input checked="" type="checkbox"/> 5 MHz	<input checked="" type="checkbox"/> 10 MHz		
LTE Band38	<input checked="" type="checkbox"/> 5 MHz	<input checked="" type="checkbox"/> 10 MHz	<input checked="" type="checkbox"/> 15 MHz	<input checked="" type="checkbox"/> 20 MHz
LTE Band41	<input checked="" type="checkbox"/> 5 MHz	<input checked="" type="checkbox"/> 10 MHz	<input checked="" type="checkbox"/> 15 MHz	<input checked="" type="checkbox"/> 20 MHz
LTE Band42	<input checked="" type="checkbox"/> 5 MHz	<input checked="" type="checkbox"/> 10 MHz	<input checked="" type="checkbox"/> 15 MHz	<input checked="" type="checkbox"/> 20 MHz
LTE Band43	<input checked="" type="checkbox"/> 5 MHz	<input checked="" type="checkbox"/> 10 MHz	<input checked="" type="checkbox"/> 15 MHz	<input checked="" type="checkbox"/> 20 MHz
LTE Band48	<input checked="" type="checkbox"/> 5 MHz	<input checked="" type="checkbox"/> 10 MHz	<input checked="" type="checkbox"/> 15 MHz	<input checked="" type="checkbox"/> 20 MHz
LTE Band66	<input checked="" type="checkbox"/> 1.4 MHz	<input checked="" type="checkbox"/> 3 MHz	<input checked="" type="checkbox"/> 5 MHz	<input checked="" type="checkbox"/> 10 MHz
	<input checked="" type="checkbox"/> 15MHz	<input checked="" type="checkbox"/> 20MHz		
LTE Band71	<input checked="" type="checkbox"/> 5MHz	<input checked="" type="checkbox"/> 10MHz	<input checked="" type="checkbox"/> 15MHz	<input checked="" type="checkbox"/> 20MHz



SGS-CSTC Standards Technical Services Co., Ltd.  
Shenzhen Branch Inspection & Testing Services

Unless otherwise agreed in writing, this document is issued by the Company subject to its General Conditions of Service printed overleaf, available on request or accessible at <https://www.sgs.com/en/Terms-and-Conditions>. Attention is drawn to the limitation of liability, indemnification and jurisdiction issues defined therein. Any holder of this document is advised that information contained hereon reflects the Company's findings at the time of its intervention only and within the limits of Client's instructions, if any. The Company's sole responsibility is to its Client and this document does not exonerate parties to a transaction from exercising all their rights and obligations under the transaction documents. This document cannot be reproduced except in full, without prior written approval of the Company. Any unauthorized alteration, forgery or falsification of the content or appearance of this document is unlawful and offenders may be prosecuted to the fullest extent of the law. Unless otherwise stated the results shown in this test report refer only to the sample(s) tested and such sample(s) are retained for 30 days only.

Attention: To check the authenticity of testing /inspection report & certificate, please contact us at telephone: (86-755) 8307 1443, or email: CN.Doccheck@sgs.com

No.1 Workshop, M-10, Middle Section, Science & Technology Park, Nanshan District, Shenzhen, Guangdong, China 518057 t (86-755) 26012053 www.sgs.com.cn  
中国·广东·深圳市南山区科技园中区M-10栋1号厂房 邮编: 518057 t (86-755) 26012053 sgs.china@sgs.com



Report No.: SZCR240200055101  
 Rev.: 01  
 Page: 27 of 53

### 3.9 Test Frequencies

Test Mode	Bandwidth	TX / RX	RF Channel		
			Low (L)	Middle (M)	High (H)
LTE Band 2	1.4MHz	TX	Channel 18607	Channel 18900	Channel 19193
			1850.7 MHz	1880 MHz	1909.3 MHz
		RX	Channel 607	Channel 900	Channel 1193
			1930.7 MHz	1960 MHz	1989.3 MHz
	3MHz	TX	Channel 18615	Channel 18900	Channel 19185
			1851.5 MHz	1880 MHz	1908.5 MHz
		RX	Channel 615	Channel 900	Channel 1185
			1931.5 MHz	1960 MHz	1988.5 MHz
	5MHz	TX	Channel 18625	Channel 18900	Channel 19175
			1852.5 MHz	1880 MHz	1907.5 MHz
		RX	Channel 625	Channel 900	Channel 1175
			1932.5 MHz	1960 MHz	1987.5 MHz
	10MHz	TX	Channel 18650	Channel 18900	Channel 19150
			1855 MHz	1880 MHz	1905 MHz
		RX	Channel 650	Channel 900	Channel 1150
			1935 MHz	1960 MHz	1985 MHz
	15MHz	TX	Channel 18675	Channel 18900	Channel 19125
			1857.5 MHz	1880 MHz	1902.5 MHz
		RX	Channel 675	Channel 900	Channel 1125
			1937.5 MHz	1960 MHz	1982.5 MHz
	20MHz	TX	Channel 18700	Channel 18900	Channel 19100
			1860 MHz	1880 MHz	1900 MHz
		RX	Channel 700	Channel 900	Channel 1100
			1940 MHz	1960 MHz	1980 MHz



SGS-CSTC Standards Technical Services Co., Ltd.  
 Shenzhen Branch

Unless otherwise agreed in writing, this document is issued by the Company subject to its General Conditions of Service printed overleaf, available on request or accessible at <https://www.sgs.com/en/Terms-and-Conditions>. Attention is drawn to the limitation of liability, indemnification and jurisdiction issues defined therein. Any holder of this document is advised that information contained hereon reflects the Company's findings at the time of its intervention only and within the limits of Client's instructions, if any. The Company's sole responsibility is to its Client and this document does not exonerate parties to a transaction from exercising all their rights and obligations under the transaction documents. This document cannot be reproduced except in full, without prior written approval of the Company. Any unauthorized alteration, forgery or falsification of the content or appearance of this document is unlawful and offenders may be prosecuted to the fullest extent of the law. Unless otherwise stated the results shown in this test report refer only to the sample(s) tested and such sample(s) are retained for 30 days only.  
**Attention: To check the authenticity of testing /inspection report & certificate, please contact us at telephone: (86-755) 8307 1443, or email: CN.Doccheck@sgs.com**

No.1 Workshop, M-10, Middle Section, Science & Technology Park, Nanshan District, Shenzhen, Guangdong, China 518057 t (86-755) 26012053 www.sgs.com.cn  
 中国·广东·深圳市南山区科技园中区M-10栋1号厂房 邮编: 518057 t (86-755) 26012053 sgs.china@sgs.com



# SGS-CSTC Standards Technical Services Co., Ltd. Shenzhen Branch

Report No.: SZCR240200055101  
Rev.: 01  
Page: 28 of 53

Test Mode	Bandwidth	TX / RX	RF Channel		
			Low (L)	Middle (M)	High (H)
LTE Band 4	1.4MHz	TX	Channel 19957 1710.7 MHz	Channel 20175 1732.5 MHz	Channel 20393 1754.3 MHz
		RX	Channel 1975 2112.5 MHz	Channel 2175 2132.5MHz	Channel 2375 2152.5 MHz
	3MHz	TX	Channel 19965 1711.5 MHz	Channel 20175 1732.5 MHz	Channel 20385 1753.5 MHz
		RX	Channel 2000 2115 MHz	Channel 2175 2132.5MHz	Channel 2350 2150 MHz
	5MHz	TX	Channel 19975 1712.5 MHz	Channel 20175 1732.5 MHz	Channel 20375 1752.5 MHz
		RX	Channel 1975 2112.5 MHz	Channel 2175 2132.5MHz	Channel 2375 2152.5 MHz
	10MHz	TX	Channel 20000 1715 MHz	Channel 20175 1732.5 MHz	Channel 20350 1750 MHz
		RX	Channel 2000 2115 MHz	Channel 2175 2132.5MHz	Channel 2350 2150 MHz
	15MHz	TX	Channel 20025 1717.5 MHz	Channel 20175 1732.5 MHz	Channel 20325 1747.5 MHz
		RX	Channel 2025 2117.5 MHz	Channel 2175 2132.5MHz	Channel 2325 2147.5 MHz
	20MHz	TX	Channel 20050 1720 MHz	Channel 20175 1732.5 MHz	Channel 20300 1745 MHz
		RX	Channel 2050 2120 MHz	Channel 2175 2132.5MHz	Channel 2300 2145 MHz

Test Mode	Bandwidth	TX / RX	RF Channel		
			Low (L)	Middle (M)	High (H)
LTE Band 5	1.4MHz	TX	Channel 20407 824.7 MHz	Channel 20525 836.5 MHz	Channel 20643 848.3 MHz
		RX	Channel 2407 869.7 MHz	Channel 2525 881.5 MHz	Channel 2643 893.3 MHz
	3MHz	TX	Channel 20415 825.5 MHz	Channel 20525 836.5 MHz	Channel 20635 847.5 MHz
		RX	Channel 2415 870.5 MHz	Channel 2525 881.5 MHz	Channel 2635 892.5 MHz
	5MHz	TX	Channel 20425 826.5 MHz	Channel 20525 836.5 MHz	Channel 20625 846.5 MHz
		RX	Channel 2425 871.5 MHz	Channel 2525 881.5 MHz	Channel 2625 891.5 MHz
	10MHz	TX	Channel 20450 829 MHz	Channel 20525 836.5 MHz	Channel 20600 844 MHz
		RX	Channel 2450 874 MHz	Channel 2525 881.5 MHz	Channel 2600 889 MHz



SGS-CSTC Standards Technical Services Co., Ltd.  
Shenzhen Branch

Unless otherwise agreed in writing, this document is issued by the Company subject to its General Conditions of Service printed overleaf, available on request or accessible at <https://www.sgs.com/en/Terms-and-Conditions>. Attention is drawn to the limitation of liability, indemnification and jurisdiction issues defined therein. Any holder of this document is advised that information contained hereon reflects the Company's findings at the time of its intervention only and within the limits of Client's instructions, if any. The Company's sole responsibility is to its Client and this document does not exonerate parties to a transaction from exercising all their rights and obligations under the transaction documents. This document cannot be reproduced except in full, without prior written approval of the Company. Any unauthorized alteration, forgery or falsification of the content or appearance of this document is unlawful and offenders may be prosecuted to the fullest extent of the law. Unless otherwise stated the results shown in this test report refer only to the sample(s) tested and such sample(s) are retained for 30 days only.  
**Attention: To check the authenticity of testing /inspection report & certificate, please contact us at telephone: (86-755) 8307 1443, or email: CN.Doccheck@sgs.com**

No.1 Workshop, M-10, Middle Section, Science & Technology Park, Nanshan District, Shenzhen, Guangdong, China 518057 t (86-755) 26012053 www.sgs.com.cn  
中国·广东·深圳市南山区科技园中区M-10栋1号厂房 邮编: 518057 t (86-755) 26012053 sgs.china@sgs.com





# SGS-CSTC Standards Technical Services Co., Ltd. Shenzhen Branch

Report No.: SZCR240200055101  
Rev.: 01  
Page: 29 of 53

Test Mode	Bandwidth	TX / RX	RF Channel		
			Low (L)	Middle (M)	High (H)
LTE Band 7	5MHz	TX	Channel 20775	Channel 21100	Channel 21425
			2502.5 MHz	2535 MHz	2567.5 MHz
		RX	Channel 2775	Channel 3100	Channel 5825
			2622.5 MHz	2655 MHz	2687.5 MHz
	10MHz	TX	Channel 20800	Channel 21100	Channel 21400
			2505 MHz	2535 MHz	2565 MHz
		RX	Channel 2800	Channel 3100	Channel 3400
			2625 MHz	2655 MHz	2685 MHz
	15MHz	TX	Channel 20825	Channel 21100	Channel 21375
			2507.5 MHz	2535 MHz	2562.5 MHz
		RX	Channel 2825	Channel 3100	Channel 3375
			2627.5 MHz	2655 MHz	2682.5 MHz
20MHz	TX	Channel 20850	Channel 21100	Channel 21350	
		2510 MHz	2535 MHz	2560 MHz	
	RX	Channel 2850	Channel 3100	Channel 3350	
		2630 MHz	2655 MHz	2680 MHz	

Test Mode	Bandwidth	TX / RX	RF Channel		
			Low (L)	Middle (M)	High (H)
LTE Band 12	1.4MHz	TX	Channel 23017	Channel 23095	Channel 23173
			699.7 MHz	707.5 MHz	715.3 MHz
		RX	Channel 5017	Channel 5095	Channel 5173
			729.7 MHz	737.5 MHz	745.3 MHz
	3MHz	TX	Channel 23025	Channel 23095	Channel 23165
			700.5 MHz	707.5 MHz	714.5 MHz
		RX	Channel 5025	Channel 5095	Channel 5165
			730.5 MHz	737.5 MHz	744.5 MHz
	5MHz	TX	Channel 23035	Channel 23095	Channel 23155
			701.5 MHz	707.5 MHz	713.5 MHz
		RX	Channel 5035	Channel 5095	Channel 5155
			731.5 MHz	737.5 MHz	743.5 MHz
10MHz	TX	Channel 23060	Channel 23095	Channel 23130	
		704 MHz	707.5 MHz	711 MHz	
	RX	Channel 5060	Channel 5095	Channel 5130	
		734 MHz	737.5 MHz	741 MHz	



SGS-CSTC Standards Technical Services Co., Ltd.  
Shenzhen Branch

Unless otherwise agreed in writing, this document is issued by the Company subject to its General Conditions of Service printed overleaf, available on request or accessible at <https://www.sgs.com/en/Terms-and-Conditions>. Attention is drawn to the limitation of liability, indemnification and jurisdiction issues defined therein. Any holder of this document is advised that information contained hereon reflects the Company's findings at the time of its intervention only and within the limits of Client's instructions, if any. The Company's sole responsibility is to its Client and this document does not exonerate parties to a transaction from exercising all their rights and obligations under the transaction documents. This document cannot be reproduced except in full, without prior written approval of the Company. Any unauthorized alteration, forgery or falsification of the content or appearance of this document is unlawful and offenders may be prosecuted to the fullest extent of the law. Unless otherwise stated the results shown in this test report refer only to the sample(s) tested and such sample(s) are retained for 30 days only.  
**Attention: To check the authenticity of testing /inspection report & certificate, please contact us at telephone: (86-755) 8307 1443, or email: CN.Doccheck@sgs.com**

No.1 Workshop, M-10, Middle Section, Science & Technology Park, Nanshan District, Shenzhen, Guangdong, China 518057 t (86-755) 26012053 www.sgs.com.cn  
中国·广东·深圳市南山区科技园中区M-10栋1号厂房 邮编: 518057 t (86-755) 26012053 sgs.china@sgs.com



# SGS-CSTC Standards Technical Services Co., Ltd. Shenzhen Branch

Report No.: SZCR240200055101  
Rev.: 01  
Page: 30 of 53

Test Mode	Bandwidth	TX / RX	RF Channel		
			Low (L)	Middle (M)	High (H)
LTE Band 13	5MHz	TX	Channel 23025	Channel 23230	Channel 23255
			779.5 MHz	782 MHz	784.5 MHz
		RX	Channel 5205	Channel 5230	Channel 5255
			748.5 MHz	751 MHz	753.5 MHz
	10MHz	TX	Channel 23230	Channel 23230	Channel 23230
			782 MHz	782 MHz	782 MHz
RX	Channel 5230	Channel 5230	Channel 5230		
	751 MHz	751 MHz	751 MHz		

Test Mode	Bandwidth	TX / RX	RF Channel		
			Low (L)	Middle (M)	High (H)
LTE Band 14	5MHz	TX	Channel 23305	Channel 23330	Channel 23355
			790.5 MHz	793 MHz	795.5 MHz
		RX	Channel 5305	Channel 5330	Channel 5355
			760.5 MHz	763 MHz	765.5 MHz
	10MHz	TX	Channel 23330	Channel 23330	Channel 23330
			793MHz	793 MHz	793 MHz
RX	Channel 5330	Channel 5330	Channel 5330		
	763MHz	763 MHz	763 MHz		

Test Mode	Bandwidth	TX / RX	RF Channel		
			Low (L)	Middle (M)	High (H)
LTE Band 17	5MHz	TX	Channel 23755	Channel 23790	Channel 23825
			706.5 MHz	710 MHz	713.5 MHz
		RX	Channel 5755	Channel 5790	Channel 5825
			736.5 MHz	740 MHz	743.5 MHz
	10MHz	TX	Channel 23780	Channel 23790	Channel 23800
			709 MHz	710 MHz	711 MHz
RX	Channel 5780	Channel 5790	Channel 5800		
	739 MHz	740 MHz	741 MHz		



SGS-CSTC Standards Technical Services Co., Ltd.  
Shenzhen Branch

Unless otherwise agreed in writing, this document is issued by the Company subject to its General Conditions of Service printed overleaf, available on request or accessible at <https://www.sgs.com/en/Terms-and-Conditions>. Attention is drawn to the limitation of liability, indemnification and jurisdiction issues defined therein. Any holder of this document is advised that information contained hereon reflects the Company's findings at the time of its intervention only and within the limits of Client's instructions, if any. The Company's sole responsibility is to its Client and this document does not exonerate parties to a transaction from exercising all their rights and obligations under the transaction documents. This document cannot be reproduced except in full, without prior written approval of the Company. Any unauthorized alteration, forgery or falsification of the content or appearance of this document is unlawful and offenders may be prosecuted to the fullest extent of the law. Unless otherwise stated the results shown in this test report refer only to the sample(s) tested and such sample(s) are retained for 30 days only.  
**Attention: To check the authenticity of testing /inspection report & certificate, please contact us at telephone: (86-755) 8307 1443, or email: CN.Doccheck@sgs.com**

No.1 Workshop, M-10, Middle Section, Science & Technology Park, Nanshan District, Shenzhen, Guangdong, China 518057 t (86-755) 26012053 www.sgs.com.cn  
中国·广东·深圳市南山区科技园中区M-10栋1号厂房 邮编: 518057 t (86-755) 26012053 sgs.china@sgs.com



# SGS-CSTC Standards Technical Services Co., Ltd. Shenzhen Branch

Report No.: SZCR240200055101  
Rev.: 01  
Page: 31 of 53

Test Mode	Bandwidth	TX / RX	RF Channel		
			Low (L)	Middle (M)	High (H)
LTE Band 25	1.4MHz	TX	Channel 26047	Channel 26365	Channel 26683
			1850.7 MHz	1882.5 MHz	1914.3 MHz
		RX	Channel 8047	Channel 8365	Channel 8683
			1930.7 MHz	1962.5 MHz	1994.3 MHz
	3MHz	TX	Channel 26055	Channel 26365	Channel 26675
			1851.5 MHz	1882.5 MHz	1913.5 MHz
		RX	Channel 8055	Channel 8365	Channel 8675
			1931.5 MHz	1962.5 MHz	1993.5 MHz
	5MHz	TX	Channel 26065	Channel 26365	Channel 26665
			1852.5 MHz	1882.5 MHz	1912.5 MHz
		RX	Channel 8065	Channel 8365	Channel 8665
			1932.5 MHz	1962.5 MHz	1992.5 MHz
	10MHz	TX	Channel 26090	Channel 26365	Channel 26640
			1855 MHz	1882.5 MHz	1910 MHz
		RX	Channel 8090	Channel 8365	Channel 8640
			1935 MHz	1962.5 MHz	1990 MHz
	15MHz	TX	Channel 26115	Channel 26365	Channel 26615
			1857.5 MHz	1882.5 MHz	1907.5 MHz
		RX	Channel 8115	Channel 8365	Channel 8615
			1937.5 MHz	1962.5 MHz	1987.5 MHz
20MHz	TX	Channel 26140	Channel 26365	Channel 26590	
		1860 MHz	1882.5 MHz	1905 MHz	
	RX	Channel 8140	Channel 8365	Channel 8590	
		1940 MHz	1962.5 MHz	1985 MHz	



SGS-CSTC Standards Technical Services Co., Ltd.  
Shenzhen Branch, Inspection & Testing Services

Unless otherwise agreed in writing, this document is issued by the Company subject to its General Conditions of Service printed overleaf, available on request or accessible at <https://www.sgs.com/en/Terms-and-Conditions>. Attention is drawn to the limitation of liability, indemnification and jurisdiction issues defined therein. Any holder of this document is advised that information contained hereon reflects the Company's findings at the time of its intervention only and within the limits of Client's instructions, if any. The Company's sole responsibility is to its Client and this document does not exonerate parties to a transaction from exercising all their rights and obligations under the transaction documents. This document cannot be reproduced except in full, without prior written approval of the Company. Any unauthorized alteration, forgery or falsification of the content or appearance of this document is unlawful and offenders may be prosecuted to the fullest extent of the law. Unless otherwise stated the results shown in this test report refer only to the sample(s) tested and such sample(s) are retained for 30 days only.  
**Attention: To check the authenticity of testing /inspection report & certificate, please contact us at telephone: (86-755) 8307 1443, or email: CN.Doccheck@sgs.com**

No.1 Workshop, M-10, Middle Section, Science & Technology Park, Nanshan District, Shenzhen, Guangdong, China 518057 t (86-755) 26012053 www.sgs.com.cn  
中国·广东·深圳市南山区科技园中区M-10栋1号厂房 邮编: 518057 t (86-755) 26012053 sgs.china@sgs.com



# SGS-CSTC Standards Technical Services Co., Ltd. Shenzhen Branch

Report No.: SZCR240200055101  
Rev.: 01  
Page: 32 of 53

Test Mode	Bandwidth	TX / RX	RF Channel		
			Low (L)	Middle (M)	High (H)
LTE Band 26 (814-824)	1.4MHz	TX	Channel 26697	Channel 26740	Channel 26783
			814.7 MHz	819 MHz	823.3 MHz
		RX	Channel 8697	Channel 8740	Channel 8783
			859.7 MHz	864MHz	868.3 MHz
	3MHz	TX	Channel 26705	Channel 26740	Channel 26775
			815.5 MHz	819 MHz	822.5 MHz
		RX	Channel 8705	Channel 8740	Channel 8775
			860.5 MHz	864MHz	867.5 MHz
	5MHz	TX	Channel 26715	Channel 26740	Channel 26765
			816.5 MHz	819 MHz	821.5 MHz
		RX	Channel 8715	Channel 8740	Channel 8755
			861.5 MHz	864MHz	866.5 MHz
10MHz	TX	Channel 26740	Channel 26740	Channel 26740	
		819 MHz	819 MHz	819 MHz	
	RX	Channel 8740	Channel 8740	Channel 8740	
		864MHz	864MHz	864MHz	

Test Mode	Bandwidth	TX / RX	RF Channel		
			Low (L)	Middle (M)	High (H)
LTE Band26 (824-849)	1.4MHz	TX	Channel 26797	Channel 26915	Channel 27033
			824.7 MHz	836.5 MHz	848.3 MHz
		RX	Channel 8697	Channel 8915	Channel 9033
			859.7 MHz	881.5 MHz	893.3 MHz
	3MHz	TX	Channel 26805	Channel 26915	Channel 27025
			825.5 MHz	836.5 MHz	847.5 MHz
		RX	Channel 8805	Channel 8915	Channel 9025
			860.5 MHz	881.5 MHz	892.5 MHz
	5MHz	TX	Channel 26815	Channel 26915	Channel 27015
			826.5 MHz	836.5 MHz	846.5 MHz
		RX	Channel 8815	Channel 8915	Channel 9015
			871.5 MHz	881.5 MHz	891.5 MHz
	10MHz	TX	Channel 26840	Channel 26915	Channel 26990
			829 MHz	836.5 MHz	844 MHz
		RX	Channel 8840	Channel 8915	Channel 8990
			874 MHz	881.5 MHz	889 MHz
	15MHz	TX	Channel 26865	Channel 26915	Channel 26965
			831.5 MHz	836.5 MHz	841.5 MHz
RX		Channel 8865	Channel 8915	Channel 8965	
		876.5 MHz	881.5 MHz	886.5 MHz	



SGS-CSTC Standards Technical Services Co., Ltd.  
Shenzhen Branch, Inspection & Testing Services

Unless otherwise agreed in writing, this document is issued by the Company subject to its General Conditions of Service printed overleaf, available on request or accessible at <https://www.sgs.com/en/Terms-and-Conditions>. Attention is drawn to the limitation of liability, indemnification and jurisdiction issues defined therein. Any holder of this document is advised that information contained hereon reflects the Company's findings at the time of its intervention only and within the limits of Client's instructions, if any. The Company's sole responsibility is to its Client and this document does not exonerate parties to a transaction from exercising all their rights and obligations under the transaction documents. This document cannot be reproduced except in full, without prior written approval of the Company. Any unauthorized alteration, forgery or falsification of the content or appearance of this document is unlawful and offenders may be prosecuted to the fullest extent of the law. Unless otherwise stated the results shown in this test report refer only to the sample(s) tested and such sample(s) are retained for 30 days only.  
Attention: To check the authenticity of testing /inspection report & certificate, please contact us at telephone: (86-755) 8307 1443, or email: CN.Doccheck@sgs.com

No. 1 Workshop, M-10, Middle Section, Science & Technology Park, Nanshan District, Shenzhen, Guangdong, China 518057 t (86-755) 26012053 www.sgs.com.cn  
中国·广东·深圳市南山区科技园中区M-10栋1号厂房 邮编: 518057 t (86-755) 26012053 sgs.china@sgs.com





# SGS-CSTC Standards Technical Services Co., Ltd. Shenzhen Branch

Report No.: SZCR240200055101  
Rev.: 01  
Page: 33 of 53

Test Mode	Bandwidth	TX / RX	RF Channel		
			Low (L)	Middle (M)	High (H)
LTE Band 30	5MHz	TX	Channel 27685	Channel27710	Channel 27735
			2307.5 MHz	2310MHz	2312.5 MHz
		RX	Channel 9795	Channel 9820	Channel 9845
	2352.5MHz		2355 MHz	2357.5MHz	
	10MHz	TX	Channel 27710	Channel27710	Channel27710
			2310 MHz	2310MHz	2310MHz
RX		Channel 9820	Channel 9820	Channel 9820	
	2355 MHz	2355 MHz	2355 MHz		

Test Mode	Bandwidth	TX / RX	RF Channel		
			Low (L)	Middle (M)	High (H)
LTE Band 38	5MHz	TX/RX	Channel 37775	Channel38000	Channel 38225
			2572.5 MHz	2595 MHz	2617.5 MHz
	10MHz	TX/RX	Channel 37800	Channel38000	Channel 38200
			2575 MHz	2595 MHz	2615 MHz
	15MHz	TX/RX	Channel 37825	Channel38000	Channel 38175
			2577.5 MHz	2595 MHz	2612.5 MHz
	20MHz	TX/RX	Channel 37850	Channel38000	Channel 38150
			2580 MHz	2595 MHz	2610 MHz

Test Mode	Bandwidth	TX / RX	RF Channel		
			Low (L)	Middle (M)	High (H)
LTE Band 41 (2496-2690)	5MHz	TX / RX	Channel 39675	Channel40620	Channel 41565
			2498.5 MHz	2593 MHz	2687.5 MHz
	10MHz	TX / RX	Channel 39700	Channel40620	Channel 41540
			2501 MHz	2593 MHz	2685 MHz
	15MHz	TX / RX	Channel 39725	Channel40620	Channel 41515
			2503.5 MHz	2593 MHz	2682.5 MHz
	20MHz	TX / RX	Channel 39750	Channel40620	Channel 41490
			2506 MHz	2593 MHz	2680 MHz



SGS-CSTC Standards Technical Services Co., Ltd.  
Shenzhen Branch

Unless otherwise agreed in writing, this document is issued by the Company subject to its General Conditions of Service printed overleaf, available on request or accessible at <https://www.sgs.com/en/Terms-and-Conditions>. Attention is drawn to the limitation of liability, indemnification and jurisdiction issues defined therein. Any holder of this document is advised that information contained hereon reflects the Company's findings at the time of its intervention only and within the limits of Client's instructions, if any. The Company's sole responsibility is to its Client and this document does not exonerate parties to a transaction from exercising all their rights and obligations under the transaction documents. This document cannot be reproduced except in full, without prior written approval of the Company. Any unauthorized alteration, forgery or falsification of the content or appearance of this document is unlawful and offenders may be prosecuted to the fullest extent of the law. Unless otherwise stated the results shown in this test report refer only to the sample(s) tested and such sample(s) are retained for 30 days only.  
**Attention: To check the authenticity of testing /inspection report & certificate, please contact us at telephone: (86-755) 8307 1443, or email: CN.Doccheck@sgs.com**

No.1 Workshop, M-10, Middle Section, Science & Technology Park, Nanshan District, Shenzhen, Guangdong, China 518057 t (86-755) 26012053 www.sgs.com.cn  
中国·广东·深圳市南山区科技园中区M-10栋1号厂房 邮编: 518057 t (86-755) 26012053 sgs.china@sgs.com





# SGS-CSTC Standards Technical Services Co., Ltd. Shenzhen Branch

Report No.: SZCR240200055101  
Rev.: 01  
Page: 34 of 53

Test Mode	Bandwidth	TX / RX	RF Channel		
			Low (L)	Middle (M)	High (H)
LTE Band 42 (3550-3600)	5MHz	TX	Channel 40115	Channel 43340	Channel 43565
			3552.5 MHz	3575 MHz	3597.5 MHz
		RX	Channel 40115	Channel 43340	Channel 43565
			3552.5 MHz	3575 MHz	3597.5 MHz
	10MHz	TX	Channel 43140	Channel 43340	Channel 43540
			3555 MHz	3575 MHz	3595 MHz
		RX	Channel 43140	Channel 43340	Channel 43540
			3555 MHz	3575 MHz	3595 MHz
	15MHz	TX	Channel 43165	Channel 43340	Channel 43515
			3557.5 MHz	3575 MHz	3592.5 MHz
		RX	Channel 43165	Channel 43340	Channel 43515
			3557.5 MHz	3575 MHz	3592.5 MHz
20MHz	TX	Channel 43190	Channel 43340	Channel 43490	
		3560 MHz	3575 MHz	3590 MHz	
	RX	Channel 43190	Channel 43340	Channel 43490	
		3560 MHz	3575 MHz	3590 MHz	

Test Mode	Bandwidth	TX / RX	RF Channel		
			Low (L)	Middle (M)	High (H)
LTE Band 42 (3450-3550)	5MHz	TX	Channel 42115	Channel 42590	Channel 43065
			3452.5 MHz	3500 MHz	3547.5 MHz
		RX	Channel 42115	Channel 42590	Channel 43065
			3452.5 MHz	3500 MHz	3547.5 MHz
	10MHz	TX	Channel 42140	Channel 42590	Channel 43040
			3455 MHz	3500 MHz	3545 MHz
		RX	Channel 42140	Channel 42590	Channel 43040
			3455 MHz	3500 MHz	3545 MHz
	15MHz	TX	Channel 42165	Channel 42590	Channel 43015
			3457.5 MHz	3500 MHz	3542.5 MHz
		RX	Channel 42165	Channel 42590	Channel 43015
			3457.5 MHz	3500 MHz	3542.5 MHz
	20MHz	TX	Channel 42190	Channel 42590	Channel 42990
			3460 MHz	3500 MHz	3540 MHz
		RX	Channel 42190	Channel 42590	Channel 42990
			3460 MHz	3500 MHz	3540 MHz



SGS-CSTC Standards Technical Services Co., Ltd.  
Shenzhen Branch  
Inspection & Testing Services  
Wireless Laboratory

Unless otherwise agreed in writing, this document is issued by the Company subject to its General Conditions of Service printed overleaf, available on request or accessible at <https://www.sgs.com/en/Terms-and-Conditions>. Attention is drawn to the limitation of liability, indemnification and jurisdiction issues defined therein. Any holder of this document is advised that information contained hereon reflects the Company's findings at the time of its intervention only and within the limits of Client's instructions, if any. The Company's sole responsibility is to its Client and this document does not exonerate parties to a transaction from exercising all their rights and obligations under the transaction documents. This document cannot be reproduced except in full, without prior written approval of the Company. Any unauthorized alteration, forgery or falsification of the content or appearance of this document is unlawful and offenders may be prosecuted to the fullest extent of the law. Unless otherwise stated the results shown in this test report refer only to the sample(s) tested and such sample(s) are retained for 30 days only.  
**Attention: To check the authenticity of testing /inspection report & certificate, please contact us at telephone: (86-755) 8307 1443, or email: CN.Doccheck@sgs.com**

No.1 Workshop, M-10, Middle Section, Science & Technology Park, Nanshan District, Shenzhen, Guangdong, China 518057 t (86-755) 26012053 www.sgs.com.cn  
中国·广东·深圳市南山区科技园中区M-10栋1号厂房 邮编: 518057 t (86-755) 26012053 sgs.china@sgs.com



# SGS-CSTC Standards Technical Services Co., Ltd. Shenzhen Branch

Report No.: SZCR240200055101  
Rev.: 01  
Page: 35 of 53

Test Mode	Bandwidth	TX / RX	RF Channel		
			Low (L)	Middle (M)	High (H)
LTE Band 43 (3700-3800)	5MHz	TX/RX	Channel 44615	Channel45090	Channel 45565
			3702.5 MHz	3750.0 MHz	3797.5 MHz
	10MHz	TX/RX	Channel 44640	Channel45090	Channel 45540
			3705.0 MHz	3750.0 MHz	3795.0 MHz
	15MHz	TX/RX	Channel 44665	Channel45090	Channel 45515
			3707.5 MHz	3750.0 MHz	3792.5 MHz
	20MHz	TX/RX	Channel 44690	Channel45090	Channel 45490
			3710 MHz	3750.0 MHz	3790.0 MHz

Test Mode	Bandwidth	TX / RX	RF Channel		
			Low (L)	Middle (M)	High (H)
LTE Band 43 (3600-3700)	5MHz	TX/RX	Channel 43615	Channel44090	Channel 44565
			3602.5 MHz	3650.0 MHz	3697.5 MHz
	10MHz	TX/RX	Channel 43640	Channel44090	Channel 44540
			3605.0 MHz	3650.0 MHz	3695.0 MHz
	15MHz	TX/RX	Channel 43665	Channel44090	Channel 44515
			3607.5 MHz	3650.0 MHz	3692.5 MHz
	20MHz	TX/RX	Channel 43690	Channel44090	Channel 44490
			3610 MHz	3650.0 MHz	3690.0 MHz

Test Mode	Bandwidth	TX / RX	RF Channel		
			Low (L)	Middle (M)	High (H)
LTE Band 48	5MHz	TX/RX	Channel 55265	Channel55990	Channel 56715
			3552.5 MHz	3625.0 MHz	3697.5 MHz
	10MHz	TX/RX	Channel 55290	Channel55990	Channel 56690
			3555.0 MHz	3625.0 MHz	3695.0 MHz
	15MHz	TX/RX	Channel 55315	Channel55990	Channel 56665
			3557.5 MHz	3625.0 MHz	3692.5 MHz
	20MHz	TX/RX	Channel 55340	Channel55990	Channel 56640
			3560.0 MHz	3625.0 MHz	3690.0 MHz



SGS-CSTC Standards Technical Services Co., Ltd.  
Shenzhen Branch Inspection & Testing Services Laboratory

Unless otherwise agreed in writing, this document is issued by the Company subject to its General Conditions of Service printed overleaf, available on request or accessible at <https://www.sgs.com/en/Terms-and-Conditions>. Attention is drawn to the limitation of liability, indemnification and jurisdiction issues defined therein. Any holder of this document is advised that information contained hereon reflects the Company's findings at the time of its intervention only and within the limits of Client's instructions, if any. The Company's sole responsibility is to its Client and this document does not exonerate parties to a transaction from exercising all their rights and obligations under the transaction documents. This document cannot be reproduced except in full, without prior written approval of the Company. Any unauthorized alteration, forgery or falsification of the content or appearance of this document is unlawful and offenders may be prosecuted to the fullest extent of the law. Unless otherwise stated the results shown in this test report refer only to the sample(s) tested and such sample(s) are retained for 30 days only.  
**Attention: To check the authenticity of testing /inspection report & certificate, please contact us at telephone: (86-755) 8307 1443, or email: CN.Doccheck@sgs.com**

No.1 Workshop, M-10, Middle Section, Science & Technology Park, Nanshan District, Shenzhen, Guangdong, China 518057 t (86-755) 26012053 www.sgs.com.cn  
中国·广东·深圳市南山区科技园中区M-10栋1号厂房 邮编: 518057 t (86-755) 26012053 sgs.china@sgs.com



# SGS-CSTC Standards Technical Services Co., Ltd. Shenzhen Branch

Report No.: SZCR240200055101  
Rev.: 01  
Page: 36 of 53

Test Mode	Bandwidth	TX / RX	RF Channel		
			Low (L)	Middle (M)	High (H)
LTE Band66	1.4MHz	TX	Channel 131979	Channel 132322	Channel 132665
			1710.7 MHz	1745 MHz	1779.3 MHz
		RX	Channel 66443	Channel 66786	Channel 67329
			2110.7 MHz	2145MHz	2199.3 MHz
	3MHz	TX	Channel 131987	Channel 132322	Channel 132657
			1711.5 MHz	1745 MHz	1778.5MHz
		RX	Channel 66451	Channel 66786	Channel 67321
			2111.5 MHz	2145MHz	2198.5MHz
	5MHz	TX	Channel 131997	Channel 132322	Channel 132647
			1712.5 MHz	1745 MHz	1777.5 MHz
		RX	Channel 66461	Channel 66786	Channel 67311
			2112.5 MHz	2145MHz	2197.5 MHz
	10MHz	TX	Channel 132022	Channel 132322	Channel 132622
			1715 MHz	1745 MHz	1775 MHz
		RX	Channel 66486	Channel 66786	Channel 67286
			2115 MHz	2145MHz	2195 MHz
	15MHz	TX	Channel 132047	Channel 132322	Channel 132597
			1717.5 MHz	1745 MHz	1772.5 MHz
		RX	Channel 66511	Channel 66786	Channel 67261
			2117.5 MHz	2145MHz	2192.5 MHz
20MHz	TX	Channel 132072	Channel 132322	Channel 132572	
		1720 MHz	1745 MHz	1770 MHz	
	RX	Channel 66536	Channel 66786	Channel 67236	
		2120 MHz	2145MHz	2190 MHz	

Test Mode	Bandwidth	TX / RX	RF Channel		
			Low (L)	Middle (M)	High (H)
LTE Band71	5MHz	TX	Channel 133147	Channel 133297	Channel 133447
			665.5 MHz	680.5 MHz	695.5 MHz
		RX	Channel 68611	Channel 68761	Channel 68911
			619.5 MHz	634.5 MHz	649.5 MHz
	10MHz	TX	Channel 133172	Channel 133297	Channel 133422
			668 MHz	680.5 MHz	693 MHz
		RX	Channel 68636	Channel 68761	Channel 68886
			622 MHz	634.5 MHz	647 MHz
	15MHz	TX	Channel 133197	Channel 133297	Channel 133397
			670.5 MHz	680.5 MHz	690.5 MHz
		RX	Channel 68661	Channel 68761	Channel 68861
			624.5 MHz	634.5 MHz	644.5 MHz
	20MHz	TX	Channel 133222	Channel 133297	Channel 133372
			673 MHz	680.5 MHz	688 MHz
		RX	Channel 68686	Channel 68761	Channel 68836
			627 MHz	634.5 MHz	642 MHz



Unless otherwise agreed in writing, this document is issued by the Company subject to its General Conditions of Service printed overleaf, available on request or accessible at <https://www.sgs.com/en/Terms-and-Conditions>. Attention is drawn to the limitation of liability, indemnification and jurisdiction issues defined therein. Any holder of this document is advised that information contained hereon reflects the Company's findings at the time of its intervention only and within the limits of Client's instructions, if any. The Company's sole responsibility is to its Client and this document does not exonerate parties to a transaction from exercising all their rights and obligations under the transaction documents. This document cannot be reproduced except in full, without prior written approval of the Company. Any unauthorized alteration, forgery or falsification of the content or appearance of this document is unlawful and offenders may be prosecuted to the fullest extent of the law. Unless otherwise stated the results shown in this test report refer only to the sample(s) tested and such sample(s) are retained for 30 days only.

Attention: To check the authenticity of testing /inspection report & certificate, please contact us at telephone: (86-755) 8307 1443, or email: CN.Doccheck@sgs.com

No.1 Workshop, M-10, Middle Section, Science & Technology Park, Nanshan District, Shenzhen, Guangdong, China 518057 t (86-755) 26012053 www.sgs.com.cn  
中国·广东·深圳市南山区科技园中区M-10栋1号厂房 邮编: 518057 t (86-755) 26012053 sgs.china@sgs.com



Report No.: SZCR240200055101  
 Rev.: 01  
 Page: 37 of 53

## 4 Description of Tests

### 4.1 Conducted Output Power

Measurement Procedure: FCC KDB 971168 D01 V03r01 Section 5.2.1

The transmitter output was connected to a calibrated coaxial cable, attenuator and power meter, the other end of which was connected to a Base Station Simulator. The Base Station Simulator was set to force the EUT to its maximum power setting. The power output at the transmitter antenna port was determined by adding the value of the cable insertion loss to the power reading. The tests were performed at three frequencies (low channel, middle channel and high channel) and on the highest power levels, which can be setup on the transmitters.

**Remark: Reference test setup 1**



SGS-CSTC Standards Technical Services Co., Ltd.  
 Shenzhen Branch

Unless otherwise agreed in writing, this document is issued by the Company subject to its General Conditions of Service printed overleaf, available on request or accessible at <https://www.sgs.com/en/Terms-and-Conditions>. Attention is drawn to the limitation of liability, indemnification and jurisdiction issues defined therein. Any holder of this document is advised that information contained hereon reflects the Company's findings at the time of its intervention only and within the limits of Client's instructions, if any. The Company's sole responsibility is to its Client and this document does not exonerate parties to a transaction from exercising all their rights and obligations under the transaction documents. This document cannot be reproduced except in full, without prior written approval of the Company. Any unauthorized alteration, forgery or falsification of the content or appearance of this document is unlawful and offenders may be prosecuted to the fullest extent of the law. Unless otherwise stated the results shown in this test report refer only to the sample(s) tested and such sample(s) are retained for 30 days only.

Attention: To check the authenticity of testing /inspection report & certificate, please contact us at telephone: (86-755) 8307 1443, or email: CN.Doccheck@sgs.com

No.1 Workshop, M-10, Middle Section, Science & Technology Park, Nanshan District, Shenzhen, Guangdong, China 518057 t (86-755) 26012053 www.sgsgroup.com.cn  
 中国·广东·深圳市南山区科技园中区M-10栋1号厂房 邮编: 518057 t (86-755) 26012053 sgs.china@sgs.com



Report No.: SZCR240200055101  
 Rev.: 01  
 Page: 38 of 53

## 4.2 Effective (Isotropic) Radiated Power of Transmitter

Measurement Procedure: FCC KDB 971168 D01 V03r01 Section 5.8.4

Calculate power in dBm by the following formula:

ERP (dBm) = Conducted Power (dBm) + antenna gain (dBd)

EIRP(dBm) = Conducted Power (dBm) + antenna gain (dBi)

EIRP=ERP+2.15dB



SGS-CSTC Standards Technical Services Co., Ltd.  
 Shenzhen Branch Wireless Laboratory

Unless otherwise agreed in writing, this document is issued by the Company subject to its General Conditions of Service printed overleaf, available on request or accessible at <https://www.sgs.com/en/Terms-and-Conditions>. Attention is drawn to the limitation of liability, indemnification and jurisdiction issues defined therein. Any holder of this document is advised that information contained hereon reflects the Company's findings at the time of its intervention only and within the limits of Client's instructions, if any. The Company's sole responsibility is to its Client and this document does not exonerate parties to a transaction from exercising all their rights and obligations under the transaction documents. This document cannot be reproduced except in full, without prior written approval of the Company. Any unauthorized alteration, forgery or falsification of the content or appearance of this document is unlawful and offenders may be prosecuted to the fullest extent of the law. Unless otherwise stated the results shown in this test report refer only to the sample(s) tested and such sample(s) are retained for 30 days only.

Attention: To check the authenticity of testing /inspection report & certificate, please contact us at telephone: (86-755) 8307 1443, or email: CN.Doccheck@sgs.com

No.1 Workshop, M-10, Middle Section, Science & Technology Park, Nanshan District, Shenzhen, Guangdong, China 518057 t (86-755) 26012053 www.sgsgroup.com.cn  
 中国·广东·深圳市南山区科技园中区M-10栋1号厂房 邮编: 518057 t (86-755) 26012053 sgs.china@sgs.com





Report No.: SZCR240200055101  
 Rev.: 01  
 Page: 39 of 53

### 4.3 EIRP Power Density

Measurement Procedure: FCC KDB 971168 D01 V03r01 Section 5.3

#### Test Settings

1. Set instrument center frequency to OBW center frequency.
2. Set span to at least 1.5 times the OBW.
3. Set the RBW to the specified reference bandwidth (often 1 MHz).
4. Set VBW  $\geq 3 \times$  RBW.
5. Detector = RMS (power averaging).
6. Ensure that the number of measurement points in the sweep  $\geq 2 \times$  span/RBW.
7. Sweep time = auto couple.
8. Employ trace averaging (RMS) mode over a minimum of 100 traces.
9. Use the peak marker function to determine the maximum amplitude level within the reference bandwidth (PSD).



SGS-CSTC Standards Technical Services Co., Ltd.  
 Shenzhen Branch Inspection & Testing Services Laboratory

Unless otherwise agreed in writing, this document is issued by the Company subject to its General Conditions of Service printed overleaf, available on request or accessible at <https://www.sgs.com/en/Terms-and-Conditions>. Attention is drawn to the limitation of liability, indemnification and jurisdiction issues defined therein. Any holder of this document is advised that information contained hereon reflects the Company's findings at the time of its intervention only and within the limits of Client's instructions, if any. The Company's sole responsibility is to its Client and this document does not exonerate parties to a transaction from exercising all their rights and obligations under the transaction documents. This document cannot be reproduced except in full, without prior written approval of the Company. Any unauthorized alteration, forgery or falsification of the content or appearance of this document is unlawful and offenders may be prosecuted to the fullest extent of the law. Unless otherwise stated the results shown in this test report refer only to the sample(s) tested and such sample(s) are retained for 30 days only.

Attention: To check the authenticity of testing /inspection report & certificate, please contact us at telephone: (86-755) 8307 1443, or email: CN.Doccheck@sgs.com

No.1 Workshop, M-10, Middle Section, Science & Technology Park, Nanshan District, Shenzhen, Guangdong, China 518057 t (86-755) 26012053 www.sgs.com.cn  
 中国·广东·深圳市南山区科技园中区M-10栋1号厂房 邮编: 518057 t (86-755) 26012053 sgs.china@sgs.com



Report No.: SZCR240200055101  
 Rev.: 01  
 Page: 40 of 53

## 4.4 Occupied Bandwidth

Measurement Procedure: FCC KDB 971168 D01 V03r01 Section 4.2 & 4.3

The occupied bandwidth, that is the frequency bandwidth such that, below its lower and above its upper frequency limits, the mean powers radiated are each equal to 0.5 percent of the total mean power radiated by a given emission shall be measured. The transmitter output was connected to a calibrated coaxial cable, attenuator and Spectrum analyser, the other end of which was connected to a Base Station Simulator. The Base Station Simulator was set to force the EUT to its maximum power setting. The tests were performed at three frequencies (low channel, middle channel and high channel). The span of the analyzer shall be set to capture all products of the modulation process, including the emission skirts. The resolution bandwidth shall be set to as close to 1 percent of the selected span as is possible without being below 1 percent. The video bandwidth shall be set to 3 times the resolution bandwidth. Video averaging is not permitted. Where practical, a sampling detector shall be used since a peak or, peak hold, may produce a wider bandwidth than actual. The trace data points are recovered and are directly summed in linear terms. The recovered amplitude data points, beginning at the lowest frequency, are placed in a running sum until 0.5 percent of the total is reached and that frequency recorded. The process is repeated for the highest frequency data points. This frequency is recorded. The span between the two recorded frequencies is the occupied bandwidth.

**Remark: Reference test setup 1**

### Test Settings

1. The signal analyzer's automatic bandwidth measurement capability was used to perform the 99% occupied bandwidth and the 26dB bandwidth. The bandwidth measurement was not influenced by any intermediate power nulls in the fundamental emission.
2. RBW = 1 – 5% of the expected OBW
3. VBW  $\geq 3 \times$  RBW
4. Detector = Peak
5. Trace mode = max hold
6. Sweep = auto couple
7. The trace was allowed to stabilize
8. If necessary, steps 2 – 7 were repeated after changing the RBW such that it would be within 1 – 5% of the 99% occupied bandwidth observed in Step 7



SGS-CSTC Standards Technical Services Co., Ltd.  
 Shenzhen Branch, Inspection & Testing Services  
 Shenzhen Branch, Inspection & Testing Services Laboratory

Unless otherwise agreed in writing, this document is issued by the Company subject to its General Conditions of Service printed overleaf, available on request or accessible at <https://www.sgs.com/en/Terms-and-Conditions>. Attention is drawn to the limitation of liability, indemnification and jurisdiction issues defined therein. Any holder of this document is advised that information contained hereon reflects the Company's findings at the time of its intervention only and within the limits of Client's instructions, if any. The Company's sole responsibility is to its Client and this document does not exonerate parties to a transaction from exercising all their rights and obligations under the transaction documents. This document cannot be reproduced except in full, without prior written approval of the Company. Any unauthorized alteration, forgery or falsification of the content or appearance of this document is unlawful and offenders may be prosecuted to the fullest extent of the law. Unless otherwise stated the results shown in this test report refer only to the sample(s) tested and such sample(s) are retained for 30 days only.  
 Attention: To check the authenticity of testing /inspection report & certificate, please contact us at telephone: (86-755) 8307 1443, or email: CN.Doccheck@sgs.com

No.1 Workshop, M-10, Middle Section, Science & Technology Park, Nanshan District, Shenzhen, Guangdong, China 518057 t (86-755) 26012053 www.sgsgroup.com.cn  
 中国·广东·深圳市南山区科技园中区M-10栋1号厂房 邮编: 518057 t (86-755) 26012053 sgs.china@sgs.com



Report No.: SZCR240200055101  
 Rev.: 01  
 Page: 41 of 53

## 4.5 Band Edge at Antenna Terminals

Measurement Procedure: FCC KDB 971168 D01 V03r01 Section 6.0

The transmitter output was connected to a calibrated coaxial cable, attenuator and Spectrum analyser, the other end of which was connected to a Base Station Simulator. The Base Station Simulator was set to force the EUT to its maximum power setting. The tests were performed at two frequencies (low channel and high channel), in the 1MHz bands immediately outside and adjacent to the frequency block a resolution bandwidth of 100kHz or 1% of the emission bandwidth of the fundamental emission of the transmitter may be employed. The EUT emission bandwidth is measured as the width of the signal between two points, outside of which all emission are attenuated at least 26dB below the transmitter power. The video bandwidth of the spectrum analyzer was set at thrice the resolution bandwidth. Detector Mode was set to rms.

### Remark: Reference test setup 1

#### Test Settings

1. Start and stop frequency were set such that the band edge would be placed in the center of the plot
2. Span was set large enough so as to capture all out of band emissions near the band edge
3.  $RBW \geq 1\%$  of the emission bandwidth
4.  $VBW \geq 3 \times RBW$
5. Detector = RMS
6. Number of sweep points  $\geq 2 \times \text{Span}/RBW$
7. Trace mode = trace average for continuous emissions, max hold for pulse emissions
8. Sweep time = auto couple
9. The trace was allowed to stabilize



SGS-CSTC Standards Technical Services Co., Ltd.  
 Shenzhen Branch

Unless otherwise agreed in writing, this document is issued by the Company subject to its General Conditions of Service printed overleaf, available on request or accessible at <https://www.sgs.com/en/Terms-and-Conditions>. Attention is drawn to the limitation of liability, indemnification and jurisdiction issues defined therein. Any holder of this document is advised that information contained hereon reflects the Company's findings at the time of its intervention only and within the limits of Client's instructions, if any. The Company's sole responsibility is to its Client and this document does not exonerate parties to a transaction from exercising all their rights and obligations under the transaction documents. This document cannot be reproduced except in full, without prior written approval of the Company. Any unauthorized alteration, forgery or falsification of the content or appearance of this document is unlawful and offenders may be prosecuted to the fullest extent of the law. Unless otherwise stated the results shown in this test report refer only to the sample(s) tested and such sample(s) are retained for 30 days only.  
 Attention: To check the authenticity of testing /inspection report & certificate, please contact us at telephone: (86-755) 8307 1443, or email: CN.Doccheck@sgs.com

No.1 Workshop, M-10, Middle Section, Science & Technology Park, Nanshan District, Shenzhen, Guangdong, China 518057 t (86-755) 26012053 www.sgs.com.cn  
 中国·广东·深圳市南山区科技园中区M-10栋1号厂房 邮编: 518057 t (86-755) 26012053 sgs.china@sgs.com



Report No.: SZCR240200055101  
 Rev.: 01  
 Page: 42 of 53

## 4.6 Spurious And Harmonic Emissions at Antenna Terminal

Measurement Procedure: FCC KDB 971168 D01 V03r01 Section 6.0

The transmitter output was connected to a calibrated coaxial cable, attenuator and Spectrum analyzer, the other end of which was connected to a Base Station Simulator. The Base Station Simulator was set to force the EUT to its maximum power setting. The tests were performed at three frequencies (low channel and high channel). The level of the carrier and the various conducted spurious and harmonic frequencies is measured by means of a calibrated spectrum analyzer. The spectrum is scanned from the lowest frequency generated in the equipment up to a frequency including its 10th harmonic. On any frequency outside a licensee's frequency block, the power of any emission shall be attenuated below the transmitter power (P) by at least  $43 + 10 \log(P)$  dB. Compliance with these provisions is based on the use of measurement instrumentation employing a resolution bandwidth of 1 MHz or greater. However, in the 1 MHz bands immediately outside and adjacent to the frequency block a resolution bandwidth of at least one percent of the emission bandwidth of the fundamental emission of the transmitter may be employed. The emission bandwidth is defined as the width of the signal between two points, one below the carrier center frequency and one above the carrier center frequency, outside of which all emission are attenuated at least 26 dB below the transmitter power.

### Remark: Reference test setup 1

#### Test Settings

1. Start frequency was set to 9kHz and stop frequency was set to at least 10\* the fundamental frequency (Separated into at least two plots per channel)
2. Detector = RMS
3. Trace mode = trace average for continuous emissions, max hold for pulse emissions
4. Sweep time = auto couple
5. The trace was allowed to stabilize
6. Please see test notes below for RBW and VBW settings



Unless otherwise agreed in writing, this document is issued by the Company subject to its General Conditions of Service printed overleaf, available on request or accessible at <https://www.sgs.com/en/Terms-and-Conditions>. Attention is drawn to the limitation of liability, indemnification and jurisdiction issues defined therein. Any holder of this document is advised that information contained hereon reflects the Company's findings at the time of its intervention only and within the limits of Client's instructions, if any. The Company's sole responsibility is to its Client and this document does not exonerate parties to a transaction from exercising all their rights and obligations under the transaction documents. This document cannot be reproduced except in full, without prior written approval of the Company. Any unauthorized alteration, forgery or falsification of the content or appearance of this document is unlawful and offenders may be prosecuted to the fullest extent of the law. Unless otherwise stated the results shown in this test report refer only to the sample(s) tested and such sample(s) are retained for 30 days only.

Attention: To check the authenticity of testing /inspection report & certificate, please contact us at telephone: (86-755) 8307 1443, or email: CN.Doccheck@sgs.com

No.1 Workshop, M-10, Middle Section, Science & Technology Park, Nanshan District, Shenzhen, Guangdong, China 518057 t (86-755) 26012053 www.sgs.com.cn  
 中国·广东·深圳市南山区科技园中区M-10栋1号厂房 邮编: 518057 t (86-755) 26012053 sgs.china@sgs.com





Report No.: SZCR240200055101  
 Rev.: 01  
 Page: 43 of 53

## 4.7 Peak-Average Ratio

Measurement Procedure: FCC KDB 971168 D01 V03r01 Section 5.7.2

A peak to average ratio measurement is performed at the conducted port of the EUT. For WCDMA signals, the spectrum analyzers Complementary Cumulative Distribution Function (CCDF) measurement profile is used to determine the largest deviation between the average and the peak power of the EUT in a given bandwidth. The CCDF curve shows how much time the peak waveform spends at or above a given average power level. The percent of time the signal spends at or above the level defines the probability for that particular power level. For GSM signals, an average and a peak trace are used on a spectrum analyzer to determine the largest deviation between the average and the peak power of the EUT in a bandwidth greater than the emission bandwidth. The traces are generated with the spectrum analyzer set to zero span mode.

**Remark: Reference test setup 1**

### Test Settings

1. The signal analyzer's CCDF measurement profile is enabled
2. Frequency = carrier center frequency
3. Measurement BW > Emission bandwidth of signal
4. The signal analyzer was set to collect one million samples to generate the CCDF curve
5. The measurement interval was set depending on the type of signal analyzed. For continuous signals (>98% duty cycle), the measurement interval was set to 1ms. For burst transmissions, the spectrum analyzer is set to use an internal "RF Burst" trigger that is synced with an incoming pulse and the measurement interval is set to less than the duration of the "on time" of one burst to ensure that energy is only captured during a time in which the transmitter is operating at maximum power



SGS-CSTC Standards Technical Services Co., Ltd.  
 Shenzhen Branch, Wireless Laboratory

Unless otherwise agreed in writing, this document is issued by the Company subject to its General Conditions of Service printed overleaf, available on request or accessible at <https://www.sgs.com/en/Terms-and-Conditions>. Attention is drawn to the limitation of liability, indemnification and jurisdiction issues defined therein. Any holder of this document is advised that information contained hereon reflects the Company's findings at the time of its intervention only and within the limits of Client's instructions, if any. The Company's sole responsibility is to its Client and this document does not exonerate parties to a transaction from exercising all their rights and obligations under the transaction documents. This document cannot be reproduced except in full, without prior written approval of the Company. Any unauthorized alteration, forgery or falsification of the content or appearance of this document is unlawful and offenders may be prosecuted to the fullest extent of the law. Unless otherwise stated the results shown in this test report refer only to the sample(s) tested and such sample(s) are retained for 30 days only.  
**Attention: To check the authenticity of testing /inspection report & certificate, please contact us at telephone: (86-755) 8307 1443, or email: CN.Doccheck@sgs.com**

No.1 Workshop, M-10, Middle Section, Science & Technology Park, Nanshan District, Shenzhen, Guangdong, China 518057 t (86-755) 26012053 www.sgs.com.cn  
 中国·广东·深圳市南山区科技园中区M-10栋1号厂房 邮编: 518057 t (86-755) 26012053 sgs.china@sgs.com





Report No.: SZCR240200055101  
 Rev.: 01  
 Page: 44 of 53

## 4.8 Field Strength of Spurious Radiation

Measurement Procedure: FCC KDB 971168 D01 V03r01 Section 5.8

### Below 1GHz test procedure as below:

- 1). The EUT was powered ON and placed on a 80cm high table in the chamber. The antenna of the transmitter was extended to its maximum length.
- 2). The disturbance of the transmitter was maximized on the test receiver display by raising and lowering from 1m to 4m (for the test frequency of below 30MHz, the antenna was tuned to heights 1 meter) the receive antenna and by rotating through 360° the turntable. After the fundamental emission was maximized, a field strength measurement was made.
- 3). Steps 1) and 2) were performed with the EUT and the receive antenna in both vertical and horizontal polarization.
- 4). Test the EUT in the lowest channel, the middle channel ,the Highest channel.
- 5). The radiation measurements are performed in X, Y, Z axis positioning. And found the X axis positioning which it is worse case, Only the test worst case mode is recorded in the report.
- 6). Repeat above procedures until all frequencies measured was complete.

$$E \text{ (dB}\mu\text{V/m)} = \text{Measured amplitude level (dB}\mu\text{V)} + (\text{Cable Loss (dB)} + \text{Antenna Factor (dB/m)} - \text{AMP(dB)})$$

$$\text{EIRP (dBm)} = E \text{ (dB}\mu\text{V/m)} + 20 \log D - 104.8; \text{ where D is the measurement distance in meters}$$

### Above 1GHz test procedure as below:

- 1) Different between above is the test site, change from Semi- Anechoic Chamber to fully Anechoic Chamber
- 2) Calculate power in dBm by the following formula:  

$$E \text{ (dB}\mu\text{V/m)} = \text{Measured amplitude level (dB}\mu\text{V)} + (\text{Cable Loss (dB)} + \text{Antenna Factor (dB/m)} - \text{AMP(dB)})$$

$$\text{EIRP (dBm)} = E \text{ (dB}\mu\text{V/m)} + 20 \log D - 104.8; \text{ where D is the measurement distance in meters}$$
- 3). Test the EUT in the lowest channel, the middle channel the Highest channel
- 4). The radiation measurements are performed in X, Y, Z axis positioning. And found the X axis positioning which it is worse case, Only the test worst case mode is recorded in the report.
- 5). Repeat above procedures until all frequencies measured was complete

Remark1: Reference test setup 2

Remark2: The emission below 18G were measured at a 3m test distance, while emissions above 18GHz were measured at a 1m test distance. At a measurement distance of 1 meter the limit line was increased by  $20 \cdot \text{LOG}(3/1) = 9.54 \text{ dB}$ .

### Remark: Reference test setup 2

Remark:

- 1) The field strength is calculated by adding the Antenna Factor, Cable Factor & AMP. The basic equation with a sample calculation is as follows:

AF = Antenna Factor(dB/m)

Factor = Cable Factor(dB) - Pre-amplifier (dB)

Level = Reading Level + AF + Factor -95.26

Margin = Limit – Level

- 2) Scan from 9kHz to 40GHz, The disturbance between 9KHz to 30MHz and 18GHz to 40GHz was very low, and the harmonics were the highest point could be found when testing, so only the harmonics had been displayed. The amplitude of spurious emissions from the radiator which are attenuated more than 20dB below the limit need not be reported.

- 3) All modes have been tested, but only the worst case data displayed in this report.



Unless otherwise agreed in writing, this document is issued by the Company subject to its General Conditions of Service printed overleaf, available on request or accessible at <https://www.sgs.com/en/Terms-and-Conditions>. Attention is drawn to the limitation of liability, indemnification and jurisdiction issues defined therein. Any holder of this document is advised that information contained hereon reflects the Company's findings at the time of its intervention only and within the limits of Client's instructions, if any. The Company's sole responsibility is to its Client and this document does not exonerate parties to a transaction from exercising all their rights and obligations under the transaction documents. This document cannot be reproduced except in full, without prior written approval of the Company. Any unauthorized alteration, forgery or falsification of the content or appearance of this document is unlawful and offenders may be prosecuted to the fullest extent of the law. Unless otherwise stated the results shown in this test report refer only to the sample(s) tested and such sample(s) are retained for 30 days only.  
 Attention: To check the authenticity of testing /inspection report & certificate, please contact us at telephone: (86-755) 8307 1443, or email: CN.Doccheck@sgs.com

No.1 Workshop, M-10, Middle Section, Science & Technology Park, Nanshan District, Shenzhen, Guangdong, China 518057 t (86-755) 26012053 www.sgsgroup.com.cn  
 中国·广东·深圳市南山区科技园中区M-10栋1号厂房 邮编: 518057 t (86-755) 26012053 sgs.china@sgs.com



Report No.: SZCR240200055101  
 Rev.: 01  
 Page: 45 of 53

## 4.9 Frequency Stability / Temperature Variation

Measurement Procedure:

Frequency stability testing is performed in accordance with the guidelines of FCC KDB 971168 D01 V03r01; Section 9

. The frequency stability of the transmitter is measured by:

- a.) **Temperature:** The temperature is varied from -30°C to +50°C in 10°C increments using an environmental chamber.
- b.) **Primary Supply Voltage:** The primary supply voltage is varied from 85% to 115% of the nominal value for non hand-carried battery and AC powered equipment. For hand-carried, battery-powered equipment, primary supply voltage is reduced to the battery operating end point which shall be specified by the manufacturer.

Specification – The frequency stability shall be sufficient to ensure that the fundamental emission stays within the authorized frequency block. The frequency stability of the transmitter shall be maintained within  $\pm 0.00025\%$  ( $\pm 2.5$  ppm ) of the center frequency.

### Time Period and Procedure:

1. The carrier frequency of the transmitter is measured at room temperature (20°C to provide a reference).
2. The equipment is turned on in a “standby” condition for fifteen minutes before applying power to the transmitter. Measurement of the carrier frequency of the transmitter is made within one minute after applying power to the transmitter.
3. Frequency measurements are made at 10°C intervals ranging from -30°C to +50°C. A period of at least one half-hour is provided to allow stabilization of the equipment at each temperature level.

### Remark: Reference test setup 3



Unless otherwise agreed in writing, this document is issued by the Company subject to its General Conditions of Service printed overleaf, available on request or accessible at <https://www.sgs.com/en/Terms-and-Conditions>. Attention is drawn to the limitation of liability, indemnification and jurisdiction issues defined therein. Any holder of this document is advised that information contained hereon reflects the Company's findings at the time of its intervention only and within the limits of Client's instructions, if any. The Company's sole responsibility is to its Client and this document does not exonerate parties to a transaction from exercising all their rights and obligations under the transaction documents. This document cannot be reproduced except in full, without prior written approval of the Company. Any unauthorized alteration, forgery or falsification of the content or appearance of this document is unlawful and offenders may be prosecuted to the fullest extent of the law. Unless otherwise stated the results shown in this test report refer only to the sample(s) tested and such sample(s) are retained for 30 days only.

Attention: To check the authenticity of testing /inspection report & certificate, please contact us at telephone: (86-755) 8307 1443, or email: CN.Doccheck@sgs.com

SGS-CSTC Standards Technical Services Co., Ltd.  
 Shenzhen Branch Inspection & Testing Services  
 Shenzhen Branch Wireless Laboratory

No.1 Workshop, M-10, Middle Section, Science & Technology Park, Nanshan District, Shenzhen, Guangdong, China 518057 t (86-755) 26012053 www.sgs.com.cn  
 中国·广东·深圳市南山区科技园中区M-10栋1号厂房 邮编: 518057 t (86-755) 26012053 sgs.china@sgs.com



### 4.10 Test Setups

#### 4.10.1 Test Setup 1

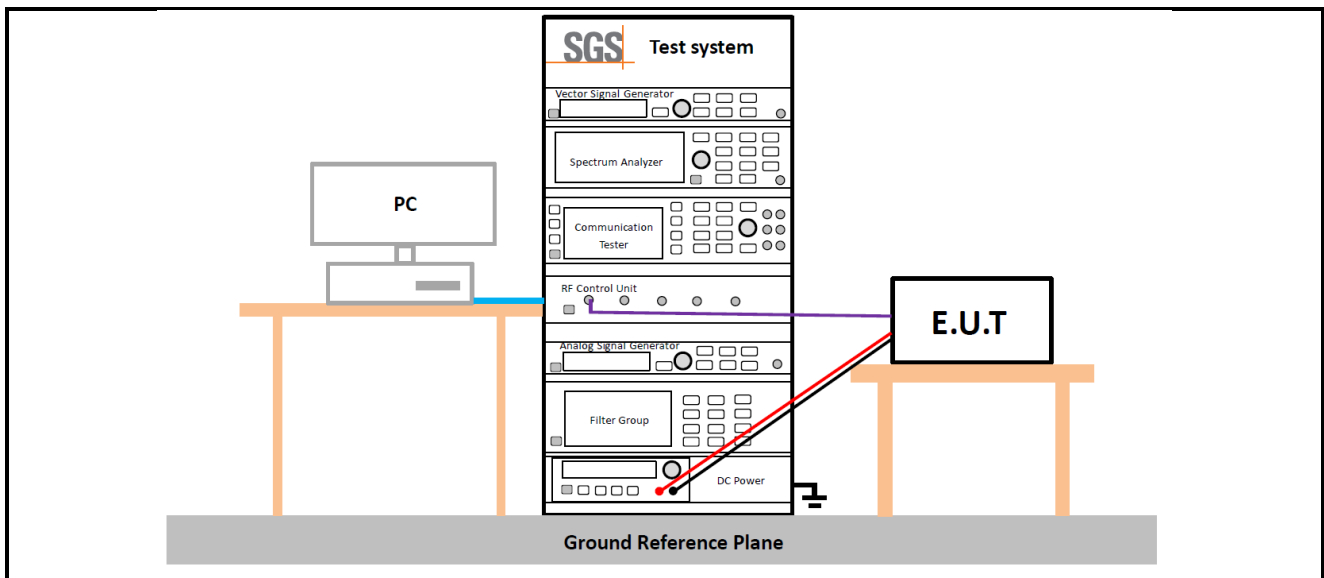

#### 4.10.2 Test Setup 2

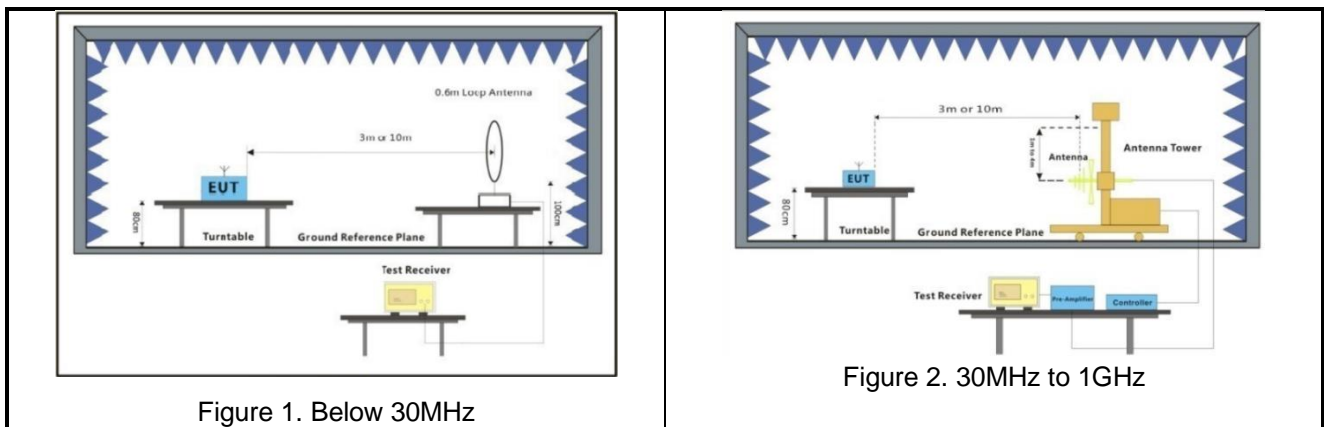

Figure 1. Below 30MHz

Figure 2. 30MHz to 1GHz



Unless otherwise agreed in writing, this document is issued by the Company subject to its General Conditions of Service printed overleaf, available on request or accessible at <https://www.sgs.com/en/Terms-and-Conditions>. Attention is drawn to the limitation of liability, indemnification and jurisdiction issues defined therein. Any holder of this document is advised that information contained hereon reflects the Company's findings at the time of its intervention only and within the limits of Client's instructions, if any. The Company's sole responsibility is to its Client and this document does not exonerate parties to a transaction from exercising all their rights and obligations under the transaction documents. This document cannot be reproduced except in full, without prior written approval of the Company. Any unauthorized alteration, forgery or falsification of the content or appearance of this document is unlawful and offenders may be prosecuted to the fullest extent of the law. Unless otherwise stated the results shown in this test report refer only to the sample(s) tested and such sample(s) are retained for 30 days only.  
**Attention: To check the authenticity of testing /inspection report & certificate, please contact us at telephone: (86-755) 8307 1443, or email: CN.Doccheck@sgs.com**  
 No.1 Workshop, M-10, Middle Section, Science & Technology Park, Nanshan District, Shenzhen, Guangdong, China 518057 t (86-755) 26012053 www.sgs.com.cn  
 中国·广东·深圳市南山区科技园中区M-10栋1号厂房 邮编: 518057 t (86-755) 26012053 sgs.china@sgs.com



**SGS-CSTC Standards Technical Services Co., Ltd.  
Shenzhen Branch**

Report No.: SZCR240200055101  
Rev.: 01  
Page: 47 of 53

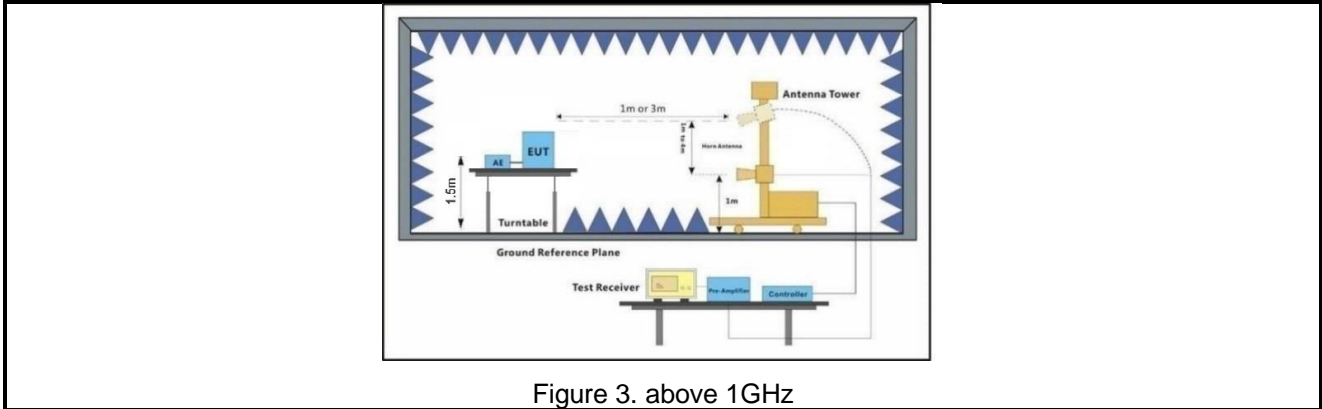
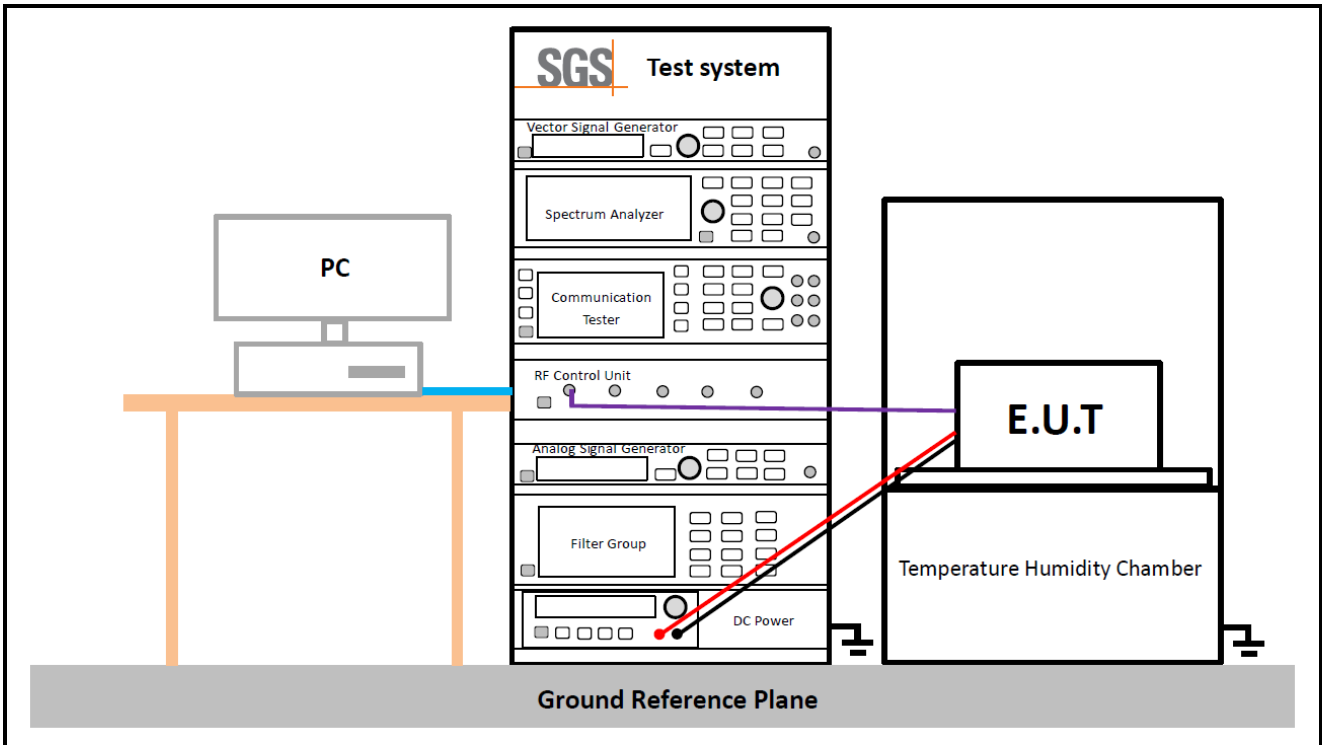

Figure 3. above 1GHz

**4.10.3 Test Setup 3**



Unless otherwise agreed in writing, this document is issued by the Company subject to its General Conditions of Service printed overleaf, available on request or accessible at <https://www.sgs.com/en/Terms-and-Conditions>. Attention is drawn to the limitation of liability, indemnification and jurisdiction issues defined therein. Any holder of this document is advised that information contained hereon reflects the Company's findings at the time of its intervention only and within the limits of Client's instructions, if any. The Company's sole responsibility is to its Client and this document does not exonerate parties to a transaction from exercising all their rights and obligations under the transaction documents. This document cannot be reproduced except in full, without prior written approval of the Company. Any unauthorized alteration, forgery or falsification of the content or appearance of this document is unlawful and offenders may be prosecuted to the fullest extent of the law. Unless otherwise stated the results shown in this test report refer only to the sample(s) tested and such sample(s) are retained for 30 days only.  
**Attention: To check the authenticity of testing /inspection report & certificate, please contact us at telephone: (86-755) 8307 1443, or email: CN.Doccheck@sgs.com**

No.1 Workshop, M-10, Middle Section, Science & Technology Park, Nanshan District, Shenzhen, Guangdong, China 518057 t (86-755) 26012053 www.sgs.com.cn  
中国·广东·深圳市南山区科技园中区M-10栋1号厂房 邮编: 518057 t (86-755) 26012053 sgs.china@sgs.com





# SGS-CSTC Standards Technical Services Co., Ltd. Shenzhen Branch

Report No.: SZCR240200055101  
Rev.: 01  
Page: 48 of 53

## 4.11 Test Conditions

Transmit Output Power Data - Average Power, Spectral Density	
Test Case	Test Conditions
Test Environment	Ambient Climate & Rated Voltage
Test Setup	Test Setup 1
RF Channels (TX)	L, M, H (L= low channel, M= middle channel, H= high channel)
Test Mode	LTE/TM1;LTE/TM2; LTE/TM3
Peak-to-Average Ratio	
Test Case	Test Conditions
Test Environment	Ambient Climate & Rated Voltage
Test Setup	Test Setup 1
RF Channels (TX)	L, M, H (L= low channel, M= middle channel, H= high channel)
Test Mode	LTE/TM1;LTE/TM2; LTE/TM3
Bandwidth - Occupied Bandwidth	
Test Case	Test Conditions
Test Environment	Ambient Climate & Rated Voltage
Test Setup	Test Setup 1
RF Channels (TX)	L, M, H (L= low channel, M= middle channel, H= high channel )
Test Mode	LTE/TM1;LTE/TM2; LTE/TM3
Bandwidth - Emission Bandwidth	
Test Case	Test Conditions
Test Environment	Ambient Climate & Rated Voltage
Test Setup	Test Setup 1
RF Channels (TX)	L, M, H (L= low channel, M= middle channel, H= high channel )
Test Mode	LTE/TM1;LTE/TM2; LTE/TM3
Adjacent Channel Leakage Ratio	
Test Case	Test Conditions
Test Environment	Ambient Climate & Rated Voltage
Test Setup	Test Setup 1
RF Channels (TX)	L, M, H (L= low channel, M= middle channel, H= high channel )



Unless otherwise agreed in writing, this document is issued by the Company subject to its General Conditions of Service printed overleaf, available on request or accessible at <https://www.sgs.com/en/Terms-and-Conditions>. Attention is drawn to the limitation of liability, indemnification and jurisdiction issues defined therein. Any holder of this document is advised that information contained hereon reflects the Company's findings at the time of its intervention only and within the limits of Client's instructions, if any. The Company's sole responsibility is to its Client and this document does not exonerate parties to a transaction from exercising all their rights and obligations under the transaction documents. This document cannot be reproduced except in full, without prior written approval of the Company. Any unauthorized alteration, forgery or falsification of the content or appearance of this document is unlawful and offenders may be prosecuted to the fullest extent of the law. Unless otherwise stated the results shown in this test report refer only to the sample(s) tested and such sample(s) are retained for 30 days only.  
**Attention: To check the authenticity of testing /inspection report & certificate, please contact us at telephone: (86-755) 8307 1443, or email: CN.Doccheck@sgs.com**

No.1 Workshop, M-10, Middle Section, Science & Technology Park, Nanshan District, Shenzhen, Guangdong, China 518057 t (86-755) 26012053 www.sgsgroup.com.cn  
中国·广东·深圳市南山区科技园中区M-10栋1号厂房 邮编: 518057 t (86-755) 26012053 sgs.china@sgs.com





# SGS-CSTC Standards Technical Services Co., Ltd. Shenzhen Branch

Report No.: SZCR240200055101  
Rev.: 01  
Page: 49 of 53

Test Mode	LTE/TM1;LTE/TM2; LTE/TM3
<b>Band Edges Compliance</b>	
Test Case	Test Conditions
Test Environment	Ambient Climate & Rated Voltage
Test Setup	Test Setup 1
RF Channels (TX)	L, H (L= low channel, H= high channel)
Test Mode	LTE/TM1;LTE/TM2; LTE/TM3
<b>Spurious Emission at Antenna Terminals</b>	
Test Case	Test Conditions
Test Environment	Ambient Climate & Rated Voltage
Test Setup	Test Setup 1
RF Channels (TX)	L, M, H (L= low channel, M= middle channel, H= high channel)
Test Mode	LTE/TM1;LTE/TM2; LTE/TM3
<b>Field Strength of Spurious Radiation</b>	
Test Case	Test Conditions
Test Environment	Ambient Climate & Rated Voltage
Test Setup	Test Setup 2
RF Channels (TX)	L, M, H (L= low channel, M= middle channel, H= high channel)
Test Mode	LTE/TM1 Remark: All bandwidth and modulation of LTE have been pre tested, and only the worst results are reflected in the report.
<b>Frequency Stability</b>	
Test Case	Test Conditions
Test Environment	(1) -30 °C to +50 °C with step 10 °C at Rated Voltage (2) VL, VN and VH of Rated Voltage at Ambient Climate.
Test Setup	Test Setup 3
RF Channels (TX)	M (M= middle channel)
Test Mode	LTE/TM1;LTE/TM2; LTE/TM3 The report only show the bandwidth with the worst case.



SGS-CSTC Standards Technical Services Co., Ltd.  
Shenzhen Branch  
Wireless Laboratory

Unless otherwise agreed in writing, this document is issued by the Company subject to its General Conditions of Service printed overleaf, available on request or accessible at <https://www.sgs.com/en/Terms-and-Conditions>. Attention is drawn to the limitation of liability, indemnification and jurisdiction issues defined therein. Any holder of this document is advised that information contained hereon reflects the Company's findings at the time of its intervention only and within the limits of Client's instructions, if any. The Company's sole responsibility is to its Client and this document does not exonerate parties to a transaction from exercising all their rights and obligations under the transaction documents. This document cannot be reproduced except in full, without prior written approval of the Company. Any unauthorized alteration, forgery or falsification of the content or appearance of this document is unlawful and offenders may be prosecuted to the fullest extent of the law. Unless otherwise stated the results shown in this test report refer only to the sample(s) tested and such sample(s) are retained for 30 days only.  
**Attention: To check the authenticity of testing /inspection report & certificate, please contact us at telephone: (86-755) 8307 1443, or email: CN.Doccheck@sgs.com**

No.1 Workshop, M-10, Middle Section, Science & Technology Park, Nanshan District, Shenzhen, Guangdong, China 518057 t (86-755) 26012053 www.sgs.com.cn  
中国·广东·深圳市南山区科技园中区M-10栋1号厂房 邮编: 518057 t (86-755) 26012053 sgs.china@sgs.com



# SGS-CSTC Standards Technical Services Co., Ltd. Shenzhen Branch

Report No.: SZCR240200055101  
Rev.: 01  
Page: 50 of 53

## 5 Main Test Instruments

RF conducted test					
Test Equipment	Manufacturer	Model No.	Inventory No.	Cal. Date	Cal. Due date
Programmable DC Source	Chroma	62024P-80-60	SEM011-09	2023/07/11	2024/07/10
Programmable Temperature & Humidity Chamber	Votsch Industrietechnik GmbH	VT 4002	SEM002-15	2023/03/21	2024/03/20
				2024/03/20	2025/03/19
Spectrum Analyzer	Rohde & Schwarz	FSV40	SEM008-04	2023/03/20	2024/03/19
				2024/03/15	2025/03/14
Measurement Software	TST	TST PASS V2.0	N/A	N/A	N/A
Attenuator	Huber+Suhner	6620_SMA-50-1	SEM021-09	2023/07/11	2024/07/10
Universal Radio Communication Tester	Rohde & Schwarz	CMW 500	SEM010-03	2023/03/28	2024/03/27
				2024/03/14	2025/03/15
Power Sensor	KEYSIGHT	U2021XA	SEM009-15	2023/03/21	2024/03/20
				2024/03/20	2025/03/19



SGS-CSTC Standards Technical Services Co., Ltd.  
Shenzhen Branch Inspection & Testing Services  
Shenzhen Branch Wireless Laboratory

Unless otherwise agreed in writing, this document is issued by the Company subject to its General Conditions of Service printed overleaf, available on request or accessible at <https://www.sgs.com/en/Terms-and-Conditions>. Attention is drawn to the limitation of liability, indemnification and jurisdiction issues defined therein. Any holder of this document is advised that information contained hereon reflects the Company's findings at the time of its intervention only and within the limits of Client's instructions, if any. The Company's sole responsibility is to its Client and this document does not exonerate parties to a transaction from exercising all their rights and obligations under the transaction documents. This document cannot be reproduced except in full, without prior written approval of the Company. Any unauthorized alteration, forgery or falsification of the content or appearance of this document is unlawful and offenders may be prosecuted to the fullest extent of the law. Unless otherwise stated the results shown in this test report refer only to the sample(s) tested and such sample(s) are retained for 30 days only.  
**Attention: To check the authenticity of testing /inspection report & certificate, please contact us at telephone: (86-755) 8307 1443, or email: CN.Doccheck@sgs.com**

No.1 Workshop, M-10, Middle Section, Science & Technology Park, Nanshan District, Shenzhen, Guangdong, China 518057 t (86-755) 26012053 www.sgs.com.cn  
中国·广东·深圳市南山区科技园中区M-10栋1号厂房 邮编: 518057 t (86-755) 26012053 sgs.china@sgs.com



# SGS-CSTC Standards Technical Services Co., Ltd. Shenzhen Branch

Report No.: SZCR240200055101  
Rev.: 01  
Page: 51 of 53

RE in Chamber					
Test Equipment	Manufacturer	Model No.	Inventory No.	Cal. Date	Cal. Due date
Trilog-Broadband Antenna	Schwarzbeck	VULB9168	SEM003-33	2021/09/25	2024/09/24
MXE EMI receiver	Agilent	N9038A	SEM004-05	2023/07/11	2024/07/10
Pre-amplifier	HP	8447D	SEM005-02	2023/07/11	2024/07/10
Spectrum Analyzer	Rohde & Schwarz	101288	SEM004-08	2023/07/11	2024/07/10
Low Noise Amplifier	CLAVIIO	BDLNA-0118-352810	SEM005-05	2023/07/11	2024/07/10
Substitution Antenna	Schwarzbeck	VULB9168	SEM003-18	2022/08/07	2025/08/06
Signal Generator(9kHz-40GHz)	N5173B	MY53270267	Agilent	2023/07/11	2024/07/10
Pre-amplifier	HP	8447D	SEM005-02	2023/07/11	2024/07/10
Broad-Band Horn Antenna	Schwarzbeck	BBHA 9170	SEM003-15	2021/07/11	2024/07/10
Broad-Band Horn Antenna	Schwarzbeck	BBHA 9120D	SEM003-32	2021/09/26	2024/09/25
Double-ridged waveguide horn	ETS-LINDGREN	3117	SEM003-34	2021/09/25	2024/09/24
Spectrum Analyzer	Rohde & Schwarz	101288	SEM004-08	2023/07/11	2024/07/10
Low Noise Amplifier	CLAVIIO	BDLNA-0118-352810	SEM005-05	2023/07/11	2024/07/10
Pre-amplifier	Compliance Directions Systems Inc.	PAP-2640-50	SEM005-08	2023/07/11	2024/07/10
Pre-amplifier	Rohde & Schwarz	CH14-H052	SEM005-17	2023/07/11	2024/07/10
Substitution Antenna	ETS-Lindgren	3142C	SEM003-01	2023/06/25	2026/06/24
Universal Radio Communication Tester	Rohde & Schwarz	CMW 500	SEM010-03	2023/03/28	2024/03/27
				2024/03/14	2025/03/13

General used equipment					
Equipment	Manufacturer	Model No.	Inventory No.	Cal Date	Cal Due Date
Humidity/ Temperature Indicator	deli	8838	SEM002-32	2023/07/28	2024/07/27
Humidity/ Temperature Indicator	deli	8838	SEM002-33	2023/07/28	2024/07/27
Barometer	Changchun Meteorological Industry Factory	DYM3	SEM002-01	2023/03/23	2024/03/22
				2024/03/18	2025/03/17



Unless otherwise agreed in writing, this document is issued by the Company subject to its General Conditions of Service printed overleaf, available on request or accessible at <https://www.sgs.com/en/Terms-and-Conditions>. Attention is drawn to the limitation of liability, indemnification and jurisdiction issues defined therein. Any holder of this document is advised that information contained hereon reflects the Company's findings at the time of its intervention only and within the limits of Client's instructions, if any. The Company's sole responsibility is to its Client and this document does not exonerate parties to a transaction from exercising all their rights and obligations under the transaction documents. This document cannot be reproduced except in full, without prior written approval of the Company. Any unauthorized alteration, forgery or falsification of the content or appearance of this document is unlawful and offenders may be prosecuted to the fullest extent of the law. Unless otherwise stated the results shown in this test report refer only to the sample(s) tested and such sample(s) are retained for 30 days only.

Attention: To check the authenticity of testing /inspection report & certificate, please contact us at telephone: (86-755) 8307 1443, or email: CN.Doccheck@sgs.com

No.1 Workshop, M-10, Middle Section, Science & Technology Park, Nanshan District, Shenzhen, Guangdong, China 518057 t (86-755) 26012053 www.sgs.com.cn  
中国·广东·深圳市南山区科技园中区M-10栋1号厂房 邮编: 518057 t (86-755) 26012053 sgs.china@sgs.com



Report No.: SZCR240200055101  
 Rev.: 01  
 Page: 52 of 53

## 6 Measurement Uncertainty

For a 95% confidence level ( $k = 2$ ), the measurement expanded uncertainties for defined systems, in accordance with the recommendations of ISO 17025 as following:

No.	Item	Measurement Uncertainty
1	Radio Frequency	$\pm 5.4 \times 10^{-8}$
2	Duty cycle	$\pm 0.3\%$
3	Occupied Bandwidth	$\pm 3\%$
4	RF conducted power	$\pm 0.8\text{dB}$
5	RF power density	$\pm 0.4\text{dB}$
6	Conducted Spurious emissions	$\pm 2.7\text{dB}$
7	Radiated Spurious emission test(UE)	$\pm 3.1\text{dB}$ (Below 1GHz)
		$\pm 4.4\text{dB}$ (Above 1GHz)

Remark:  
 The  $U_{\text{lab}}$  (lab Uncertainty) is less than  $U_{\text{CISPR/ETSI}}$  (CISPR/ETSI Uncertainty), so the test results  
 – compliance is deemed to occur if no measured disturbance level exceeds the disturbance limit;  
 – non-compliance is deemed to occur if any measured disturbance level exceeds the disturbance limit.



SGS-CSTC Standards Technical Services Co., Ltd.  
 Shenzhen Branch / Wireless Laboratory

Unless otherwise agreed in writing, this document is issued by the Company subject to its General Conditions of Service printed overleaf, available on request or accessible at <https://www.sgs.com/en/Terms-and-Conditions>. Attention is drawn to the limitation of liability, indemnification and jurisdiction issues defined therein. Any holder of this document is advised that information contained hereon reflects the Company's findings at the time of its intervention only and within the limits of Client's instructions, if any. The Company's sole responsibility is to its Client and this document does not exonerate parties to a transaction from exercising all their rights and obligations under the transaction documents. This document cannot be reproduced except in full, without prior written approval of the Company. Any unauthorized alteration, forgery or falsification of the content or appearance of this document is unlawful and offenders may be prosecuted to the fullest extent of the law. Unless otherwise stated the results shown in this test report refer only to the sample(s) tested and such sample(s) are retained for 30 days only.  
**Attention: To check the authenticity of testing /inspection report & certificate, please contact us at telephone: (86-755) 8307 1443, or email: CN.Doccheck@sgs.com**

No.1 Workshop, M-10, Middle Section, Science & Technology Park, Nanshan District, Shenzhen, Guangdong, China 518057 t (86-755) 26012053 www.sgs.com.cn  
 中国·广东·深圳市南山区科技园中区M-10栋1号厂房 邮编: 518057 t (86-755) 26012053 sgs.china@sgs.com



# SGS-CSTC Standards Technical Services Co., Ltd. Shenzhen Branch

Report No.: SZCR240200055101  
Rev.: 01  
Page: 53 of 53

## 7 Appendixes

Appendix A.1	WWAN Setup Photos
Appendix B.1	LTE Band 2
Appendix B.2	LTE Band 4
Appendix B.3	LTE Band 5
Appendix B.4	LTE Band 7
Appendix B.5	LTE Band 12
Appendix B.6	LTE Band 13
Appendix B.7	LTE Band 14
Appendix B.8	LTE Band 17
Appendix B.9	LTE Band 25
Appendix B.10	LTE Band 26(814-824)
Appendix B.11	LTE Band 26(824-849)
Appendix B.12	LTE Band 30
Appendix B.13	LTE Band 38
Appendix B.14	LTE Band 41
Appendix B.15	LTE Band 42(3450-3550)
Appendix B.16	LTE Band 43(3700-3800)
Appendix B.17	LTE Band 48
Appendix B.18	LTE Band 66
Appendix B.19	LTE Band 71
Appendix B.40	LTE Band 42 _Part96
Appendix B.41	LTE Band 43 _Part96
Appendix B.42	LTE Band 26(814-849)

---End of Report---



SGS-CSTC Standards Technical Services Co., Ltd.  
Shenzhen Branch Wireless Laboratory

Unless otherwise agreed in writing, this document is issued by the Company subject to its General Conditions of Service printed overleaf, available on request or accessible at <https://www.sgs.com/en/Terms-and-Conditions>. Attention is drawn to the limitation of liability, indemnification and jurisdiction issues defined therein. Any holder of this document is advised that information contained hereon reflects the Company's findings at the time of its intervention only and within the limits of Client's instructions, if any. The Company's sole responsibility is to its Client and this document does not exonerate parties to a transaction from exercising all their rights and obligations under the transaction documents. This document cannot be reproduced except in full, without prior written approval of the Company. Any unauthorized alteration, forgery or falsification of the content or appearance of this document is unlawful and offenders may be prosecuted to the fullest extent of the law. Unless otherwise stated the results shown in this test report refer only to the sample(s) tested and such sample(s) are retained for 30 days only.  
**Attention: To check the authenticity of testing /inspection report & certificate, please contact us at telephone: (86-755) 8307 1443, or email: CN.Doccheck@sgs.com**

No.1 Workshop, M-10, Middle Section, Science & Technology Park, Nanshan District, Shenzhen, Guangdong, China 518057 t (86-755) 26012053 www.sgs.com.cn  
中国·广东·深圳市南山区科技园中区M-10栋1号厂房 邮编: 518057 t (86-755) 26012053 sgs.china@sgs.com