

# TU600B

## Technical Manual

Version 1.0, March 2022



## Content

|   |    |
|---|----|
| Content.....  | 2  |
| Introduction.....   | 9  |
| Related Information.....  | 9  |
| Safety first.....   | 9  |
| Simple Guidelines.....  | 9  |
| Do Not Operate Where Prohibited.....                                    | 9  |
| Interference.....   | 10 |
| Avoid Body Contact with Device during Operation.....                    | 10 |
| Qualified Service.....  | 10 |
| Accessories and Batteries.....  | 10 |
| Water-Resistance.....   | 10 |
| Detailed Safety Information.....  | 10 |
| Exposure to Radio Frequency Signals.....                                | 10 |
| Electronic Devices.....   | 11 |
| Pacemakers.....   | 11 |
| Other Medical Devices.....  | 11 |
| Vehicles.....   | 11 |
| Posted Facilities.....  | 12 |
| Aircrafts.....  | 12 |
| Potentially Explosive Atmospheres.....                                  | 12 |
| For Vehicles Equipped with an Airbag.....                               | 12 |
| Specific Human Absorption Rates (SAR).....                              | 12 |
| Battery Safety Information.....   | 13 |
| Automatic battery safety during operation.....                          | 13 |
| Delivered standard content.....   | 14 |
| Ready-to-Use, No Custom Programming Required.....                       | 14 |
| Cost-effective, Universally Available Communications.....               | 14 |
| Use location – Children not likely to be present.....                   | 15 |
| Practical installation advice.....                                      | 15 |
| Installation for insurance and anti-theft purpose.....                  | 15 |
| Connections.....  | 16 |
| Power supply.....   | 16 |
| Digital inputs.....   | 16 |
| Digital output.....   | 16 |
| Motion/acceleration sensor.....   | 16 |
| Installing the TU600B as to surpass the main switch on the machine..... | 17 |
| Functionality check.....  | 18 |
| “Verify my Trackunit”.....  | 19 |
| Troubleshooting.....  | 20 |
| Installation of the digital output.....                                 | 21 |
| SMS commands for output control.....                                    | 22 |
| Safety precautions.....   | 22 |
| Warranty.....   | 22 |
| Technical Assistance/Support and spare parts.....                       | 22 |
| Minimum Information Required for Technical Assistance.....              | 24 |

|  |           |
|--|-----------|
| Return Merchandise Authorization – RMA .....                       | 24        |
| <b>Specifications .....</b>  | <b>24</b> |
| Product specifications .....                                       | 24        |
| Connections:.....  | 24        |
| Internal temperature ranges: .....                                 | 25        |
| External temperature ranges: .....                                 | 25        |
| GSM/GPRS-specifications:.....                                      | 25        |
| LTE cat M1 / cat NB2 band - specifications: .....                  | 25        |
| Mechanical specifications .....                                    | 27        |
| <b>Approvals and certificates.....</b>                             | <b>28</b> |
| FCC and IC certification statements.....                           | 28        |
| Automotive, off-road vehicles, machinery etc.....                  | 29        |
| Statement for ISO 13849-1 safety .....                             | 29        |
| EU and UK regulations and directives.....                          | 30        |
| CE and UKCA marking.....   | 31        |
| PTCRB certification for interoperability with mobile networks..... | 31        |
| Bluetooth SIG registration .....                                   | 31        |
| <b>Specific country approval regulations and statements .....</b>  | <b>31</b> |
| Australia and New Zealand .....                                    | 31        |
| Japan .....  | 32        |
| Chile .....  | 32        |
| Mexico.....  | 32        |
| Brazil .....   | 33        |
| United Arab Emirates (UAE) .....                                   | 33        |
| <b>Specific model country approval certificates .....</b>          | <b>33</b> |
| Europe-CEPT .....  | 34        |
| UK .....   | 34        |
| Myanmar .....  | 34        |
| Macau .....  | 34        |
| Japan .....  | 34        |
| Australia .....  | 34        |
| New Zealand .....  | 34        |
| Singapore.....   | 34        |
| India .....  | 34        |
| Sri Lanka (In process) .....                                       | 34        |
| US .....   | 34        |
| Canada.....  | 34        |
| Chile .....  | 34        |
| Trinidad & Tobago.....   | 34        |
| El Salvador .....  | 34        |
| British Virgin Islands (BVI).....                                  | 34        |
| Jamaica .....  | 34        |
| Argentina .....  | 34        |
| Uruguay.....   | 34        |
| Bahamas .....  | 34        |
| Guatemala.....   | 34        |
| Peru.....  | 34        |
| Dominican Republic .....   | 34        |
| Ecuador.....   | 34        |
| Barbados.....  | 34        |

|                                  |    |
|----------------------------------|----|
| Belize .....                     | 34 |
| Bermuda.....                     | 34 |
| Dominica .....                   | 35 |
| Paraguay.....                    | 35 |
| Columbia .....                   | 35 |
| Guyana.....                      | 35 |
| Aruba.....                       | 35 |
| Panama.....                      | 35 |
| Bolivia.....                     | 35 |
| Honduras.....                    | 35 |
| Nicaragua (In process).....      | 35 |
| Mexico (In process).....         | 35 |
| Brazil (In process) .....        | 35 |
| Costa Rica.....                  | 35 |
| Morocco .....                    | 35 |
| Algeria .....                    | 35 |
| Madagascar .....                 | 35 |
| Ghana .....                      | 35 |
| Gambia.....                      | 35 |
| Zimbabwe.....                    | 35 |
| Botswana .....                   | 35 |
| Tanzania .....                   | 35 |
| Namibia (In process) .....       | 35 |
| South Africa.....                | 35 |
| Djibouti .....                   | 35 |
| Qatar .....                      | 35 |
| Kuwait .....                     | 36 |
| Oman .....                       | 36 |
| Israel .....                     | 36 |
| Turkey .....                     | 36 |
| Saudi Arabia.....                | 36 |
| Jordan .....                     | 36 |
| Lebanon (In process) .....       | 36 |
| Bahrain.....                     | 36 |
| Pakistan .....                   | 36 |
| Turkmenistan .....               | 36 |
| Uzbekistan .....                 | 36 |
| United Arab Emirates (UAE) ..... | 36 |
| Yemen (In process).....          | 36 |
| Environmental compliance.....    | 36 |

### Corporate Office

Trackunit APS  
 Gasvaerksvej 24, 4 sal  
 9000 Aalborg  
 Denmark.  
[www.trackunit.com](http://www.trackunit.com)

### Copyright and Trademarks

© 1998-2020, Trackunit APS. All rights reserved.  
 Trackunit, Trackunit logo and Trackunit are trademarks of Trackunit APS, registered in the United States and in other countries. All other trademarks are the property of their respective owners.

### Release Notice

This document is release v1.0 of the TU600B, Technical Manual.

THIS MANUAL IS INTENDED FOR USE BY SYSTEM INTEGRATORS, SERVICE PROVIDERS AND APPLICATION DEVELOPERS (COLLECTIVELY, "RESELLERS"). IT IS NOT INTENDED FOR END-USERS OF THE TU600B. ANY END-USER DOCUMENTATION IS TO BE PREPARED AND FURNISHED BY THE RESELLERS.

The following Product Limited Warranty gives Resellers specific legal rights. You may have others, which vary from state/jurisdiction to state/jurisdiction.

### Product Limited Warranty

Subject to the terms and conditions set forth herein, Trackunit APS ("Trackunit") makes the following warranty only to its Resellers who purchase the TU600B hardware product ("Product") directly from Trackunit: for a period of one (1) year from the date of shipment from Trackunit, the Product will substantially conform to Trackunit's standard published specifications for the Product and the Product hardware will be substantially free from defects in materials and workmanship. The foregoing warranty shall not apply to embedded software/firmware components.

THIS PRODUCT LIMITED WARRANTY IS PROVIDED TO RESELLERS AND TO RESELLERS ONLY. RESELLER IS SOLELY RESPONSIBLE FOR ANY AND ALL WARRANTIES MADE TO ITS CUSTOMERS, AND TRACKUNIT MAKES NO WARRANTIES, EXPRESS OR IMPLIED, AND SHALL HAVE NO OBLIGATIONS OR LIABILITY TO RESELLER'S CUSTOMERS OR END-USERS OF THE PRODUCT. RESELLER SHALL NOT MAKE ANY REPRESENTATIONS OR WARRANTIES ON TRACKUNIT'S BEHALF, AND SHALL FULLY INDEMNIFY, DEFEND AND HOLD TRACKUNIT HARMLESS FROM ANY BREACH OF THE FOREGOING. IF RESELLER DISTRIBUTES PRODUCT TO END-USER CUSTOMERS, RESELLER SHALL BE SOLELY RESPONSIBLE FOR PREPARING AND PROVIDING PRODUCT WARRANTIES AND PRODUCT LITERATURE TO END-USERS.

### Warranty Remedies

If the Product fails during the warranty period for reasons covered by this Product Limited Warranty and Reseller notifies Trackunit of such failure during the warranty period, Trackunit at its option will repair OR replace the nonconforming Product,

OR refund the purchase price paid by Reseller for the Product, provided that Reseller returns the Product to Trackunit in accordance with Trackunit's standard return material authorization procedures or as otherwise instructed by Trackunit.

### Warranty Exclusions and Disclaimers

The foregoing Product Limited Warranty shall only apply in the event and to the extent that (i) the Product is properly and correctly installed, configured, interfaced, maintained, stored and operated in accordance with Trackunit's specifications, and (ii) the Product is not modified or misused. This Product Limited Warranty shall not apply to, and Trackunit shall not be responsible for, defects or performance problems resulting from: (a) the combination or utilization of the Product with hardware or software products, information, data, systems, interfaces, services or devices not made, supplied or specified by Trackunit; (b) the operation of the Product under any specifications other than, or in addition to, Trackunit's standard published specifications for the Product; (c) the unauthorized installation, modification or use of the Product; (d) damage caused by: accident, lightning or other electrical discharge, water immersion or spray, or exposure to environmental conditions for which the Product is not intended; or (e) normal wear and tear on consumable parts, including by way of example and without limitation, batteries.

TRACKUNIT DOES NOT WARRANT OR GUARANTEE THE RESULTS OBTAINED THROUGH THE USE OF THE PRODUCT. THE FOREGOING TERMS OF THE PRODUCT LIMITED WARRANTY STATE TRACKUNIT'S ENTIRE LIABILITY, AND RESELLER'S EXCLUSIVE REMEDIES, RELATING TO THE USE AND PERFORMANCE OF THE PRODUCT EXCEPT AS OTHERWISE EXPRESSLY PROVIDED FOR IN THIS PRODUCT LIMITED WARRANTY, THE PRODUCT, ACCOMPANYING DOCUMENTATION AND MATERIALS, AND/OR ANY EMBEDDED SOFTWARE/FIRMWARE AND UPDATES THERETO ARE PROVIDED "AS-IS" AND WITHOUT EXPRESS OR IMPLIED WARRANTIES OF ANY KIND, BY EITHER TRACKUNIT OR ANYONE WHO HAS BEEN INVOLVED IN ITS CREATION, PRODUCTION, INSTALLATION OR DISTRIBUTION, INCLUDING, BUT NOT LIMITED TO, THE IMPLIED WARRANTIES OF MERCHANTABILITY AND FITNESS FOR A PARTICULAR PURPOSE, TITLE AND NONINFRINGEMENT. THE STATED EXPRESS WARRANTIES ARE IN LIEU OF ALL OBLIGATIONS OR LIABILITIES ON THE PART OF TRACKUNIT ARISING OUT OF, OR IN CONNECTION WITH, THE PRODUCT. WITHOUT LIMITING THE GENERALITY OF THE FOREGOING: TRACKUNIT IS NOT RESPONSIBLE FOR THE OPERATION OR FAILURE OF OPERATION OF GPS SATELLITES OR WIRELESS SERVICE OR THE AVAILABILITY OF GPS SATELLITE SIGNALS OR WIRELESS SERVICE. THE PRODUCT MAY CONTAIN TECHNOLOGY THAT IS NOT FAULT TOLERANT AND IS NOT DESIGNED, MANUFACTURED OR INTENDED FOR USE IN ENVIRONMENTS OR APPLICATIONS IN WHICH THE FAILURE OF THE PRODUCT WOULD LEAD TO DEATH, PERSONAL INJURY OR SEVERE PHYSICAL OR ENVIRONMENTAL DAMAGE OR SEVERE FINANCIAL LOSS. ANY USE OR DISTRIBUTION BY RESELLER OR ITS CUSTOMERS IN CONNECTION WITH ANY SUCH ENVIRONMENT OR APPLICATION SHALL BE AT

RESELLER'S AND ITS CUSTOMERS' SOLE RISK, AND TRACKUNIT SHALL HAVE NO LIABILITY WHATSOEVER IN CONNECTION THEREWITH. RESELLER SHALL INDEMNIFY AND HOLD TRACKUNIT AND ITS SUPPLIERS HARMLESS FROM ANY CLAIM BROUGHT AGAINST TRACKUNIT WHICH ARISES FROM RESELLER'S USE OR DISTRIBUTION OF THE PRODUCT IN CONNECTION WITH SUCH ENVIRONMENTS OR APPLICATIONS. SOME STATES AND JURISDICTIONS DO NOT ALLOW LIMITATIONS ON DURATION OR THE EXCLUSION OF AN IMPLIED WARRANTY, SO CERTAIN OF THE ABOVE LIMITATIONS MAY NOT APPLY TO EVERY RESELLER.

#### **Embedded Software/Firmware**

The Product and associated tools, if any, may contain embedded software/firmware, which is licensed, not sold, and is only for use within the Product as an integral part thereof. Such embedded software/firmware (which includes all updates thereto) contains valuable trade secrets and is proprietary to Trackunit and its suppliers. To the greatest extent permitted by law, such embedded software/firmware may not be modified, copied, disassembled, decompiled or reverse engineered. Trackunit reserves all other rights.

#### **Limitation of Liability**

TRACKUNIT'S ENTIRE LIABILITY REGARDING THE PRODUCT SHALL BE LIMITED TO THE AMOUNT ACTUALLY PAID BY RESELLER FOR THE PRODUCT. TO THE MAXIMUM EXTENT PERMITTED BY APPLICABLE LAW, IN NO EVENT SHALL TRACKUNIT OR ITS SUPPLIERS BE LIABLE FOR ANY INDIRECT, SPECIAL, INCIDENTAL OR CONSEQUENTIAL DAMAGES WHATSOEVER UNDER ANY CIRCUMSTANCE OR LEGAL THEORY RELATING IN ANY WAY TO THE PRODUCTS, ACCOMPANYING DOCUMENTATION AND MATERIALS, AND ANY EMBEDDED SOFTWARE/FIRMWARE AND UPDATES THERETO (INCLUDING, WITHOUT LIMITATION, DAMAGES FOR LOSS OF BUSINESS PROFITS, BUSINESS INTERRUPTION, LOSS OF DATA OR ANY OTHER PECUNIARY LOSS), REGARDLESS OF WHETHER TRACKUNIT HAS BEEN ADVISED OF THE POSSIBILITY OF ANY SUCH LOSS AND REGARDLESS OF THE COURSE OF DEALING BETWEEN TRACKUNIT AND RESELLER. BECAUSE SOME STATES AND JURISDICTIONS DO NOT ALLOW THE EXCLUSION OR LIMITATION OF LIABILITY FOR CONSEQUENTIAL OR INCIDENTAL DAMAGES, THE ABOVE LIMITATION MAY NOT APPLY TO EVERY RESELLER.

#### **Notices**

Class B Statement – Notice to Users. This equipment has been tested and found to comply with the limits for a Class B digital device, pursuant to Part 15 of the FCC rules. These limits are designed to provide reasonable protection against harmful interference in a residential installation. This equipment generates, uses, and can radiate radio frequency energy and, if not installed and used in accordance with the instructions, may cause harmful interference to radio communication. However, there is no guarantee that interference will not occur in a particular installation. If this equipment does cause harmful interference to radio or television reception, which can be determined by turning the equipment off and on, the user is encouraged to try to correct the interference by one or more of the following measures:

– Reorient or relocate the receiving antenna.

- Increase the separation between the equipment and the receiver.
- Consult the dealer or an experienced radio/TV technician for help.

Changes and modifications not expressly approved by the manufacturer or registrant of this equipment can void your authority to operate this equipment under Federal Communications Commission rules.

#### **Regulatory Approvals**

##### **CE**

The TU600B product comply with the essential requirements of the RED Directive 2014/53/EU as stated by the Declaration of Conformity (CE). The TU600B product comply with the European Telecommunications Standards Institute Specifications EN 301 489-1, EN 301489-17 (Bluetooth LE), EN 301 489-19 (GPSS/GNSS) and EN 301 489-52 (EMC for GPS, GSM 900MHz/1800MHz and LTE cat M1/NB2 700MHz/900MHz/1800MHz/2100MHz Radio Equipment and Systems).

##### **EU/ International/Automotive**

The TU600B product comply with the essential requirements of the UN regulative ECE R10 EMC rev5 clause 6.5, 6.6, 6.8 and 6.9,

The TU600B product comply with the essential requirements of the Directive 2006/42/EC, EU regulation 167/2013 and the Directive 2014/30/EU; with standards ISO-13766-1, -2 and EN ISO 14982, ISO 12895 for tractors, forest, and agricultural machinery, moving machinery, construction machinery, lifts, trucks etc.

- The product complies with the essential requirements of the 2011/65/EC directive and amendment 2015/863/EU on the restriction of the use of certain hazardous substances in electrical and electronic equipment (ROHS 3).
- The product complies with the essential requirements of the EC 1907/2006 regulation concerning the Registration, Evaluation, Authorization and Restriction of Chemicals (REACH).
- The product complies with the requirements of the 2012/19/EU directive on waste electrical and electronic equipment (WEEE).

##### **FCC**

The TU600B product comply with the FCC Part 15, Part 22, Part 24, Part 27, part 90 and the Industry Canada requirements RSS-102, RSS-132, RSS-133, RSS-139.

The TU600B product comply with Part 15 of the FCC rules and Industry Canada license exempt RSS standard(s). Operation is subject to the following two conditions: (1) This device may not cause harmful interference, and (2) This device must accept any interference received, including interference that may cause undesired operation.

For fixed mounted operations the TU600B must be installed to provide a separation distance of at least 20 cm from all persons.

##### **MIC (Japan)**

##### **(Shared with Quectel BG95-M3 module certificate):**

The TU600B product complies with the Japanese Telecommunication Business Act for radio terminal equipment supporting LTE M1 / NB IoT at 800, 1800, 2100 MHz (Band B18/B19, B3, B1) and Bluetooth LE (2402 – 2480 MHz).

**Bluetooth SIG registered:**  
 Declaration ID: **D050742**  
 Company identifier UUID: **2159 (0x086F)**

**Automotive:**  
 KBA UN ECE R10 rev 5/1 certified :

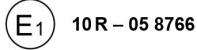

**Insurance and Pension (Tracking system):**  
 Denmark-FOP Control certificate:

### Europe:

**EU certificate:**  
 CE mark by EU-Tec certificate:



**United Kingdom (UK):**  
 UKCA mark by DOC



### Oceania:

**Australia SDOC approval:**  
 RCM mark by SDOC from E7689



**New Zealand approval:**  
 NZS mark by importer SDOC from local office.

### Asia:

#### **Japan certificates:**

**India:**  
 ETA-WPC Certificate number:

**Myanmar:**  
 N/A - Accept EU-TEC certificate upon request.

**Macau:**  
 CTT no certification required.

**Singapore:**  
 IMDA Certificate number: xxxx-xx / **DB107653**

### USA / CANADA

**US and Canada certificates:**  
 FCC ID: ZMF-TU600B  
 IC: 9746A-TU600B

**US - CTIA certificates:**  
 PTCRB ID:

### LATAM America

**El Salvador:**  
 CNAF Certificate number:

**Trinidad and Tobago:**  
 TATT approval number: **ZMF-TU600B**  
 (Recognized by FCC approval ID)

**British Virgin Islands (BVI):**  
 TRC Certificate number:

**Jamaica:**  
 SMA approval number: **ZMF-TU600B**  
 (Recognize by FF approval ID)

**Uruguay:**  
 URSEC Certificate number:

**Bahamas:**  
 URCA Certificate number:

**Guatemala:**  
 SIT Approval number:

**Peru:**  
 Homologation Certificate number:

**Dominican Republic:**  
 INDOTEL Certificate number:

**Ecuador:**  
 Certificate number:

**Barbados:**  
 MED Approval number:

**Belize:**  
 PUC Certificate number:

**Bermuda:**  
 BRA Bluetooth certificate number:  
 BRA Cellular certificate number:  
 (Accept FCC ID: ZMF-TU600B and CE mark)

**Columbia:**  
 CRC Certificate number:  
 (Approval of BG95-M3 in product with TAC: 86773005)  
 CRC Certificate number:  
 (Approval of BG95-M3 in product with TAC: 35361794)

**Dominica:**  
 NTRC Certificate number:

**Paraguay:**  
 CONATEL Certificate number:

**Argentina:**  
 ENACOM Certificate number:

**Guyana:**  
 TA Reference number:



TA approval number: **ZMF-TU600B**  
(Recognize by FCC approval ID)

**Aruba:**

DTZ Reference number:  
(Recognize FCC approval ID)

**Panama:**

ASEP Certificate number:

**Bolivia:**

ATT Certificate number:  
(Recognize FCC approval ID)

**Honduras:**

CONATEL homologation number:

**Chile:**

Exempted for IMEI listing due to roaming SIM card and fixed installation.

Este equipo cumple con la Resolución No 403 de 2008, de la Subsecretaría de telecomunicaciones, relativa a radiaciones electromagnéticas

**Mexico:**

(Product safety, Import)

ANCE NOM-019 Certificate number:

NOM-208 Certificate number:

NOM-221 Certificate number:

NOM-221 Certificate number:

IFETEL certificate number for permanent Radio approval:

**Número IFETEL:**

**Brazil:**

ibrace COC technical certificate number:

ANATEL certificate number:

**Costa Rica:**

SUTEL approval number:

**North Africa / Sub Sahara****Morocco:**

ANRT technical certificate:

**Algeria:**

ARPCE certificate number:

**Madagascar:**

ARTEC approval certificate

**Ghana:**

NCA approval certificate:

**Gambia:**

PURA approval certificate:

**Botswana:**

BOCRA certificate number:

**Zimbabwe:**

POTRAZ certificate number:

**Tanzania:**

TCRA certificate number:

**South Africa:**

ICASA certificate number:

**Djibouti:**

DDTIC certificate number:

**Middle East:****Turkey:**

*(Listed but import license acquired.)*

**Israel:**

MOC certificate/import license :

*(Individual import application required)*

**Jordan:**

TRC require import statement for showing compliance to TRC regulations by importing company. Trackunit letter available.

**Qatar:**

CRA approval certificate:

**Kuwait:**

CITRA certificate number:

**Oman:**

OMAN TRA certificate number:

**Saudi Arabia:**

CITC certificate number:

**Bahrain:**

TRA certificate number:

**United Arab Emirates (UAE):**

TDRA certificate number:

with dealer number

**Pakistan:**

TAC certificate number:

**Turkmenistan:**

TDS certificate number:

**Uzbekistan:**

OSTZ certificate number:



## Introduction

This document contains the installation guide for the (GSM / LTE cat-M1 / NB2-IOT / GNSS / BLE) product type series TU600B units. This manual is intended for use by system integrators, service providers and application developers (collectively, “Resellers”). It is not intended for end-users of the TU600B. Any end-user documentation is to be prepared and furnished by the resellers.

This manual covers the TU600B with 60.012 and later firmware operating on:

- 2G bands [850 MHz, 900 MHz, 1800 MHz and 1900 MHz] Global System for Mobile communication (GSM) networks.
- LTE bands [700 MHz, 800 MHz, 850 MHz, 900 MHz, 1700 MHz, 1800 MHz, 1900 MHz, 2100 MHz] LTE M1/NB2 IOT networks.
- Data and Event Reporting support is by Short Message Service (SMS), General Packet Radio Service (GPRS), or both.

This manual describes how to set up, configure, install, operate, and troubleshoot the product. Even if you have used other GSM, LTE cat-M1 / NB2- IOT or Global Positioning System (GPS) products before, Trackunit recommends that you spend some time reading this manual to learn about the special features of this product.

Trackunit assumes that you are familiar with Microsoft Windows.

## ***Related Information***

The Trackunit web site is found at [www.trackunit.com](http://www.trackunit.com). This site links to the fleet management system from Trackunit APS called Trackunit Manager. TU600B devices are integrated to Trackunit but can also be used together with third part system providers.

## **Safety first**

### ***Simple Guidelines***

Please follow these guidelines when configuring, using or recycling the TU600B. Violating these guidelines may be dangerous, illegal or otherwise detrimental. Further detailed information is provided in this manual.

### ***Do Not Operate Where Prohibited***

Do not allow the TU600B unit to operate wherever wireless phone use is prohibited or when doing so may cause interference or danger. The TU600B cannot be turned off after installation, so any vehicle, moving machinery, construction machinery using TU600B etc. must not enter areas where it is prohibited to operate wireless phones as the device periodically turns on the transmitter in a short period of time to perform tracking reporting.

Examples include but are not limited to operation in hospitals, aircrafts, near blasting sites or wherever operation can cause interference.

## ***Interference***

Like all wireless devices, the TU600B may encounter electrical interference that may affect its performance.

## ***Avoid Body Contact with Device during Operation***

Do not operate the TU600B in direct contact with your body. Maintain at least 8 inches (20 cm) separation between the device and any parts of your body.

## ***Qualified Service***

Except for batteries and Subscriber Identification Module (SIM) card, the TU600B contains no user serviceable or replaceable parts. Non-functioning units must be returned to an authorized service center for repair or replacement.

## ***Accessories and Batteries***

Use only Trackunit approved accessories or batteries. Do not connect incompatible products.

The battery package is a Trackunit design, no other battery designs are compatible with the battery holder of the TU600B. There is risk of explosion or fire if an incorrect type replacement battery is forced into the battery holder as contact may generate a short circuit. Additionally, the battery holder will be destroyed.

Do not exceed the temperature ranges or other environmental conditions specified by the battery manufacturer, see battery safety chapter below. Dispose of used batteries according to the instructions provided with the batteries.

## ***Water-Resistance***

The TU600B series is water-resistant according to the IP-67 standard. It is however recommended that it is be used where it is relatively dry and not subjected to either water streams or submersion. Mounted inside the HW shield a higher water-resistance level to IP-66k and IP 69k can be achieved.

## **Detailed Safety Information**

### ***Exposure to Radio Frequency Signals***

The TU600B unit is a low power radio transmitter and receiver. Periodically the TU600B wakes up either due to activity or by a timer. When it is ON, it receives and sends out radio frequency (RF) signals for a short period of time when awake.

**The TU600B unit cannot be turned off after installation; however, the unit is mostly asleep waiting for either the wake-up timer or activity on the acceleration sensor.**

**The unit operation can continue for approximately 3 to 4 days depending on the charging state of the backup battery.**

The TU600B unit is designed for vehicular use only.

### ***Electronic Devices***

Most modern electronic equipment is shielded from RF signals. However, certain electronic equipment may not be shielded against the RF signals generated by the TU600B unit.

### ***Pacemakers***

The Health Industry Manufacturers Association recommends that a minimum separation of six (6") inches be maintained between a handheld wireless phone and a pacemaker to avoid potential interference with the pacemaker. The following precautions apply:

- The TU600B unit is not intended for handheld use or to be worn on the body.
- It is always recommended that a minimum separation of 8" inches (20 cm) to be maintained between the TU600B unit and any persons' body after end user installation.

### ***Other Medical Devices***

If any other personal medical devices are used in the vicinity of a TU600B unit, consult the manufacturers of the medical devices to determine if they are adequately shielded from external RF energy. Physicians may be able to assist in obtaining this information.

The TU600B unit cannot be turned off after installation, so any vehicle, moving machinery, construction machinery installed with the TU600B etc. must not operate near health care facilities when any regulations posted in these areas prohibit the use of wireless phones or two-way radios. Hospitals and health care facilities may be using equipment that could be sensitive to external RF energy.

### ***Vehicles***

RF signals may affect improperly installed or inadequately shielded electronic systems in motor vehicles. Check with the manufacturer or its representative regarding the vehicle. Also consult the manufacturer of any equipment that has been added to the vehicle.

### ***Posted Facilities***

The TU600B unit cannot be turned off after installation, so any vehicle, moving machinery, construction machinery installed with the TU600B etc. must not enter any facility where posted notices prohibit the use of wireless phones or two-way radios.

### ***Aircrafts***

FCC and FAA regulations prohibit using wireless phones while in the air. Do not carry the TU600B unit aboard an aircraft as it cannot be turned off.

### ***Potentially Explosive Atmospheres***

The TU600B unit cannot be turned off after installation, so any vehicle, moving machinery, construction machinery installed with TU600B etc. must not enter any area with a potentially explosive atmosphere and obey all signs and instructions. Sparks in such areas could cause an explosion or fire resulting in bodily injury or even death.

Additionally, the TU600B must not enter or in areas posted “turn off two-way radio” to avoid interfering with blasting operations. Obey all signs and instructions.

Areas with a potentially explosive atmosphere are often, but not always marked clearly. Potential areas may include: fueling areas (such as gasoline stations); below deck on boats; fuel or chemical transfer or storage facilities; vehicles using liquefied petroleum gas (such as propane or butane); areas where the air contains chemicals or particles (such as grain, dust, or metal powders); and any other area where it would normally be advisable to turn off motor vehicle engines it is not allowed to enter with a vehicle, moving machinery, construction machinery installed with the TU600B.

### ***For Vehicles Equipped with an Airbag***

An airbag inflates with great force. DO NOT place objects, including the TU600B unit, in the area over the airbag or in the airbag deployment area. If in vehicle wireless equipment is improperly installed and the air bag inflates, serious injury could result.

### ***Specific Human Absorption Rates (SAR)***

THE TU600B UNIT IS NOT DESIGNED TO BE WORN ON A PERSON'S BODY. AS SUCH, BODY WORN TEST POSITIONS FOR THE TU600B UNIT ARE NOT REQUIRED BY EITHER THE IEC 62311 FOR GSM 900/1800 MHz BANDS, LTE M1/NB IOT 800/900/1800/2100 MHz BANDS OR FCC/IEEE/ICNIRP REQUIREMENTS FOR GSM 850/1900 MHz BANDS, LTE M1/NB IOT 700/850/1700/1900 MHz bands.

The TU600B unit is not intended for handheld use or to be worn on the body. A minimum separation of ten (8”) inches (20 cm) is to be maintained between the TU600B and any persons' body. Additional information on Specific Absorption Rates (SAR) can be found on the Cellular Telecommunications & Internet Association (CTIA) Web site at [www.ctia.org](http://www.ctia.org).

## **Battery Safety Information**

Adhere to the following guidelines to avoid the risk of fire or explosion:

1. Dispose of the used battery according to the instructions provided with the battery.
2. Do not drop, puncture, disassemble, mutilate, or incinerate the battery.
3. Touching both terminals of a battery with a metal object will short circuit the battery.  
Do not carry batteries loosely if the contacts may touch coins, keys, and other metal objects (such as in pockets or bags).
4. Do not stack batteries taken out of the carry case.
5. Do not heat the batteries to try to rejuvenate their charge.
6. Do not exceed the temperature ranges or other environmental conditions specified by the battery manufacturer when handling replacement batteries.
7. Never install and use the TU600B without the battery cover installed.
8. The TU600B can operate solely on the vehicle's battery without the internal backup battery installed. It is recommended to remove the battery under long term exposure to extreme environmental conditions above +60°C and below -20°C.

## **Automatic battery safety during operation**

For operational safety the battery inside the TU600B is under constant environmental temperature control providing the following automatic battery safety.

- The battery can only be charged within the specified temperature range 0°C to +45°C. For temperatures outside the range 0°C to 45°C, the battery charging circuit is disabled.
- The TU600B operates solely from the internal backup battery supply voltage when the external supply voltages is turned off or experiencing failure. The internal backup battery is limited to operate in the temperature range from -20°C to 60°C. If the temperature is outside this range the battery is disabled.
- When TU600B is operated from an external supply voltage the battery is put into storage from temperatures above +45°C and below -20°C.
- If the battery is fully charged and the temperature is within 0°C to 45°C a maintenance charging is applied.
- For long term storage in extreme temperatures below -20°C and above +50°C it is recommended to remove the battery from TU600B. The battery safety ensures that there is no risk\* associated with the battery in the temperature range from -40°C to +70°C but the battery lifetime can be seriously affected or even lead to internal permanent damage of the battery.

\* The risks are: No leakage, No venting, No disassembly, No rupture or No fire.

## Delivered standard content

The delivered standard package content includes the following items:

- 1 x (GSM / LTE cat-M1 / cat BN2 / GPS/GLONASS)-unit of the model type TU600B
- 1 x Mounting cradle.
- 1 x Li-ion Battery PN 4233.0002 or PN4233.0002 (May already be mounted inside the TU600B unit)

### **Optional content for generic installation:**

- 1 x Fuse with fuse holder for installation up to 24V DC/ (Max 1A) for TU600B units delivered with open cable ends. For installation in systems with higher voltages than 24V it is recommended to use a fuse and fuse holder rated for the specific supply voltage range, see service chapter for compliant fuse holders.

**NOTE:** Fuse and fuse holder is not included in packages where the TU600B is fitted with a customer required connector from factory.

**NOTE:** In case the unit is delivered with SIM card from the factory (Either US, EU SIM card or E-SIM as indicated on the product label), then the GSM/LTE cat-M1/cat-NB2 number will be indicated on the delivery note as well as on the package itself.

**NOTE:** In case the SIM card is delivered from factory it is mounted inside the TU600B unit.

## ***Ready-to-Use, No Custom Programming Required***

Simply connect the unit to supply voltage (12V/24V/48V DC). In its default configuration, reports are sent nominally at 15-minute intervals or faster whenever there is motion.

Upon powering up, the device will self-initialize anywhere in the world and start transmitting if an authorized GSM network is available. While a basic understanding of the different TU600B operational states is helpful, configuring the TU600B unit does not require a highly skilled software programmer or technician.

## **Cost-effective, Universally Available Communications**

The TU600B unit takes advantage of the near universal availability of GSM/LTE M1/NB IOT SMS text messaging while also leveraging cost-effective GPRS data rate plans.

Typical SMS plans offer very extensive inter-network roaming capabilities, both within a host country and internationally.

SMS plans also tend to be too pricey for applications requiring more than a few reports per day. GPRS data plans, on the other hand, typically allow for lower recurring communication costs although GPRS coverage and roaming can be restricted in some areas.

The TU600B unit takes advantage of both technologies by automatically selecting GPRS wherever such service is available, while relying upon SMS text messages for configuration purpose only. This helps minimize recurring communication costs while allowing the greatest coverage possible.

## Installing the unit

### ***Use location – Children not likely to be present***

This equipment design typically applies to commercial or industrial equipment expected to be installed in locations where only adults are normally present.

### ***Practical installation advice***

- **It is very important to be careful when installing the unit, as incorrect installation will reduce the quality of the GPS position reports (Ex. Could be a jump in position or showing speed while parking) or in the worst-case scenario will prevent the unit performing any position reporting at all.**

**The unit must NOT be installed beneath metal plates or inside closed metal compartments. Incorrect installation will also reduce the standby time of the battery inside the unit**

- The unit must be mounted either horizontally or vertically (sideways) using either screws or strips. The unit **must not** be installed with the interface/supply cable hanging down, as this will reduce the GPS sensitivity.  
Optimize the placement of the unit to increase the aerial view (through windows etc.) as much as possible. For hiding the unit, make sure it is only mounted beneath plastic parts or similar parts (wood), but not beneath metal parts.
- To reduce hum and noise in the FM radio it is recommended to place the unit at a minimum distance of 20 inches (50 cm) from the radio or the loudspeakers.

### ***Installation for insurance and anti-theft purpose***

For an installation of the TU600B with respect to insurance coverage of equipment/items/vehicles etc. in your country/region please contact your nearest sales office for support as the TU600B installation must be registered and documented for the local insurance company, the associated local alarm center.

The installation position in multiple equipment/items/vehicles etc. of the same type must be insured to be random to increase the theft protection.

It is needed to sign up a different subscription for each installed TU600B unit under insurance coverage that covers the local alarm center administration of the units.

The local sales office will be able to inform you about the obligations that you have in relation to the insurance company and how to act in relation to the alarm center while the units are covered by the insurance.



## Connections

The connections depend on the type of vehicles / machines etc. in which the (GSM/LTE M1/NB IOT)/GPS unit is to be installed.

Different variants of the TU600B device will have only a subset of the connections shown in the table below. Please contact your nearest sales office, distributor or “Reseller” for further information about the availability of other variants in your area.

| Wire (color code) | TU600B function             |
|-------------------|-----------------------------|
| Red               | Supply voltage +12V / +24V  |
| White             | Digital input 1             |
| Brown             | Digital input 2 (Ignition)  |
| Grey              | Digital input 3             |
| Yellow            | Digital output 1            |
| Green             | 1-Wire input (M8 Connector) |
| Pink              | Digital input 4             |
| Orange            | CAN HI (Optional)           |
| Light Blue        | CAN LO (Optional)           |
| Blue              | Common ground               |

## Power supply

The unit **must** be connected to either +12V, +24V battery voltage through a 1A/32V fuse or +36V, +48V battery through 3A/80V fuse. The use of a fused supply wire is important for not damaging the wires related to the unit in case of a short circuit etc.

## Digital inputs

The activation of a digital input requires a minimum high-level voltage of 9,5V.

## Digital output

The digital output has the type indication” LO-side switch”, that connects the output to 0V “ground”, when the output is active. This output can be used to control a relay powered from an external DC supply voltage. The maximum current drawn from the output is 200mA.

The output is protected against short circuits, overload and is also protected against over voltage. For further information about connection possibilities of the digital output, see chapters about installation later in this manual.

## Motion/acceleration sensor

The unit has a built-in 3 axis acceleration sensor that can activate the unit if it, as a consequence of disconnected supply voltage, is in stand-by mode (theft protection), log accelerometer data (for analyzing shock and machine behavior) or configured as a tilt-sensor.

## CAN interface

TU600 is equipped with a built-in CAN Controller.

Protocols supported: SAE J1939 and CANopen. The CAN interface is Fully Compliant with CAN 2 Part A and 2 Part B. Eight independent message objects (mailboxes) are implemented, and

Controller supports Bit Rates up to 1 Mbit/s.

Physical Interface specification as referred to by ISO/11898-2. 120R CAN termination optional: Mounted, Not Mounted or controlled by Firmware (CAN configuration).

The CAN Interface is only operational when supply voltage (12V / 24V / 48V) is present. Interface cannot operate on internal battery alone.

### **M8 Connector: 1-Wire input**

The M8 3 pole connector contains 3 signals: 1-wire bus, 5V and Ground.

The 1-wire is designed to communicate with Maxim 1-wire parts. Ex. Digital Thermometer (Temperature logging) or Maxim iButton Keys/tags (Access Control).

The 1-wire input is only operational when supply voltage (12V / 24V / 48V) is present. Interface cannot operate on internal battery alone.

### **Installing the TU600B as to surpass the main switch on the machine.**

In case the main switch on the machine will break the negative wire (Ground wire), the inputs may register a voltage level and start counting operating hours. To avoid this situation the digital input 4 (Pink wire) should be connected to the chassis/ground on the machine. Then send the following SMS to the unit (phone number) to activate the filtering:

| <b>Function</b>                     | <b>Send SMS</b>     | <b>Return-SMS from the unit</b>       |
|-------------------------------------|---------------------|---------------------------------------|
| Activate filter function on inputs. | <i>MT INFILT ON</i> | <i>MTC ACK (SERIAL No.) INFILT ON</i> |

**NOTE:** Enabling the filtering function will disable the use of the digital input 4 as a normal input.

**NOTE:** It is recommended always to connect digital input 2 to the ignition signal of the vehicle or machine.

**NOTE:** For the "Send SMS" it is of no importance if small or capital letters are used in the command string, or a mixture hereof.

### **Wireless connectivity: Bluetooth LE**

The TU600B can operate in Bluetooth LE band for access control, device configuration and asset tracking.





The TU600B will operate on a BT LE radio wave system when assessed by a paired unit i.e. cellphone. When connected the cellphone can be used as a mean for access control to the vehicles, machinery etc. on which the TU600B is physically installed.

In addition to the use case described above the TU600B can also be requested to passive scan for BLE advertisements and thereby enable asset tracking.

## Functionality check

### Functionality Check

LED status indication

| Status | LED mode   | LED color   | Status indication  |
|--------|--|---|--|
| ✓      | Red flashing light and constant green light in LED |    | - Mobile network is OK<br>- GPS has valid satellite position |
| ✗      | No light in LED                                    |   | - No power supply  |
| ✗      | Constant red light and no green light in LED       |    | - NO mobile network<br>- GPS has NO satellite position       |
| ✗      | Red flashing light and no green light in LED       |    | - Mobile network is OK<br>- GPS has NO satellite position    |
| ✗      | Constant red light and green light in LED          |  | - NO mobile network<br>- GPS has satellite position          |



## “Verify my Trackunit”

In order to control if the installation of the TU600B unit has been done correctly, it is possible to use the “Verify my Trackunit” tool.

### Installation Check & Update

Using “Verify my Trackunit”

#### 1. Login

- Go to [verify.trackunit.com](https://verify.trackunit.com)
- Enter user name and password

#### 2. Find unit

- Enter serial number
- Click “Find”

#### 3. Review status

- Time of last received data
- GPS and mobile signal
- Mobile number
- Power supply voltage
- Internal battery voltage
- Status of inputs 1 - 4 (on/off)
- Click “Find” again to refresh status

#### 4. Basic configuration options

- Enter:
  - A name of the device
  - Engine hours - start
  - Start distance
- Select “Category”
- Connect up to multiple groups
- Add a note (will be visible for the device in Trackunit Manager)

#### 5. Logout

- Click “Update” to save
- Click “Logout”

**Note:** Prior to verification, make sure the Raw is installed and active in an area with sufficient GPS and mobile coverage.

## Troubleshooting

Various error situations are listed below along with some possible solutions.

| Error code | Error description   | Possible solutions  |
|------------|---|---|
| F1         | The unit does not answer the SMS command send to it.                            | <ul style="list-style-type: none"> <li>◆ Verify if the SMS messages are sent to the correct GSM/LTE M1/NB IOT phone number.</li> <li>◆ Check LED status; See the “Functionality check” chapter in this manual.</li> <li>◆ If the TU600B unit has been delivered with the SIM card mounted. Contact Trackunit support. <ul style="list-style-type: none"> <li>○ Or contact the mobile operator to verify if there is any problem with the SIM card.</li> </ul> </li> <li>◆ Verify if the SIM card is correctly mounted in the unit.</li> </ul> |
| F2         | The LED in the unit is off, thus no power on the unit.                          | <ul style="list-style-type: none"> <li>◆ Check if the installation is performed correctly according to the guidelines of this manual.</li> </ul>  |
| F3         | The LED is constant red; thus the unit is not attached to the GSM / LTE network | <ul style="list-style-type: none"> <li>◆ If the TU600B unit has been delivered with the SIM card mounted. Contact Trackunit support. <ul style="list-style-type: none"> <li>○ Or contact the mobile operator to verify if there is any problem with the SIM card.</li> </ul> </li> <li>◆ Verify if the SIM card is correctly mounted in the unit.</li> <li>◆ Verify if the PIN code has been disabled from the SIM card before it was inserted in the unit</li> </ul>   |
| F4         | The unit send reply messages but there is no GPS signal                         | <ul style="list-style-type: none"> <li>◆ Verify if the unit is mounted according to the instructions laid out in this manual with respect to the aerial view; see “Installing the unit” chapter.</li> <li>◆ If the machine/vehicles are located inside a building, please move the machine/vehicle outside a try again.</li> </ul>  |

## Installation of the digital output

According to the E1 certificate of the TU600B unit, it is prohibited under any circumstances to use this output to control any equipment that may influence the safety of the construction machinery and earth moving machines/vehicle operation and driving. The output must only be used to control comfort equipment.

The example shows a 12V relay function with a 12V DC supply voltage. It is also possible to use a 24V relay with a 24V DC supply voltage etc. The current consumption of the relay must not exceed 200 mA (DC current) and the relay contacts must be specified to withstand the load that needs to be controlled.

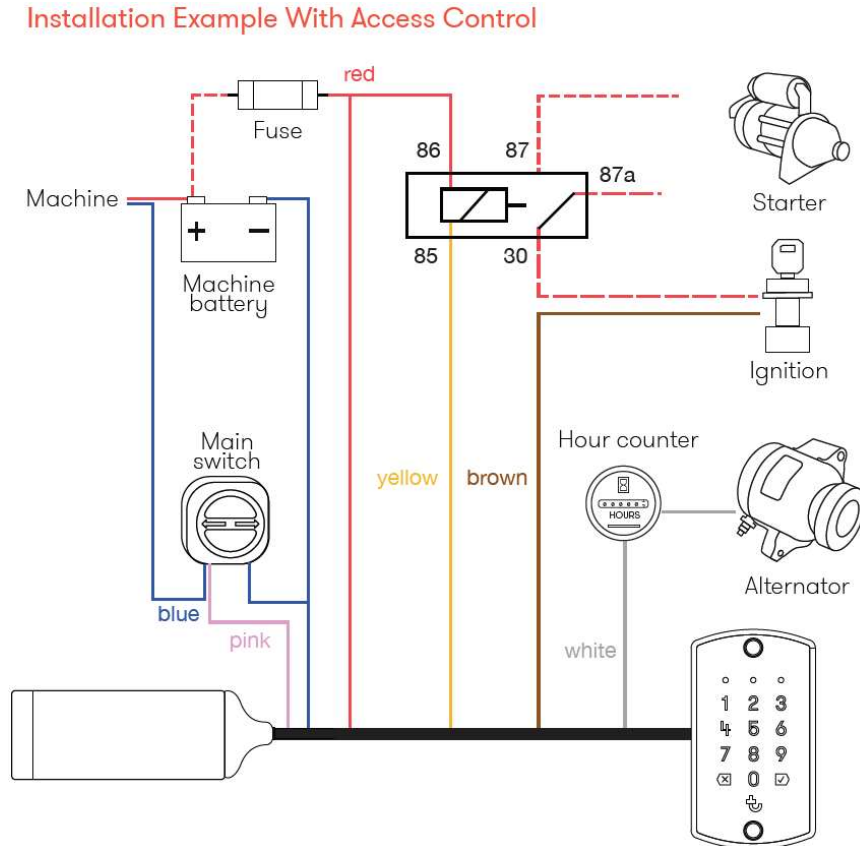

**NOTE:** The output can only handle DC and **not** AC voltage. It is necessary to only use a DC power supply for the relay.

**Important!** The power supply connected to the TU600B (GSM/LTE M1/NB IoT)/GPS unit and the supply voltage for the relay mounted on the digital output must have a common ground connection.

One application example for the “Usable contact function controlled by the TU600B” signals shown in the figure above could be a “Start Relay”, blocking function, for preventing unauthorized use of the moving machinery and construction machine or vehicle outside normal working hours etc.

## ***SMS commands for output control***

| Function                   | Send SMS    | Return SMS                    | Description   |
|----------------------------|-------------|-------------------------------|---|
| Activation of the output   | MT OUT1=ON  | MTC ACK (SERIAL No.) OUT1 ON  | With this command the output is activated permanently. The output can be deactivated again using the "OFF" command. |
| Deactivation of the output | MT OUT1=OFF | MTC ACK (SERIAL No.) OUT1 OFF | With this command the output is deactivated.  |

**NOTE:** For the "Send SMS" it is of no importance if small or capital letters are used in the command string, or a mixture hereof.

## ***Safety precautions***

The use of the digital output is restricted to signals/systems/components related to comfort applications in the vehicles.

Under no circumstances must it be used for purposes, which can influence the safety of the vehicle when driving.

Trackunit holds no liability for any damages occurred to persons, vehicles, moving machines, construction machines etc. caused by wrong installation and/or faulty use of the digital output.

## **Warranty**



Trackunit APS products are covered by a limited manufacturer warranty. The Trackunit APS warranty is limited to the warranty rules and legislation present in each country. The warranty only covers manufacturing faults.

The warranty does not cover misuse, wrong installation or damage due to a faulty installation or wrong maintenance.

The invoice act as the proof of warranty, so please keep it as reference for any warranty complaints.

## **Technical Assistance/Support and spare parts**

Trackunit APS offers technical assistance to all our customers about the use, installation, insurance, and spare parts:

-  If you have a problem and cannot find the information you need in the product documentation, please contact Trackunit Aps.
-  For replacement batteries Trackunit model PN 4233.0002 or PN 4233.004 must be used, please order at Trackunit Aps.



- ✚ For mounting the Trackunit TU600B in harsh environment, not covered by the compliance statements or areas where pressure cleaning is required the Trackunit HW shield PN 7402.9551 is required for protective mounting. Please order at Trackunit Aps.



- ✚ Recommended fuse holders and fuses up to 48V supply voltages (Can be ordered at Trackunit APS):
  - a. Supply voltage 12V/24V (Max 30A)
    - i. ATO blade fuses (Max 32V/1A) used with Littelfuse FHAC0002SXJ fuse holder (Standard).
    - ii. ATP blade fuse (Max 32V/1A – ATO style) used with TaiTek FH-006WR-12R-12-U fuse holder (Standard).
  - b. Supply voltage 12V – 48V (Max 30A)
    - i. FKS blade fuse (Max 80V/3A – ATO style) used with Littelfuse FH2 fuse holder. (Recommended)



**Left:** 32V/1A fuse kit, **Right:** 80V/3A fuse kit

### Trackunit Aps

Gasvaerksvej 24, 4 sal  
 Dk-9000 Aalborg  
 Tel: +45 9973 0020  
 Fax: +45 9673 7407

E-Mail: [support@trackunit.com](mailto:support@trackunit.com)  
 Web: [www.trackunit.com](http://www.trackunit.com)

When contacting technical support, please be prepared to provide the information listed below:

### **Minimum Information Required for Technical Assistance**

If you or a user reports difficulty with a TU600B unit (i.e. no GPS fixes, not communicating, LED not working, etc.), it is helpful to retrieve directly from the unit all current configuration settings and the message log data etc., that is accessible by the technical support when they receive the following information about the unit.

2. Unit Serial number

### **Return Merchandise Authorization – RMA**

1. If you experience defects in your product, please contact our customer support at: [support@trackunit.com](mailto:support@trackunit.com) or phone **+45 96 73 74 00**

Your inquiry will be processed by our support team and a support ticket number will be created in our system. You will receive your ticket number by email.

2. In case your hardware needs to be sent to us you will receive an RMA form by email from our support team that you must fill out.

Print out the RMA and pack it together with the faulty product and send both to the following address:

**Trackunit Aps**  
 Gasvaerksvej 24, 4 sal  
 DK-9000 Aalborg  
 Denmark  
 Attention: Service

## **Specifications**

The product specifications are described below.

### **Product specifications**

The TU600B unit is a (GSM/GPRS quad-band-unit and a combined LTE M1 / NB IoT multiband unit) with GPS, integrated antennas, acceleration sensor, 2Mbyte SPI flash and a backup battery

### **Connections:**

|   |                                     |
|---|-------------------------------------|
| Operational voltage (supply voltage):                   | 12 – 48 V DC                        |
| Absolute maximum voltage range:                         | 8 – 58 V DC continuous              |
| Standby consumption (GSM/LTE M1/NB IOT-receiver active) | 10 mA / 7 mA (average at 12V / 24V) |
| Consumption during charging on an empty battery         | 225 mA / 115 mA (max at 12V / 24V)  |
| Standby time on the backup-battery                      | 2-4 days                            |

|   |                  |
|---|------------------|
| Charging time for an empty backup-battery | 3 hours at 25 °C |
| Expected lifetime of the backup-battery   | 3 years          |
| Digital inputs                            | 4                |
| Digital outputs                           | 1                |
| 1-Wire interface                          | Optional         |
| CAN interface                             | Optional         |
| Bluetooth 5 LE (wireless)                 | Optional         |

### Internal temperature ranges:

|   |                |
|---|----------------|
| Charging or maintenance charging (With external DC supply voltage)<br>(If the temperature exceeds this range the charging is disabled, and the battery put into internal storage mode)  | 0°C to +45°C   |
| In active running mode (Without external DC supply voltage)<br>(If the temperature exceeds this range the battery supply voltage is disabled, and the battery put into internal storage mode. Due to a small internal self-heating during operation this may occur at external temperatures between 55°C – 60°C.)                                 | -20°C to +60°C |
| Internal storage without loss of battery performance<br>(Specified by battery cell vendor. This range apply for the TU600B operated from an external DC supply voltage outside the charging temperature range.)   | -20°C to +50°C |
| Internal storage with loss of battery performance<br>(Within battery safety limits)<br>(According to the MSDS, UN38.3 and IEC62133:2012 testing, it is safe to keep the battery in storage for shorter periods above +50°C or below -20°C. For longer exposures to extreme temperatures it is recommended to remove the battery from the TU600B). | -40°C to +70°C |

### External temperature ranges:

|   |                      |
|---|----------------------|
| Recommended operational temperature range (External/Internal DC supply)<br>(See internal temperature ranges for details)  | -20°C to +55°C/+60°C |
| Internal Storage<br>(Warning: Battery life time and performance not guaranteed for temperatures from -40°C to -20°C or from +50°C to +70°C)<br>(See internal temperature ranges for details). | -40°C to +70°C       |

### GSM/GPRS-specifications:

Supporting EGSM/GPRS/EGPRS 900/1800/850/1900 with maximum output power:

|                                  |      |
|----------------------------------|------|
| at EGSM-GPRS/EGPRS 900 MHz:      | 2.0W |
| at GSM-GPRS/EGPRS 850 MHz:       | 2.0W |
| at GSM-GPRS/EGPRS 1800/1900 MHz: | 1.0W |

Additionally, supports GPRS/EGPRS – Multislot class 33, CS 1–4 and MCS 1-9

### LTE cat M1 / cat NB2 band - specifications:

Supporting LTE cat M1 / cat NB2 band 600/700/800/900/1800/2100/850/1700/1900 with maximum output power:

$P_{\max} = 0.3W$

TU600B supports band :

**LTE-FDD cat M1; B1 / B2 / B3 / B4 / B5 / B8 / B12 / B13 / B18 / B19 / B20 / B25 / B26 / B27 / B28 / B66 / B85:**

- B1: TX 1920-1980 MHz, RX 2110-2170 MHz
- **B2 / (GSM1900):** TX 1850-1910 MHz, RX 1930-1990 MHz
- **B3 / (GSM1800):** TX 1710-1785 MHz, RX 1805-1880 MHz
- B4: TX 1710-1755 MHz, RX 2110-2155 MHz
- **B5 / (GSM850):** TX 824-849 MHz, RX 869-894 MHz
- **B8 / (GSM900):** TX 880-915 MHz, RX 924-960 MHz
- B12: TX 699-716 MHz, RX 728-746 MHz
- B13: TX 777-787 MHz, RX 746-757 MHz
- B18: TX 815-829.9 MHz, RX 860-874.9 MHz
- B19: TX 830-844.9 MHz, RX 875-889.9 MHz
- B20: TX 832-862 MHz, RX 791-821 MHz.
- B25: TX 1850-1915, RX 1930-1995 MHz (Extended PCS band)
- B26: TX 814-848.9 MHz, RX 859-893.9 MHz (Extended 850 MHz band)
- B27: TX 807-824 MHz, RX 852-869 MHz (Sub 850 MHz band)
- B28: TX 703-748 MHz, RX 758-803 MHz
- B66: TX 1710-1780 MHz, RX 2110-2200 MHz
- B85: TX 698-716 MHz, RX 728-746 MHz

**LTE-FDD cat NB2; B1 / B2 / B3 / B4 / B5 / B8 / B12 / B13 / B18 / B19 / B20 / B25 / B28 / B66 / B71 / B85:**

- B1: TX 1920-1980 MHz, RX 2110-2170 MHz
- **B2 / (GSM1900):** TX 1850-1910 MHz, RX 1930-1990 MHz
- **B3 / (GSM1800):** TX 1710-1785 MHz, RX 1805-1880 MHz
- B4: TX 1710-1755 MHz, RX 2110-2155 MHz
- **B5 / (GSM850):** TX 824-849 MHz, RX 869-894 MHz
- **B8 / (GSM900):** TX 880-915 MHz, RX 924-960 MHz
- B12: TX 699-716 MHz, RX 728-746 MHz
- B13: TX 777-787 MHz, RX 746-757 MHz
- B18: TX 815-829.9 MHz, RX 860-874.9 MHz
- B19: TX 830-844.9 MHz, RX 875-889.9 MHz
- B20: TX 832-862 MHz, RX 791-821 MHz.
- B25: TX 1850-1915, RX 1930-1995 MHz
- B28: TX 703-748 MHz, RX 758-803 MHz
- B66: TX 1710-1780 MHz, RX 2110-2200 MHz
- B71: TX 663-698 MHz, RX 617-652 MHz
- B85: TX 698-716 MHz, RX 728-746 MHz

The marked bands B12/B13 are denoted LTE 700 MHz band lower and upper part. The bands B18/B19 are denoted LTE 800 band lower and upper part for Japan.

## Mechanical specifications

|                      |  |
|----------------------|--|
| Dimensions: Length:  | 122.1 mm   |
| Width:               | 45.65 mm (49 mm incl. mounting cradle)                     |
| Height:              | 18 mm (23 mm incl. mounting cradle)                        |
| Cable length:        | 170 – 180 cm   |
| Environmental class: | IP67 (Standalone)<br>IP66K, IP69K (Mounted with HW shield) |
| Enclosure material:  | Non-flammable PP casing and ABS cable connector lid.       |
| Weight:              | 65 g (excluding the cable)                                 |



## Approvals and certificates

The TU600B product is certified according to KBA (E1 mark), EU (CE mark), UK (UKCA mark), USA (FCC ID), Canada (IC ID), Japan JATE/MIC ID (GITEKI mark), Australia ACMA (RCM mark), New Zealand (R mark), Argentina (RAMATEL mark), Mexico safety (NOM mark), SUTEL (Costa Rica), NCA (Ghana), ICASA (South Africa), Chile (Resolution 403:2008), Ingress Properties (IP mark), Bluetooth SIG (BLE mark), CTIA (IoT Network mark), UAE (TRA), OMAN (TRA), Singapore (IMDA):

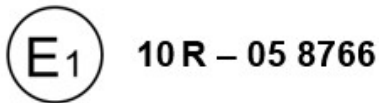

10R – 05 8766



Este equipo cumple con la Resolución No 403 de 2008, de la Subsecretaría de telecomunicaciones, relativa a radiaciones electromagnéticas

FCC ID: ZMF-TU600B  
IC: 9746A-TU600B



IP67

*“The Bluetooth® word mark and logos are registered trademarks owned by Bluetooth SIG, Inc. and any use of such marks by Trackunit APS is under license. Other trademarks and trade names are those of their respective owners.”*

### FCC and IC certification statements

The TU600B product contains radio transmitters that comply with CFR 47 Part 15, Part 15.247, Part 22, Part 24, Part 27 and Part 90 of the FCC rules and with RSS-GEN, RSS-102, RSS-130, RSS-132, RSS-133, RSS-139 and RSS-247 of Industry Canada requirements.

#### Statements according to CFR 47 Part 15.19 / RSS-GEN:

The TU600B product complies with Part 15 of the FCC rules and with ICES-003 of Industry Canada rules. Operation is subject to the following two conditions:

- (1) This device may not cause harmful interference, and
- (2) This device must accept any interference received, including interference that may cause undesired operation.

#### Déclarations selon le CFR 47 section 15.19 / RSS-GEN:

Le présent TU600B appareil est conforme aux CNR d'Industrie Canada applicables aux appareils radio. L'exploitation est autorisée aux deux conditions suivantes :

- (1) l'appareil ne doit pas produire de brouillage, et
- (2) l'utilisateur de l'appareil doit accepter tout brouillage radioélectrique subi, même si le brouillage est susceptible d'en compromettre le fonctionnement.

#### Statements according to CFR 47 Part 15.21:

Changes or modifications made to this equipment not expressly approved by Trackunit may void the FCC authorization to operate this equipment.



**Statements according to CFR 47 Part 2.1091 and RSS-102:**

With respect to radiofrequency radiation exposure Information, it is declared that this equipment complies with FCC radiation exposure limits set forth for an uncontrolled environment.

This equipment should be installed and operated with minimum distance of 20 cm between the radiator and your body.

This transmitter must not be co-located or operating in conjunction with any other antenna or transmitter.

**Déclarations selon le CFR 47 Sections 2.1091 et RSS-102:**

Respectant les informations relatives à l'exposition aux radiations de fréquences radio, on déclare que cet équipement respecte les limites d'exposition aux radiations de la FCC aux conditions prévues pour un environnement non contrôlé.

Cet équipement doit être installé et fonctionner à une distance minimale de 20 cm entre l'appareil irradiant et votre corps.

Cet émetteur ne doit pas être installé ou utilisé en conjonction avec d'autres antennes ou d'autres émetteurs.

**Statements according to CFR 47 Part 15.105 and ICES-003:**

This equipment has been tested and found to comply with the limits for a Class B digital device, pursuant to part 15 of the FCC Rules and ICES-003 of the Canadian rules. These limits are designed to provide reasonable protection against harmful interference in a residential installation. This equipment generates, uses and can radiate radio frequency energy and, if not installed and used in accordance with the instructions, may cause harmful interference to radio communications. However, there is no guarantee that interference will not occur in a particular installation. If this equipment does cause harmful interference to radio or television reception, which can be determined by turning the equipment off and on, the user is encouraged to try to correct the interference by one or more of the following measures:

- Reorient or relocate the receiving antenna.
- Increase the separation between the equipment and receiver.
- Connect the equipment into an outlet on a circuit different from that to which the receiver is connected.
- Consult the dealer or an experienced radio/TV technician for help.

**Automotive, off-road vehicles, machinery etc.**

- UN regulative ECE R10 EMC rev. 05/01 in accordance with EU regulation 661/2009.
  - Tested by ECE R10 rev05/01.
- The TU600B product complies with the essential requirements of the Directive 2006/42/EC and EU regulation 167/2013 construction machinery:
  - Tested in compliance to EN ISO 14982, ISO 13766-1, -2, EN 13309, DIN EN 12895, see below.

**Statement for ISO 13849-1 safety**

1. *The TU600B products are when installed not a vital part in the machine safety system, but it can be used as access control/immobilizer if paired with a keypad (i.e. DualID II), ibutton or wireless (Bluetooth LE enabling). This function depends on correct installation (see*



install guide) and requires that the output wire is connected to a relay to control the starter motor.

2. When the emergency stop on the machine is activated, the unit and keypad functions will be disabled. The internal battery ensures that a GPS position still can be acquired on an hourly basis.

**Precaution: Trackunit recommends only mounting Output1 to starter motors through a relay and under no circumstances should Output1 be used to control engine shutdown during operation or any moving parts on the machine.**

### EU and UK regulations and directives

- The TU600B product complies with the essential requirements of the Automotive Directive
- The TU600B product complies with the essential requirements of the RED Directive 2014/53/EU directive with respect to the EMC requirements, safety, vehicles transients and radio spectrum and the council recommendation 1999/519/EC on the limitation of exposure of the general public to electromagnetic fields (0 Hz to 300 GHz), when used as intended.
  - The TU600B product also complies with the essential requirements of the Directive 2014/30/EU for the use of harmonized standards for machinery and vehicles EMC: EN ISO 14982, EN 13309, EN 12895 and ISO 13766-1, -2
- The TU600B product complies with the essential and environmental requirements of the Interoperability of trans-European conventional rail system 2001/16/EC and 2004/50/EC directives, when used as intended on rolling stock.
- *The TU600B complies with the essential requirements of the 2011/65/EC directive with the amendment 2015/863/EU directive on the restriction of the use of certain hazardous substances in electrical and electronic equipment (ROHS 3).*
- *The TU600B complies with the essential requirements of the 1999/45/EC directive as amended by EC 1907/2006 regulation concerning the Registration, Evaluation, Authorization and Restriction of Chemicals (REACH).*
- *The TU600B complies with the requirements of the 2012/19/EU directive on waste electrical and electronic equipment (WEEE).*

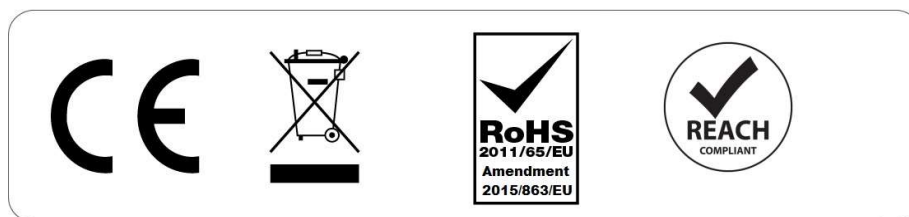

- *UK Restriction of use of Certain Hazardous Substances in Electrical and Electronic Equipment Regulation 2012 – UK SI 2012 No. 3032.*

Including:

| Standard                 | Version | Description                                       |
|--------------------------|---------|---|
| ISO 13766-1, ISO 13766-2 | 2018    | Earth-moving machinery and Construction machinery |
| EN 13309                 | 2010    | Construction machinery                            |

|                                      |                         |   |
|--------------------------------------|-------------------------|---|
|                                      |                         | (Expire 2021-06-30)   |
| <b>EN/ISO 14982</b>                  | <b>2010</b>             | Agricultural and forestry machines  |
| <b>EN 12895, DIN EN 12895</b>        | <b>2015</b>             | Industrial trucks – Electromagnetic compatibility   |
| <b>(EN/IEC 62368-1 + AC/3 + A11)</b> | <b>2014, 2015, 2017</b> | Information and communication technology equipment safety                                 |
| <b>EN/IEC 62133 {Ed2}</b>            | <b>2012</b>             | Safety requirements for portable sealed secondary cells and for batteries made from them. |

### ***CE and UKCA marking***

We, Trackunit Aps hereby declare that the TU600B product complies with the essential requirements of the RED Directive 2014/53/EU as stated by the EU Declaration of Conformity and the Radio Equipment Regulations 2017 – UK SI 2017 No. 1206.

EU Certificate and Declaration of conformity (DOC) statements can be downloaded from the Trackunit website:

<https://www.trackunit.com/support/download/>

### ***PTCRB certification for interoperability with mobile networks.***

All variants of the TU600B products series under FCC ID: ZMF-TU600B and IC: 9746A-TU600B are certified for PTCRB interoperability with mobile networks. Specific Trackunit model design certificates have been obtained for:



Approval ID: for TU600-25

### ***Bluetooth SIG registration***

The TU600-25 product is Bluetooth SIG registered under declaration ID: D050742 supporting core specification 5.1. Trackunit Aps is listed with company identifier UUID: 2159 (0x086F)

## **Specific country approval regulations and statements**

### ***Australia and New Zealand***

- The TU600B product complies with the requirements of the relevant ACMA Standards made under the Radiocommunications Act 1992 and the Telecommunications Act 1997, by the Supplier's Declaration of Conformity (SDOC). These Standards are referenced in notices made under section 182 of the Radiocommunications Act and 407 of the Telecommunications Act.

- The TU600B product complies with the requirements of the relevant standards under Section 134 (1) (g) of the New Zealand Radiocommunications Act 1989, by the Supplier's Declaration of Conformity (SDOC)

### Japan

- The **TU600-25** model of the product family TU600B is approved in Japan with the certificate ID n°: **[T] D200116003, [R] 003-200139, [R] 020-190254**  
(That contains a Bluetooth Low Energy interface)
- This device is granted pursuant to the Japanese Radio Law (電波法)  
=当該機器には電波法に基づく、技術基準適合証明等を受けた特定無線設備を装着している
- This device should not be modified (otherwise the granted designation number will become invalid)  
本製品の改造は禁止されています。(適合証明番号などが無効となります。)

**Translated (For information only):**

This device is granted pursuant to the Japanese Radio Law (Radio Act)  
= The equipment is equipped with specified wireless equipment that has received a certificate of conformity with technical standards based on the Radio Law.  
This device should not be modified (otherwise the granted designation number will become invalid)  
Modification of this product is prohibited (Compliance certification number etc. become invalid.)

### Chile

- For Chile, a label must be applied in the user manual for compliance with the radio and EMC law:

Este equipo cumple con la Resolución No  
403 de 2008, de la Subsecretaría de  
telecomunicaciones, relativa a radiaciones  
electromagnéticas

### Mexico

- For Mexico, the label for NOM-019, NOM-008, NOM-221 compliance certification must be applied in the user manual for compliance with the safety rules SCFI-1993:

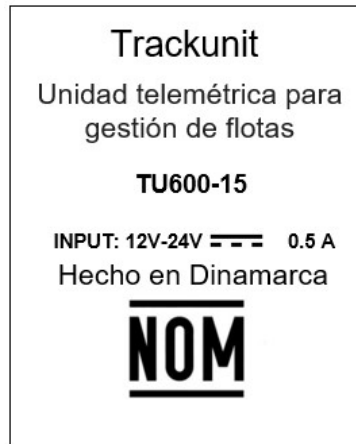

- “La operación de este equipo está sujeta a las siguientes dos condiciones:
  - (1) es posible que este equipo o dispositivo no cause interferencia perjudicial y
  - (2) este equipo o dispositivo debe aceptar cualquier interferencia, incluyendo la que pueda causar su operación no deseada.”

### **Brazil**

- For the ANATEL homologation of the TU600-25 in Brazil the below information applies:

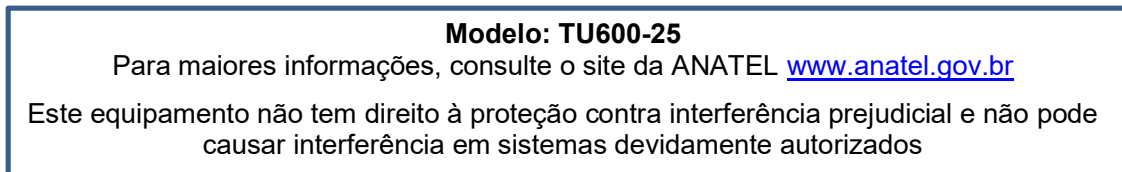

### **United Arab Emirates (UAE)**

- Besides the approval label in the user guide a Declaration of Conformity label is required for the retail boxes when importing TU600-25 to UAE. The label is mandatory for sales and distribution in UAE in either color or BW:

## **Specific model country approval certificates**

The specific country approvals are listed in the table below. For some countries an importing license apply as no certification or approval is applicable for the TU600-25.

| Country                             | Model    | Regulatory body        | Certificate number  | Label |
|-------------------------------------|----------|------------------------|---|-------|
| <b>Europe-CEPT</b>                  | TU600-25 | EU-NB                  |   | Yes   |
| <b>UK</b>                           | TU600-25 | BSI                    | <b>UKCA mark</b>  | Yes   |
| <b>Russia,</b>                      | TU600-25 | EAC                    | <b>EAC mark</b>   | Yes   |
| <b>Myanmar</b>                      | TU600B   | PTD                    | (NOTE: Accept EU DoC for Import if requested)                           | No    |
| <b>Macau</b>                        | TU600-25 | CTT                    | (NOTE: No certification required)                                       | No    |
| <b>Japan</b>                        | TU600B   | TELEC/<br>JATE/<br>MIC | <b>[T] D200116003</b><br><b>[R] 003-200139</b><br><b>[R] 020-190254</b> | Yes   |
| <b>Australia</b>                    | TU600-25 | ACMA                   | <b>RCM mark</b><br>(By local signed SDOC)                               | Yes   |
| <b>New Zealand</b>                  | TU600-25 | NZ                     | Local importer must apply for approval                                  | Yes   |
| <b>Singapore</b>                    | TU600-25 | IMDA                   | <b>DB 107653</b>  | Yes   |
| <b>India</b>                        | TU600-25 | ETA-WPC                |   | No    |
| <b>Sri Lanka</b>                    | TU600-25 |                        | <b>TBD</b><br>(Local importer required)                                 | Yes   |
| <b>US</b>                           | TU600B   | FCC                    | <b>FCC ID: ZMF-TU600B</b>   | Yes   |
| <b>Canada</b>                       | TU600B   | ISED                   | <b>IC: 4796A-TU600B</b>   | Yes   |
| <b>Chile</b>                        | TU600B   | -                      | (NOTE: Label required for compliance to radio law)                      | Yes   |
| <b>Trinidad &amp; Tobago</b>        | TU600-25 | TATT                   | Reference:<br>Accept FCC-ID: <b>ZMF-TU600B</b>                          | No    |
| <b>El Salvador</b>                  | TU600-25 | CNAF                   |   | No    |
| <b>British Virgin Islands (BVI)</b> | TU600-25 | TRC                    | Reference:<br>Accept <b>FCC ID: ZMF-TU600B</b>                          | No    |
| <b>Jamaica</b>                      | TU600-25 | SMA                    | Accept <b>FCC-ID: ZMF-TU600B</b>  | No    |
| <b>Argentina</b>                    | TU600-25 | ENACOM                 |   | Yes   |
| <b>Uruguay</b>                      | TU600-25 | URSEC                  |   | No    |
| <b>Bahamas</b>                      | TU600-25 | URCA                   |   | No    |
| <b>Guatemala</b>                    | TU600-25 | SIT                    |   | No    |
| <b>Peru</b>                         | TU600-25 | TRF                    |   | No    |
| <b>Dominican Republic</b>           | TU600-25 | INDOTEL                |   | No    |
| <b>Ecuador</b>                      | TU600-25 | ARCOTEL                |   | No    |
| <b>Barbados</b>                     | TU600-25 | MED                    |   | No    |
| <b>Belize</b>                       | TU600-25 | PUC                    |   | No    |
| <b>Bermuda</b>                      | TU600-25 | BRA                    | (Bluetooth)   | No    |
|                                     |          |                        | (Cellular)  |       |

| Country             | Model    | Regulatory body  | Certificate number  | Label |
|---------------------|----------|------------------|---|-------|
| <b>Dominica</b>     | TU600-25 | NTRC             |   | No    |
| <b>Paraguay</b>     | TU600-25 | CONATEL          |   | Yes   |
| <b>Columbia</b>     | BG95-M3  | CRC              | (Approved for BG95-M3 TAC: 86773005)                                      | No    |
|                     | TU600-25 | CRC              | (Approval of TU600-25 TAC: 35361794)                                      | No    |
| <b>Guyana</b>       | TU600-25 | TA               | Reference:<br>Accept <b>FCC-ID: ZMF-TU600B</b>                            | No    |
| <b>Aruba</b>        | TU600-25 | DTZ              | Reference:<br>Accept <b>FCC-ID: ZMF-TU600B</b>                            | No    |
| <b>Panama</b>       | TU600-25 | ASEP             | <b>4860</b>   | No    |
| <b>Bolivia</b>      | TU600-25 | ATT              | Reference:<br>Accept <b>FCC-ID: ZMF-TU600B</b>                            | No    |
| <b>Honduras</b>     | TU600-25 | CONATEL          |   | No    |
| <b>Nicaragua</b>    | TU600-25 | TELCOR           |   | No    |
| <b>Mexico</b>       | TU600-25 | ANCE:<br>NOM-019 |   | Yes   |
|                     |          | ANCE:<br>NOM-208 |   |       |
|                     |          | ANCE:<br>NOM-221 | Part 1:<br>Part 2:  |       |
|                     |          | IFETEL           |   | Yes   |
| <b>Brazil</b>       | TU600-25 | ibrace           |   | Yes   |
|                     |          | ANATEL           |   |       |
| <b>Costa Rica</b>   | TU600-25 | SUTEL            |   | Yes   |
| <b>Morocco</b>      | TU600-25 | ANRT             | Technical certificate for import:<br><br>(NOTE : Import license required) | No    |
| <b>Algeria</b>      | TU600-25 | ARPCE            |   | No    |
| <b>Madagascar</b>   | TU600-25 | ARTEC            |   | No    |
| <b>Ghana</b>        | TU600-25 | NCA              |   | Yes   |
| <b>Gambia</b>       | TU600-25 | PURA             |   | No    |
| <b>Zimbabwe</b>     | TU600-25 | POTRAZ           |   | No    |
| <b>Botswana</b>     | TU600-25 | BOCRA            |   | No    |
| <b>Tanzania</b>     | TU600-25 | TCRA             |   | No    |
| <b>Namibia</b>      | TU600-25 | CRAN             |   | No    |
| <b>South Africa</b> | TU600-25 | ICASA            |   | Yes   |
| <b>Djibouti</b>     | TU600-25 | DDTIC            |   | No    |
| <b>Qatar</b>        | TU600-25 | CRA              |   | No    |

| Country                           | Model    | Regulatory body   | Certificate number  | Label |
|-----------------------------------|----------|-------------------|---|-------|
| <b>Kuwait</b>                     | TU600-25 | CITRA             |   | No    |
| <b>Oman</b>                       | TU600-25 | TRA<br>Dealer     |   | Yes   |
| <b>Israel</b>                     | TU600-25 | MOC               | (Import license number:<br>for 2022/2023)                           | No    |
| <b>Turkey</b>                     | TU600-25 | TTTE<br>(Sinif 2) | (NOTE: Import manufacturer declaration<br>required)                 | No    |
| <b>Saudi Arabia</b>               | TU600-25 | CITC              |   | No    |
| <b>Jordan</b>                     | TU600-25 | TRC               | (NOTE: Import application stating<br>compliance to TRC regulations) | No    |
| <b>Lebanon</b>                    | TU600-25 | MOC               |   | No    |
| <b>Bahrain</b>                    | TU600-25 | TRA               |   | No    |
| <b>Pakistan</b>                   | TU600-25 | TAC               |   | No    |
| <b>Turkmenistan</b>               | TU600-25 | TDS               |   | No    |
| <b>Uzbekistan</b>                 | TU600-25 | OSTZ              |   | No    |
| <b>United Arab Emirates (UAE)</b> | TU600-25 | TDRA              |   | Yes   |
| <b>Yemen</b>                      | TU600-25 | MTIT              |   | No    |

## Environmental compliance

The TU600B are designed for compliance to the following environmental standards related to the intended use of the product:

| Standard                                     | Version       | Description <sup>A, B</sup> |
|--|---------------|-----------------------------|
| SAE J1455:2017, EN/IEC 60068-2-1             | 2007          | Cold                        |
| SAE J1455:2017, EN/IEC 60068-2-2             | 2006          | Dry Heat                    |
| SAE J1455:2017, EN/IEC 60068-2-27, IEC 61373 | 2010          | Shock                       |
| SAE J1455:2017, EN/IEC 60068-2-31            | 2008          | Drop, free fall             |
| SAE J1455:2017, EN/IEC 60068-2-64            | 2008          | Random vibration            |
| SAE J1455:2017, EN/IEC 60068-2-64, IEC 61373 | 2010          | Acceleration                |
| IEC 60721-2-3                                | 2013          | Attitude                    |
| SAE J1455:2017, EN/IEC 60068-2-78            | 2001          | Damp heat steady state      |
| EN/IEC 60068-2-5, ASTM D4329                 | 2018,<br>2013 | UV protection               |



|  |             |   |
|--|-------------|---|
| <b>SAE J1455:2017,<br/>IEC 60529 + A1 + A2 (CSV) {Ed3.1}</b> | <b>2013</b> | IP67 - Degrees of protection without HW shield<br>IP69K & IP66K mounted inside HW shield. |
|--|-------------|---|

**NOTE A:** The TU600B is not to be mounted in areas with presence of Motor oil, Gasoline, Diesel fuel, Hydraulic fluid, Brake fluid, Transmission fluid, Glycol and water mixture etc.

**NOTE B:** The housing not designed to withstand high pressure cleaning. Only use the TU600B when mounted inside the designated Trackunit protection cap (Can be ordered at Trackunit APS) in mounting areas where high pressure cleaning is common procedure.

**Environmental protection without HW shield:**

|  | TU600-x standalone                            | Requirements   |
|--|---|--|
| <b>Temperature Soak</b>  | -40°C - +85°C, 48h                            | SAE J1455, IEC 60068-2-1, IEC 60068-2-2                                |
| <b>Humidity</b>  | +45°C to -30°C, RH95%, 8h                     | SAE J1455, IEC 60068-2-78  |
| <b>Salt Spray</b>  | -   | SAE J1455, IEC 61701   |
| <b>Immersion of water</b>  | IPX7  | SAE J1455, IEC 60529 IPX7  |
| <b>Splash of water</b>   | -   | SAE J1455, IEC 60529 IPX6  |
| <b>Chemicals /oils</b> (Motor oil, Motor oil, Gasoline, Diesel fuel, Hydraulic fluid, Brake fluid, Transmission fluid, Glycol and water mixture) | -   | SAE J1455 (Add for 5min + clean), IEC 60068-2-74                       |
| <b>Steam cleaning / pressure washing</b>   | -   | SAE J1455, IEC 60529 up to IPx9K                                       |
| <b>Fungus</b>  | -   |  |
| <b>Dust/wire</b>   | IP6X, Ø1                                      | SAE J1455, ISO 5011, IEC 60529 IP6X, Ø1                                |
| <b>Sand and Gravel Bombardment</b>   | -   | SAE J1455, ISO 5011  |
| <b>Altitude</b>  | 700 hPa                                       | IEC 60721-2-3 (700 hPa - 3000 meter)                                   |
| <b>Vibration (3 axes)</b>  | 30 m/s <sup>2</sup> at 10Hz – 2kHz, 8h        | SAE J1455, IEC 60068-2-64 category 1, 2a, 2b, 2c                       |
| <b>Acceleration (3 axes)</b>   | 1 m/s <sup>2</sup> – 34 m/s <sup>2</sup> , 8h | SAE J1455, IEC 60068-2-64 category 1                                   |
| <b>Shock (3 axes)</b>  | 300 m/s <sup>2</sup> , 8h                     | SAE J1455, IEC 60068-2-27  |
| <b>Drop</b>  | 1m  | SAE J1455, IEC 60068-2-31  |
| <b>UV</b>  | -   | IEC 60068-2-5, ASTM D4329/D5870/SAE J2020 exposure/index (no cracking) |
| <b>Application</b>   | SAE J1455                                     | Applicable standards   |

### Environmental protection with use of HW shield:

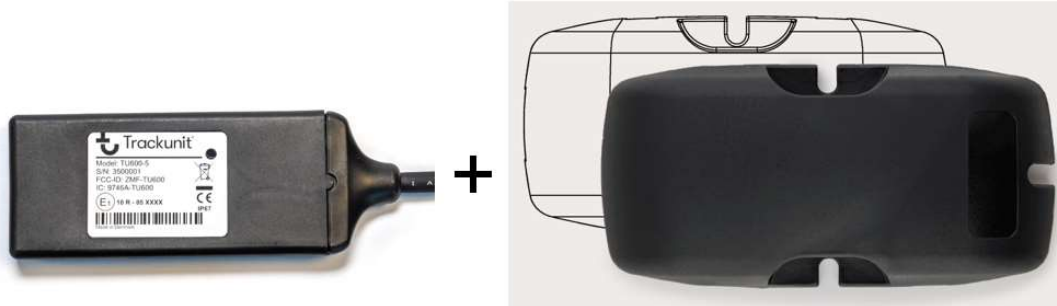

|  | TU600-x inside HW shield                      | Requirements   |
|--|---|--|
| <b>Temperature Soak</b>  | -40°C - +85°C, 48h                            | SAE J1455, IEC 60068-2-1, IEC 60068-2-2                                |
| <b>Humidity</b>  | +45°C to -30°C, RH95%, 8h                     | SAE J1455, IEC 60068-2-78  |
| <b>Salt Spray</b>  | 5%, +35°C, 96h                                | SAE J1455, IEC 61701   |
| <b>Immersion of water</b>  | IPX7  | SAE J1455, IEC 60529 IPX7  |
| <b>Splash of water</b>   | IPX6K   | SAE J1455, IEC 60529 IPX6  |
| <b>Chemicals /oils</b> (Motor oil, Motor oil, Gasoline, Diesel fuel, Hydraulic fluid, Brake fluid, Transmission fluid, Glycol and water mixture) | Splash or Wipe and clean after 5 min          | SAE J1455 (Add for 5 min + clean), IEC 60068-2-74                      |
| <b>Steam cleaning / pressure washing</b>   | IPX9K   | SAE J1455, IEC 60529 up to IPx9K                                       |
| <b>Fungus</b>  | -   |  |
| <b>Dust/wire</b>   | IP6X, Ø1                                      | SAE J1455, ISO 5011, IEC 60529 IP6X, Ø1                                |
| <b>Sand and Gravel Bombardment</b>   | -   | SAE J1455, ISO 5011  |
| <b>Altitude</b>  | -   | IEC 60721-2-3 (700 hPa - 3000 meter)                                   |
| <b>Vibration (3 axes)</b>  | 30 m/s <sup>2</sup> at 10Hz – 2kHz, 8h        | SAE J1455, IEC 60068-2-64 category 1, 2a, 2b, 2c                       |
| <b>Acceleration (3 axes)</b>   | 1 m/s <sup>2</sup> – 34 m/s <sup>2</sup> , 8h | SAE J1455, IEC 60068-2-64 category 1 (A.6)                             |
| <b>Shock (3 axes)</b>  | 300 m/s <sup>2</sup> , 8h                     | SAE J1455, IEC 60068-2-27  |
| <b>Drop</b>  | 1m  | SAE J1455, IEC 60068-2-31  |
| <b>UV</b>  | UV resistant plastic selected                 | IEC 60068-2-5, ASTM D4329/D5870/SAE J2020 exposure/index (no cracking) |
| <b>Application</b>   | SAE J1455                                     | Applicable standards   |



Trackunit Aps  
 Gasvaerksvej 24, 4 sal  
 DK-9000 Aalborg  
 Denmark  
 Phone +45 9673 7400