

BeneVision N1

Patient Monitor

Operator's Manual



© Copyright 2017-2019 Shenzhen Mindray Bio-Medical Electronics Co., Ltd. All rights reserved.

Release time: June 2019

Revision: 7.0

WARNING

- **Federal Law (USA) restricts this device to sale by or on the order of a physician or other practitioner licensed by U.S. state law to use or order the use of this device.**
-
-

Intellectual Property Statement

SHENZHEN MINDRAY BIO-MEDICAL ELECTRONICS CO., LTD. (hereinafter called Mindray) owns the intellectual property rights to this Mindray product and this manual. This manual may refer to information protected by copyrights or patents and does not convey any license under the patent rights of Mindray, nor the rights of others.

Mindray intends to maintain the contents of this manual as confidential information. Disclosure of the information in this manual in any manner whatsoever without the written permission of Mindray is strictly forbidden.

Release, amendment, reproduction, distribution, rental, adaption and translation of this manual in any manner whatsoever without the written permission of Mindray is strictly forbidden.

mindray is the registered trademark owned by Mindray in China and other countries. All other trademarks that appear in this manual are used only for editorial purposes without the intention of improperly using them. They are the property of their respective owners.

Responsibility on the Manufacturer Party

Contents of this manual are subject to changes without prior notice.

Mindray is responsible for the effects on safety, reliability and performance of this product, only if:

- all installation operations, expansions, changes, modifications and repairs of this product are conducted by Mindray authorized personnel;
- the electrical installation of the relevant room complies with the applicable national and local requirements;
- the product is used in accordance with the instructions for use.

WARNING

- **This equipment must be operated by skilled/trained clinical professionals.**
 - **It is important for the hospital or organization that employs this equipment to carry out a reasonable service/maintenance plan. Neglect of this may result in machine breakdown or personal injury.**
-
-

Warranty

THIS WARRANTY IS EXCLUSIVE AND IS IN LIEU OF ALL OTHER WARRANTIES, EXPRESSED OR IMPLIED, INCLUDING WARRANTIES OF MERCHANTABILITY OR FITNESS FOR ANY PARTICULAR PURPOSE.

Exemptions

Mindray's obligation or liability under this warranty does not include any transportation or other charges or liability for direct, indirect or consequential damages or delay resulting from the improper use or application of the product or the use of parts or accessories not approved by Mindray or repairs by people other than Mindray authorized personnel.

This warranty shall not extend to

- Malfunction or damage caused by improper use or man-made failure.
- Malfunction or damage caused by unstable or out-of-range power input.
- Malfunction or damage caused by force majeure such as fire and earthquake.
- Malfunction or damage caused by improper operation or repair by unqualified or unauthorized service people.
- Malfunction of the instrument or part whose serial number is not legible enough.
- Others not caused by instrument or part itself.

Company Contact

Manufacturer:	Shenzhen Mindray Bio-Medical Electronics Co., Ltd.
Address	Mindray Building, Keji 12th Road South, High-tech Industrial Park, Nanshan, Shenzhen 518057, P.R.China
Website	www.mindray.com
E-mail Address:	service@mindray.com.cn
Tel:	+86 755 81888998
Fax:	+86 755 26582680
EC-Representative:	Shanghai International Holding Corp. GmbH (Europe)
Address:	Eiffestraße 80, 20537 Hamburg, Germany
Tel:	0049-40-2513175
Fax:	0049-40-255726

Preface

Manual Purpose

This manual contains the instructions necessary to operate the product safely and in accordance with its function and intended use. Observance of this manual is a prerequisite for proper product performance and correct operation and ensures patient and operator safety.

This manual is based on the maximum configuration and therefore some contents may not apply to your product. If you have any question, please contact us.

This manual is an integral part of the product. It should always be kept close to the equipment so that it can be obtained conveniently when needed.

Intended Audience

This manual is geared for clinical professionals who are expected to have a working knowledge of medical procedures, practices and terminology as required for monitoring of critically ill patients.

Illustrations

All illustrations in this manual serve as examples only. They may not necessarily reflect the setup or data displayed on your patient monitor.

Conventions

- *Italic text* is used in this manual to quote the referenced manuals, chapters, sections and formulas.
- **Bold text** is used to indicate the screen texts and names of hard keys.
- → is used to indicate operational procedures.

Contents

1 Safety	1 - 1
1.1 Safety Information	1 - 1
1.1.1 Warnings	1 - 1
1.1.2 Cautions	1 - 2
1.1.3 Notes	1 - 2
1.2 Equipment Symbols	1 - 2
2 Equipment Introduction	2 - 1
2.1 Indications for Use	2 - 1
2.2 Applied Parts	2 - 1
2.3 Main Unit	2 - 1
2.3.1 Front View	2 - 1
2.3.2 Left View	2 - 2
2.3.3 Right View	2 - 3
2.3.4 Bottom View	2 - 3
2.4 Modular Rack	2 - 3
2.4.1 Left View	2 - 4
2.4.2 Right View	2 - 4
2.5 Dock	2 - 4
2.5.1 Left View	2 - 5
2.5.2 Right View	2 - 5
2.5.3 Rear View	2 - 6
2.6 External Parameter Modules	2 - 6
2.7 Installation	2 - 7
2.7.1 Installing the N1 or External Parameter Module into the Modular Rack	2 - 7
2.7.2 Removing the N1 or External Parameter Module from the Modular Rack	2 - 7
2.7.3 Installing the Modular Rack to the Dock	2 - 8
2.7.4 Removing the Modular Rack from the Dock	2 - 8
2.7.5 Installing the N1 to the Dock	2 - 8
2.7.6 Removing the N1 from the Dock	2 - 9
2.8 N1 in Use with the Host Monitor	2 - 9
2.8.1 Connecting N1 to the Host Monitor through the Module Rack	2 - 10
2.8.2 Connecting N1 to the Host Monitor through the Satellite Module Rack (SMR)	2 - 10
2.8.3 Connecting N1 to the Host Monitor through the Dock	2 - 10
2.9 N1 in Use with the Transport Dock	2 - 11
2.10 Input Devices	2 - 11
2.11 Printing Devices	2 - 11
3 Getting Started	3 - 1
3.1 Equipment Preparation Safety Information	3 - 1
3.2 Unpacking and Checking	3 - 1
3.3 Environmental Requirements	3 - 2
3.4 Setting Up the Equipment	3 - 2
3.4.1 Connecting the AC Mains	3 - 2

3.4.2 Connecting the Input Devices	3 - 3
3.4.3 Installing the External Parameter Module	3 - 3
3.4.4 Turning on the Monitor	3 - 3
3.5 Operation and Navigation	3 - 3
3.5.1 Using the Touchscreen	3 - 3
3.5.2 Using the Mouse	3 - 4
3.5.3 Using the On-Screen Keyboard	3 - 4
3.5.4 Using the Barcode Reader	3 - 4
3.6 Screen Display	3 - 5
3.6.1 On-screen Symbols	3 - 6
3.6.2 Menus	3 - 7
3.6.3 Quick Keys of the N1	3 - 8
3.6.4 Quick keys of the independent external display	3 - 8
3.6.5 Configuring the Displayed Quick Keys (only available for the independent external display)	3 - 10
3.7 Operating Modes	3 - 10
3.7.1 Monitoring Mode	3 - 10
3.7.2 Module Mode	3 - 10
3.7.3 Privacy Mode	3 - 10
3.7.4 Night Mode	3 - 11
3.7.5 Standby Mode	3 - 12
3.7.6 Outdoor Mode	3 - 12
3.8 Configuring Your Monitor	3 - 13
3.8.1 Selecting the Language	3 - 13
3.8.2 Setting the Date and Time	3 - 13
3.8.3 Enabling Auto Daylight Saving Time	3 - 13
3.8.4 Setting the Unit	3 - 14
3.8.5 Adjusting the Screen Brightness	3 - 14
3.8.6 Adjusting the Key Volume	3 - 14
3.9 Starting Monitoring a Patient	3 - 14
3.10 Stopping a Parameter Measurement	3 - 14
3.11 General Operation	3 - 14
3.11.1 Switching On or Off a Parameter	3 - 14
3.11.2 Displaying Parameter Numerics and Waveforms	3 - 15
3.11.3 Accessing Parameter Setup Menus	3 - 15
3.11.4 Choosing a Screen	3 - 15
3.11.5 Selecting the Big Numerics Screen	3 - 15
3.11.6 Changing Measurement Colors	3 - 16
3.12 Using the On-Screen Timers	3 - 16
3.12.1 Displaying Timers	3 - 16
3.12.2 Setting the Timer	3 - 16
3.13 Using the External Display	3 - 17
3.13.1 Connecting the N1 to the External Display	3 - 17
3.13.2 Setting the External Display	3 - 17
3.13.3 External Display Troubleshooting	3 - 18
3.14 The OxyCRG Screen (only available for the independent external display)	3 - 18
3.14.1 Entering the OxyCRG Screen	3 - 18
3.14.2 OxyCRG Events	3 - 18
3.14.3 The Display of the ABD Event Area	3 - 19

3.14.4 Setting OxyCRG Parameters	3 - 19
3.14.5 Setting the Threshold of ABD Events	3 - 19
3.14.6 Editing ABD Events	3 - 19
3.15 Turning Off the Monitor	3 - 19
4 Managing Patients	4 - 1
4.1 Discharging a Patient	4 - 1
4.1.1 Auto Discharging a Patient after Monitor Power Off	4 - 1
4.1.2 Manually Discharging a Patient	4 - 1
4.2 Admitting a Patient	4 - 2
4.3 Managing Patient Information	4 - 2
4.3.1 Entering the Patient Management Menu	4 - 2
4.3.2 Editing Patient Information	4 - 2
4.3.3 Loading Patient Information from the CMS	4 - 2
4.3.4 Loading Patient Information from the ADT Server	4 - 3
4.3.5 Selecting Query Criteria for Searching Patients in ADT Server	4 - 3
4.3.6 Changing Patient Management Settings	4 - 3
4.3.7 Setting Monitor Information	4 - 3
4.3.8 Setting Monitor Location	4 - 4
4.3.9 Setting Patient Location	4 - 4
4.3.10 Hiding Patient Name	4 - 4
4.4 Transferring Patient Data	4 - 4
4.5 Setting the Dock	4 - 5
4.5.1 Setting the Work Mode	4 - 5
4.5.2 Setting the Net Setting Type	4 - 5
4.5.3 Setting the Network of the Dock	4 - 5
4.5.4 Setting the External Display	4 - 6
4.6 Connecting the CMS	4 - 6
5 Managing Configurations	5 - 1
5.1 Configuration Introduction	5 - 1
5.2 Changing the Department	5 - 1
5.3 Setting Default Configuration	5 - 1
5.4 Saving Current Settings	5 - 2
5.5 Deleting a Configuration	5 - 2
5.6 Transferring a Configuration	5 - 2
5.6.1 Exporting a Configuration	5 - 2
5.6.2 Importing a Configuration	5 - 3
5.7 Loading a Configuration	5 - 3
5.8 Modifying Configuration Password	5 - 3
6 Networked Monitoring	6 - 1
6.1 Network Introduction	6 - 1
6.2 Network Safety Information	6 - 1
6.3 Connecting the Monitor to the CMS	6 - 1
6.3.1 Setting the CMS	6 - 1
6.3.2 Selecting a CMS	6 - 1
6.4 Connecting the eGateway	6 - 2

6.5 Using the ADT Gateway	6 - 2
6.6 Sending Realtime Data, Waveforms and Alarms via HL7 Protocol	6 - 2
6.7 Viewing Other Patients (Only available for the independent external display)	6 - 2
6.7.1 Remote View	6 - 3
6.7.2 Alarm Watch	6 - 5
6.8 Configuring the Network	6 - 6
6.8.1 Setting the Wireless Network	6 - 6
6.8.2 Disconnecting the Wireless Network	6 - 6
6.8.3 Selecting WLAN Band and Channels	6 - 6
6.8.4 Managing Certifications	6 - 6
6.8.5 Setting Multicast Parameters	6 - 7
6.8.6 Setting the Network Service Quality Level	6 - 7
6.8.7 Selecting Data Encryption Type	6 - 7
6.8.8 Disabling the Broadcasting Patient Demographics Function	6 - 7
6.9 MLDAP	6 - 8
6.9.1 Setting MLDAP	6 - 8
6.9.2 Testing MLDAP Server Connection	6 - 8
6.9.3 Selecting Password for User Authentication	6 - 8
6.9.4 Setting the Password Timeout Period	6 - 9
7 Alarms	7 - 1
7.1 Alarm Introduction	7 - 1
7.2 Alarm Safety Information	7 - 1
7.3 Understanding the Alarms	7 - 1
7.3.1 Alarm Categories	7 - 1
7.3.2 Alarm Priorities	7 - 2
7.3.3 Alarm Indicators	7 - 2
7.3.4 Alarm Status Symbols	7 - 3
7.4 Accessing On-screen Help for Technical Alarms (AlarmSight)	7 - 3
7.5 Checking Physiological Alarm List	7 - 3
7.6 Changing Alarm Settings	7 - 3
7.6.1 Setting Parameter Alarm Properties	7 - 3
7.6.2 Setting Alarm Tone Properties	7 - 4
7.6.3 Initiating Auto Alarm Limits	7 - 5
7.6.4 Setting the Alarm Delay Time	7 - 7
7.6.5 Adjusting the Alarm Light Brightness	7 - 8
7.6.6 Setting the Length of Printing Duration On Alarm	7 - 8
7.6.7 Setting the Switch of the CMS and eGateway Disconnection Alarm	7 - 8
7.6.8 Setting the Priority of the CMS and eGateway Disconnection Alarm	7 - 8
7.6.9 Setting the Switch of the SpO ₂ Desat Alarm Off	7 - 8
7.6.10 Setting the Switch of the Zero RR Alarm Off	7 - 9
7.7 Pausing Alarms/Pausing Alarm Tones	7 - 9
7.7.1 Defining the Pause Function	7 - 9
7.7.2 Pausing Alarms	7 - 9
7.7.3 Pausing Alarm Sound	7 - 11
7.8 Resetting Alarms	7 - 11
7.8.1 Resetting Physiological Alarms	7 - 12
7.8.2 Resetting Technical Alarms	7 - 12

7.8.3 Setting Alarm Light Status on Alarm Reset	7 - 12
7.9 Latching Alarms	7 - 12
7.10 CPB Mode	7 - 13
7.10.1 Entering the CPB Mode	7 - 13
7.10.2 Exiting the CPB Mode	7 - 13
7.11 Intubation Mode	7 - 13
7.11.1 Entering the Intubation Mode	7 - 13
7.11.2 Setting the Intubation Time	7 - 13
7.11.3 Exiting the Intubation Mode	7 - 13
7.12 Managing Alarms from Remote Devices (only available for the independent external display)	7 - 14
7.12.1 Setting the Tone Pattern for Alarms from Remote Devices	7 - 14
7.12.2 Selecting the Alarm Reminder for Remote Devices	7 - 14
7.12.3 Presenting Alarm Sound for Remote Devices as per Alarm Priority	7 - 14
7.12.4 Resetting Alarms for Remote Devices	7 - 15
7.12.5 Authorizing the Alarm Reset to Other Devices	7 - 15
7.12.6 Switching Off the Remote Device Disconnection Alarm	7 - 15
7.13 Testing Alarms	7 - 15
7.14 Actions When an Alarm Occurs	7 - 15
8 Monitoring ECG, Arrhythmia, ST and QT	8 - 1
8.1 ECG Introduction	8 - 1
8.2 ECG Safety Information	8 - 1
8.3 ECG Display	8 - 2
8.4 Preparing for ECG Monitoring	8 - 2
8.4.1 Preparing the Patient Skin	8 - 2
8.4.2 Applying Electrodes	8 - 2
8.4.3 Lead Wire Color Code	8 - 3
8.4.4 ECG Electrode Placements	8 - 3
8.4.5 Choosing the ECG Lead Type	8 - 5
8.4.6 Checking Paced Status	8 - 5
8.4.7 Enabling Pacer Rejection	8 - 6
8.5 Changing ECG Settings	8 - 6
8.5.1 Choosing an ECG Screen	8 - 6
8.5.2 Setting ECG Alarm Properties	8 - 6
8.5.3 Changing ECG Wave Settings	8 - 7
8.5.4 Disabling the Smart Lead Off Function	8 - 8
8.5.5 Setting the Priority of the ECG Lead Off Alarm	8 - 8
8.5.6 Adjusting the QRS Volume	8 - 9
8.5.7 Adjusting the Minimum QRS Detection Threshold	8 - 9
8.5.8 Selecting the ECG Standard	8 - 9
8.6 Monitoring Arrhythmia	8 - 9
8.6.1 Arrhythmia Safety Information	8 - 10
8.6.2 Arrhythmia Events	8 - 10
8.6.3 Displaying Arrhythmia Information	8 - 11
8.6.4 Changing Arrhythmia Settings	8 - 11
8.6.5 Arrhythmia Alarms Timeout	8 - 14
8.7 ST Segment Monitoring	8 - 15
8.7.1 ST Safety Information	8 - 15

8.7.2 Enabling ST Monitoring	8 - 15
8.7.3 Displaying ST Numerics	8 - 16
8.7.4 Displaying ST Segments in the Waveform Area	8 - 16
8.7.5 Entering the ST View	8 - 17
8.7.6 Saving the Current ST as Baseline	8 - 17
8.7.7 Entering the ST Graphic Window (only available for the independent external display)	8 - 17
8.8 Changing ST Settings	8 - 18
8.8.1 Setting ST Alarm Properties	8 - 18
8.8.2 Adjusting ST Measurement Points	8 - 19
8.9 QT/QTc Interval Monitoring	8 - 20
8.9.1 QT/QTc Monitoring Limitations	8 - 20
8.9.2 Enabling QT/QTc Monitoring	8 - 21
8.9.3 Displaying QT/QTc Numerics and Segments	8 - 21
8.9.4 Entering the QT View	8 - 21
8.9.5 Changing the Current QTc as Baseline	8 - 22
8.9.6 Changing QT Settings	8 - 22
8.10 ECG Relearning	8 - 23
8.10.1 Auto ECG Relearning	8 - 23
8.10.2 Initiating an ECG Relearning Manually	8 - 23
8.11 Calibrating ECG	8 - 23
8.12 Defibrillation Synchronization Pulse Output	8 - 24
8.13 ECG Troubleshooting	8 - 24
9 Resting 12-Lead ECG Analysis	9 - 1
9.1 Resting 12-Lead ECG Analysis Introduction	9 - 1
9.2 Entering the 12-Lead Screen	9 - 1
9.3 Initiating Resting 12-Lead ECG Analysis	9 - 1
9.4 Changing 12-Lead ECG Analysis Settings	9 - 1
9.4.1 Setting the High Frequency Filter	9 - 1
9.4.2 Setting the Baseline Drift Removal	9 - 2
9.4.3 Setting the 12-Lead Waveform Layout	9 - 2
9.5 Glasgow Resting 12-lead ECG Analysis Algorithm Settings	9 - 2
9.5.1 Editing Patient Information (For Glasgow Algorithms)	9 - 2
9.5.2 Setting Tachycardia and Bradycardia Thresholds (For Glasgow Algorithms)	9 - 3
9.5.3 Setting the 12-Lead Interpretation Report (For Glasgow Algorithms)	9 - 3
9.6 Saving the 12-Lead Interpretation Report	9 - 3
9.7 Printing the 12-Lead Interpretation Report	9 - 3
9.8 Exiting the ECG 12-Lead Screen	9 - 3
10 Monitoring Respiration (Resp)	10 - 1
10.1 Resp Introduction	10 - 1
10.2 Resp Safety Information	10 - 1
10.3 Resp Display	10 - 2
10.4 Preparing for Resp Monitoring	10 - 2
10.4.1 Preparing the Patient	10 - 2
10.4.2 Placing the Electrodes	10 - 3
10.5 Changing Resp Settings	10 - 4

10.5.1 Setting the Resp Alarm Properties	10 - 4
10.5.2 Setting the RR Source	10 - 4
10.5.3 Choosing the Respiration Lead	10 - 4
10.5.4 Setting the Resp Waveform Size	10 - 4
10.5.5 Setting the Resp Waveform Speed	10 - 4
10.5.6 Setting the Auto Detection Switch	10 - 5
10.5.7 Adjusting the Resp Waveform Detection Threshold	10 - 5
10.6 Resp Troubleshooting	10 - 5
11 Monitoring Pulse Oxygen Saturation (SpO₂)	11 - 1
11.1 SpO ₂ Introduction	11 - 1
11.2 SpO ₂ Safety Information	11 - 1
11.3 SpO ₂ Measurement Limitations	11 - 2
11.4 SpO ₂ Display	11 - 3
11.5 Preparing for SpO ₂ Monitoring	11 - 3
11.6 Changing the SpO ₂ Settings	11 - 4
11.6.1 Changing the SpO ₂ Alarm Settings	11 - 4
11.6.2 Nellcor Sat-Seconds Alarm Management	11 - 4
11.6.3 Setting the Nellcor SpO ₂ Sat-Seconds	11 - 5
11.6.4 Setting SpO ₂ Sensitivity (for Masimo SpO ₂ Module)	11 - 5
11.6.5 Enabling FastSAT (for Masimo SpO ₂)	11 - 5
11.6.6 Displaying SIQ (for Masimo SpO ₂)	11 - 6
11.6.7 Changing the Sensitivity	11 - 6
11.6.8 Monitoring SpO ₂ and NIBP Simultaneously	11 - 6
11.6.9 Changing the Sweep Speed of the Pleth Wave	11 - 6
11.6.10 Setting the Alarm Priority for SpO ₂ Sensor Off Alarm	11 - 6
11.6.11 Setting the SpO ₂ Tone Mode	11 - 7
11.7 Changing the PR Settings	11 - 7
11.7.1 Changing the PR Alarm Settings	11 - 7
11.7.2 Changing the QRS Volume	11 - 7
11.7.3 Setting the PR Source	11 - 7
11.8 SpO ₂ Troubleshooting	11 - 8
11.9 Nellcor Information	11 - 8
11.9.1 Masimo Information	11 - 9
12 Monitoring Temperature (Temp)	12 - 1
12.1 Temperature Introduction	12 - 1
12.2 Displaying the Temp Numerics Area	12 - 1
12.3 Temperature Display	12 - 1
12.4 Preparing for Temperature Monitoring	12 - 1
12.5 Changing Temperature Settings	12 - 2
12.5.1 Setting the Temperature Alarm Properties	12 - 2
12.5.2 Selecting the Temperature Label	12 - 2
12.5.3 Displaying the Temperature Difference	12 - 2
12.6 Temperature Troubleshooting	12 - 2
13 Monitoring Noninvasive Blood Pressure (NIBP)	13 - 1
13.1 NIBP Introduction	13 - 1

13.2 NIBP Safety Information	13 - 1
13.3 NIBP Measurement Limitations	13 - 2
13.4 Measurement Modes	13 - 2
13.5 NIBP Display	13 - 2
13.6 Preparing for NIBP Measurements	13 - 3
13.6.1 Preparing the Patient for NIBP Measurements	13 - 3
13.6.2 Placing the NIBP Cuff	13 - 3
13.7 Starting and Stopping NIBP Measurements	13 - 4
13.8 Changing NIBP Settings	13 - 4
13.8.1 Setting the NIBP Alarm Properties	13 - 4
13.8.2 Setting the Initial Cuff Inflation Pressure	13 - 4
13.8.3 Setting the NIBP Interval	13 - 5
13.8.4 Selecting NIBP Start Mode	13 - 5
13.8.5 Enabling the NIBP End Tone	13 - 5
13.8.6 Setting NIBP Sequence	13 - 5
13.8.7 Setting NIBP Measurement Timeout	13 - 5
13.8.8 Displaying the NIBP List	13 - 5
13.8.9 Correcting the NIBP Measurements	13 - 6
13.9 Assisting Venous Puncture	13 - 6
13.10 NIBP Maintenance	13 - 6
13.10.1 NIBP Leakage Test	13 - 6
13.10.2 NIBP Accuracy Test	13 - 6
13.11 NIBP Troubleshooting	13 - 6
14 Monitoring Invasive Blood Pressure (IBP)	14 - 1
14.1 IBP Introduction	14 - 1
14.2 IBP Safety Information	14 - 1
14.3 Preparing for IBP Monitoring	14 - 2
14.3.1 IBP Equipment to Patient Connection	14 - 2
14.3.2 Measuring an Invasive Blood Pressure	14 - 2
14.3.3 Zeroing the IBP transducer	14 - 3
14.4 Measuring ICP Using the Codman ICP Transducer	14 - 3
14.4.1 Zeroing the Codman ICP transducer	14 - 3
14.4.2 Measuring ICP	14 - 3
14.5 IBP Display	14 - 4
14.6 Changing IBP Settings	14 - 4
14.6.1 Changing the IBP Alarm Settings	14 - 4
14.6.2 Changing the Pressure Label	14 - 4
14.6.3 Setting the Pressure Type for Display	14 - 5
14.6.4 Changing the Sensitivity	14 - 5
14.6.5 Setting the IBP Waveform	14 - 5
14.6.6 Setting the Use PA-D as PAWP Switch (only available for the independent external display)	14 - 6
14.6.7 Enabling PPV Measurement	14 - 6
14.6.8 Changing the Pressure Unit	14 - 6
14.6.9 Overlapping IBP Waveforms	14 - 6
14.7 Measuring PAWP (only available for the independent external display)	14 - 7
14.7.1 PAWP Equipment to Patient Connection	14 - 8

14.7.2	Preparing to Measure PAWP	14 - 8
14.7.3	Measuring PAWP	14 - 8
14.7.4	Setting the Waveforms of the PAWP Screen	14 - 9
14.7.5	Performing Hemodynamic Calculation (only available for the independent external display)	14 - 10
14.8	IBP Troubleshooting	14 - 10
15	Monitoring Carbon Dioxide (CO₂)	15 - 1
15.1	CO ₂ Introduction	15 - 1
15.2	CO ₂ Safety Information	15 - 2
15.3	CO ₂ Measurement Limitations	15 - 2
15.4	CO ₂ Display	15 - 3
15.5	Measuring CO ₂ Using Sidestream/Microstream CO ₂ Module	15 - 3
15.5.1	Preparing to Measure CO ₂ Using Sidestream CO ₂ Module	15 - 3
15.5.2	Preparing to Measure CO ₂ Using Microstream CO ₂ Module	15 - 5
15.5.3	Zeroing the Sidestream/Microstream CO ₂ Module	15 - 6
15.6	Measuring CO ₂ Using Mainstream CO ₂ Module	15 - 6
15.6.1	Preparing to Measure CO ₂ Using Mainstream CO ₂ Module	15 - 6
15.6.2	Zeroing the Mainstream CO ₂ sensor	15 - 7
15.7	Changing Settings for All CO ₂ Modules	15 - 8
15.7.1	Changing CO ₂ Alarm Settings	15 - 8
15.7.2	Changing the CO ₂ Unit	15 - 8
15.7.3	Setting the CO ₂ Waveform	15 - 8
15.7.4	Setting the RR Source	15 - 8
15.7.5	Entering the Standby Mode	15 - 8
15.7.6	Entering the Intubation Mode	15 - 9
15.8	Changing Settings for Sidestream and Microstream CO ₂ Module	15 - 9
15.8.1	Setting the Auto Standby	15 - 9
15.8.2	Setting Humidity Compensation	15 - 9
15.8.3	Setting Flow Rate (For Sidestream CO ₂ Module Without O ₂)	15 - 9
15.9	Changing O ₂ Settings (For Sidestream CO ₂ Module Integrating O ₂)	15 - 10
15.9.1	Changing O ₂ Alarm Settings	15 - 10
15.9.2	Changing the O ₂ Unit	15 - 10
15.9.3	Setting the O ₂ Waveform	15 - 10
15.10	Setting the Gas Compensation	15 - 10
15.11	Choosing a Time Interval for Peak-Picking	15 - 11
15.12	Changing Barometric Pressure	15 - 11
15.13	Performing the Leakage Test	15 - 11
15.14	CO ₂ Calibration	15 - 12
15.15	Test Method Used to Determine the Respiration Rate Measuring Range	15 - 12
15.16	CO ₂ Troubleshooting	15 - 12
15.16.1	Troubleshooting the Sidestream/Microstream CO ₂ Module	15 - 12
15.16.2	Troubleshooting the Mainstream CO ₂ Module	15 - 13
15.17	Oridion Information	15 - 13
16	Review	16 - 1
16.1	Review Overview	16 - 1
16.2	Review Page	16 - 1

16.2.1	Accessing the Review Page	16 - 1
16.2.2	Example Review Page	16 - 1
16.2.3	Symbols on Review Pages	16 - 2
16.2.4	Common Operations	16 - 2
16.2.5	Reviewing the Tabular Trends	16 - 3
16.2.6	Reviewing the Graphics Trends	16 - 3
16.2.7	Events Review Page	16 - 4
16.2.8	Viewing the Full Disclosure	16 - 6
16.2.9	OxyCRG Review Page (available for the independent external display)	16 - 7
16.2.10	12-Lead ECG Review Page	16 - 8
16.3	Minitrends Screen (only available for the independent external display)	16 - 8
16.3.1	Entering the Minitrends Screen	16 - 8
16.3.2	Viewing the Long Trends	16 - 9
16.3.3	Setting Parameters	16 - 9
16.3.4	Setting the Minitrend Length	16 - 9
16.3.5	Exiting the Minitrends Screen	16 - 9
16.4	Hiding Undesired Review Tabs	16 - 9
17	Clinical Assistive Applications (only available for the independent external display)	17 - 1
17.1	Early Warning Score (EWS)	17 - 1
17.1.1	Displaying the EWS Numerics Area	17 - 1
17.1.2	Accessing the EWS Screen	17 - 2
17.1.3	Performing EWS Scoring	17 - 3
17.1.4	Changing EWS Settings	17 - 4
17.2	Glasgow Coma Scale (GCS)	17 - 5
17.2.1	Displaying the GCS Parameter Area	17 - 5
17.2.2	Accessing the GCS Menu	17 - 6
17.2.3	Performing GCS Scoring	17 - 6
17.2.4	Setting GCS Scoring Interval	17 - 7
17.2.5	Setting Threshold and Color for Each Consciousness Level	17 - 7
17.2.6	Reviewing GCS Trend Data	17 - 7
17.3	SepsisSight™	17 - 7
17.3.1	Accessing the SepsisSight Dialog	17 - 8
17.3.2	Screening	17 - 8
17.3.3	Recommendations	17 - 8
17.3.4	Reviewing SepsisSight Trend Data	17 - 9
17.4	Rescuing Mode	17 - 9
17.4.1	Entering the Rescue Mode	17 - 9
17.4.2	CPR Dashboard	17 - 9
17.4.3	Exit the Rescue Mode	17 - 10
18	Calculation (only available for the independent external display)	18 - 1
18.1	Calculation Overview	18 - 1
18.2	Calculation Safety Information	18 - 1
18.3	Drug Calculations	18 - 1
18.3.1	Performing Drug Calculations	18 - 1
18.3.2	Checking the Titration Table	18 - 2
18.3.3	Drug Calculation Formula	18 - 2
18.3.4	Titration Table Calculation Formula	18 - 2

18.4 Hemodynamic Calculations	18 - 3
18.4.1 Performing Hemodynamic Calculations	18 - 3
18.4.2 Input Parameters for Hemodynamic Calculations	18 - 3
18.4.3 Calculated Parameters and Formulas for Hemodynamic Calculations	18 - 3
18.5 Oxygenation Calculations	18 - 4
18.5.1 Performing Oxygenation Calculations	18 - 4
18.5.2 Input Parameters for Oxygenation Calculations	18 - 5
18.5.3 Calculated Parameters and Formulas for Oxygenation Calculations	18 - 5
18.6 Ventilation Calculations	18 - 6
18.6.1 Performing Ventilation Calculations	18 - 6
18.6.2 Input Parameters for Ventilation Calculations	18 - 6
18.6.3 Calculated Parameters and Formulas for Ventilation Calculations	18 - 6
18.7 Renal Calculations	18 - 7
18.7.1 Performing Renal Calculations	18 - 7
18.7.2 Calculated Parameters and Formulas for Renal Calculations	18 - 7
18.7.3 Calculated Parameters and Formulas for Renal Calculations	18 - 7
19 Printing	19 - 1
19.1 Printer	19 - 1
19.2 Setting the Printer	19 - 1
19.3 Setting Patient Information on the Reports	19 - 1
19.3.1 Setting Patient Information on ECG Reports	19 - 1
19.3.2 Setting Patient Information on Other Reports	19 - 2
19.4 Setting End Case Reports	19 - 2
19.5 Manually Starting a Printing Task	19 - 2
19.5.1 Starting Printing from the Current Page	19 - 2
19.5.2 Printing Realtime Reports	19 - 2
19.5.3 Printing Normal Reports	19 - 2
19.6 Automatically Printing Reports	19 - 2
19.7 Stopping a Printing Task	19 - 3
19.8 Setting Reports	19 - 3
19.8.1 Setting ECG Reports	19 - 3
19.8.2 Setting Realtime Reports	19 - 4
19.8.3 Setting Tabular Trends Reports	19 - 4
19.8.4 Setting Graphic Trends Reports	19 - 4
19.8.5 Showing the Second Mark	19 - 4
19.9 Viewing Printer Statuses	19 - 4
19.10 Printer Out of Paper	19 - 5
20 Battery	20 - 1
20.1 Battery Introduction	20 - 1
20.2 Battery Safety Information	20 - 1
20.3 Installing the Battery	20 - 1
20.4 Battery Indications	20 - 2
20.4.1 Battery LED	20 - 2
20.4.2 Battery Symbols	20 - 2
20.4.3 Battery Power Indicator	20 - 2

20.4.4 Battery-related Alarms	20 - 2
20.4.5 Checking the Battery Information	20 - 3
20.5 Charging the Battery	20 - 3
20.6 Maintaining the Battery	20 - 3
20.6.1 Conditioning the Battery	20 - 3
20.6.2 Checking Battery Performance	20 - 3
20.7 Storing the Battery	20 - 4
20.8 Recycling the Battery	20 - 4
21 Care and Cleaning	21 - 1
21.1 Care and Cleaning Introduction	21 - 1
21.2 Care and Cleaning Safety Information	21 - 1
21.3 Recommended Cleaning and Disinfection Agents	21 - 1
21.4 General Cleaning Methods	21 - 2
21.5 Disinfection	21 - 2
21.6 Sterilization	21 - 2
21.7 Cleaning, Disinfecting and Sterilizing Monitoring Accessories	21 - 3
21.8 Impact of Improper Cleaning	21 - 3
22 Maintenance	22 - 1
22.1 Maintenance Introduction	22 - 1
22.2 Maintenance Safety Information	22 - 1
22.3 Maintenance and Testing Schedule	22 - 2
22.4 Checking Version Information	22 - 2
22.5 Testing Methods and Procedures	22 - 2
22.5.1 Performing Visual Inspection	22 - 3
22.5.2 Performing Power-on Test	22 - 3
22.5.3 Testing the Network Printer	22 - 3
22.5.4 Checking the Battery	22 - 3
22.6 Disposing of the Monitor	22 - 3
23 Accessories	23 - 1
23.1 ECG Accessories	23 - 1
23.1.1 ECG Electrodes	23 - 1
23.1.2 12-Pin Trunk Cables	23 - 1
23.1.3 3-lead ECG Leadwires	23 - 2
23.1.4 5-lead ECG Leadwires	23 - 2
23.1.5 6-lead ECG Leadwires	23 - 3
23.1.6 12-lead ECG Leadwire	23 - 3
23.2 SpO ₂ Accessories	23 - 3
23.2.1 Extension Cables	23 - 3
23.2.2 Mindray SpO ₂ Sensors	23 - 4
23.2.3 Masimo SpO ₂ Sensors	23 - 4
23.2.4 Nellcor SpO ₂ Sensors	23 - 5
23.3 Temp Accessories	23 - 5
23.3.1 Temp Cable	23 - 5
23.3.2 Temp Probes	23 - 5

23.4 NIBP Accessories	23 - 6
23.4.1 NIBP Hoses	23 - 6
23.4.2 Cuffs	23 - 6
23.5 IBP Accessories	23 - 7
23.5.1 IBP Accessories	23 - 7
23.5.2 ICP Accessories	23 - 7
23.6 CO ₂ Accessories	23 - 7
23.6.1 Sidestream CO ₂ Accessories	23 - 7
23.6.2 Microstream CO ₂ Accessories	23 - 8
23.6.3 Mainstream CO ₂ Accessories	23 - 9

A Product Specifications A - 1

A.1 Monitor Safety Specifications	A - 1
A.2 Physical Specifications	A - 1
A.3 Environmental Specifications	A - 2
A.4 Power Supply Specifications	A - 3
A.4.1 External Power Supply Specifications	A - 3
A.4.2 Battery Specifications	A - 3
A.5 Display Specifications	A - 4
A.6 Touchscreen Specifications	A - 4
A.7 LEDs	A - 4
A.7.1 Main Unit	A - 4
A.7.2 Dock	A - 4
A.7.3 Transport Dock	A - 4
A.7.4 AC Adapter	A - 5
A.8 Audio Indicator	A - 5
A.9 Monitor Interface Specifications	A - 5
A.9.1 Interface Specifications of the Main Unit	A - 5
A.9.2 Interface Specifications of the Modular Rack	A - 5
A.9.3 Interface Specifications of the Dock	A - 5
A.10 Signal Outputs Specifications	A - 6
A.11 Data Storage	A - 6
A.12 Out-Of-Hospital Transport - Standards Compliance	A - 7
A.13 Wi-Fi Specifications	A - 8
A.13.1 Wi-Fi Technical Specifications	A - 8
A.13.2 Wi-Fi Performance Specifications	A - 8
A.14 Measurement Specifications	A - 9
A.14.1 ECG Specifications	A - 9
A.14.2 Resp Specifications	A - 12
A.14.3 SpO ₂ Specifications	A - 13
A.14.4 PR Specifications	A - 14
A.14.5 Temp Specifications	A - 16
A.14.6 NIBP Specifications	A - 16
A.14.7 IBP Specifications	A - 17
A.14.8 CO ₂ Specifications	A - 18

B EMC and Radio Regulatory Compliance B - 1

B.1 EMC	B - 1
B.2 Radio Regulatory Compliance	B - 4
C Default Settings	C - 1
C.1 ECG, Arrhythmia, ST and QT Default Settings	C - 1
C.1.1 ECG Default Settings	C - 1
C.1.2 Arrhythmia Default Settings	C - 2
C.1.3 ST Default Settings	C - 3
C.1.4 QT Default Settings	C - 4
C.1.5 Glasgow 12-lead ECG Algorithm Default Settings	C - 4
C.2 Respiration Default Settings	C - 4
C.3 SpO ₂ Default Settings	C - 5
C.4 Temperature Default Settings	C - 6
C.4.1 Temperature Default Settings	C - 6
C.5 NIBP Default Settings	C - 6
C.6 IBP Default Settings	C - 8
C.7 CO ₂ Default Settings	C - 11
C.7.1 General Settings	C - 11
C.7.2 Sidestream CO ₂ Default Settings	C - 12
C.7.3 Microstream CO ₂ Default Settings	C - 12
C.7.4 Mainstream CO ₂ Default Settings	C - 12
C.8 Alarm Default Settings	C - 13
D Alarm Messages	D - 1
D.1 Physiological Alarm Messages	D - 1
D.1.1 General Physiological Alarm Messages	D - 1
D.1.2 Arrhythmia Alarm Messages	D - 1
D.1.3 Resp Physiological Alarm Messages	D - 2
D.1.4 SpO ₂ Physiological Alarm Messages	D - 2
D.1.5 PR Physiological Alarm Messages	D - 2
D.1.6 NIBP Physiological Alarm Messages	D - 2
D.1.7 IBP Physiological Alarm Messages	D - 2
D.1.8 CO ₂ Physiological Alarm Messages	D - 3
D.2 Technical Alarm Messages	D - 3
D.2.1 General Technical Alarm Messages	D - 3
D.2.2 ECG Technical Alarm Messages	D - 3
D.2.3 Resp Technical Alarm Messages	D - 4
D.2.4 SpO ₂ Technical Alarm Messages	D - 4
D.2.5 Temp Technical Alarm Messages	D - 5
D.2.6 NIBP Technical Alarm Messages	D - 5
D.2.7 IBP Technical Alarm Messages	D - 5
D.2.8 CO ₂ Technical Alarm Messages	D - 6
D.2.9 Power Supply Technical Alarm Messages	D - 7
D.2.10 Printer Technical Alarm Messages	D - 8
D.2.11 Technical Alarm Messages Related to Networked Monitoring	D - 8
D.2.12 Other System Technical Alarm Messages	D - 8
E Electrical Safety Inspection	E - 1
E.1 Power Cord Plug	E - 1

E.2 Device Enclosure and Accessories	E - 1
E.2.1 Visual Inspection	E - 1
E.2.2 Contextual Inspection	E - 2
E.3 Device Labeling	E - 2
E.4 Protective Earth Resistance	E - 2
E.5 Earth Leakage Test	E - 2
E.6 Patient Leakage Current	E - 3
E.7 Mains on Applied Part Leakage	E - 3
E.8 Patient Auxiliary Current	E - 4
F SpO₂ Sensor Accuracy	F - 1
F.1 The Accuracy of Mindray SpO ₂ Sensors	F - 1
F.2 The Accuracy of Masimo SpO ₂ Sensors	F - 7
F.3 The Accuracy of Nellcor SpO ₂ Sensors	F - 9
G Units, Symbols and Abbreviations	G - 1
G.1 Units	G - 1
G.2 Symbols	G - 2
G.3 Abbreviations	G - 3

1 Safety

1.1 Safety Information

WARNING

- Indicates a potential hazard or unsafe practice that, if not avoided, could result in death or serious injury.
-
-

CAUTION

- Indicates a potential hazard or unsafe practice that, if not avoided, could result in minor personal injury or product/property damage.
-

NOTE

- Provides application tips or other useful information to ensure that you get the most from your product.
-

1.1.1 Warnings

WARNING

- This equipment is used for single patient at a time.
- To avoid explosion hazard, do not use the equipment in the presence of oxygen-rich atmospheres, flammable anesthetics, or other flammable agents.
- MR unsafe: the N Series monitors are not intended to be used within the Magnetic Resonance (MR) environment.
- Before connecting the equipment to the power line, check that the voltage and frequency ratings of the power line are the same as those indicated on the equipment's label or in this manual.
- Before putting the system into operation, the operator must verify that the equipment, connecting cables and accessories are in correct working order and operating condition.
- To avoid risk of electric shock, the equipment must only be connected to mains power with protective earth. If a protective earth conductor is not provided, operate it on battery power, if possible.
- Do not touch the patient and live parts simultaneously. Otherwise patient injury may result.
- Do not come into contact with the patient during defibrillation. Otherwise serious injury or death could result.
- Do not open the equipment housings. All servicing and future upgrades must be carried out by trained and authorized personnel.
- Do not rely exclusively on the audible alarm system for patient monitoring. Turning the alarm volume to a low level or off may result in a hazard to the patient. Remember that alarm settings should be customized according to patient situations. Always keep the patient under close surveillance.
- The physiological data and alarm messages displayed on the equipment are for reference only and cannot be directly used for diagnostic interpretation.
- Route, wrap and secure the cables to avoid inadvertent disconnection, stumbling and entanglement.
- Do not place the equipment or accessories in any position that might cause it to fall on the patient.
- Do not start or operate the equipment unless the setup was verified to be correct.

- The equipment should not be used as the sole basis for medical decisions. It must be used in conjunction with clinical signs and symptom. If any measurement seems questionable, first check the patient's vital signs by alternate means and then check the equipment for proper functioning.
- The software equipment copyright is solely owned by Mindray. No organization or individual shall resort to modifying, copying, or exchanging it or to any other infringement on it in any form or by any means without due permission.

1.1.2 Cautions

CAUTION



- Use only parts and accessories specified in this manual.
- Ensure that the equipment is supplied with continuous electric power during work. Sudden power failure may cause data loss.
- Magnetic and electrical fields are capable of interfering with the proper performance of the equipment. For this reason make sure that all external devices operated in the vicinity of the equipment comply with the relevant EMC requirements. Mobile phone, X-ray equipment or MRI devices are a possible source of interference as they may emit higher levels of electromagnetic radiation.
- Always install or carry the equipment properly to avoid damage caused by drop, impact, strong vibration or other mechanical force.
- Dry the equipment immediately in case of rain or water spray.
- Some settings are password protected and can only be changed by authorized personnel. Contact your department manager or biomedical engineering department for the passwords used at your facility.
- Do not loop the patient cabling into a tight coil or wrap around the device, as this can damage the patient cabling.
- Dispose of the package material as per the applicable waste control regulations. Keep it out of children's reach.
- At the end of its service life, the equipment, as well as its accessories, must be disposed of in compliance with the guidelines regulating the disposal of such products. If you have any questions concerning disposal of the equipment, please contact us.

























1.1.3 Notes









NOTE

- Put the equipment in a location where you can easily view and operate the equipment.
- The equipment use a mains plug as isolation means to the mains power. Do not locate the equipment in a place difficult to operate the mains plug.
- The typical operator's position is in front of the monitor.
- The software was developed in compliance with IEC62304. The possibility of hazards arising from software errors is minimized.
- This manual describes all features and options. Your equipment may not have all of them.
- Keep this manual in the vicinity of the equipment so that it can be obtained conveniently when needed.

1.2 Equipment Symbols

Symbol	Description	Symbol	Description
	General warning sign		Refer to instruction manual/booklet

Symbol	Description	Symbol	Description
	Serial number	REF	Catalogue number
	Date of manufacture		Manufacturer
	USB connector	IPX1	Protected against vertically falling water drops per IEC 60529
IP44	IP44: protected against ingress of foreign objects no less than 1.0 mm, and against access to hazardous parts with wire; protect against harmful effects of splashing water	IP22	IP22: protected against ingress of foreign objects no less than 12.5 mm and against access to hazardous parts with finger; protected against harmful effects of vertically falling water drops with the device tilted at any angle up to 15°
	Battery indicator		Computer network
	Direct current		Alternating current
	DEFIBRILLATION-PROOF TYPE CF APPLIED PART		DEFIBRILLATION-PROOF TYPE BF APPLIED PART
	Lock; tighten		Zero key
	Locking		Unlocking
	Direction and angle off rotation		Calibration
	Start		Stop
	Equipotentiality		Polarity of d.c. power connector
	Menu		Video output
	Gas outlet		Gas inlet

Symbol	Description	Symbol	Description
	Stand-by		Input/output
	Humidity limitations		Atmospheric pressure limitations
	Temperature limitations		Non-ionizing electromagnetic radiation
	Dispose of in accordance to your country's requirements		Authorised representative in the European Community
	<p>The product bears CE mark indicating its conformity with the provisions of the Council Directive 93/42/EEC concerning medical devices and fulfil the essential requirements of Annex I of this directive.</p> <p>Note: The product complies with the Council Directive 2011/65/EU.</p>		

2 Equipment Introduction

2.1 Indications for Use

The BeneVision N1 Patient Monitor is intended for monitoring, displaying, reviewing, storing, alarming, and transferring of multiple physiological parameters including ECG (3-lead, 5-lead, 6-lead or 12-lead selectable, Arrhythmia Detection, ST Segment Analysis, QT Analysis, and Heart Rate (HR)), Respiration (Resp), Temperature (Temp), Pulse Oxygen Saturation (SpO₂), Pulse Rate (PR), Non-invasive Blood Pressure (NIBP), Invasive Blood Pressure (IBP), Pulmonary Artery Wedge Pressure (PAWP), Carbon Dioxide (CO₂) and Oxygen (O₂). The system also provides an interpretation of resting 12-lead ECG.

All the parameters can be monitored on single adult, pediatric, and neonatal patients except for the following:

- PAWP is intended for adult and pediatric patients only

The BeneVision N1 monitor is to be used in healthcare facilities. It can also be used during patient transport inside and outside of the hospital environment. It should be used by clinical professionals or under their guidance. It should only be used by persons who have received adequate training in its use. It is not intended for home use.

2.2 Applied Parts

The applied parts of the monitor are:

- ECG electrode and leadwire
- SpO₂ sensor
- Temp probe
- NIBP cuff
- IBP transducer
- CO₂ sampling line/nasal sampling cannula, water trap, and mask

2.3 Main Unit

2.3.1 Front View

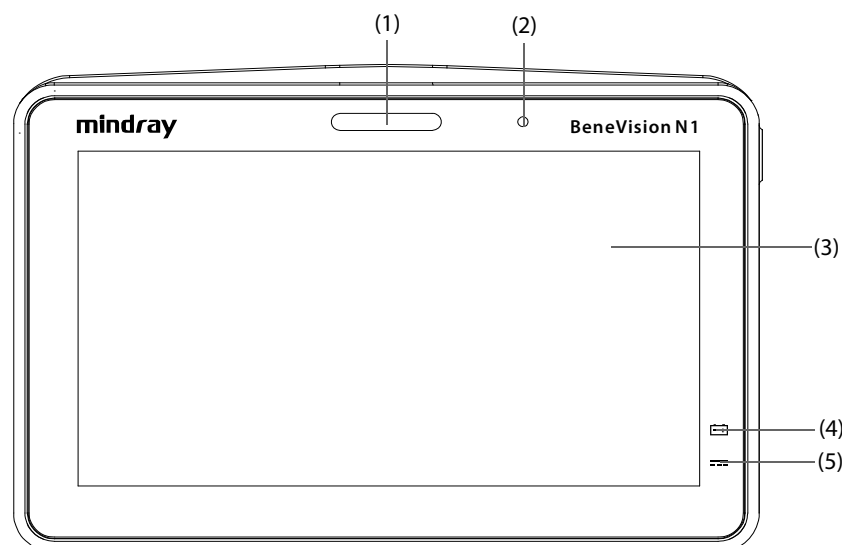

- (1) Alarm lamp:
When a physiological alarm or technical alarm occurs, this lamp lights and flashes corresponding with the alarm priority:
 - High priority alarms: the lamp quickly flashes red.
 - Medium priority alarms: the lamp slowly flashes yellow.
 - Low priority alarms: the lamp lights in cyan without flashing.
- (2) Ambient light sensor
When screen brightness is set to auto, the system automatically adjusts screen brightness according to the strength of ambient light.
- (3) Display
- (4) Battery LED
- (5) External power LED
 - On: when external power supply is connected.
 - Off: when external power supply is not connected.

2.3.2 Left View

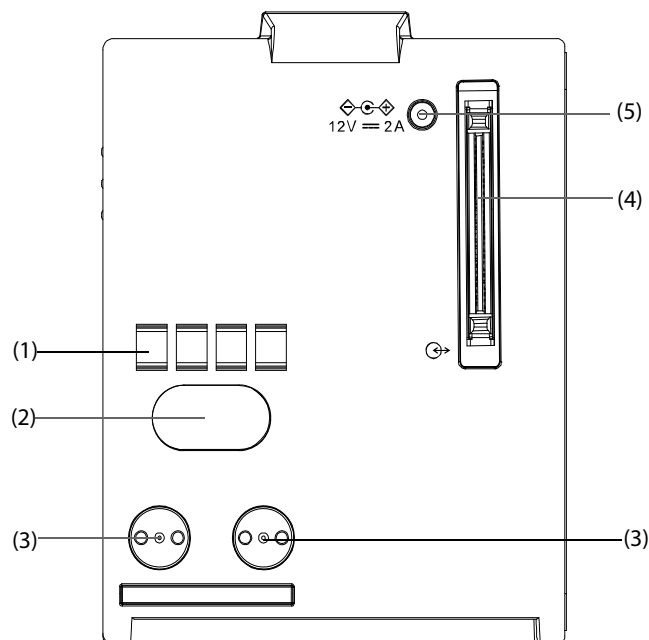

- (1) Communication interface: used for communication between the N1 and host monitor (BeneVision N series monitor).
- (2) Infrared filter: used for communication between the N1 and BeneView T series monitor; used for communication between the N1 and N series monitor if the communication interface does not work.
- (3) Contact: used for receiving power supply from the host monitor (BeneView T series monitor or BeneVision N series monitor).
- (4) Multi-pin connector: connects the N1 to the Modular Rack or Dock.
- (5) External DC power input connector: connects the N1 to the AC adapter

NOTE

- **Dry the Multi-pin connector of the N1 before connecting the N1 to the Modular Rack or Dock in case of water spray.**

2.3.3 Right View

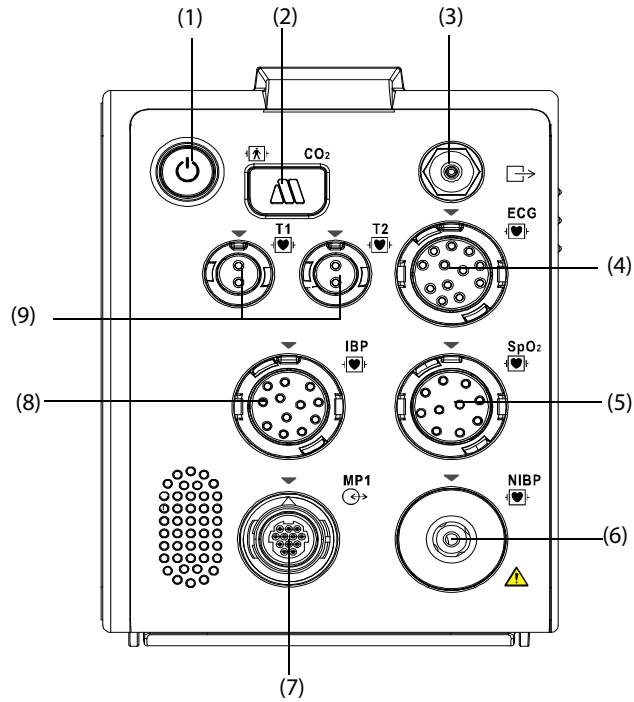

- | | | |
|--|---|-------------------------|
| (1) Power switch | (2) Sample line connector of the sidestream CO ₂ | (3) Gas outlet |
| (4) ECG cable connector | (5) SpO ₂ sensor connector | (6) NIBP cuff connector |
| (7) Multifunctional connector: outputting analog and defib synchronization signal. | (8) IBP cable connector | |
| (9) Temperature probe connector | | |

2.3.4 Bottom View

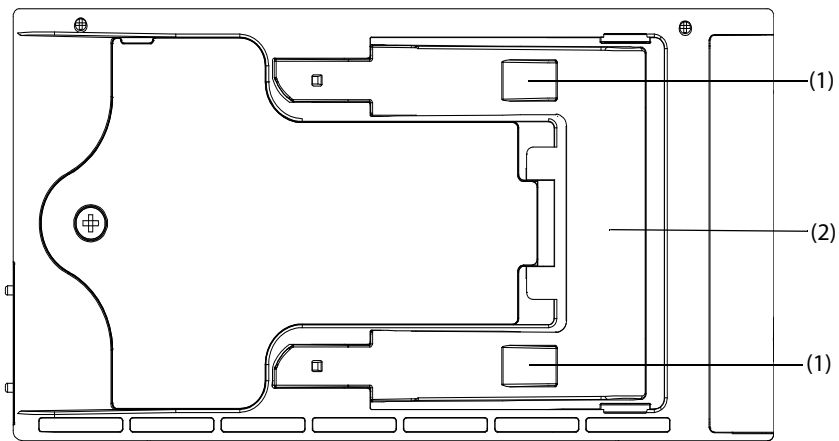

- | |
|---|
| (1) Clip: fasten the N1 when N1 is in use with the host monitor, Dock or Modular Rack. |
| (2) Latch: locks the N1 when the N1 is in use with the host monitor, Dock or Modular Rack. Pressing here releases the N1 so that you can remove the N1 from the host monitor, Dock or Modular Rack. |

2.4 Modular Rack

Modular Rack is used for connecting a N1 and an external parameter module.

2.4.1 Left View

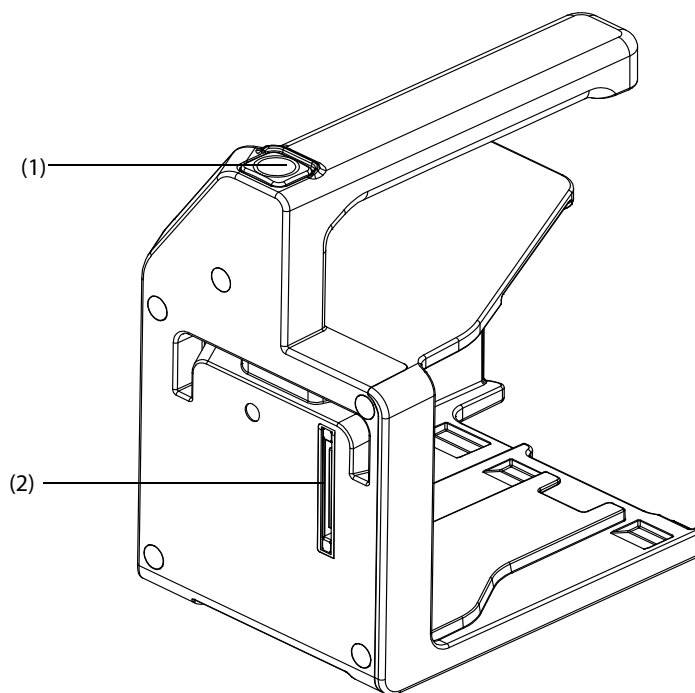

- (1) Release button: pressing this button releases the Modular Rack from the Dock.
- (2) Multi-pin connector: connects the Modular Rack and Dock.

2.4.2 Right View

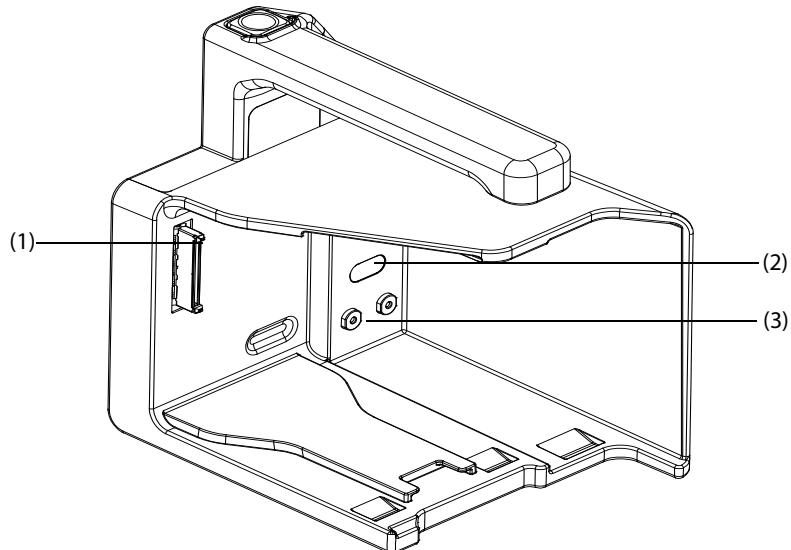

- (1) Multi-pin connector: connects the Modular Rack and N1.
- (2) Infrared filter: used for communication between the Modular Rack and external parameter module.
- (3) Contact: power input connector of the external parameter module.

2.5 Dock

Dock is used to connect the N1 or Modular Rack.

2.5.1 Left View

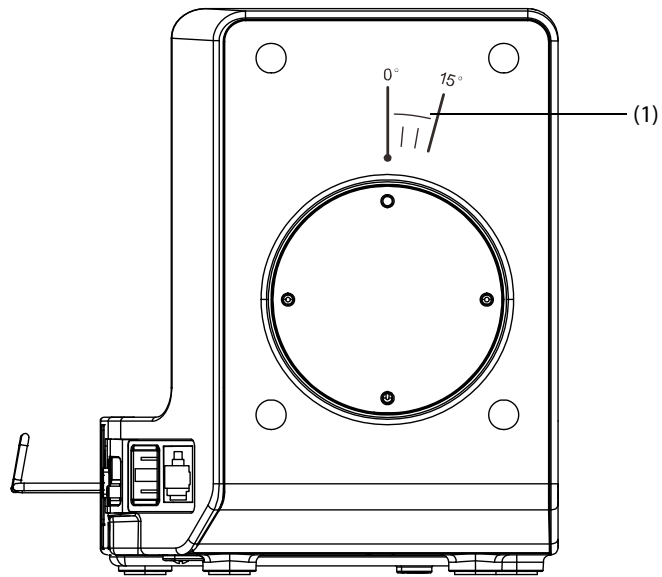

- (1) Symbol: indicates the direction and angle that Dock can rotate when Dock is fixed onto a transverse or a vertical rod.

2.5.2 Right View

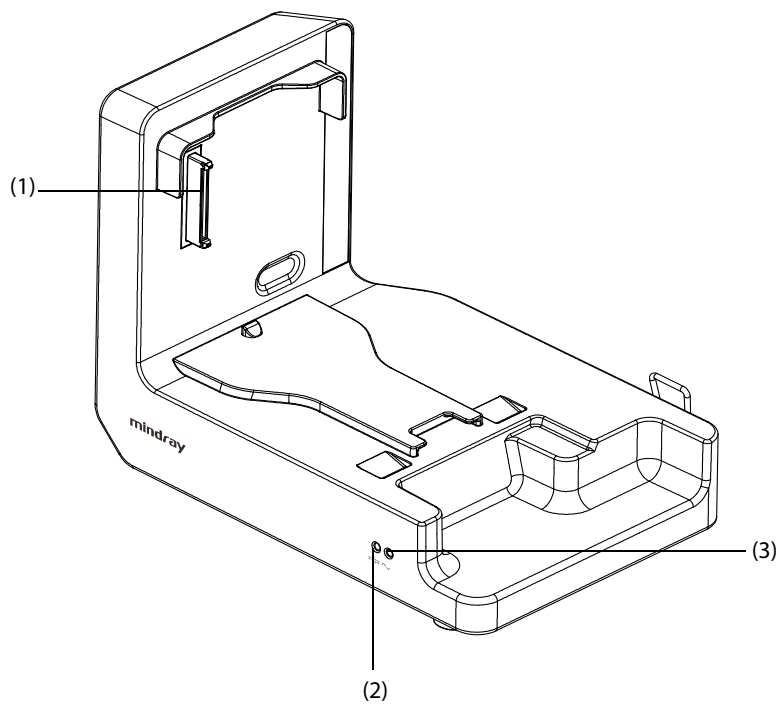

- (1) Multi-pin connector: power input and communication connector of the N1.
(2) Connection status LED: it is on when the N1 is properly connected to the Dock.
(3) External power LED: it is on when the external AC power supply is connected.

2.5.3 Rear View

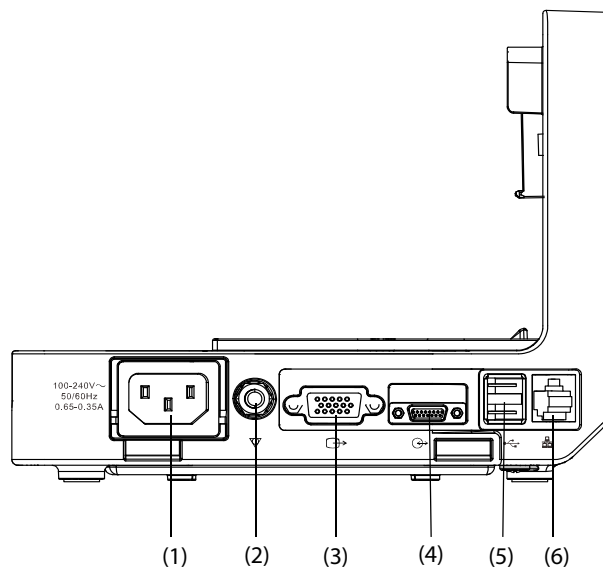

- (1) AC Power input connector
- (2) Equipotential grounding terminal: when using the monitor together with other devices, connect their equipotential grounding terminals together to eliminate the potential difference between them.
- (3) VGA connector: connects the external display
- (4) Host monitor connector: connects the N1 to the host monitor.
- (5) USB connector: connects USB devices.
- (6) Network connector: a standard RJ45 connector.

2.6 External Parameter Modules

The monitor can connect the following external parameter modules to perform CO₂ monitoring and IBP monitoring through the Modular Rack.

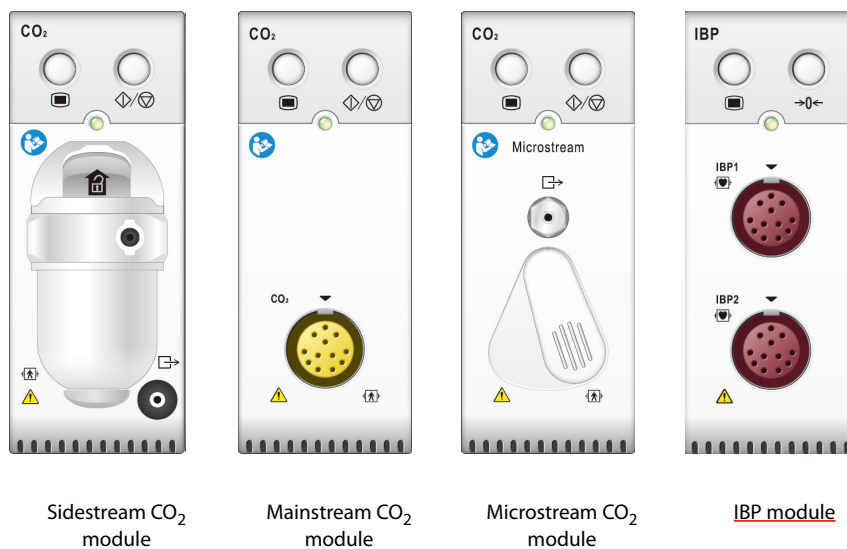

2.7 Installation

2.7.1 Installing the N1 or External Parameter Module into the Modular Rack

You can install the N1 and an external parameter module, if needed, to the Modular Rack as indicated below:

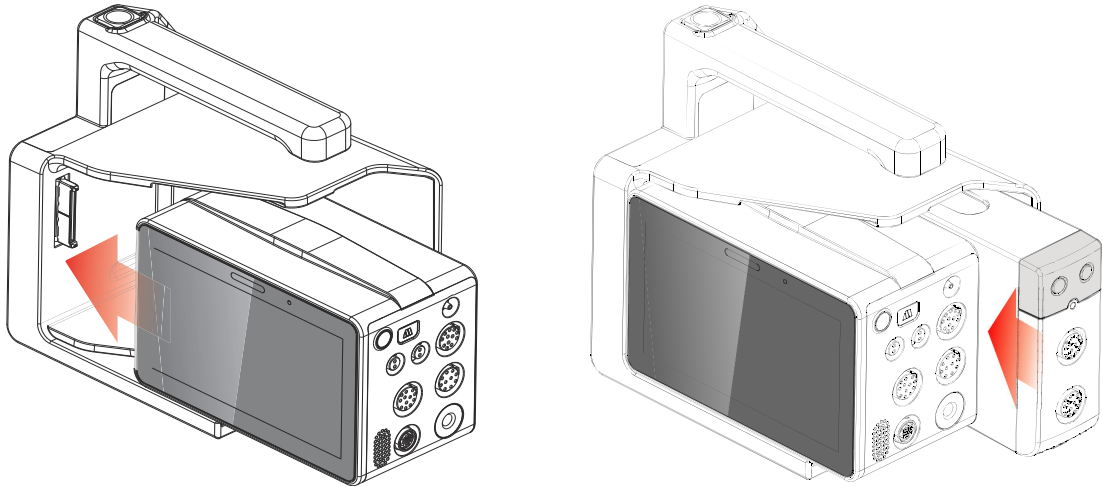

Firmly push the N1 or the external module until you hear that the clip (refer to 2.3.4 Bottom View) engages the Modular Rack. To ensure that the N1 or the external module is properly connected, try to pull the N1 or the external module outward. The N1 or the external module properly engages the Modular Rack if you cannot pull it out.

NOTE

- To prevent N1 or the external module from falling off, after insert N1 or the external module into the Modular Rack, always check that N1 or the external module properly engages the Modular Rack.
- When the external module is properly installed, you should further fasten the module to the Modular Rack with the lock at the bottom of the module to ensure the engagement.

2.7.2 Removing the N1 or External Parameter Module from the Modular Rack

To remove the N1 or external parameter module, follow this procedure:

1. Press and hold the latch at the bottom of the N1 or parameter module. If the external module is locked to the Modular Rack, unlock it first.
2. Pull the N1 or parameter module out as indicated.

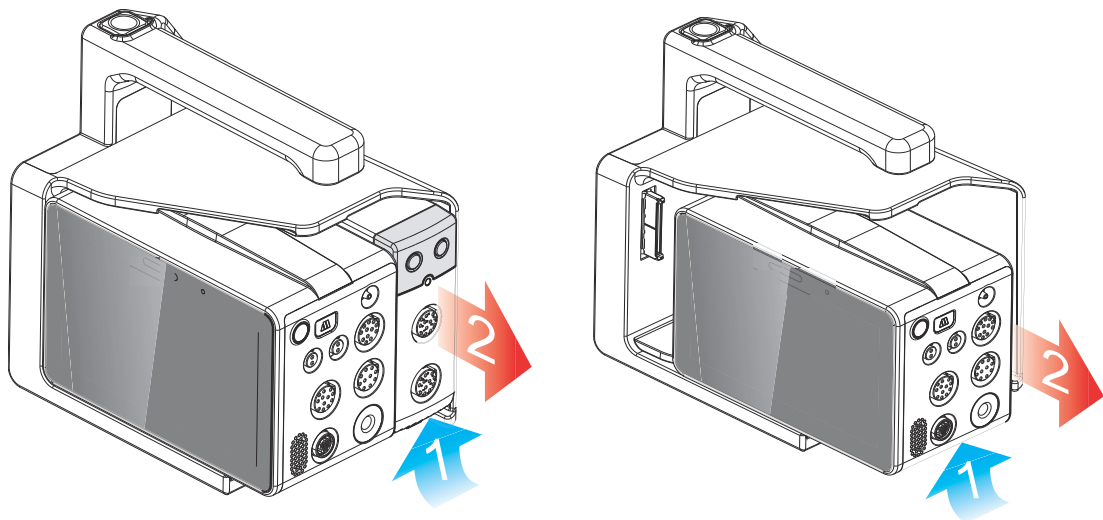

2.7.3 Installing the Modular Rack to the Dock

The Modular Rack can be installed to the Dock as indicated below:

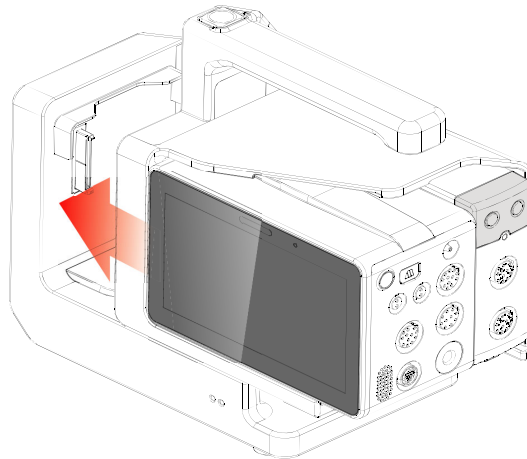

You hear a click when the Modular Rack is pushed into place.

2.7.4 Removing the Modular Rack from the Dock

To remove the Modular Rack from the Dock, follow this procedure:

1. Press and hold down the release button at the top of the Modular Rack.
2. Pull the Modular Rack out as indicated.

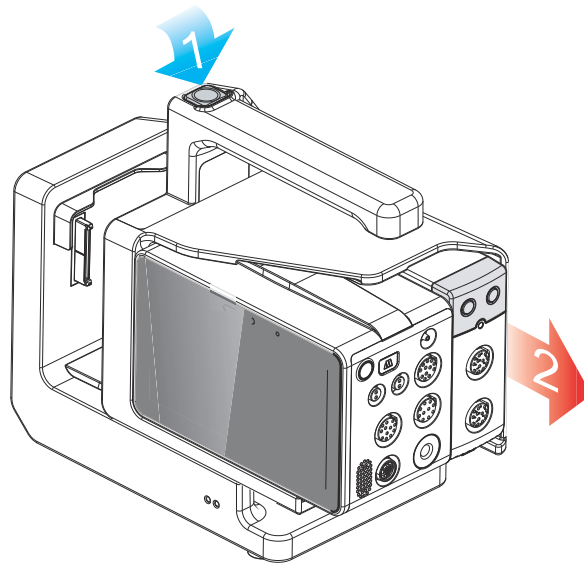

CAUTION

- To prevent N1 from falling off, do not press the release button while transferring N1 with the Modular Rack and Dock.
-

2.7.5 Installing the N1 to the Dock

You can also install N1 directly to the Dock as shown below:

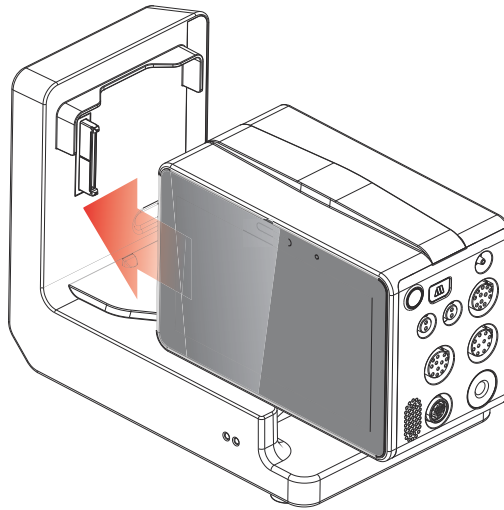

Firmly push N1 until you hear that the clip (refer to 2.3.4 *Bottom View*) engages the Dock. To ensure that N1 is properly connected, try to pull N1 outward. N1 properly engages the Dock if you cannot pull it out.

2.7.6 Removing the N1 from the Dock

To remove the N1 from the Dock, follow this procedure:

1. Press and hold the latch at the bottom of N1.
2. Pull the N1 out as indicated.

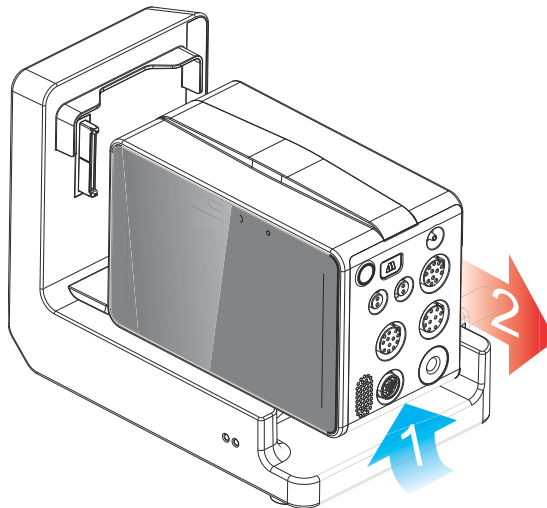

2.8 N1 in Use with the Host Monitor

When the N1 is connected to the BeneVision N series monitor or BeneView T series monitor, the N1 works as the parameter module while BeneVision N series monitor or BeneView T series monitor works as the host monitor. For more information, see section 3.7.2 *Module Mode*.

N1 can be connected to the host monitor through the following parts:

- The module rack of the host monitor
- The Satellite Module Rack (SMR)
- The Dock

BeneVision N series and BeneView T series monitor that can be used as N1 host monitor are as follows:

- BeneVision 22, BeneVision N19, BeneVision N17, BeneVision N15, BeneVision N12, and BeneVision N12C
- BeneView T5, BeneView T6, BeneView T8, and BeneView T9

CAUTION

- If you need the analog signals, use the multifunctional connector of the N1 instead of the Micro-D connector of the BeneView T series monitor when the two monitors are connected.
-

2.8.1 Connecting N1 to the Host Monitor through the Module Rack

To connect the N1 to the module rack of the host monitor, follow this procedure:

1. Insert N1 to the host monitor's module rack. Firmly push N1 until you hear that the clip (refer to 2.3.4 *Bottom View*) engages the module rack.
2. To ensure that N1 is properly connected, try to pull N1 outward. N1 properly engages the module rack if you cannot pull N1 out.

To remove N1 from the module rack of the host monitor, lift the latch (refer to 2.3.4 *Bottom View*) at the bottom of N1 and pull N1 out.

CAUTION

- To prevent N1 from falling off, after inserting N1 into the module rack, always check that N1 properly engages the module rack.
 - To prevent N1 from falling off, catch it with another hand while pulling it out from the module rack.
-

NOTE

- There is no module rack for the BeneVision N22 or BeneVision N19 monitor. The N1 can be connected to the BeneVision N22 and BeneVision N19 monitor through the SMR or Dock.
-

2.8.2 Connecting N1 to the Host Monitor through the Satellite Module Rack (SMR)

To connect the N1 to the host monitor through the SMR, follow this procedure:

1. Connect the SMR to the host monitor.
2. Insert N1 to the SMR. Firmly push N1 until you hear that the clip (refer to 2.3.4 *Bottom View*) engages the SMR.

To ensure that N1 is properly connected, try to pull N1 outward. N1 properly engages the module rack if you cannot pull N1 out.

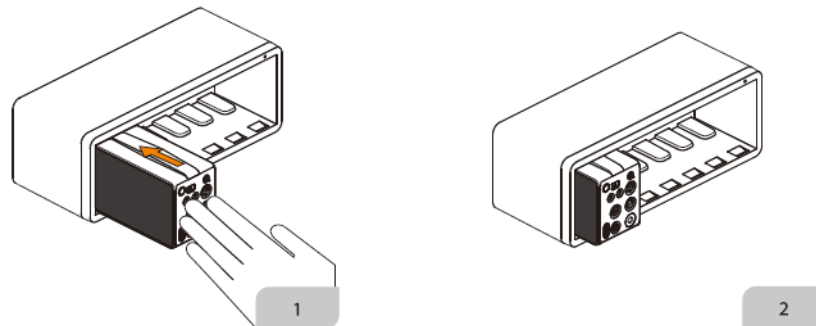

To remove N1 from the SMR, lift the latch (refer to 2.3.4 *Bottom View*) at the bottom of N1 and pull N1 out.

CAUTION

- To prevent N1 from falling off, after inserting N1 into the SMR, always check that N1 properly engages the SMR.
 - To prevent N1 from falling off, catch it with another hand while pulling it out from the SMR.
-

2.8.3 Connecting N1 to the Host Monitor through the Dock

To connect the N1 to the host monitor through the Dock, follow this procedure:

1. Connect the N1 to the Dock.
2. Connect the host monitor connector of the Dock with the SMR connector of the host monitor using the dock data cable.

2.9 N1 in Use with the Transport Dock

N1 can be used together with the Transport Dock to transport patient through road ambulance, airplane fuselage or helicopter fuselage. For the installation of the N1 and Transport Dock, refer to the *Transport Dock Indication for Use (PN: H-046-011365-00)*.

WARNING

- - **The monitor must only be connected to mains power with protective earth, and the connection should be performed by qualified service personnel.**
 - **Ensure that the external power system has secure protective earth when the monitor is used together with the Transport Dock.**
 - **Verify that the connection of protective earth and the external power system is securely connected when installing the Transport Dock.**
-
-

2.10 Input Devices

The monitor allows data entry through touchscreen, keyboard, mouse, and barcode reader.

2.11 Printing Devices

You can use Mindray specified printer to output patient information and data.

3 Getting Started

3.1 Equipment Preparation Safety Information

WARNING

- Use only installation accessories specified by Mindray.
 - The equipment software copyright is solely owned by Mindray. No organization or individual shall resort to modifying, copying, or exchanging it or to any other infringement on it in any form or by any means without due permission.
 - Connect only approved devices to this equipment. Devices connected to the equipment must meet the requirements of the applicable IEC standards (e.g. IEC 60950 safety standards for information technology equipment and IEC 60601-1 safety standards for medical electrical equipment). The system configuration must meet the requirements of the IEC 60601-1 medical electrical systems standard. Any personnel who connect devices to the equipment's signal input/output port are responsible for providing evidence that the safety certification of the devices has been performed in accordance to the IEC 60601-1. If you have any questions, please contact Mindray.
 - If it is not evident from the equipment specifications whether a particular combination with other devices is hazardous, for example, due to summation of leakage currents, please consult the manufacturer or an expert in the field. A determination must be made that the proposed combination will not negatively affect the devices themselves or the patient's safety.
 - If the accuracy of any value displayed on the monitor, central station, or printed on a report is questionable, determine the patient's vital signs by alternative means. Verify that all equipment is working correctly.
-

CAUTION

- The equipment should be installed by authorized Mindray personnel.
 - When disposing of the packaging material, be sure to observe the applicable waste control regulations and keep it out of children's reach.
 - Before use, verify whether the packages are intact, especially the packages of single use accessories. In case of any damage, do not apply it to patients.
 - Avoid rude handling during transport.
 - Observance of this manual is a prerequisite for proper product performance and correct operation and ensures patient and operator safety.
-

NOTE

- Put the equipment in a location where you can easily view and operate the equipment.
 - Keep this manual in the vicinity of the equipment so that it can be conveniently referenced when needed.
 - Save the packing case and packaging material as they can be used if the equipment must be reshipped.
-

3.2 Unpacking and Checking

Before unpacking, examine the packing case carefully for signs of damage. If any damage is detected, contact the carrier or us.

If the packing case is intact, open the package and remove the equipment and accessories carefully. Check all materials against the packing list and check for any mechanical damage. Contact us in case of any problem.

NOTE

- **If your monitor contains the internal CO₂ module, connect the CO₂ adapter to the CO₂ receptacle soon after you unpack the monitor to avoid losing the CO₂ adapter.**
-

3.3 Environmental Requirements

The operating environment of the equipment must meet the requirements specified in this manual.

The environment where the equipment is used shall be reasonably free from noises, vibration, dust, corrosive, flammable and explosive substances. If the equipment is installed in a cabinet, sufficient space in front and behind shall be left for convenient operation, maintenance and repair. Moreover, to maintain good ventilation, the equipment shall be at least 2 inches (5cm) away from around the cabinet.

When the equipment is moved from one place to another, condensation may occur as a result of temperature or humidity difference. In this case, never start the system before the condensation disappears.

CAUTION

- **Make sure that the equipment operating environment meets the specific requirements. Otherwise unexpected consequences, e.g. damage to the equipment, could result.**
-

3.4 Setting Up the Equipment

Observance of this manual is a prerequisite for proper product performance and correct operation. It ensures patient and operator safety.

3.4.1 Connecting the AC Mains

The monitor can be powered by AC power supply when it is connected to the AC adapter or Dock. Before connecting the equipment to the AC mains, check that the voltage and frequency ratings of the power line are the same as those indicated on the AC adapter or Dock.

3.4.1.1 Connecting the AC Mains through the AC Adapter

To connect the N1 to the AC power source through the AC adapter, follow this procedure:

1. Connect the N1 to the AC adapter.
2. Connect the female end of the power cord to the AC adapter, and the male end of the power cord to a wall AC outlet.
3. Check that the external power supply indicator is on.

The external power supply indicator lies in the lower right corner of the display. When the AC mains is not connected, the external power supply indicator is off. When AC mains is connected, the external power supply indicator is illuminated in green.

3.4.1.2 Connecting the AC Mains through the Dock

To connect the N1 to the AC power source through the Dock, follow this procedure:

1. Connect the N1 to the Dock.
2. Connect the female end of the power cord to the AC power input of the Dock, and the male end of the power cord to a wall AC outlet.
3. Check that the external power supply indicator of the N1 and Dock are on.

WARNING

- **Always use the accompanying power cord delivered with the monitor.**
- **Always use the AC adapter specified by Mindray.**
- **Before connecting the equipment to the AC mains, check that the voltage and frequency ratings of the power line are the same as those indicated on the AC adapter and Dock.**

- Use the cable retainer to secure the power cord to prevent it from falling off.
 - Use AC power source when the N1 is in use with the Dock.
 - Use the battery if the integrity of the protective earth conductor or the protective earthing system in the installation is in doubt.
-

3.4.2 Connecting the Input Devices

Connect the mouse, keyboard, and barcode scanner if necessary.

3.4.3 Installing the External Parameter Module

If external parameter module is needed, refer to section 2.7.1 *Installing the N1 or External Parameter Module into the Modular Rack* for installation.

3.4.4 Turning on the Monitor

Before turn on the monitor, perform the following inspections:

1. Check the monitor for any mechanical damage. Make sure that all external cables, plug-ins and accessories are properly connected.
2. Connect the monitor to the AC power source using AC adapter or Dock. Make sure the battery power is sufficient if the monitor is powered by the battery.
3. Press the power switch to turn on the monitor.

The monitor automatically performs a self test at startup. Check that the alarm tone is heard and the alarm lamp illuminates, one after the other, in red, yellow, and cyan. This indicates that the visible and audible alarm indicators functions correctly.

CAUTION

- Check that visual and auditory alarm signals are presented correctly when the equipment is powered on. Do not use the patient monitor for any monitoring procedure on a patient if you suspect it is not working properly, or if it is mechanically damaged. Contact your service personnel or us.
-

NOTE

- For first use, connect the monitor to the AC power source for a while and then turn on the monitor to activate the battery.
 - The time for the monitor to warm from the minimum storage temperature between uses until the monitor is ready for its intended use is 10 minutes when the ambient temperature is 20 °C.
 - The time for the monitor to cool from the maximum storage temperature between uses until the monitor is ready for its intended use is 10 minutes when the ambient temperature is 20 °C.
-

3.5 Operation and Navigation

Everything you need to operate the monitor is on its screen. Almost every element on the screen is interactive. Screen elements include parameter values, waveforms, quick keys, information fields, alarms fields and menus. Often you can access the same element in different ways. For example, you can access a parameter menu by selecting corresponding numeric area or waveform area, or by selecting the **Main Menu** quick key → from the **Parameters** column select **Setup**.

3.5.1 Using the Touchscreen

You can use the touchscreen to select a screen element by pressing directly on the monitor's screen. To avoid misuse, the touchscreen is locked in the following situation:

- The touchscreen is not used in 60 seconds.
- Select the **Unlock** quick key , and swipe the slider up as instructed.

When the touchscreen is locked, the quick key changes to . To unlock the touchscreen, touch anywhere of the touchscreen and swipe the slider up as instructed.

NOTE

- **Wipe off the water on the touchscreen in case of rain or water spray.**
-





3.5.2 Using the Mouse

You can use the mouse to select a screen element by moving the cursor on the element and then click on it. The mouse sensitivity is adjustable. To do so, follow this procedure:

1. Select the **Main Menu** quick key → from the **System** column select **Maintenance** → input the required password → select .
2. Select the **Other** tab.
3. Set **Mouse Sensitivity**.

3.5.3 Using the On-Screen Keyboard

The on-screen keyboard enables you to enter information:

- Enter the information by selecting one character after another.
- Select the Backspace key  to delete single characters or select  to delete the entire entry.
- Select the Caps Lock key  to access uppercase letters.
- Select the Enter key  to confirm the entry and close the on-screen keyboard.

3.5.4 Using the Barcode Reader

The monitor supports both linear (1D) barcode reader and two-dimension (2D) barcode reader. The barcode reader is connected to the monitor through the USB connector on the Dock.

NOTE

- **You can use the Mindray custom barcode reader to scan both the 2D and 1D barcodes. Using other barcode readers can only output the patient's medical record number (MRN) and visit number.**
-

3.5.4.1 Clearing Old Data Formats (for the Mindray Custom 2D Barcode Reader)

If you are using the Mindray custom 2D barcode reader (Model HS-1R or HS-1M), before using the it for the first time, clear old data formats and configure the barcode reader.

Before configuring the Mindray custom barcode reader, clear old data formats. To do so, follow this procedure:

1. Scan the engineering barcode to clear the previous data format.
2. Scan the 2D engineering barcode which contains your hospital's data format.

NOTE

- **Contact the scanner manufacturer or Mindray to obtain the engineering barcodes for clearing data formats and containing the hospital's data format.**
-

3.5.4.2 Establish the Relationship between Patient Demographics and 2D Barcode Fields (for the Mindray Custom 2D Barcode Reader)

To configure the Mindray custom barcode reader, follow this procedure:

1. Select the **Main Menu** quick key → from the **System** column select **Maintenance** → input the required password → select .
2. Select the **Scanner** tab → **2D Barcode** tab.
3. Establish the relationship between the monitor data and barcode data for selectable patient demographics. For example, the monitor has an option of **Ped** for patient category. In your hospital

barcode, the text may read as **Pediatric**. You need to input **Pediatric** for the field **Ped** to establish their relationship.

3.5.4.3 Setting the Barcode Reader Information

To set the barcode reader information, follow this procedure:

1. Select the **Main Menu** quick key → from the **System** column select **Maintenance** → input the required password → select .
2. Select the **Scanner** tab → **Scanner Info.** tab.
3. Set **Scanner Type**:
 - ◆ **1D Scanner**: select this option when you are using a 1D scanner or a 2D scanner other than the Mindray custom 2D scanner.
 - ◆ **2D Scanner**: select this option when you are using the Mindray custom scanner.

NOTE

- **When you set Scanner Type to 2D Scanner, default settings are applied to Data Encoding Type and DataParseMode. You do not need to change these setting.**
-

3.5.4.4 Identifying the Barcode Reader (for the non-Mindray Custom 2D Barcode Reader)

When you are using barcode readers other than HS-1R or HS-1M, you should select the barcode reader from the USB device list, so that the monitor can identify the barcode reader. To do so, follow this procedure:

1. Select the **Main Menu** quick key → from the **System** column select **Maintenance** → input the required password → select .
2. Select the **Scanner** tab → **Identifying Scanner** tab.
3. From the USB device list, select the barcode reader you are using.

3.5.4.5 Selecting Patient Information output by the Barcode Reader (for the Mindray Custom 2D Barcode Reader)

To select desired patient information to be output by the barcode reader, follow this procedure:

1. Select the **Main Menu** quick key → from the **System** column select **Maintenance** → input the required password → select .
2. Select the **Scanner** tab → **Field** tab.
3. Select desired patient information. The selected information can be output by the barcode reader.

3.6 Screen Display



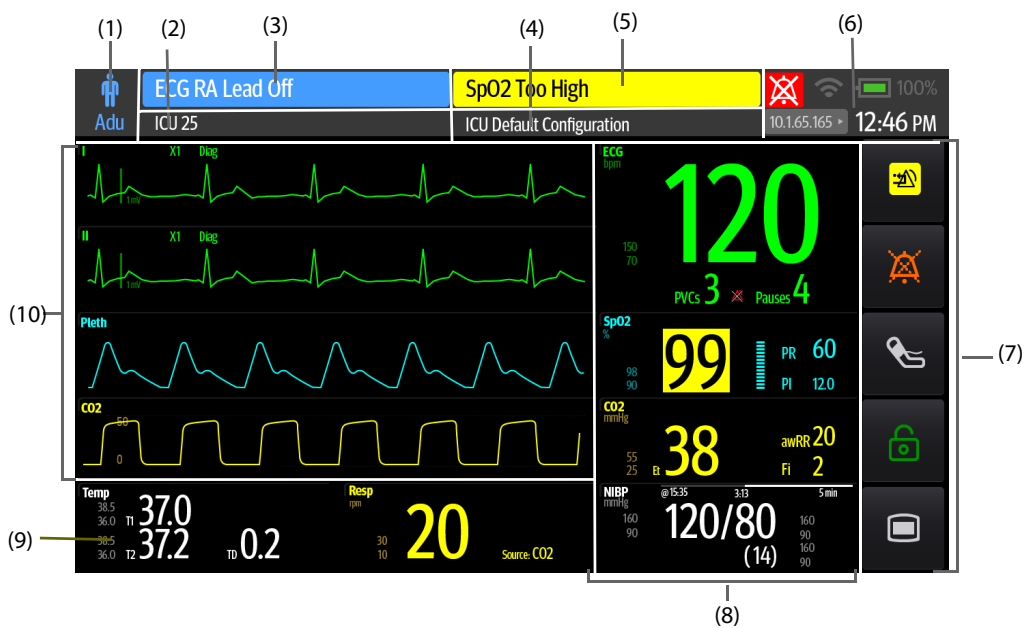

The following figure shows the normal screen:



















- (1) Patient information area: displays patient category and gender. The displayed patient information is configurable. Selecting this area enters the **Patient Management** menu. For more information, see 4.3Managing Patient Information.
- (2) Patient information area: displays patient information, including department, room number, bed number, and so on. The displayed patient information is configurable. Selecting this area enters the **Patient Management** menu. For more information, see 4.3Managing Patient Information.
- (3) Technical alarm information area: displays technical alarm message or prompt message.
- (4) The current configuration
- (5) Physiological alarm information area: displays physiological alarm message.
- (6) System status information area: displays alarm symbol, battery status, network status, currently connected CMS, and system time. For more information, see 3.6.1On-screen Symbols.
- (7) Quick key area: displays quick keys.
- (8) Parameter numerics area: displays parameter values, alarm limits, and alarm status. Selecting a parameter numeric block enters corresponding parameter menu. For more information, see 3.11.3Accessing Parameter Setup Menus.
- (9) Parameter waveform/ numerics area: displays parameter waveforms or parameter values, alarm limits, and alarm status. Selecting a parameter waveform of numeric block enters corresponding parameter menu. For more information, see 3.11.3Accessing Parameter Setup Menus.
- (10) Parameter waveform area: displays parameter waveforms. Select a waveform enters corresponding parameter menu. For more information, see 3.11.3Accessing Parameter Setup Menus.

3.6.1 On-screen Symbols

The following table lists the on-screen symbols displayed on the system status information area:

Symbol	Description	Symbol	Description
	Adult, male		Adult, female
	Pediatric, male		Pediatric, female

Symbol	Description	Symbol	Description
	Neonate, male		Neonate, female
	Wireless network is connected. The solid part indicates network signal strength.		Wireless network is not connected.
	Wired network is connected.		Wired network is not connected.
	All the alarms are paused.		Individual physiological alarms are turned off or the monitor is in the alarm off status.
	Audible alarm tones are paused.		Audible alarm tones are turned off.
	Alarms are acknowledged and the alarm system is reset.		The battery works correctly. The green portion represents the remaining charge.
	The battery has low power and needs to be charged.		The battery has critically low charge and needs to be charged immediately. Otherwise, the monitor will soon automatically shut down.
	The battery is being charged.		No battery is installed.
	Battery fault, battery communication fault, or battery charging fault. Contact service personnel for help.		

3.6.2 Menus

All menus have similar style and structure, see the figure below:















(1) Menu heading

(2) Submenu tabs

- (3) Operation buttons
- (4) Exit button: closes the current menu page.
- (5) Main body area: includes menu items and options.
- (6) Switch:
 - ◆ Green: the switch is on.
 - ◆ Gray: the switch is off.







3.6.3 Quick Keys of the N1

The monitor provides quick keys for you to quickly access some functions. The quick key area is located at the right of the screen. The quick key area displays 5 quick keys. You can also swipe down on the quick key area for more quick keys. The following table shows available quick keys.



Symbol	Label	Function	Symbol	Label	Function
	Alarm Reset	Acknowledges the ongoing alarms.		Screen Setup	Enters the Screen Setup menu.
	Alarm Pause	Pauses the current alarms.		Print	Starts printing a real-time report.
	Audio Pause	Pauses alarm tone.		Standby	Enters the Standby mode.
	NIBP Start/Stop	Starts an NIBP measurement or stops the current NIBP measurement.		Manual Event	Manually triggers and saves an event.
	Lock	Selects and operates as instructed to unlock the touchscreen		NIBP Measure	Enters the NIBP Measure menu.
	Unlock	Selects and operates as instructed to lock the touchscreen		Main Menu	Enters the main menu.

3.6.4 Quick keys of the independent external display

The following table displays the quick keys that are available for the independent external display.

Symbol	Label	Function	Symbol	Label	Function
	Alarm Reset	Acknowledges the ongoing alarms.		Screen Setup	Enters the Screen Setup menu.
	Alarm Pause	Pauses the current alarms.		Print	Starts printing a real-time report.
	Audio Pause	Pauses alarm tone.		Standby	Enters the Standby mode.

Symbol	Label	Function	Symbol	Label	Function
	NIBP Start/Stop	Starts an NIBP measurement or stops the current NIBP measurement.		Manual Event	Manually triggers and saves an event.
	NIBP Measure	Enters the NIBP Measure menu.		Main Menu	Enters the main menu.
	Alarm Setup	Enters the Alarm menu.		More	Shows more quick keys.
	Discharge Patient	Enters the Discharge Patient dialog box.		Patient Demographics	Enters the Patient Management menu.
	Review	Enters the Review menu.		Parameters Setup	Enters the Parameters Setup menu.
	NIBP STAT	Starts a five-minutes continuous NIBP measurement.		Stop All	Stops all NIBP measurements.
	Zero IBP	Starts IBP zero calibration.		PAWP	Enters the PAWP screen.
	Venipuncture	Opens the Venipuncture window.		ECG Lead/Gain	Enters the ECG Lead/Gain menu.
	Remote View	Opens the Remote View window.		Minitrends	Enters the Minitrends screen.
	OxyCRG	Opens the OxyCRG window.		ECG Full-Screen	Enters the 12-lead ECG full screen.
	Privacy Mode	Enters the privacy mode.		Night Mode	Enters the night mode.
	CPB Mode	Enters the CPB mode.		Intubation Mode	Enters the intubation mode.
	Volume	Enters the Volume menu.		Freeze	Freezes waveforms.
	Calculations	Enters the Calculations menu.		Load Configuration	Enters the Load Config menu.
	C.O. Measure	Opens the C.O. Measure (CCO) window.		EWS	Enters the EWS screen.

Symbol	Label	Function	Symbol	Label	Function
	GCS	Enters the GCS menu.		Rescue Mode	Enters the rescue mode.

3.6.5 Configuring the Displayed Quick Keys (only available for the independent external display)

To select the quick keys you want to display, follow this procedure:

1. Access **Quick Key** in either of the following ways:
 - ◆ Select the **Screen Setup** quick key → the **Select Quick Keys** tab.
 - ◆ Select the **Main Menu** quick key → from the **Display** column select **Quick Keys**.
2. Select the **Current** tab to configure the quick keys you want to display on the screen: From the top of this page, select a block where you want to show a certain quick key, and then select the quick key from the quick key list. For example, if you want to show the **Screen Setup** quick key at the first block, select the first block, and then select **Screen Setup** from the list.
3. Select the **More** tab to configure the quick keys you want to display when the **More** quick key is selected.

3.7 Operating Modes

The monitor provides different operating modes. This section describes the monitoring mode and the standby mode.

3.7.1 Monitoring Mode

The monitoring mode is the most frequently used clinical mode for patient monitoring. When the monitor is turned on, it automatically enters the monitoring mode.

3.7.2 Module Mode

When the N1 is connected to the host monitor, the N1 enters the module mode. For connection of the N1 and the host monitor, see section *2.8N1 in Use with the Host Monitor*. The N1 monitor has the following features when it enters the module mode:

- The patient information, parameter setup, and alarm setup of the N1 and the host monitor will be synchronized. For data transfer strategy, see the operator's manual of the host monitor.
- The N1 can still store the parameter data and the alarm events.
- The N1 receives and stores the parameter trends data from the host monitor.
- All audible sounds of the N1 are off.
- Wired and wireless network of the N1 are not available.
- The alarm indications of the battery related alarms of the N1 are given by the host monitor.
- Turning on or off the host monitor simultaneously powers on or off the N1.
- The main screen of the N1 is off when it is connected to the host monitor through the SMR or the module rack of the host monitor.

The N1 resumes to monitor mode when it is disconnected from the host monitor.

3.7.3 Privacy Mode

The privacy mode is a special clinical monitoring mode. In the privacy mode, the monitor does not display patient information and monitoring data. This provides controlled access to patient data and ensures confidentiality.

The privacy mode is only available when the patient admitted by the monitor is also monitored by the CMS. The monitor continues monitoring the patient, but patient data is only visible at the CMS.

3.7.3.1 Entering the Privacy Mode

To enter the privacy mode, select the **Main Menu** quick key → from the **Display** column select **Privacy Mode** → select **Ok**.

The monitor has the following features after entering the privacy mode:

- The screen turns blank.
- Except for the low battery alarm, the monitor inactivate alarm tone and alarm light of all other alarms.
- The monitor suppresses all system sounds, including heart beat tone, pulse tone, and prompt tone.

WARNING

- **In Privacy mode, all audible alarms are suppressed and the alarm light is deactivated at the monitor. Alarms are presented only at the CMS. Pay attention to potential risk.**

NOTE

- **The privacy mode is not available if the Department is set to OR.**
 - **You cannot enter the privacy mode if a low battery alarm occurs.**
-

3.7.3.2 Exiting the Privacy Mode

The monitor automatically exit the privacy mode in any of the following situations:

- The monitor disconnects from the CMS.
- The low battery alarm occurs.

You can also operate the touchscreen, mouse, or keyboard to manually exit the privacy mode.

3.7.4 Night Mode

The night mode is a special clinical monitoring mode. To avoid disturbing the patient, you can use the night mode.

3.7.4.1 Entering the Night Mode

To enter the night mode, follow this procedure:

1. Select the **Main Menu** quick key → from the **Display** column select **Night Mode**.
2. Change the night mode settings if necessary.
3. Select **Enter Night Mode**.

The night mode settings are as follows by default:

- Brightness: 1
- Alarm Volume: 2
- QRS Volume: 1
- Key Volume: 0
- NIBP End Tone: Off
- Stop NIBP: Off

CAUTION

- **Verify the night mode settings before entering the night mode. Pay attention to the potential risk if the setting value is low.**
-

3.7.4.2 Exiting the Night Mode

To cancel the night mode, follow this procedure:

1. Select the **Main Menu** quick key → from the **Display** column select **Exit Night Mode**.
2. Select **Ok**.

NOTE

- **If your monitor is connected to the CMS, it automatically exits the night mode when being disconnected from the CMS.**
 - **The monitor resumes the previous settings after exiting the night mode.**
-

3.7.5 Standby Mode

You can temporarily stop patient monitoring without switching off the monitor by entering the standby mode.

3.7.5.1 Entering the Standby Mode

1. Select the **Standby** quick key, or select the **Main Menu** quick key → from the **Patient Management** column select **Standby**.
2. Define where the patient is by selecting a location in the drop down list when the monitor enters the standby mode.
3. Select **Ok**.

The monitor behaves as follows after entering the standby mode:

- Stops all parameter measurements.
- Disables all the alarms and prompt messages, except for the battery low alarm.
- Turns screen brightness to the dimmest after entering the standby mode for 30 seconds.

WARNING

- **Pay attention to the potential risk of placing the monitor to standby. In the standby mode, the monitor stops all parameter measurements and disable all the alarm indications, except for the battery low alarm.**
-

3.7.5.2 Changing the Patient Location at Standby

If you need to change the patient's location, select patient location from the standby screen.

3.7.5.3 Exiting the Standby Mode

To exit the standby mode, choose any of the following ways:

- Select **Resume Monitor** to exit the standby mode and resume monitoring the current patient.
- Select **Discharge Patient** to discharge the current patient.

3.7.6 Outdoor Mode

The outdoor mode is intended for transferring patients outdoors. The monitor behaves as follows after entering the outdoor mode:

- ◆ The parameter color is white and unchangeable.
- ◆ The screen brightness is automatically changed to 10.

3.7.6.1 Entering the Outdoor Mode

To enter the outdoor mode, follow this procedure:

1. Select the **Main Menu** quick key → from the **System** column select **Maintenance** → input the required password → select **←**.
2. Select the **Other** tab.

3. Set **Enter Outdoor Mode** to **Manual** or **Auto**.
 - ◆ **Manual:** The monitor enters the outdoor mode by manually selecting the **Main Menu** quick key → from the **Display** column select **Enter Outdoor Mode**.
 - ◆ **Auto:** The monitor enters the outdoor mode automatically if the strength of ambient light is greater than the threshold.

3.7.6.2 Exiting the Outdoor Mode

When **Enter Outdoor Mode** is set to **Manual**, select the **Main Menu** quick key → from the **Display** column select **Exit Outdoor Mode**.

The monitor automatically exits the outdoor mode in the following situation:

- The monitor is connected to a host monitor.
- The strength of ambient light is lower than the threshold when **Enter Outdoor Mode** is set to **Auto**.

3.8 Configuring Your Monitor

Configure your monitor before putting it in use.

3.8.1 Selecting the Language

To set the user interface (UI) language, follow this procedure:

1. Select the **Main Menu** quick key → from the **System** column select **Maintenance** → input the required password → select .
2. Select the **Other** tab.
3. Set **Language**.

3.8.2 Setting the Date and Time

To set the system time, follow this procedure:

1. Select the **Main Menu** quick key → from the **System** column select **Time**.
2. Set **Date** and **Time**.
3. Set **Date Format**.
4. If you want to use the 12-hour mode, switch off **24 Hour Time**.
5. If you want to use daylight saving time, switch on **Daylight Saving Time**. You can manually switch on or off the daylight saving time only when the auto daylight saving time function is disabled. For more information, see [3.8.3 Enabling Auto Daylight Saving Time](#) for details.

If your monitor is connected to a central monitoring system (CMS) or hospital clinical system (HIS), the date and time are automatically taken from the CMS. In this case, you cannot change the date and time from your monitor.

CAUTION

- **Changing the date and time affects the storage of trends and events and may result in loss of data.**
-

3.8.3 Enabling Auto Daylight Saving Time

By default, you need to manually enable the daylight saving time. To auto start the daylight saving time, follow this procedure:

1. Select the **Main Menu** quick key → from the **System** column select **Maintenance** → input the required password → select .
2. Select the **Time** tab.
3. Switch on **Auto Daylight Saving Time**.
4. Adjust daylight saving time settings as necessary.

NOTE

- If you enable **Auto Daylight Saving Time**, you cannot manually switch it on or off from the **System Time** menu. For more information, see [3.8.2 Setting the Date and Time](#).
-

3.8.4 Setting the Unit

To set the unit, follow this procedure:

1. Select the **Main Menu** quick key → from the **System** column select **Maintenance** → input the required password → select .
2. Set the **Unit** tab.
3. Set measurement units for each parameter.

3.8.5 Adjusting the Screen Brightness

To adjust the screen brightness, follow this procedure:

1. Access **Display** in either of the following ways:
 - ◆ Select the **Screen Setup** quick key → select the **Display** tab.
 - ◆ Select the **Main Menu** quick key → from the **Display** column select **Display**.
2. Set the **Brightness**. If **Brightness** is set to **Auto**, the monitor automatically adjust the screen brightness according to the ambient light.

3.8.6 Adjusting the Key Volume

To adjust the key volume, follow this procedure:

1. Select the **Main Menu** quick key → from the **Display** column select **Display**.
2. Set the **Key Volume**.

3.9 Starting Monitoring a Patient

After turning on your monitor, follow this procedure to monitor a patient:

1. Admit the patient.
2. Check patient settings. Make sure that alarm limits, patient category and paced status, and so on, are appropriate for your patient. Change them if necessary.
3. Perform desired measurements. For more information, see corresponding measurement chapters.

3.10 Stopping a Parameter Measurement

To stop monitoring a parameter, follow this procedure:

1. Remove corresponding sensor from the patient.
2. Disconnect the sensor from the patient cable.
3. Disconnect the patient cable from the parameter connector.
4. If you are using the disposable sensor, discard it.

3.11 General Operation

This section describes the operations that are generally used when monitoring a patient.

3.11.1 Switching On or Off a Parameter

You can manually switch on or off a parameter when its module is connected. To do so, follow this procedure:

1. Access **Parameters On/Off** by any of the following ways:

- ◆ Select the **Screen Setup** quick key → select the **Parameters On/Off** tab.
 - ◆ Select the **Main Menu** quick key → from the **Parameters** column select **Parameters On/Off**.
2. Switch on or off desired parameters.

When a parameter is switched off, the monitor stops data acquisition and alarming for this measurement.

NOTE

- **When a parameter is manually switched off, you cannot monitor this parameter even if the related accessories of this parameter are connected.**
-

3.11.2 Displaying Parameter Numerics and Waveforms

You can configure the parameter numerics, waveforms, and their sequence displayed on the normal screen. To do so, follow this procedure:

1. Access **Tile Layout** in either of the following ways:
 - ◆ Select the **Screen Setup** quick key → select the **Tile Layout** tab.
 - ◆ Select the **Main Menu** quick key → from the **Display** column select **Tile Layout**.
2. Select a parameter numeric area or waveform area, and then from the popup list select an element you want to display in this area. The parameters and waveforms you did not select will not be displayed.

NOTE

- **ECG parameters and waveform are always displayed on the first line of the parameter numeric area and waveform area.**
-

3.11.3 Accessing Parameter Setup Menus

Each parameter has a setup menu in which you can adjust the alarm and parameter settings. You can enter a parameter setup menu by using any of the following methods:

- Select the parameter numeric area or waveform area.
- Press the setup hard key  on the module front of the CO₂ module.
- Select the **Parameter Setup** quick key, and then select the desired parameter.
- Select the **Main Menu** quick key → from the **Parameters** column select **Setup** → select the desired parameter.

NOTE

- **In this manual, we always use the first method to enter the setup menu. But you can use any method you prefer.**
-

3.11.4 Choosing a Screen

The monitor enters the normal screen after it is powered on. The normal screen is most frequently used for patient monitoring. You can also select other screens. To do so, follow this procedure:

1. Access **Choose screen** in either of the following ways:
 - ◆ Select the **Screen Setup** quick key.
 - ◆ Select the **Main Menu** quick key → from the **Display** column select **Choose screen**.
2. Select the desired screen.

3.11.5 Selecting the Big Numerics Screen

The big numerics screen displays parameter numerics in big font size. You can configure the parameters and their layout on the big numeric screen. You can quickly switch the normal screen and the big numeric screen by swiping left or right on the touchscreen with two fingers. You can also select the big numeric screen by proceeding as follows:

1. Access **Choose screen** in either of the following ways:
 - ◆ Select the **Screen Setup** quick key.
 - ◆ Select the **Main Menu** quick key → from the **Parameter** column select **Choose screen**.
2. Select **Big Numerics**.
3. Select **Big Numerics** tab.
4. Select a parameter numeric area or waveform area, and then from the popup list select an element you want to display in this area.

3.11.6 Changing Measurement Colors

You can set the color of measurement values and waveforms for each parameter. To do so, follow this procedure:

1. Select **Main Menu** quick key → from the **Display** column select **Param Color**.
2. Select the **Current** tab and set the colors of the currently monitoring measurement values and waveforms.
3. Select the **All** tab and set the colors of measurement values and waveforms for all parameters.

3.12 Using the On-Screen Timers

The monitor has a Timer function to notify you when a preset time period is expired. You can simultaneously display up to two timers.

3.12.1 Displaying Timers

To display a timers, follow this procedure:

1. Access **Tile Layout** in either of the following ways:
 - ◆ Select the **Screen Setup** quick key → select the **Tile Layout** tab.
 - ◆ Select the **Main Menu** quick key → from the **Display** column select **Tile Layout**.
2. Click the parameter area where you want to display the timer, and then select a timer from the popup list.

3.12.2 Setting the Timer

You can set each timer independently. To set the timer, follow this procedure:

1. Select the timer area to enter the **Timer Setup** menu.
2. Set **Timer Type**:
 - ◆ **Normal**: The timer has a single and defined run time, and stops when the run time is reached.
 - ◆ **Advanced**: The timer has a single and defined run time. When the run time is reached, the timer continuously displays the time beyond the end of run time.
 - ◆ **Cycled**: The timer has a single and defined run time. When the run time is reached, the timer restarts automatically. The cycles is also displayed.
 - ◆ **Unlimited**: The timer displays the time elapsed since the timer was started.
 - ◆ **Clock**: The timer displays the system time.
3. Set **Direction**.
 - ◆ **Down**: the timer counts down.
 - ◆ **Up**: the timer counts up.
4. Set **Run Time**.
5. Set **Reminder Volume**. A progress bar is shown with the run time. When the remaining time is 10 seconds, the monitor issues a reminder tone and the timer flashes in red, prompting you that the run time is to expire.

NOTE

-
- **You cannot change timer settings when a timer is running.**
 - **You can set Direct, Run Time, and Reminder Volume only for normal, advanced, and cycled timers.**
-

3.13 Using the External Display

The N1 can be connected to an external display through the VGA connector of the Dock. When the external display is connected, you can monitor a patient either through the N1 or through the external display.

The external display configured as independent display can display differently with the N1. For the configuration of the independent external display, see section 3.13.2 *Setting the External Display*.

The following screens or functions can only be viewed and operated on the independent external display:

- Minitrends Screen
- OxyCRG Screen
- View Others Screen
- ECG 7-Lead Half-Screen
- PAWP Screen
- Calculations
- EWS
- GCS
- CPR Dashboard
- ST Graphic

NOTE

- **The external display can share the mouse or keyboard with the monitor. If you need to use the mouse or keyboard, connect the mouse or keyboard to the USB connector of the Dock.**

3.13.1 Connecting the N1 to the External Display

To connect the external display, follow this procedure:

1. Connect the Dock and the external display using the VGA cable.
2. Connect the Dock and the external display using the USB cable accompanying the external display.
3. Connect the external display to the AC mains and turn on the display.
4. Connect the N1 to the Dock.

3.13.2 Setting the External Display

To set the external display, follow this procedure:

1. Select the **Main Menu** quick key → from the **System** column select **Maintenance** → input the required password → select .
2. Select the **Display** tab.
3. Set **Screen Contents**.
 - ◆ **Mirrored**: the contents of the external display is exactly the same with the monitor.
 - ◆ **Independent**: you can separately configure the contents and layout of the monitor and external display.

NOTE

- **The N1 and the independent display cannot display simultaneously. To switch the display, gently press the power switch of the N1, or double click the display you want to use.**
- **In the situation that the Screen Content is set to Independent and you switch the display to the N1, if there is no operation on the monitor within one minute, the display will automatically switch back to the external display.**
- **When the N1 is connected to the Dock, the N1 can use the external screen setting of the Dock. For more information, see section 4.5 *Setting the Dock*.**

3.13.3 External Display Troubleshooting

Problem	Corrective Actions
Image offset	Adjust the external display by using the auto adjust function or adjust the external display manually.
No image or the image displays abnormally	<ul style="list-style-type: none"> • Check that the external display is properly connected to the AC mains and is powered on. • Check that the VGA cable is properly connected. • Remove the N1 from the Dock and reconnect it if the problem persists.
Touchscreen failure	Check that if both ends of the USB cable accompanying the external display are connected properly to the Dock and the external display.

CAUTION

- **Use only specified display. Using unspecified display may result in unknown problem.**

3.14 The OxyCRG Screen (only available for the independent external display)

The OxyCRG screen is the default user screen when the neonatology department is selected. It displays 6-minute HR/btbHR, SpO₂ trends, CO₂/Resp compressed waveform, ABD parameters, and the latest ABD events.

The OxyCRG function is intended for neonatal patents only.

3.14.1 Entering the OxyCRG Screen

To enter the OxyCRG screen, choose any of the following ways:

- Swipe left or right on the touchscreen with two fingers to switch to the OxyCRG screen.
- Select the **OxyCRG** quick key.
- Select the **Screen Setup** quick key → select the **Choose Screen** tab → select **OxyCRG**.
- Select the **Main Menu** quick key → from the **Display** column select **Choose Screen** → select **OxyCRG**.

3.14.2 OxyCRG Events

The following table lists the ABD events and their criteria:

Event type	Description	Remarks
A	Zero RR event: the zero RR duration exceeds the threshold. <ul style="list-style-type: none"> • A20: the zero RR duration is greater or equal to 20 seconds. • A15: the zero RR duration is between 15 to 20 seconds (excluding 20 seconds). • A10: the zero RR duration is between 10 to 15 seconds (excluding 15 seconds). 	A20 is a red event
B	Low heart rate event: the duration of low heart rate exceeds the threshold.	/
D	Low SpO ₂ event: the duration of SpO ₂ Desat exceeds the threshold.	/
BD	Low heart rate and low SpO ₂ happen at the same time.	/
AB	Zero RR and low heart rate happen at the same time.	Red event
AD	Low heart rate and low SpO ₂ happen at the same time.	Red event
ABD	Zero RR, low heart rate, and low SpO ₂ happen at the same time.	Red event

NOTE

- **The monitor records all ABD events for OxyCRG review, but only red events displays in the ABD list of the OxyCRG screen.**

3.14.3 The Display of the ABD Event Area

The ABD event area displays parameter values of currently active OxyCRG events and lists the latest red ABD events.

3.14.4 Setting OxyCRG Parameters

Select parameter trends or compressed waveform to set parameters and the compressed waveform you want to display. The selected parameters will be used for ABD event calculation.

3.14.5 Setting the Threshold of ABD Events

Select any parameter trend or the compressed waveform to perform the following setup:

- Set the threshold of ABD events.
- Set **Event Storage Format**:
 - ◆ **1 min+3 min**: stores data one minute before and three minutes after the event.
 - ◆ **3 min+1 min**: stores data three minutes before and one minute after the event.
 - ◆ **2 min+2 min**: stores data two minutes before and two minutes after the event.

The stored data includes the trends of the OxyCRG parameters, compressed waveform, alarm thresholds, NIBP, and Temp measurements.

3.14.6 Editing ABD Events

To edit ABD events, follow this procedure:

1. Select the **Mark** button to enter the **Mark** dialog box.
2. Drag the event list upwards and downwards to select the desired event.
3. Select the patient's status when the event happens.
4. Select **Save**.

3.15 Turning Off the Monitor

Before turn off the monitor, perform the following check:

1. Ensure that the monitoring of the patient has been completed.
2. Disconnect the cables and sensors from the patient.
3. Make sure to save or clear the patient monitoring data as required.

To turn off the monitor, press and hold the power switch for 3 seconds.

CAUTION

- **Press and hold the power switch for no less than 10 seconds to forcibly shut down the monitor if it could not be shut down normally. This may cause loss of patient data.**
-

NOTE

- **Turning off the monitor does not disconnect the monitor from the AC mains. To completely disconnect the power supply, unplug the power cord.**
 - **In case of a temporary power failure, if the power is restored within 30 minutes, monitoring will resume with all active settings unchanged; if the monitor is without power for more than 30 minutes, the monitor behaves the same as it is normally turned off.**
-

4 Managing Patients

4.1 Discharging a Patient

Before monitoring a new patient, discharge the previous patient. After the patient is discharged, all patient data, including patient information, trend data, and physiological alarm information is deleted from the monitor. The technical alarms is reset, and monitor settings returns to their defaults. For more information, see *5.3 Setting Default Configuration*.

After a patient is discharged, the monitor automatically admit a new patient.

WARNING

- **Always discharge the previous patient before starting monitoring a new patient. Failure to do so can lead to data being attributed to the wrong patient.**

NOTE

- **Discharging a patient deletes all history data from the monitor.**
-

4.1.1 Auto Discharging a Patient after Monitor Power Off

You can let the monitor automatically discharge after the monitor has been switched off for a period of time.

To set the time period of discharging a patient, follow this procedure:

1. Select the **Main Menu** quick key → from the **System** column select **Maintenance** → input the required password → select .
2. Select the **Patient Management** tab → select the **Discharge** tab.
3. Select a time for **Auto Discharge When Power Off**. The monitor will automatically discharge the patient when it is turned off for the designated period of time. The default is **Never**. That is to say the monitor will not discharge a patient no matter for how long the monitor has been switched off.

4.1.2 Manually Discharging a Patient

Manually discharge a patient using any of the following methods:

- Swipe down the touchscreen with two fingers → select **Discharge**.
- Select the patient information area at the top left corner of the screen → **Discharge Patient**.
- Select the **Main Menu** quick key → from the **Patient Management** column select **Discharge**.

Select a desired item from the **Discharge Patient** dialog box:

- **Print End Case Report:** prints the end case report when the patient is discharged.
- **Discharge:** all patient data, including patient information, trend data, and physiological alarm information, is deleted from the monitor. The technical alarms is reset. The monitor loads the default configuration and goes to the standby mode.
- **Clear Patient Data:** all patient data is deleted from the monitor. The monitor still uses the current monitor settings.

4.2 Admitting a Patient

The monitor admits a new patient in the following situations:

- After a patient is manually discharged, the monitor automatically admit a new patient.
- After being switched off for the selected time period, the monitor automatically discharge the previous patient and admit a new patient at startup.
- If the monitor has not detected certain patient vital signs (ECG, SpO₂, PR, RR, NIBP) for 30 minutes, you will be prompted whether to start monitoring a new patient if any of the above vital signs are detected again.

Always inputs patient information as soon as the patient is admitted. For more information, see *4.3.2 Editing Patient Information* for details.

WARNING

- **The settings of patient category and paced status always contain a default value, regardless of whether the patient is admitted or not. Check if the setting is correct for your patient.**
 - **For paced patients, you must set Paced to Yes. If it is incorrectly set to No, the monitor could mistake a pace pulse for a QRS and fail to alarm when the ECG signal is too weak.**
 - **For non-paced patients, you must set Paced to No.**
-

4.3 Managing Patient Information

4.3.1 Entering the Patient Management Menu

Use any of the following methods to enter the **Patient Management** menu:

- Select the patient information area at the top left corner of the screen.
- Select the **Main Menu** quick key → from the **Patient Management** column select **Demographics**.

4.3.2 Editing Patient Information

Edit patient information after a patient has been admitted, or when patient information is incomplete, or when you want to change patient information:

To edit patient information, follow this procedure:

1. Enter the **Patient Management** menu. For more information, see *4.3.1 Entering the Patient Management Menu*.
2. Edit patient information as required.

If you connect a barcode reader with your monitor, you can scan the patient's barcode to enter the patient's information.

NOTE

- **The monitor will reload the configuration if you changed the patient category.**
-

4.3.3 Loading Patient Information from the CMS

If the monitor is connected to the central monitoring system (CMS). You can load patient information from the CMS to the monitor. To do so, follow this procedure:

1. Enter the **Find Patient** menu in either of the following ways:
 - ◆ Select the **Main Menu** quick key → from the **Patient Management** column select **Find Patient**.
 - ◆ From the **Patient Management** menu select **Find Patient**.
2. Input query criteria. If your monitor is connected with the ADT server, input query criteria from the **Discharged Patient** page.
3. Select **Search**. Then a list pops up, including all the patients that meet the query criteria.

4. Select a patient from the patient list, and then select **Import**. Corresponding patient information in the monitor will be updated.

4.3.4 Loading Patient Information from the ADT Server

If the monitor is connected with the Admit-Discharge-Transfer (ADT) server through the eGateway. You can load patient information from ADT server to the monitor. To do so, follow this procedure:

1. Enter the **Find Patient** menu in either of the following ways:
 - ◆ Select the **Main Menu** quick key → from the **Patient Management** column select **Find Patient**.
 - ◆ Select **Find Patient** from the **Patient Management** menu.
2. Input query criteria.
3. Select **Query**. Then a list pops up, including all the patients that meet the query criteria.
4. Select a patient from the patient list, and then select **Import**. Corresponding patient information in the monitor will be updated.

NOTE

- You can load patient information from the ADT server only when ADT Query is enabled. For more information, see 6.5 Using the ADT Gateway.
 - Loading patient information from the ADT server updates only patient information in the monitor. The patient's monitoring data is not changed and the patient is not discharged.
-

4.3.5 Selecting Query Criteria for Searching Patients in ADT Server

You can define which criteria can be used to search patients in the ADT server. To do so, follow this procedure:

1. Select the **Main Menu** quick key → from the **System** column select **Maintenance** → input the required password → select .
2. Select the **Patient Management** tab → **ADT Query** tab.
3. Select the query criteria as desired.

4.3.6 Changing Patient Management Settings

You can define which items can be displayed and edited from the **Patient Management** menu. To do so, follow this procedure:

1. Select the **Main Menu** quick key → from the **System** column select **Maintenance** → input the required password → select .
2. Select the **Patient Management** tab.
3. Select the fields you want to display in the **Patient Management** menu.
4. If necessary, select the customized fields and input names for these fields.

NOTE

- If the monitor is connected with the CMS, the patient information items and customized fields are loaded from the CMS.
-

4.3.7 Setting Monitor Information

To set monitor information, follow this procedure:

1. Select the **Main Menu** quick key → from the **System** column select **Maintenance** → input the required password → select .
2. Select the **Device Location** tab.
3. Input monitor name, facility name and department name.

4.3.8 Setting Monitor Location

If your monitor is installed at a fixed position, or you do not need to frequently change the room number and bed number, you can set **Monitor Location** to **Fixed**. To set the monitor location, follow this procedure:

1. Select the **Main Menu** quick key → from the **System** column select **Maintenance** → input the required password → select .
2. Select the **Device Location** tab.
3. Set **Location**.
 - ◆ **Fixed:** the **Patient Management** menu displays **Bed No.** and **Room No.**, but you cannot change them.
 - ◆ **Unfixed:** you can change **Bed No.** and **Room No.** from the **Patient Management** menu.
4. Input room number and bed number.

NOTE

-
- **If Location is set to Unfixed, Bed No. and Room No. are cleared each time you discharge a patient.**
-

4.3.9 Setting Patient Location

To set patient location, follow this procedure:

1. Select the **Main Menu** quick key → from the **System** column select **Maintenance** → input the required password → select .
2. Select the **Patient Management** tab.
3. Select the **Location** tab.
4. Input patient location as desired.

4.3.10 Hiding Patient Name

To hide patient name, follow this procedure:

1. Select the **Main Menu** quick key → from the **System** column select **Maintenance** → input the required password → select .
2. Select the **Patient Management** tab.
3. Select the **Display** tab.
4. Set the following switches as desired:
 - ◆ Switch off **Primary Screen Display Full Name:** does not display patient name in the patient information area on the primary display.
 - ◆ Switch off **Remote View Display Full Name:** does not display patient name in the patient information area on the remote monitors when this monitor is viewed by other monitors.
 - ◆ Switch off **Remote View Bedlist Display Full Name:** does not display patient name in bed list on the remote monitors when this monitor is viewed by other monitors.

4.4 Transferring Patient Data

You can transfer the patient data between N1 and the host monitor without re-entering the patient demographic information or changing the settings. Transferring of patient data enables you to understand the patient's history condition. The patient data that can be transferred includes: patient demographics, trend data, event data, full disclosure waveform and parameters settings. The trends data and event data from the parameter modules of the host monitor can also be transferred.

For detailed information about patient data transfer, refer to the user manual of the host monitor. For the connection of N1 and the host monitor, refer to section 2.8 *N1 in Use with the Host Monitor*.

WARNING

- **Do not discharge a patient before the patient is successfully transferred.**

- After a patient is successfully transferred, check if the patient settings (especially patient category, paced status, alarm limits settings, and etc) on the monitor are appropriate for this patient.

NOTE

- The system automatically switches on the HR alarm and lethal arrhythmia alarm after transferring the patient data.
-

4.5 Setting the Dock

After the N1 is transferred to the target location, connecting the N1 to a Dock enables N1 to use the settings of the Dock. All the settings in this section are stored in the Dock. When the N1 is disconnected from the Dock, the N1 uses its own settings and network.

4.5.1 Setting the Work Mode

To set the work mode of the Dock, follow this procedure:

1. Connect the N1 to the Dock.
2. Select the **Main Menu** quick key → from the **System** column select **Maintenance** → input the required password → select .
3. Select the **Dock Setup** tab → select the **Setup** tab.
4. Set the **Work Mode**. The default work mode is **Dock Mode**.
 - ◆ **Dock Mode**: the patient location settings (facility, department, room number, and bed number), printer settings, and authorization settings are from the N1. You can change these settings on **Device Location, Print, or Authorization Setup** page from the **Maintenance** menu.
 - ◆ **Host Mode**: the patient location settings (facility, department, room number, and bed number), printer settings, and authorization settings are from the Dock. You can change these settings on **Location, Print, or Authorization Setup** tab from the **Dock Setup** page.

4.5.2 Setting the Net Setting Type

To set the network setting type of the Dock, follow this procedure:

1. Connect the N1 to the Dock.
2. Select the **Main Menu** quick key → from the **System** column select **Maintenance** → input the required password → select .
3. Select the **Dock Setup** tab → select the **Setup** tab.
4. Set the **Net Setting Type**. The default work mode is **Use current N1 net setting**.
 - ◆ **Use current N1 net setting**: the IP and WLAN settings are from the N1. You can change these settings on **Network Setup** page from the **Maintenance** menu.
 - ◆ **Use current Dock net setting**: the IP and WLAN settings are from the Dock. You can change these settings on **IP, or WLAN** tab from the **Dock Setup** page.

4.5.3 Setting the Network of the Dock

4.5.3.1 Selecting a Network Type

To select network type, follow this procedure:

1. Connect the N1 to the Dock.
2. Select the **Main Menu** quick key → from the **System** column select **Maintenance** → input the required password → select .
3. Select the **Dock Setup** tab → select the **Setup** tab.
4. Set the **Work Mode** to **Host Mode**.
5. Select the **IP** tab.
6. Set **Network Type** to **LAN1 IP**, or **WLAN** according to your network type.

4.5.3.2 Setting the Wired Network

The wired networking is available as long as N1 is connected to the Dock. To set the wired network, follow this procedure:

1. Connect the N1 to the Dock.
2. Select the **Main Menu** quick key → from the **System** column select **Maintenance** → input the required password → select .
3. Select the **Dock Setup** tab → select the **Setup** tab.
4. Set the **Work Mode** to **Host Mode**.
5. Select the **IP** tab.
6. Set **Network Type** to **LAN1 IP**.
7. Select how to get the IP address of wired network.

- ◆ **Obtain IP Address Automatically:** the monitor automatically gets the IP address.
- ◆ **Use the Following Address:** you need to input the **IP address**, **Subnet mask**, and **Gateway**.

4.5.3.3 Setting the Wireless Network

To set the wireless network of the Dock, follow this procedure:

1. Connect the N1 to the Dock.
2. Select the **Main Menu** quick key → from the **System** column select **Maintenance** → input the required password → select .
3. Select the **Dock Setup** tab → select the **Setup** tab.
4. Set the **Work Mode** to **Host Mode**.
5. Select the **IP** tab, and set **Network Type** to **WLAN**.
6. Select how to get the IP address of wireless network.

- ◆ **Obtain IP Address Automatically:** the monitor automatically gets the IP address.
- ◆ **Use the Following Address:** you need to input the **IP address**, **Subnet Mask**, and **Gateway**.

7. Select the **WLAN** tab and set **SSID**, **Security**, and **Password**.

4.5.4 Setting the External Display

To set the external display, follow this procedure:

1. Connect the N1 to the Dock.
2. Select the **Main Menu** quick key → from the **System** column select **Maintenance** → input the required password → select .
3. Select the **Dock Setup** tab → select the **Setup** tab.
4. Set the **External Screen Contents**.
 - ◆ **Mirrored:** the contents of the external display is exactly the same with the monitor.
 - ◆ **Independent:** you can separately configure the contents and layout of the monitor and external display.

NOTE

- **When the N1 is disconnected from the Dock, N1 uses its own external display setting. For the external display setting of the N1, see section 3.13.2 *Setting the External Display*.**

4.6 Connecting the CMS

You can connect the monitor to the BeneVision CMS. When connected to the CMS, the system provides the following function.

- The monitor can transmits parameter values, waveforms, alarm settings, and events to the CMS. From the CMS, you can check the patient's monitoring data and alarms.
- Patient information, alarm settings, and alarm status can be synchronized between the monitor and the CMS.
- You can start or stop NIBP measurements from the CMS.
- In case of network disconnection, the monitor can transmit the offline data to the CMS when network is reconnected.

For more information on the CMS, see *BeneVision Central Monitoring System Operator's Manual (PN: 046-007687-00)*.

5 Managing Configurations

5.1 Configuration Introduction

When performing continuous monitoring on a patient, the clinical professional often needs to adjust the monitor's settings according to the patient's condition. The collection of all these settings is called a configuration. The system configuration items can be classified as: parameter configuration items, conventional configuration items, and user maintenance items. Allowing you to configure the monitor more efficiently, the monitor provides different sets of configurations to accommodate the varying patient categories and departments. You can change some settings from a certain set of configuration and then save the changed configuration as a user configuration.

The default configurations provided for your monitor are department-oriented. You can choose either from:

- General
- OR
- ICU
- NICU
- CCU

Each department has three different sets of configurations tailored for adult, pediatric and neonatal patients.

WARNING

- **The configuration management function is password protected. The configuration management tasks must be performed by clinical professionals.**
-

5.2 Changing the Department

If the current department configuration is not the one you want to view, you can change the department by following this procedure:

1. Select the **Main Menu** quick key → from the **Configuration** column select **Manage** → input the required password → select .
2. Select **Change Department**.
3. Select a department.
4. Select **OK**.

CAUTION

- **Changing the department will delete all current user configurations.**
-

5.3 Setting Default Configuration

The monitor will load the pre-set default configuration in the following cases:

- A patient is admitted.
- A patient is discharged.
- Patient category is changed.

To set the default configuration, follow this procedure:

1. Select the **Main Menu** quick key → from the **Configuration** column select **Manage** → input the required password → select .
2. Select **Select Default Config.**
3. Select **Load the Latest Config** or **Load Specified Config.**
 - ◆ When you select **Load Specified Config**, the restored configuration is subject to the patient category (adult, pediatric or neonate). This configuration can be either factory configuration or a saved user configuration. As an example, select **Default Adult Config** and then select **Factory Default** or user configuration(s).
 - ◆ When you select **Load the Latest Config**, the latest configuration is loaded when the monitor is started or a patient is admitted.

5.4 Saving Current Settings

Current settings can be saved as a user configuration. Up to 10 user configurations can be saved.

To save current settings, follow this procedure:

1. Select the **Main Menu** quick key → from the **Configuration** column select **Manage** → input the required password → select .
2. Select **Save Current Settings.**
3. Input the configuration name.
4. Select **OK** to save current settings as a user configuration.

5.5 Deleting a Configuration

To delete a configuration, follow this procedure:

1. Select the **Main Menu** quick key → from the **Configuration** column select **Manage** → input the required password → select .
2. Select **Delete Configuration.**
3. Select the configuration you want to delete:
 - ◆ In the **Delete Configuration** menu, selecting **Local** tab shows the existing user configurations on the monitor.
 - ◆ In the **Delete Configuration** menu, selecting **USB Drive** tab shows the existing user configurations on the USB drive.
4. Select **Delete.**
5. Select **OK.**

5.6 Transferring a Configuration

When installing several monitors with identical user configurations, it is not necessary to set each unit separately. Use a USB drive to transfer the configuration from monitor to monitor.

5.6.1 Exporting a Configuration

To export the current monitor's configuration, follow this procedure:

1. Connect the monitor to the Dock.
2. Connect the USB drive to the Dock's USB port.
3. Select the **Main Menu** quick key → from the **Configuration** column select **Manage** → input the required password → select .
4. Select **Export Configuration.**
5. Select the configurations and **User Maintenance Settings** to export.
6. Select **Export.**

5.6.2 Importing a Configuration

To import the configuration from the USB drive to the monitor, follow this procedure:

1. Connect the monitor to the Dock.
2. Connect the USB drive to the Dock's USB port.
3. Select the **Main Menu** quick key → from the **Configuration** column select **Manage** → input the required password → select .
4. Select **Import Configuration**.
5. Select the configurations and **User Maintenance Settings** to import.
6. Select **Import**.

5.7 Loading a Configuration

You may make changes to some settings during operation. However, these changes or the pre-selected configuration may not be appropriate for the newly admitted patient. Therefore, the monitor allows you to load a desired configuration to ensure that all the settings are appropriate for your patient.

To load a configuration, follow this procedure:

1. Select the **Main Menu** quick key → from the **Configuration** column select **Load**.
2. Select the desired configuration.
 - ◆ Select the configuration on this monitor in the **Local** page.
 - ◆ Select the configuration on the USB drive in the **USB Drive** page.
3. Select **Load**.

NOTE

-
- **The monitor may configure some settings by default when you load a configuration of different software version with the current configuration.**
-

5.8 Modifying Configuration Password

To modify the configuration password, follow this procedure:

1. Select the **Main Menu** quick key → from the **Configuration** column select **Manage** → input the required password → select .
2. Select **Modify Password**.
3. Respectively input the old password and new password.
4. Select **OK**.

6 Networked Monitoring

6.1 Network Introduction

You can connect the monitor to the central monitoring system (CMS), and eGateway through wired LAN or wireless LAN.

6.2 Network Safety Information

CAUTION

- **Wireless network designing, deploying, debugging, and maintenance should be executed by Mindray service personnel or authorized technicians.**
 - **Always set the wireless network according to local wireless regulations.**
 - **Keep network authentication information, for example password, safe, protecting the network from being accessed by unauthorized users.**
 - **Do not connect non-medical devices to the monitor network.**
 - **If wireless network signal is poor, there may be a risk of CMS data loss.**
 - **RF interference may result in wireless network disconnection.**
 - **Disconnecting from the network may result in CMS data loss and function failure. Check the patient in case of network disconnection and solve the network problem as soon as possible.**
 - **Ensure that the monitor IP address setting is correct. Changing the network settings may result in network disconnection. Contact your service personnel if you have any problems on setting the IP address.**
-

6.3 Connecting the Monitor to the CMS

To connect the monitor to the CMS, follow this procedure:

1. Set the **IP address**, **Subnet Mask**, and **Gateway**. For more information, see section 6.8 *Configuring the Network*.
2. Connect the monitor to the CMS through either of the following methods:
 - ◆ Admit the monitor on the CMS. Refer to the *BeneVision Central Monitoring System Operator's Manual (PN: 046-007687-00)* for details of admitting a monitor.
 - ◆ Setting the CMS (refer to section 6.3.1 *Setting the CMS* for details), and then selecting a CMS (refer to section 6.3.2 *Selecting a CMS* for details).

6.3.1 Setting the CMS

You can add up to 30 central stations (CMS) for your monitor. To set the CMS, follow this procedure:

1. Select the **Main Menu** quick key → from the **System** column select **Maintenance** → input the required password → select .
2. Select the **Network Setup** tab → **Central Station Setup** tab.
3. Select **Add Central Station** and set the **Name** and **IP Address** of the CMS.
4. Edit or delete the CMS as desired.

6.3.2 Selecting a CMS

1. Select the **Main Menu** quick key → from the **System** column select **Maintenance** → input the required password → select .
2. Select the **Network Setup** tab → **Central Station Setup** tab.

3. Enable the **Select CMS**.
4. Select the system status information area at the top right corner of the screen.

6.4 Connecting the eGateway

You can connect the monitor to the eGateway to implement interaction between the monitor and external devices. When connected to the eGateway, the system provides the following functions:

- The monitor can transmit parameter values, waveforms, alarm settings, and events to the eGateway.
- Clock can be synchronized between the monitor and the eGateway.

6.5 Using the ADT Gateway

The ADT (admit-discharge-transfer) gateway is normally deployed in the eGateway. You can obtain patient information from the hospital ADT server through the ADT gateway.

To configure the ADT gateway, follow this procedure:

1. Select the **Main Menu** quick key → from the **System** column select **Maintenance** → input the required password → select .
2. Select the **Network Setup** tab → **ADT** tab.
3. Set **IP Address** and **Port** for the ADT gateway.

ADT Query is switched on by default. You can load patient information to the monitor from the ADT server only when this function is enabled.

6.6 Sending Realtime Data, Waveforms and Alarms via HL7 Protocol

You can send the realtime data, waveforms, and alarms from the monitor to the hospital servers via HL7 protocol. To do so, follow this procedure:

1. Select the **Main Menu** quick key → from the **System** column select **Maintenance** → input the required password → select .
2. Select the **Network Setup** tab → **HL7 Configuration** tab.
3. Switch on **Send Data**, **Send Waveform**, and **Send Alarms** as needed.
4. From the **Data + Waveforms** column, set **Destination IP** and **Port** for the server receiving the realtime data and waveform.
5. Set **Data Interval**.
6. From the **Alarms** column, set **Destination IP** and **Port** for the server receiving the alarm data.

This page also display the server connection status.

6.7 Viewing Other Patients (Only available for the independent external display)

The patient alarm and real time physiological data of the N1 can be viewed by other networked monitors. When the external display is connected, you can also observe alarm conditions and view real time physiological data from patients on other networked monitoring devices.

A device from a remote site is called a remote device or bed, for example, a bedside monitor. You can simultaneously watch up to 12 remote devices. You can also view waveforms of one remote device on the external display.

You can watch the remote devices in the **Remote View** window, or the alarm watch tiles on the main screen.

NOTE

- **You can also view this monitor from remote devices. This monitor can be viewed by at most 32 remote devices at the same time, in which eight remote devices can watch this monitor's waveforms.**

6.7.1 Remote View

In the **Remote View** window, you can view real time parameters and waveforms from one specific device, and watch the alarms of other monitored devices at the same time.

6.7.1.1 Entering the Remote View Window

To enter the **Remote View** window, choose one of the following ways:

- Select the **Remote View** quick key.
- Select the bed at the alarm watch tile on the main screen. For more information, see *6.7.2.2 Displaying the Alarm Watch Tile on the Main Screen* for configuring to display the tile on the main screen.
- Select the **Screen Setup** quick key → select the **Choose Screen** tab → select **Remote View**.

6.7.1.2 About the Remote View

The following figure shows the **Remote View** window.

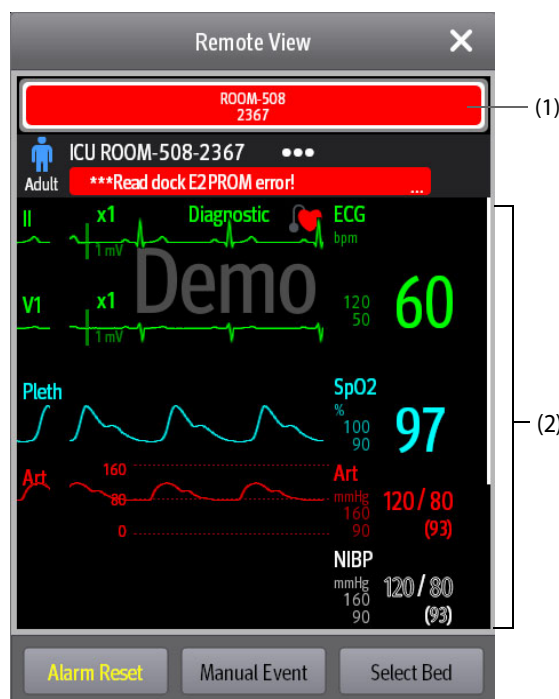

(1) Alarm watch area

- Display all the monitored remote beds.
- Each bed displays the room number, bed number, connection status and alarm status. The background color indicates the alarm status on the corresponding bed.

Background Color	Description
Green	No alarm is occurring to the bed.
Red	The remote device is disconnected or a high priority alarm is occurring. The high priority alarm currently is the highest alarm level on the bed. If the remote device is disconnected, the  icon is displayed.
Yellow	The medium priority alarm is occurring. The medium priority alarm currently is the highest alarm level on the bed.
Cyan	The low priority alarm is occurring. The low priority alarm currently is the highest alarm level on the bed.
Grey	The bed is in the standby mode.

- (2) Main body

Display the patient's information, alarm status and messages, waveforms, measurements, etc. of the selected bed. This bed is called main bed.

6.7.1.3 Adding a Bed

You need to add the desired remote devices, and then the alarms from these devices can be watched on your monitor. To add a remote device, follow this procedure:

1. Enter the **Select Bed** window. To do so, choose either of the following ways:
 - ◆ In the **Remote View** window, select **Select Bed**. For more information, see 6.7.1.1 *Entering the Remote View Window* for entering the **Remote View** window.
 - ◆ Select the  icon at the alarm watch tile if the tile is configured to display on the main screen.
2. In the **Select Bed** window, select a desired department. All the beds under this department will be listed.
3. Select a desired tile at the A-W1, or A-W2 areas and then select a bed from the bed list. The selected bed will appear in the tile.

NOTE

- The added bed is indicated by a ✓ check mark at the right of the bed list.

6.7.1.4 Removing a Bed

If you do not want to monitor a remote device any longer, you can remove it. To remove a remote device, follow this procedure:

1. Enter the **Select Bed** window. Choose either of the following ways:
 - ◆ In the **Remote View** window, select **Select Bed**. For more information, see 6.7.1.1 *Entering the Remote View Window* for entering the **Remote View** window.
 - ◆ Select the  icon in the alarm watch tile if the tile is configured to display on the main screen.
2. In the **Select Bed** window, select a bed at the A-W1 or A-W2 area, and then select **Clear Bed**. If you want remove all beds, select **Clear All Beds**.

6.7.1.5 Displaying the Main Bed

In the **Remote View** window, you can select a bed at the alarm watch area, then the main body of the **Remote View** window will display the real time monitoring screen of the device.

6.7.1.6 Saving a Manual Event

You can initiate a manual event by selecting **Manual Event** in the **Remote View** window.

The manual event stores in the event review of the corresponding remote device.

6.7.1.7 Resetting Alarms for Remote Devices

You can reset the alarms on the remote devices by selecting **Alarm Reset** in the **Remote View** window. This function needs to be enabled. To enable this function, follow this procedure:

1. Select the **Main Menu** quick key → from the **System** column select **Maintenance** → input the required password → select .
2. Select the **Alarm** tab → **Remote View** tab.
3. Switch on **Reset Remote Bed's Alarms**. Then the **Alarm Reset** button appears on the bottom left of the **Remote View** window.
4. To reset remote device alarms, select **Alarm Reset**.

NOTE

- You can reset remote device alarms only if the **Alarm Reset by Other Bed** switch is on at the remote devices.

6.7.2 Alarm Watch

The alarm watch function provides the alarm notification by color and sound.

- The monitor sounds the highest priority alarm tone from all the monitored remote devices.
- The moitor displays the highest priority alarm in corresponding background color for each bed at following areas:
 - ◆ At the top of the **Remote View**. For more information, see 6.7.1.2 *About the Remote View* for details.
 - ◆ On the main screen. For more information, see 6.7.2.1 *About Alarm Watch Tile* for details.

6.7.2.1 About Alarm Watch Tile

The main screen can display up to three alarm watch tiles, namely A-W1 and A-W2. Each tile can accommodate up to six beds.

The following figure shows the alarm watch tiles.

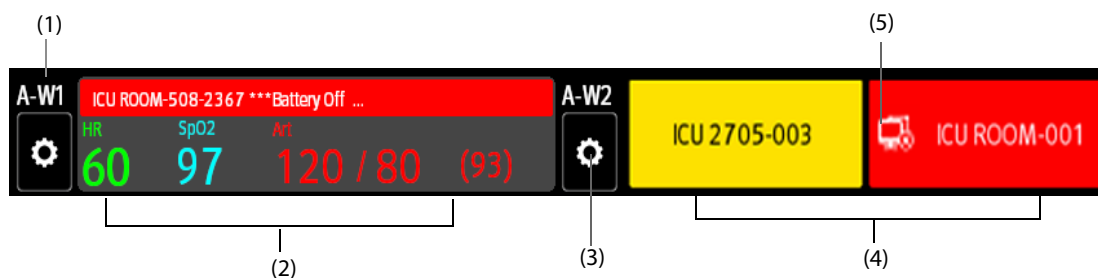

- (1) Alarm watch tile label
- (2) One bed tile: when only one bed is assigned to a tile, the tile displays the parameter value and alarm message from this bed, etc.
- (3) Select bed icon: select it to enter the **Select Bed** window.
- (4) More than one bed tile: when more than one bed is assigned to a tile, the tile displays the alarm status, connection status, etc.
- (5) Disconnection icon: when the remote device is disconnected, this icon displays at the tile, and the tile background color is red.

The alarm watch tile is similar to alarm watch area in the **Remote View**. For more information, see 6.7.1.2 *About the Remote View*.

6.7.2.2 Displaying the Alarm Watch Tile on the Main Screen

To configure the alarm watch tile to be displayed on the monitor's main screen, follow this procedure:

1. Select the **Main Menu** quick key → from the **Display** column select **Choose Screen** to enter the **Screen Setup** menu.
2. Select the **Tile Layout** tab.
3. Select the numeric area where you want to display the alarm watch tile, and then in the drop-down list, select **Alarm Watch** → **A-W1** or **A-W2**.

6.8 Configuring the Network

6.8.1 Setting the Wireless Network

To set the wireless network of the N1, follow this procedure:

1. Select the **Main Menu** quick key → from the **System** column select **Maintenance** → input the required password → select .
2. Select the **Network Setup** tab → **WLAN**.
3. Input **SSID**, **Security**, and **Password**.
4. Select the **WLAN IP** tab and select how to get the IP address.
 - ◆ **Obtain IP Address Automatically:** the monitor automatically gets the IP address.
 - ◆ **Use the Following Address:** you need to input the **IP address**, **Subnet Mask**, and **Gateway**.

The monitor supports the following security methods: WEP OFF, WEP ON, WPA PSK, WPA TKIP, WPA2 PSK, WPA2 AES, CCKM TKIP, CCKM AES, WPA PSK AES, WPA AES.

Selecting the security method as desired. You may need to set more parameters for some security methods.

NOTE

- **When the N1 is connected to a Dock, the N1 can use the network setup of the Dock. For more information about the network setup of the Dock, see section 4.5 Setting the Dock.**

6.8.2 Disconnecting the Wireless Network

To disconnect the wireless network manually, follow this procedure:

1. Swipe the screen from top down with a single finger.
2. Select .

To reconnect the wireless network after it is disconnected manually, follow this procedure:

1. Swipe the screen from top down with a single finger.
2. Select .

6.8.3 Selecting WLAN Band and Channels

The monitor supports 2.4 G and 5 G WLAN. To select WLAN band rate and channels, follow this procedure:

1. Select the **Main Menu** quick key → from the **System** column select **Maintenance** → input the required password → select .
2. Select the **Network Setup** tab → **WLAN** tab.
3. Select **WLAN Setup** from the bottom left corner of the menu.
4. Set **WLAN Band** to **Auto**, **5G**, or **2.4G** according to the band you are using. The default is **Auto**, which means the monitor can automatically identify the WLAN band.
5. Select **Auth Server Type** to set the type of authentication server.
6. Set **BGN Channel**.
7. Set **AN Channel**.

6.8.4 Managing Certifications

You can delete certifications from the monitor, or import certifications from the USB memory. To do so, follow this procedure:

1. Select the **Main Menu** quick key → from the **System** column select **Maintenance** → input the required password → select .
2. Select the **Network Setup** tab → **WLAN** tab.

3. Select **Certification Management** from the bottom left corner of the menu.
 - ◆ From the **Local** tab, select certifications you want to delete from the monitor, and then select **Delete**.
 - ◆ From the **USB Drive** tab, select certifications you want to import from the USB memory, and then select **Import**.

6.8.5 Setting Multicast Parameters

Multicast helps device discovery between monitors and between monitors and CMS. Devices in the same multicast group can be mutually discovered.

To set multicast parameters, follow this procedure:

1. Select the **Main Menu** quick key → from the **System** column select **Maintenance** → input the required password → select .
2. Select the **Network Setup** tab → **Device Discover** tab.
3. Set **Multicast TTL**.
4. Set **Multicast Address**.

6.8.6 Setting the Network Service Quality Level

To set the quality of service (QoS), follow this procedure:

1. Select the **Main Menu** quick key → from the **System** column select **Maintenance** → input the required password → select .
2. Select the **Network Setup** tab → **QoS** tab.
3. Select **QoS Level For Realtime Monitoring** to set the service quality of network connection for realtime monitoring, for example parameter measurements and waveforms, alarms, and so on. It is suggested that you set the service quality for realtime monitoring to a higher level.
4. Select **QoS Level For Others** to set the service quality of network connection for non-realtime monitoring, for example history data, printing, and as on.

6.8.7 Selecting Data Encryption Type

To set data encryption type, follow this procedure:

1. Select the **Main Menu** quick key → from the **System** column select **Maintenance** → input the required password → select .
2. Select the **Network Setup** tab → **Encryption** tab.
3. Select **Encryption Connection Type** to set data encryption type when connecting devices:
 - ◆ **Only Private Encryption:** Mindray private encryption is used to encrypt the transmitted data. You cannot connect devices supporting SSL (secure sockets layer) encryption.
 - ◆ **SSL Encryption Priority:** for devices supporting SSL encryption, SSL encryption is used when connecting the devices. For devices not supporting SSL encryption, private encryption is used when connecting the devices.

6.8.8 Disabling the Broadcasting Patient Demographics Function

When viewing other patients, device location and patient information of remote devices are displayed in the remote device list by default. To protect patient privacy, you can disable the broadcasting patient demographics function to protect the monitor from sending patient information via broadcast. To do so, follow this procedure:

1. Select the **Main Menu** quick key → from the **System** column select **Maintenance** → input the required password → select .
2. Select **Network Setup** tab → **Information Security** tab.
3. Switch off **Broadcast Patient Demographics**.

Thus, patient information will not display in the remote device list.

6.9 MLDAP

MLDAP refers to Mindray LDAP (Lightweight Directory Access Protocol). It is an independent process which can be installed on eGateway or other application server (Windows). MLDAP provides user identity and authentication.

The MLDAP server is connected with the hospital LDAP server. All monitoring devices are connected to the MLDAP server to implement identity and authentication for the following operations:

- Changing alarm settings
- Changing arrhythmia settings
- Accessing the **Maintenance** menu

6.9.1 Setting MLDAP

To access the MLDAP server, you should set your monitor as follows:

1. Select the **Main Menu** quick key → from the **System** column select **Maintenance** → input the required password → select .
2. Select the **Network Setup** tab → **MLDAP** tab.
3. Set IP address and port of the MLDAP server.

6.9.2 Testing MLDAP Server Connection

To test whether the monitor is properly connected with the MLDAP server, follow this procedure:

1. Select the **Main Menu** quick key → from the **System** column select **Maintenance** → input the required password → select .
2. Select the **Network Setup** tab → **MLDAP** tab.
3. Select **Network Test**.

6.9.3 Selecting Password for User Authentication

You can select what password is used when changing alarm settings, arrhythmia settings, and accessing the **Maintenance** menu. To do so, follow this procedure:

1. Select the **Main Menu** quick key → from the **System** column select **Maintenance** → input the required password → select .
2. Select the **Authorization Setup** tab.
3. From the **Maintenance** area, set **User Maintenance** to select the password for accessing the monitor's **Maintenance** menu.
 - ◆ **Local Password**: the monitor's password for accessing the **Maintenance** menu is required.
 - ◆ **User Password**: the user name and password saved in the MLDAP server are required.
4. From the **Others** area, set **Alarm Setup**: select the password for changing alarm settings.
 - ◆ **No Password**: changing alarm settings is not password protected.
 - ◆ **Local Password**: changing alarm switch, alarm limit, and alarm priority is password protected. The monitor's password for changing alarm settings is required.
 - ◆ **User Password**: changing alarm switch, alarm limit, and alarm priority is password protected. The user name and password saved in the MLDAP server are required.
5. Set **Arrhythmia**: select the password for changing arrhythmia settings.
 - ◆ **No Password**: changing arrhythmia settings is not password protected.
 - ◆ **Local Password**: changing arrhythmia switch, alarm priority, and arrhythmia threshold is password protected. The monitor's password for changing arrhythmia settings is required.
 - ◆ **User Password**: changing arrhythmia switch, alarm priority, and arrhythmia threshold is password protected. The user name and password saved in the MLDAP server are required.

From the **Maintenance** area, selecting **Modify Local Password** can change the monitor's password for accessing the **Maintenance** menu.

From the **Others** area, selecting **Modify Local Password** can change the monitor's password for accessing alarm settings and arrhythmia settings.

6.9.4 Setting the Password Timeout Period

If you use the password saved in the MLDAP server to access the **Maintenance** menu, alarm settings and arrhythmia settings, you can set the password timeout period. If the timeout period is reached, you need to re-enter the password. To do so, follow this procedure:

1. Select the **Main Menu** quick key → from the **System** column select **Maintenance** → input the required password → select .
2. Select the **Authorization Setup** tab.
3. Set **Retention Time**.

7 Alarms

7.1 Alarm Introduction

This chapter describes alarm functions and alarm settings.

7.2 Alarm Safety Information

WARNING

- **A potential hazard can exist if different alarm presets and default configuration settings are used for the same or similar equipment in the same care area, for example an intensive care unit or cardiac operating room.**
 - **If your monitor is connected to the central monitoring system (CMS) or other monitors, alarms can be presented and controlled remotely. Remote suspension, inhibition, or reset of monitor alarms via the CMS or other monitors may cause a potential hazard. For more information, see the operator's manuals of the CMS and the other monitors.**
 - **The monitors in your care area may each have different alarm settings to suit different patients. Always check that the alarm settings are appropriate for your patient before start monitoring. Always make sure that necessary alarm limits are active and set according to the patient's clinical condition.**
 - **Setting alarm limits to extreme values may cause the alarm system to become ineffective. For example, high oxygen levels may predispose a premature infant to retrolental fibroplasia. If this is a consideration do not set the SpO₂ high alarm limit to 100%, which is equivalent to switching the alarm off.**
 - **When the alarm sound is switched off, the monitor gives no alarm tones even if a new alarm occurs. Be careful about whether to switch off the alarm sound or not. When the alarms are off or while alarm audio is paused either temporarily or indefinitely, observe the patient frequently.**
 - **When monitoring patients that are not continuously attended by a clinical operator, properly configure the alarm system and adjust alarm settings as per the patient's condition.**
 - **Do not rely exclusively on the audible alarm system for monitoring. Adjustment of alarm volume to a low level may result in a hazard to the patient. Always make sure that the audio alarm volume level is adequate in your care environment. Always keep the patient under close surveillance.**
-

7.3 Understanding the Alarms

7.3.1 Alarm Categories

The monitor has two different types of alarms: physiological alarms and technical alarms.

- Physiological alarms are triggered by patient measurement exceeding the parameter limits, or by an abnormal patient conditions.
- Technical alarms are triggered by an electrical, mechanical, or other monitor failure, or by failure of a sensors or components. Technical alarm conditions may also be caused when an algorithm cannot classify or interpret the available data.

Apart from the physiological and technical alarms, the monitor can also prompt some messages telling the system status or patient status.

7.3.2 Alarm Priorities

By severity, the alarms are classified into the following priority levels:

- High priority alarms: indicates a life threatening situation or a severe device malfunction. High priority alarms require an immediate response.
- Medium priority alarms: indicates abnormal vital signs or a device malfunction. Medium priority alarms require a prompt response.
- Low priority alarms: indicate a discomfort condition, a device malfunction, or an improper operation. Low priority alarms require you to be aware of this condition.
- Messages: provides additional information on the patient or the equipment.

7.3.3 Alarm Indicators

When an alarm occurs, the monitor indicates it to you through visual or audible alarm indications. For more information, see the following table.

Alarm Indicator		High Priority Alarm	Medium Priority Alarm	Low Priority Alarm	Message	Comments
Alarm lamp		Red Flashing frequency: 1.4 - 2.8 Hz Duty ratio: 20 - 60%	Yellow Flashing frequency: 0.4 - 0.8 Hz Duty ratio: 20 - 60%	Cyan No flashing Duty ratio: 100%	None	None
Audible tone pattern	ISO	Repeat pattern of 2 × 5 beep tones	Repeat pattern of 3-beep tones	1-beep tone	None	None
	Mode 1	Repeat pattern of high-pitched 3-beep tones	Repeat pattern of 2-beep tones	Low-pitched 1-beep tone	None	
	Mode 2	Repeat pattern of high-pitched 3-beep tones	Repeat pattern of 2-beep tones	Low-pitched 1-beep tone	None	
Alarm message		White text inside a red box	Black text inside a yellow box	Black text inside a cyan box	White text	Alarm messages are displayed in the alarm information area at the top of the screen. You can select the alarm messages to show the alarm list.
Alarm priority indicator		***	**	*	None	The indicator shows in front of corresponding alarm message.
Parameter value		White text inside a flashing red box	Black text inside a flashing yellow box	Black text inside a flashing cyan box	None	None

NOTE

- **When multiple alarms of different priority levels occur simultaneously, the monitor select the alarm of the highest priority to light the alarm lamp and issue the alarm tone.**
- **When multiple alarms of different priority levels occur simultaneously and should be displayed in the same area, the monitor only displays the messages of the highest priority alarm.**
- **When multiple alarms of the same priority levels occur simultaneously and should be displayed in the same area, all the alarm messages are displayed circularly.**

7.3.4 Alarm Status Symbols

Apart from the alarm indicators as described in **7.3.3 Alarm Indicators**, the monitor uses the following symbols to indicate the alarm status:



Alarm pause: indicates that all the alarms are paused.



Alarm off: indicates that individual measurement alarms are turned off or the system is in the alarm off status.



Audio pause: indicates that audible alarm tones are paused.



Audio off: indicates that audible alarm tones are turned off.



Alarm reset: indicates that alarms are acknowledged and the alarm system is reset.

7.4 Accessing On-screen Help for Technical Alarms (AlarmSight)

In the technical alarm list, alarm messages followed by **Detail** include help messages or pictures to help you identify the problem. This function is called AlarmSight. To access AlarmSight, follow this procedure:

1. Select the technical alarm information area to enter the **Alarms** window.
2. Select the **Technical Alarms** tab.
3. From the alarm list select the desired alarm.

7.5 Checking Physiological Alarm List

To check the physiological alarm list, follow this procedure:

1. Select the physiological alarm information area to enter the **Alarms** window.
2. Select the **Physiological Alarms** tab.

7.6 Changing Alarm Settings

From the **Alarm** column of the main menu select desired buttons to set alarm properties.

7.6.1 Setting Parameter Alarm Properties

To set parameter alarm properties, follow this procedure:

1. Select the **Main Menu** quick key → from the **Alarm** column select **Limits**. **Enter the password if required.**
2. Select a parameter tab and set alarm properties as desired.

You can also change the alarm properties of individual parameter from corresponding parameter menu.

7.6.2 Setting Alarm Tone Properties

7.6.2.1 Changing the Alarm Volume

To change the alarm volume, follow this procedure:

1. Select the **Main Menu** quick key → from the **Alarm** column select **Setup**.
2. Set **Alarm Volume**. The optional alarm volume is between X to 10, in which X is the minimum volume, depending on the setting of minimum alarm volume, and 10 is the maximum volume.
3. Select **High Alarm Volume** to set the volume of the high priority alarm.
4. Select **Reminder Volume** to set the volume of the reminder tone.

NOTE

- **When the alarm volume is set to 0, the alarm sound is turned off and the audio off symbol appears on the screen.**
 - **You cannot set the volume of high priority alarms if Alarm Volume is set to 0.**
-

7.6.2.2 Setting the Minimum Alarm Volume

To set the minimum alarm volume, follow this procedure:

1. Select the **Main Menu** quick key → from the **System** column select **Maintenance** → input the required password → select .
2. Select the **Alarm** tab → **Audio** tab.
3. Set **Minimum Alarm Volume**.

NOTE

- **When your monitor is connected to the CMS and Minimum Alarm Volume is set to 0, Minimum Alarm Volume automatically changes to 2 if the CMS is disconnected.**
-

7.6.2.3 Setting the Audible Alarm Tone Pattern

You can distinguish the heart beat tone, pulse tone, and keystroke tone by frequency. You can choose any of the three tone patterns: ISO, Mode 1, and Mode 2. For more information, see **7.3.3 Alarm Indicators**.

To set the alarm tone pattern, follow this procedure:

1. Select the **Main Menu** quick key → from the **System** column select **Maintenance** → input the required password → select .
2. Select the **Alarm** tab → **Audio** tab.
3. Set **Alarm Sound** to **ISO, Mode 1** or **Mode 2**.

7.6.2.4 Setting the Interval between Alarm Sounds

If you choose the ISO pattern, you can change the interval between alarm tones. To change the interval between alarm tones, follow this procedure:

1. Select the **Main Menu** quick key → from the **System** column select **Maintenance** → input the required password → select .
2. Select the **Alarm** tab → **Audio** tab.
3. Set **High Alarm Interval**, **Med Alarm Interval**, and **Low Alarm Interval**.

7.6.2.5 Setting the Reminder Tones

When the alarm volume is set to zero, or the alarm is reset or switched off, the monitor issues a periodical reminder tone. The reminder tone is enabled by default.

To set the reminder tone, follow this procedure:

1. Select the **Main Menu** quick key → from the **System** column select **Maintenance** → input the required password → select .
2. Select the **Alarm** tab → **Pause/Reset** tab.
3. Set **Alarm Reset Reminder**.
 - ◆ **On**: the monitor issues reminder tones at a designated interval.
 - ◆ **Re-alarm**: if the alarm condition persists the acknowledged alarms marked with “√” will be re-generated after the designated reminder tone interval .
 - ◆ **Off**: the monitor does not issue reminder tones at a designated interval. The acknowledged alarms marked with “√” will be silenced.
4. Set **Alarm Off Reminder**.
5. Set **Reminder Interval** to **10 min, 5 min, 3 min, 2 min, or 1 min**.

7.6.2.6 Setting Alarm Volume Escalation

The monitor provides the function of automatically escalating the alarm tone volume. When this function is enabled, if an alarm is not reset within the designated delay time after the alarm occurs, the volume of the alarm tone increases automatically.

To set the alarm volume escalation, follow this procedure:

1. Select the **Main Menu** quick key → from the **System** column select **Maintenance** → input the required password → select .
2. Select the **Alarm** tab → **Audio** tab.
3. Set **Auto Increase Volume**.
 - ◆ **2 Steps**: if an alarm is not reset within the designated delay time after the alarm occurs, the alarm volume automatically increases by two levels.
 - ◆ **1 Step**: if an alarm is not reset within the designated delay time after the alarm occurs, the alarm volume automatically increases by one level.
 - ◆ **Off**: if an alarm is not reset within the designated delay time after the alarm occurs, the volume of the alarm tone does not change.
4. Select **Increase Volume Delay** to set the delay time of alarm volume escalation.

NOTE

-
- **The alarm volume escalation function is not applied to the latched alarms.**
-

7.6.3 Initiating Auto Alarm Limits

The monitor provides the auto alarm limits function to automatically adjust alarm limits according to the patient's vital signs using. When auto limits are selected, the monitor calculates safe auto limits based on the latest measured values. To get accurate auto alarm limits, you need to collect a set of measured vital signs as a baseline.

To initiate auto alarm limits, follow this procedure:

1. Select the **Main Menu** quick key → from the **Alarm** column select **Limits**.
2. From the **Limits** page, select **Auto Limits** at the left bottom.
3. Select **OK** from the popup dialog box.

Then the monitor will automatically calculate alarm limits basing on the latest measured values. Before applying these automatically created alarm limits, confirm if they are appropriate for your patient from the **Limits** menu. If not, you can adjust them manually. These alarm limits will remain unchanged until you select auto limits again or adjust them manually.

The monitor calculates auto limits basing on the following rules:

Module	Parameter	Lower Limit		Upper Limit		Auto Limit Range
		Adult/ pediatric	Neonate	Adult/ pediatric	Neonate	
ECG	HR/PR (bpm)	HR × 0.8 or 40 (whichever is greater)	(HR - 30) or 90 (whichever is greater)	HR × 1.25 or 240 (whichever is smaller)	(HR + 40) or 200 (whichever is smaller)	Adult/pediatric: 35 to 240 Neonate: 55 to 225
Resp	RR (rpm)	RR × 0.5 or 6 (whichever is greater)	(RR - 10) or 30 (whichever is greater)	(RR × 1.5) or 30 (whichever is smaller)	(RR + 25) or 85 (whichever is smaller)	Adult/pediatric: 6 to 55 Neonate: 10 to 90
SpO ₂	SpO ₂ (%)	Same as the default alarm limit	Same as the default alarm limit	Same as the default alarm limit	Same as the default alarm limit	Same as the measurement range
NIBP	NIBP-S (mmHg)	(SYS × 0.68 + 10)	(SYS - 15) or 45 (whichever is greater)	(SYS × 0.86 + 38)	(SYS + 15) or 105 (whichever is smaller)	Adult: 45 to 270 Pediatric: 45 to 185 Neonate: 40 to 115
	NIBP-D (mmHg)	(Dia × 0.68 + 6)	(Dia - 15) or 20 (whichever is greater)	(Dia × 0.86 + 32)	(Dia + 15) or 80 (whichever is smaller)	Adult: 25 to 210 Pediatric: 25 to 150 Neonate: 20 to 90
	NIBP-M (mmHg)	(Mean × 0.68 + 8)	(Mean - 15) or 35 (whichever is greater)	(Mean × 0.86 + 35)	(Mean + 15 or 95) (whichever is smaller)	Adult: 30 to 230 Pediatric: 30 to 165 Neonate: 25 to 105
Temp	T1 (°C)	(T1 - 0.5)	(T1 - 0.5)	(T1 + 0.5)	(T1 + 0.5)	1 to 49
	T2 (°C)	T2 - 0.5)	T2 - 0.5)	(T2 + 0.5)	(T2 + 0.5)	1 to 49
	ΔT (°C)	Same as the default alarm limit	Same as the default alarm limit	Same as the default alarm limit	Same as the default alarm limit	Same as the measurement range
IBP: ART/ Ao/UAP/ BAP/FAP/ LV/P1-P4 (Arterial pressure)	IBP-S (mmHg)	SYS × 0.68 + 10	(SYS - 15) or 45 (whichever is greater)	SYS × 0.86 + 38	(SYS + 15) or 105 (whichever is smaller)	Adult: 45 to 270 Pediatric: 45 to 185 Neonate: 35 to 115
	IBP-D (mmHg)	(Dia × 0.68 + 6)	(Dia - 15) or 20 (whichever is greater)	(Dia × 0.86 + 32)	(Dia + 15) or 80 (whichever is smaller)	Adult: 25 to 225 Pediatric: 25 to 150 Neonate: 20 to 90
	IBP-M (mmHg)	Mean × 0.68 + 8	(Mean - 15) or 35 (whichever is greater)	Mean × 0.86 + 35	(Mean + 15) or 95 (whichever is smaller)	Adult: 30 to 245 Pediatric: 30 to 180 Neonate: 25 to 105
IBP: PA	IBP-S (mmHg)	SYS × 0.75	SYS × 0.75	SYS × 1.25	SYS × 1.25	3 to 120
	IBP-D (mmHg)	Dia × 0.75	Dia × 0.75	Dia × 1.25	Dia × 1.25	3 to 120
	IBP-M (mmHg)	Mean × 0.75	Mean × 0.75	Mean × 1.25	Mean × 1.25	3 to 120
IBP: CPP	CPP (mmHg)	CPP × 0.68 + 8	(CPP - 15) or 35, (whichever is greater)	CPP × 0.86 + 35	(CPP + 15) or 95, (whichever is smaller)	Adult: 20 to 235 Pediatric: 25 to 175 Neonate: 25 to 100

Module	Parameter	Lower Limit		Upper Limit		Auto Limit Range
		Adult/ pediatric	Neonate	Adult/ pediatric	Neonate	
IBP: CVP/ LAP/ RAP/ UVP/P1- P4 (Venous pressure)	IBP-M	Mean × 0.75	Mean × 0.75	Mean × 1.25	Mean × 1.25	3 to 40
CO ₂	EtCO ₂ (mmHg)	0 to 32: remains the same	0 to 32: remains the same	0 to 32: remains the same	0 to 32: remains the same	Same as the measurement range
		33 to 35: 29	33 to 35: 29	33 to 35: 41	33 to 35: 41	Same as the measurement range
		36 to 45: (etCO ₂ - 6)	36 to 45: (etCO ₂ - 6)	36 to 45: (etCO ₂ + 6)	36 to 45: (etCO ₂ + 6)	Same as the measurement range
		46 to 48: 39	46 to 48: 39	46 to 48: 51	46 to 48: 51	Same as the measurement range
		>48: remains the same	>48: remains the same	>48: remains the same	>48: remains the same	Same as the measurement range
	FiCO ₂	None	None	Same as the default alarm limit	Same as the default alarm limit	Same as the measurement range
	awRR (rpm)	awRR × 0.5 or 6 (whichever is greater)	(awRR - 10) or 30 (whichever is greater)	awRR × 1.5 or 30 (whichever is smaller)	(awRR+25) or 85 rpm (whichever is smaller)	Adult/pediatric: 6 to 55 Neonate: 10 to 90

7.6.4 Setting the Alarm Delay Time

For continuously measured parameters, you can set the alarm delay time. If the alarm condition is resolved within the delay time, the monitor does not present the alarm.

To set the alarm delay time, follow this procedure:

1. Select the **Main Menu** quick key → from the **System** column select **Maintenance** → input the required password → select .
2. Select the **Alarm** tab → **Other** tab.
3. Set **Alarm Delay**.

The setting of **Alarm Delay** is not applied to the zero RR alarms and the ST alarms. You can set **Zero RR Delay** and **ST Alarm Delay** separately.

7.6.4.1 Setting the Zero RR Delay Time

To set the Zero RR delay time, follow this procedure:

1. Select the **Main Menu** quick key → from the **Alarm** column select **Setup**.
2. Select **Zero RR Delay** to set the zero RR delay time.

7.6.4.2 Setting the ST Alarm Delay Time

1. Select the **Main Menu** quick key → from the **System** column select **Maintenance** → input the required password → select .
2. Select the **Alarm** tab → **Other** tab.
3. Set **ST Alarm Delay**.

7.6.5 Adjusting the Alarm Light Brightness

To adjust the alarm light brightness, follow this procedure:

1. Select the **Main Menu** quick key → from the **System** column select **Maintenance** → input the required password → select .
2. Select the **Alarm** tab → **Other** tab.
3. From the **Alarm Light Brightness** block, set **Primary Display**. If you set alarm light brightness to **Auto**, the monitor automatically adjusts the alarm light brightness according to the ambient light. The stronger the ambient light is, the brighter the alarm light is.

For N22/N19, if you are using a secondary display, set the **Secondary Display** too. Restoring the Default Alarm Settings

To reset all alarm settings to the defaults, follow this procedure:

1. Select the **Main Menu** quick key → from the **Alarm** column select **Setup**.
2. Select the **Limits** tab.
3. On the **Limits** page, select **Defaults** at the left bottom.

7.6.6 Setting the Length of Printing Duration On Alarm

You can define the length of printed waveforms when an alarm is triggered. To do so, follow this procedure:

1. Access the **Setup** page in either of the following ways:
 - ◆ Select the **Alarm Setup** quick key → select the **Setup** tab.
 - ◆ Select the **Main Menu** quick key → from the **Alarm** column select **Setup**.
2. Select the **Setup** tab.
3. Set **Printing Duration On Alarm**.

7.6.7 Setting the Switch of the CMS and eGateway Disconnection Alarm

You can choose whether to issue an alarm when the monitor is not connected or disconnected from the CMS/eGateway. To do so, follow this procedure:

1. Select the **Main Menu** quick key → from the **System** column select **Maintenance** → input the required password → select .
2. Select the **Alarm** tab → **Other** tab.
3. Switch on or off **CMS/eGW Disconnected Alarm**. If **CMS/eGW Disconnected Alarm** is switched off, the "Offline" alarm is not presented when the monitor is not connected or disconnected from the CMS/eGateway.

7.6.8 Setting the Priority of the CMS and eGateway Disconnection Alarm

To set the priority of the CMS and eGateway disconnection alarm, follow this procedure:

1. Select the **Main Menu** quick key → from the **System** column select **Maintenance** → input the required password → select .
2. Select the **Alarm** tab → **Other** tab.
3. Set **CMS/eGW Disconnected**.

7.6.9 Setting the Switch of the SpO₂ Desat Alarm Off

You can choose whether switching off the SpO₂ Desat alarm is permissible or not. To do so, follow this procedure:

1. Select the **Main Menu** quick key → from the **System** column select **Maintenance** → input the required password → select .

2. Select the **Alarm** tab → select the **Other** tab.
3. Set **SpO2 Desat Alarm Off**.
 - ◆ **Disable:** the SpO₂ Desat alarm is always on. You cannot switch it off.
 - ◆ **Enable:** you can switch off the SpO₂ Desat alarm. For more information, see *11.6.1 Changing the SpO₂ Alarm Settings*.

WARNING

- **If you switch off the SpO2 Desat alarm, the monitor will not alarm when the patient's SpO₂ is extremely low. This may result in a hazard to the patient. Always keep the patient under close surveillance.**
 - **If you switch off all arrhythmia alarms, the monitor will not alarm for any arrhythmia event. Always keep the patient under close surveillance.**
-

7.6.10 Setting the Switch of the Zero RR Alarm Off

You can choose whether switching off the zero RR alarm is permissible or not. To do so, follow this procedure:

1. Select the **Main Menu** quick key → from the **System** column select **Maintenance** → input the required password → select .
2. Select the **Alarm** tab → select the **Other** tab.
3. Set **Zero RR Alarm Off**.
 - ◆ **Disable:** the zero RR alarm is always on. You cannot switch it off.
 - ◆ **Enable:** you can switch off the zero RR alarm. For more information, see *10.5.1 Setting the Resp Alarm Properties*.

WARNING

- **If you switch off the zero RR alarm, the monitor will not issue the zero RR alarm in case that zero RR happens. This may result in a hazard to the patient. Keep the patient under close surveillance.**
-

7.7 Pausing Alarms/Pausing Alarm Tones

7.7.1 Defining the Pause Function

You can either pause alarms or pause alarm tones. This depends on the pause setting. To set the pause function, follow this procedure:

1. Select the **Main Menu** quick key → from the **System** column select **Maintenance** → input the required password → select .
2. Select the **Alarm** tab → **Pause/Reset** tab.
3. Set **Pause** to **Alarm Pause** or **Audio Pause**. The default setting is **Alarm Pause**.

7.7.2 Pausing Alarms

If the pause function is designated as pausing alarms, pressing the **Alarm Pause** quick key can temporarily disable alarm indicators. When alarms are paused, the following rules are followed:

- No physiological alarm will be presented.
- For technical alarms, alarm sounds are paused, but alarm lamps and alarm messages remain presented.
- The remaining alarm pause time is displayed in the physiological alarm information area.
- The alarm pause symbol is displayed in the system information area.

When the alarm pause time expires, the alarm paused status is automatically deactivated. You can also cancel the alarm paused status by pressing the **Alarm Pause** quick key.

7.7.2.1 Setting the Alarm Pause Time

The alarm pause time can be set to **1 min**, **2 min**, **3 min**, or **Permanent**. The default alarm pause time is **2 min**.

To set the alarm pause time, follow this procedure:

1. Select the **Main Menu** quick key → from the **System** column select **Maintenance** → input the required password → select .
2. Select the **Alarm** tab → **Pause/Reset** tab.
3. Set **Pause Time**.

7.7.2.2 Prolonging the Alarm Pause Time

You can temporarily prolong the alarm pause time after the monitor enters the alarm paused status. This function is enabled by default. To do so, follow this procedure:

1. In the physiological alarm information area, select the alarm pause countdown.
2. Select **Pause 5 min**, **Pause 10 min**, or **Pause 15 min**.

To disable the function of prolonging the alarm pause time, follow this procedure:

1. Select the **Main Menu** quick key → from the **System** column select **Maintenance** → input the required password → select .
2. Select the **Alarm** tab → **Pause/Reset** tab.
3. Switch off **Pause 5 min**, **Pause 10 min**, or **Pause 15 min**.

NOTE

-
- **Prolonging alarm pause time does not affect the setting of alarm pause time.**
 - **You can not prolong the pause time if the Pause Time is set to Permanent.**
-

7.7.2.3 Selecting the Priority of Paused Alarms

To select alarms of what priority can be paused, follow this procedure:

1. Select the **Main Menu** quick key → from the **System** column select **Maintenance** → input the required password → select .
2. Select the **Alarm** tab → **Pause/Reset** tab.
3. Set **Pause Priority**.
 - ◆ **All**: pressing the **Alarm Pause** quick key pauses all alarms.
 - ◆ **Med & Low**: pressing the **Alarm Pause** quick key pauses alarms of medium and low priority. The high priority alarms will not be paused.
 - ◆ **Disabled**: the **Alarm Pause** quick key is disabled.

7.7.2.4 Switching Off All Alarms

If **Pause Time** is set to **Permanent** (see 7.7.2.1 *Setting the Alarm Pause Time*), pressing the **Alarm Pause** quick key permanently switches off all alarms. The alarm off status has the following features:

- Physiological alarms are switched off. The alarm lamp does not flash and alarm sound is not issued.
- Alarm sound of technical alarms is switched off, but alarm lamp flashes and alarm messages are presented.
- The message **Alarm Off** with red background is displayed in the physiological alarm information area.
- The alarm off symbol is displayed in the system status information area.

To exit the alarm off status, press the **Alarm Pause** quick key again.

WARNING

- **Pausing or switching off alarms may result in a hazard to the patient.**
-
-

7.7.3 Pausing Alarm Sound

If the pause function is defined as **Audio Pause**, pressing the **Audio Pause** key pauses alarm tone. When alarm tones are paused, the following rules are followed:

- The sound of all physiological alarms and technical alarms are switched off.
- The remaining audio pause time is displayed in the physiological alarm information area.
- The audio pause symbol is displayed in the system information area.

When the audio pause time expires, the audio paused status is automatically deactivated. You can also cancel the audio paused status by pressing the **Audio Pause** quick key.

7.7.3.1 Setting the Alarm Tone Pause Time

The alarm tone pause time can be set to **1 min**, **2 min**, **3 min**, or **Permanent**. The default audio pause time is two minutes.

To set the alarm tone pause time, see *7.7.2.1 Setting the Alarm Pause Time*.

7.7.3.2 Prolonging the Alarm Tone Pause Time

You can temporarily prolong the alarm tone pause time after the monitor enters the alarm tone paused status. For more information, see *7.7.2.2 Prolonging the Alarm Pause Time*.

NOTE

- **Prolonging alarm pause time does not affect the setting of alarm tone pause time.**
-

7.7.3.3 Setting the Priority of Audio Paused Alarms

To select alarm sound of what priority can be paused, see *7.7.2.3 Selecting the Priority of Paused Alarms*.

7.7.3.4 Switching Off Alarm Sound

If **Pause Time** is set to **Permanent** (see *7.7.2.1 Setting the Alarm Pause Time*), pressing the **Audio Pause** quick key permanently switches off all alarm sound. The audio off status has the following features:

- Alarm sound of both physiological alarms and technical alarms is switched off.
- The audio off symbol is displayed in the system information area.

To exit the audio off status, press the **Audio Pause** quick key again.

WARNING

- **Pausing or switching off alarm sound may result in a hazard to the patient.**
-
-

7.8 Resetting Alarms

Pressing the **Alarm Reset** quick key to acknowledge the ongoing alarms and reset the alarm system. When the alarm system is reset, the alarm reset symbol displays in the system status information area for alarm symbols.

NOTE

- **If a new alarm is triggered after the alarm system is reset, the alarm reset icon will disappear and the alarm light and alarm tone will be reactivated.**
-

7.8.1 Resetting Physiological Alarms

Physiological alarms give different alarm indicators when the alarm system is reset:

- The alarm sound is silenced.
- A √ appears before the alarm message, indicating that the alarm is acknowledged.
- The color of the parameter numeric background corresponds with the alarm priority, but the parameter numeric does not flash.

7.8.2 Resetting Technical Alarms

Technical alarms give different alarm indicators when the alarm system is reset:

- Some technical alarms are cleared. The monitor gives no alarm indications.
- Some technical alarms are changed to the prompt messages.
- For some technical alarms, the alarm is silenced and a √ appears before the alarm message, indicating that the alarm is acknowledged.

For details about the indications of technical alarms when the alarm system is reset, see *D Alarm Messages*.

7.8.3 Setting Alarm Light Status on Alarm Reset

When the alarm system is reset, the monitor presents the alarm light by default, but you can switch off the alarm light. To change the alarm light setting, follow this procedure:

1. Select the **Main Menu** quick key → from the **System** column select **Maintenance** → input the required password → select .
2. Select the **Alarm** tab → **Pause/Reset** tab.
3. Set **Alarm Light**.
 - ◆ **On When Reset:** when the alarm system is reset, the alarm tones of the current alarms are switched off, but the alarm lamp remains flashing.
 - ◆ **Off When Reset:** when the alarm system is reset, both the alarm tone and alarm lamp of the current alarms are switched off.

7.9 Latching Alarms

The latching setting for physiological alarms defines how alarm indicators behave if you do not reset the alarms.

- If you do not “latch” physiological alarms, their alarm indications disappear when the alarm condition ends.
- If you “latch” physiological alarms, all visual and audible alarm indications remains until you reset the alarms. For latched alarms the time when the alarm is last triggered is displayed behind the alarm message.

You can separately latch visual indications or simultaneously latch the visual and the audible indications.

- When visual indications are latched, visual indications, including alarm lamp, alarm message and its background remains when the alarm condition ends and the time when the alarm last triggered is displayed behind the alarm message.
- When audible indications are latched, the monitor continues to issues alarm sounds when the alarm condition ends.

To latch physiological alarms, follow this procedure:

1. Select the **Main Menu** quick key → from the **System** column select **Maintenance** → input the required password → select .
2. Select the **Alarm** tab → **Latching** tab.
3. Select how you want to latch the alarms.

Alarm latching rules are as follows:

- You can separately latch visual alarm signal.
- Latching audible alarm signal simultaneously latches visual signal.
- Selecting alarms of lower priority simultaneously latches higher priority alarms.

NOTE

- **Changing alarm priority may affect the latching status of corresponding alarm. Determine if you need to adjust the latching status for the specific alarm when you have changed its alarm priority.**
 - **When the alarm system is reset, latched physiological alarms are cleared.**
-

7.10 CPB Mode

The CPB (Cardiopulmonary Bypass) mode is activated only if you set the department to **OR**.

In the CPB mode, all the physiological alarms and technical alarms are switched off. So when performing CPB, you can put the monitor in the CPB mode in order to inactivate unnecessary alarms.

7.10.1 Entering the CPB Mode

To enter the CPB mode, select the **Main Menu** quick key → from the **Alarm** column, select **CPB Mode**.

In the CPB mode, **CPB Mode** is displayed in the physiological alarm area with a red background color.

NOTE

- **When the CPB mode is entered, the monitor stops all NIBP measurements. You can restart NIBP measurements after entering the CPB mode.**
-

7.10.2 Exiting the CPB Mode

To exit the CPB mode, select the **Main Menu** quick key → from the **Alarm** column select **Exit CPB Mode**.

7.11 Intubation Mode

Intubation mode is available for Resp and CO₂ monitoring. When performing intubation during general anesthesia, you can put the monitor in the intubation mode in order to inactivate unnecessary alarms.

In the intubation mode, Resp and CO₂ related physiological alarms are switched off.

7.11.1 Entering the Intubation Mode

To enter the intubation mode, choose either of the following ways:

- From the bottom of the **Resp** or **CO2** menu, select **Intubation Mode**.
- Select the **Main Menu** quick key → from the **Alarm** column select **Intubation Mode**.

7.11.2 Setting the Intubation Time

The default intubation time is 2 minutes. To change the intubation time, following this procedure:

1. Select the **Main Menu** quick key → from the **System** column select **Maintenance** → input the required password → select .
2. Select the **Alarm** tab → **Other** tab.
3. Set the **Intubation Mode Period**.

7.11.3 Exiting the Intubation Mode

To exit the intubation mode, choose either of the following ways:

- From the bottom of the **Resp** or **CO2** menu, select **Exit Intubation Mode**.
- Select the **Main Menu** quick key → from the **Alarm** column select **Exit Intubation Mode**.

7.12 Managing Alarms from Remote Devices (only available for the independent external display)

You can view and manage the alarms coming from remote devices, for example bedside monitors and telemetry monitors on your monitor.

7.12.1 Setting the Tone Pattern for Alarms from Remote Devices

The monitor provides the same alarm tone pattern for the remote device alarms as those for your monitor alarms. For more information on alarm tone pattern, see 7.3.3 *Alarm Indicators*.

To set the alarm tone pattern for the remote device alarms, follow this procedure:

1. Select the **Main Menu** quick key → from the **System** column select **Maintenance** → input the required password → select .
2. Select the **Alarm** tab → select the **Remote View** tab.
3. Set **Alarm Sound** to **ISO, Mode 1** or **Mode 2**.

If your monitor and remote devices have alarms at the same time, the monitor presents alarms according to the following rules:

- If the alarm tone pattern for your monitor is same as that for the remote devices, the monitor prioritizes all the alarms and sounds the highest alarm tone.
- If the alarm tone pattern for your monitor is differently from that for the remote devices, the monitor sounds the alarms in their corresponding tone.

The monitor provides the same alarm tone pattern for the remote device alarms as those for your monitor alarms by default. You can change the alarm tone pattern of the remote monitor; see 37.3.4.5 *Setting the Tone Pattern for Alarms from Remote Devices*

7.12.2 Selecting the Alarm Reminder for Remote Devices

You can configure what alarm indicators are necessary for the remote devices. To do so, follow this procedure:

1. Select the **Main Menu** quick key → from the **System** column select **Maintenance** → input the required password → select .
2. Select the **Alarm** tab → **Remote View** tab.
3. Select **Alarm Reminder**:
 - ◆ **Visible + Audible**: the monitor provides visual alarm indication, and continuous audible alarm indication if the alarm persists at the remote device.
 - ◆ **Visible + Single Tone**: the monitor provides visual alarm indication, and a single tone when the alarm occurs at the remote device.
 - ◆ **Visible Only**: the monitor only provides visual alarm indication.

7.12.3 Presenting Alarm Sound for Remote Devices as per Alarm Priority

You can configure what priority of remote device alarms are presented for audible notification. To do so, follow this procedure:

1. Select the **Main Menu** quick key → from the **System** column select **Maintenance** → input the required password → select .
2. Select the **Alarm** tab → **Remote View** tab.
3. Select **Alarm Priority**:
 - ◆ **All**: the monitor sounds if an alarm occurs.
 - ◆ **High&Med**: the monitor sounds if a high or medium priority alarm occurs.
 - ◆ **High Only**: the monitor sounds only if a high priority alarm occurs.

7.12.4 Resetting Alarms for Remote Devices

You can reset the alarms occurring to the remote devices at your monitor. To enable this function, follow this procedure:

1. Select the **Main Menu** quick key → from the **System** column select **Maintenance** → input the required password → select .
2. Select the **Alarm** tab → **Remote View** tab.
3. Switch on **Reset Remote Bed's Alarms**. Then the **Alarm Reset** button appears on the bottom left of the **Remote View** window.

To reset remote device alarms, select **Alarm Reset**.

NOTE

- You can reset remote device alarms only if the **Alarm Reset by Other Bed** switch is on at the remote devices.
-

7.12.5 Authorizing the Alarm Reset to Other Devices

Alarms on your monitor can be reset by remote devices if you enable this function. To do so, follow this procedure:

1. Select the **Main Menu** quick key → from the **System** column select **Maintenance** → input the required password → select .
2. Select the **Alarm** tab → **Remote View** tab.
3. Switch on **Alarm Reset by Other Bed**.

7.12.6 Switching Off the Remote Device Disconnection Alarm

The monitor can provide an alarm if remote devices are disconnected. By default, the function is enabled. To disable the alarm, follow this procedure:

1. Select the **Main Menu** quick key → from the **System** column select **Maintenance** → input the required password → select .
2. Select the **Alarm** tab → **Remote View** tab.
3. Switch off **Remote Disconnected Alarm**.

7.13 Testing Alarms

The monitor automatically performs a selftest at startup. Check that an alarm tone is heard, and the alarm lamp illuminates, one after the other, in red, yellow, and cyan. This indicates that the visible and audible alarm indicators functions correctly.

To further test individual measurement alarms, perform measurements on yourself or using a simulator. Adjust alarm limits and check that appropriate alarm behavior is observed.

7.14 Actions When an Alarm Occurs

When an alarm occurs, observe the following steps and take proper actions:

1. Check the patient's condition.
2. Confirm the alarming parameter or alarm category.
3. Identify the source of the alarm.
4. Take proper action to eliminate the alarm condition.
5. Make sure the alarm condition is corrected.

For more information, see *D Alarm Messages*.

8

Monitoring ECG, Arrhythmia, ST and QT

8.1 ECG Introduction

The electrocardiogram (ECG) measures the electrical activity of the heart and displays it on the monitor as waveforms and numerics. ECG monitoring provides 3-, 5-, 6-, and 12-lead ECG monitoring, ST-segment analysis, arrhythmia analysis, and QT/QTc measurements.

ECG monitoring is intended for adult, pediatric, and neonatal patients.

8.2 ECG Safety Information

WARNING

- **This equipment is not intended for direct cardiac application.**
 - **Make sure the conductive parts of electrodes and associated connectors, including the neutral electrode, do not contact any other conductive parts including earth.**
 - **Use defibrillation-proof ECG cables during defibrillation.**
 - **Do not touch the patient or metal devices connected to the patient during defibrillation.**
 - **To reduce the hazard of burns during high-frequency surgical procedure, ensure that the monitor's cables and transducers never come into contact with the electrosurgery unit (ESU).**
 - **To reduce the hazard of burns during use of high-frequency surgical unit (ESU), the ECG electrodes should not be located between the surgical site and the ESU return electrode.**
-



CAUTION

- **Only use parts and accessories specified in this manual. Follow the instructions for use and adhere to all warnings and cautions.**
 - **Periodically inspect the electrode application site to ensure skin integrity. If the skin quality changes, replace the electrodes or change the application site.**
 - **Interference from ungrounded instrument near the patient and electrosurgery interference can induce noise and artifact into the waveforms.**
-

8.3 ECG Display

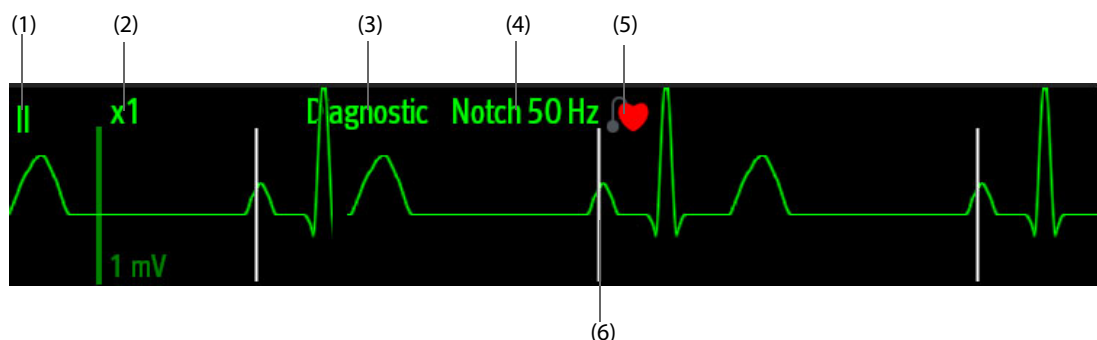
The following figures show the ECG waveform and numeric areas. Your display may be configured to look slightly different.



- (1) ECG lead label of the displayed waveform
- (2) ECG waveform gain
- (3) ECG filter mode
- (4) Notch filter status
- (5) Paced status: If **Paced** is set to **Yes**,  is displayed. If **Paced** is set to **No**,  is displayed.
- (6) Pace pulse mark: If **Paced** is set to **Yes**, the pace pulse markers "||" are displayed corresponding to detected pace pulse on each ECG waveform.

NOTE

- The ECG numeric area and waveform area are configured to be different for different lead type and ECG settings.

8.4 Preparing for ECG Monitoring

8.4.1 Preparing the Patient Skin

Proper skin preparation is necessary to ensure good signal quality at the electrode sites, as the skin is a poor conductor of electricity. To properly prepare the skin, choose flat areas and then follow this procedure:

1. Shave hair from skin at chosen electrode sites.
2. Gently rub skin surface at sites to remove dead skin cells.
3. Thoroughly cleanse the site with a mild soap and water solution.
4. Dry the skin completely before applying electrodes.

8.4.2 Applying Electrodes

To connect ECG cables, follow this procedure:

1. Check that electrode packages are intact and the electrodes are not past the expiry date. Make sure the electrode gel is moist. If you are using snap electrodes, attach the snaps to the electrodes before placing electrodes on the patient.
2. Place the electrodes on the prepared sites. Make sure that all electrodes have good skin contact.
3. Connect the leadwires to the patient cable if not already connected.
4. Plug the patient cable into the ECG connector.

NOTE

- Store the electrodes at room temperature.
- Only open the electrode package immediately prior to use.
- Never mix patient electrode types or brands. This may lead to problem due to impedance mismatch.

- **When applying the electrodes, avoid bony area, obvious layers of fat, and major muscles. Muscle movement can result in electrical interference. Applying electrodes on major muscles, for example on muscles of the thorax, may lead to erroneous arrhythmia alarms due to excessive muscle movement.**

8.4.3 Lead Wire Color Code

The following table lists the color coding of leadwires for both AHA and IEC standards:

Lead	IEC		AHA	
	Label	Color	Label	Color
Right arm	R	Red	RA	White
Left arm	L	Yellow	LA	Black
Right leg (neutral)	N	Black	RL	Green
Left leg	F	Green	LL	Red
Chest 1	C1	White/Red	V1	Brown/Red
Chest 2	C2	White/Yellow	V2	Brown/Yellow
Chest 3	C3	White/Green	V3	Brown/Green
Chest 4	C4	White/Brown	V4	Brown/Blue
Chest 5	C5	White/Black	V5	Brown/Orange
Chest 6	C6	White/Violet	V6	Brown/Violet

8.4.4 ECG Electrode Placements

In this section, electrode placement is illustrated using the AHA naming convention.

8.4.4.1 3-leadwire Electrode Placement

The following is an electrode configuration when a 3-leadwire cable is used:

- RA placement: directly below the clavicle and near the right shoulder.
- LA placement: directly below the clavicle and near the left shoulder.
- LL placement: on the left lower abdomen.

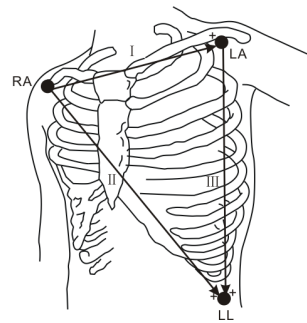

8.4.4.2 5-leadwire and 6-leadwire Electrode Placement

The following is an electrode configuration when when 5-leadwires is used:

- RA placement: directly below the clavicle and near the right shoulder.
- LA placement: directly below the clavicle and near the left shoulder.
- RL placement: on the right lower abdomen.
- LL placement: on the left lower abdomen.
- V placement: on the chest.

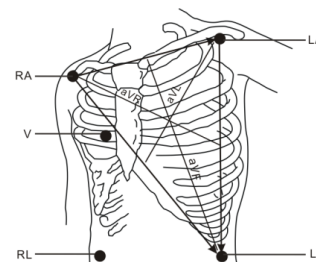

For 6-leadwire placement, you can use the position for the 5 -leadwire placement but with two chest leads. The two chest leads (Va and Vb) can be positioned at any two of the V1 to V6 positions. For more information, see 8.4.4.3 *Chest Electrode Placement*. The Va and Vb lead positions are configurable. For more information, see 8.5.3.3 *Changing Va and Vb Labels*.

8.4.4.3 Chest Electrode Placement

The chest electrode can be placed at the following positions:

- V1 placement: on the fourth intercostal space at the right sternal border.
- V2 placement: on the fourth intercostal space at the left sternal border.
- V3 placement: midway between the V2 and V4 electrode positions.
- V4 placement: on the fifth intercostal space at the left midclavicular line.
- V5 placement: on the left anterior axillary line, horizontal with the V4 electrode position.
- V6 placement: on the left midaxillary line, horizontal with the V4 electrode position.
- V3R-V6R placement: on the right side of the chest in positions corresponding to those on the left.
- VE placement: over the xiphoid process.
- V7 placement: on posterior chest at the left posterior axillary line in the fifth intercostal space.
- V7R placement: on posterior chest at the right posterior axillary line in the fifth intercostal space.

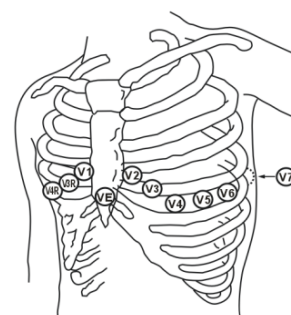

NOTE

- For the 5-leadwire and 6-leadwire placement, place the precordial electrode according to the physician's preference.

8.4.4.4 10-leadwire Electrode Placement

12-lead ECG uses 10 electrodes, which are placed on the patient's four limbs and chest. The limb electrodes should be placed on the limb extremities and the chest electrodes placed according to the physician's preference. The picture at the right shows the conventional 10-leadwire electrode placement.

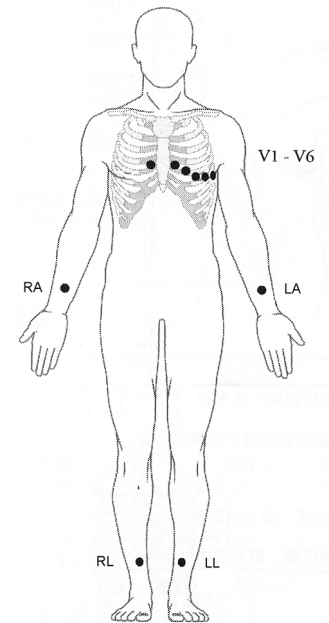

8.4.4.5 Lead Placement for Surgical Patients

The surgical site should be taken into consideration when placing electrodes on a surgical patient. For example, for open-chest surgery, the chest electrodes can be placed on the lateral chest or back. To reduce artifacts and interference from electrosurgical units, you can place the limb electrodes close to the shoulders and lower abdomen and the chest electrodes on the left side of the mid-chest. Do not place the electrodes on the upper arm. Otherwise, the ECG waveform will be very small.

WARNING



- **To reduce the hazard of burns during use of electrosurgical units (ESU), the ECG electrodes should not be located between the surgical site and the ESU return electrode.**
 - **Never entangle the ESU cable and the ECG cable together.**
 - **When using ESU, never place ECG electrodes near the grounding plate of the ESU, as this can cause a lot of interference on the ECG signal.**
-
-

8.4.5 Choosing the ECG Lead Type

To choose ECG lead type, follow this procedure:

1. Select the ECG numeric area or waveform area to enter the **ECG** menu.
2. Select the **Setup** tab.
3. Set **Lead Set** according to the lead type you are going to use. The default lead type is **Auto**. In this case, the monitor automatically detects the lead type.

8.4.6 Checking Paced Status

It is important to correctly set the paced status before you start monitoring ECG. The paced symbol  is displayed when **Paced** is set to **Yes**. The pace pulse markers "I" are shown on each ECG waveform when the patient has a paced signal. If **Paced** is set to **No** or if the patient's paced status is not selected, the symbol  will be shown in the ECG waveform area.

To change the paced status, follow this procedure:

1. Select the ECG numeric area or waveform area to enter the **ECG** menu.
2. Select the **Pacer** tab.
3. Set **Paced** to **Yes** or **No**.

You can also change the patient's paced status from the Patient Management menu. For more information, see *4.3.1 Entering the Patient Management Menu*.

If you did not set the paced status, the monitor issues a prompt tone when pace pulse is detected. At the same time, the paced symbol  flashes and the message **Please check if the patient has a pacemaker?** appears in the ECG waveform area. Check and set the patient's paced status.

WARNING

- **For paced patients, you must set Paced to Yes. If it is incorrectly set to No, the monitor could mistake a pace pulse for a QRS complex and fail to alarm when the ECG signal is too weak. On ventricular paced patients, episodes of ventricular tachycardia may not always be detected. Do not rely entirely upon the system's automated arrhythmia detection algorithm.**
 - **False low heart rate or false asystole alarms may result with certain pacemakers because of pacemaker artifacts, such as electrical overshoot of the pacemaker overlapping the true QRS complexes.**
 - **Do not rely entirely on rate meter alarms when monitoring patients with pacemakers. Always keep these patients under close surveillance.**
 - **The auto pacer recognition function is not applicable to pediatric and neonatal patients.**
 - **For non-paced patients, you must set Paced to No.**
-

8.4.7 Enabling Pacer Rejection

The pace pulse rejection function is disabled by default. To enable this function, follow this procedure:

1. Select the ECG numeric area or waveform area to enter the **ECG** menu.
2. Select the **Pacer** tab.
3. Switch on **Pacer Reject**.

NOTE

- **When pace pulses are detected, the pace pulse marks "P" are shown on the ECG waveforms. Pacer Rejection setting has no impact on the display of pace pulse marks "P".**
 - **You can switch on pacer rejection only when Paced is set to Yes. If Paced is set to no, the setting of Pacer Reject is disabled.**
-

8.5 Changing ECG Settings

8.5.1 Choosing an ECG Screen

When monitoring ECG, you can choose the screen as desired.

- For 3-lead ECG monitoring, only normal screen is available.
- For 5-lead or 6-lead ECG monitoring, besides the normal screen, you can also choose the full screen.
- For 12-lead ECG monitoring, besides the normal screen, you can also choose the full screen, and 12-lead full screen.

Taking the selection of the 12-lead screen for example, to choose the 12-lead screen, follow this procedure:

1. Select the ECG numeric area or waveform area to enter the **ECG** menu.
2. Select the **Setup** tab, and set the **Lead Set** to **12-Lead**.
3. From the bottom of the menu, select **12-lead**.

8.5.2 Setting ECG Alarm Properties

To set ECG alarm properties, follow this procedure:

1. Select the ECG numeric area or waveform area to enter the **ECG** menu.

2. Select the **Alarm** tab.
3. Enter the password if required. For more information, refer to *6.9.3 Selecting Password for User Authentication*.
4. Set alarm properties as desired.

8.5.3 Changing ECG Wave Settings

8.5.3.1 Selecting the Leads of Displayed ECG Waveforms

To select the leads of displayed ECG waveforms, follow this procedure:

1. Select the ECG numeric area or waveform area to enter the **ECG** menu.
2. Select the **Setup** tab.
3. Select **ECG** to set the lead of each ECG waveform.
4. If more than three ECG waveforms are displayed, select the **More Leads** tab, and then select **ECG** to set leads of other ECG waveforms.

The waveform of selected lead should have the following characteristics:

- The QRS complex should be either completely above or below the baseline and it should not be biphasic.
- The QRS complex should be tall and narrow.
- The P waves and T waves should be less than 0.2mV.

CAUTION

- **Ensure that you have selected the optimal leads with the best waveform amplitude and the highest signal-to-noise ratio. Selecting the optimal leads is important for detecting beats, classifying beats, and detecting ventricular fibrillation.**
-

8.5.3.2 Changing ECG Waveform Size

If the ECG waveform is too small or clipped, you can change its size by selecting an appropriate **Gain** setting. To do so, follow this procedure:

1. Select the ECG numeric area or waveform area to enter the **ECG** menu.
2. Select the **Setup** tab.
3. Select **ECG gain** to set the size of each ECG waveform.
4. If more than three ECG waveforms are displayed, select the **More Leads** tab, and then select **ECG Gain** to change the sizes of other ECG waveforms. If you select **Auto**, the monitor automatically adjusts the size of the ECG waveforms.

8.5.3.3 Changing Va and Vb Labels

When monitoring ECG with 6-leadwire. You can change the labels of Va and Vb leads. To do so, follow this procedure:

1. Select the ECG numeric area or waveform area to enter the **ECG** menu.
2. Select the **Setup** tab.
3. Set **Va** and **Vb** according to the Va and Vb electrode sites. Default settings are **Va** and **Vb**.

8.5.3.4 Changing ECG Waveform Speed

To change ECG waveform speed, follow this procedure:

1. Select the ECG numeric area or waveform area to enter the **ECG** menu.
2. Select the **Setup** tab.
3. Set **Speed**.

8.5.3.5 Setting the ECG Filter

To set the ECG waveform filter mode, follow this procedure:

1. Select the ECG numeric area or waveform area to enter the **ECG** menu.
2. Select the **Setup** tab.
3. Set **Filter**.
 - ◆ **Diagnostic**: use when diagnostic quality ECG is required. The unfiltered ECG waveform is displayed so that changes such as R-wave notching or discrete elevation or depression of the ST segment are visible.
 - ◆ **Monitor**: use under normal measurement conditions.
 - ◆ **Surgery**: use when the signal is distorted by high frequency or low frequency interference. High frequency interference usually results in large amplitude spikes making the ECG signal look irregular. Low frequency interference usually leads to wandering or rough baseline. The surgery filter reduces artifacts and interference from electrosurgical units. Under normal measurement conditions, selecting **Surgery** may suppress certain features or details of the QRS complexes.
 - ◆ **ST**: recommended for ST monitoring.

8.5.3.6 Switching On or Off the Notch Filter

The notch filter removes the line frequency interference. To switch on or off the notch filter, follow this procedure:

1. Select the ECG numeric area or waveform area to enter the **ECG** menu.
2. Select the **Setup** tab.
3. Switch on or off **Notch Filter**.

NOTE

- **The notch filter can only be switched on or off when ECG Filter is set to Diagnostic. In other filter modes, the notch filter is always on.**

8.5.3.7 Setting Notch Filter Frequency

Set notch filter frequency according to the power line frequency of your country. To set notch filter frequency, follow this procedure:

1. Select the **Main Menu** quick key → from the **System** column select **Maintenance** → input the required password → select .
2. Select the **Other** tab.
3. Set **Notch Frequency** to **50 Hz** or **60 Hz** according to the power line frequency.

8.5.4 Disabling the Smart Lead Off Function

The monitor provides the smart lead off function . When the lead of the first ECG wave is detached but another lead is available, the monitor automatically switches to the available lead to recalculate heart rate, and to analyze and detect arrhythmias. When you reconnect the detached leads, the monitor automatically switches back to the original lead.

The smart lead off function is enabled by default. To disable this function, follow this procedure:

1. Select the ECG numeric area or waveform area to enter the **ECG** menu.
2. Select the **Setup** tab.
3. Switch off **Smart Lead**.

8.5.5 Setting the Priority of the ECG Lead Off Alarm

To set the priority of the ECG lead off alarm, follow this procedure:

1. Select the **Main Menu** quick key → from the **System** column select **Maintenance** → input the required password → select .
2. Select the **Alarm** tab → select the **Other** tab.
3. Set the priority of **ECG Lead Off**.

8.5.6 Adjusting the QRS Volume

To adjust the QRS volume, follow this procedure:

1. Select the ECG numeric area or waveform area to enter the **ECG** menu.
2. Select the **Setup** tab.
3. Set **QRS Volume**.

When valid SpO₂ measurements are available, the monitor adjusts the pitch of QRS tone based on the SpO₂ value.

8.5.7 Adjusting the Minimum QRS Detection Threshold

To avoid false asystole alarm due to low R wave amplitude, and to avoid tall T waves and P waves being mistaken for QRS complexes, the monitor provides a means to manually adjust the minimum QRS detection threshold.

To adjust the minimum QRS detection threshold, follow this procedure:

1. Select the ECG numeric area or waveform area to enter the **ECG** menu.
2. Select the **Setup** tab and set **Filter** to **Monitor**.
3. Select the **QRS Threshold** tab.
4. Select up or down arrow buttons to adjust the minimum threshold for QRS detection. Selecting **Default** resets the QRS threshold to the default value (0.16 mV).

CAUTION

- **The setting of the QRS detection threshold can affect the sensitivity for arrhythmia, ST, QT/QTc detection, and heart rate calculation.**
- **If QRS amplitude is low, the monitor might not be able to calculate heart rate and false asystole calls may occur.**

NOTE

- **The minimum QRS detection threshold can only be adjusted when the ECG filter is set to Monitor.**
-

8.5.8 Selecting the ECG Standard

Select the ECG standard according to the leadwires you are using. To select the ECG standard, follow this procedure:

1. Select the **Main Menu** quick key → from the **System** column select **Maintenance** → input the required password → select .
2. Select the **Module** tab → **ECG** tab.
3. Set **ECG Standard** to **AHA** or **IEC**.

8.6 Monitoring Arrhythmia

Arrhythmia monitoring is intended for adult, pediatric, and neonatal patients.

8.6.1 Arrhythmia Safety Information

WARNING

- Heart rate reading may be affected by cardiac arrhythmias. Do not rely entirely on heart rate alarms when monitoring patients with arrhythmia. Always keep these patients under close surveillance.
 - The arrhythmia analysis program is intended to detect ventricular arrhythmias and atrial fibrillation. It is not designed to detect all the atrial or supraventricular arrhythmias. It may incorrectly identify the presence or absence of an arrhythmia. Therefore, a physician must analyze the arrhythmia information with other clinical findings.
 - Atrial fibrillation (Afib) detection function is not intended for pediatric and neonatal patients.
 - Pacer not Capture and Pacer not Pacing detection function are not intended for pediatric patients.
-

CAUTION

- Since the arrhythmia detection algorithm sensitivity and specificity are less than 100%, sometimes there may be some false arrhythmias detected and also some true arrhythmia events may not be detected. This is especially true when the signal is noisy.
 - The ECG size and minimum QRS detection threshold settings affect arrhythmia detection and heart rate calculation sensitivity.
 - If QRS amplitude is low, the monitor might not be able to calculate heart rate and false asystole calls may occur. During the learning phase of the algorithm, arrhythmia detection may not be available. So you should closely monitor patient condition during and for several minutes after the learning phase to allow the algorithm to reach optimal detection performance.
-

8.6.2 Arrhythmia Events

This section lists all arrhythmia events and their criteria.

8.6.2.1 Lethal Arrhythmia Events

Arrhythmia message	Description
Asystole	No QRS complex detected within the set time interval in the absence of ventricular fibrillation or chaotic signal.
V-Fib/V-Tach	A fibrillatory wave for 6 consecutive seconds. A dominant rhythm of adjacent PVCs and the ventricular rate is greater than the V-tach rate limit.
V-Tach	The number of consecutive PVCs is greater than or equal to the V-Tach PVCs limit, and the ventricular rate is greater than or equal to the V-Tach rate limit.
Vent Brady	The number of consecutive PVCs is greater than or equal to V brady PVC limit and the ventricular rate is less than the V brady rate limit.
Extreme Tachy	The heart rate is greater than the extreme tachycardia limit.
Extreme Brady	The heart rate is less than the extreme bradycardia limit.

8.6.2.2 Nonlethal Arrhythmia Events

Arrhythmia message	Description
R on T	R on T PVC is detected.
Run PVCs	More than two consecutive PVCs, but lower than the V brady PVCs limit, and the ventricular rate is lower than the V-Tach rate limit.
Couplet	A Pair of PVCs detected in between normal beats.
Multiform PVC	Multiform PVCs detected in Multif. PVC's Window (which is adjustable).

Arrhythmia message	Description
PVC	One PVC detected in between normal beats.
Bigeminy	A dominant rhythm of N, V, N, V, N, V.
Trigeminy	A dominant rhythm of N, N, V, N, V, N, V.
Tachy	The heart rate is greater than the tachycardia limit.
Brady	The heart rate is lower than the bradycardia limit.
Pacer not Capture	No QRS complex detected for 300 ms following a pace pulse (for paced patients only).
Pacer not Pacing	No pace pulse detected for 1.75 x average R-to-R intervals following a QRS complex (for paced patients only).
Missed Beats	At least 3 consecutive Ns, and The current RR interval is greater than 1.5 x previous RR interval, and The next RR interval is lower than 1.5 x average RR interval, and HR lower than 100 and the current RR interval is greater than 1.75 x average RR interval , or HR is greater than or equal to 100 and the current RR interval is greater than 1000 ms.
Nonsus V-Tach	The number of consecutive PVCs is lower than the V-Tach PVCs limit but greater than 2, and the ventricular rate is greater than or equal to the V-Tach Rate limit.
Vent Rhythm	The number of consecutive PVCs is greater than or equal to the V Brady PVCs limit, and ventricular rate is greater than or equal to the V Brady Rate limit but lower than V-Tach Rate limit.
Pause	No QRS complex is detected within the set time threshold of pause.
Irr Rhythm	Consistently irregular rhythm (N, irregular RR interval change is greater than 12.5%)
Afib	P wave is absent and normal beat RR intervals are irregular.
PVCs/min	PVCs/min exceeds high limit.
Pauses/min	Pauses/min exceeds high limit.
Irr. Rhythm End	Irregular rhythm no longer detected for the irregular rhythm end delay time.
Afib End	Atrial fibrillation no longer detected for the Afib end delay time.

8.6.3 Displaying Arrhythmia Information

You can display the arrhythmia information in the numeric area. To do so, follow this procedure:

1. Access **Tile Layout** by either of the following ways:
 - ◆ Select the **Screen Setup** quick key → select the **Tile Layout** tab.
 - ◆ Select **Main Menu** quick key → from the **Display** column select **Tile Layout**.
2. Click the numeric area where you want to display the arrhythmia information, and then select ECG → **Arrhythmia**.

8.6.4 Changing Arrhythmia Settings

8.6.4.1 Changing Arrhythmia Alarm Settings

To set the arrhythmia alarm properties, follow this procedure:

1. Select the ECG numeric area or waveform area to enter the **ECG** menu.
2. Select the **Arrhythmia** tab → **Alarm** tab.
3. Enter the password if required. For more information, refer to *6.9.3 Selecting Password for User Authentication*.
4. Set alarm properties as desired.

NOTE

- You can switch off lethal arrhythmia alarms only when you have enabled Lethal Arrhys Off. For more information, see 8.6.4.2 *Setting the Lethal Arrhythmia Alarms Switch*.
- The priority of lethal arrhythmia alarms is always high. It cannot be altered.

8.6.4.2 Setting the Lethal Arrhythmia Alarms Switch

To disable the arrhythmia alarms, follow this procedure:

1. Select the **Main Menu** quick key → from the **System** column select **Maintenance** → input the required password → select .
2. Select the **Alarm** tab → select the **Other** tab.
3. From the **Other** block, set **Lethal Arrhys Off**.

- ◆ **Lethal Arrhys Off** is set to **Disable** by default. In this case, you cannot switch off arrhythmia alarms.
- ◆ If you set **Lethal Arrhys Off** to **enable**, you can switch off arrhythmia alarms from the **ECG** menu. For more information, see 8.6.4.1 *Changing Arrhythmia Alarm Settings*.

WARNING

- If you switch off all arrhythmia alarms, the monitor will not alarm for any arrhythmia event. This may result in a hazard to the patient. Always keep the patient under close surveillance.

NOTE

- If any of the lethal arrhythmia alarms is switched off, the ECG waveform area displays the "Lethals Off" message.

8.6.4.3 Changing Arrhythmia Alarm Threshold Settings

You can change threshold settings for some arrhythmia alarms. When an arrhythmia violates its threshold, an alarm will be triggered. To do so, follow this procedure:

1. Select the ECG numeric area or waveform area to enter the **ECG** menu.
2. Select the **Arrhythmia** tab → select the **Threshold** tab.
3. Enter the password if required. For more information, refer to 6.9.3 *Selecting Password for User Authentication*.
4. Set the threshold of desired arrhythmia alarms.

NOTE

- The asystole delay time relates to ECG relearning. When heart rate is less than 30 bpm, it is recommended to set Asystole Delay to 10 sec.

8.6.4.4 Arrhythmia Threshold Range

Arrhythmia	Threshold Range
Asystole Delay	3 sec to 10 sec
Tachy (HR High)	60 bpm to 295 bpm
Brady (HR Low)	16 bpm to 120 bpm
Extreme Tachy	65 bpm to 300 bpm

Arrhythmia	Threshold Range
Extreme Brady	15bpm to 115 bpm
Multif PVCs Window	3 beats to 31 beats
V-Tach Rate	100 bpm to 200 bpm
V Brady Rate	15 bpm to 60 bpm
V-Tach PVCs	3 beats to 99 beats
V Brady PVCs	3 beats to 99 beats
PVCs/min	1 to 100
Pauses/min	1 to 15
Pause Threshold	1.5sec, 2.0sec, 2.5sec, 3.0sec
AF/Irr Rhy End Time	0, 1 min, 2 min, 3 min, 4 min, 5 min, 10 min, 15 min, 30 min

8.6.4.5 Setting Thresholds for PVC-Related Alarms

PVC-related alarms are detected on the basis of the current PVC rate and the number of consecutive PVCs.

To set the required thresholds for PVC-related alarms, follow this procedure:

1. Select the ECG numeric area or waveform area to enter the **ECG** menu.
2. Select the **Arrhythmia** tab → select the **More Threshold** tab.
3. Enter the password if required. For more information, refer to 6.9.3 *Selecting Password for User Authentication*.
4. Adjust **V-Tach PVCs**, **V-Tach Rate**, **V Brady PVCs**, and **V Brady Rate** to set the threshold of desired PVC-related alarms.

The following figure illustrates the conditions under which PVC alarms will be generated if **V-Tach PVCs** is set to 6, **V-Tach Rate** is set to 130, **V Brady PVCs** is set to 5, and **V Brady Rate** is set to 40.

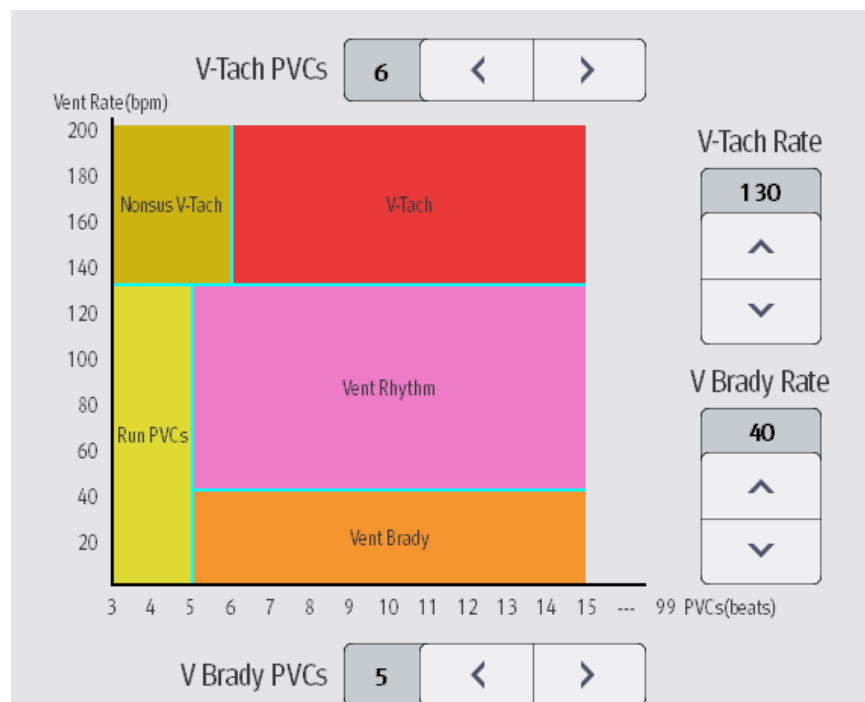

- If both V-Tach PVCs and V-Tach Rate are greater than or equal to the limits, a V-Tach alarm is generated.

- If the number of consecutive PVCs is lower than the V-Tach PVCs limit (6) but greater than 2, and PVC rate is greater or equal to the V-Tach Rate limit (130), a Nonsus V-Tach alarm is generated.
- If the number of consecutive PVCs is greater than or equal to the V Brady PVCs limit (5), and PVC rate is lower than the V Brady limit (40), a Vent Brady alarm is generated.
- If both the V Brady PVCs and V Brady Rate are lower than the limits, but V Brady PVCs is greater than 2, a Run PVCs alarm is generated.
- If the V Brady PVCs and V Brady Rate are greater than or equal to limits, but the Vent rate is lower than V-Tach Rate (130), a Vent Rhythm alarm is generated.

8.6.5 Arrhythmia Alarms Timeout

Normally, an arrhythmia alarm is presented when an alarm condition is detected. However, there are certain situations that can inhibit audible and visible alarm indications even though an alarm condition was detected. For more information, see 8.6.5.1 Arrhythmia Alarm Chains and 8.6.5.2 Setting Arrhythmia Alarm Timeout Period.

8.6.5.1 Arrhythmia Alarm Chains

If multiple alarms overlap, announcing all of the detected alarm conditions would be confusing, and a more serious condition might be overlooked. So arrhythmia alarms are prioritized by alarm "chains".

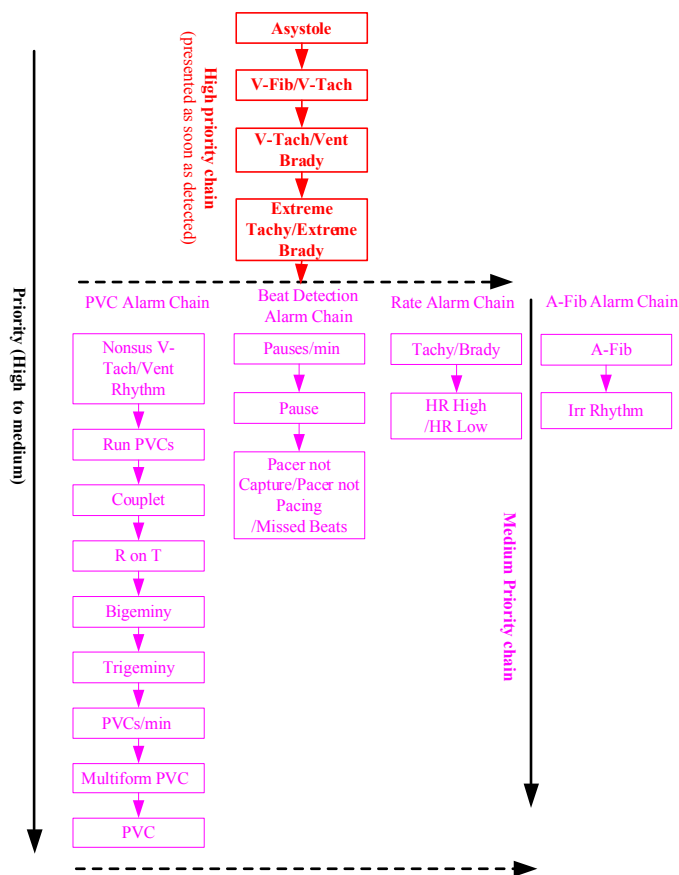

8.6.5.2 Setting Arrhythmia Alarm Timeout Period

The arrhythmia algorithm can disable alarm light and alarm tone for designated period of time when certain arrhythmia alarms are detected.

To set the arrhythmia alarm timeout period, follow this procedure:

1. Select the **Main Menu** quick key → from the **System** column select **Maintenance** → input the required password → select **↵**.
2. Select the **Alarm** tab → select the **Other** tab.

From the **Other** block, set **Arrhy Shield Time**. The arrhythmia alarm timeout period is two minutes by default. To disable this function, set **Arrhy Shield Time** to 0.

NOTE

- For the following alarms, alarm light and alarm tone cannot be disabled: HR high, HR low, Tachycardia, Bradycardia, Afib End, Irr. Rhythm End.
- The timeout period is only applicable to the alarms in the medium priority chains and atrial fibrillation chain. For the alarms in the high priority chain, alarm tone and alarm light are presented as soon as the alarm condition is detected.
- Alarm indication rules for alarms in the atrial fibrillation chain are the same with those for the medium priority chains.

8.6.5.3 Arrhythmia Alarm Timeout Rules

The following table explains how audible and visual alarm indicate during arrhythmia alarm timeout.

Previous alarm	Current alarm	Alarm indication
Alarm in high priority chain	Alarm in high priority chain	Alarm light and alarm tone
	Alarm in medium priority chain	During timeout period, alarm light and alarm tone are disabled. When the timeout period is reached, alarm light and alarm tone are reactivated.
Alarm in medium priority chain	Alarm in high priority chain	Alarm light and alarm tone
	Alarm in the same medium priority chain, but with higher priority	Alarm light and alarm tone
	The same alarm reoccurs	During timeout period, alarm light and alarm tone are disabled. When the timeout period is reached, alarm light and alarm tone are reactivated.
	Alarm in the same medium priority chain, but with lower priority	During timeout period, alarm light and alarm tone are disabled. When the timeout period is reached, alarm light and alarm tone are reactivated.
	Alarm in other medium priority chain	Alarm light and alarm tone

8.7 ST Segment Monitoring

ST monitoring is intended for adult, pediatric and neonatal patient.

8.7.1 ST Safety Information

WARNING

- ST values may be affected by such factors as some drugs or metabolic and conduction disturbances.
- ST deviation is often calculated at a fixed offset from the J point. Changes in heart rate may affect ST.
- The ST deviation measurement algorithm has been tested for accuracy. The significance of ST segment changes needs to be determined by a physician.
- This monitor provides ST deviation level change information. The clinical significance of the ST level change information should be determined by a physician.

8.7.2 Enabling ST Monitoring

The ST monitoring function is disabled by default. Before you start ST monitoring, enable the ST function. To do so, follow this procedure:

1. Select the ECG numeric area or waveform area to enter the **ECG** menu.

2. Select the **ST** tab→ select the **Setup** tab.
3. Switch on **ST Analysis**.

Reliable ST monitoring cannot be ensured under the following situations:

- You are unable to get a lead that is not noisy.
- Arrhythmias, such as atrial fib or flutter, cause irregular baseline.
- The patient is continuously ventricularly paced.
- The patient has left bundle branch block.

In these cases, you may consider switching off ST monitoring.

8.7.3 Displaying ST Numerics

To display ST numerics and Segments, follow this procedure:

1. Access **Tile Layout** by either of the following ways:
 - ◆ Select the **Screen Setup** quick key → select the **Tile Layout** tab.
 - ◆ Select **Main Menu** quick key → from the **Display** column select **Tile Layout**.
2. Click the numeric area where you want to display the ST numerics, and then select **ECG** → **ST**.

The display of ST parameters area is different according to the lead type:

- When you are using the 3-lead ECG leadwires, the ST numeric area does not display. A ST value displays in the ECG numeric area.
- When you are using the 5-lead ECG leadwires, the ST numeric area displays 7 ST values: ST-I, ST-II, ST-III, ST-aVR, ST-aVL, ST-aVF, ST-V.
- When you are using the 6-lead ECG leadwires, the ST numeric area displays 8 ST values: ST-I, ST-II, ST-III, ST-aVR, ST-aVL, ST-aVF, ST-Va, ST-Vb.
- When you are using the 12-lead ECG leadwires, the ST numeric area displays 12 ST values: ST-I, ST-II, ST-III, ST-aVR, ST-aVL, ST-aVF, ST-V1, ST-V2, ST-V3, ST-V4, ST-V5, ST-V6.

This example shows the ST numeric area when 5-lead ECG cable is used. Your monitor screen may look slightly different:

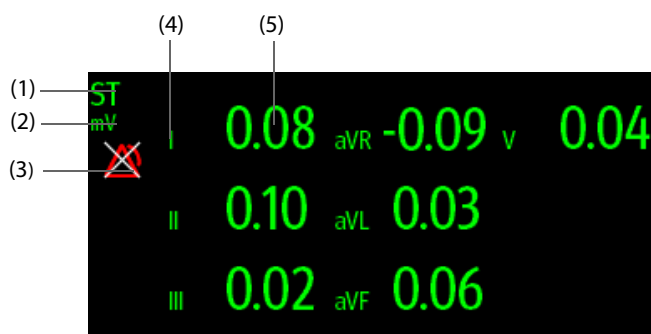

(1) Parameter label

(2) ST unit

(3) ST alarm off symbol

(4) Lead labels

(5) ST numerics: a positive value indicates ST segment elevation, and a negative value indicates ST segment depression.

8.7.4 Displaying ST Segments in the Waveform Area

You can display ST segments in the waveform area. To do so, follow this procedure:

1. Access **Tile Layout** by either of the following ways:
 - ◆ Select the **Screen Setup** quick key → select the **Tile Layout** tab.
 - ◆ Select **Main Menu** quick key → from the **Display** column select **Tile Layout**.

2. Select the waveform area where you want to display the ST segments, and then select **ST**→ **ST Segment**.

The waveform area displays the current and baseline ST segments. It also displays the current and baseline ST values. In the following picture, the current ST segment and value are in green, while the baseline ST segment and value are in white.

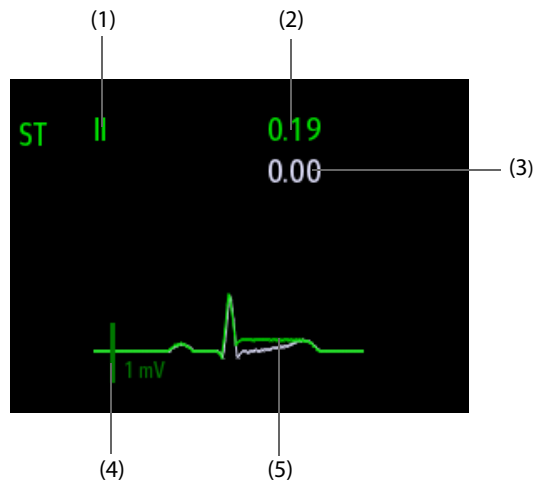

- | | |
|--|----------------------|
| (1) ST lead | (2) Current ST value |
| (3) Baseline ST value | (4) 1 mV scale |
| (5) Current ST segment (green) and baseline ST segment (white) | |

8.7.5 Entering the ST View

The ST View shows a complete QRS segment for each ST lead. The color of current ST segments and ST values is consistent with the color of ECG waveforms, normally green. The color of baseline ST segments and ST values is white.

You can enter the ST view either by selecting the ST segment in the waveform area, or by the following ways:

1. Select the ST numeric area, ECG numeric area or ECG waveform area to enter the **ECG** menu.
2. Select the **ST** tab.
3. From the bottom of the menu, select **ST View**.

8.7.6 Saving the Current ST as Baseline

ST deviation is a typically monitored as a relative change from a baseline value. Set an ST baseline when ST values become stable. If you did not set the ST baseline, the monitor automatically saves the baseline when valid ST values appear for 5 minutes. To manually set the ST baseline, select **Set Baseline** in the **ST View** window. From the **ST View** window, you can also perform the following operations:

- Display or hide ST baseline by selecting **Display Baseline** or **Hide Baseline**.
- Display or hide the position of ISO point, J point and ST point by selecting **Display Marker** or **Hide Marker**.

CAUTION

- **Updating ST baseline affects ST alarms.**
-

8.7.7 Entering the ST Graphic Window (only available for the independent external display)

To display **ST Graphic** window, follow this procedure:

1. Select the ECG numeric area or waveform area to enter the **ECG** menu.
2. Select the **ST** tab.

- From the bottom of the menu, select **ST Graphic**. The following figure shows the ST Graphic when **ST Alarm Mode** is set to **Absolute**. The height of the bar indicates the ST value of corresponding ST lead. The color of the bar indicates ST alarm status: green indicates that corresponding ST value is within alarm limits; cyan, yellow and red indicate that the ST value exceeds the alarm limits. The color matches ST alarm priority.

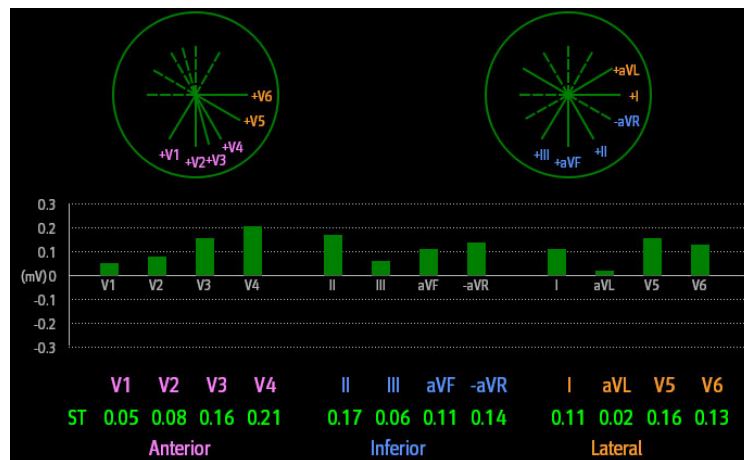

The following figure shows the ST Graphic when **ST Alarm Mode** is set to **Relative**. The height of grey bar indicates the baseline ST value and the green bar (cyan, yellow or red if an alarm occurs) indicates Δ ST.

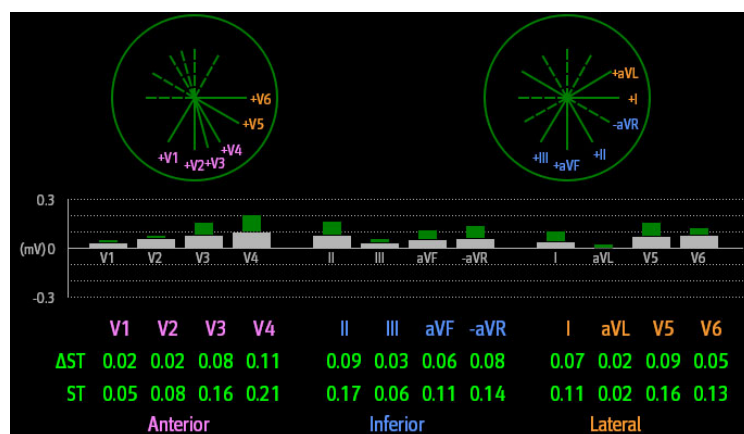

8.8 Changing ST Settings

8.8.1 Setting ST Alarm Properties

To set ST alarm properties, follow this procedure:

- Select the ST numeric area, ECG numeric area or ECG waveform area to enter the **ECG** menu.
- Select the **ST** tab → **Alarm** tab.
- Set **ST Alarm Mode** to **Absolute** or **Relative**.
 - ◆ **Absolute**: you can separately set the alarm properties for each ST alarm.
 - ◆ **Relative**: you can set the alarm properties for **ST Single** and **ST Dual** alarms.
- Set ST alarm properties.

8.8.1.1 Setting the ST Alarm Delay Time

To set the ST alarm delay time, follow this procedure:

- Select the **Main Menu** quick key → from the **System** column select **Maintenance** → input the required password → select **↵**.
- Select the **Alarm** tab → select the **Other** tab.

3. Set **ST Alarm Delay**.

8.8.1.2 Changing Leads for ST Display

The monitor automatically selects the three most deviated leads for ST display. You can also manually select the leads. To do so, follow this procedure:

1. Select the ST numeric area, ECG numeric area or ECG waveform area to enter the **ECG** menu.
2. Select the **ST** tab → select the **Setup** tab.
3. Set **ST Segment**. You can select up to 3 leads.

8.8.1.3 Showing ISO Point, J Point, and ST Point Marks

In the waveform area, the ISO point, J point, and ST point mark do not display on the ST segments by default. To show these marks, follow this procedure:

1. Select the ST numeric area, ECG numeric area or ECG waveform area to enter the **ECG** menu.
2. Select the **ST** tab → select the **Setup** tab.
3. Switch on **Show Markers**.

8.8.1.4 Changing the ST Unit

The unit of ST measurements can be millivolt (mV) or millimeter (mm). To change the ST unit, follow this procedure:

1. Select the **Main Menu** quick key → from the **System** column select **Maintenance** → input the required password → select **↵**.
2. Select the **Unit** tab.
3. Set **ST Unit**.

8.8.2 Adjusting ST Measurement Points

8.8.2.1 About ST Point, ISO Point, and J Point

The ST deviation value for each beat is the potential difference between the isoelectric (ISO) point and the ST point. The ISO point provides the baseline. The ST point is at the midpoint of the ST segment. The J point is the end of the QRS complex. As the J point is a fixed distance away from the ST point, it can be useful to help you correctly position the ST point.

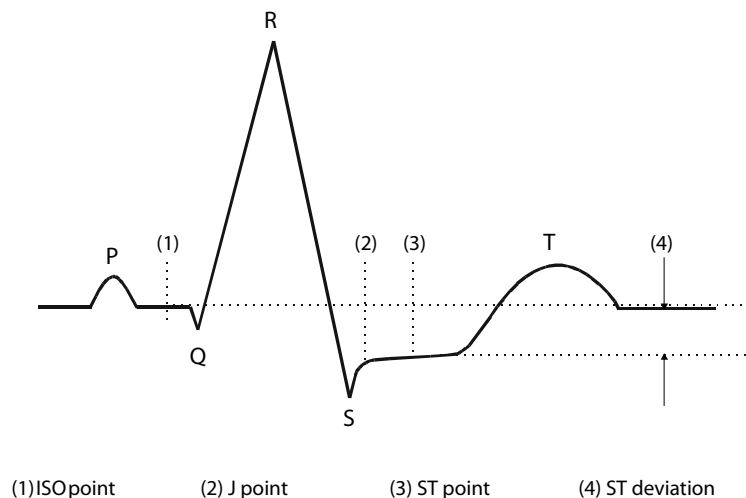

8.8.2.2 Setting ST Point, ISO Point, and J Point

CAUTION

- You need to adjust the ST points before starting monitoring, or if the patient's heart rate or ECG morphology changes significantly, as this may affect the size of the QT interval and thus the placement of the ST point. Artifactual ST segment depression or elevation may occur if the isoelectric point or the ST point is incorrectly set.
 - Always make sure that the positions of ST points are appropriate for your patient.
-

To set ST point, ISO point, and J point, follow this procedure:

1. Select the ST numeric area, ECG numeric area or ECG waveform area to enter the **ECG** menu.
2. Select the **ST** tab→ select the **Adjust** tab.
3. Set **ST Point**.

The setting of **Auto Adjust** defines the method of adjusting the ISO point and J point. **Auto Adjust** is enabled by default. In this case, positions of ISO point and J point are automatically adjusted accordingly. If you disable when **Auto Adjust**, you need to manually adjust the position of ISO point and J point by selecting the arrows at the right sides of **ISO** and **J**.

- The ISO point (isoelectric) position is given relative to the R-wave peak. Position the ISO point in the middle of the flattest part of the baseline (between the P and Q waves).
- The J point position is given relative to the R-wave peak and helps locating the ST point. Position the J point at the end of the QRS complex and the beginning of the ST segment.
- The ST point is positioned a fixed distance from the J point. Move the J point to position the ST point at the midpoint of the ST segment. Position the ST point relative to the J point at **J+60/80ms**, **J+40ms**, **J+60ms** or **J+80ms**. When **J+60/80ms** is selected, the ST point will be positioned 80 ms (heart rate 120 bpm or less) or 60 ms (heart rate more than 120 bpm) from the J point.

8.9 QT/QTc Interval Monitoring

The QT interval is defined as the time between the beginning of the Q-wave and the end of the T-wave. It measures the total duration of ventricular depolarization (QRS duration) and repolarization (ST-T). QT interval monitoring can assist in the detection of long QT syndrome.

The QT interval has an inverse relationship to heart rate. Faster heart rates shorten the QT interval and slower heart rates prolong the QT interval. Therefore, several formulas can be used to correct the QT interval for heart rate. The heart rate corrected QT interval is abbreviated as QTc.

QT/QTc interval monitoring is intended for adult, pediatric, and neonatal patients.

8.9.1 QT/QTc Monitoring Limitations

Some conditions may make it difficult to achieve reliable QT/QTc monitoring, for example:

- R-wave amplitudes are too low
- The presence of frequent ventricular ectopic beats
- Unstable RR intervals
- P-waves tending to encroach on the end of the previous T-wave at high heart rates
- The T-wave is very flat or T-wave are not well defined
- The end of the T-wave is difficult to delineate because of the presence of U-waves
- QTc measurements are not stable
- In the presence of noise, asystole, ventricular fibrillation, atrial fibrillation, and ECG lead off

For these cases you should select a lead with good T-wave amplitude and no visible flutter activity, and without a predominant U-wave or P-wave.

Some conditions such as left or right bundle branch block or hypertrophy can lead to a widened QRS complex. If a long QTc is observed you should verify it to ensure that it is not caused by QRS widening.

Because normal beats followed by ventricular beats are not included in the analysis, no QT measurement will be generated in the presence of a bigeminy rhythm.

If the heart rate is extremely high (over 150bpm for adults and over 180bpm for pediatrics and neonates), QT will not be measured. When the heart rate changes, it can take several minutes for the QT interval to stabilize. For reliable QTc calculation it is important to avoid measurements when the heart rate is changing.

8.9.2 Enabling QT/QTc Monitoring

The QT monitoring function is disabled by default. Before you start QT monitoring, enable the QT function. To do so, follow this procedure:

1. Select the ECG numeric area or waveform area to enter the **ECG** menu.
2. Select the **QT** tab → select the **Setup** tab.
3. Switch on **QT Analysis**.

8.9.3 Displaying QT/QTc Numerics and Segments

To display QT/QTc numerics and Segments, follow this procedure:

1. Access **Tile Layout** by either of the following ways:
 - ◆ Select the **Screen Setup** quick key → select the **Tile Layout** tab.
 - ◆ Select **Main Menu** quick key → from the **Display** column select **Tile Layout**.
2. Click the parameter numeric area where you want to display the QT numerics, and then select **ECG** → **QT/QTc**.

NOTE

- **QTc values are calculated based on the QT-HR, not the ECG HR. To view the QT-HR, open the QT View window. For more information, see 8.9.4 Entering the QT View.**

The following picture shows the QT numeric area. Your monitor screen may look slightly different:

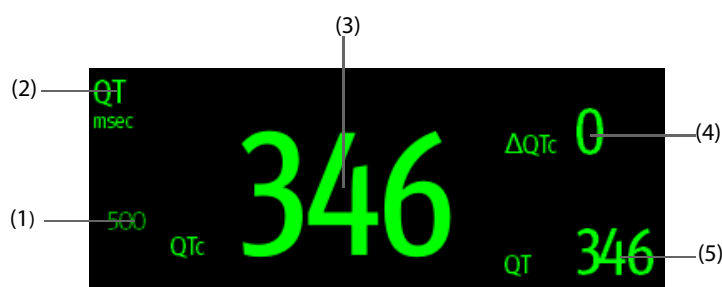

- (1) QTc alarm limit (if QTc alarm is off, the alarm off symbol is displayed)
- (2) Parameter label
- (3) QTc value
- (4) Δ QTc value (the difference between the current and baseline QTc values)
- (5) QT value

NOTE

- **The display of the QT numeric area differs as related settings change.**

8.9.4 Entering the QT View

QT View shows the current and baseline QT parameter values and waveforms. To enter the QT View, follow this procedure:

1. Select the QT numeric area, ECG numeric area or ECG waveform area to enter the **ECG** menu.
2. Select the **QT** tab.
3. From the bottom of the menu, select **QT View**.

The following picture shows the QT view.



- The current waveform is shown in the upper half in green.
- The baseline waveform is shown below in white.
- The start of QRS complex and the end of the T wave are marked with a vertical line.
- In some conditions, no QT measurement can be calculated. Then the cause of failed QT measurement is shown at the bottom of the QT numerics area and the message “Cannot Analyze QT” is shown in the technical alarm area.

Select the left or right arrow to switch leads. Corresponding waveform will be highlighted.

8.9.5 Changing the Current QTc as Baseline

In order to quantify changes in the QTc value, you can set a QTc baseline. If no baseline has been set for this patient within the first five minutes after getting valid QT values, the monitor will automatically set a baseline. To set the current values as baseline, follow this procedure:

1. From the **QT View** window, select **Set Baseline**.
2. From the pop-up dialog box, select **OK**. This baseline will then be used to calculate Δ QTc.

If you set a new baseline the previous baseline is discarded.

From the **QT View** window, you can also perform the following operations:

- Select the left or right arrow to select a lead label to highlight corresponding waveform.
- Select **Display Baseline** or **Hide Baseline** to display or hide baseline waveform.

CAUTION

- **Updating QTc baseline affects Δ QTc value and Δ QTc alarm.**
-

8.9.6 Changing QT Settings

8.9.6.1 Setting QT Alarm Properties

To set QT alarm properties, follow this procedure:

1. Select the QT numeric area, ECG numeric area or ECG waveform area to enter the **ECG** menu.
2. Select the **QT** tab→ select the **Alarm** tab.
3. Set QTc and Δ QTc alarm properties.

8.9.6.2 Selecting Leads for QT Calculation

You can select one lead or all leads for QT calculation. To do so, follow this procedure:

1. Select the QT numeric area, ECG numeric area or ECG waveform area to enter the **ECG** menu.

2. Select the **QT** tab → select the **Setup** tab.
3. Set **QT Leads**. **All** is selected by default. This means all leads are used for QT calculation.

8.9.6.3 Changing the QTc Formula

The monitor uses the Hodges correction formula by default to correct the QT interval for heart rate. To select the QTc formula, follow this procedure:

1. Select the **Main Menu** quick key → from the **System** column select **Maintenance** → input the required password → select .
2. Select the **Module** tab → **ECG** tab.
3. Set **QTc Formula**.

◆ Hodges: $QTc = QT + 1.75 \times (\text{HeartRate} - 60)$

◆ Bazett: $QTc = QT \times \left(\frac{\text{HeartRate}}{60}\right)^{\frac{1}{2}}$

◆ Fridericia: $QTc = QT \times \left(\frac{\text{HeartRate}}{60}\right)^{\frac{1}{3}}$

◆ Framingham: $QTc = QT + 154 \times \left(1 - \frac{60}{\text{HeartRate}}\right)$

8.10 ECG Relearning

Changes in ECG template could result in incorrect arrhythmia alarms and/or inaccurate heart rate. ECG relearning allows the monitor to learn new ECG template so as to correct arrhythmia alarms and HR value. Once learning is complete, the dominant QRS complex is stored as a reference template. The reference template is used as a normal morphology of that patient and it is compared with incoming beats to identify possible arrhythmias.

8.10.1 Auto ECG Relearning

Auto arrhythmia relearning happens in the following situation:

- The ECG lead type or lead label is changed.
- ECG leads are off and are not reconnected within 60 seconds.
- The patient's paced status is changed.

8.10.2 Initiating an ECG Relearning Manually

If you suspect that abnormal arrhythmia alarms are presented, you may need to manually initiate an ECG relearning. To do so, follow this procedure:

1. Select the ECG numeric area or waveform area to enter the **ECG** menu.
2. Select **Relearn** at the bottom left corner of the menu.

CAUTION

- **Take care to initiate ECG relearning only during periods of predominantly normal rhythm and when ECG signal is relatively noise-free. If ECG learning takes place during arrhythmia, the ectopics may be incorrectly learned as normal QRS complex. This may result in missed detection of subsequent events of arrhythmia.**
-

8.11 Calibrating ECG

The ECG signal may be inaccurate due to hardware or software problems. As a result, the ECG waveform amplitude becomes greater or smaller. In that case, you need to calibrate the ECG module. To do so, follow this procedure:

1. Select the **Main Menu** quick key → from the **System** column select **Maintenance** → input the required password → select .
2. Select the **Module** tab → **ECG** tab.
3. From the bottom left corner of the menu select **Calibrate**.

8.12 Defibrillation Synchronization Pulse Output

The monitor provides an multifunctional connector to output defibrillation synchronization pulse. If a defibrillator is connected, it receives a synchronization pulse (100 ms, +5 V) through the analog out connector each time an R-wave is detected.

WARNING

- **Improper use of a defibrillator may cause injury to the patient. The operator should determine whether to perform defibrillation or not according to the patient's condition.**
 - **According to AAMI specifications the peak of the synchronized defibrillator discharge should be delivered within 60 ms of the peak of the R wave. The signal at the ECG output (sync pulse) on the monitor is delayed by maximum of 30 ms. Your biomedical engineer should verify that your ECG/ Defibrillator combination does not exceed recommended maximum delay of 60 ms.**
 - **Before defibrillation, the user must ensure both defibrillator and monitor has passed the system test and can be safely used together.**
-
-

8.13 ECG Troubleshooting

This section lists the problems that might occur. If you encounter problems when using the monitor or accessories, check the table below before requesting for services. If the problem persists after you have taken corrective actions, contact your service personnel.

Problem	Corrective Actions
Do not see ECG numeric area or waveform area on the main screen	<ol style="list-style-type: none"> 1. Check that ECG is set to display in the Screen Setup menu. For more information, see 3.11.2 <i>Displaying Parameter Numerics and Waveforms</i>. 2. Check that if the ECG parameter switch is enabled. If not, enable the ECG measurement. For more information, see 3.11.1 <i>Switching On or Off a Parameter</i>. 3. Check that the cable connections of ECG electrode and the lead set are tight. Replace the ECG electrode or the lead set if needed.
Noisy ECG traces	<ol style="list-style-type: none"> 1. Check that electrodes are not detached or dry. Replace with fresh and moist electrodes if necessary. 2. Check that leadwires are not defective. Replace leadwires if necessary. 3. Check that patient cable or leadwires are routed too close to other electrical devices. Move the patient cable or leadwires away from electrical devices.
Excessive electrosurgical Interference	Use ESU-proof ECG cables. For more information, see 24.1 <i>ECG Accessories</i> .
Muscle Noise	<p>Inadequate skin preparation, tremors, tense subject, and/or poor electrode placement.</p> <ol style="list-style-type: none"> 1. Perform skin preparation again and re-place the electrodes. For more information, see 8.4.1 <i>Preparing the Patient Skin</i> and 8.4.2 <i>Applying Electrodes</i>. 2. Apply fresh, moist electrodes. Avoid muscular areas.
Intermittent Signal	<ol style="list-style-type: none"> 1. Check that cables are properly connected. 2. Check that electrodes are not detached or dry. Perform skin preparation again as described in 8.4.1 <i>Preparing the Patient Skin</i> and apply fresh and moist electrodes. 3. Check that the patient cable or leadwires are not damaged. Change them if necessary.

Problem	Corrective Actions
Excessive alarms: heart rate, lead fault	<ol style="list-style-type: none"> 1. Check that electrodes are not dry. Perform skin preparation again and re-place the electrodes. For more information, see <i>8.4.1 Preparing the Patient Skin</i> and <i>8.4.2 Applying Electrodes</i>. 2. Check for excessive patient movement or muscle tremor. Reposition the electrodes. Replace with fresh and moist electrodes if necessary.
Low Amplitude ECG Signal	<ol style="list-style-type: none"> 1. Check that the ECG gain is not set too low. Adjust the gain as required. For more information, see <i>8.5 Changing ECG Settings</i>. 2. Perform skin preparation again and re-place the electrodes. For more information, see <i>8.4.1 Preparing the Patient Skin</i> and <i>8.4.2 Applying Electrodes</i>. 3. Check electrode application sites. Avoid bone or muscular area. 4. Check that electrodes are not dry or used for a prolonged time. Replace with fresh and moist electrodes if necessary.
No ECG Waveform	<ol style="list-style-type: none"> 1. Check that the ECG gain is not set too low. Adjust the gain as required. For more information, see <i>8.5.3 Changing ECG Wave Settings</i>. 2. Check that the leadwires and patient cables are properly connected. 3. Change cable and lead wires. 4. Check that the patient cable or leadwires are not damaged. Change them if necessary.
Base Line Wander	<ol style="list-style-type: none"> 1. Check for excessive patient movement or muscle tremor. Secure leadwires and cable. 2. Check that electrodes are not detached or dry and replace with fresh and moist electrodes if necessary. For more information, see <i>8.4.1 Preparing the Patient Skin</i> and <i>8.4.2 Applying Electrodes</i>. 3. Check for ECG filter setting. Set ECG Filter mode to Monitor to reduce baseline wander on the display.

This page intentionally left blank.

9

Resting 12-Lead ECG Analysis

9.1 Resting 12-Lead ECG Analysis Introduction

The monitor can be configured with either Glasgow 12-lead ECG analysis algorithm or Mindray 12-lead ECG analysis algorithm.

The Glasgow algorithm is intended for adult, pediatric, and neonatal patients. The Mindray algorithm is intended for adult patients only.

The monitor providing the 12-lead ECG analysis function has a 12-lead label. The monitor incorporating the Glasgow algorithm is labelled with the logo of Glasgow.

For more information on the Glasgow algorithm, refer to *12-Lead ECG Interpretive Program Physician's Guide (PN: 046-004817-00)* for detail.

9.2 Entering the 12-Lead Screen

To enter the 12-Lead screen, follow this procedure:

1. Select the ECG numeric area or waveform area to enter the **ECG** menu.
2. Select the **Setup** tab.
3. Set the **Lead Set** to **12-Lead**.
4. From the bottom of the **ECG** menu, select **12-Lead**.

You can also enter the 12-Lead screen by following this procedure:

- Select the **Screen Setup** quick key → select **Choose Screen** → select **ECG 12-Lead**.
- Select **Main Menu** quick key → from the **Display** column select **Choose Screen** → select **ECG 12-Lead**.

9.3 Initiating Resting 12-Lead ECG Analysis

Before 12-lead ECG interpretation, check that all electrodes are correctly connected to the lead wires and the ECG trunk cable is properly connected. Check that patient information is correct. Keep the patient still.

To initiate 12-Lead ECG analysis, select **Analyze** from the left bottom of the 12-Lead screen.

9.4 Changing 12-Lead ECG Analysis Settings

On the ECG 12-Lead screen, you can set the high frequency filter, baseline drift removal (BDR) switch, and the waveform layout.

9.4.1 Setting the High Frequency Filter

The high frequency filter attenuates muscle artifact by restricting the included frequencies. The setting of the high frequency filter is 35 Hz by default. To change the setting, follow this procedure:

1. On the ECG 12-Lead screen, select the ECG numeric area or waveform area to enter the **ECG** menu.
2. Select the **Setup** tab.
3. Set **HighFreq Cut-off**.

The high frequency filter is a low-pass filter. That is to say signal that exceeds the set frequency is filtered out. For example, if you set **High Freq Cut-off** to **35 Hz**, only signal at 35 Hz or less displays. Signal exceeding 35 Hz is attenuated.

9.4.2 Setting the Baseline Drift Removal

The baseline drift removal (BDR) suppresses most baseline drift interference and also is able to preserve the fidelity of the ST-segment level. BDR is switched on by default. To set the BDR, follow this procedure:

1. On the ECG 12-Lead screen, select the ECG numeric area or waveform area to enter the **ECG** menu.
2. Select the **Setup** tab.
3. Switch on or off **Baseline Drift Removal**. If BDR is switched off, the 0.05 Hz high pass filter is used.

NOTE

- **BDR introduces around 1-second delay. We recommend using BDR except when the delay is unacceptable.**
-

9.4.3 Setting the 12-Lead Waveform Layout

To set the 12-lead waveform layout, follow this procedure:

1. On the ECG 12-Lead screen, select the ECG numeric area or waveform area to enter the **ECG** menu.
2. Select the **Setup** tab.
3. Set **Waveform Layout**.

◆ **Standard:** the waveform sequence is I, II, III, aVR, aVL, aVF, V1, V2, V3, V4, V5, V6.

◆ **Cabrera:** the waveform sequence is aVL, I, -aVR, II, aVF, III, V1, V2, V3, V4, V5, V6.

For the Glasgow algorithm, the sequence of the chest leads depends on the setting of **V3 placement**. If **V3 placement** is set to **V4R**, the sequence of chest leads is V4R, V1, V2, V4, V5, V6.

9.5 Glasgow Resting 12-lead ECG Analysis Algorithm Settings

For the Glasgow algorithm, besides filter mode, BDR, and waveform layout, you can also perform the following operation:

- Editing patient information
- Changing tachycardia and bradycardia thresholds.
- Setting the 12-lead ECG report

9.5.1 Editing Patient Information (For Glasgow Algorithms)

Some patient information may directly affect ECG analysis. Complete and correct patient information is helpful for accurate diagnosis and treatment of the patient. Enter patient information before taking an ECG measurement.

To enter patient information, follow this procedure:

1. On the ECG 12-Lead screen, select **Setup** to enter the **12-Lead Setup** menu.
2. On the **Patient Demographics** page, input or edit patient information.

NOTE

- **Check that patient information is correct before resting 12-lead analysis.**
 - **We recommend using pediatric lead placement V4R, V1, V2, V4 - V6 if the patient is under 16 years of age. Please record V4R using the V3 electrode. Also set V3 Electrode to V4R. This is a normal practice for a patient of this age.**
-

9.5.2 Setting Tachycardia and Bradycardia Thresholds (For Glasgow Algorithms)

To set tachycardia and bradycardia thresholds, follow this procedure:

1. On the ECG 12-Lead screen, select **Setup** to enter the **12-Lead Setup** menu.
2. Select the **Setup** tab.
3. Set **Tachy** and **Brady**.

NOTE

- The tachycardia threshold only applies to patients whose age exceeds 180 days.
 - The bradycardia threshold only applies to patients whose age exceeds 2191 days.
-

9.5.3 Setting the 12-Lead Interpretation Report (For Glasgow Algorithms)

To set the 12-lead interpretation report, follow this procedure:

1. On the ECG 12-Lead screen, select **Setup** to enter the **12-Lead Setup** menu.
2. Select the **Report** tab.
3. Set the format and items included in the 12-lead interpretation report.

9.6 Saving the 12-Lead Interpretation Report

At the completion of 12-lead ECG interpretation, select **Save** to save the report. You can review the saved 12-lead interpretation reports. For more information, see *16.2.10 12-Lead ECG Review Page*.

9.7 Printing the 12-Lead Interpretation Report

At the completion of 12-lead ECG interpretation, select **Print** to output the report via the printer.

9.8 Exiting the ECG 12-Lead Screen

To exit the ECG 12-Lead screen, select **Exit** on the ECG 12-Lead screen.

10 Monitoring Respiration (Resp)

10.1 Resp Introduction

Impedance respiration is measured across the thorax. When the patient is breathing or ventilated, the volume of air changes in the lungs, resulting in impedance changes between the electrodes. Respiration rate (RR) is calculated from these impedance changes, and a respiration waveform appears on the patient monitor screen.

Respiration monitoring is intended for adult, pediatric and neonatal patients.

10.2 Resp Safety Information

WARNING

- **When monitoring the patient's respiration, do not use ESU-proof ECG cables.**
 - **If you do not set the detection level for the respiration correctly in manual detection mode, it may not be possible for the monitor to detect zero respiration rate. If you set the detection level too low, the monitor is more likely to detect cardiac activity, and to falsely interpret cardiac activity as respiratory activity in the case of zero respiration rate.**
 - **The respiration measurement does not recognize the cause of zero respiration rate. It only indicates an alarm if no breath is detected when a pre-adjusted time has elapsed since the last detected breath. Therefore, it cannot be used for diagnostic purpose.**
 - **If operating under conditions according to the EMC Standard IEC 60601-1-2 (Radiated Immunity 3V/m), field strengths above 3V/m may cause erroneous measurements at various frequencies. Therefore, it is recommended to avoid the use of electrically radiating equipment in close proximity to the respiration measurement unit.**
 - **The impedance respiration measurement may cause rate changes in Minute Ventilation Rate Responsive Pacemakers. Set the pacemaker rate responsive mode off or disable the impedance respiration measurement on the monitor.**
 - **When using the electrosurgery unit, ensure proper contact of the ESU return electrode to the patient to avoid burns at monitor measurement sites. Also ensure that the ESU return electrode is near the operating area.**
-

CAUTION

- **Only use parts and accessories specified in this manual.**
 - **Respiration monitoring is not for use on the patients who are very active, as this will cause false alarms.**
-

10.3 Resp Display

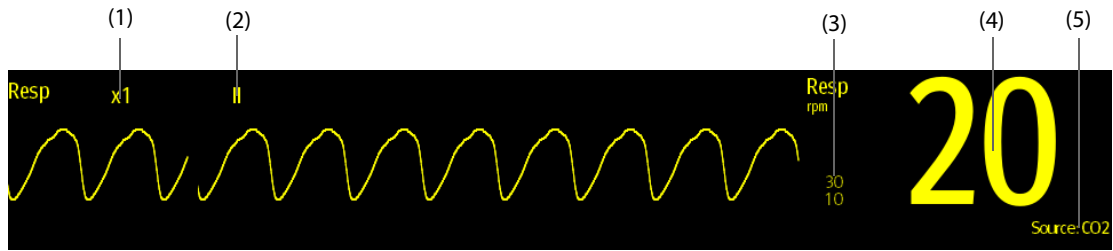

- (1) Resp waveform gain (2) Resp lead label (3) Alarm limits
(4) Respiration rate (RR) (5) RR source

NOTE

- If ESU-proof ECG cables are used, the Resp waveform area will display the message “Check Leads”. Replace the ECG cable if necessary.

10.4 Preparing for Resp Monitoring

10.4.1 Preparing the Patient

Follow this procedure to prepare the patient:

1. Shave hair from skin at chosen sites.
2. Gently rub skin surface at sites to remove dead skin cells.
3. Thoroughly cleanse the site with a mild soap and water solution.
4. Dry the skin completely before applying the electrodes.

CAUTION

- Proper skin preparation is necessary for good signal quality at the electrode site, as the skin is a poor conductor of electricity.

10.4.2 Placing the Electrodes

As the Respiration measurement adopts the standard ECG electrode placement, you can use different ECG cables. Since the respiration signal is measured between two ECG electrodes, if a standard ECG electrode placement is applied, the two electrodes should be RA and LA of ECG Lead I, or RA and LL of ECG Lead II.

For more information, see 8.4.4 ECG Electrode Placements.

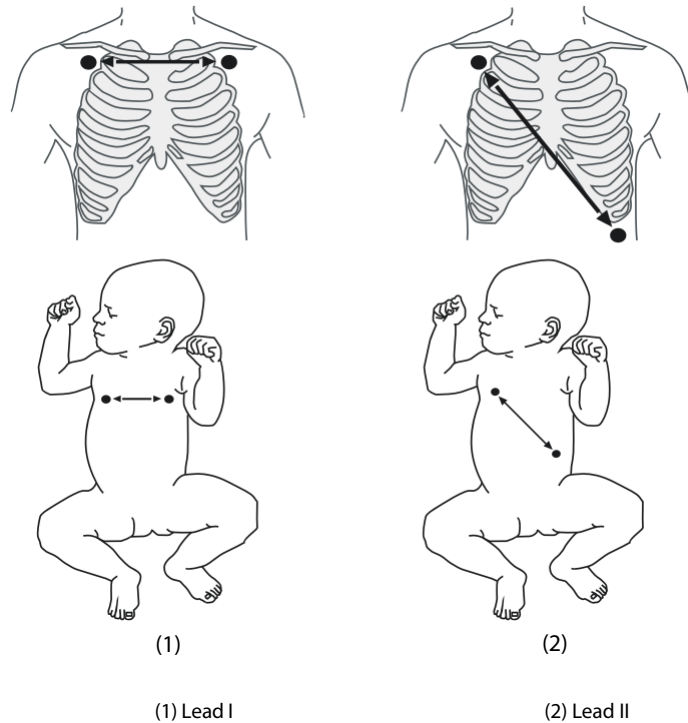

CAUTION

- **Correct electrodes placement can help to reduce cardiac overlay: avoid the liver area and the ventricles of the heart in the line between the respiratory electrodes. This is particularly important for neonates.**
- **Some patients with restricted movements breathe mainly abdominally. In these cases, you may need to place the left leg electrode on the left abdomen at the point of maximum abdominal expansion to optimize the respiratory wave.**
- **In clinical applications, some patients (especially neonates) expand their chests laterally, causing a negative intrathoracic pressure. In these cases, it is better to place the two respiration electrodes in the right midaxillary and the left lateral chest areas at the patient's maximum point of the breathing movement to optimize the respiratory waveform.**
- **To optimize the respiration waveform, place the RA and LA electrodes horizontally when monitoring respiration with ECG Lead I; place the RA and LL electrodes diagonally when monitoring respiration with ECG Lead II.**
- **Periodically inspect the electrode application site to ensure skin quality. If the skin quality changes, replace the electrodes or change the application site.**

NOTE

- **Store the electrodes at room temperature. Open the electrode package immediately prior to use.**
 - **Check that the electrode packages are intact and not expired. Make sure the electrode gel is moist.**
-

10.5 Changing Resp Settings

10.5.1 Setting the Resp Alarm Properties

To set the Resp alarm properties, follow this procedure:

1. Select the Resp numeric area or waveform area to enter the **Resp** menu.
2. Select the **Alarm** tab.
3. Enter the password if required. For more information, refer to *6.9.3 Selecting Password for User Authentication*.
4. Set alarm properties as desired.

10.5.2 Setting the RR Source

To set RR source, follow this procedure:

1. Select the Resp numeric area or waveform area to enter the **Resp** menu.
2. Select the **Setup** tab.
3. Choose **RR Source** from the dropdown list.

When you select **Auto**, the system automatically selects the RR source according to the priority. The priority of RR source is first CO₂, and then RM, and finally ECG. When the current RR source does not have valid measurement, the system automatically switches the **RR Source** to **Auto**.

10.5.3 Choosing the Respiration Lead

To set the respiration lead, follow this procedure:

1. Select the Resp numeric area or waveform area to enter the **Resp** menu.
2. Select the **Setup** tab.
3. Set **Resp Lead**.

If you cannot get optimal Resp waveform or you suspect the Resp value after choosing the Resp lead, you may need to optimize the electrode placement.

10.5.4 Setting the Resp Waveform Size

To set the Resp waveform size, follow this procedure:

1. Select the Resp numeric area or waveform area to enter the **Resp** menu.
2. Select the **Setup** tab.
3. Set **Gain**.

10.5.5 Setting the Resp Waveform Speed

To set the Resp waveform speed, follow this procedure:

1. Select the Resp numeric area or waveform area to enter the **Resp** menu.
2. Select the **Setup** tab.
3. Set **Speed**.

10.5.6 Setting the Auto Detection Switch

To set the auto detection switch, follow this procedure:

1. Select the Resp numeric area or waveform area to enter the **Resp** menu.
2. Select the **Setup** tab.
3. Switch on or off **Auto Threshold Detection**.
 - ◆ If **Auto Threshold Detection** is switched on, the monitor automatically adjusts the Resp waveform detection level, or threshold.
 - ◆ If **Auto Threshold Detection** is switched off, you have to manually adjust the Resp waveform threshold. For more information, see *10.5.7 Adjusting the Resp Waveform Detection Threshold*.

In the auto detection mode, if you are monitoring Resp and ECG is switched off, the monitor cannot compare the ECG and Resp rates to detect cardiac overlay. The respiration detection level is automatically set higher to prevent the detection of cardiac overlay as respiration.

In the manual detection mode, cardiac overlay can in certain situations trigger the respiration counter. This may lead to a false indication of a high respiration or an undetected zero respiration rate condition. If you suspect that cardiac overlay is being registered as breathing activity, raise the detection level above the zone of cardiac overlay. If the Resp wave is so small that raising the detection level is not possible, you may need to optimize the electrode placement.

10.5.7 Adjusting the Resp Waveform Detection Threshold

Use the manual detection mode in the following situations:

- The respiration rate and the heart rate are close.
- Patients have intermittent mandatory ventilation.
- Respiration is weak. Try repositioning the electrodes to improve the signal.

To set the Resp waveform threshold to the desired level, follow this procedure:

1. Select the Resp numeric area or waveform area to enter the **Resp** menu.
2. Select the **Threshold** tab.
3. Select the up and down arrows below **Upper Line** and **Lower Line** to define the Resp waveform threshold.

Once set, the detection level will not adapt automatically to different respiration depths. It is important to remember that if the depth of breathing changes, you may need to change the detection level.

10.6 Resp Troubleshooting

For more information, see *D Alarm Messages*.

11 Monitoring Pulse Oxygen Saturation (SpO₂)

11.1 SpO₂ Introduction

Pulse Oxygen Saturation (SpO₂) monitoring is a non-invasive technique used to measure the amount of oxygenated haemoglobin and pulse rate by measuring the absorption of selected wavelengths of light. The light generated in the emitter side of the probe is partly absorbed when it passes through the monitored tissue. The amount of transmitted light is detected in the detector side of the probe. When the pulsative part of the light signal is examined, the amount of light absorbed by the haemoglobin is measured and the pulse oxygen saturation can be calculated. This device is calibrated to display functional oxygen saturation.

SpO₂ monitoring is intended for adult, pediatric and neonatal patients.

The following types of SpO₂ can be configured for the N1 monitor:

- Mindray SpO₂: the connector is blue and no logo is on the monitor.
- Nellcor SpO₂: the connector is grey and the logo of Nellcor is on the monitor.
- Masimo SpO₂: the connector is purple and the logo of Masimo SET is on the monitor.

NOTE

- **The SpO₂ extension cable should be compatible with the SpO₂ connectors. For example, you can only connect the Mindray SpO₂ extension cable to the Mindray SpO₂ connectors.**
 - **A functional tester or SpO₂ simulator can be used to determine the pulse rate accuracy.**
 - **A functional tester or SpO₂ simulator cannot be used to assess the SpO₂ accuracy.**
-

11.2 SpO₂ Safety Information

WARNING

- **When a trend toward patient deoxygenation is indicated, analyze the blood samples with a laboratory co-oximeter to completely understand the patient's condition.**
 - **Do not use SpO₂ sensors during magnetic resonance imaging (MRI). Induced current could potentially cause burns. The sensor may affect the MRI image, and the MRI unit may affect the accuracy of the oximetry measurements.**
 - **Prolonged continuous monitoring may increase the risk of undesirable changes in skin characteristics, such as irritation, reddening, blistering or burns. Inspect the sensor site every two hours and move the sensor if the skin quality changes. Change the application site every four hours. For neonates, or patients with poor peripheral blood circulation or sensitive skin, inspect the sensor site more frequently.**
 - **If the sensor is too tight because the application site is too large or becomes too large due to edema, excessive pressure for prolonged periods may result in venous congestion distal from the application site, leading to interstitial edema and tissue ischemia. SpO₂ is empirically calibrated in healthy adult volunteers with normal levels of carboxyhemoglobin (COHb) and methemoglobin (MetHb).**
 - **When patients are undergoing photodynamic therapy they may be sensitive to light sources. Pulse oximetry may be used only under careful clinical supervision for short time periods to minimize interference with photodynamic therapy.**
 - **Setting alarm limits to extreme values may cause the alarm system to become ineffective. For example, high oxygen levels may predispose a premature infant to retrolental fibroplasia. If this is a consideration, do not set the high alarm limit to 100%, which is equivalent to switching off the alarm.**
-

CAUTION

- **Change the application site or replace the sensor and/or patient cable when a persistent SpO₂ Low Signal Quality message is displayed on the equipment. These messages may indicate that patient monitoring time is exhausted on the patient cable or sensor.**
 - **Replace the cable or sensor when a “SpO₂ Sensor Off”, “SpO₂ No Sensor”, or “SpO₂ Low Signal Quality” message is consistently displayed while monitoring consecutive patients after completing troubleshooting steps listed in this manual.**
 - **Variation in measurements may be profound and may be affected by sampling technique as well as the patient’s physiological conditions. Any results exhibiting inconsistency with the patient’s clinical status should be repeated and/or supplemented with additional test data. Blood samples should be analyzed by laboratory instruments prior to clinical decision making to completely understand the patient’s condition.**
 - **Use only SpO₂ sensors specified in this manual. Follow the SpO₂ sensor’s instructions for use and adhere to all warnings and cautions.**
-

NOTE

- **Additional information specific to the Masimo sensors compatible with the equipment, including information about parameter/measurement performance during motion and low perfusion, may be found in the sensor’s directions for use (DFU).**
 - **Masimo cables and sensors are provided with X-Cal™ technology to minimize the risk of inaccurate readings and unanticipated loss of patient monitoring. Refer to the Cable or Sensor DFU for the specified duration of the patient monitoring time.**
-

11.3 SpO₂ Measurement Limitations

The following factors may influence the accuracy of SpO₂ measurement:

- Patient physiological characteristics:
 - ◆ Cardiac arrest
 - ◆ Hypotension
 - ◆ Darkly pigmented skin
 - ◆ Shock
 - ◆ Severe vasoconstriction
 - ◆ Hypothermia
 - ◆ Severe anemia
 - ◆ Ventricular septal defects (VSDs)
 - ◆ Venous pulsations
 - ◆ Poor perfusion
 - ◆ Dysfunctional hemoglobin, such as carboxyhemoglobin (COHb) and methemoglobin (MetHb)
 - ◆ Elevated levels of bilirubin
 - ◆ Vasospastic disease, such as Raynaud’s, and peripheral vascular disease
 - ◆ Hemoglobinopathies and synthesis disorders such as thalassemias, Hb s, Hb c, sickle cell, etc.
 - ◆ Hypocapnic or hypercapnic conditions
 - ◆ Birthmark(s), tattoos, skin discolorations, moisture on skin, deformed or abnormal fingers. etc.
- Interfering substances:
 - ◆ Intravascular dyes (such as indocyanine green, methylene blue, indigo carmine, etc.)
 - ◆ Dysfunctional haemoglobin, such as carboxyhemoglobin (COHb) and methemoglobin (MetHb)
 - ◆ Dyes in the measure site, such as nail polish.
- Environmental conditions:
 - ◆ Excessive ambient light

- ◆ Electrosurgery equipment
- ◆ Defibrillation (may cause inaccurate reading for a short amount of time)
- ◆ Excessive patient/sensor motion
- ◆ Electromagnetic field
- ◆ Arterial catheters and intra-aortic balloon
- Others
 - ◆ Inappropriate positioning of the SpO₂ sensor, or use of incorrect SpO₂ sensor
 - ◆ Cuff or arterial blood pressure measurement device on the same limb as the SpO₂ sensor.

11.4 SpO₂ Display

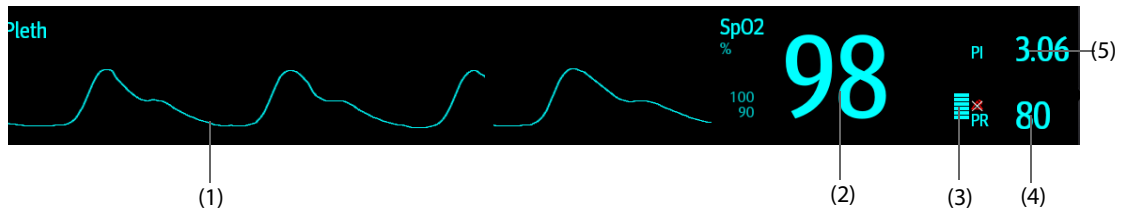

- (1) Pleth waveform (Pleth): visual indication of patient's pulse. The waveform is not normalized.
- (2) Oxygen saturation of arterial blood (SpO₂): percentage of oxygenated hemoglobin in relation to the sum of oxyhemoglobin and deoxyhemoglobin.
- (3) Perfusion indicator: the pulsatile portion of the measured signal caused by arterial pulsation.
- (4) Pulse rate (derived from the pleth wave): detected pulsations per minute.
- (5) Perfusion index (PI): gives the numerical value for the pulsatile portion of the measured signal caused by arterial pulsation. PI is an indicator of the pulsatile strength. You can also use it to assess the SpO₂ signal strength.
 - ◆ Above 1 is optimal.
 - ◆ Between 0.3 and 1 is acceptable.
 - ◆ Below 0.3 indicates low perfusion. Set **Sensitivity to Maximum** first. Reposition the SpO₂ sensor or find a better site. If low perfusion persists, choose another method to measure oxygen saturation if possible.

NOTE

- **PI is only available for Mindray SpO₂ and Masimo SpO₂.**

11.5 Preparing for SpO₂ Monitoring

To prepare to monitor SpO₂, follow this procedure:

1. Select an appropriate sensor according to the module type, patient category and weight.
2. Clean the contact surface of the reusable sensor.
3. Remove colored nail polish from the application site.
4. Apply the sensor to the patient according to the instruction for use of the sensor.
5. Select an appropriate extension cable according to the connector type and plug the cable into the SpO₂ connector.
6. Connect the sensor to the extension cable.

CAUTION

- **Do not apply sensor too tightly as this results in venous pulsation which may severely obstruct circulation and lead to inaccurate measurements.**

- **At elevated ambient temperatures be careful with measurement sites that are not well perfused, because this can cause burns after prolonged application.**
 - **Avoid placing the sensor on extremities with an arterial catheter, an NBP cuff or an intravascular venous infusion line.**
 - **For neonatal patients, make sure that all sensor connectors and adapter cable connectors are outside the incubator. The humid atmosphere inside can cause inaccurate measurements.**
-

11.6 Changing the SpO₂ Settings

11.6.1 Changing the SpO₂ Alarm Settings

To change the SpO₂ alarm settings, follow this procedure:

1. Select the SpO₂ numeric area or waveform area to enter the **SpO2** menu.
2. Select the **Alarm** tab.
3. Enter the password if required. For more information, refer to *6.9.3 Selecting Password for User Authentication*.
4. Set the alarm properties of SpO₂ and SpO₂ Desat.

NOTE

- **You can switch off the SpO2 Desat alarm only when SpO2 Desat Alarm Off is enabled. For more information, see section 7.6.9 Setting the Switch of the SpO₂ Desat Alarm Off.**
-

11.6.2 Nellcor Sat-Seconds Alarm Management

With traditional alarm management, high and low alarm limits are set for monitoring oxygen saturation. During monitoring, once an alarm limit is violated, an audible alarm immediately sounds. When the patient SpO₂ fluctuates near an alarm limit, the alarm sounds each time the limit is violated. Such frequent alarms can be distracting. Nellcor's Sat-Seconds alarm management technique is used to reduce these nuisance alarms.

The Sat-Seconds feature is available with the Nellcor SpO₂ to decrease the likelihood of false alarms caused by motion artifacts. With Sat-Seconds alarm management, high and low alarm limits are set in the same way as those with traditional alarm management. A Sat-Seconds limit is also set. The Sat-Seconds limit controls the amount of time that SpO₂ saturation may be outside the set limits before an alarm sounds.

The method of calculation is as follows: the percentage points of the SpO₂ saturation falling outside the alarm limit is multiplied by the number of seconds remaining outside the limit. This can be stated as the equation:

$$\text{Sat-Seconds} = \text{Points} \times \text{Seconds}$$

Only when the Sat-Seconds limit is reached, the monitor gives a Sat-Seconds alarm. For example, the figure below demonstrates the alarm response time with a Sat-Seconds limit set at 50 and a low SpO₂ limit set at 90%. In this example, the patient SpO₂ drops to 88% (2 points) and remains there for 2 seconds. Then it drops to 86% (4 points) for 3 seconds, and then to 84% (6 points) for 6 seconds. The resulting Sat-Seconds are:

% SpO ₂	Seconds	Sat-Seconds
2×	2=	4
4×	3=	12
6×	6=	36
Total Sat-Seconds=		52

After approximately 10.9 seconds, a Sat-Second alarm would sound, because the limit of 50 Sat-Seconds would have been exceeded.

Saturation levels may fluctuate rather than remaining steady for a period of several seconds. Often, the patient SpO₂ may fluctuate above and below an alarm limit, re-entering the non-alarm range several times. During such

fluctuation, the monitor integrates the number of SpO₂ points, both positive and negative, until either the Sat-Seconds limit is reached, or the patient SpO₂ re-enters the non-alarm range and remains there.

NOTE

- **The SpO₂ Too Low or SpO₂ Too High alarm is presented in the case that SpO₂ value violates the alarm limits for 3 times within one minute even if the setting of Sat-Seconds is not reached.**
-

11.6.3 Setting the Nellcor SpO₂ Sat-Seconds

To set the Sat-Seconds, follow this procedure:

1. Select the SpO₂ numeric area or waveform area to enter the **SpO2** menu.
2. Select the **Alarm** tab.
3. Set **Sat-Seconds**.

11.6.4 Setting SpO₂ Sensitivity (for Masimo SpO₂ Module)

For Masimo SpO₂ module, selects the **Sensitivity** as per signal quality and patient motion.

Normal Sensitivity is the recommended for patients who are experiencing some compromise in blood flow or perfusion. It is advisable for care areas where patients are observed frequently, such as the intensive care unit (ICU).

Adaptive Probe Off Detection (APOD) Sensitivity is the recommended sensitivity mode where there is a high probability of the sensor becoming detached. It is also the suggested mode for care areas where patients are not visually monitored continuously. This mode delivers enhanced protection against erroneous pulse rate and arterial oxygen saturation readings when a sensor becomes inadvertently detached from a patient due to excessive movement.

Maximum Sensitivity is recommended for use on patients with weak signals (e.g. high ambient noise and/or patients with very low perfusion) and for use during procedures or when clinician and patient contact is continuous such as in higher acuity settings.

To set SpO₂ sensitivity, follow this procedure:

1. Select the SpO₂ numeric area or waveform area to enter the **SpO2** menu.
2. Select the **SpO2 Setup** tab.
3. Set **Sensitivity**.

CAUTION

- **When using the Maximum Sensitivity setting, performance of "Sensor Off" detection may be compromised. If the equipment and the sensor becomes detached from the patient, the potential for false readings may occur due to environmental noise such as light, vibration, and excessive air movement.**
-

11.6.5 Enabling FastSAT (for Masimo SpO₂)

FastSAT enables rapid tracking of arterial oxygen saturation changes as may be required in urgent situations. When FastSAT is switched on, the averaging algorithm evaluates all the SpO₂ values and provides an averaged SpO₂ value that is a better representation of the patient's current oxygen saturation status.

The reliability of FastSAT is dependent on the setting for the averaging time and the input signal. FastSAT is disabled by default. To enable FastSAT, follow this procedure:

1. Select the SpO₂ numeric area or waveform area to enter the **SpO2** menu.
2. Select the **Setup** tab.
3. Switch on **FastSAT**.

11.6.6 **Displaying SIQ (for Masimo SpO₂)**

The signal quality indicator (SIQ) displays below the Pleth waveform. The SIQ is conveyed by vertical bars. The height of the bar provides an assessment of the confidence in the displayed SpO₂ value. The SpO₂ SIQ can also be used to identify the occurrence of a patient's pulse.

The following picture shows the SpO₂ SIQ:

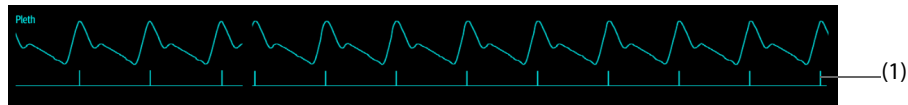

(1) Signal quality indicator (SIQ)

To show SpO₂ SIQ, follow this procedure:

1. Select the SpO₂ numeric area or waveform area to enter the **SpO2** menu.
2. Select the **Setup** tab.
3. Switch on **Display SIQ**.

11.6.7 **Changing the Sensitivity**

The SpO₂ value displayed on the monitor screen is the average of data collected within a specific time. The shorter the averaging time is, the quicker the monitor responds to changes in the patient's oxygen saturation level. Contrarily, the longer the averaging time is, the slower the monitor responds to changes in the patient's oxygen saturation level, but the SpO₂ measurement is more stable. For critically ill patients, selecting shorter averaging time will help understanding the patient's state.

To set the averaging time, follow this procedure:

1. Select the SpO₂ numeric area or waveform area to enter the **SpO2** menu.
2. Select the **SpO2 Setup** tab.
3. Set **Averaging** for Masimo SpO₂ module, and **Sensitivity** for Mindray SpO₂ module.

11.6.8 **Monitoring SpO₂ and NIBP Simultaneously**

When monitoring SpO₂ and NIBP on the same limb simultaneously, you can switch on **NIBP Simul** to lock the SpO₂ alarm status until the NIBP measurement ends. If you switch off **NIBP Simul**, low perfusion caused by NIBP measurement may lead to inaccurate SpO₂ readings and therefore cause false physiological alarms.

To set the **NIBP Simul**, follow this procedure:

1. Select the SpO₂ numeric area or waveform area to enter the **SpO2** menu.
2. Select the **Alarm** tab.
3. Select **SpO2** tab.
4. Set **NIBP Simul**.

11.6.9 **Changing the Sweep Speed of the Pleth Wave**

To set the sweep speed of Pleth waveforms, follow this procedure:

1. Select the SpO₂ numeric area or waveform area to enter the **SpO2** menu.
2. Select the **SpO2 Setup** tab.
3. Set **Speed**.

11.6.10 **Setting the Alarm Priority for SpO₂ Sensor Off Alarm**

To set the alarm level for SpO₂ sensor off alarm, follow this procedure:

1. Select the **Main Menu** quick key → from the **System** column select **Maintenance** → input the required password → select **↵**.
2. Select the **Alarm** tab → select the **Other** tab.

3. Set **SpO2 Sensor Off**.

11.6.11 Setting the SpO₂ Tone Mode

The monitor adjusts the QRS tone (pitch tone) according to the SpO₂ values. To set the SpO₂ tone mode, follow this procedure:

1. Select the **Main Menu** quick key → from the **System** column select **Maintenance** → input the required password → select .
2. Select the **Other** tab.
3. Set **SpO2 Tone**.

CAUTION

- **The same SpO₂ tone mode shall be used for the same monitors in a single area.**
-

11.7 Changing the PR Settings

11.7.1 Changing the PR Alarm Settings

To change the PR alarm settings, follow this procedure:

1. Select the SpO₂ numeric area or waveform area to enter the **SpO2** menu.
2. Select the **PR Alarm** tab.
3. Set the alarm properties of PR.

11.7.2 Changing the QRS Volume

If the **Alarm Source** is set to **PR**, the QRS tone is derived from PR measurements. To set the QRS volume, follow this procedure:

1. Select the SpO₂ numeric area or waveform area to enter the **SpO2** menu.
2. Select the **PR Setup** tab.
3. Set **QRS Volume**.

If the SpO₂ value is effective, the monitor also adjusts the QRS tone (pitch tone) according to the SpO₂ value. For information, see *11.6.11 Setting the SpO₂ Tone Mode*.

11.7.3 Setting the PR Source

Current pulse source is displayed in the PR numeric area. The PR from current pulse source has the following characteristics:

- PR is monitored as system pulse and generates alarms when you select PR as the active alarm source.
- PR is stored in the monitor's database and reviewed in the graphic/tabular trends; in trend graphs, as the PR curve is in the same color with that of the PR source, it is unlikely to distinguish the PR source.
- PR is sent via the network to the CMS, if available.

To set which pulse rate as PR source, follow this procedure:

1. Select the SpO₂ numeric area or waveform area to enter the **SpO2** menu.
2. Select the **PR Setup** tab.
3. Set **PR Source**.

The **PR Source** menu displays the currently available PR sources from top to bottom by priority. When you select **Auto**, the system will automatically select the first option as the PR source. If the current PR source is unavailable, the system will automatically switch **PR Source** to **Auto**. When you select **IBP**, the system will automatically select the first pressure label as the PR source.

11.8 SpO₂ Troubleshooting

This section lists the problems that might occur. If you encounter the problems when using the equipment or accessories, check the table below before requesting for services. If the problem persists, contact your service personnel.

NOTE

- For the physiological and technical alarm messages, see *D Alarm Messages*.

Problem	Solution
Do not see SpO ₂ numeric area or waveform area on the main screen	<ol style="list-style-type: none"> 1. Check that the SpO₂ is set to display in the Screen Setup menu. For more information, see 3.11.2 <i>Displaying Parameter Numerics and Waveforms</i>. 2. Check that if the SpO₂ parameter switch is enabled. If not, enable the SpO₂ measurement. For more information, see 3.11.1 <i>Switching On or Off a Parameter</i>. 3. Check that the cable connections of SpO₂ sensor and the extension cable are tight. Replace the SpO₂ sensor or the extension cable if needed.
Dashes "--" display in place of numerics.	<ol style="list-style-type: none"> 1. Check that the cable connections of SpO₂ sensor and the extension cable are tight. Replace the SpO₂ sensor or the extension cable if needed. 2. Reconnect the SpO₂ sensor if the alarm SpO2 Sensor Off appears. 3. Check the PI value. If the PI value is too low, adjust the SpO₂ sensor, or apply the sensor to the site with better perfusion. 4. Move the sensor to the place with weaker light, or cover the sensor with shade cloth if the alarm SpO2 Sensor Off appears.
Low amplitude SpO ₂ signal	<ol style="list-style-type: none"> 1. The SpO₂ sensor and NIBP cuff are placed on the same limb. Change a monitoring site if necessary. 2. Check the PI value. If the PI value is too low. Adjust the SpO₂ sensor, or apply the sensor to the site with better perfusion. 3. Check the sensor and its application site.
SpO ₂ value is inaccurate	<ol style="list-style-type: none"> 1. Check the patient's vital signs. 2. Check for conditions that may cause inaccurate SpO₂ readings. For more information, see 11.3 <i>SpO₂ Measurement Limitations</i>. 3. Check the monitor, the SpO₂ sensor for proper functioning.

11.9 Nellcor Information



■ Nellcor Patents

This device may be covered by one or more of the following US patents and foreign equivalents: 5,485,847, 5,676,141, 5,743,263, 6,035,223, 6,226,539, 6,411,833, 6,463,310, 6,591,123, 6,708,049, 7,016,715, 7,039,538, 7,120,479, 7,120,480, 7,142,142, 7,162,288, 7,190,985, 7,194,293, 7,209,774, 7,212,847, 7,400,919.

■ No Implied License

Possession or purchase of this device does not convey any express or implied license to use the device with unauthorized replacement parts which would, alone, or in combination with this device, fall within the scope of one or more of the patents relating to this device.

11.9.1 Masimo Information



- Masimo Patents

This posting serves as notice under 35 U.S.C. §287(a) for Masimo patents: <http://www.masimo.com/patents.htm>.

- No Implied License

Possession or purchase of this device does not convey any express or implied license to use the device with unauthorized sensors or cables which would, alone, or in combination with this device, fall within the scope of one or more of the patents relating to this device.

12 Monitoring Temperature (Temp)

12.1 Temperature Introduction

You can continuously monitor the patient's skin temperature and core temperature by the monitor. Thermally sensitive resistors (thermistors) are used. They are based on the principle that electrical resistance of the thermistor changes as temperature changes. Thermistors measure the resistance change and use it to calculate the temperature.

You can simultaneously monitor up to two temperature sites and calculate the difference between two measured sites.

Temperature monitoring is intended for adult, pediatric and neonatal patients.

12.2 Displaying the Temp Numerics Area

To display the Temp numerics area, follow this procedure:

1. Access **Tile Layout** in either of the following ways:
 - ◆ Select the **Screen Setup** quick key → select the **Tile Layout** tab.
 - ◆ Select the **Main Menu** quick key → from the **Display** column select **Tile Layout**.
2. Select a parameter numeric area or waveform area, and then from the popup list select **Temp**.

12.3 Temperature Display

The following figure shows the Temp numeric area for temperature monitoring with the monitor. Your display may be configured to look different.

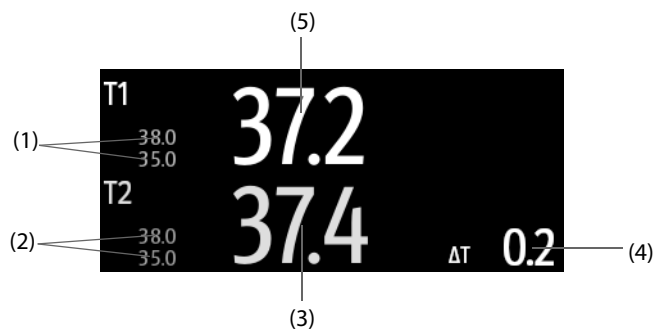

(1) T1 alarm limits

(2) T2 alarm limits

(3) T2 temperature value

(4) Temperature difference (ΔT): Difference between two temperature sites. It displays only when ΔT is switched on.

(5) T1 temperature value

12.4 Preparing for Temperature Monitoring

To prepare temperature monitoring, follow this procedure:

1. Select an appropriate probe for your patient according to patient category and measured site.
2. Plug the probe or temperature cable to the temperature connector. If you are using a disposable probe, connect the probe to the temperature cable.
3. Follow the probe manufacturer's instructions to connect the probe to the patient.

12.5 Changing Temperature Settings

12.5.1 Setting the Temperature Alarm Properties

To set the temperature alarm properties, follow this procedure:

1. Select the temperature numeric area to enter the **Temp** menu.
2. Select the **Alarm** tab.
3. Enter the password if required. For more information, refer to 6.9.3 *Selecting Password for User Authentication*.
4. Set the alarm properties.

12.5.2 Selecting the Temperature Label

Select the temperature label according to the measurement site. To do so, follow this procedure:

1. Select the temperature numeric area to enter the **Temp** menu.
2. Select the **Setup** tab.
3. Set the temperature label.

12.5.3 Displaying the Temperature Difference

To display the temperature difference between two measurement sites monitored by the same temperature module, switch on corresponding ΔT . To do so, follow this procedure:

1. Select the temperature numeric area to enter the **Temp** menu.
2. Select the **Setup** tab.
3. Switch on ΔT .

12.6 Temperature Troubleshooting

This section lists the problems that might occur. If you encounter the problems when using the equipment or accessories, check the table below before requesting for services. If the problem persists, contact your service personnel.

NOTE

- For the physiological and technical alarm messages, see *D Alarm Messages*.

Problem	Solution
Do not see Temp numeric area on the main screen	<ol style="list-style-type: none">1. Check that the Temp is set to display in the Screen Setup menu. For more information, see 3.11.2 <i>Displaying Parameter Numerics and Waveforms</i>.2. Check that if the Temp parameter switch is enabled. If not, enable the Temp measurement. For more information, see 3.11.1 <i>Switching On or Off a Parameter</i>.3. Check that the connections of the temperature probe and the temperature cable are tight.
Measurement fails/'--' is displayed in the Temp numeric area	<ol style="list-style-type: none">1. If you are using a disposable probe, check the connection between the probe and the temperature cable.2. Try using a known good probe in case the sensor is damaged.
The tympanic thermometer display is frozen.	Install or remove the probe cover to activate the thermometer.

13 Monitoring Noninvasive Blood Pressure (NIBP)

13.1 NIBP Introduction

The monitor uses the oscillometric method for measuring the non-invasive blood pressure (NIBP). NIBP measurement is based on the principle that pulsatile blood flow through an artery creates oscillations of the arterial wall. The oscillometric device uses a blood pressure cuff to sense these oscillations that appear as tiny pulsations in cuff pressure. The Oscillometric devices measure the amplitude of pressure changes in the occluding cuff as the cuff deflates from above systolic pressure. The amplitude suddenly increases as the pulse breaks through the occlusion in the artery. As the cuff pressure decreases further, the pulsations increase in amplitude, reach a maximum (which approximates to the mean pressure), and then diminish. The oscillometric method measures the mean pressure and determines the systolic and diastolic pressures.

NIBP monitoring is intended for adult, pediatric, and neonatal patients.

NOTE

- **Blood pressure measurements determined with this device are equivalent to those obtained by a trained observer using the cuff/stethoscope auscultatory method or an intra-arterial blood pressure measurement device, within the limits prescribed by the American National Standard: manual, electronic, or automated sphygmomanometers.**
 - **NIBP measurement can be performed during electro-surgery and discharge of defibrillator.**
-

13.2 NIBP Safety Information

WARNING

- **Be sure to select the correct patient category setting for your patient before NIBP measurement. Do not apply the higher adult settings for pediatric or neonatal patients. Otherwise, it may present a safety hazard.**
 - **Do not measure NIBP on patients with sickle-cell disease or on the limb where skin damage has occurred or is expected.**
 - **Use clinical judgment to determine whether to perform frequent unattended blood pressure measurements on patients with severe blood clotting disorders because of the risk of hematoma in the limb fitted with the cuff.**
 - **Do not use the NIBP cuff on a limb with an intravenous infusion or arterial catheter in place. This could cause tissue damage around the catheter when the infusion is slowed or blocked during cuff inflation.**
 - **Do not apply cuff on the arm on the side of a mastectomy.**
 - **Continuous cuff pressure due to connection tubing kinking may cause blood flow interference, and resulting in harmful injury to the patient.**
 - **NIBP reading can be affected by the measurement site, the position of the patient, exercise, or the patient's physiologic condition. If you doubt the NIBP measurements, determine the patient's vital signs by alternative means, and then verify that the monitor is working correctly.**
 - **Devices that exert pressure on tissue have been associated with purpura, ischemia, and neuropathy. Inspect the application site regularly to ensure skin quality and inspect the extremity of the cuffed limb for normal color, warmth and sensitivity. If the skin quality changes, or if the extremity circulation is being affected, move the cuff to another site or stop the blood pressure measurements immediately. Check more frequently when making automatic or STAT measurements. Auto NIBP measurements with one and two minute intervals are not recommended for extended periods of time.**
 - **NIBP diagnostic significance must be decided by the physician.**
-

CAUTION

- Only use parts and accessories specified in this manual. Follow the instructions for use and adhere to all warnings and cautions.
 - Accuracy of NIBP measurement depends on using a cuff of proper size. It is essential to measure limb circumference and choose a cuff with proper size.
-

13.3 NIBP Measurement Limitations

Measurements are impossible with heart rate extremes of less than 30 bpm or greater than 300 bpm, or if the patient is on a heart-lung machine. The measurement may be inaccurate or impossible in the following situations:

- Regular arterial pressure pulses are hard to detect
- With excessive and continuous patient movement such as shivering or convulsions
- With cardiac arrhythmias
- With rapid blood pressure changes
- With severe shock or hypothermia that reduces blood flow to the peripheries
- On an edematous extremity.

NOTE

- The effectiveness of this sphygmomanometer has not been established in pregnant, including pre-eclamptic patients.
-

13.4 Measurement Modes

There are three NIBP measurement modes:

- Manual: measurement on demand.
- Auto: repeated measurements at set interval.
- STAT: continually rapid series of measurements over a five minute period.
- Sequence: continually automatic measurement at set durations and intervals.

13.5 NIBP Display

The NIBP display shows only numerics.

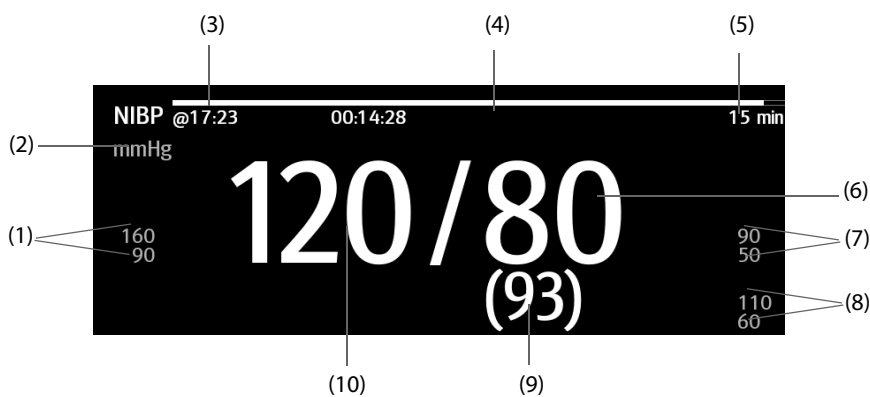

(1) Systolic pressure alarm limits

(2) NIBP unit: mmHg or kPa

(3) The last NIBP measurement time

(4) Time to the next measurement (for Auto mode and Sequence mode)

(5) Measurement mode: for Auto NIBP, interval is displayed; for Sequence mode, the current phase and interval are displayed

(6) Diastolic pressure

(7) Diastolic pressure alarm limit

(8) Mean pressure alarm limit

(9) Mean pressure (displayed after measurement completed) or cuff pressure (displayed during the measurement)

(10) Systolic pressure

NOTE

- **If NIBP measurement fails, "XX" is displayed; if NIBP measurement is not taken, "--" is displayed.**
 - **Outlined NIBP numerics indicate that the measurement is old and exceeds the set time. So these NIBP values are not recommended for reference.**
-

13.6 Preparing for NIBP Measurements

13.6.1 Preparing the Patient for NIBP Measurements

In normal use, perform NIBP measurement on a patient who is in the following position:

- Comfortably seated
- Legs uncrossed
- Feet flat on the floor
- Back, arm and feet supported

NOTE

- **It is recommended that the patient calms down and relaxes as much as possible before performing the measurement and that the patient do not talk during the measurement.**
 - **It is recommended to have the patient sat quietly for several minutes before taking the measurement.**
 - **Other factors that have been shown to result in an overestimation of blood pressure are labored breathing, full bladder, pain etc.**
-

13.6.2 Placing the NIBP Cuff

To place the NIBP cuff, follow this procedure:

1. Verify that the patient category setting is correct.
2. Connect the air tubing to the NIBP connector on the monitor.
3. Select an appropriately sized cuff for the patient, and then wrap it around the limb directly over the patient's skin as follows:
 - a Determine the patient's limb circumference.
 - b Select an appropriate cuff by referring to the limb circumference marked on the cuff. The width of the cuff should be 40% (50% for neonates) of the limb circumference, or 2/3 of the length of the upper arm or the thigh. The inflatable part of the cuff should be long enough to encircle at least 50% to 80% of the limb.
 - c Apply the cuff to the patient's upper arm or leg and make sure the Φ marking on the cuff matches the artery location. The cuff should fit snugly, but with enough room for two fingers to be placed between the cuff and the patient's arm (on adults), and loosely on neonates with little or no air present within the cuff. Otherwise it may cause discoloration and ischemia of the extremities. Make sure that the cuff index line falls within the range markings on the cuff.
 - d Middle of the cuff should be at the level of the right atrium of the heart. If it is not, you must use the measurement correction formula to correct the measurement. For more information, see *13.8.9 Correcting the NIBP Measurements*.







- Connect the cuff to the air tubing. Avoid compression or restriction of pressure tubes. Air must pass unrestricted through the tubing.

CAUTION

- A wrong cuff size and a folded or twisted bladder can cause inaccurate measurements.**
 - Do not touch or apply external pressure against the cuff and air tubing during NIBP measurement. This may cause inaccurate blood pressure values.**
 - Use care when placing the cuff on an extremity used for monitoring other patient parameters.**
-

13.7 Starting and Stopping NIBP Measurements

Start and stop NIBP measurement by selecting the NIBP quick keys or from the NIBP menu.

Task	By Quick Key	From NIBP menu
Start a manual measurement	NIBP Start/Stop quick key 	Start NIBP button
Start auto NIBP series	NIBP Start/Stop quick key  Make sure to set the Interval before starting the auto NIBP.	Setup tab → set Interval → Start NIBP button
	NIBP Measure quick key  → select interval	
Start NIBP sequence measurement	NIBP Measure quick key  → Sequence	Sequence tab → set NIBP sequence → Start NIBP button
Start STAT measurement	NIBP Measure quick key  → STAT	STAT button
Stop the current NIBP measurements	NIBP Start/Stop quick key 	Stop NIBP button
End auto NIBP series or NIBP Sequence	/	Stop All button
Stop STAT measurement and end series	NIBP Start/Stop quick key 	Stop NIBP or Stop All button

13.8 Changing NIBP Settings

13.8.1 Setting the NIBP Alarm Properties

To set the NIBP alarm properties, follow this procedure:

- Select the NIBP numeric area to enter the **NIBP** menu.
- Select the **Alarm** tab.
- Enter the password if required. For more information, refer to *6.9.3 Selecting Password for User Authentication*.
- Set alarm properties as desired.

13.8.2 Setting the Initial Cuff Inflation Pressure

To set initial cuff inflation pressure, follow this procedure:

- Select the NIBP numeric area to enter the **NIBP** menu.

2. Select **Initial Pressure**, and then select the appropriate setting.

13.8.3 Setting the NIBP Interval

For auto NIBP measurement, you need to set the interval between two NIBP measurements. To set the NIBP interval, follow this procedure:

1. Select the NIBP numeric area to enter the **NIBP** menu.
2. Set **Interval**. Selecting **Manual** switches to manual mode.

13.8.4 Selecting NIBP Start Mode

Start mode defines how NIBP auto mode works. To set the start mode, follow this procedure:

1. Select the NIBP numeric area to enter the **NIBP** menu.
2. Set **Start Mode**.
 - ◆ **Clock**: after the first measurement, the monitor automatically synchronizes NIBP automatic measurements with the real time clock. For example, if **Interval** is set to **20 min**, and you start NIBP auto measurement at 14:03, the next measurement will be taken at 14:20, and then at 14:40, 15:00, and so on.
 - ◆ **Interval**: after the first measurement, the monitor automatically repeats measurements at set interval. For example, if **Interval** is set to **20 min**, and you start NIBP auto measurement at 14:03, the next measurement will be taken at 14:23, and then at 14:43, 15:03, and so on.

13.8.5 Enabling the NIBP End Tone

The monitor can issue a reminder tone at the completion of NIBP measurement. The NIBP End Tone is off by default. To switch on the NIBP end tone, follow this procedure:

1. Select the NIBP numeric area to enter the **NIBP** menu.
2. Switch on **NIBP End Tone**.

13.8.6 Setting NIBP Sequence

NIBP sequence measurement can have up to five phases: A, B, C, D, and E. You can individually set the duration and interval of each phase.

To set NIBP sequence, follow this procedure:

1. Select the NIBP numeric area to enter the **NIBP** menu.
2. Select the **Sequence** tab.
3. Set **Duration** and **Interval** of each phase.

13.8.7 Setting NIBP Measurement Timeout

NIBP measurements become outline fonts after a preset time. This avoids older NIBP values being misinterpreted as current measurements. To set the timeout period, follow this procedure:

1. Select the **Main Menu** quick key → from the **System** column select **Maintenance** → input the required password → select .
2. Select the **Module** tab → select **Other**.
3. Set **NIBP Timeout**.

13.8.8 Displaying the NIBP List

To display multiple sets of the most recent NIBP measurements, follow this procedure:

1. Access **Tile Layout** by either of the following ways:
 - ◆ Select the **Screen Setup** quick key → select the **Tile Layout** tab.

- ◆ Select **Main Menu** quick key → from the **Display** column select **Tile Layout**.
- 2. In the desired numeric area, select **NIBP** → **NIBP List**.

13.8.9 Correcting the NIBP Measurements

The middle of the cuff should be at the level of right atrium. If the limb is not at the heart level, you need to correct the measurement:

- Add 0.75 mmHg (0.10 kPa) to the displayed value for each centimetre higher.
- Deduct 0.75 mmHg (0.10 kPa) to the displayed value for each centimeter lower.

13.9 Assisting Venous Puncture

You can use the NIBP cuff to cause sub-diastolic pressure to block the venous blood vessel and therefore help venous puncture. To assist venous puncture, follow this procedure:

1. Select the NIBP numeric area → **Setup** tab.
2. Set **Venipuncture pressure**.
3. Select **VeniPuncture** at the bottom of the menu.
4. Puncture vein and draw blood sample.
5. Select the **NIBP Start/Stop** quick key to deflate the cuff. If you do not deflate the cuff, the cuff automatically deflates after a period of time (170 seconds for adult and pediatric patient, 85 seconds for neonatal patient).

During venous puncture, pay attention to the cuff pressure and the remaining time displayed in the NIBP numerics area.

13.10 NIBP Maintenance

13.10.1 NIBP Leakage Test

The NIBP leakage test checks the integrity of the system and of the valve. The NIBP leakage test should be performed once every two years or when you doubt the NIBP measurements. The NIBP leakage test should be performed by Mindray-qualified service personnel only.

13.10.2 NIBP Accuracy Test

The NIBP accuracy test should be performed once every two years or when you doubt the NIBP measurements. The NIBP accuracy test should be performed by Mindray-qualified service personnel only.

13.11 NIBP Troubleshooting

For more information, see *D Alarm Messages*.

14 Monitoring Invasive Blood Pressure (IBP)

14.1 IBP Introduction

This patient monitor can monitor up to four invasive blood pressures.

IBP monitoring is intended for adult, pediatric, and neonatal patients. PAWP monitoring is available only for the external display. PAWP monitoring is only intended for adult and pediatric patients.

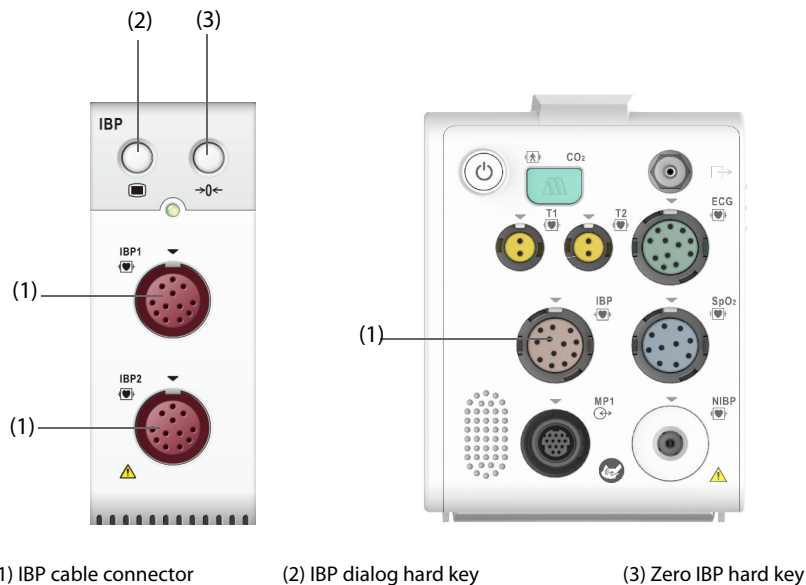

WARNING

- **The IBP module cannot be used for transport outside the hospital environment.**

14.2 IBP Safety Information

WARNING

- **Use only pressure transducers specified in this manual. Never reuse disposable pressure transducers.**
- **Make sure that the applied parts never contact other conductive parts.**
- **To reduce the hazard of burns during high-frequency surgical procedure, ensure that the monitor's cables and transducers never come into contact with the high-frequency surgical units.**
- **When using accessories, their operating temperature should be taken into consideration. For more information, see instructions for use of accessories.**
- **All invasive procedures involve risks to the patient. Use aseptic technique. Follow catheter manufacturer's instructions.**
- **Mechanical shock to the invasive blood pressure transducer may cause severe shifts in zero balance and calibration, and cause erroneous readings.**

14.3 Preparing for IBP Monitoring

14.3.1 IBP Equipment to Patient Connection

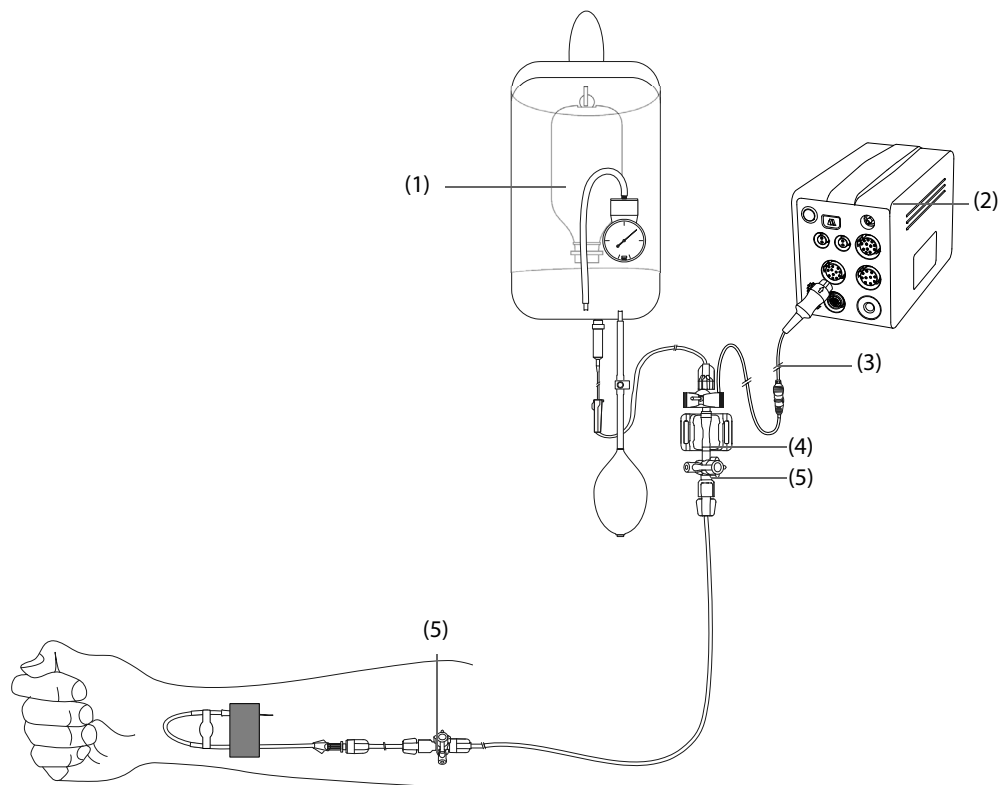

(1) Pressure bag

(2) N1 monitor

(3) IBP cable

(4) IBP transducer

(5) Three-way valve

14.3.2 Measuring an Invasive Blood Pressure

To monitor IBP, follow this procedure:

1. Connect one end of the IBP cable to the IBP cable connector on the monitor, and the other end to the IBP transducer.
2. Flush the IBP transducer system to exhaust all air from the tubing according to the manufacturer's instructions. Ensure that the system is free of air bubbles.
3. Connect the IBP transducer to the patient, making sure that the transducer is at the same horizontal level as the heart.
4. Select the proper pressure label for currently measured pressure. For more information, see [14.6.2 Changing the Pressure Label](#).
5. Zero the IBP transducer. For more information, see [14.3.3 Zeroing the IBP transducer](#). After a successful zeroing, turn off the stopcock to the air and turn on the stopcock to the patient.

CAUTION

- **If you need to measure two invasive blood pressures, you can use the IBP extension cable with dual-receptacle (PN: 040-001029-00) instead of the IBP cable.**
 - **Make sure that all the transducers are zeroed correctly before the IBP measure.**
 - **Make sure that no air bubble exists in the IBP transducer system before the IBP measure.**
 - **If measuring intracranial pressure (ICP) with a sitting patient, level the transducer with the top of the patient's ear. Incorrect leveling may give incorrect values(not applicable if measuring ICP with the Codman ICP transducer).**
-

14.3.3 Zeroing the IBP transducer

To avoid inaccurate pressure readings, the monitor requires a valid zero. Zero the transducer in accordance with your hospital policy. The IBP transducer should be zeroed in the following conditions:

- The IBP transducer or adapter cable is reconnected.
- The monitor restarts.
- You doubt the readings.
- The monitor displays the prompt message **Zero Required**.

To zero the transducer, follow this procedure:

1. Connect the IBP transducer, the IBP adapter cable and the monitor.
2. Turn off the three-way valve (the one near the transducer) to the patient, in order to vent the transducer to the atmospheric pressure.
3. Select the numeric area (such as the Art numeric area), and then select **Zero** button.
4. After the zero calibration is completed, close the stopcock to the air and open the stopcock to the patient.

Zero calibration may fail in case of pressure fluctuation or pressure exceeding the calibration range. If zero calibration fails, follow this procedure:

1. Check that the three-way valve (the one near the transducer) is open to the air.
2. Perform zero calibration again. Do not sway the IBP transducer and tubing during zero calibration.

14.4 Measuring ICP Using the Codman ICP Transducer

14.4.1 Zeroing the Codman ICP transducer

You shall zero the Codman ICP transducer (Model: 82-6653) before use. To zero the ICP transducer, follow this procedure:

1. Connect the ICP transducer, the ICP adapter cable and the monitor.
2. Follow the manufacturer's instructions to prepare the ICP transducer.
3. Zero the ICP transducer: when you see the message **Zero Reference** in the ICP numeric area, select the ICP waveform area or numeric area to enter the **ICP** menu → select the **Zero** tab → select the **Zero** button.
4. Record the zero reference value on the blank area of the ICP transducer for further reference.

If the ICP transducer zero calibration failed or you doubt the zero reference value, perform a zero calibration again.

14.4.2 Measuring ICP

To perform the ICP measurement, follow this procedure:

1. Zero the Codman ICP transducer. For more information, see section *14.4.1 Zeroing the Codman ICP transducer*.
2. Disconnect the ICP transducer and ICP adapter cable. Follow the manufacturer's instructions to apply the ICP transducer to the patient.
3. Reconnect the ICP transducer and ICP adapter cable.
4. Check that the zero reference value displayed on the monitor is consistent with that recorded on the ICP transducer.
 - ◆ Consistent: select **Accept**.
 - ◆ Inconsistent: input the zero reference value recorded on the ICP transducer, and select **Accept**.

If you have to transfer the patient who is taking ICP measurement, check that the target monitor supports the Codman ICP transducer. For more information, see *14.4.1 Zeroing the Codman ICP transducer*. If the target monitor does not support the Codman ICP transducer, do not use it for ICP monitoring.

Follow this procedure to transfer the patient:

1. Disconnect the ICP adapter cable from the measurement module, or remove the module from the monitor.
2. Connect the ICP adapter cable, measurement module, and the target monitor, or insert the measurement module into the target monitor.
3. Check that the zero reference value displayed on the monitor is consistent with that recorded on the ICP transducer.
 - ◆ Consistent: select **Accept**.
 - ◆ Inconsistent: input the zero reference value recorded on the ICP transducer, and select **Accept**.

CAUTION

- **If monitors of different brands are used to zero the Codman ICP transducer, the zero reference values can be different. Use a Mindray monitor to Zero the Codman ICP transducer if you will take ICP measurement using a Mindray monitor. Otherwise the ICP measurement can be inaccurate.**
-

14.5 IBP Display

The IBP measurement is displayed on the monitor as a waveform and numeric pressures. For arterial pressure, the IBP numeric area displays systolic pressure, diastolic pressure and mean pressure. For venous pressure, the IBP numeric area displays only the mean pressure. The figure below shows the waveform and numerics for the Art pressure.

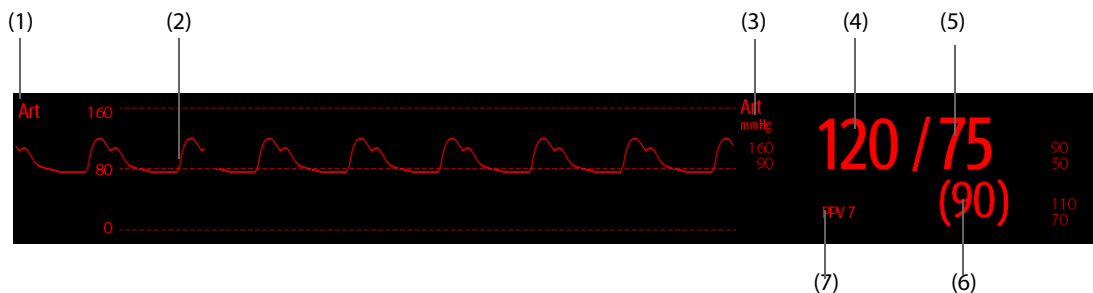

- | | | |
|-----------------------|------------------------|-------------------|
| (1) Pressure label | (2) Waveform | (3) Pressure Unit |
| (4) Systolic pressure | (5) Diastolic pressure | (6) Mean pressure |
| (7) PPV measurement | | |

14.6 Changing IBP Settings

14.6.1 Changing the IBP Alarm Settings

To change the IBP alarm settings, follow this procedure:

1. Select the IBP numeric area or waveform area to enter the corresponding pressure menu.
2. Select the **Alarm** tab.
3. Enter the password if required. For more information, refer to *6.9.3 Selecting Password for User Authentication*.
4. Set the alarm properties.

14.6.2 Changing the Pressure Label

The pressure label is a unique identifier for each type of pressure. Therefore, you should select a proper pressure label for the source of the pressure you want to monitor.

To select the pressure label, follow this procedure:

1. Select the IBP numeric area or waveform area to enter the corresponding pressure menu.
2. Select the **Setup** tab.

3. Set **IBP1 Label** or **IBP2 Label**.

Label	Description	Label	Description
PA	Pulmonary artery pressure	CVP	Central venous pressure
Ao	Aortic pressure	LAP	Left atrial pressure
UAP	Umbilical arterial pressure	RAP	Right atrial pressure
BAP	Brachial arterial pressure	ICP	Intracranial pressure
FAP	Femoral arterial pressure	UVP	Umbilical venous pressure
Art	Arterial blood pressure	LV	Left ventricular pressure
CPP	Cerebral perfusion pressure	P1 to P4	Non-specific pressure label

NOTE

- It is not allowed to select the same label for different pressures.

14.6.3 Setting the Pressure Type for Display

For the non-specific pressure (P1, P2, P3 or P4), the displayed pressure type is configurable. To set the displayed pressure type, follow this procedure:

1. Select the numeric area or waveform area of the non-specific pressure to enter the corresponding pressure menu.
2. Select the **Setup** tab.
3. Set **Measure**:
 - ◆ If this non-specific pressure is artery pressure, set the **Measure** to **All**. In this case, its corresponding numeric area displays systolic pressure, diastolic pressure and mean pressure.
 - ◆ If this non-specific pressure is venous pressure, set the **Measure** to **Mean Only**. In this case, its corresponding numeric area displays only the mean pressure.

14.6.4 Changing the Sensitivity

The IBP value displayed on the monitor screen is the average of data collected within a specific time. The shorter the averaging time is, the quicker the monitor responds to changes in the patient's blood pressure, and the higher the sensitivity. Contrarily, the longer the averaging time is, the slower the monitor responds to changes in the patient's blood pressure, the lower the sensitivity, but the measurement accuracy will be improved. For critically ill patients, selecting higher sensitivity will help understanding the patient's state.

To set the sensitivity, follow this procedure:

1. Select the IBP numeric area or waveform area to enter the corresponding pressure menu.
2. Select the **Setup** tab.
3. Set **Sensitivity**.

14.6.5 Setting the IBP Waveform

To set the IBP waveform, follow this procedure:

1. Select the IBP numeric area or waveform area to enter the corresponding pressure menu.
2. Select the **Setup** tab.
3. Set the following properties of the IBP waveform:
 - ◆ **Speed**
 - ◆ **Scale**: if **Auto** is selected, the size of the pressure's waveform will be adjusted automatically.

14.6.6 Setting the Use PA-D as PAWP Switch (only available for the independent external display)

You can set whether PA-D value is used to replace PAWP value for hemodynamic calculation. To do so, follow this procedure:

1. Select the PA numeric area or waveform area to enter the **PA** menu.
2. Select the **Setup** tab.
3. Switch on or off **Use PA-D as PAWP**.

For more information on hemodynamic calculation, see *18.4 Hemodynamic Calculations*.

14.6.7 Enabling PPV Measurement

PPV indicates pulse pressure variation. When measuring the arterial pressure (except PA), the PPV measurement is available. To enable the PPV measurement, follow this procedure:

1. Select the IBP numeric area or waveform area to enter the corresponding pressure menu.
2. Select the **PPV Setup** tab.
3. Switch on **PPV Measure**.

You can select PPV source after enabling the PPV measurement.

WARNING

- **This monitor can calculate PPV from beat-to-beat values of any arterial pulsatile pressure. The circumstances under which the calculation of a PPV value is clinically meaningful, appropriate and reliable must be determined by a physician.**
 - **The clinical value of the derived PPV information must be determined by a physician. According to recent scientific literature, the clinical relevance of PPV information is restricted to sedated patients receiving controlled mechanical ventilation and mainly free from cardiac arrhythmia.**
 - **PPV calculation may lead to inaccurate values in the following situations:**
 - ◆ at respiration rates below 8 rpm
 - ◆ during ventilation with tidal volumes lower than 8 ml/kg
 - ◆ for patients with acute right ventricular dysfunction (“corpulmonale”).
 - **The PPV measurement has been validated only for adult patients.**
-

14.6.8 Changing the Pressure Unit

To change the pressure unit, follow this procedure:

1. Select the **Main Menu** quick key → from the **System** column select **Maintenance** → input the required password → select .
2. Select the **Unit** tab.
3. Set **Pressure Unit**, **CVP Unit** or **ICP Unit**.

14.6.9 Overlapping IBP Waveforms

The IBP waveforms can be displayed together. To combine IBP waveforms, follow this procedure:

1. Access **Tile Layout** by either of the following ways:
 - ◆ Select the **Screen Setup** quick key → select the **Tile Layout** tab.
 - ◆ Select **Main Menu** quick key → from the **Display** column select **Tile Layout**.
2. Select the waveform area where you want to display the overlapped IBP waveforms, and then select the IBP waves to be overlapped on the left side of the same line.
3. Repeat step 2 in another waveform area if needed.
4. Select  to save the setting and exit the window. The main screen will display the overlapped IBP waves.

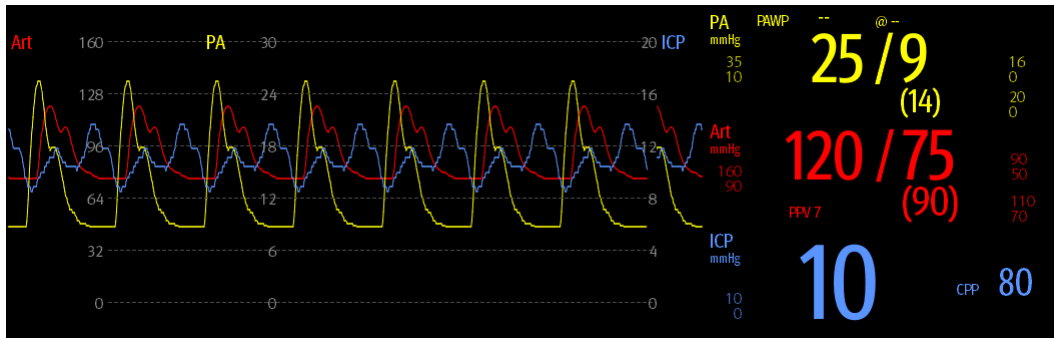

Selecting the overlapped IBP waveforms on the main screen opens the **Overlapping Waveform Setup** menu, where you can make the following settings:

- Scale
 - ◆ Set **Left Scale** for the arterial pressure.
 - ◆ Set **Right Scale** for the venous pressure.
 - ◆ Set **CVP Scale** individually if the CVP waveform is combined and CVP unit is different from IBP unit.
 - ◆ Set **ICP Scale** individually if the ICP waveform is combined and ICP unit is different from IBP unit.
 - ◆ Set **PA Scale** individually if the PA waveform is combined.
- Switch on or off **Gridlines** to show or hide gridlines in the overlapped waveform area.
- Set **Speed** for the overlapped waveforms.

NOTE

- **The unit of CVP scale is consistent with CVP parameter unit.**

14.7 Measuring PAWP (only available for the independent external display)

Pulmonary Artery Wedge Pressure (PAWP) values, used to assess cardiac function, are affected by fluid status, myocardial contractility, and valve and pulmonary circulation integrity.

Obtain the measurement by introducing a balloon-tipped pulmonary artery flotation catheter into the pulmonary artery. When the catheter is in one of the smaller pulmonary arteries, the inflated balloon occludes the artery allowing the monitor to record changes in the intrathoracic pressures that occur throughout the respiration cycle.

The pulmonary wedge pressure is the left ventricular end diastolic pressure when the airway pressure and valve function are normal. The most accurate PAWP values are obtained at the end of the respiration cycle when the intrathoracic pressure is fairly constant and the artifact caused by respiration is minimal.

WARNING

- **PAWP monitoring is not intended for neonatal patients.**

14.7.1 PAWP Equipment to Patient Connection

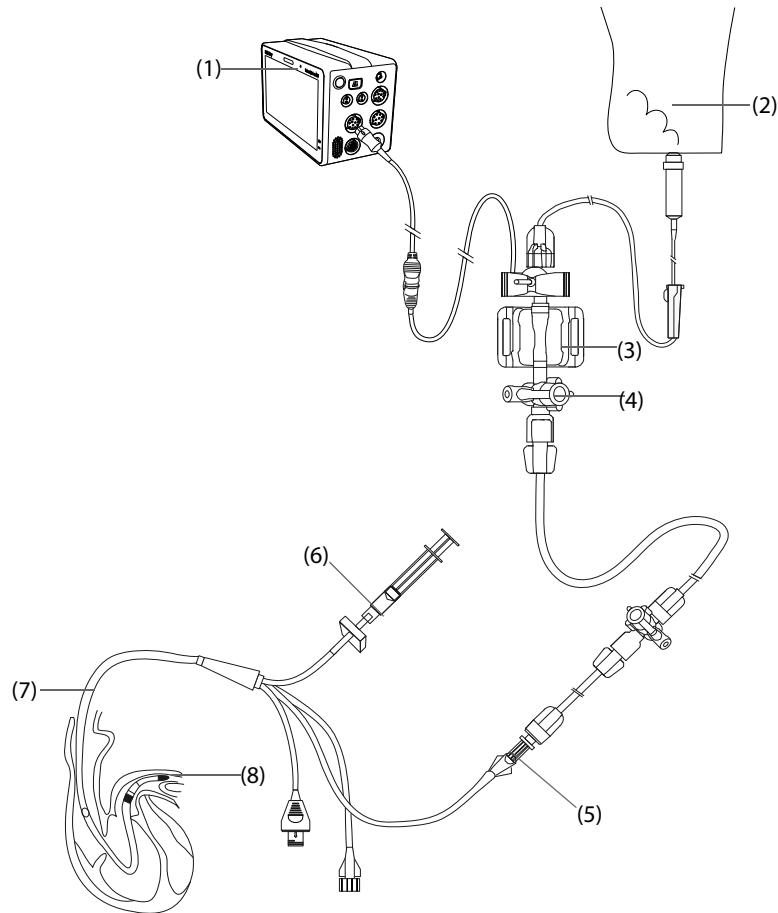

- | | |
|-----------------------------|-----------------------------|
| (1) N1 monitor | (2) Flush bag |
| (3) IBP transducer | (4) Three-way valve |
| (5) PA distal port | (6) Balloon inflation valve |
| (7) Thermodilution catheter | (8) Balloon |

14.7.2 Preparing to Measure PAWP

To prepare to monitor PAWP, follow this procedure:

1. Connect the IBP transducer, the IBP cable and the monitor. For more information, see *14.3.2 Measuring an Invasive Blood Pressure*.
2. Follow the manufacturer's instructions to connect the PA port of the thermodilution catheter and the patient end of the IBP transducer.
3. Zero the IBP transducer. For more information, see *14.3.3 Zeroing the IBP transducer*.
4. Set the IBP label to **PA** since the PAWP is measured on PA. For more information, see *14.6.2 Changing the Pressure Label*.

14.7.3 Measuring PAWP

To measure the PAWP, follow this procedure:

1. Select the PA numeric area or waveform area to enter the **PA** menu, and then select **PAWP**.
2. Wedge the flotation catheter into the pulmonary artery by observing the PA waveform changes on the screen, referring to the following figure.

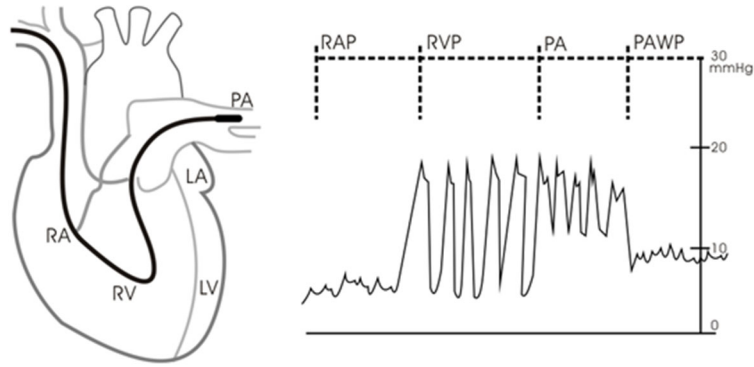

3. Select **Start**.
4. Inflate the balloon and pay attention to PA waveform changes on the screen when the prompt message **Ready For Balloon Deflation** appears.
5. Deflate the balloon when the prompt message **Ready For Balloon Deflation** appears. If the PA waveform is stable yet the monitor still not show the prompt message **Ready For Balloon Deflation**, select the **Freeze** to freeze the waveform, and deflate the balloon.
6. Select **Accept** to save the PAWP value.
7. If you need to start a new measurement, repeat the step 3 to step 6.

If the measurement fails or you need to adjust the PAWP value, you can use the following buttons to adjust the PAWP waveform and measurement.

- Select the up or down arrow button to adjust the PAWP value.
- Select the left or right arrow button to view the frozen waveforms of 40 seconds.
- Select **Accept** to save the PAWP value.

WARNING

- **Prolonged inflation can cause pulmonary hemorrhage, infarction or both. Inflate the balloon for the minimum time necessary to get an accurate measurement.**
- **If the PAWP is greater than the PA (systolic), deflate the balloon and report the incident in accordance with hospital policy. Because the pulmonary artery could be accidentally ruptured, and the PAWP value derived will not reflect the patient's hemodynamic state, but will merely reflect the pressure in the catheter or balloon.**
- **If the flotation/thermodilution catheter drifts into the wedge position without inflation of the balloon, the PA waveform assumes a wedged appearance. Take appropriate action, in accord with standard procedures, to correct the situation.**

NOTE

- **The PA alarm is turned off automatically when the monitor enters the PAWP screen.**

14.7.4 Setting the Waveforms of the PAWP Screen

On the **PAWP** screen, select **Setup** to enter the **PAWP Setup** menu. In the **PAWP Setup** menu, you can make the following settings:

- Select **Reference Waveform 1** to set an ECG lead wave as the first reference wave.
- Select **Reference Waveform 2** to set a respiration wave as the second reference wave.
- Select **Speed** to set a sweep speed for the displayed waveforms on the **PAWP** screen.
- Select **Scale** to set the size of the PA waveform on the **PAWP** screen.

14.7.5 Performing Hemodynamic Calculation (only available for the independent external display)

On the **PAWP** screen, select **Hemo Calcs** to enter the **Hemo Calcs** menu. For more information, see 18.4 *Hemodynamic Calculations*.

14.8 IBP Troubleshooting

This section lists the problems that might occur. If you encounter the problems when using the equipment or accessories, check the table below before requesting for services. If the problem persists, contact your service personnel.

NOTE

- For the physiological and technical alarm messages, see *D Alarm Messages*.

Problem	Solution
Cannot see IBP numeric area or waveform area on the main screen	<ol style="list-style-type: none">1. Check that the IBP is set to display in the Screen Setup menu. For more information, see .3.11.2 <i>Displaying Parameter Numerics and Waveforms</i>2. Check that if the IBP parameter switch is enabled. If not, enable the IBP measurement. For more information, see 3.11.1 <i>Switching On or Off a Parameter</i>.3. Check the connection of IBP cable, IBP transducer and module.4. Check that the stopcock is turned to the correct position.5. Check that the IBP transducer has been zeroed. For more information, see 14.3.3 <i>Zeroing the IBP transducer</i>.
Cannot see systolic pressure and diastolic pressure for P1/P2/P3/P4	Set Measure to All in the P1/P2/P3/P4 setup menu. For more information, see 14.6.3 <i>Setting the Pressure Type for Display</i> .
IBP readings seem unstable	<ol style="list-style-type: none">1. Make sure there are no air bubbles in the transducer systems.2. Check that the transducer is properly fixed.3. Zero the transducer again.4. Replace a transducer.
Zeroing of IBP channel(s) fails.	<ol style="list-style-type: none">1. Ensure that the channels are open to air.2. Perform zero calibration again. Do not sway the IBP transducer and tubing during zero calibration. For more information, see 14.3.3 <i>Zeroing the IBP transducer</i>.3. If zero calibration still fails, replace the transducer.

15 Monitoring Carbon Dioxide (CO₂)

15.1 CO₂ Introduction

CO₂ monitoring is a continuous, non-invasive technique for determining the concentration of CO₂ in the patient's airway by measuring the absorption of infrared (IR) light of specific wavelengths. CO₂ has its own absorption characteristic and the amount of light passing the gas probe depends on the concentration of the measured CO₂. When a specific band of IR light passes through respiratory gas samples, some of IR light will be absorbed by the CO₂ molecules. The amount of IR light transmitted after it has been passed through the respiratory gas sample is measured with a photodetector. From the amount of IR light measured, the concentration of CO₂ is calculated.

CO₂ measurement are used to monitor the patient's respiratory status. The following two methods are used for measuring CO₂:

- Mainstream CO₂ measurement

Directly insert a CO₂ sensor into the patient's breathing system.

- Sidestream/Microstream CO₂ measurement

Take a sample of the respiratory gas with a constant sample flow from the patient's airway and analyzes it with a remote CO₂ sensor built into the Sidestream or Microstream CO₂ module.

The sidestream CO₂ module can be configured with a paramagnetic oxygen sensor. The paramagnetic oxygen sensor measures oxygen relying on its paramagnetic properties.

CO₂ monitoring is intended for adult, pediatric and neonatal patients.

WARNING

- **N1 monitor does not support the CO₂ measurement when it is used for transporting patient though the rotary or fixed-wing ambulance.**
 - **It is recommended not to measure O₂ when you're transferring patient with the N1 monitor. Shaking the CO₂ module during O₂ measurement may lead to distorted O₂ waveform or inaccurate O₂ measurement.**
-

To measure CO₂, you can use either the internal CO₂ module or the external CO₂ module. The external CO₂ module is connected to the N1 through the Modular Rack. For the connection of the N1 and the external CO₂ module, see section 2.7.1 *Installing the N1 or External Parameter Module into the Modular Rack*.

In sequence, the follows are sidestream CO₂ module, microstream CO₂ module, mainstream CO₂ module and N1 monitor.

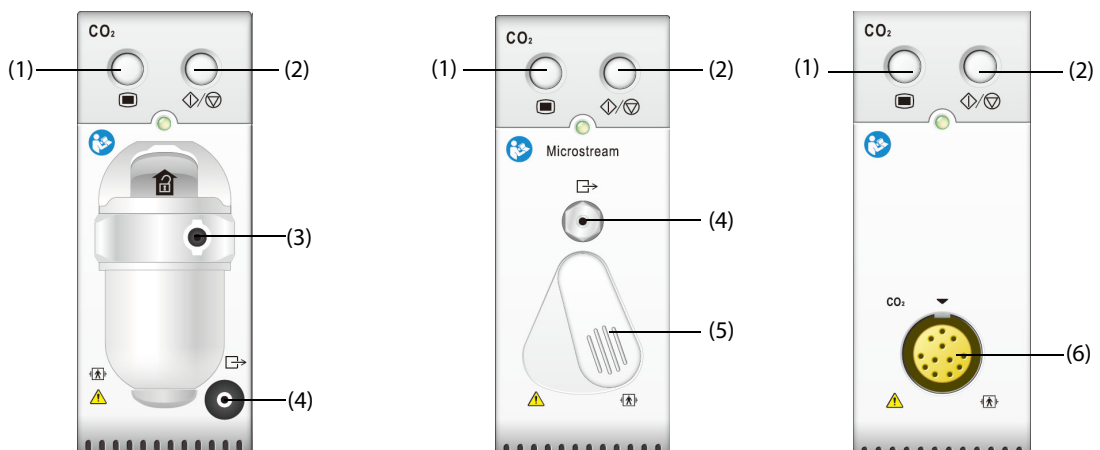

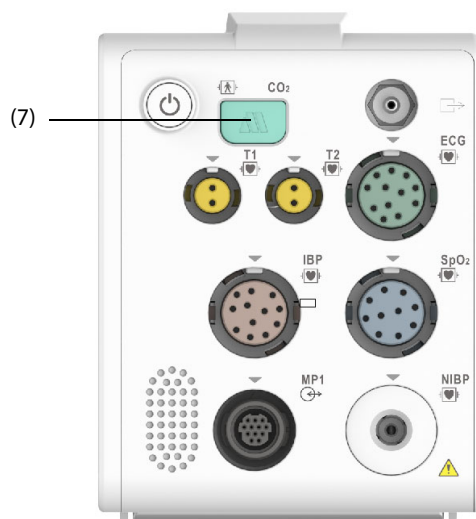

- | | |
|---------------------------------------|--|
| (1) CO ₂ menu hard key | (2) CO ₂ Measure/standby hard key |
| (3) CO ₂ watertrap seat | (4) Gas outlet |
| (5) Sample line connector | (6) CO ₂ sensor connector |
| (7) CO ₂ adapter connector | |

15.2 CO₂ Safety Information

WARNING

- **Route all tubing away from the patient's throat to avoid strangulation.**
-

CAUTION

- **Remove the airway sample line from the patient's airway while nebulized medications are being delivered.**
 - **EtCO₂ values measured from the CO₂ module may differ from those of from the blood gas analysis.**
 - **Avoid mechanical shock to the sidestream CO₂ module**
-

NOTE

- **The CO₂ module automatic suppress physiological alarms until breathing waves have been detected. Make sure that a patient is properly connected when monitoring with the CO₂ module.**
-

15.3 CO₂ Measurement Limitations

The following factors may influence the measurement accuracy:

- Leaks or internal venting of sampled gas
- Mechanical shock
- Cyclic pressure up to 10 kPa (100 cmH₂O)
- Other sources of interference, if any

Measurement accuracy of the sidestream CO₂ module may be affected by the breath rate and inspiration/expiration (I/E) ratio. Measurement accuracy of the microstream CO₂ module may be affected by the breath rate. For more information, refer to *A.14.8CO₂ Specifications*.

15.4 CO₂ Display

The CO₂ numeric and waveform area provide FiCO₂ measurement, EtCO₂ measurement, awRR measurement, and a CO₂ waveform.

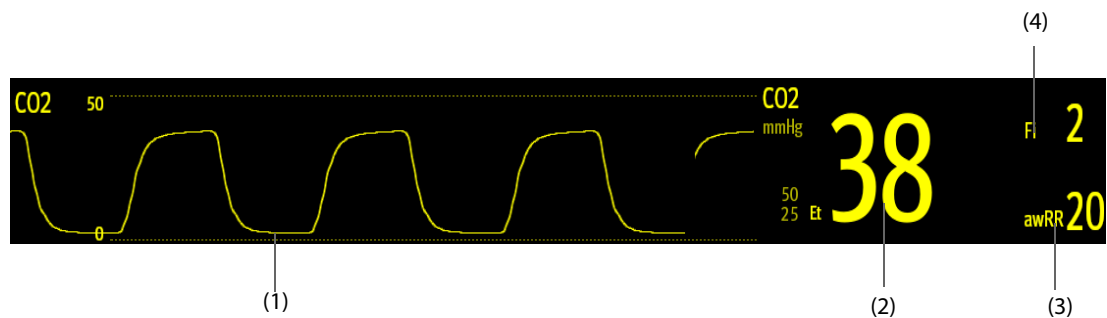

- (1) CO₂ waveform
- (2) End tidal CO₂ value (EtCO₂)
- (3) Airway respiration rate (awRR)
- (4) Fraction of inspired CO₂ (FiCO₂)

If your sidestream CO₂ module is configured with the oxygen sensor, O₂ waveform and parameters can be displayed as follows:

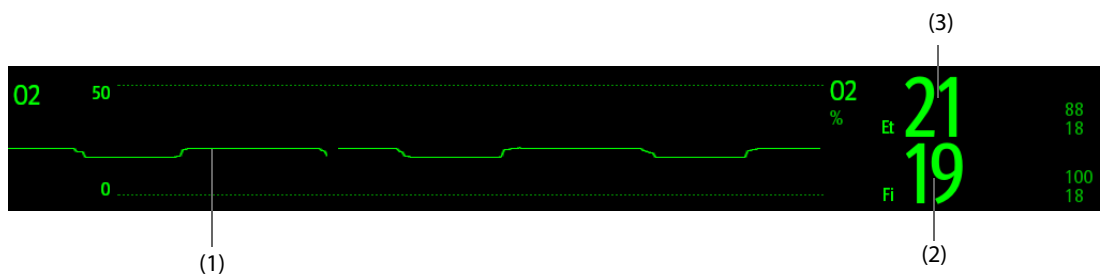

- (1) O₂ waveform
- (2) FiO₂ measurement
- (3) EtO₂ measurement

15.5 Measuring CO₂ Using Sidestream/Microstream CO₂ Module

15.5.1 Preparing to Measure CO₂ Using Sidestream CO₂ Module

To prepare the sidestream CO₂ measurement, follow this procedure:

1. Select the appropriate gas sample line and watertrap according to the patient category.
2. Connect the one end of the gas sample line.
 - ◆ If you're using the sidestream CO₂ module, connect the watertrap to the CO₂ module, and connect the gas sample line to the watertrap.

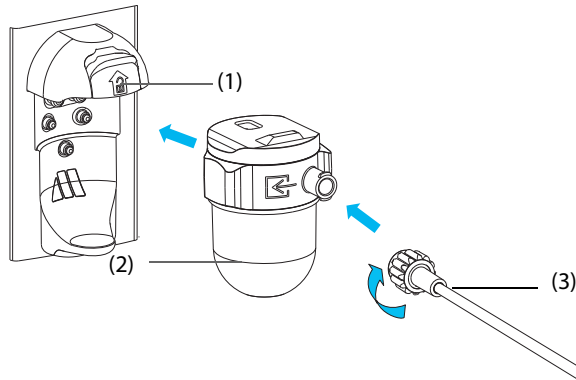

(1) Watertrap receptacle (2) DRYLINE II watertrap
 (3) Gas sample line

- ◆ If you're using the N1 monitor for CO₂ measure, connect the one end of the gas sample line to the CO₂ adapter. Refer to the *CO₂ Adapter User Manual* (PN: H-046-009994-00) for the connection of the CO₂ adapter and the gas sampling line.

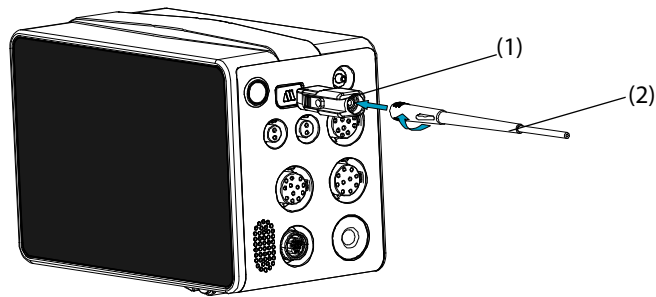

(1) CO₂ adapter (2) Gas sample line

3. Connect the other end of the gas sample line to the patient.
 - ◆ For intubated patients requiring an airway adapter, install the airway adapter between the patient circuit and the ventilator Y-piece.

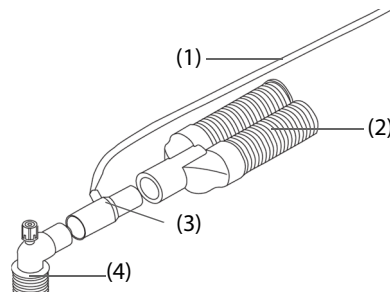

(1) Sample line (2) Connect to the ventilator
 (3) Airway adapter (4) Connect to the patient

- ◆ For non-intubated patients, place the nasal cannula onto the patient.

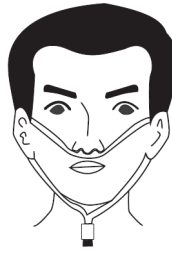

4. Connect the gas outlet to the scavenging system using an exhaust tube.

After the CO₂ module is connected, it enters measure mode by default and the monitor displays **CO₂ Starting**. CO₂ can be measured after the start-up is complete.

WARNING

- Do not apply adult or pediatric watertrap to the neonate patient. Otherwise, patient injury could result.
- Connect the gas outlet to the scavenging system when measuring CO₂ using the sidestream CO₂ module.

CAUTION

- Check the compatibility of the CO₂ adapter and the sampling line before use. The CO₂ adapter is intended for connecting an Oridion CO₂ sampling line.
- Leakage in the breathing or sampling system may cause the displayed EtCO₂ values to be significantly low. Always make sure that all components are securely connected.
- Inspect the airway adapter for a tight connection and proper operation before attaching it to the patient.
- Squeezing or bending the sample line during the sidestream or microstream CO₂ measurement may cause inaccurate CO₂ reading or no reading.
- To avoid blocking the airway, empty the DRYLINE II watertrap container whenever half full. Replacing the DRYLINE II watertrap once a month is recommended.
- The DRYLINE II watertrap has a filter preventing bacterium, water and secretions from entering the module. Extended use could destroy the filter in watertrap and fail to stop the bacterium, water and secretions entering the module, result in damaging the gas module and having infection risk.

NOTE

- It is recommended to replace the CO₂ adapter at least once a year.
- To extend the lifetime of the watertrap and module, disconnect the watertrap from the module and set the operating mode to Standby mode when CO₂ monitoring is not required.
- The sample rates are different when different types of watertraps are used.
- The emptying interval of the DRYLINE II adult/pediatric watertrap is 26 hours @ 120 ml/min, 37 °C, and 100% RH.
- The emptying interval of the DRYLINE II neonatal watertrap is 35 hours @ 90 ml/min, 37 °C, and 100% RH.

15.5.2 Preparing to Measure CO₂ Using Microstream CO₂ Module

To prepare the CO₂ module for measurement, follow this procedure:

1. Connect one end of the sample line to the microstream CO₂ module.

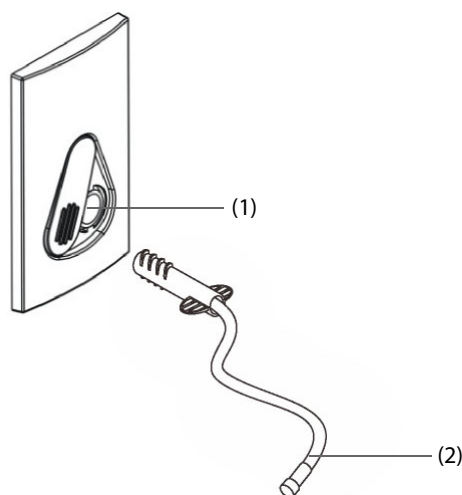

(1) Sample line connector

(2) Sample line

2. Connect the other end of the sample line to the patient.
 - ◆ For intubated patient requiring an airway adapter, install the airway adapter between the patient circuit and the ventilator Y-piece.
 - ◆ For non-intubated patient, place the nasal cannula onto the patient.
 - ◆ For patient prone to mouth breathing, place the oral-nasal cannula onto the patient.
3. Connect the gas outlet to the a scavenging system using an exhaust tube.

After the CO₂ module is connected to N1, it enters measure mode by default and the monitor displays **CO₂ Sensor Warmup**. CO₂ can be measured after the start-up is complete.

CAUTION

- **Connect the gas outlet to the scavenging system when measuring CO₂ using the microstream CO₂ module.**
-

NOTE

- **Disconnect the sample line from the module when CO₂ monitoring is not required.**
-

15.5.3 Zeroing the Sidestream/Microstream CO₂ Module

The sidestream or microstream CO₂ module performs zero calibration automatically when needed.

NOTE

- **The CO₂ module temporarily stops measuring during zeroing.**
-

15.6 Measuring CO₂ Using Mainstream CO₂ Module

15.6.1 Preparing to Measure CO₂ Using Mainstream CO₂ Module

To prepare the CO₂ module for measurement, follow this procedure:

1. Connect the airway adapter to the sensor head.

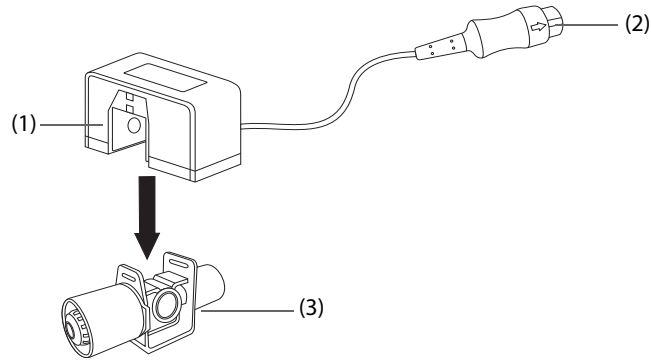

(1) Sensor

(2) Connect to module

(3) Airway adapter

2. Attach the sensor connector to the CO₂ connector on the mainstream CO₂ module.
3. Zero the sensor after the warm-up is finished. For details, see *15.6.2 Zeroing the Mainstream CO₂ sensor*.
4. After the zero calibration is finished, connect the airway as shown below.

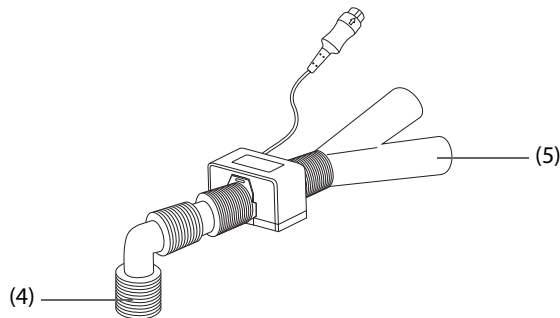

(4) Connect to patient

(5) Connect to ventilator

5. Make sure that no leakages are in the airway and then start a measurement.

NOTE

- **Be sure to set the barometric pressure properly before using the mainstream CO₂ module. Improper settings will result in erroneous CO₂ reading.**
- **Always position the sensor with the adapter in an upright position to avoid collection of fluids in the windows of the adapter. Large concentrations of fluids at this point will obstruct gas analysis.**
- **To avoid dead space, place the sensor as close to the patient as possible.**

15.6.2 Zeroing the Mainstream CO₂ sensor

For mainstream CO₂ modules, the sensor should be zeroed in the following conditions:

- Before each measurement.
- A new adapter is used.
- Reconnect the sensor to the module.
- The message **CO₂ Zero Required** displays. In this case, check the airway adapter for any blockage, e.g. mucus, etc. If a blockage is detected, clear or replace the adapter.

To zero the sensor, follow this procedure:

1. Connect the sensor to the module.
2. In the **CO₂** menu, select **Setup** tab.

3. Set the **Operating Mode** to **Measure**. The message **CO2 Sensor Warmup** is displayed.
4. After warm-up is finished, connect the sensor to a clean, dry airway adapter. The adapter should be vented to the air and isolated from CO₂ sources, such as ventilator, the patient's breathing, your own breathing, etc.
5. Select **Zero** in the **CO2** menu. The message **Zeroing** is displayed.

It takes about 15 to 20 seconds. The message disappears when the zero calibration is completed.

WARNING

- **When perform a zero calibration during the measurement, disconnect the sensor from the patient's airway first.**
 - **Please do not rely on the readings during zeroing.**
-
-

15.7 Changing Settings for All CO₂ Modules

15.7.1 Changing CO₂ Alarm Settings

To change the CO₂ alarm settings, follow this procedure:

1. Select the CO₂ numeric area or waveform area to enter the **CO2** menu.
2. Select the **Alarm** tab.
3. Enter the password if required. For more information, refer to *6.9.3 Selecting Password for User Authentication*.
4. Set alarm properties as desired.

15.7.2 Changing the CO₂ Unit

To change the CO₂ unit, follow this procedure:

1. Select the **Main Menu** quick key → from the **System** column select **Maintenance** → input the required password → select .
2. Select the **Unit** tab.
3. Set **CO2 Unit**.

15.7.3 Setting the CO₂ Waveform

To set the CO₂ waveform, follow this procedure:

1. Select the CO₂ numeric area or waveform area to enter the **CO2** menu.
2. Select the **Setup** tab.
3. Set **Waveform Type**, **Speed** and **CO2 Scale** of the CO₂ waveform.

15.7.4 Setting the RR Source

To set the respiration rate (RR) source, follow this procedure:

1. Select the CO₂ numeric area or waveform area to enter the **CO2** menu.
2. Select the **Setup** tab.
3. Set **RR Source**.

When the current RR source does not have valid measurement, the system will automatically switch **RR Source** to **Auto**.

15.7.5 Entering the Standby Mode

You can set the CO₂ module to one of the following modes according to the module status:

- Select **Measure** mode when you use the CO₂ module for monitoring.

- Select **Standby** mode when you does not use the CO₂ module to prolong the serviec life of the CO₂ module.

The default operating mode is **Measure**. If you are not using the CO₂ module, you can proceed as follows to enter the Standby mode:

1. Select the CO₂ numeric area or waveform area to enter the **CO2** menu.
2. Select the **Setup** tab.
3. Set **Operating Mode** to **Standby**.

15.7.6 Entering the Intubation Mode

When performing intubation during general anesthesia, you can enter the intubation mode in order to reduce unnecessary alarms. To enter the intubation mode, follow this procedure:

1. Select the CO₂ numeric area or waveform area to enter the **CO2** menu.
2. Select **Intubation Mode**.

For the details of the intubation mode, see 7.11 *Intubation Mode*.

15.8 Changing Settings for Sidestream and Microstream CO₂ Module

15.8.1 Setting the Auto Standby

The monitor enters standby mode automatically after the configured period of time if no breath is detected since the last detected breath. To set the auto standby, follow this procedure:

1. Select the CO₂ numeric area or waveform area to enter the **CO2** menu.
2. Select the **Setup** tab.
3. Set **Auto Standby**.

15.8.2 Setting Humidity Compensation

Sidestream and microstream CO₂ modules are configured to compensate CO₂ readings for either Body Temperature and Pressure, Saturated Gas (BTPS), to account for humidity in the patient's breath, or Ambient Temperature and Pressure, Dry Gas (ATPD).

- ATPD: $P_{CO_2}(mmHg) = CO_2(vol\%) \times P_{amb}/100$
- BTPS (sidestream): $P_{CO_2}(mmHg) = CO_2(vol\%) \times (P_{amb} - 47)/100$
- BTPS (microstream): $P_{CO_2}(mmHg) = CO_2(vol\%) \times (1 - 0.03) \times P_{amb}/100$

Where, $P_{CO_2}(mmHg)$ = partial pressure, $vol\%$ = CO₂ concentration, P_{amb} = ambient pressure, and unit is mmHg.

For the sidestream and microstream CO₂ module, you can set the humidity compensation on or off according to the actual condition.

To set the humidity compensation, follow this procedure:

1. Select the CO₂ numeric area or waveform area to enter the **CO2** menu.
2. Select the **Setup** tab.
3. Set **BTPS Compensation**.
 - ◆ Switch on for BTPS.
 - ◆ Switch off for ATPD.

15.8.3 Setting Flow Rate (For Sidestream CO₂ Module Without O₂)

When you are using the sidestream CO₂ module without the O₂ monitoring function to monitor a neonatal patient, you can select flow rate. To do so, follow this procedure:

1. Select the **Main Menu** quick key → from the **System** column select **Maintenance** → input the required password → select .
2. Select the **Module** tab → **Other** tab.
3. Set **CO2 Flow Rate For Neo**.

15.9 Changing O₂ Settings (For Sidestream CO₂ Module Integrating O₂)

15.9.1 Changing O₂ Alarm Settings

To change the O₂ alarm settings, follow this procedure:

1. Select the CO₂ numeric area or waveform area to enter the **CO2** menu.
2. Select the **Alarm** tab.
3. Set alarm properties as desired.

15.9.2 Changing the O₂ Unit

To change the O₂ unit, follow this procedure:

1. Select the **Main Menu** quick key → from the **System** column select **Maintenance** → input the required password → select .
2. Select the **Unit** tab.
3. Set **O2 Unit**.

15.9.3 Setting the O₂ Waveform

To set the O₂ waveform, follow this procedure:

1. Select the CO₂ numeric area or waveform area to enter the **CO2** menu.
2. Select the **Setup** tab.
3. Set **Speed** and **O2 Scale** of the O₂ waveform.

15.10 Setting the Gas Compensation

The presence of interfering gas affects the CO₂ measurement. To get the best possible measuring result, it is needed to set the gas compensation. The configured concentration of the interfering gas should be in accordance with its actual proportion.

For the microstream CO₂ module, gas compensations are not required.

WARNING

- **Make sure to use the appropriate compensations. Inappropriate compensations may cause inaccurate measurement values and result in misdiagnosis.**
-

For the sidestream CO₂ module, follow this procedure to set the gas compensation:

1. Select the CO₂ numeric area or waveform area to enter the **CO2** menu.
2. Select the **Setup** tab.
3. Set the compensation according to the actual condition.

For the mainstream CO₂ module, follow this procedure to set the gas compensation:

1. Select the CO₂ numeric area or waveform area to enter the **CO2** menu.
2. Select the **Setup** tab.
3. Set the following compensation according to the actual condition.

■ Balance Gas

- ◆ Select **Room Air** when air predominates in the ventilation gas mixture.
 - ◆ Select **N2O** when N₂O predominates in the ventilation gas mixture.
 - ◆ Select **He** when He predominates in the ventilation gas mixture.
- **O2 Compensation**
 - ◆ Select **Off** when the amount of O₂ is less than 30%.
 - ◆ Select an appropriate setting according to the amount of O₂ in the ventilation gas mixture.
 - **AG Compensation:** enters the concentration of anesthetic gas present in the ventilation gas mixture. This could compensate for the effect of AG on the readings.

15.11 Choosing a Time Interval for Peak-Picking

For microstream and mainstream CO₂ modules, you can select a time interval for picking the highest CO₂ as the EtCO₂ and the lowest as the FiCO₂.

To set the time interval, follow this procedure:

1. Select the CO₂ numeric area or waveform area to enter the **CO2** menu.
2. Select the **Setup** tab.
3. Set **Maximum Hold**.
4. Toggle between **Single Breath, 10 s, 20 s** and **30 s** if microstream CO₂ module is configured; toggle between **Single Breath, 10 s** and **20 s** if mainstream CO₂ module is configured.
 - ◆ **Single Breath:** EtCO₂ and FiCO₂ are calculated for every breath.
 - ◆ **10 s, 20 s, or 30 s:** EtCO₂ and FiCO₂ are calculated using 10, 20 or 30 seconds of data.

15.12 Changing Barometric Pressure

Both sidestream and microstream CO₂ modules have the function of automatic barometric pressure compensation (the system automatically measures the barometric pressure to which the patient monitor is exposed). However, the mainstream CO₂ module does not have such function. For the mainstream CO₂ module, the default barometric pressure is 760 mmHg. You must modify the barometric pressure based on the actual situation. To change the barometric pressure for the mainstream CO₂ module, follow this procedure:

1. Select the **Main Menu** quick key → from the **System** column select **Maintenance** → input the required password → select .
2. Select **Other** tab.
3. Select **Barometric Pressure** and then enter the value of barometric pressure to which the patient monitor is exposed to.

WARNING

- **Be sure to set the barometric pressure properly before using the mainstream CO₂ module. Improper settings will result in erroneous CO₂ reading.**
-
-

15.13 Performing the Leakage Test

When measuring CO₂ using the internal CO₂ module or the sidestream CO₂ module. The leakage test is required every time before the CO₂ measurement. To perform the CO₂ leakage test, follow this procedure:

1. Connect the measuring accessories as per section *15.5.1 Preparing to Measure CO₂ Using Sidestream CO₂ Module*.
2. Wait until the startup finishes. Completely block the gas inlet on the sidestream CO₂ module or on the N1. Then the alarm message "**CO₂ Airway Occluded**" will appear on the screen.
3. Block the gas inlet for another one minute.

4. Select the **Main Menu** quick key → from the **System** column select **Maintenance** → input the required password → select .
5. Select the **Module** tab → **CO₂** tab.
6. Check that the current flow rate is less than 10ml/min, and the alarm message “**CO₂ Airway Occluded**” does not disappear.

This indicates that the module does not leak. If the alarm message disappears, or the flow rate is equal to 10ml/min or greater, it indicates that the module leaks. Perform the leakage test again. If the problem remains, contact your service personnel for help.

15.14 CO₂ Calibration

For sidestream and microstream CO₂ modules, a calibration is needed every year or when the measured values have a great deviation. For maintream CO₂ module, no calibration is needed. To calibrate the CO₂ module, contact the service personnel.

CAUTION

- **Connect the gas outlet to the scavenging system when calibrating the CO₂ module.**
-

15.15 Test Method Used to Determine the Respiration Rate Measuring Range

To determine the RR measurement range, follow this procedure:

1. Connect the 5% CO₂ + N₂ (BAL) gas cylinder, reduction valve, rhythm generator and gas sampling path of a monitor.
2. Respectively set the rhythm generator to generate a respiration rate of 0 rpm, 6 rpm, 20 rpm, 60 rpm, 120rpm, and 150 rpm.
3. Verify that it meets the specifications.

NOTE

- **The rhythm generator mentioned above is a sensor/sampling site in Figure 201.101 – Test apparatus for the TOTAL SYSTEM RESPONSE TIME of an RGM of ISO 80601-2-55.**
-

15.16 CO₂ Troubleshooting

This section lists the problems that might occur. If you encounter the problems when using the equipment or accessories, check the table below before requesting for services. If the problem persists, contact your service personnel.

NOTE

- **For the physiological and technical alarm messages, see *DAlarm Messages*.**
-

15.16.1 Troubleshooting the Sidestream/Microstream CO₂ Module

Problem	Solution
EtCO ₂ measurements too low	<ol style="list-style-type: none"> 1. Ventilate the room if the environmental CO₂ concentration is too high. 2. Check the sample line and connectors for leakage. 3. Check the patient status.

15.16.2 Troubleshooting the Mainstream CO₂ Module

Problem	Solution
Elevated baseline	1. Check the patient status. 2. Check the sensor.

15.17 Oridion Information

Microstream

This trademark is registered in Israel, Japan, German and America.

Oridion Patents

The capnography component of this product is covered by one or more of the following US patents: 6,428,483; 6,997,880; 6,437,316; 7,488,229; 7,726,954 and their foreign equivalents. Additional patent applications pending.

No Implied License

Possession or purchase of this device does not convey any express or implied license to use the device with unauthorized CO₂ sampling consumables which would, alone, or in combination with this device, fall within the scope of one or more of the patents relating to this device and/or CO₂ sampling consumable.

16 Review

16.1 Review Overview

Trends are patient data collected over time and displayed in graphic, tabular, or other forms to give you a picture of how your patient's condition is developing. You can review the trend data in the review page, minitrends window, or OxyCRG window (minitrends window and OxyCRG window are only available for the independent external display). You can also review the events, 12-lead ECG analysis results and waveforms, full disclosure waveforms, and so on.

16.2 Review Page

The **Review** page contains tabs to display trend data in tabular, graphic, or other forms.

16.2.1 Accessing the Review Page



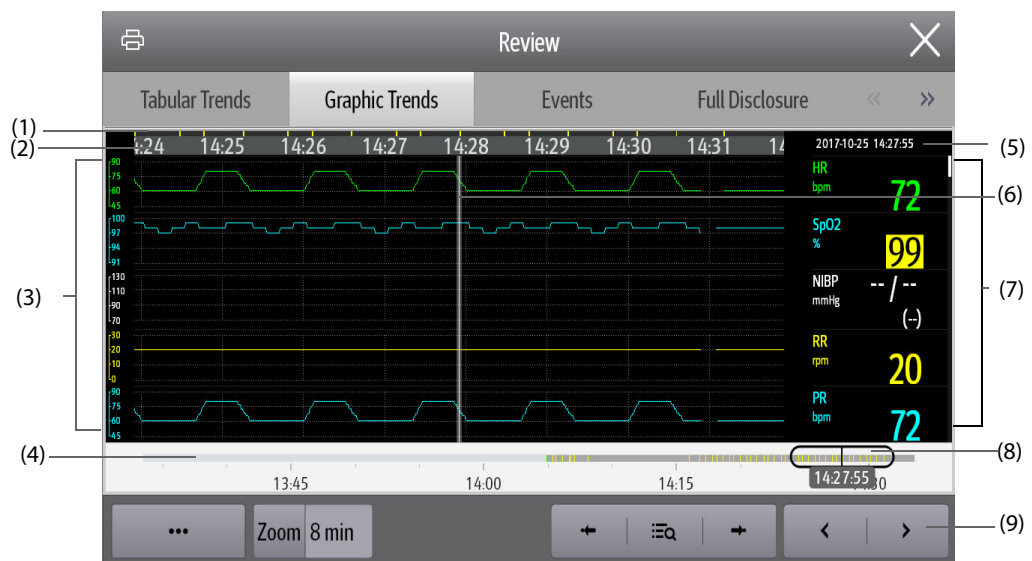

To enter the review page, select the **Main Menu** quick key → from the **Review** column select the desired option.

16.2.2 Example Review Page

The review pages have similar structure. We take the graphic trends review page as an example.





- (1) Event type indicator: different color blocks match different types of events:
 - Red: high priority alarm event
 - Yellow: medium priority alarm event
 - Cyan: low priority alarm event
 - Green: manual event
 - White: operation-related event
- (2) Current window time line: indicates the time length of the current window.
- (3) Waveform area: displays trend curves. The color of trend curves is consistent with the color of parameter labels.

- (4) Time line: indicates the entire time length.
- : indicates the time length of reviewable trend data.  can be moved within this time length.
 - : indicates the time length of no trend data.  cannot be moved within this time length.
- Different color blocks at the time line indicate events of different types. See the color definition for the event type indicator.
- (5) Event area: displays the event of the cursor time. Selecting the event access the event list. If there is no event at the cursor time, the cursor time is displayed.
- (6) Cursor
- (7) Numeric area: displays numeric values at the cursor indicated time. The background color of numeric values matches the alarm priority.
- (8) Slider: indicates the position of current window time in the entire time length. Dragging this button left or right enables you to locate the trend data at a specific time and also refreshes trend data in current window accordingly.
- (9) Button area.

16.2.3 Symbols on Review Pages

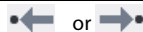
The following table lists the symbols on review pages.

Symbol	Description
	Slider: indicates the position of current window time in the entire time length. Dragging the slider left or right enables you to locate the trend data at a specific time and also refreshes data in current window accordingly.
	Goes to the previous or next event.
	Event list: displays events in a chronological order. The most recent event is displayed at the top. The number of asterisk symbols before an event matches alarm priority.
	Print button: select it to output patient information and data through the printer.

16.2.4 Common Operations

This section describes common operations for all review pages.

16.2.4.1 Browsing Trend Data

Browse trend data in one of the following ways:



- Move the cursor.
- Move the slider .
- Slide your finger on the screen.

16.2.4.2 Viewing Events

You can view the following types of events:

- Manually triggered events
- Parameter-related operation events and alarm-related events, such as starting C.O. measurement
- Operation events not related to parameters, such as system time change

View events in either of the following ways:

- Select  and select the desired event.
- Select  or  to view the previous or next event.

Events are displayed in a chronological order. The most recent event is displayed at the top. The number of asterisk symbols before and event matches alarm priorities as follows:

- ***: high priority alarm
- **: medium priority alarm
- *: low priority alarm

16.2.5 Reviewing the Tabular Trends

The tabular trends review page displays trend data in a tabular form. To enter the tabular trends review page, select the **Main Menu** quick key → from the **Review** column select **Tabular Trends**.

16.2.5.1 Changing the Trend Group

To change the trend group, follow this procedure:

1. Enter the tabular trends review page.
2. Set **Trend Group**.

16.2.5.2 Editing the Trend Group

The setting of the **Trend Group** defines the contents of displayed and printed trends. You can edit the trend group. To do so, follow this procedure:

1. Enter the tabular trends review page.
2. Select **Group Setup**.

NOTE

-
- **You cannot edit the trend groups labeled All or Standard.**
 - **ECG parameter and waveform are always displayed in the first row on the trend page. It cannot be deleted or moved.**
-

16.2.5.3 Changing the Resolution of Trend Data

The interval of tabular trends defines the interval of displaying trend data. Short interval is especially suited for neonatal applications, where the clinical situation may change very quickly. In adult monitoring, where the patient's status typically changes more gradually, a longer interval may be more informative.

To change the interval of trend data, follow this procedure:

1. Enter the tabular trends review page.
2. Select **Interval**.
 - ◆ **5 sec or 30 sec:** select to view up to 4 hours of tabular trends at an interval of 5 seconds or 30 seconds.
 - ◆ **1 min, 5 min, 10 min, 15 min, 30 min, 1 hr, 2 hrs, or 3 hrs:** select to view up to 120 hours of tabular trends at selected interval.
 - ◆ Select parameters, such as NIBP, C.O. to view the tabular trends when parameter measurements are acquired.

16.2.5.4 Printing a Tabular Trends Report

To print a tabular trends report, follow this procedure:

1. Enter the tabular trends review page.
2. Select  at the upper left corner of the review page
3. Set the tabular trends report as described in *19.8.3 Setting Tabular Trends Reports*.
4. Select **Print**.

16.2.6 Reviewing the Graphics Trends

The graphic trends review page displays trend data in a graphic form. To enter the graphic trends review page, select the **Main Menu** quick key → from the **Review** column select **Graphic Trends**.

16.2.6.1 Changing the Trend Group

To change the trend group, follow this procedure:

1. Enter the Graphic trends review page.
2. Select  and set **Trend Group**.

16.2.6.2 Editing the Trend Group

The setting of the **Trend Group** defines the contents of displayed and printed trends. You can edit the trend group. To do so, follow this procedure:

1. Enter the Graphic trends review page.
2. Select  and select **Group Setup**.

NOTE

- **You cannot edit the trend groups labeled All or Standard.**
 - **ECG parameter and waveform are always displayed in the first row on the trend page. It cannot be deleted or moved.**
-

16.2.6.3 Changing the Resolution of Trend Data

To change the length of trend data displayed on the current screen, follow this procedure:

1. Enter the graphic trends review page.
2. Select **Zoom**.
 - ◆ **8 min:** the screen displays eight minutes of trend data. You can view the recent one hour data.
 - ◆ **30 min, 1 hr, 2 hrs, 4 hrs:** the screen displays 30 minutes, one hour, two hours, or four hours of trend data. You can view the recent four hour data.
 - ◆ **8 hrs, 12 hrs, 24 hrs, 48 hrs:** the screen displays eight hours, 12 hours, 24 hours, or 48 hours of trend data. You can view the recent 120 hours of data.

16.2.6.4 Changing the Number of Waveforms

To change the number of waveforms displayed on the trend review page, follow this procedure:

1. Enter the graphic trends review page.
2. Select  and set **Trends**.

16.2.6.5 Printing a Graphic Trends Report

To print a graphic trends report, follow this procedure:

1. Enter the graphic trends review page.
2. Select  at the upper left corner of the review page.
3. Set the graphic trends report as described in *19.8.4 Setting Graphic Trends Reports*.
4. Select **Print**.

16.2.7 Events Review Page

The monitor stores events in real time, including technical alarm events, physiological alarm events, manual events, and operational events. When an event occurs, all the measurement numerics and three event-related waveforms 16 seconds before and after the event are stored.

NOTE

- **Alarms are saved as events and will be maintained if the equipment is powered down. The time of equipment power down is not recorded as an event and cannot be reviewed.**
- **A total loss of power does not affect the events already stored.**

- **Earlier events will be overwritten by later ones if the capacity is reached.**
-

16.2.7.1 Entering the Events Review Page

To enter the events review page, select the **Main Menu** quick key → from the **Review** column select **Events**.

The **Event** page displays event list. Events are displayed in descending chronological order. The most recent event is displayed at the top. The number of asterisk symbols before an event indicate alarm priorities. Different color blocks are displayed on the left of each event to indicate different event types.

- Red: high priority alarm event
- Yellow: medium priority alarm event
- Cyan: low priority alarm event
- Green: manual event
- White: operation-related event

16.2.7.2 Configuring the Filter

You can filter events by time, alarm priority, alarm category, or parameter group. To configure the filter, follow this procedure:

1. Enter the **Events** page.
2. Select **Event List**.
3. Select **Filter Setup** and set the desired filter criterion.

16.2.7.3 Editing Events

To edit events, follow this procedure:

1. Enter the **Events** page and tick off the desired events.
2. Select **...** to edit the selected events.
 - ◆ **Lock**: manually lock the event. Locked events cannot be deleted.
 - ◆ **Note**: enter comments for the event.

16.2.7.4 Viewing Event Details

To view waveforms and parameter values at the event time, follow this procedure:

1. Enter the **Events** page.
2. Select **Detail**.

To display beat labels on the first ECG waveform, switch on **Beat Anno**. The white beat labels indicate heart beats classification and may explain suspected, missed, or false arrhythmia calls. Heart beats are classified as follows:

- N = Normal
- V = Ventricular ectopic
- S = Supraventricular premature
- P = Paced
- L = Learning
- ? = Insufficient information to classify beats
- I = Inoperative (for example, Lead Off)
- M = Missed beat

16.2.7.5 Printing Event Reports

To print event reports, follow this procedure:

1. Enter the events review page.

2. Select  at the upper left corner of the review page.
3. Select the desired options.
 - ◆ **Print All Event List:** print the entire event list.
 - ◆ **Print List of Selected Events:** print the list of selected events.
 - ◆ **Print Detail of Selected Events:** print the details of selected events.
 - ◆ **Print Displayed Event Detail:** print the waveforms and parameters of the currently displayed event.
4. Select **Print**.

16.2.8 Viewing the Full Disclosure

You can review up to 48-hours' waveform data on the full disclosure review page. You can view both the compressed waveforms, full waveforms and numeric values. To enter the full disclosure review page, select the **Main Menu** quick key → from the **Review** column select **Full Disclosure**.

16.2.8.1 Selecting Waveforms

Before reviewing compressed waveforms, you must select waveforms you want to store and display. To store and display the desired waveforms, follow this procedure:

1. Enter the full disclosure review page.
2. Select  and select **Setup**.
3. Select the **Storage** tab and set the desired waveforms to be stored in the monitor.
4. Select the **Display (Maximum: 3)** tab and set the desired waveforms to be displayed on the **Full Disclosure** page.

NOTE

- **The more waveforms selected in the Storage column, the shorter the waveform storage time. The waveforms may not be stored for 48 hours. Please exert caution when selecting waveforms.**

16.2.8.2 Setting Scale and Duration

To set the length and size of displayed compressed waveforms, follow this procedure:

1. Enter the full disclosure review page.
2. Select .
3. Select **Scale** to set ECG waveform gain.
4. Select **Duration** to set the length of displayed waveforms.

16.2.8.3 Viewing Details of Compressed Waveforms

To view the full waveforms and numeric values, follow this procedure:

1. Enter the full disclosure review page.
2. Select **Details**.

You can perform the following operations on the this page:

- Switch on **Beat Anno**. For more information, see *16.2.7.4 Viewing Event Details*.
- Select  and make the following settings:
 - ◆ Set **Speed** and **ECG Gain**
 - ◆ Select **Save As Event**, and edit according to prompt to save current waveform as an event.
- Select **Overview** to switch to the compressed waveform page.

16.2.8.4 Printing the Full Disclosure Waveform Report

To print a compressed waveform report, follow this procedure:

1. Enter the full disclosure review page.

2. Select  and set the time range for printing.
3. Select **Print**.

16.2.9 OxyCRG Review Page (available for the independent external display)

You can review up to 48 hours of trend curves on the OxyCRG review page. The OxyCRG review functionality is available for neonatal monitoring only.

NOTE

- **OxyCRG Review Page is available only when Patient Category is set to Neo.**

16.2.9.1 Entering the OxyCRG Review Page

Choose one of the following methods to enter the OxyCRG review page:

- From the OxyCRG screen, select the ABD events list area.
- Select the **Review** quick key → select the **OxyCRG** tab.
- Select the **Main Menu** quick key → from the **Review** column select **OxyCRG**.

16.2.9.2 The Display of the OxyCRG Review Page

The following figure shows the OxyCRG screen:

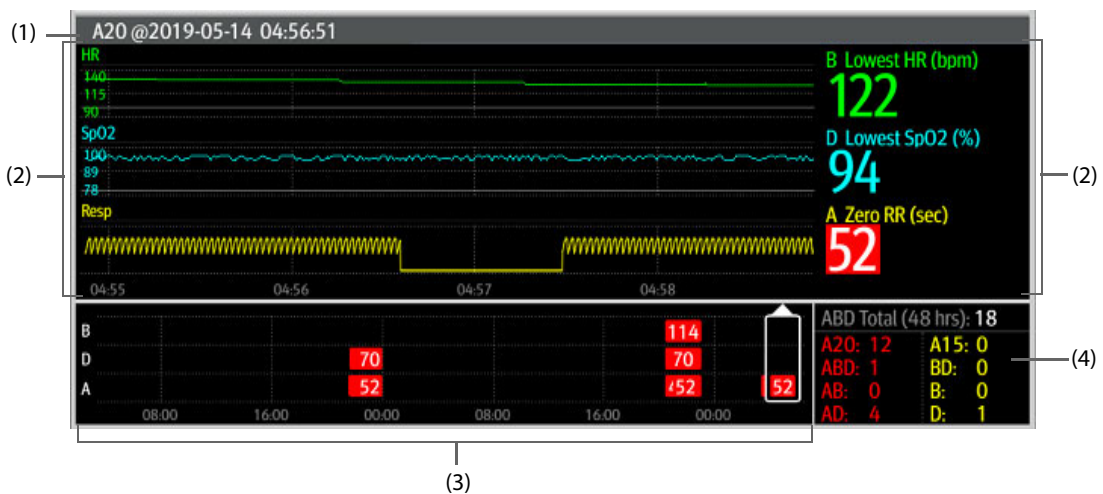

- (1) Event title area: displays information of the selected event, such as the event type and time.
- (2) Event detail area: displays parameter trends, compressed waveform, and parameter values of selected event.
- (3) Event summary area: displays ABD events within the **Zoom** period. The selected event is enclosed in a white frame.
- (4) Event statistics area: displays the total number of ABD events and the numbers of each event within the **Zoom** period.

16.2.9.3 Changing the Resolution of Trend Curves

To set the resolution of trend curves, follow this procedure:

1. Enter the OxyCRG review page.
2. Set **Zoom**.

NOTE

- If the Zoom is set for a large duration (for example, 8 hrs), the screen may show "No Patient Data" for the first several minutes of data collection (for example, 6 minutes), but data will be shown after enough data has been collected.
-

16.2.9.4 Printing an OxyCRG Review Report

To print an OxyCRG review report, follow this procedure:

1. Enter the OxyCRG review page.
2. Select  to enter the **Print Setup** dialog.
3. Select **Print**. The report duration corresponds to the duration of data shown on the screen.

16.2.10 12-Lead ECG Review Page

When 12-lead ECG analysis is performed, you can review the most recent 20 events of 12-lead analysis. For more information, see *9 Resting 12-Lead ECG Analysis*.

16.2.10.1 Entering the 12-Lead Review Page

Choose one of the following methods to enter the 12-lead ECG review page:

- Upon completion of 12-lead ECG analysis, select **Review** from the **12-Lead Interpretation** screen. For more information, see *9 Resting 12-Lead ECG Analysis*.
- Select the **Main Menu** quick key → from the **Review** column select **12-Lead ECG**.

16.2.10.2 Switching to Median Complex (for Glasgow Algorithm Only)

The median complex template displays 12-lead ECG waveforms on one page in 4 columns, with 3 lines in each column, and one rhythm lead waveform at the bottom. Besides, a short vertical bar appears above each waveform, marking the start and end position of P-wave and QRS-wave and the end position of T-wave.

To view Median Complex, follow this procedure:

1. Enter the 12-lead review page.
2. Select **Median Complex**.

Selecting **Waveform** can return to the 12-lead ECG waveform page.

16.2.10.3 Setting 12-Lead ECG Waveforms

To set the 12-lead ECG waveforms on the review page, follow this procedure:

1. Enter the 12-lead review page.
2. Set **Speed**, **Gain**, and **Layout**.

16.2.10.4 Printing the 12-Lead ECG Report

To print the 12-Lead ECG report, follow this procedure:

1. Enter the 12-lead review page.
2. Select .

16.3 Minitrends Screen (only available for the independent external display)

The minitrends screen shows graphic minitrends of parameters.

16.3.1 Entering the Minitrends Screen

Choose one of the following methods to enter the minitrends screen:

- Select the **Minitrends** quick key.
- Select the **Screen Setup** quick key → select **Minitrends**.
- Select the **Main Menu** quick key → from the **Display** column select **Choose Screen** → select **Minitrends**.

For adult and pediatric patients, when the Minitrends screen is hidden as , you can also choose one of the following methods to quickly enter the Minitrends screen.

- Swipe left or right across the touchscreen with two fingers until you switch to the Minitrends screen.
- Swipe right across the touchscreen with a single finger.
- Select the  button.

On the minitrends screen, parameter labels are displayed above trend data. Scales are displayed on the left of trend data. Time length is displayed at the bottom of the minitrends screen.

16.3.2 Viewing the Long Trends

To expand the Minitrends screen to view the long trends, choose either of the following ways:

- Select the  button.
- Swipe right across the Minitrends screen with a finger.

16.3.3 Setting Parameters

To set parameters, follow this procedure:

1. Enter the minitrends screen.
2. Select the minitrends area to enter the **Minitrend Setup** menu.
3. Set parameters. If you want to use the default parameters, select **Default Parameter**.

16.3.4 Setting the Minitrend Length

To set the minitrend length, follow this procedure:

1. Enter the minitrends screen.
2. Select the minitrends area to enter the **Minitrend Setup** menu.
3. Set **Minitrend Length**.

16.3.5 Exiting the Minitrends Screen

Choose one of the following methods to exit the minitrends screen:

- Select the **Screen Setup** quick key → select the desired option.
- Select the **Main Menu** quick key → from the **Display** column select **Choose Screen** → select the desired option.

16.4 Hiding Undesired Review Tabs

If you do not need to review some items, you can hide them. To do so, follow this procedure:

1. Select the **Main Menu** quick key → from the **System** column select **Maintenance** → input the required password → select .
2. Set the **Review** tab.
3. From the **Tabs** page, **Event**, or **Arrh Mark** deselect those you do not need to review.

17 Clinical Assistive Applications (only available for the independent external display)

The Clinical Assistive Applications (CAA) function integrates some commonly used clinical guidelines and tools into the monitor. It puts the currently monitoring parameter measurements together and provides comprehensive analysis results.

CAA can improve the clinician's working efficiency. However, it is not directly used for diagnosis and cannot not replace the clinician's judgement.

17.1 Early Warning Score (EWS)

The Early Warning Score (EWS) can help you recognize the early sign of deterioration in patients based on vital signs and clinical observations. Depending on the score calculated, appropriate recommendations are displayed.

The monitor supports the following scores:

- MEWS (Modified Early Warning Score)
- NEWS (National Early Warning Score)
- NEWS2 (National Early Warning Score 2)
- Custom Score

A subscore is given for each parameter based on the measured or entered value. When all the required parameters are entered or measured, the subscores are added together to calculate the total early warning score. Each subscore has a color coding to indicate associated level of risk. When the total score is outside of the thresholds, actions are recommended. Both MEWS, NEWS and NEWS2 can give total scores.

Custom Score is based on user-defined parameters.

MEWS and NEWS and NEWS2 are intended for adult patients only. The patient category of the Custom Score is defined by the Mindray Clinical Score Configuration Tool. For more information, see *Mindray Clinical Scoring Config Tool Instruction for Use (P/N: 046-012986-00)*.

WARNING

- **The EWS scores and recommended actions are for reference only and cannot be directly used for diagnostic interpretation.**
 - **EWS cannot be used as an prognosis index. It is not a clinical judgement tool. Clinicians must use their clinical judgement in conjunction with the EWS tool at all times.**
 - **MEWS and NEWS are intended for adult patients only. NEWS is not applicable to pregnant woman and COPD (Chronic Obstructive Pulmonary Disease) patients.**
-

NOTE

- **The EWS scores does not trigger any alarms, and cannot used for continuous monitoring.**
-

17.1.1 Displaying the EWS Numerics Area

To display the EWS numerics area, follow this procedure:

1. Access **Tile Layout** in either of the following ways:
 - ◆ Select the **Screen Setup** quick key → select the **Tile Layout** tab.
 - ◆ Select the **Main Menu** quick key → from the **Display** column select **Tile Layout**.
2. Select the parameter area where you want to display the EWS score, and then from the popup list select **EWS**.

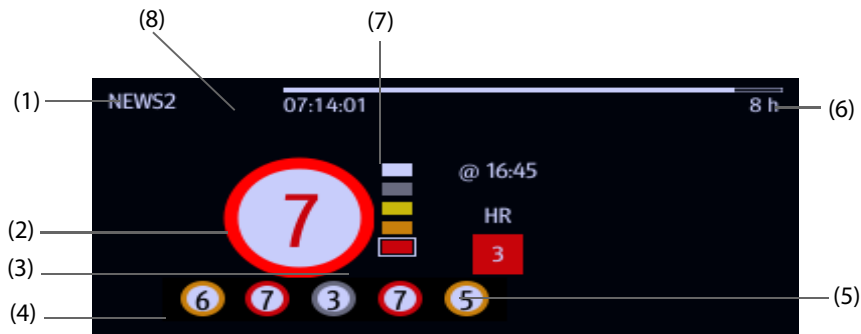



- (1) EWS label
- (2) Total score. The color of the circle indicates the level of risk.
- (3) Single parameter whose score reaches 3
- (4) Latest history total score
- (5) Risk level indicator. The level of risk increases from top down.
- (6) Scoring interval
- (7) The scoring time
- (8) Scoring countdown: time to the next scoring.

17.1.2 Accessing the EWS Screen

Access the EWS window in any of the following ways:

- Select the EWS parameter area
- Select the **EWS** quick key.
- Select the **Screen Setup** quick key → select the **Choose Screen** tab → select **EWS**.
- Select the **Main Menu** quick key → from the **CAA** column select **EWS**.

When the EWS screen is hidden as , you can also choose one of the following methods to quickly enter the EWS screen.

- Swipe left or right across the touchscreen with two fingers until you switch to the EWS screen.
- Swipe right across the touchscreen with a single finger.
- Select the  button.

Take NEWS2 as an example, the EWS screen is shown as follows. Your screen may be slightly different due to the configuration.

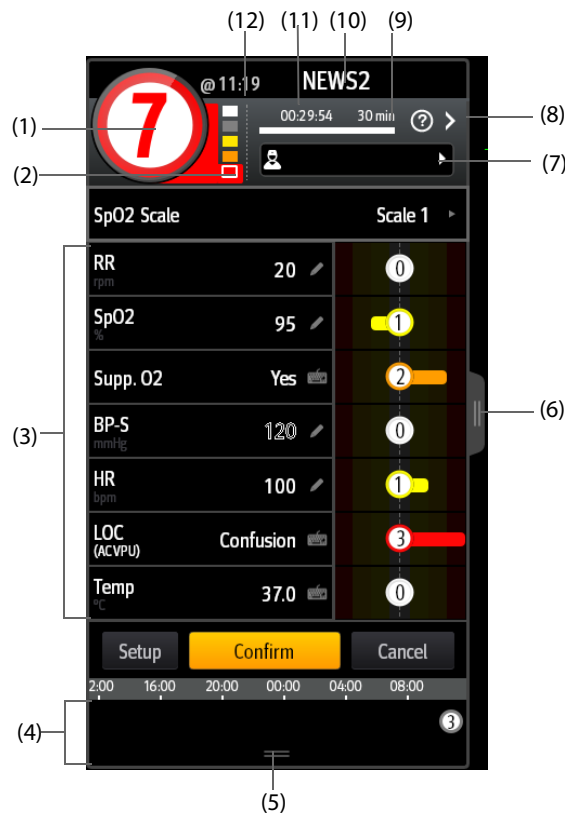

- (1) Total score. The color of the circle indicates the level of risk.
- (2) Risk level indicator. The level of risk increases from top down. The current level is enclosed by a white frame.
- (3) Parameter area: display the subscore and parameter value of each parameter. The keyboard symbol indicates that the parameter value is manually entered.
- (4) History total scores
- (5) Selecting this button expands the History Total Scores area where you can review the trends of the total score and each subscore.
- (6) Selecting this button or swiping right across the screen with one finger displays the trends of total score and parameter values for scoring.
- (7) Clinician ID (displays only when the Clinician ID is enabled): allows inputting the Clinician ID to associate with the EWS score. For more information, see 21.4.1 *Enabling Inputting the Clinician ID*.
- (8) Select this button to see the clinical response to the current score
- (9) Scoring interval
- (10) EWS protocol label
- (11) Scoring countdown: time to the next scoring.
- (12) The scoring time

17.1.3 Performing EWS Scoring

To perform scoring, follow this procedure:

1. Select **Reset** to clear the previous score and update values of currently monitored parameters and relevant subscores.
2. For NEWS2, set the **SpO2 Scale**.
 - ◆ **Scale 1:** for patient without hypercapnic respiratory failure.
 - ◆ **Scale 2:** for patients with a prescribed oxygen saturation requirement of 88–92% (for example, in patients with hypercapnic respiratory failure).

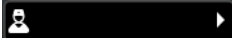
3. Measure or manually enter other required parameters and observations.
4. If enabled, select the clinician ID  .
5. Select **Calculate** to get the total score.
6. If **Score Confirmation** is enabled, select **Confirm** to save current scoring, or select **Cancel** to give up current scoring. Refer to section 17.1.4.2 *Setting the Scoring Confirmation Switch* for more information.

CAUTION

- **The decision to use Scale 2 of the SpO2 Scale should be made by a competent clinical decision maker and should be recorded in the patient's clinical notes.**
-

NOTE

- **Before calculating the score, select Reset to clear the previous score.**
 - **The keyboard symbol at the right of the parameter value indicates that the value is manually entered.**
 - **You can get the score only when all required parameters have been measured or entered.**
-

17.1.4 Changing EWS Settings

17.1.4.1 Changing the Scoring Protocol

The monitor is configured with a default scoring protocol. To change the scoring protocol, follow this procedure:

1. From the EWS page select **Setup**.
2. Set **Score**.

17.1.4.2 Setting the Scoring Confirmation Switch

To select if confirmation is required before saving score, follow this procedure:

1. From the EWS page select **Setup**.
2. Set **Scoring Confirmation** switch.
 - ◆ **Off:** the monitor automatically saves the scoring result after the scoring is completed.
 - ◆ **On:** you need to confirm that whether the scoring result is saved or not after the scoring is completed.

17.1.4.3 Setting the Manual Data Timeout

The manually input parameter data become invalid after a preset time. To set the timeout period for the input data, follow this procedure:

1. From the EWS screen select **Setup**.
2. From the **Manual Data Timeout** area, select a desired parameter and set its timeout period.

NOTE

- **If the data is expired and not updated, the monitor displays the corresponding parameter score in outline font, and gives a timeout alarm.**
-

17.1.4.4 Setting Auto Scoring

The monitor automatically starts scoring at the preset interval. To enable auto scoring, follow this procedure:

1. From the EWS page select **Setup**.
2. Set **Auto Scoring**:
 - ◆ **Interval:** the monitor automatically starts scoring at the preset interval.
 - ◆ **NIBP:** the monitor automatically starts scoring at the completion of each NIBP measurement.
 - ◆ **Alarm:** the monitor automatically starts scoring when an alarm occurs to the parameter for scoring.

- ◆ If no option is selected, the monitor does not initiate auto scoring.

17.1.4.5 Setting Auto Scoring Interval

1. From the EWS page select **Setup**.
2. Set **Interval**:
 - ◆ **By Score**: the monitor automatically starts scoring as per the interval selected for corresponding total score.
 - ◆ **5 min - 24 h**: If **Auto Scoring** is set to **Interval**, the monitor automatically starts scoring as per the selected interval. If **Auto Scoring** is not set to **Interval**, the countdown timer of manual scoring is selected.

17.1.4.6 Managing Operator ID

To manage the Operator ID, follow this procedure:

1. From the EWS page select **Setup**.
2. Select the **Manage Operator ID** button at the bottom left corner to add or delete the operator IDs.

NOTE

- **Manage Operator ID button is available when it is enabled in the Maintenance menu. For more information, see section 21.4.1.1 Displaying and Managing the Operator ID.**

17.2 Glasgow Coma Scale (GCS)

The Glasgow Coma Scale (GCS) function is based on 1974_Lancet_Teasdale Assessment of Coma and Impaired Consciousness-A Practical Scale. Three aspects of behavior are independently measured: eye opening, verbal response, and motor response. The scores are added together to indicate that patient's level of consciousness.

GCS is intended for adults and pediatric patients.

CAUTION

- **GCS is for reference only. Consult other clinical observations for diagnosis.**
- **GCS is not applied to patients that are sedated, muscularly relaxed, with artificial airway, drunk, hypothermia or in status epilepsies.**
- **GCS is not applied to deaf people and patients having language barrier or with mental disorder.**
- **When applied to children younger than five years old or to the elderly, the GCS score may not reflect actual function.**

17.2.1 Displaying the GCS Parameter Area

To Display the GCS parameter area, follow this procedure:

1. Access **Tile Layout** in either of the following ways:
 - ◆ Select the **Screen Setup** quick key → select the **Tile Layout** tab.
 - ◆ Select the **Main Menu** quick key → from the **Display** column select **Tile Layout**.
2. Select the parameter area where you want to display the GCS score, and then from the popup list select **GCS**.

The following figure shows the GCS parameter area. Your display may be configured to look slightly different.

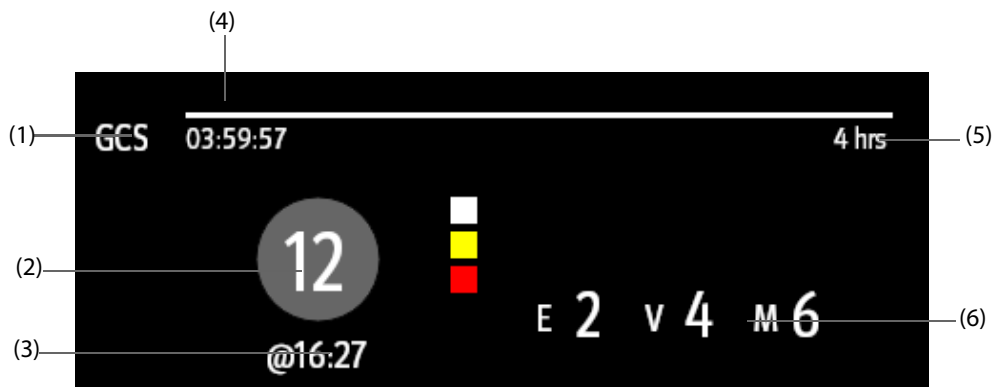

- (1) GCS label
 - (2) Total score and level of consciousness. The color of the circle indicates the level of risk.
 - (3) Scoring time
 - (4) Scoring countdown: time to the next scoring.
 - (5) Scoring interval
 - (6) Subscores
- ◆ E: eye opening
 - ◆ V: verbal response
 - ◆ M: motor response

17.2.2 Accessing the GCS Menu

Enter the GCS menu in any of the following ways:

- Select the GCS parameter area
- Select the **GCS** quick key.
- Select the **Main Menu** quick key → from the **CAA** column select **GCS**.

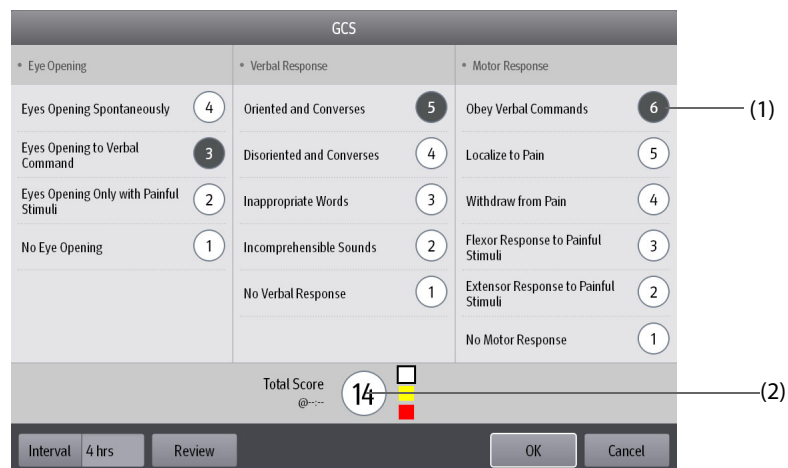

(1) Subscore

(2) Total score

17.2.3 Performing GCS Scoring

To perform scoring, follow this procedure:

1. From the **Eye Opening** area, **Verbal Response** area, and **Motor Response** area, respectively select an item that represents the patient's status.
2. Select **OK** to accept the total score.

The following table lists the default score range and color of relevant consciousness level.

<u>Level</u>	<u>Range</u>	<u>Color</u>
<u>Mild damage</u>	<u>12 to15</u>	<u>White</u>
<u>Moderate damage</u>	<u>5 to 11</u>	<u>Yellow</u>
<u>Severe damage</u>	<u>3 to 4</u>	<u>Red</u>

17.2.4 Setting GCS Scoring Interval

From the **GCS** menu, select **Interval** to set GCS scoring interval. When the scoring interval is reached and you do not perform another scoring, the score will be invalid and displayed as outline fonts.

17.2.5 Setting Threshold and Color for Each Consciousness Level

You can configure the threshold and color of each consciousness level. To do so, follow this procedure:

1. Select the **Main Menu** quick key → from the **System** column select **Maintenance** → input the required password → select **OK**.
2. Select the **CAA** tab → select the **GCS** tab.
3. Set high limit, low limit, and color for each level.

17.2.6 Reviewing GCS Trend Data

From the **GCS** menu, select **Review** to enter the **Review** menu and view the GCS trend data from the **Tabular Trends**.

17.3 SepsisSight™

The SepsisSight™ function is based on [Third International Consensus Definitions for Sepsis and Septic Shock \(Sepsis-3\)](#) and [Surviving Sepsis Campaign: International Guidelines for Management of Sepsis and Septic Shock: 2016 \(SSC Guideline 2016\)](#). It assists you in recognizing the early signs and symptoms of sepsis by comparing the state of the patient to the defined criteria and then guides you through the recommended treatment protocol.

CAUTION

- **SepsisSight is not a diagnostic or therapeutic tool and is not intended to replace the competent judgment of a clinician.**
- **SepsisSight should not be used with intravenous immunoglobulins in adult patients with severe sepsis or septic shock.**
- **SepsisSight should not be used with intravenous selenium for the treatment of severe sepsis.**
- **SepsisSight should not be used with sodium bicarbonate therapy for the purpose of improving hemodynamics or reducing vasopressor requirements in patients with hypoperfusion-induced lactic acidemia with pH ≥7.15.**

NOTE

- **SepsisSight is intended to perform routine screening of potentially infected seriously ill patients for severe sepsis to allow earlier implementation of therapy.**
- **SepsisSight is intended to be followed by application of hospital-based performance improvement efforts in severe sepsis.**
- **The Surviving Sepsis Campaign recommends to discuss goals of care and prognosis with patients and families.**
- **The Surviving Sepsis Campaign recommends to incorporate goals of care into treatment and end-of-life care planning, utilizing palliative care principles where appropriate.**
- **The SepsisSight goals of care are intended to be applied in a time defined by the SSC guidelines.**

- **Due to space limitations on the screen, the recommendations cannot always be reproduced in the full detail available in the printed and on-line guidelines.**
 - **SepsisSight is intended for patients suffering from sepsis or suspicion of sepsis.**
-

17.3.1 Accessing the SepsisSight Dialog

Enter the **SepsisSight** dialog in any of the following ways:

- **Select the SepsisSight quick key.**
- **Select the Main Menu quick key → from the CAA column select SepsisSight.**

17.3.2 Screening

As per Sepsis-3, SepsisSight supports quick Sepsis-Related Organ Failure Assessment (qSOFA, or quick SOFA) and Sepsis-Related Organ Failure Assessment (SOFA).

17.3.2.1 Performing qSOFA

qSOFA evaluates the patient's respiration rate, systolic blood pressure and altered mental status.

RR and BP-S being monitored are automatically obtained. You can also manually enter these values by selecting the  symbol. Select whether the patient's mental status is altered. Then qSOFA score is calculated.

If the qSOFA score is greater than or equal to 2, or sepsis is suspected, select **SOFA>>** to perform SOFA.

To clear the score, select **Reset**.

NOTE

- **The keyboard symbol  indicates that the parameter value is manually entered.**
 - **The question mark (?) in the score circle indicates that more parameter values are required before a score can be calculated.**
-

17.3.2.2 Performing SOFA

SOFA score is used to identify organ function or the rate of sepsis-related organ failure.

To perform SOFA, enter the value or select a range for each item, SOFA score will be automatically calculated.

To clear the score, select **Reset**.

If Sepsis criteria is met, make a comprehensive judgement on the clinical features.

17.3.2.3 Changing Screening Settings

From the **Screening** page select **Setup**. You can change the following settings:

- **In the Screening area, set RR (rpm) high limit and BP-S (mmHg) low limit for qSOFA scoring.**
- **In the Unit area, set the unit of Bilirubin and Creatinine.**

17.3.3 Recommendations

As per the SSC Guidelines 2016, SepsisSight provides graded recommendations. Pages **Part I** and **Part II** in the SepsisSight screen list these recommendations.

17.3.3.1 Viewing Detailed Recommendations

Select the **•••** icon at the right side of each item to view detailed recommendations of SSC Guideline 2016. The star symbol **★** indicates the grade of recommendation:

- **★ ★: strong recommendation**
- **★: weak recommendation**
- **No ★ symbol: ungraded strong recommendation**

17.3.3.2 **Marking Implemented Items**

Check off implemented items. Then the time and date are automatically recorded and displayed.

- You can select the  symbol to change the date and time.
- Select **Reset** to clear the current results.

17.3.4 **Reviewing SepsisSight Trend Data**

Select the **Graphic Trends** tab to view the trend of parameters of resuscitation.

When a recommended treatment is checked off on the **Part I** page and **Part II** page, relevant event is marked in the tabular trend. Vertical lines of different colors indicate the event type:

- White: inspection performed
- Blue: medication
- Green: goal achieved
- Purple: other treatment

17.4 **Rescuing Mode**

You can put the monitor into the rescue mode when rescuing a patient. In the rescue mode, the monitor displays the following information:

- Values and waveforms of physiological parameters
- CPR Dashboard

You can output the rescue report.

The rescue mode is intended for adult and pediatric patients.

WARNING

- **The rescue mode is not intended for neonatal patients.**
 - **In the rescue mode, all physiological alarms and part of technical alarms are disabled.**
-
-

NOTE

- **Licenses are required for the CPR Dashboard function.**
 - **A responsible nurse is required to record the rescue process. Recording shall not affect patient rescue.**
-

17.4.1 **Entering the Rescue Mode**

To enter the rescue mode, choose either of the following ways:

- Select the **Rescue Mode** quick key.
- Select the **Main Menu** quick key → from the **Alarm** column select **Rescue Mode**.

17.4.2 **CPR Dashboard**

The CPR Dashboard helps you record the medications and treatments administrated during patient rescue. You can record the following information on the monitor:

- Rescue start time and end time
- The use of drugs, for example adenaline, amiodarone and other drugs
- The administrated treatments, for example, CPR, defibrillation, and other treatments

17.4.2.1 Accessing the CPR Dashboard

If you are entering the rescue mode for the first time, the CPR Dashboard opens automatically. If you have closed the CPR Dashboard, to open it, select the **Main Menu** quick key → from the **CAA** column select **CPR Dashboard**.

17.4.2.2 Recording the Rescue Process

To record the rescue process using the CPR Dashboard, do as follows:

- To record the rescue start time: select **Start Rescue**. When entering the rescue mode, the monitor automatically records the rescue start time.
- To record the medications and the doses, select **Adrenaline**, **Amiodarone**, or **Other Drugs** accordingly.
- To record the treatments, select **Start Compression/Pause Compression**, **Defibrillation**, or **Other Treatment** accordingly.
- To record the rescue end time, select **End Rescue**.

17.4.2.3 Saving the Rescue Record

On the CPR Dashboard, select **Save** to save the rescue record.

17.4.2.4 Exporting the Rescue Record

You can export the rescue record using a USB drive. To do so, follow this procedure:

1. Connect the N1 and Dock.
2. Connect the USB drive to the Dock's USB connector.
3. Select **Export**.

17.4.2.5 Customizing Drugs and Treatments

Besides sodium bicarbonate, vasopressin, and atropine, you can define another five drugs.

Besides tracheal intubation and establishing IV access, you can define another two types of treatment.

To customize drugs and treatments, follow this procedure:

1. Select the **Main Menu** quick key → from the **System** column select **Maintenance** → input the required password → select .
2. Select the **CAA** tab → **CPR** tab.
3. Select the **Customized Drug** tab to define the commonly used drugs.
4. Select the **Customized Treatment** tab to define the normal treatments.

17.4.2.6 Closing the CPR Dashboard

CPR Dashboard automatically closes when you exit the rescue mode. In the rescue mode, if you want to close the CPR Dashboard, choose any of the following ways:

- Select the exit key at the top right corner of the CPR Dashboard.
- Select the **Main Menu** quick key → from the **CAA** column select **Exit CPR Dashboard**.

17.4.3 Exit the Rescue Mode

To exit the rescue mode, choose either of the following ways:

- Select the **Exit Rescue Mode** quick key.
- Select the **Main Menu** quick key → from the **Alarm** column select **Exit Rescue Mode**.

18 Calculation (only available for the independent external display)

18.1 Calculation Overview

The monitor provides calculation functions. The calculated values, which are not directly measured, are computed based on the values you provide. The calculation feature is independent of other monitoring functions and can be therefore used for patients being monitored by other monitors. Any operation in a calculation window does not affect the patient monitored by the current monitor.

You can perform the following calculations:

- Drug calculations
- Hemodynamic calculations
- Oxygenation calculations
- Ventilation calculations
- Renal calculations

18.2 Calculation Safety Information

WARNING

- **Decisions on the choice and dosage of drugs administered to patients must always be made by the physician in charge. The drug calculations are based on the values input, it does not check the plausibility of the calculation performed.**
 - **Check that the entered values are correct and the calculated values are appropriate. We assume no responsibility for any consequences caused by wrong entries and improper operations.**
-
-

18.3 Drug Calculations

The monitor provides the drug calculation function.

18.3.1 Performing Drug Calculations

To perform drug calculations, follow this procedure:

1. Access drug calculator by either of the following ways:
 - ◆ Select the **Calculations** quick key.
 - ◆ Select the **Main Menu** quick key → from the **Calculations** column select **Drug**.
2. Set **Drug Name** and **Patient Category**. If the dose of drug is weight dependent, you must input the patient's weight. The dose calculation program has a library of commonly used drugs, of which Drug A through Drug E are user defined.
3. Enter the known values, for example **Drug Amount** and **Solution Volume**.
4. Select **Calculate**. The calculated values are indicated by red arrows.

NOTE

- **If available, the patient category and weight from the Patient Demographics menu are automatically entered when you first access drug calculation. You can change the patient category and weight. This will not change the patient category and weight stored in the patient demographic information.**
-

18.3.2 Checking the Titration Table

The titration table shows information on the currently used drugs. Use the titration table to see what dose of a drug your patient will receive at different infusion rates. To access the titration table, follow this procedure:

1. Access drug calculator by either of the following ways:
 - ◆ Select the **Calculations** quick key.
 - ◆ Select the **Main Menu** quick key → from the **Calculations** column select **Drug**.
2. Select the **Titration Table** tab.
3. Select **Dose Type** to set the type of dose unit in the titration table.
4. Select **Interval** to set the interval between two adjacent titration table items.

You can select how to display the titration table:

- **Dose:** the titration table is listed in the sequence of increased drug dose.
- **Infusion Rate:** the titration table is listed in the sequence of increased infusion rate. Normally the resolution of the infusion rate is one (1). By selecting **Exact Rate** the resolution of the infusion rate can reach 0.01 so that you can display the infusion rate more accurately.

18.3.3 Drug Calculation Formula

Description	Unit	Formula
Dose	Dose/hr Dose/min	$\text{Dose} = \text{Infusion Rate} \times \text{Concentration}$
Dose (weight based)	Dose/kg/hr Dose/kg/min	$\text{Dose (weight based)} = \text{Infusion Rate} \times \text{Concentration/Weight}$
Drug Amount	g series: mcg, mg, g unit series: Unit, KU, MU mEq series: mEq	$\text{Drug Amount} = \text{Dose} \times \text{Duration}$
Drug Amount (weight based)	g series: mcg, mg, g unit series: Unit, KU, MU mEq series: mEq	$\text{Drug Amount (weight based)} = \text{Dose} \times \text{Duration} \times \text{Weight}$
Duration	hr	$\text{Duration} = \text{Amount/Dose}$
Duration (weight based)	hr	$\text{Duration (weight based)} = \text{Amount}/(\text{Dose} \times \text{Weight})$
Concentration	mcg/ml, mg/ml, g/ml, Unit/ml, KU/ml, MU/ml, mEq/ml	$\text{Concentration} = \text{Drug Amount}/\text{Solution Volume}$
Solution volume	ml	$\text{Volume} = \text{Infusion Rate} \times \text{Duration}$
Infusion rate	ml/hr	$\text{Infusion Rate} = \text{Dose}/\text{Concentration}$
Infusion rate (weight based)	g·ml/hr	$\text{Infusion Rate} = \text{Dose} \times \text{Weigh}/\text{Concentration}$

18.3.4 Titration Table Calculation Formula

Description	Unit	Formula
Infusion Rate	ml/hr	$\text{Infusion Rate} = \text{Dose}/\text{Concentration}$
Infusion Rate (weight based)	ml/hr	$\text{Infusion Rate} = \text{Weight} \times \text{Dose}/\text{Concentration}$
Dose	Dose/hr Dose/min	$\text{Dose} = \text{Infusion Rate} \times \text{Concentration}$
Dose (weight based)	Dose/kg/hr Dose/kg/min	$\text{Dose (weight based)} = \text{INF Rate} \times \text{Concentration}/\text{Weight}$

18.4 Hemodynamic Calculations

The monitor provides the hemodynamic calculation function. The monitor can save the results of up to 10 calculations, which are displayed in groups.

18.4.1 Performing Hemodynamic Calculations

To perform hemodynamic calculation, follow this procedure:

1. Access hemodynamic calculation by either of the following ways:
 - ◆ Select the **Calculations** quick key → **Hemodynamics** tab.
 - ◆ Select the **Main Menu** quick key → from the **Calculations** column select **Hemodynamics**.
2. Enter the known values. For a patient who is being monitored, the currently measured values are automatically taken.
3. Select **Calculate**.

The calculated value greater than the normal upper limit is indicated by an up arrow “↑”. The calculated value lower than the normal lower limit is indicated by a down arrow “↓”.

You can select **Range** to show the normal range of each parameter.

18.4.2 Input Parameters for Hemodynamic Calculations

Input Parameter	Label	Unit
cardiac output	C.O.	L/min
heart rate	HR	bpm
pulmonary artery wedge pressure	PAWP	mmHg
artery mean pressure	PMAP	mmHg
pulmonary artery mean pressure	PA Mean	mmHg
central venous pressure	CVP	mmHg
end-diastolic volume	EDV	ml
height	Height	cm
weight	Weight	kg

NOTE

- If you enable Use PA-D as PAWP, PA-D value will be used to replace PAWP value for hemodynamic calculation. For more information, refer to 14.6.6 Setting the Use PA-D as PAWP Switch (only available for the independent external display).

18.4.3 Calculated Parameters and Formulas for Hemodynamic Calculations

Calculated Parameters	Label	Unit	Formula
cardiac index	C.I.	L/min/m ²	C.I. (L/min/m ²) = C.O. (L/min)/BSA (m ²)
body surface area	BSA	m ²	BSA (m ²) = Wt ^{0.425} (kg) × Ht ^{0.725} (cm) × 0.007184
stroke volume	SV	ml	SV (ml) = 1000 × C.O. (L/min)/HR (bpm)
stroke index	SVI	ml/m ²	SVI (ml/m ²) = SV (ml)/BSA (m ²)
systemic vascular resistance	SVR	DS/cm ⁵	SVR (DS/cm ⁵) = 79.96 × [APMAP (mmHg) - CVP (mmHg)]/C.O. (L/min)

Calculated Parameters	Label	Unit	Formula
systemic vascular resistance index	SVRI	$DS \cdot m^2/cm^5$	$SVRI (DS \cdot m^2/cm^5) = SVR (DS/cm^5) \times BSA (m^2)$
pulmonary vascular resistance	PVR	DS/cm^5	$PVR (DS/cm^5) = 79.96 \times [PAMAP (mmHg) - PAWP (mmHg)]/C.O. (L/min)$
pulmonary vascular resistance index	PVRI	$DS \cdot m^2/cm^5$	$PVRI (DS \cdot m^2/cm^5) = PVR (DS/cm^5) \times BSA (m^2)$
left cardiac work	LCW	$kg \cdot m$	$LCW (kg \cdot m) = 0.0136 \times APMAP (mmHg) \times C.O. (L/min)$
left cardiac work index	LCWI	$kg \cdot m/m^2$	$LCWI (kg \cdot m/m^2) = LCW (kg \cdot m)/BSA (m^2)$
left ventricular stroke work	LVSW	$g \cdot m$	$LVSW (g \cdot m) = 0.0136 \times APMAP (mmHg) \times SV (ml)$
left ventricular stroke work index	LVSWI	$g \cdot m/m^2$	$LVSWI (g \cdot m/m^2) = LVSW (g \cdot m)/BSA (m^2)$
right cardiac work	RCW	$kg \cdot m$	$RCW (kg \cdot m) = 0.0136 \times PAMAP (mmHg) \times C.O. (L/min)$
right cardiac work index	RCWI	$kg \cdot m/m^2$	$RCWI (kg \cdot m/m^2) = RCW (kg \cdot m)/BSA (m^2)$
right ventricular stroke work	RVSW	$g \cdot m$	$RVSW (g \cdot m) = 0.0136 \times PAMAP (mmHg) \times SV (ml)$
right ventricular stroke work index	RVSWI	$g \cdot m/m^2$	$RVSWI (g \cdot m/m^2) = RVSW (g \cdot m)/BSA (m^2)$
ejection fraction	EF	%	$EF (\%) = 100 \times SV (ml)/EDV (ml)$
End-diastolic volume index	EDVI	ml/m^2	$EDVI (ml/m^2) = EDV (ml)/BSA (m^2)$
End-systolic Volume	ESV	ml	$ESV (ml) = EDV (ml) - SV (ml)$
End-systolic Volume index	ESVI	ml/m^2	$ESVI (ml/m^2) = ESV (ml)/BSA (m^2)$

18.5 Oxygenation Calculations

The monitor provides the oxygenation calculation function. The monitor can save the results of up to 10 calculations, which are displayed in groups.

18.5.1 Performing Oxygenation Calculations

To perform oxygenation calculations, follow this procedure:

1. Access oxygenation calculation by either of the following ways:
 - ◆ Select the **Calculations** quick key → **Oxygenation** tab.
 - ◆ Select the **Main Menu** quick key → from the **Calculations** column select **Oxygenation**.
2. Enter the known values. For a patient who is being monitored, the currently measured values are automatically taken.
3. Select **Calculate**.

The calculated value greater than the normal upper limit is indicated by an up arrow "↑". The calculated value lower than the normal lower limit is indicated by a down arrow "↓".

In the **Oxygenation** page, you can also perform the following operations:

- Select **Oxycont Unit**, **Hb Unit**, and **Pressure Unit**. Then corresponding parameter values will be automatically converted and updated accordingly.
- Select **Range** to show the normal range of each parameter.

18.5.2 Input Parameters for Oxygenation Calculations

Input Parameter	Label	Unit
cardiac output	C.O.	L/min
percentage fraction of inspired oxygen	FiO ₂	%
partial pressure of oxygen in the arteries	PaO ₂	mmHg, kPa
partial pressure of carbon dioxide in the arteries	PaCO ₂	mmHg, kPa
arterial oxygen saturation	SaO ₂	%
partial pressure of oxygen in venous blood	PvO ₂	mmHg, kPa
venous oxygen saturation	SvO ₂	%
hemoglobin	Hb	g/L, g/dl, mmol/L
respiratory quotient	RQ	None
atmospheric pressure	ATMP	mmHg, kPa
height	Height	cm, inch
weight	Weight	kg, lb

18.5.3 Calculated Parameters and Formulas for Oxygenation Calculations

Calculated Parameters	Label	Unit	Formula
body surface area	BSA	m ²	$BSA (m^2) = Wt^{0.425} (kg) \times Ht^{0.725} (cm) \times 0.007184$
oxygen consumption	VO ₂	ml/min	$VO_2 (ml/min) = C(a-v)O_2 (ml/L) \times C.O. (L/min)$
arterial oxygen content	CaO ₂	ml/L, ml/dL	$CaO_2 (ml/L) = 10 \times (0.0134 \times Hb (g/dl) \times SaO_2 (\%)) + 0.031 \times PaO_2 (mmHg)$
venous oxygen content	CvO ₂	ml/L, ml/dL	$CvO_2 (ml/L) = 10 \times (0.0134 \times Hb (g/dl) \times SvO_2 (\%)) + 0.031 \times PvO_2 (mmHg)$
arteriovenous oxygen content difference	C(a-v)O ₂	ml/L, ml/dl	$C(a-v)O_2 (ml/L) = CaO_2 (ml/L) - CvO_2 (ml/L)$
oxygen extraction ratio	O ₂ ER	%	$O_2ER (\%) = 100 \times C(a-v)O_2 (ml/L) / CaO_2 (ml/L)$
oxygen transport	DO ₂	ml/min	$DO_2 (ml/min) = C.O. (L/min) \times CaO_2 (ml/L)$
partial pressure of oxygen in the alveoli	PAO ₂	mmHg, kPa	$PAO_2 (mmHg) = [ATMP (mmHg) - 47 mmHg] \times FiO_2 (\%)/100 - PaCO_2 (mmHg) \times [FiO_2 (\%)/100 + (1 - FiO_2 (\%)/100)/RQ]$
alveolar-arterial oxygen difference	AaDO ₂	mmHg, kPa	$AaDO_2 (mmHg) = PAO_2 (mmHg) - PaO_2 (mmHg)$
capillary oxygen content	CcO ₂	ml/L, ml/dl	$CcO_2 (ml/L) = Hb (g/L) \times 1.34 + 0.031 \times PAO_2 (mmHg)$
venous admixture	QS/QT	%	$QS/QT (\%) = 100 \times [1.34 \times Hb (g/L) \times (1 - SaO_2 (\%)/100) + 0.031 \times (PAO_2 (mmHg) - PaO_2 (mmHg))] / [1.34 \times Hb (g/L) \times (1 - SvO_2 (\%)/100) + 0.031 \times (PAO_2 (mmHg) - PvO_2 (mmHg))]$
oxygen transport index	DO ₂ I	ml/min/m ²	$DO_2I (ml/min/m^2) = CaO_2 (ml/L) \times (C.O. (L/min) / BSA (m^2))$
oxygen consumption	VO ₂ I	ml/min/m ²	$VO_2I (ml/min/m^2) = C(a-v)O_2 (ml/L) \times (C.O. (L/min) / BSA (m^2))$

18.6 Ventilation Calculations

The monitor provides the ventilation calculation function. The monitor can save the results of up to 10 calculations, which are displayed in groups.

18.6.1 Performing Ventilation Calculations

To perform ventilation calculations, follow this procedure:

1. Access ventilation calculation by either of the following ways:
 - ◆ Select the **Calculations** quick key → **Ventilation** tab.
 - ◆ Select the **Main Menu** quick key → from the **Calculations** column select **Ventilation**.
2. Enter the known values. For a patient who is being monitored, the currently measured values are automatically taken. If the anesthesia machine or ventilator is connected, measured values for ventilation calculation are also automatically taken.
3. Select **Calculate**.

The calculated value greater than the normal upper limit is indicated by an up arrow “↑”. The calculated value lower than the normal lower limit is indicated by a down arrow “↓”.

On the **Ventilation** page, you can also perform the following operations:

- Select **Pressure Unit**. Then corresponding parameter values will be automatically converted and updated accordingly.
- Select **Range** to show the normal range of each parameter.

18.6.2 Input Parameters for Ventilation Calculations

Input Parameter	Label	Unit
percentage fraction of inspired oxygen	FiO ₂	%
respiration rate	RR	rpm
partial pressure of mixed expiratory CO ₂	PeCO ₂	mmHg, kPa
partial pressure of carbon dioxide in the arteries	PaCO ₂	mmHg, kPa
partial pressure of oxygen in the arteries	PaO ₂	mmHg, kPa
tidal volume	TV	ml
respiratory quotient	RQ	None
atmospheric pressure	ATMP	mmHg, kPa

18.6.3 Calculated Parameters and Formulas for Ventilation Calculations

Calculated Parameters	Label	Unit	Formula
partial pressure of oxygen in the alveoli	PAO ₂	mmHg, kPa	$PAO_2 \text{ (mmHg)} = [ATMP \text{ (mmHg)} - 47 \text{ mmHg}] \times FiO_2 \text{ (\%)/100} - PaCO_2 \text{ (mmHg)} \times [FiO_2 \text{ (\%)/100} + (1 - FiO_2 \text{ (\%)/100})/RQ]$
alveolar-arterial oxygen difference	AaDO ₂	mmHg, kPa	$AaDO_2 \text{ (mmHg)} = PAO_2 \text{ (mmHg)} - PaO_2 \text{ (mmHg)}$
oxygenation ratio	Pa/FiO ₂	mmHg, kPa	$Pa/FiO_2 \text{ (mmHg)} = 100 \times PaO_2 \text{ (mmHg)}/FiO_2 \text{ (\%)}$
arterial to alveolar oxygen ratio	a/AO ₂	%	$a/AO_2 \text{ (\%)} = 100 \times PaO_2 \text{ (mmHg)}/PAO_2 \text{ (mmHg)}$
minute volume	MV	L/min	$MV \text{ (L/min)} = [TV \text{ (ml)} \times RR \text{ (rpm)}]/1000$

Calculated Parameters	Label	Unit	Formula
volume of physiological dead space	Vd	ml	$Vd (ml) = TV (ml) \times [1 - PeCO_2 (mmHg)/PaCO_2 (mmHg)]$
physiologic dead space in percent of tidal volume	Vd/Vt	%	$Vd/Vt (\%) = 100 \times Vd (ml)/TV (ml)$
alveolar volume	VA	L/min	$VA (L/min) = [TV (ml) - Vd (ml)] \times RR (rpm) / 1000$

18.7 Renal Calculations

The monitor provides the renal calculation function. The monitor can save the results of up to 10 calculations, which are displayed in groups.

18.7.1 Performing Renal Calculations

To perform renal calculations, follow this procedure:

- Access renal calculation by either of the following ways:
 - ◆ Select the **Calculations** quick key → select the **Renal** tab.
 - ◆ Select the **Main Menu** quick key → from the **Calculations** column select **Renal**.
- Enter the known values. .
- Select **Calculate**.

The calculated value greater than the normal upper limit is indicated by an up arrow "↑". The calculated value lower than the normal lower limit is indicated by a down arrow "↓". You can select **Range** to show the normal range of each parameter.

18.7.2 Calculated Parameters and Formulas for Renal Calculations

Input Parameter	Label	Unit
urine potassium	URK	mmol/L
urinary sodium	URNa	mmol/L
urine	Urine	ml/24 hrs
plasma osmolality	Posm	mOsm/kgH ₂ O
urine osmolality	Uosm	mOsm/kgH ₂ O
serum sodium	SerNa	mmol/L
creatinine	Cr	μmol/L
urine creatinine	UCr	μmol/L
blood urea nitrogen	BUN	mmol/L
height	Height	cm
weight	Weight	kg

18.7.3 Calculated Parameters and Formulas for Renal Calculations

Calculated Parameters	Label	Unit	Formula
urine sodium excretion	URNaEx	mmol/24 hrs	$URNaEx (mmol/24 hrs) = Urine (ml/24 hrs) \times URNa (mmol/L)/1000$

Calculated Parameters	Label	Unit	Formula
urine potassium excretion	URKEx	mmol/24 hrs	$URKEx \text{ (mmol/24 hrs)} = \text{Urine (ml/24 hrs)} \times URK \text{ (mmol/L)} / 1000$
sodium potassium ratio	Na/K	%	$Na/K \text{ (\%)} = 100 \times URNa \text{ (mmol/L)} / URK \text{ (mmol/L)}$
clearance of sodium	CNa	ml/24 hrs	$CNa \text{ (ml/24 hrs)} = URNa \text{ (mmol/L)} \times \text{Urine (ml/24 hrs)} / SerNa \text{ (mmol/L)}$
creatinine clearance rate	Clcr	ml/min	$Clcr \text{ (ml/min)} = Ucr \text{ (\mu mol/L)} \times \text{Urine (ml/24 hrs)} / [Cr \text{ (\mu mol/L)} \times (BSA \text{ (m}^2\text{)} / 1.73) \times 1440]$
fractional excretion of sodium	FENa	%	$FENa \text{ (\%)} = 100 \times URNa \text{ (mmol/L)} \times Cr \text{ (\mu mol/L)} / [SerNa \text{ (mmol/L)} \times Ucr \text{ (\mu mol/L)}]$
osmolar clearance	Cosm	ml/min	$Cosm \text{ (ml/min)} = Uosm \text{ (mOsm/kgH}_2\text{O)} \times \text{Urine (ml/24 hrs)} / (Posm \text{ (mOsm/kgH}_2\text{O)} \times 1440)$
free water clearance	CH2O	ml/hr	$CH2O \text{ (ml/hr)} = \text{Urine (ml/24 hrs)} \times [1 - Uosm \text{ (mOsm/kgH}_2\text{O)} / Posm \text{ (mOsm/kgH}_2\text{O)}] / 24$
urine to plasma osmolality ratio	U/P osm	None	$U/P \text{ osm} = Uosm \text{ (mOsm/kgH}_2\text{O)} / Posm \text{ (mOsm/kgH}_2\text{O)}$
blood urea nitrogen creatinine ratio	BUN/Cr*	Mmol/L	$BUN/Cr = 1000 \times BUN \text{ (mmol/L)} / Cr \text{ (\mu mol/L)}$
urine-serum creatinine ratio	U/Cr	None	$U/Cr \text{ (mmol/L)} = Ucr \text{ (\mu mol/L)} / Cr \text{ (\mu mol/L)}$

*: BUN/Cr is a ratio at mol unit system.

19 Printing

19.1 Printer

The monitor can output patient reports via a connected network printer. So far, the monitor supports the following printer:



- HP LaserJet Pro M202dw
- HP LaserJet Enterprise M605
- HP LaserJet P4015n
- HP LaserJet Pro 400 M401n
- HP LaserJet 600 M602

NOTE

- **For more details about the printer, see the document accompanying the printer. With product upgrades, the monitor may support more printers and no prior notice will be given. If you have any doubt about the printer you have purchased, contact Mindray.**
-

19.2 Setting the Printer

To set a network printer, follow this procedure:

1. Select the **Main Menu** quick key → from the **System** column select **Maintenance** → input the required password → select .
2. Select the **Print** tab.
3. Select **Printer IP Address**. Select the edit icon  on the right of the printer IP address input box. Enter an IP of a printer that is located in the same LAN with the monitor.
4. Select **Paper Size**.
5. Select **Resolution**.

After finishing configurations, you can select **Print Test Page** to verify that the printer works properly.

19.3 Setting Patient Information on the Reports

You can customize patient information that appears on the printed Reports.

19.3.1 Setting Patient Information on ECG Reports

To set the patient information you want to display on an ECG reports, follow this procedure:

1. Select the **Main Menu** quick key → from the **System** column select **Maintenance** → input the required password → select .
2. Select the **Print** tab.
3. select the **ECG Report** tab.
4. On the right of the **ECG Report** window, select the desired patient information items. Patient ID, patient name, age, and gender are displayed on an ECG report by default.

NOTE

- **You can only set the patient information displays on the ECG report from the ECG Report page. Patient information configured in the Report Layout page is not applied to ECG reports.**
-

19.3.2 Setting Patient Information on Other Reports

To set the patient information you want to display on other reports, follow this procedure:

1. Select the **Main Menu** quick key → from the **System column** select **Maintenance** → input the required password → select .
2. Select the **Print** tab.
3. Select the **Report Layout** tab.
4. Select the desired items under **Report Name**. **N/A** indicates that this item is not displayed on a report.

19.4 Setting End Case Reports

All normal reports can be set as end case reports. If you enable **Print End Case Report** when you discharge a patient, the monitor will automatically print the end case reports.

To set a normal report as an end case report, follow this procedure:

1. Select the **Main Menu** quick key → from the **Report** column select **End Case Report**.
2. Select the desired report tab, for example **ECG Report**.
3. Switch on **Set As End Case Report** to set the selected report to the end case report.

19.5 Manually Starting a Printing Task

You can start a printing task manually.

19.5.1 Starting Printing from the Current Page

From the current page, select the  button, if available, to start printing.

19.5.2 Printing Realtime Reports

Select the  quick key to print a realtime report. You can also print a realtime report from the **Normal Report** page. For more information, see *19.5.3 Printing Normal Reports*.

19.5.3 Printing Normal Reports

Normal reports refers to the following types of reports:

- ECG Report
- Realtime Report
- Tabular Trends Report
- Graphic Trend Report.

To print normal reports, follow this procedure:

1. Select the **Main Menu** quick key → from the **Report** column select **Normal Report**.
2. Select the desired report tab.
3. Check the settings.
4. Select **Print**.

19.6 Automatically Printing Reports

When a parameter alarm switch is set to on and an alarm is triggered for this parameter, you can set a printer to start alarm printing automatically.

To do so, follow this procedure:

1. Access alarm related tabs such as the **Alarm** tab for a parameter in one of the following ways:
 - ◆ Select the parameter or waveform area of the desired parameter → select the **Alarm** tab.

- ◆ Select the **Main Menu** quick key → from the **Parameters** column select **Setup** → select the **desired parameter** → select the **Alarm** tab.

2. Switch on **On/Off** and **Alarm outputs** for desired parameters.

19.7 Stopping a Printing Task

To stop a printing task, follow this procedure:

1. Select the **Main Menu** quick key → from the **Report** column select **Print Queue**.
2. Select desired printing tasks and then select **Delete**. Selecting **Delete All** to stop all the printing tasks.

19.8 Setting Reports

This section focuses on how to set ECG reports, realtime reports, tabular trends reports, and graphic trends reports.

19.8.1 Setting ECG Reports

To set ECG reports, follow this procedure:

1. Select the **Main Menu** quick key → from the **Report** column select **Normal Report**.
2. Select **ECG Report**.
3. Set **the desired options**. The following table only lists some of the options.

Menu item	Function	Description
Auto Interval	Defines the spacing between the ECG waveforms on a printout	<p>On: automatically adjusts the space between waveforms to avoid overlapping.</p> <p>Off: each waveform area has the same size on a printout.</p>
Note: This setting is only relevant when 12x1 is selected for 12-Lead Format .		
12-Lead Format	Select the format of 12-lead ECG waveforms on a printout.	<p>12x1: displays 12-lead ECG waveforms on one page in one column.</p> <p>6x2: displays 12-lead ECG waveforms on one page in two columns, with 6 lines in each column.</p> <p>6x2+1: displays 12-lead ECG waveforms on one page in two columns, with 6 lines in each column, and one rhythm lead waveform at the bottom.</p> <p>3x4+1: displays 12-lead ECG waveforms on one page in 4 columns, with 3 lines in each column, and one rhythm lead waveform at the bottom.</p> <p>3x4+3: displays 12-lead ECG waveforms on one page in 4 columns, with 3 lines in each column, and three rhythm lead waveforms at the bottom.</p>
Rhythm Lead 1 Rhythm Lead 2 Rhythm Lead 3	Select the lead that will be used as Rhythm Lead 1, 2, or 3.	I, II, III, aVR, aVL, aVF, V1, V2, V3, V4, V5, V6
Note: This setting is only relevant when 6x2+1, 3x4+1, or 3x4+3 is selected for 12-Lead Format .		
Format sequence	Select the recording method of ECG report generated by auto measurement	<p>Sequential: 12-lead ECG data are recorded sequentially and displayed in 3 lines and 4 columns with 2.5 seconds of ECG data for each column.</p> <p>Simultaneous: Record simultaneous 12-lead ECG data.</p>

NOTE

- **When ECG Lead Set is set to 3-Lead, ECG report cannot be printed.**

19.8.2 Setting Realtime Reports

To set tabular realtime reports, follow this procedure:

1. Select the **Main Menu** quick key → from the **Report** column select **Normal Report**.
1. Select **Realtime Report**.
2. Set the desired options. The following table only list some of the options.

Menu item	Function	Description
Select Waveform	Select the desired waveform to print	Current Waveforms: prints the realtime report for current waveforms. Selected Waveforms: prints the realtime report for the selected waveforms.

19.8.3 Setting Tabular Trends Reports

To set tabular trends reports, follow this procedure:

1. Select the **Main Menu** quick key → from the **Report** column select **Normal Report**.
2. Select **Tabular Trends Report**.
3. Set the desired options. The following table only list some of the options.

Menu Item	Function	Description
Period	Select the period during which a tabular trends report will be printed.	Auto: one page of a tabular trends according to the selected interval.
Interval	Select the resolution of the tabular trends printed on a report.	NIBP, EWS, GCS, C.O.: at an interval of acquiring the values of selected parameter. (EWS, and GCS are only available for the independent external display) Auto: using the Interval setting of the Tabular Trends review page.
Report Format	Select the printing principle.	Parameter Oriented: print one page of report by parameters when Interval is set to Auto . Time Oriented: print one page of report by time when Interval is set to Auto .

19.8.4 Setting Graphic Trends Reports

To set graphic trends reports, follow this procedure:

1. Select the **Main Menu** quick key → from the **Report** column select **Normal Report**.
2. Select **Graphic Trends Report**.
3. Set the **desired options**.

19.8.5 Showing the Second Mark

To set whether you want to show second marks on the report output by the printer, follow this procedure.

1. Select the **Main Menu** quick key → from the **System** column select **Maintenance** → input the required password → select .
2. Select the **Print** tab → **Other** tab.
3. Enable or disable **Second Mark (Printer)**.

19.9 Viewing Printer Statuses

You can view the status of the most recent ten printing tasks in the **Print Queue** window. To view the status of printing tasks, follow this procedure:

1. Select the **Main Menu** quick key → from the **Report** column select **Print Queue**.
2. View the status of printing tasks in the **Print Queue** window. Each printing task includes a report title, printing time and the printing status. The printing statuses are printing, failed, retrying, and waiting.

19.10 Printer Out of Paper

When the printer runs out of paper, the print request will not be responded. If there are too many print jobs that are not responded, a printer error may occur. In these cases, you need to install paper and then re-send the print request. Restart the printer if necessary.

Therefore, you'd better ensure that there is enough paper in the printer before sending a print request.

20 Battery

20.1 Battery Introduction

This monitor is designed to run on rechargeable Lithium-ion battery power when the external power is not available. The monitor can switch between battery power and the external power without interrupting patient monitoring. If both the external power and the battery power are available, the monitor uses the external power in preference to the battery power.

20.2 Battery Safety Information

WARNING

- **Keep the battery out of children's reach.**
 - **Use only specified battery. Use of a different battery may present a risk of fire or explosion.**
 - **Keep the battery in their original package until you are ready to use them.**
 - **Do not expose the battery to liquid.**
 - **Do not crush, drop or puncture the battery. Mechanical abuse can lead to internal damage and internal short circuits. If a battery has been dropped or banged against a hard surface, whether damage is externally visible or not, remove the battery from use and dispose of it properly.**
 - **If the battery shows signs of damage or signs of leakage, replace it immediately. Use caution in removing the battery. Avoid contacting the leakage.**
 - **The battery should be charged only in this monitor.**
 - **Extremely high ambient temperature may cause battery overheat protection, resulting in monitor shutdown.**
 - **The lithium-ion battery has a service life. Replace your battery when it reaches the end of its service life. Failure to replace the battery may cause serious damage to your equipment from battery overheating.**
 - **Do not open the battery, heat the battery above 60 °C, incinerate battery, or short battery terminals. They may ignite, explode, leak or heat up, causing personal injury.**
-

CAUTION

- **Remove the battery if it will not be used for an extended period of time.**
-

20.3 Installing the Battery

The battery must only be installed by service personnel trained and authorized by Mindray. To install the battery, contact your service personnel. The battery is installed when the monitor leaves the factory.

20.4 Battery Indications

The battery LED, on-screen battery symbol, battery power indicator, and related alarm messages indicate the battery status.

20.4.1 Battery LED

The battery LED lies on the lower right corner of the monitor front panel.

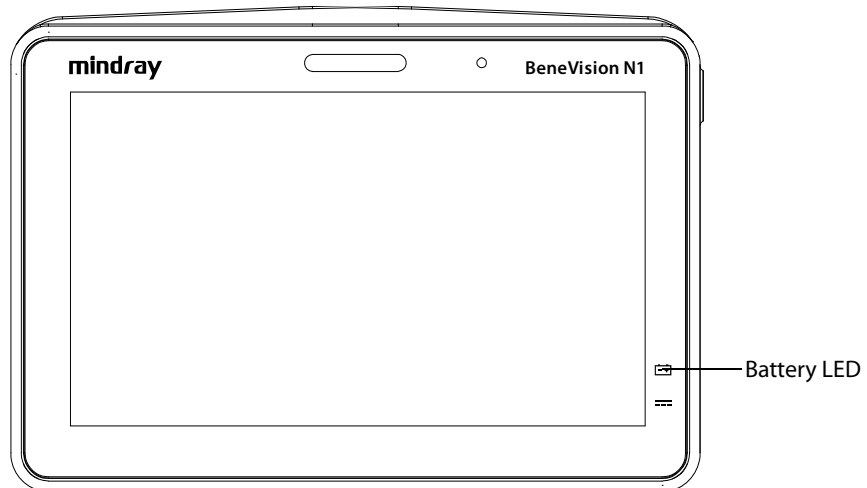







The battery LED indications are as follows:

- Yellow: the battery is being charged.
- Green: the battery is fully charged.
- Flashing green: the monitor runs on battery power.
- Flashing yellow: the battery is malfunctioning.
- Off: no battery is installed, or the monitor is powered off and no external power is connected.

20.4.2 Battery Symbols

The on-screen power indicator indicates the battery status as follows:

-  indicates that the battery works correctly. The green portion represents the remaining charge.
-  indicates that the battery power is low and needs to be charged.
-  indicates that the battery is almost depleted and needs to be charged immediately. Otherwise, the monitor will soon automatically shut down.
-  indicates that the battery is being charged.
-  indicates that no battery is installed.
-  indicates the battery fault, battery communication fault, or battery charging fault. Contact service personnel for help.

20.4.3 Battery Power Indicator

Battery power indicator displays the remaining battery power.



20.4.4 Battery-related Alarms

The capacity of the battery is limited. When the battery is low, the monitor presents the **Low Battery** alarm, the alarm lamp flashes, and the monitor produces an alarm sound.

If the battery is almost depleted, the monitor presents the **Critically Low Battery** alarm. In this case, immediately connect the external the monitor and charge the battery. Otherwise, the monitor will automatically shut down soon.

If the battery has been used for a prolonged period of time, the battery will be aged and its runtime may be significantly less than the specification. If the battery is aged, the **Battery Service Required** alarm is presented each time the monitor is turned on, indicating that the battery reaches its lifetime.

For more information on battery-related alarms, see *D Alarm Messages*.

20.4.5 Checking the Battery Information

To check the battery information, follow this procedure:

1. Select the **Main Menu** quick key → from the **System** column select **Maintenance** → input the required password → select .
2. Select the **Battery Information** tab.

20.5 Charging the Battery

To optimize performance, a fully (or nearly fully) discharged battery should be charged as soon as possible. The battery can be charged in any of the following methods:

- Method 1: the monitor is connected to the AC adapter or Dock.
- Method 2: the monitor is in use with the host monitor.
- Method 3: the monitor is in use with the Transport Dock.

For method 1 and method 3, the battery is charged in regardless of whether or not the monitor is currently turned on.

20.6 Maintaining the Battery

20.6.1 Conditioning the Battery

The performance of the battery deteriorates over time. You should condition the battery every two months.

To condition a battery, follow this procedure:

1. Disconnect the monitor from the patient and stop all monitoring and measuring procedures.
2. Turn off the monitor, and connect the monitor to the external power source.
3. Allow the battery to be charged uninterruptedly till it is fully charged.
4. Disconnect the monitor from the external power source, and turn on the monitor.
5. Allow the monitor to run on the battery until the battery is completely depleted and the monitor automatically shuts down.
6. Fully charge the battery again for use or charge it to 40 – 60% for storage.

NOTE

- **If the battery is not conditioned for a prolonged time, its charge indication may not be accurate and you may wrongly evaluate the remaining battery runtime.**
- **Do not use the monitor to monitor the patient during battery conditioning.**
- **Do not interrupt battery conditioning.**

20.6.2 Checking Battery Performance

Life expectancy of a battery depends on how frequent and how long it is used. When properly used, the lithium-ion battery has a useful life of approximately two years. If improperly used, its life expectancy can be shorten. We recommend replacing lithium-ion battery every two years.

The performance of a rechargeable battery deteriorates over time. You should check the battery performance every two months or if you doubt that the battery may fail.

See steps 1 to 5 of *20.6.1 Conditioning the Battery* to check battery performance. The operating time of the battery reflects their performance directly. If the operating time of a battery is noticeably shorter than that stated in the specifications, the battery may reach its service life or malfunction. If the battery performance meets the requirement, fully charge the battery again for use or charge it to 40 – 60% for storage.

NOTE

- **Battery operating time depends on equipment configuration and operation. For example, high display brightness or measuring NIBP repeatedly will shorten the battery operating time.**
-

20.7 Storing the Battery

When storing the battery, make sure that the battery terminals do not come into contact with metallic objects. If the battery are stored for an extended period of time, place the battery in a cool place with a partial charge of 40% to 60% capacity.

Condition the stored battery every three months. For more information, see *20.6.1 Conditioning the Battery*.

NOTE

- **Remove the battery from the equipment if the equipment is not used for a prolonged time (for example, several weeks). Otherwise the battery may overdischarge.**
 - **Storing the battery at high temperature for an extended period of time will significantly shorten their life expectancy.**
 - **Storing the battery in a cool place can slow the aging process. Ideally the battery should be stored at 15 °C.**
-

20.8 Recycling the Battery

Discard a battery in the following situations:

- The battery has visual signs of damage.
- The battery fails.
- The battery is aged and its runtime significantly less than the specification.
- The battery has been used for more than its service time.

Properly dispose of the battery according to local regulations.

WARNING

- **Do not open the battery, heat the battery above 60 °C, incinerate the battery, or short the battery terminals. They may ignite, explode, leak or heat up, causing personal injury.**
-
-

21 Care and Cleaning

21.1 Care and Cleaning Introduction

In this chapter we describe how to clean and disinfect the equipment.

21.2 Care and Cleaning Safety Information

WARNING

- Use only Mindray approved cleaners and disinfectants and methods listed in this chapter to clean or disinfect your equipment. Warranty does not cover damage caused by unapproved substances or methods.
 - We make no claims regarding the efficacy of the listed chemicals or methods as a means for controlling infection. For the method to control infection, consult your hospital's infection control officer or epidemiologist.
 - Do not attempt to clean the device while monitoring a patient.
 - It is recommend to turn off the equipment and disconnect from any power source before cleaning the equipment.
 - The responsible hospital or institution shall carry out all cleaning and disinfection procedures specified in this chapter.
-

CAUTION

- Avoid placing the device on surfaces with visible liquid spills.
 - Never immerse any part of the equipment or accessories in liquids or allow liquid to enter the interior.
 - Any contact of disinfectant solutions with metal parts may cause corrosion.
 - Do not pour or spray any liquid directly on the equipment or accessories or permit fluid to seep into connections or openings.
 - If you spill liquid on the equipment or accessories, disconnect the power supply, dry the equipment, and contact your service personnel.
 - Do not mix disinfecting solutions, such as bleach and ammonia, as hazardous gases may result.
 - Check the equipment after cleaning and disinfecting. If there is any sign of damage, remove it from use.
-

21.3 Recommended Cleaning and Disinfection Agents

The following table lists recommended cleaning and disinfection agents:

Product Name	Product Type	Ingredients
Water	Liquid	/
Mild soap	Liquid	/
Ethanol	Liquid	Ethanol 70%
Isopropyl alcohol	Liquid	Isopropyl alcohol 70%
Sodium hypochlorite bleach	Liquid	Sodium hypochlorite 10%
Hydrogen peroxide	Liquid	Hydrogen peroxide 3%

Product Name	Product Type	Ingredients
Rely+On™ Virkon®	Powder	Used as 1% solution* Biocidal active: Pentapotassium bis (peroxymonosulphate) bis (sulphate) (500g/kg) Contains dipotassium peroxodisulphate.
1-Propanol	Liquid	1-Propanol 50%
Dismozon® plus	Powder	Used as 0.4% solution* Active ingredient: Magnesium monoperoxyphthalate hexahydrate 958 mg/g
Mikrozid® AF liquid	Liquid, wipes	100g solution contains active ingredients: 25 g Ethanol (94 %) 35 g Propan-1-ol
perform® classic concentrateOXY	Powder	Used as 0.5% solution* 100 g contains 45 g Pentapotassium bis (peroxymonosulphate) bis (sulphate)

Note: *: Prepare the cleaning solution according to the concentration directed by the accompanying instructions for use.

21.4 General Cleaning Methods

Clean your equipment on a regular basis. Before cleaning the equipment, consult your hospital's regulations for cleaning the equipment.

To clean the main unit, follow this procedure:

1. Dampen a soft lint-free cloth with one of the approved cleaning agent.
2. Wring excess liquid from the cloth.
3. Wipe the display screen.
4. Wipe the external surface of the main unit, the Modular Rack, the Dock, or modules with the damp cloth, avoiding the connectors and metal pins.
5. Dry the surface with a clean cloth or paper towel. Allow the equipment air dry in a ventilated and cool place.

CAUTION

- **Always dilute according the manufacturer's instructions or use lowest possible concentration.**
 - **Take extra care when cleaning the screen because it is more sensitive to rough cleaning method than the housing. To clean the screen when the monitor is on, lock the touchscreen by selecting and swiping up the Unlock quick key until the Lock quick key appears.**
 - **Avoid pouring the liquid on the monitor while cleaning the monitor. Do not allow water or cleaning solution to enter the measurement connectors. Wipe around, not over, connector sockets and openings.**
 - **When cleaning the mouse, keyboard, or other peripheral devices, disconnect them from the monitor.**
-

21.5 Disinfection

Disinfect the monitor as required in your hospital's servicing schedule. Cleaning equipment before disinfecting is recommended.

21.6 Sterilization

Sterilization is not recommended for this monitor, related products, accessories, or supplies unless otherwise indicated in the Instructions for Use that accompany the products, accessories or supplies.

21.7 Cleaning, Disinfecting and Sterilizing Monitoring Accessories

To clean, disinfect and sterilize reusable transducers, sensors, cables, leadwires, and so forth, refer to the instructions delivered with the accessory. If no instructions are delivered with the accessory, the instructions given in this chapter for cleaning, disinfecting and sterilizing the monitor are applicable.

21.8 Impact of Improper Cleaning

Using cleaning agents other than those recommended may have the following impact:

- Product discoloration
- Metal part corrosion
- Brittle and breaking wires, connectors, and equipment housing
- Reduced cable and leadwire life
- Overall system performance degradation
- Equipment malfunction or failure

22 Maintenance

22.1 Maintenance Introduction

Regular maintenance is essential to ensure that the equipment functions properly. This chapter contains information on periodic testing and maintenance.

22.2 Maintenance Safety Information

WARNING

- **To avoid electric shock, stop using N1 if you find the housing of N1 has signs of broken. Contact the service personnel for help in that case.**
 - **Failure on the part of the responsible individual hospital or institution using this equipment to implement a recommended maintenance schedule may cause undue equipment failure and possible health hazards.**
 - **No modification of this equipment is allowed.**
 - **This equipment contains no user serviceable parts.**
 - **The safety checks or maintenance involving any disassembly of the equipment should be performed by professional service personnel. Otherwise, undue equipment failure and possible health hazards could result.**
 - **Do not open batteries, heat batteries to above 60 °C, incinerate batteries, or short the battery terminals. Batteries may ignite, explode, leak or heat up, causing personal injury.**
 - **The service personnel must be properly qualified and thoroughly familiar with the operation of the equipment.**
-

CAUTION

- **If you discover a problem with any of the equipment, contact your service personnel or Mindray.**
 - **Use and store the equipment within the specified temperature, humidity, and altitude ranges.**
 - **When disposing of the packaging material, be sure to observe the applicable waste control regulations and keep it out of children's reach.**
 - **At the end of its service life, the equipment, as well as its accessories, must be disposed of in compliance with the guidelines regulating the disposal of such products. If you have any questions concerning disposal of the equipment, please contact Mindray.**
-

NOTE

- **If needed, contact the manufacture for circuit diagrams, component part lists, descriptions, calibration instructions, or other information concerning the repair of the equipment.**
-

22.3 Maintenance and Testing Schedule

Follow the maintenance and testing schedule or local regulations to perform testing and maintenance. Make sure to clean and disinfect the equipment before taking any tests and maintenance

The following table lists the maintenance and testing schedule:

Test/Maintenance Item		Recommended Frequency
Performance Tests		
Visual inspection		Every day, before first use.
Measurement module performance test and calibration		1. If you suspect that the measurement values are incorrect. 2. Follow any repairs or replacement of relevant module. 3. Once a year for CO ₂ tests. 4. Once every two years for other parameter module performance tests.
Analog output test		If you suspect that the analog output function does not work properly.
Defibrillation synchronization test		If you suspect that the defibrillation synchronization function does not work properly.
Electrical Safety Tests		
Electrical safety tests		Once every two years.
Other Tests		
Power-on test		Before use.
Network printer tests		1. When first installed. 2. Follow any repair or replacement of the printer.
Battery check	Functionality test	1. When first installed. 2. When battery is replaced.
	Performance test	Every three months or if the battery runtime reduced significantly.

22.4 Checking Version Information

You may be asked for information on monitor and module version.

To view system software version information, select the **Main Menu** quick key → from the **System** column select **Version**.

You can also view more version information by following this procedure

1. Select the **Main Menu** quick key → from the **System** column select **Maintenance** → input the required password → select .
2. Select the **Version** tab.

You can check system software version, module hardware and software version, and firmware version.

22.5 Testing Methods and Procedures

Except the following maintenance tasks, all other test and maintenance tasks should be performed by Mindray-qualified service personnel only.

- Regular check, including visual inspection and power-on test
- Printer tests
- Battery check

If your monitor needs a safety test and performance test, contact the service personnel.

22.5.1 Performing Visual Inspection

Visually inspect the equipment before its first used every day. If you find any signs of damage, remove your monitor from use and contact the service personnel.

Verify that the equipment meets the following requirements:

- Environment and power supply specifications are met.
- The monitor housing and display screen are free from cracks or other damages
- The power cord is not damaged and the insulation is in good condition.
- Connectors, plugs, and cables are not damaged and kinked.
- Power cord and patient cables are securely connected with the equipment and modules.

22.5.2 Performing Power-on Test

The monitor automatically performs a selftest at startup. Check the following items for the power-on test:

- The equipment powers on properly.
- The alarm system works properly.
- The monitor displays properly.

22.5.3 Testing the Network Printer

To check the printer, follow this procedure:

1. Start a printing task to print waveforms and reports.
2. Check that the printer is properly connected and functions correctly.
3. Check that the printout is clear without missing dots.

22.5.4 Checking the Battery

For information on battery check, see *20.6.2 Checking Battery Performance*.

22.6 Disposing of the Monitor

Dispose of the monitor and its accessories when its service life is reached. Follow local regulations regarding the disposal of such product.

WARNING

- **For disposal of parts and accessories, where not otherwise specified, follow local regulations regarding disposal of hospital waste.**
-
-

23 Accessories

The accessories listed in this chapter comply with the requirements of IEC 60601-1-2 when in use with the patient monitor. The accessory material that contacts the patients has undertaken the bio-compatibility test and is verified to be in compliance with ISO 10993-1. For details about the accessories, refer to the instructions for use provided with the accessory.

WARNING

- **Use accessories specified in this chapter. Using other accessories may cause damage to the monitor or not meet the claimed specifications.**
- **Single use accessories are not designed to be reused. Reuse may cause a risk of contamination and affect the measurement accuracy.**

CAUTION

- **The accessories may not meet the performance specifications if stored or used outside the specified temperature and humidity ranges. If accessory performance is degraded due to aging or environmental conditions, contact your service personnel.**
- **Check the accessories and their packages for any sign of damage. Do not use them if any damage is detected.**
- **Use the accessories before the expiry date if their expiry date is indicated.**
- **The disposable accessories shall be disposed of according to hospital's regulations.**

23.1 ECG Accessories

23.1.1 ECG Electrodes

Model	Part No.	Description	Usage	Applicable patient
31499224	0010-10-12304	Electrode, Kendall, 10 pcs/package	Disposable	Adult
2245-50	9000-10-07469	ECG electrode, 3M, 50 pcs/package	Disposable	Pediatric
1050NPSMKittyCat	0681-00-0098-01	NEO pre-wired electrode radio Opaque	Disposable	Neonate
1051NPSMKittyCat	0681-00-0098-02	NEO pre-wired electrode radio Translucent	Disposable	Neonate

23.1.2 12-Pin Trunk Cables

Model	Part No.	Description	Usage	Applicable patient
EV6201	0010-30-42719	12Pin 3/5-Lead ECG trunk cable, defibrillation-proof	Reusable	Adult/Pediatric
EV6202	0010-30-42720	12Pin 3-Lead ECG trunk cable, defibrillation-proof	Reusable	Pediatric/Neonate
EV6203	0010-30-42721	12Pin 12-Lead trunk cable, defibrillation-proof	Reusable	Adult/Pediatric

Model	Part No.	Description	Usage	Applicable patient
EV6211	0010-30-42723	12Pin 3/5-Lead ECG trunk cable, ESU-proof	Reusable	Adult/Pediatric
EV6212	0010-30-42724	12Pin 3-Lead ECG trunk cable, ESU-proof	Reusable	Pediatric/Neonate
EV6222	040-000754-00	12Pin 3-Lead trunk cable, defibrillation-proof, DIN Conn	Reusable	Pediatric/Neonate
EV6206	009-005266-00	ECG Cable, 10'(3.1 m), Def-P, for N/T	Reusable	Adult, pediatric
EV6207	009-005267-00	ECG Cable, 20'(6.2 m)? Def-P? for N/T	Reusable	Adult, pediatric
EV6216	009-005268-00	ECG Cable, 10'(3.1 m), ESU-P, for N/T	Reusable	Adult, pediatric
EV6217	009-005269-00	ECG Cable, 20'(6.2 m), ESU-P, for N/T	Reusable	Adult, pediatric

23.1.3 3-lead ECG Leadwires

Model	Part No.	Description	Usage	Applicable patient
EL6305A	0010-30-42896	3-Lead leadset, AHA, clip	Reusable	Neonate
EL6303A	0010-30-42731	3-Lead leadset, AHA, clip, Long	Reusable	Adult/Pediatric
EL6301B	0010-30-42734	3-Lead leadset, snap	Reusable	Adult/Pediatric
EL6311B	040-000146-00	3-Lead leadset, AHA, snap	Disposable	Pediatric/Neonate
EL6311A	040-000148-00	3-Lead leadset, AHA, clip	Disposable	Pediatric/Neonate
EY6316B	009-004765-00	3-Lead, New Telemetry, AHA, snap, 24"	Reusable	Adult/Pediatric
EY6305B	009-004766-00	3-Lead, New Telemetry, AHA, snap, 36"	Reusable	Adult/Pediatric
EY6316A	009-004771-00	3-Lead, New Telemetry, AHA, pinch, 24"	Reusable	Adult/Pediatric
EY6305A	009-004772-00	3-Lead, New Telemetry, AHA, pinch, 36"	Reusable	Adult/Pediatric
EY6310B	009-004777-00	3-Lead, New Telemetry, AHA, snap, 24"	Disposable	Adult/Pediatric

23.1.4 5-lead ECG Leadwires

Model	Part No.	Description	Usage	Applicable patient
EL6503A	0010-30-42729	5-Lead leadset, AHA, clip, Long	Reusable	Adult/Pediatric
EL6501B	0010-30-42735	5-Lead leadset, AHA, snap	Reusable	Adult/Pediatric
EL6501A	0010-30-42727	5-Lead leadset, AHA, clip	Reusable	Adult/Pediatric
EY6511B	009-004782-00	5-Lead, New Telemetry, AHA, snap, 24"	Reusable	Adult/Pediatric
EY6512B	009-004783-00	5-Lead, New Telemetry, AHA, snap, 36"	Reusable	Adult/Pediatric
EY6511A	009-004786-00	5-Lead, New Telemetry, AHA, pinch, 24"	Reusable	Adult/Pediatric
EY6512A	009-004787-00	5-Lead, New Telemetry, AHA, pinch, 36"	Reusable	Adult/Pediatric

Model	Part No.	Description	Usage	Applicable patient
EY6507B	009-004790-00	5-Lead, New Telemetry, AHA, snap, 24"	Disposable	Adult/Pediatric

23.1.5 6-lead ECG Leadwires

Model	Part No.	Description	Usage	Applicable patient
EY6601B	009-004794-00	6-Lead, New Telemetry, AHA, snap, 24"	Reusable	Adult/Pediatric
EY6602B	009-004795-00	6-Lead, New Telemetry, AHA, snap, 36"	Reusable	Adult/Pediatric
EY6601A	009-004798-00	6-Lead, New Telemetry, AHA, pinch, 24"	Reusable	Adult/Pediatric
EY6602A	009-004799-00	6-Lead, New Telemetry, AHA, pinch, 36"	Reusable	Adult/Pediatric

23.1.6 12-lead ECG Leadwire

Model	Part No.	Description	Usage	Applicable patient
EL6801A	0010-30-42902	12-Lead leadset, limb, AHA, clip	Reusable	Adult/Pediatric
EL6803A	0010-30-42904	12-Lead leadset, chest, AHA, clip	Reusable	Adult/Pediatric
EL6801B	0010-30-42906	12-Lead leadset, limb, AHA, snap	Reusable	Adult/Pediatric
EL6803B	0010-30-42908	12-Lead leadset, chest, AHA, snap	Reusable	Adult/Pediatric

23.2 SpO₂ Accessories

Wavelength emitted by the sensors is between 600 nm and 1000 nm. The maximum photic output consumption of the sensor is less than 18 mW.

The information about the wavelength range and maximum photic output consumption can be especially useful to clinicians, for example, when photodynamic therapy is performed.

23.2.1 Extension Cables

Model	Part No.	Description	Usage	Applicable patient
562A	0010-20-42710	7-pin SpO ₂ extension cable, Mindray	Reusable	/
562B	040-001443-00	7pin SpO ₂ extension cable, 1.2 m, Mindray	Reusable	/
572A	0010-20-42712	8-pin SpO ₂ extension cable, Nellcor	Reusable	/
582A	115-020768-00	8-pin SpO ₂ extension cable, Masimo	Reusable	/
4089	040-003381-00	RD to LNC Adapter Cable		/
4092	040-003426-00	LNCS to RD Adapter		/
583A	040-003310-00	8pin masimo Cable (RD SET)		/

23.2.2 Mindray SpO₂ Sensors

Model	Part No.	Description	Usage	Applicable patient
512F	512F-30-28263	SpO ₂ sensor, finger-clip	Reusable	Adult
512FLH	115-012807-00	SpO ₂ sensor, finger-clip,7p	Reusable	Adult
512H	512H-30-79061	SpO ₂ sensor, finger-clip	Reusable	Pediatric
512E	512E-30-90390	SpO ₂ sensor, finger-tip	Reusable	Adult
512G	512G-30-90607	SpO ₂ sensor, finger-tip	Reusable	Pediatric
518B	518B-30-72107	SpO ₂ sensor, foot, bandage	Reusable	Neonate
518C	040-000330-00	SpO ₂ sensor, foot, bandage	Reusable	Neonate
520A	009-005087-00	SpO ₂ sensor, finger, non-adhesive	Disposable	Adult
520P	009-005088-00	SpO ₂ sensor, finger, non-adhesive	Disposable	Pediatric
520I	009-005089-00	SpO ₂ sensor, toe, non-adhesive	Disposable	Infant
520N	009-005090-00	SpO ₂ sensor, foot, non-adhesive	Disposable	Neonate

23.2.3 Masimo SpO₂ Sensors

Model	Part No.	Description	Usage	Applicable patient
LNCS DCI	0010-10-42600	SpO ₂ sensor, finger-clip, Masimo P/N: 1863	Reusable	Adult (>30 kg)
LNCS DCIP	0010-10-42634	SpO ₂ sensor, finger-clip, Masimo P/N: 1864	Reusable	Pediatric (10-50 kg)
LNCS YI	0010-10-43016	SpO ₂ sensor, multisite, Masimo P/N: 2258	Reusable	Adult/Pediatric/ Neonate
LNCS NeoPt-L	0010-10-42626	SpO ₂ sensor	Disposable	Neonate (<1 kg)
LNCS Neo-L	0010-10-42627	SpO ₂ sensor	Disposable	Neonate /Adult (<3 kg or >40 kg)
LNCS Inf-L	0010-10-42628	SpO ₂ sensor	Disposable	Infant (3-20 kg)
LNCS Pdtx	0010-10-42629	SpO ₂ sensor	Disposable	Pediatric (10-50 kg)
LNCS Adtx	0010-10-42630	SpO ₂ sensor	Disposable	Adult (>30 kg)
LNCS Adtx	0600-00-0121	SpO ₂ sensor, finger-clip, 20 pcs/box	Disposable	Adult (>30 kg)
LNCS Pdtx	0600-00-0122	SpO ₂ sensor, finger-clip, 20 pcs/box	Disposable	Pediatric (10-50 kg)
LNCS DCI	0600-00-0126	SpO ₂ sensor, finger-clip	Disposable	Adult (>30 kg)
LNCS DCIP	0600-00-0127	SpO ₂ sensor, finger-clip	Disposable	Pediatric (10-50 kg)
LNCS NeoPt	0600-00-0156	SpO ₂ sensor, finger-clip	Disposable	Neonate (<1Kg)
LNCS Neo-L	0600-00-0157	SpO ₂ sensor, 20 pcs/box	Disposable	Neonate /Adult (<3 kg or > 40 kg)
LNCS Inf	0600-00-0158	SpO ₂ sensor, 20 pcs/box	Disposable	Infant (3-20 kg)
4050	040-003376-00	RD SET DCI, Adult Reusable Sensor	Reusable	Adult (> 30 kg)
4051	040-003377-00	RD SET DCIP, Pediatric Reusable Sensor	Reusable	Pediatric (10 to 50 kg)
4053	040-003380-00	RD Set TC-I SpO ₂ Reusable Tip-Clip Ear Sensor, 3ft	Reusable	Adult (> 30 kg)

Model	Part No.	Description	Usage	Applicable patient
4000	040-003382-00	RD SET Adhesive Sensor	Disposable	Adult (> 30 kg)
4001	040-003383-00	RD SET PDT Adhesive Sensor	Disposable	Pediatric (10 to 50 kg)
4002	040-003384-00	RD Set Infant Adhesive Sensor	Disposable	Infant (3 to 20 kg)
4003	040-003385-00	RD Set Neo Adhesive Sensor	Disposable	Adult (> 40 kg) Neonate (< 3 kg)
4004	040-003386-00	RD Set NeoPt Adhesive Sensor	Disposable	Neonate (< 1 kg)
4005	040-003387-00	RD Set NeoPt-500 Non-adhesive sensor	Disposable	Neonate (< 1 kg)

23.2.4 Nellcor SpO₂ Sensors

Model	Part No.	Description	Usage	Applicable patient
DS-100A	9000-10-05161	SpO ₂ sensor, finger-clip	Reusable	Adult
D-YS	0010-10-12476	Dura-Y D-YS flexo oxygen sensor	Reusable	/
OXI-P/I	9000-10-07308	SpO ₂ sensor, finger, band	Reusable	Pediatric/Infant
OXI-A/N	9000-10-07336	SpO ₂ sensor, finger/foot, band	Reusable	Adult/Neonate
MAX-AI	0010-10-12202	SpO ₂ sensor, 24 pcs/box	Disposable	Adult (>30 kg)
MAX-PI	0010-10-12203	SpO ₂ sensor, 24 pcs/box	Disposable	Pediatric (10-50 Kg)
MAX-II	0010-10-12204	SpO ₂ sensor, 24 pcs/box	Disposable	Infant (3-20 kg)
MAX-NI	0010-10-12205	SpO ₂ sensor, 24 pcs/box	Disposable	Adult/Neonate (<3 kg or >40 kg)

23.3 Temp Accessories

23.3.1 Temp Cable

Model	Part No.	Description	Usage	Applicable patient
MR420B	040-001235-00	2-pin Temperature adapter cable	Reusable	/

23.3.2 Temp Probes

Model	Part No.	Description	Usage	Applicable patient
MR401B	0011-30-37392	Temperature probe, endocavity	Reusable	Adult
MR402B	0011-30-37394	Temperature probe, endocavity	Reusable	Pediatric/Infant
MR403B	0011-30-37393	Temperature probe, skin surface	Reusable	Adult
MR404B	0011-30-37395	Temperature probe, skin surface	Reusable	Pediatric/Infant
MR411	040-003292-00	Temperature probe, esophageal/rectal, 9FR	Disposable	/
MR412	040-003293-00	Temp probe, skin surface	Disposable	/
/	0206-03-0112-02	PROBE, D TEMP, ES400-12 (box of 20)	Disposable	Adult

Model	Part No.	Description	Usage	Applicable patient
/	0206-03-0118-02	PROBE, D TEMP, ES400-18 (box of 20)	Disposable	Adult
/	0206-03-0209-02	PROBE, D TEMP, ER400-9 (box of 20)	Disposable	Adult
/	0206-03-0212-02	PROBE, D TEMP, ER400-12 (box of 20)	Disposable	Adult
/	0206-03-0300-02	PROBE, D TEMP, STS-400 (box of 20)	Disposable	Adult

23.4 NIBP Accessories

23.4.1 NIBP Hoses

Model	Part No.	Description	Usage	Applicable patient
CM1903	6200-30-09688	NIBP hose, inbuilt connector, 3m	Reusable	Adult/Pediatric
CM1901	6200-30-11560	NIBP hose, inbuilt connector, 3m	Reusable	Neonate

23.4.2 Cuffs

Model	Part No.	Description	Usage	Applicable patient
CM1200	115-002480-00	Cuff, 7-13 cm	Reusable	Small Infant
CM1201	0010-30-12157	Cuff, 10-19 cm	Reusable	Infant
CM1202	0010-30-12158	Cuff, 18-26 cm	Reusable	Pediatric
CM1203	0010-30-12159	Cuff, 25-35 cm	Reusable	Adult
CM1204	0010-30-12160	Cuff, 33-47 cm	Reusable	Adult
CM1205	0010-30-12161	Cuff, 46-66 cm	Reusable	Adult thigh
CM1301	115-027713-00	Cuff, 10-19 cm, bladerless	Reusable	Infant
CM1302	115-027714-00	Cuff, 18-26 cm, bladerless	Reusable	Small Adult
CM1303	115-027715-00	Cuff, 25-35 cm, bladerless	Reusable	Adult
CM1304	115-027716-00	Cuff, 33-47 cm, bladerless	Reusable	Adult
CM1305	115-027717-00	Cuff, 46-66 cm, bladerless	Reusable	Adult thigh
CM1306	115-027718-00	Cuff, 24-35 cm, bladderless	Reusable	Adult
CM1307	115-027719-00	Cuff, 33-47 cm, bladderless	Reusable	Adult
CM1501	115-027556-00	Cuff, 10-19 cm, bladerless	Disposable	Infant
CM1502	115-027557-00	Cuff, 18-26 cm, bladerless	Disposable	Pediatric
CM1503	115-027558-00	Cuff, 25-35 cm, bladerless	Disposable	Adult
CM1504	115-027559-00	Cuff, 33-47 cm, bladerless	Disposable	Adult
CM1505	115-027560-00	Cuff, 46-66 cm, bladerless	Disposable	Adult thigh
CM1506	115-027561-00	Cuff, 25-35 cm, bladerless	Disposable	Adult
CM1507	115-027562-00	Cuff, 33-47 cm, bladerless	Disposable	Adult
CM1500A	001B-30-70677	Cuff, 3.1-5.7 cm	Disposable	Neonate

Model	Part No.	Description	Usage	Applicable patient
CM1500B	001B-30-70678	Cuff, 4.3-8.0 cm	Disposable	Neonate
CM1500C	001B-30-70679	Cuff, 5.8-10.9 cm	Disposable	Neonate
CM1500D	001B-30-70680	Cuff, 7.1-13.1 cm	Disposable	Neonate
CM1500E	001B-30-70681	Cuff, 5#	Disposable	Neonate

23.5 IBP Accessories

23.5.1 IBP Accessories

Model	Part No.	Description	Usage	Applicable patient
IM2202	001C-30-70757	12 Pin IBP cable, Argon	Reusable	/
DT-4812	6000-10-02107	Disposable transducer kit, Argon	Disposable	/
682275	0010-10-12156	Mounting background and accessory for IBP transducer, Argon	Reusable	/
IM2201	001C-30-70759	12 Pin IBP cable, ICU Medical	Reusable	/
42584	0010-10-42638	IBP transducer, ICU Medical	Disposable	/
42602	M90-000133---	Mounting background and accessory for IBP transducer, ICU Medical	Reusable	/
42394	M90-000134---	Mounting clamp for IBP transducer (send with the cable), ICU Medical	Reusable	/
IM2204	040-001029-00	IBP extended cable with dual-receptacle	Reusable	/
IM2211	0010-21-12179	IBP Truwave Reusable Cable, not for transportation	Reusable	/

23.5.2 ICP Accessories

Model	Part No.	Description	Usage	Applicable patient
82-6653	040-002336-00	ICP sensor kit, Johnson&Johnson	Disposable	/

23.6 CO₂ Accessories

23.6.1 Sidestream CO₂ Accessories

Model	Part No.	Description	Usage	Applicable patient
4000	M02A-10-25937	CO ₂ Nasal sample cannula, 7" line	Disposable	Adult
4100	M02A-10-25938	CO ₂ Nasal sample cannula, 7" line	Disposable	Pediatric
4200	M02B-10-64509	CO ₂ Nasal sample cannula, 7" line	Disposable	Neonatal
60-15200-00	9200-10-10533	Sampling line, 2.5 m	Disposable	Adult/Pediatric

Model	Part No.	Description	Usage	Applicable patient
60-15300-00	9200-10-10555	Sampling line, 2.5 m	Disposable	Neonatal
60-14100-00	9000-10-07486	Dryline airway adapter, straight	Disposable	Adu/Ped
040-001187-00	040-001187-00	Airway Adapter	Disposable	Neonatal
60-14200-00	9000-10-07487	Dryline airway adapter, elbow	Disposable	/
100-000080-00	100-000080-00	Watertrap, DRYLINE II	Reusable	Adult/Pediatric
100-000081-00	100-000081-00	Watertrap, DRYLINE II	Reusable	Neonatal

Model	Part No.	Description	Usage	Applicable patient
100-000138-00	100-000138-00	DRYLINE™ PRIME gas sampling line with airway adapter	Disposable	Adult/Pediatric
100-000139-00	100-000139-00	DRYLINE™ PRIME gas sampling line with airway adapter	Disposable	Neonatal
100-000140-00	100-000140-00	DRYLINE™ PRIME+ gas sampling line with airway adapter	Disposable	Adult/Pediatric
100-000141-00	100-000141-00	DRYLINE™ PRIME+ gas sampling line with airway adapter	Disposable	Neonatal
100-000142-00	100-000142-00	DRYLINE™ PRIME nasal gas sampling line	Disposable	Adult
100-000143-00	100-000143-00	DRYLINE™ PRIME nasal gas sampling line	Disposable	Pediatric
100-000144-00	100-000144-00	DRYLINE™ PRIME nasal gas sampling line	Disposable	Neonatal
100-000145-00	100-000145-00	DRYLINE™ PRIME+ nasal gas sampling line	Disposable	Adult
100-000146-00	100-000146-00	DRYLINE™ PRIME+ nasal gas sampling line	Disposable	Pediatric
100-000147-00	100-000147-00	DRYLINE™ PRIME+ nasal gas sampling line	Disposable	Neonatal
100-000151-00	100-000151-00	DRYLINE™ PRIME watertrap mini	Disposable	/

23.6.2 Microstream CO₂ Accessories

Model	Part No.	Description	Usage	Applicable patient
XS04620	0010-10-42560	FilterLine Set	Disposable	Adult, pediatric
XS04624	0010-10-42561	FilterLine H Set	Disposable	Adult, pediatric
006324	0010-10-42562	FilterLine H Set	Disposable	Neonate
007768	0010-10-42563	FilterLine Set, long	Disposable	Adult, pediatric
007737	0010-10-42564	FilterLine H Set, long	Disposable	Adult, pediatric
007738	0010-10-42565	FilterLine H Set, long	Disposable	Neonate
009818	0010-10-42566	S CapnoLine Plus	Disposable	Adult
007266	0010-10-42567	Smart CapnoLine	Disposable	Pediatric
009822	0010-10-42568	S CapnoLine Plus O ₂	Disposable	Adult
007269	0010-10-42569	Smart CapnoLine O ₂	Disposable	Pediatric

Model	Part No.	Description	Usage	Applicable patient
009826	0010-10-42570	S CapnoLine Plus O ₂ , long	Disposable	Adult
007743	0010-10-42571	S CapnoLine O ₂ , long	Disposable	Pediatric
008177	0010-10-42572	CapnoLine H	Disposable	Adult
008178	0010-10-42573	CapnoLine H	Disposable	Pediatric
008179	0010-10-42574	CapnoLine H	Disposable	Neonate
008180	0010-10-42575	CapnoLine H O ₂	Disposable	Adult
008181	0010-10-42576	CapnoLine H O ₂	Disposable	Pediatric
008174	0010-10-42577	NIV-Line	Disposable	Adult
008175	0010-10-42578	NIV-Line	Disposable	Pediatric
/	045-003134-00	CO2 adapter	Reusable	/

23.6.3 Mainstream CO₂ Accessories

Model	Part No.	Description	Usage	Applicable patient
6063	0010-10-42662	Airway adapter	Disposable	Adult, pediatric
6421	0010-10-42663	Airway adapter, with mouthpiece	Disposable	Adult, pediatric
6312	0010-10-42664	Airway adapter	Disposable	Pediatric, neonate
7007	0010-10-42665	Airway adapter	Reusable	Adult, pediatric
7053	0010-10-42666	Airway adapter	Reusable	Neonate
9960LGE	0010-10-42669	CAPNOSTAT CO ₂ large adult mask	Disposable	Adult
9960STD	0010-10-42670	CAPNOSTAT CO ₂ standard adult mask	Disposable	Adult
9960PED	0010-10-42671	CAPNOSTAT CO ₂ pediatric mask	Disposable	Pediatric
6934	0010-10-42667	Cable management straps (5 pcs)	Reusable	/
8751	0010-10-42668	Cable holding clips (5 pcs)	Reusable	/
1036698	6800-30-50760	CAPNOSTAT CO ₂ sensor	Reusable	/

A Product Specifications

A.1 Monitor Safety Specifications

The monitor is classified, according to IEC 60601-1:

Degree of protection against electrical shock	Type CF defibrillation proof for ECG, TEMP, IBP, SpO ₂ , and NIBP Type BF defibrillation proof for CO ₂
Type of protection against electrical shock	Class I
Ingress Protection	N1 monitor: IP44 (protected against ingress of foreign objects no less than 1.0 mm, and against access to hazardous parts with wire; protect against harmful effects of splashing water) Dock/Modular Rack/AC Adapter: IPX1 (protected against harmful effects of vertically falling water drops) Transport Dock: IP22 (protected against ingress of foreign objects no less than 12.5 mm and against access to hazardous parts with finger; protected against harmful effects of vertically falling water drops with the device tilted at any angle up to 15°)
Degree of safety of application in the presence of flammable anesthetic mixture with air or with oxygen or nitrous oxide	The equipment is not suitable for use in the presence of a flammable anesthetic mixture with air or with oxygen or nitrous oxide
Mode of operation	Continuous

A.2 Physical Specifications

Item	Maximum Weight (kg)	W × H × D (mm)	Comments
N1 main unit	0.95	148.5 × 103 × 81	without internal CO ₂ module
N1 main unit	1.17	148.5 × 103 × 81	with internal CO ₂ module
Modular Rack	1.55	165 × 130 × 168	with N1 not configuring the internal CO ₂ module
Modular Rack	1.78	165 × 130 × 168	with N1 configuring the internal CO ₂ module
Dock	0.97	190 × 125 × 155	/
Transport Dock	2.51	162.4 × 253 × 195.5	with cable box
Transport Dock	1.80	162.4 × 113 × 195.5	without cable box
Mainstream CO ₂ module	0.66	136.5 × 40 × 102	/
Microstream CO ₂ module	0.40	136.5 × 40 × 102	/
Sidestream CO ₂ module	0.64	136.5 × 40 × 102	with O ₂
Sidestream CO ₂ module	0.52	136.5 × 40 × 102	without O ₂
IBP module	0.26	136.5 × 40 × 102	/

A.3 Environmental Specifications

WARNING

- The monitor may not meet the performance specifications if stored or used outside the specified temperature and humidity ranges. If the performance of the equipment is degraded due to aging or environmental conditions, contact your service personnel.
- When the monitor and related products have differing environmental specifications, the effective range for the combined products is that range which is common to the specifications for all products.
- The monitor cannot be transported in the temperature lower than -30°C.

NOTE

- The environmental specification of unspecified parameter modules are the same as those of the main unit.

Components	Item	Operating Condition	Storage Condition
Main Unit/ Transport Dock/AC Adapter	Temperature (°C)	0 to 40	-30 to 70
	Relative humidity (noncondensing) (%)	5 to 95	5 to 95
	Barometric (mmHg)	427.5 to 805.5	375 to 805.5 (with CO ₂) 120 to 805.5 (without CO ₂)
Modular Rack/ Dock	Temperature (°C)	0 to 40	-20 to 60
	Relative humidity (noncondensing) (%)	15 to 95	10 to 95
	Barometric (mmHg)	427.5 to 805.5	120 to 805.5
Microstream CO ₂ module	Temperature (°C)	0 to 40	-20 to 60
	Relative humidity (noncondensing) (%)	15 to 95	10 to 95
	Barometric (mmHg)	430 to 790	430 to 790
Sidestream CO ₂ module	Temperature (°C)	5 to 40	-20 to 60
	Relative humidity (noncondensing) (%)	15 to 95	10 to 95
	Barometric (mmHg)	430 to 790	375 to 805.5
Mainstream CO ₂ module	Temperature (°C)	0 to 40	-20 to 60
	Relative humidity (noncondensing) (%)	10 to 90	10 to 90
	Barometric (mmHg)	427.5 to 805.5	400 to 805.5

Transient operating conditions

The monitor is operated in normal use for a period not less than 20 minutes when moved from room temperature ($20^{\circ}\text{C} \pm 2^{\circ}\text{C}$) to an environment of a temperature range from -20°C to 50°C , and relative humidity range from 15% to 95% (non-condensing).

The monitor is operated in normal use for a period not less than 20 minutes when moved from storage temperature (range from -30°C to 70°C) to room temperature ($20^{\circ}\text{C} \pm 2^{\circ}\text{C}$), and started up within 10 minutes after the movement.

A.4 Power Supply Specifications

A.4.1 External Power Supply Specifications

N1 main unit	
Input voltage	12VDC ($\pm 10\%$)
Input current	2 A
AC Adapter	
Input	100 to 240 VAC (-15% , $+10\%$), 50/60 Hz (± 3 Hz), 1.0A to 0.6A
Output	12VDC ($\pm 10\%$), 2.5A
Dock	
Input voltage	100 to 240VAC ($\pm 10\%$)
Input current	0.65A to 0.35A
Frequency	50/60Hz (± 3 Hz)
Transport Dock	
Input	100 to 240 VAC (-15% , $+10\%$), 50/60 Hz (± 3 Hz), 1.0A to 0.6A
Output	12VDC ($\pm 10\%$), 2.5A

A.4.2 Battery Specifications

Battery type	Rechargeable lithium-Ion battery
Voltage	7.2 VDC
Capacity	2500 mAh
Run time	<p>At least 8 hours when the monitor without internal CO₂ module is powered by two new fully-charged batteries at $25^{\circ}\text{C} \pm 5^{\circ}\text{C}$ with factory default screen brightness, Wi-Fi disabled, ECG and SpO₂ cable connected, and auto NIBP measurements at an interval of 15 minutes.</p> <p>At least 3 hours when the monitor with internal CO₂ module is powered by one new fully-charged battery at $25^{\circ}\text{C} \pm 5^{\circ}\text{C}$ with factory default screen brightness, Wi-Fi enabled, CO₂ sampling line connected, Temp, IBP, ECG and SpO₂ cable connected, and auto NIBP measurements at an interval of 15 minutes.</p> <p>Shutdown delay: at least 15 minutes after the low battery alarm first occurs.</p>

Charge time	<p>For the monitor without internal CO₂ module: no more than 6 hours to 90% when the monitor is off. no more than 10 hours to 90% when the monitor is on.</p> <p>For the monitor with internal CO₂ module: no more than 3 hours to 90% when the monitor is off. no more than 5 hours to 90% when the monitor is on.</p>
-------------	---

A.5 Display Specifications

N1 main unit	
Screen type	Color TFT LCD
Screen Size (diagonal)	5.5 inches
Resolution	1280 x 720 pixels
Pixel per inch (PPI)	269
External display	
Screen type	Medical-grade color TFT LCD
Screen Size (diagonal)	22 inches
Resolution	1280 x 720 pixels

A.6 Touchscreen Specifications

Screen type	Capacitive, multi-point touch
-------------	-------------------------------

A.7 LEDs

A.7.1 Main Unit

Alarm lamp	1 (three color-coded: red, yellow, and cyan)
Power-on LED	1 (green)
External power LED	1 (green)
Battery LED	1 (two color-coded: yellow and green)

A.7.2 Dock

Connection status LED	1 (green)
External power supply LED	1 (green)

A.7.3 Transport Dock

Power-on LED	1 (green)
--------------	-----------

A.7.4 AC Adapter

Power-on LED	1 (green)
--------------	-----------

A.8 Audio Indicator

Speaker	Give alarm tones (45 to 85 dB), reminder tones, key tones, QRS tones; support PITCH TONE and multi-level tone modulation; alarm tones comply with IEC 60601-1-8.
---------	--

A.9 Monitor Interface Specifications

A.9.1 Interface Specifications of the Main Unit

DC power input connector	1
Multifunctional connector	1
Multi-pin connector	1
Communication interface	4
Infrared filter	1
Contact	2
Power switch	1
Sample line connector of the Sidestream CO ₂	1
Gas outlet	1
ECG cable connector	1
SpO ₂ sensor connector	1
NIBP cuff connector	1
IBP cable connector	1
Temperature probe connector	2

A.9.2 Interface Specifications of the Modular Rack

Multi-pin connector	2
---------------------	---

A.9.3 Interface Specifications of the Dock

Network connector	1
Equipotential grounding terminal	1
AC power input connector	1
VGA connector	1
Host monitor connector	1
USB connector	2
Multi-pin connector	1

A.10 Signal Outputs Specifications

ECG Analog Output	
Bandwidth (-3dB; reference frequency: 10Hz)	Diagnostic mode: 0.05 to 150 Hz Monitor mode: 0.5 to 40 Hz Surgical mode: 1 to 20 Hz ST mode: 0.05 to 40 Hz
Maximum QRS delay	25 ms (in diagnostic mode, and non-paced)
Gain (reference frequency 10Hz)	1V/mV ($\pm 5\%$)
Pace enhancement	Signal amplitude: $V_{oh} \geq 2.5V$ Pulse width: $10ms \pm 5\%$ Signal rising and falling time: $\leq 100\mu s$
IBP Analog Output	
Bandwidth (-3dB; reference frequency: 1Hz)	0 to 40 Hz
Maximum transmission delay	30 ms
Gain (reference frequency 1Hz)	1 V/100 mmHg, $\pm 5\%$
Defib Sync Pulse	
Output impedance	≤ 100 ohm
Maximum time delay	35 ms (R-wave peak to leading edge of pulse)
Amplitude	High level: 3.5 to 5 V, $\pm 5\%$, providing a maximum of 10 mA output current; Low level: < 0.5 V, receiving a maximum of 5 mA input current.
Pulse width	100 ms $\pm 10\%$
maximum rising and falling time	1 ms
Video Output	
Video signals	VGA signal
Alarm output	
Alarm delay time from the monitor to remote equipment	The alarm delay time from the monitor to remote equipment is ≤ 2 seconds, measured at the monitor signal output connector.
Alarm signal sound pressure level range	45 db(A) to 85 db(A) within a range of one meter

A.11 Data Storage

Trends	A minimum of 120 hours' trend data with the resolution no less than 1 minute.
Events	1000 events, including parameter alarms, arrhythmia events, technical alarms, and so on
NIBP measurements	1000 sets
Interpretation of resting 12-lead ECG results	20 sets
Full-disclosure waveforms	48 hours at maximum. The specific storage time depends on the waveforms stored and the number of stored waveforms.
OxyCRG view	48 hours. Trend data is stored one dot per second and the waveform stored is a compressed waveform.

A.12 Out-Of-Hospital Transport - Standards Compliance

- **Shock Tests** according to IEC TR 60721-4-7, Class 7M3. Test procedure according to IEC/EN60068-2-27 (peak acceleration up to 100g).
- **Random Vibration** according to IEC TR 60721-4-7, Class 7M3. Test procedure according to IEC/EN 60068-2-64 (RMS acceleration 5g).
- **Sinusoidal Vibration** according to IEC TR 60721-4-7, Class 7M3. Test procedure according to IEC/EN 60068-2-6 (acceleration up to amplitude 2g).
- **Bump Test** according to IEC/EN60068-2-29 (peak acceleration 15 g, 1000 bumps).
- **Free Fall Test** according to EN 60068-2-32 (height 1.2 m).
- EN 1789:2007+A2:2014 Medical vehicles and their equipment - Road ambulances.
- EN 13718-1:2008 Medical vehicles and their equipment-Air ambulances-Part 1: Requirements for medical devices used in air ambulances.
- IEC 60601-1-12:2014 Medical electrical equipment -Part 1-12: General requirements for basic safety and essential performance -Collateral Standard: Requirements for medical electrical equipment and medical electrical systems intended for use in the emergency medical services environment.
- **RTCA DO-160G** Environmental Conditions and Test Procedures for Airborne Equipment.
 - ◆ Section 7 Operational Shocks and Crash Safety
 - ◆ Section 8 Vibration (Category S for fixed wing and Category U2 for rotary wing)
- **MIL-STD-810G** Environmental engineering considerations and laboratory tests
 - ◆ Method 514.6 Category 13 - Fixed Wing Propeller Aircraft
 - ◆ Method 514.6 Category 14 Category 14 Helicopter, General, UH-60
 - ◆ Method 514.6 Category 20 - Ground vehicles - ground mobile
 - ◆ Method 514.6 Category 24 - Helicopter minimum integrity test
- **Radiated susceptibility** 20 V/m according to IEC80601-2-30: 2013 (NIBP), ISO80601-2-55: 2011 (CO₂), ISO80601-2-56: 2009 (TEMP), ISO 80601-2-61: 2011 (SpO₂).
- **Extended radiated susceptibility tests**
 - ◆ TETRA 400: 27V/m
 - ◆ GMRS 460; FRS 460; GSM 800/900; TETRA 800; iDEN 820; CDMA 850; LTE Band 5; GSM 1800; CDMA 1900; GSM 1900; DECT; LTE Band 1, 3,4, 25; UMTS; Bluetooth; WLAN; 802.11 b/g/n; RFID 2450; LTE Band 7: 28V/m
 - ◆ LTE Band 13, 17; WLAN 802.11 a/n: 9V/m
- **Magnetic Field emission** according to MIL STD 461F, Chapter RE101: Radiated emissions, magnetic field, 30Hz to 100KHz. Limit class: Army.
- **Magnetic Field susceptibility:** Radiated susceptibility, magnetic field, 50 and 60 Hz, 30 A/m.

A.13 Wi-Fi Specifications

A.13.1 Wi-Fi Technical Specifications

Protocol	IEEE 802.11a/b/g/n	
Modulation mode	DSSS and OFDM	
Operating frequency	IEEE 802.11b/g/n (at 2.4G)	IEEE 802.11a/n (at 5G)
	ETSI: 2.4 GHz to 2.483 GHz FCC: 2.4 GHz to 2.483 GHz MIC: 2.4 GHz to 2.495GHz KC: 2.4 GHz to 2.483 GHz	ETSI: 5.15 GHz to 5.35 GHz, 5.47 GHz to 5.725 GHz FCC: 5.15 GHz to 5.35 GHz, 5.725 GHz to 5.85 GHz MIC: 5.15GHz to 5.35 GHz KC: 5.15 GHz to 5.35 GHz, 5.47 GHz to 5.725 GHz, 5.725 GHz to 5.85 GHz Not support the DFS channels
Channel spacing	IEEE 802.11b/g: 5 MHz IEEE 802.11n (at 2.4G): 5 MHz IEEE802.11a: 20 MHz IEEE802.11n (at 5G): 20 MHz	
Wireless baud rate	IEEE 802.11a: 6 Mbps to 54 Mbps IEEE 802.11b: 1 Mbps to 11 Mbps IEEE 802.11g: 6 Mbps to 54 Mbps IEEE 802.11n (both at 2.4G and 5G): 6.5 Mbps to 72.2 Mbps	
Output power	<20dBm (CE requirement, detection mode- RMS) <30dBm (FCC requirement, detection mode- peak power)	
Operating mode	Infrastructure	
Data security	Standards: WPA-PSK, WPA2-PSK, WPA-Enterprise,WPA2-Enterprise. WPA CCKM, WPA2 CCKM EAP method: EAP-FAST, EAP-TLS, EAP-TTLS, PEAP-GTC, PEAP- MSCHAPv2, PEAP-TLS, LEAP Encryption: AES	

A.13.2 Wi-Fi Performance Specifications

WARNING

- **Do perform all network functions of data communication within an enclosed network.**
-

A.13.2.1 System capacity and resistance to wireless interference

Meets the following requirements:

- All the monitors do not encounter communication loss.
- The total delay of data transmission from the monitor to the central monitoring system: ≤ 2 seconds.
- The delay for monitor-related settings configured at the central monitoring system to be effective: ≤ 2 seconds.
- The total delay of data transmission from one monitor to the other: ≤ 2 seconds.
- The delay for the monitor to reset alarms of another to be effective: ≤ 2 seconds.

Testing conditions are as follows:

- Number of the monitors supported by a single AP: ≤ 16 .
- Each monitor can communicate with the central monitoring system.
- Two monitors are used to view other monitors.
- Only one monitor can transmit history data.
- The weakest strength of the AP signal where the monitor is located cannot be less than -65 dBm.

- The distance between the interfering devices and the monitor is greater than 20 cm. A Wi-Fi interference (no greater than -85 dBm) in the same channel and a Wi-Fi interference (no greater than -50 dBm) in an adjacent-channel are presented synchronously. The interfering devices include, but are not limited to, 2.4 G wireless devices, cellular mobile networks, microwave ovens, interphones, cordless phones, and ESU equipment. The interfering devices do not include Wi-Fi devices.

A.13.2.2 Wi-Fi network stability

The ratio of the communication data lost on CMS from the N1 does not exceed 0.1% in 24 hours..

Testing conditions are as follows:

- Number of the monitors supported by a single AP: ≤16.
- Each monitor can communicate with the central monitoring system.
- Two monitors are used to view other monitors.
- Only one monitor can transmit history data.
- The weakest strength of the AP signal where the monitor is located cannot be less than -65 dBm.

A.13.2.3 Distinct vision distance

The distinct vision distance between the monitor and the AP is no less than to 50 meters.

A.14 Measurement Specifications

The adjustable range of alarm limits is the same with the measurement range of signals unless otherwise specified.

A.14.1 ECG Specifications

ECG	
Standards	Meet standards of IEC 60601-2-27 2011 and IEC 60601-2-25 2011
Lead set	3-lead: I, II, III 5-lead: I, II, III, aVR, aVL, aVF, V 6-lead: I, II, III, aVR, aVL, aVF, Va, Vb 12-lead: I, II, III, aVR, aVL, aVF, V1 to V6
ECG standard	AHA, IEC
Display sensitivity	1.25 mm/mV (X0.125), 2.5 mm/mV (X0.25), 5 mm/mV (X0.5), 10 mm/mV (X1), 20 mm/mV (X2), 40 mm/mV (X4), Auto, less than ±5% error
Sweep speed	6.25 mm/s, 12.5 mm/s, 25 mm/s, 50 mm/s, less than ±5% error
Bandwidth (-3dB)	Diagnostic mode: 0.05 to 150 Hz Monitor mode: 0.5 to 40 Hz Surgical mode: 1 to 20 Hz ST mode: 0.05 to 40 Hz High Freq Cut-off (for 12-lead ECG analysis): 350 Hz (0.05 to 350 Hz), 150 Hz (0.05 to 150 Hz), 35 Hz (0.05 to 35 Hz), 20 Hz (0.05 to 20 Hz) selectable.
Common mode rejection ratio	Diagnostic mode: >90 dB Monitor mode: >105 dB (with notch filter on) Surgical mode: >105 dB (with notch filter on) ST mode: >105 dB (with notch filter on)
Notch filter	50/60 Hz Monitor, surgical, and ST mode: notch filter turns on automatically Diagnostic mode and High Freq Cut-off: notch filter is turned on/off manually
Differential input impedance	≥5 MΩ

Input signal range	±8 mV (peak-to-peak value)
Accuracy of signal reproduction	Use A and D methods based on IEC 60601-2-25 2011 to determine frequency response.
Electrode offset potential tolerance	±500 mV
Lead-off detection current	Measuring electrode: <0.1 µA Drive electrode: <1 µA
Input offset current	≤0.1 µA, (drive lead≤1µA)
Defibrillation protectio	Enduring 5000V (360 J) charge without data loss or corruption Baseline recovery time: <5 s (after defibrillation) Polarization recovery time: <10 s Defibrillation energy absorption: ≤10% (100Ω load)
Patient leakage current	<10 uA
Calibration signal	1mV (peak-to-peak value) ±5%
ESU protection	Cut mode: 300 W Coagulate mode: 100 W Recovery time: ≤10 s In compliance with the requirements in clause 202.6.2.101 of IEC 60601-2-27 2011
Pace Pulse	
Pace pulse markers	Pace pulses meeting the following conditions are labeled with a PACE marker: Amplitude: ±2 mV to ±700 mV Width: 0.1 ms to 2 ms Rise time: 10 µs to 100 µs (less than 10% of pulse width) No overshoot
Pace pulse rejection	When tested in accordance with the IEC 60601-2-27 2011: 201.12.1.101.13, the heart rate meter rejects all pulses meeting the following conditions. Amplitude: ±2mV to ±700 mV Width: 0.1ms to 2 ms Rise time: 10µs to 100 µs (less than 10% of pulse width) No overshoot

HR	
Measurement range	Neonate: 15 to 350 bpm Pediatric: 15 to 350 bpm Adult: 15 to 300 bpm
Resolution	1 bpm
Accuracy	±1 bpm or ±1%, whichever is greater.
Sensitivity	200 µV (lead II)
HR averaging method	In compliance with the requirements in Clause 201.7.9.2.9.101 b) 3) of IEC 60601-2-27 2011, the following method is used: If the last 3 consecutive RR intervals are greater than 1200 ms, the 4 most recent RR intervals are averaged to compute the HR. Otherwise, heart rate is computed by subtracting the maximum and minimum ones from the most recent 12 RR intervals and then averaging them. The HR value displayed on the monitor screen is updated no more than one second.

Response to irregular rhythm	In compliance with the requirements in Clause 201.7.9.2.9.101 b) 4) of IEC 60601-2-27 2011, the heart rate after 20 seconds of stabilization is displayed as follows: Ventricular bigeminy (waveform A1): -80 ± 1 bpm Slow alternating ventricular bigeminy (waveform A2): -60 ± 1 bpm Rapid alternating ventricular bigeminy (waveform A3): -120 ± 1 bpm Bidirectional systoles (waveform A4): -90 ± 2 bpm
Response time to heart rate change	Meets the requirements of IEC 60601-2-27 2011: Clause 201.7.9.2.9.101 b) 5). From 80 to 120 bpm: less than 11 s From 80 to 40 bpm: less than 11 s
Time to alarm for tachycardia	Meets the requirements in Clause 201.7.9.2.9.101 b) 6) of IEC 60601-2-27 2011. Waveform B1h-range: < 11 s B1-range: < 11 s B1d-range: < 11 s B2h-range: < 11 s B2-range: < 11 s B2d-range: < 11 s
Tall T-wave rejection capability	When the test is performed based on Clause 201.12.1.101.17 of IEC 60601-2-27 2011, the heart rate calculation is not affected for QRS of 1 mV amplitude and 100 ms duration, T-wave duration of 180 ms and amplitude lower than 1.2 mV, and QT interval of 350 ms.
Arrhythmia Analysis Classifications	Asystole, V-Fib/V-Tac, V-Tac, Vent Brady, Extreme Tachy, Extreme Brady, Vent Rhythm, PVCs/min, Pauses/min, Couplet, Bigeminy, Trigeminy, R on T, Run PVCs, PVC, Tachy, Brady, Missed Beats, Pacer Not Pacing, Pacer Not Capture, Multiform PVC, Nonsus V-Tach, Pause, Irr Rhythm, A-Fib
ST Segment Analysis	
Measurement range	-2.0 mV to 2.0 mV RTI
Accuracy	-0.8 mV to 0.8 mV: ± 0.02 mV or $\pm 10\%$, whichever is greater. Beyond this range: Not specified.
Resolution	0.01mV
QT/QTc Analysis	
Measurement range	QT: 200 to 800 ms QTc: 200 to 800 ms QT-HR: 15 bpm to 150 bpm for adult, 15 bpm to 180 bpm for pediatric and neonate
Accuracy	QT: ± 30 ms
Resolution	QT: 4 ms QTc: 1 ms
12-lead ECG Interpretation	
Sampling rate	1000 samples/s (waveform) 500 samples/s (algorithm)
Amplitude quantisation	24 bits
PVCs/min	
<u>Measurement range</u>	<u>Adult: 0 to 300</u> <u>Pediatric, neonate: 0 to 350</u>

Alarm limit	Range	Step
-------------	-------	------

HR High	HR≤40bpm: (low limit + 2 bpm) to 40 bpm HR > 40 bpm: (low limit + 5 bpm) to 295 bpm	HR≤40bpm: 1 bpm HR > 40 bpm: 5 bpm
HR Low	HR≤40bpm: 16 bpm to (HR high - 2 bpm) HR > 40 bpm: 40 bpm to (HR high - 5 bpm)	
ST High	(low limit + 0.2 mV) to 2.0 mV (absolute) 0 mV to 2.0 mV (relative)	0.05 mV
ST Low	-2.0 mV to (high limit - 0.2 mV) (absolute)-2.0 mV to 0 mV (relative)	
QTc High	200 to 800 ms	10 ms
ΔQTc High	30 to 200 ms	

A.14.2 Resp Specifications

Technique	Trans-thoracic impedance	
Lead	Options are lead I, II and Auto.	
Respiration excitation waveform	<300 μA RMS, 62.8 kHz (±10%)	
Minimum respiration impedance threshold	0.3Ω	
Baseline impedance range	200 to 2500Ω (using an ECG cable with 1kΩ resistance)	
Bandwidth	0.2 to 2.5 Hz (-3 dB)	
Sweep speed	3mm/s, 6.25 mm/s, 12.5 mm/s, 25 mm/s or 50 mm/s, less than 10% error	
Respiration Rate		
Measurement range	0 to 200 rpm	
Resolution	1 rpm	
Accuracy	0 to 120 rpm: ±1 rpm 121 to 200 rpm: ±2 rpm	
Zero RR alarm delay	10 s, 15 s, 20 s, 25 s, 30 s, 35 s, 40 s	
Alarm limit	Range (rpm)	Step (rpm)
RR High	Adult, pediatric: RR≤20 (low limit + 2) to 20 RR>20 (low limit + 5) to 100 Neonate: RR≤20 (low limit + 2) to 20 RR>20 (low limit + 5) to 150	RR≤20: 1 RR>20: 5
	RR Low RR≤20 0 to (high limit - 2) RR>20 20 to (high limit - 5)	

A.14.3 SpO₂ Specifications

Refer to *F SpO₂ Sensor Accuracy* for the clinical study results of SpO₂ sensor accuracy.

Alarm limit	Range (%)	Step (%)
SpO ₂ High	(low limit + 2) to 100	1
SpO ₂ Low	Mindray: (Desat+1) to (high limit - 2) Nellcor: (Desat+1) or 20 (whichever is greater) to (high limit - 2)	
Desat	0 to (low limit - 1)	

Mindray SpO₂ Module

Standards	Meet standards of ISO 80601-2-61 2011		
*Measurement accuracy verification: The SpO ₂ accuracy has been verified in human experiments by comparing with arterial blood sample reference measured with a CO-oximeter. Pulse oximeter measurement are statistically distributed and about two-thirds of the measurements are expected to come within the specified accuracy range compared to CO-oximeter measurements.			
Measurement range	0 to 100%		
Resolution	1%		
Response time	< 30 s (normal perfusion, no disturbance, SpO ₂ value sudden changes from 70% to 100%)		
Accuracy	70 to 100%: ±2% (adult/pediatric) 70 to 100%: ±3% (neonate) 0% to 69%: Not specified.		
* One percent was added to the accuracies for neonatal sensors to account for accuracy variation due to properties of fetal hemoglobin. Studies were performed to validate the accuracy of Pulse Oximeter with neonatal SpO ₂ sensors by contrast with a CO-Oximeter. Some neonates aged from 1 day to 30 days with a gestation age of 22 weeks to full term were involved in this study. The statistical analysis of data of this study shows the accuracy (Arms) is within the stated accuracy specification. Please see the following table.			
Sensor type	Totally neonates	Data	Arms
518B	97 (51 male & 46 female)	200 pairs	2.38%
520N	122 (65 male & 57 female)	200 pairs	2.88%
The Pulse Oximeter with neonatal SpO ₂ sensors was also validated on adult subjects.			
Refreshing rate	≤1 s		
Sensitivity	High, Medium, Low		
PI			
Measurement range	0.05 to 20%		
Resolution	PI<10.0: 0.01 PI≥10.0: 0.1		

Nellcor SpO₂ Module

Measurement range	0 to 100%
Resolution	1%
Refreshing rate	≤1 s
Response time	≤30 s (normal perfusion, no disturbance, SpO ₂ value sudden change from 70% to 100%)

Accuracy	70 to 100%: $\pm 2\%$ (adult/pediatric) 70 to 100%: $\pm 3\%$ (neonate) 0% to 69%: Not specified.
When the SpO ₂ sensor is applied for neonatal patients as indicated, the specified accuracy range is increased by $\pm 1\%$, to compensate for the theoretical effect on oximeter measurements of fetal hemoglobin in neonatal blood.	

Masimo SpO₂ Module

Measurement range	1 to 100%
Resolution	1%
Response time	≤ 20 s (normal perfusion, no disturbance, SpO ₂ value sudden change from 70% to 100%)
Accuracy ¹	70 to 100%: $\pm 2\%$ (adult/pediatric, without motion) 70 to 100%: $\pm 3\%$ (adult/pediatric, with motion) 70 to 100%: $\pm 3\%$ (neonate) 1% to 69%: Not specified.
Refreshing rate	≤ 2 s
SpO ₂ averaging time	2-4 s, 4-6 s, 8 s, 10 s, 12 s, 14 s, 16 s
Low perfusion conditions	Pulse amplitude: $>0.02\%$ Light penetration: $>5\%$
Low perfusion SpO ₂ accuracy ²	$\pm 2\%$
PI measurement range	0.02 to 20%
<p>¹ The Masimo pulse oximeter with sensors have been validated for no motion accuracy in human blood studies on healthy adult volunteers in induced hypoxia studies in the range of 70% to 100% SpO₂ against a laboratory co-oximeter and ECG monitor. This variation equals plus or minus one standard deviation. Plus or minus one standard deviation encompasses 68% of the population. One percent was added to the accuracies for neonatal sensors to account for accuracy variation due to properties of fetal hemoglobin.</p> <p>The Masimo pulse oximeter with sensors has been validated for motion accuracy in human blood studies on healthy adult volunteers in induced hypoxia studies while performing rubbing and tapping motions at 2 to 4 Hz. At an amplitude of 1 to 2 cm and non-repetitive motion between 1 to 5 Hz. At an amplitude of 2 to 3 cm in induced hypoxia studies in the range of 70% to 100% SpO₂ against a laboratory co-oximeter and ECG monitor. This variation equals plus or minus one standard deviation. Plus or minus one standard deviation encompasses 68% of the population.</p> <p>² The Masimo pulse oximeter has been validated for low perfusion accuracy in bench top testing against a Biotek Index 2 simulator and Masimo's simulator with signal strengths of greater than 0.02% and a % transmission of greater than 5% for saturations ranging from 70 to 100%. This variation equals plus or minus one standard deviation. Plus or minus one standard deviation encompasses 68% of the population.</p>	

A.14.4 PR Specifications

Alarm limit	Range (bpm)	Step (bpm)
PR High	PR ≤ 40 : (low limit +2) to 40 PR > 40 : (low limit +5) to 295	PR ≤ 40 : 1 PR > 40 : 5
PR Low	PR ≤ 40 : 16 to (high limit - 2) PR > 40 : 40 to (high limit - 5)	

PR from Mindray SpO₂ Module

Measurement range	20 to 254 bpm
Resolution	1 bpm
Response time	< 30 s (normal perfusion, no disturbance, PR value sudden changes from 25 bpm, to 220 bpm)
Accuracy	± 3 bpm
Refreshing rate	≤ 1 s

PR from Nellcor SpO₂ Module

Measurement range	20 to 300 bpm
Resolution	1 bpm
Response time	≤30 s (normal perfusion, no disturbance, PR value sudden change from 25 to 250 bpm)
Accuracy	20 to 250 bpm: ±3 bpm 251 to 300 bpm, not specified
Refreshing rate	≤1 s

PR from Masimo SpO₂ Module

Measurement range	25 to 240 bpm
Resolution	1 bpm
Response time	≤20 s (normal perfusion, no disturbance, PR value sudden change from 25 to 220 bpm)
Accuracy	±3 bpm (without motion) ±5 bpm (with motion)
Refreshing rate	≤2 s

PR from NIBP Module

Measurement range	30 to 300 bpm
Resolution	1 bpm
Accuracy	±3 bpm or ±3%, whichever is greater

PR from IBP Module

Measurement range	25 to 350 bpm
Resolution	1 bpm
Accuracy	±1 bpm or ±1%, whichever is greater

A.14.5 Temp Specifications

Standard	Meet the standard of ISO 80601-2-56 2009	
Technique	Thermal resistance	
Operating mode	Direct mode	
Measurement range	0 to 50 °C (32 to 122 °F)	
Resolution	0.1°C	
Accuracy	±0.1 °C or ±0.2 °F (excluding probe error)	
Refreshing rate	≤1 s	
Minimum time for accurate measurement	Body surface: <100 s Body cavity: <80 s	
Alarm limit	Range	Step
T1/T2 High	(low limit +1.0) to 50.0 °C (low limit +2.0) to 122.0 °F	0.1 °C 0.1 °F
T1/T2 Low	0.1 to (high limit - 1.0) °C 32.2 to (high limit - 2.0) °F	
ΔT High	0.1 to 50.0 °C 0.2 to 90.0 °F	

A.14.6 NIBP Specifications

Standard	Meet standard of IEC 80601-2-30 2013			
Technique	Oscillometry			
Mode of operation	Manual, Auto, STAT, Sequence			
Auto mode repetition intervals	1, 2, 2.5, 3, 5, 10, 15, 20, 30, 60, 90, 120, 180, 240 or 480 min			
STAT mode cycle time	5 min			
Max measurement time	Adult, pediatric: 180 s Neonate: 90 s			
Heart rate range	30 to 300 bpm			
Measurement ranges (mmHg)		Adult	Pediatric	Neonate
	Systolic:	25 to 290	25 to 240	25 to 140
	Diastolic:	10 to 250	10 to 200	10 to 115
	Mean:	15 to 260	15 to 215	15 to 125
Accuracy	Max mean error: ±5 mmHg Max standard deviation: 8 mmHg			
Resolution	1 mmHg			
Initial cuff inflation pressure range (mmHg)	Adult: 80 to 280 Pediatric: 80 to 210 Neonate: 60 to 140			
Default initial cuff inflation pressure (mmHg)	Adult: 160 Pediatric: 140 Neonate: 90			
Software overpressure protection	Adult: 297±3 mmHg Pediatric: 297±3 mmHg Neonate: 147±3 mmHg			

Static pressure measurement range	0 mmHg to 300 mmHg	
Static pressure measurement accuracy	±3 mmHg	
Alarm limit	Range (mmHg)	Step (mmHg)
NIBP-S High	Adult: (low limit + 5) to 265 Pediatric: (low limit + 5) to 195 Neonate: (low limit + 5) to 130	NIBP ≤ 50: 1 NIBP > 50: 5
NIBP-S Low	Adult: 41 to (high limit - 5) Pediatric: 41 to (high limit - 5) Neonate: 40 to (high limit - 5)	
NIBP-M High	Adult: (low limit + 5) to 225 Pediatric: (low limit + 5) to 160 Neonate: (low limit + 5) to 105	
NIBP-M Low	21 to (high limit - 5)	
NIBP-D High	Adult: (low limit + 5) to 205 Pediatric: (low limit + 5) to 145 Neonate: (low limit + 5) to 95	
NIBP-D Low	11 to (high limit - 5)	
NIBP-S Extreme High	Adult: (NIBP-S high limit + 5) to 270 Pediatric: (NIBP-S high limit + 5) to 200 Neonate: (NIBP-S high limit + 5) to 135	
NIBP-S Extreme Low	Adult: 40 to (NIBP-S low limit - 5) Pediatric: 40 to (NIBP-S low limit - 5) Neonate: 30 to (NIBP-S low limit - 5)	
NIBP-M Extreme High	Adult: (NIBP-M high limit + 5) to 230 Pediatric: (NIBP-M high limit + 5) to 165 Neonate: (NIBP-M high limit + 5) to 110	
NIBP-M Extreme Low	20 to (NIBP-M low limit - 5)	
NIBP-D Extreme High	Adult: (NIBP-D high limit + 5) to 210 Pediatric: (NIBP-D high limit + 5) to 150 Neonate: (NIBP-D high limit + 5) to 100	
NIBP-D Extreme Low	10 to (NIBP-D low limit - 5)	

*Measurement accuracy verification: In adult and pediatric modes, the blood pressure measurements measured with this device are in compliance with the Standard for Non-invasive sphygmomanometers (ISO 81060-2) in terms of mean error and standard deviation by comparing with intra-arterial or auscultatory measurements (depending on the configuration) in a typical patient population. For auscultatory reference, the 5th Korotkoff sound was used to determine the diastolic pressure.

In neonatal mode, the blood pressure measurements measured with this device are in compliance with the American National Standard for Non-invasive sphygmomanometers (ISO 81060-2) in terms of mean error and standard deviation by comparing with intra-arterial measurements (depending on the configuration) in a typical patient population.

A.14.7 IBP Specifications

Standard	Meet the standard of IEC 60601-2-34 2011.
Technique	Direct invasive measurement
IBP	
Measurement range	-50 to 300 mmHg
Resolution	1 mmHg

Accuracy	±2% or ±1 mmHg, whichever is greater (excluding sensor error)	
Refreshing rate	≤1s	
PPV		
Measurement range	0% ~ 50%	
Pressure transducer		
Excitement voltage	5 VDC, ±2%	
Sensitivity	5 μV/V/mmHg	
Zero adjustment range	±200 mmHg	
Impedance range	300 to 3000Ω	
Volume displacement	<0.04 mm ³ /100 mmHg	
Alarm limit	Range (mmHg)	Step (mmHg)
Sys High	IBP ≤ 50: (low limit + 2) to 50 IBP > 50: (low limit + 5) to 355	IBP ≤ 50: 1 IBP > 50: 5
Mean High		
Dia High		
Sys Low	IBP ≤ 50: - 49 to (high limit - 2) IBP > 50: 50 to (high limit - 5)	
Mean Low		
Dia Low		
Art-S Extreme High	(High limit+5) to 360	IBP ≤ 50: 1 IBP > 50: 5
Art-M Extreme High		
Art-D Extreme High		
Art-S Extreme Low	-50 to (low limit-5)	
Art-M Extreme Low		
Art-D Extreme Low		

A.14.8 CO₂ Specifications

Measurement mode	Sidestream, microstream, mainstream	
Technique	Infrared absorption	
Zero RR delay	10 s, 15 s, 20 s, 25 s, 30 s, 35 s, 40 s	
Alarm limit	Range	Step
EtCO ₂ High	(low limit + 2) to 99 mmHg	1 mmHg
EtCO ₂ Low		
FiCO ₂ High		
EtO ₂ High	(low limit + 2%) to 100%	1%
EtO ₂ Low		
FiO ₂ High		
FiO ₂ Low		

Sidestream CO₂ Module

Standard	Meet the standard of ISO 80601-2-55 2011
CO ₂ Measurement range	0 to 150mmHg
CO ₂ absolute accuracy*	<p>Full accuracy mode:</p> <p>0≤CO₂ concentration≤40 mmHg: ± 2mmHg</p> <p>41mmHg≤CO₂ concentration<76 mmHg: ±5% of reading</p> <p>77mmHg≤CO₂ concentration<99 mmHg: ±10% of reading</p> <p>100 mmHg≤CO₂ concentration<150 mmHg: ±(3mmHg + 8% of reading)</p> <p>> 150 mmHg: Unspecified</p>
Inaccuracy specifications are affected by the breath rate and I:E. The EtCO ₂ accuracy is within specification for breath rate ≤ 60 rpm and I/E ratio ≤ 1:1, or breath rate ≤ 30 rpm and I/E ratio ≤ 2:1.	
CO ₂ resolution	1 mmHg
O ₂ measurement range	0 to 100%
O ₂ absolute accuracy	<p>0≤O₂ concentration≤25%: ±1%</p> <p>25<O₂ concentration≤80%: ±2%</p> <p>80<O₂ concentration≤100%: ±3%</p>
O ₂ resolution	1%
Accuracy drift	Meet the requirement for measurement accuracy within 6 hours
Sample flowrate	<p>Using internal CO₂ module:</p> <p>Adult, pediatric, neonatal: 50 ml/min</p> <p>Using external CO₂ module with O₂ sensor:</p> <p>Adult, pediatric: 120 ml/min</p> <p>Neonatal: 90 ml/min</p> <p>Using the CO₂ module without O₂ sensor:</p> <p>Adult, pediatric: 120 ml/min</p> <p>Neonatal: 70 ml/min, 90 ml/min</p>
Sample flowrate tolerance	±15% or ±15 ml/min, whichever is greater.
Start-up time	20s (typical), 90 s (maximum)

Response time	<p>For CO₂ measurements (using external CO₂ module without O₂ sensor):</p> <p>Measured with a DRYLINE II neonatal watertrap and a 2.5-meter neonatal sampling line: ≤5.0 s @ 70 ml/min</p> <p>Measured with a DRYLINE II neonatal watertrap and a 2.5-meter neonatal sampling line: ≤4.5 s @ 90 ml/min</p> <p>Measured with a DRYLINE II adult watertrap and a 2.5-meter adult sampling line: ≤5.0 s @ 120 ml/min</p> <p>For CO₂ measurements (using external CO₂ module with O₂ sensor):</p> <p>Measured with a DRYLINE II neonatal watertrap and a 2.5-meter neonatal sampling line: ≤4.5 s @ 90 ml/min</p> <p>Measured with a DRYLINE II adult watertrap and a 2.5-meter adult sampling line: ≤5.0 s @ 120 ml/min</p> <p>For CO₂ measurements (using internal CO₂ module):</p> <p>Measured with a standard Oridion sampling line: ≤5.0 s@50 ml/min</p> <p>Measured with a prolonged Oridion sampling line: <6.5 s@50 ml/min</p> <p>For O₂ measurements:</p> <p>Measured with a DRYLINE II neonatal watertrap and a 2.5-meter neonatal sampling line: ≤4.5 s @ 90 ml/min</p> <p>Measured with a DRYLINE II adult watertrap and a 2.5-meter adult sampling line: ≤5.0 s @ 120 ml/min</p>
Rise time	<p>For CO₂ measurements (using external CO₂ module without O₂ sensor):</p> <p>Measured with a DRYLINE II neonatal watertrap and a 2.5-meter neonatal sampling line: ≤250 ms@70 ml/min.</p> <p>Measured with a DRYLINE II neonatal watertrap and a 2.5-meter neonatal sampling line: ≤250 ms@90 ml/min.</p> <p>Measured with a DRYLINE II adult watertrap and a 2.5-meter adult sampling line: ≤300 ms@120 ml/min</p> <p>For CO₂ measurements (using external CO₂ module with O₂ sensor):</p> <p>Measured with a DRYLINE II neonatal watertrap and a 2.5-meter neonatal sampling line: ≤250 ms@90 ml/min.</p> <p>Measured with a DRYLINE II adult watertrap and a 2.5-meter adult sampling line: ≤300 ms@120 ml/min</p> <p>For CO₂ measurements (using internal CO₂ module):</p> <p>Measured with a standard Oridion sampling line: ≤250 ms@50 ml/min</p> <p>Measured with a prolonged Oridion sampling line: ≤280 ms@50 ml/min</p> <p>For O₂ measurements:</p> <p>Measured with a DRYLINE II neonatal watertrap and a 2.5-meter neonatal sampling line: ≤800 ms@90 ml/min.</p> <p>Measured with a DRYLINE II adult watertrap and a 2.5-meter adult sampling line: ≤750 ms@120 ml/min</p>
awRR measurement range	0 to 150 rpm
awRR measurement precision	<60 rpm: ±1 rpm 60 to 150 rpm: ±2 rpm
awRR resolution	1 rpm
Data sample rate	50 Hz

Effect of interference gases on CO ₂ measurements		
Gas	Concentration (%)	Quantitative effect*
N ₂ O	≤60	±1 mmHg
Hal	≤4	
Sev	≤5	
Iso	≤5	
Enf	≤5	
Des	≤15	±2 mmHg
*: means an extra error should be added in case of gas interference when CO ₂ measurements are performed between 0 to 40mmHg.		
Effect of interference gases on O ₂ measurements		
Gas	Concentration (%)	
CO ₂	0.2	
N ₂ O	0.2	
HAL, DES, SEV, ISO, ENF	1.0	

Microstream CO₂ Module

Standard	Meet the standard of ISO 80601-2-55 2011	
CO ₂ Measurement range	0 to 99 mmHg	
Accuracy*	0 to 38 mmHg:	±2 mmHg
	39 to 99 mmHg:	±5% of the reading (0.08% increased in error for every 1 mmHg if the reading is more than 38)
Accuracy drift	Meet the requirement for measurement accuracy within 6 hours	
* Accuracy applies for respiration rate up to 80 rpm. For respiration rate above 80 rpm and EtCO ₂ exceeding 18 mmHg, the accuracy is 4 mmHg or ±12% of the reading, whichever is greater. For respiration rate above 60 rpm, the above accuracy can be achieved by using the CapnoLine H Set for Infant/Neonatal. In the presence of interfering gases, the above accuracy is maintained to within 4%.		
Resolution	1 mmHg	
Sample flow rate	50 ^{-7.5} ₊₁₅ ml/min	
Initialization time	180 s (maximum)	
Response time	≤2.9 s (The response time is the sum of the rise time and the delay time when using a FilterLine of standard length) Rise time: <190ms@50ml/min Delay time: ≤2.7 s	
awRR measurement range	0 to 150 rpm	
awRR measurement accuracy	0 to 70 rpm:	±1 rpm
	71 to 120 rpm:	±2 rpm
	121 to 150 rpm:	±3 rpm
awRR resolution	1 rpm	

Mainstream CO₂ Module

Standard	Meet the standard of ISO 80601-2-55 2011
----------	--

CO ₂ Measurement range	0 to 150 mmHg
Accuracy	0 to 40 mmHg: ±2 mmHg 41 to 70 mmHg: ±5% of the reading 71 to 100 mmHg: ±8% of the reading 101 to 150 mmHg: ±10% of the reading
Accuracy drift	Meet the requirement for measurement accuracy within 6 hours
Resolution	1 mmHg
Rise time	<60 ms
Data sample rate	100 Hz
awRR measurement range	0 to 150 rpm
awRR measurement accuracy	±1 rpm
awRR resolution	1 rpm

B EMC and Radio Regulatory Compliance

B.1 EMC

The device meets the requirements of IEC 60601-1-2: 2014.

WARNING

- **Use of accessories, transducers and cables other than those specified or provided by the manufacturer of this device could result in increased electromagnetic emissions or decreased electromagnetic immunity of this device and result in improper operation.**
- **Use of this device adjacent to or stacked with other device should be avoided because it could result in improper operation. If such use is necessary, this device and the other device should be observed to verify that they are operating normally.**
- **Portable RF communications equipment (including peripherals such as antenna cables and external antennas) should be used no closer than 30 cm (12 inches) to any part of the this device, including cables specified by the manufacturer. Otherwise, degradation of the performance of this device could result.**
- **The non-ME EQUIPMENT (e.g. ITE) that is a part of an ME SYSTEM may be disrupted by the electromagnetic interference of nearby equipment. It may be necessary to take mitigation measures, such as re-orienting or relocating the non-ME EQUIPMENT or shielding the location.**
- **This device is intended for use in professional healthcare facility environment and home healthcare environment only. If it is used in special environment, such as magnetic resonance imaging environment, the equipment/system may be disrupted by the operation of nearby equipment.**

Guidance and Declaration - Electromagnetic Emissions		
The device is intended for use in the electromagnetic environment specified below. The customer or the user of the device should assure that it is used in such an environment.		
Emission tests	Compliance	Electromagnetic environment - guidance
Conducted and radiated RF EMISSIONS CISPR 11	Group 1	The device uses RF energy only for its internal function. Therefore, its RF emissions are very low and are not likely to cause any interference in nearby electronic device.
Conducted and radiated RF EMISSIONS CISPR 11	Class B	The device is suitable for use in all establishments, including domestic establishments and those directly connected to the public low-voltage power supply network that supplies buildings used for domestic purposes.
Conducted and radiated RF EMISSIONS CISPR 11	Class A (Used with Dock)	The device is suitable for use in all establishments other than domestic and those directly connected to the public low-voltage power supply network that supplies buildings used for domestic purposes.
Harmonic distortion IEC 61000-3-2	Class A	The device is suitable for use in all establishments, including domestic establishments and those directly connected to the public low-voltage power supply network that supplies buildings used for domestic purposes.
Voltage fluctuations and flicker IEC 61000-3-3	Complies	

NOTE

- **The device needs special precautions regarding EMC and needs to be installed and put into service according to the EMC information provided below.**
- **Other devices may affect this device even though they meet the requirements of CISPR.**

- **When the inputted signal is below the minimum amplitude provided in technical specifications, erroneous measurements could result.**
- **The EMISSIONS characteristics of this device make it suitable for use in industrial areas and hospitals (CISPR 11 class A). If it is used in a residential environment (for which CISPR 11 class B is normally required) this device might not offer adequate protection to radio-frequency communication services. The user might need to take mitigation measures, such as relocating or re-orienting the device.**
- **If the essential performance is lost or degraded, it may be necessary to take mitigation measures, such as re-orienting or relocating the ME EQUIPMENT or ME SYSTEM or shielding the location or stopping using the monitor and contact the service personnel.**

If the device is operated within the electromagnetic environment listed in Table **Guidance and Declaration — Electromagnetic Immunity**, the system will remain safe and provide the following essential performance:

- Operating mode
- Accuracy
- Function
- Accessories identification
- Data stored
- Alarm
- Detect for connection

Guidance and Declaration - Electromagnetic Immunity			
The device is intended for use in the electromagnetic environment specified below. The customer or the user of the device should assure that it is used in such an environment.			
Immunity test	IEC60601 test level	Compliance level	Electromagnetic environment - guidance
Electrostatic discharge (ESD) IEC 61000-4-2	±8 kV contact ±15kV air	±8 kV contact ±15kV air	Floors should be wood, concrete or ceramic tile. If floors are covered with synthetic material, the relative humidity should be at least 30%.
Electrical fast transient/burst IEC 61000-4-4	±2 kV for power supply lines ±1 kV for input/output lines (length greater than 3 m)	±2 kV for power supply lines ±1 kV for input/output lines (length greater than 3 m)	Mains power quality should be that of a typical commercial or hospital environment.
Surge IEC 61000-4-5	±1 kV line(s) to line(s) ±2 kV line(s) to earth	±1 kV line(s) to line(s) ±2 kV line(s) to earth	
Voltage dips and Voltage interruptions IEC 61000-4-11	0 % U_T for 0,5 cycle 0 % U_T for 1 cycle and 70 % U_T for 25/30 cycles 0 % U_T for 250/300 cycle	0 % U_T for 0,5 cycle 0 % U_T for 1 cycle and 70 % U_T for 25/30 cycles 0 % U_T for 250/300 cycle	Mains power quality should be that of a typical commercial or hospital environment. If the user of our product requires continued operation during power mains interruptions, it is recommended that our product be powered from an uninterruptible power supply or a battery.
RATED power frequency magnetic fields IEC 61000-4-8	30 A/m 50 Hz / 60 Hz	30 A/m 50 Hz / 60 Hz	Power frequency magnetic fields should be at levels characteristic of a typical location in a typical commercial or hospital environment.
Note: U_T is the AC mains voltage prior to application of the test level.			

Guidance and Declaration - Electromagnetic Immunity

The device is intended for use in the specified electromagnetic environment. The customer or the user of the device should assure that it is used in such an environment as described below.

Immunity test	IEC60601 test level	Compliance level	Electromagnetic environment - guidance
Conducted disturbances induced by RF fields IEC61000-4-6	3 Vrms 150 kHz to 80 MHz	3 Vrms	Portable and mobile RF communications equipment should be used no closer to any part of the device, including cables, than the recommended separation distance calculated from the equation applicable to the frequency of the transmitter. Recommended separation distance: $d = \left[\frac{3.5}{V} \right] \sqrt{P}$ 150k to 80 MHz $d = \left[\frac{3.5}{E} \right] \sqrt{P}$ 80 MHz to 80 0MHz $d = \left[\frac{7}{E} \right] \sqrt{P}$ 800 MHz to 2.7GHz where P is the maximum output power rating of the transmitter in watts (W) according to the transmitter manufacturer and d is the recommended separation distance in meters (m). Field strengths from fixed RF transmitters, as determined by an electromagnetic site survey ^p , should be less than the compliance level in each frequency range ^c . Interference may occur in the vicinity of equipment marked with the following symbol: 
	6 Vrms in ISM bands and amateur radio bands ^a between 0,15 MHz and 80 MHz	6 Vrms	
Radiated RF EM fields IEC61000-4-3	10V/m 80 MHz to 2.7 GHz	10V/m	
	20V/m 80 MHz to 2.5 GHz (IEC80601-2-30: 2013, ISO80601-2-55: 2011, ISO80601-2-56: 2009, ISO80601-2-61: 2011)	20V/m	
Proximity fields from RF wireless communications equipment IEC61000-4-3	27 V/m 380–390 MHz	27 V/m	
	28 V/m 430–470 MHz, 800–960 MHz, 1700–1990 MHz, 2400–2570 MHz	28 V/m	
	9 V/m 704–787 MHz, 5100–5800 MHz	9 V/m	

Note 1: At 80 MHz and 800 MHz, the higher frequency range applies.

Note 2: These guidelines may not apply in all situations. Electromagnetic propagation is affected by absorption and reflection from structures, objects and people.

Guidance and Declaration - Electromagnetic Immunity
<p>^a The ISM (industrial, scientific, and medical) bands between 150 kHz and 80 MHz are 6.765 MHz to 6.795 MHz; 13.553 MHz to 13.567 MHz; 26.957 MHz to 27.283 MHz; and 40.66 MHz to 40.70 MHz. The amateur radio bands between 0,15 MHz and 80 MHz are 1,8 MHz to 2,0 MHz, 3,5 MHz to 4,0 MHz, 5,3 MHz to 5,4 MHz, 7 MHz to 7,3 MHz, 10,1 MHz to 10,15 MHz, 14 MHz to 14,2 MHz, 18,07 MHz to 18,17 MHz, 21,0 MHz to 21,4 MHz, 24,89 MHz to 24,99 MHz, 28,0 MHz to 29,7 MHz and 50,0 MHz to 54,0 MHz.</p> <p>^b Field strengths from fixed transmitters, such as base stations for radio (cellular/cordless) telephones and land mobile radios, amateur radio, AM and FM radio broadcast and TV broadcast cannot be predicted theoretically with accuracy. To assess the electromagnetic environment due to fixed RF transmitters, an electromagnetic site survey should be considered. If the measured field strength in the location in which the device is used exceeds the applicable RF compliance level above, the device should be observed to verify normal operation. If abnormal performance is observed, additional measures may be necessary, such as re-orienting or relocating the device.</p> <p>^c Over the frequency ranges 150 kHz to 80 MHz, field strengths should be less than 3V/m.</p>

Recommended Separation Distances between Portable and Mobile RF, Communications Equipment and This Equipment			
The equipment is intended for use in an electromagnetic environment in which radiated RF disturbance are controlled. The customer or the user of the device can help prevent electromagnetic interference by maintaining a minimum distance between portable and mobile RF communications equipment (transmitters) and the device as recommended below, according to the maximum output power of the communication equipment.			
Rated Maximum Output power of Transmitter Watts (W)	Separation Distance According to Frequency of Transmitter (m)		
	150 kHz to 80 MHz $d = \left[\frac{3.5}{V} \right] \sqrt{P}$	80 MHz to 800 MHz $d = \left[\frac{3.5}{E} \right] \sqrt{P}$	800 MHz to 2.7 GHz $d = \left[\frac{Z}{E} \right] \sqrt{P}$
0.01	0.12	0.12	0.23
0.1	0.38	0.38	0.73
1	1.2	1.20	2.3
10	3.8	3.80	7.3
100	12	12.00	23
For transmitters at a maximum output power not listed above, the recommended separation distanced in meters (m) can be determined using the equation applicable to the frequency of the transmitter, where P is the maximum output power rating of the transmitter in watts (W) according to the transmitter manufacturer.			
Note 1: At 80 MHz and 800 MHz, the higher frequency range applies.			
Note 2: These guidelines may not apply in all situations. Electromagnetic propagation is affected by absorption and reflection from structures, objects and people.			

B.2 Radio Regulatory Compliance

RF parameters

Radio devices	IEEE 802.11b/g/n (2.4G)	IEEE 802.11a/n (5G)
Operating Frequency	ETSI: 2.4 GHz to 2.483 GHz FCC: 2.4 GHz to 2.483 GHz MIC: 2.4 GHz to 2.495GHz KC: 2.4 GHz to 2.483 GHz	ETSI: 5.15 GHz to 5.35 GHz, 5.47 GHz to 5.725 GHz FCC: 5.15GHz to 5.35GHz, 5.47~5.725GHz to 5.725GHz to 5.825GHz MIC: 5.15GHz to 5.35GH, 5.47 to 5.725GHz KC: 5.15GHz to 5.35GHz, 5.47 to 5.725GHz, 5.725GHz to 5.825GHz
Modulation Mode	DSSS and OFDM	OFDM
Output Power	<30dBm (Peak Power) <20dBm (Average Power)	

This device complies with Part 15 of the FCC Rules and RSS-210 of Industry Canada. Operation is subject to the following two conditions: (1) this device may not cause harmful interference, and (2) this device must accept any interference received, including interference that may cause undesired operation.

Any changes or modifications to this equipment not expressly approved by Mindray may cause harmful radio frequency interference and void your authority to operate this equipment.

The maximum antenna gain permitted complies with the e.i.r.p. limits as stated in RSS-210.

The maximum antenna gain permitted complies with the e.i.r.p. limits specified for point-to-point operation, as stated in RSS-210

C Default Settings

C.1 ECG, Arrhythmia, ST and QT Default Settings

C.1.1 ECG Default Settings

Item		Default Setting
HR	Alarm switch	On
	High limit	Adult: 120 bpm Pediatric: 160 bpm Neonate: 200 bpm
	Low limit	Adult: 50 bpm Pediatric: 75 bpm Neonate: 100 bpm
	Priority	Med
	Alarm Outputs	Off
	Alarm Source	Auto
ECG1		II
ECG2 (5-lead, 6-lead, 12-lead)		V, Va, V1
Va (for 6-lead only)		Va
Vb (for 6-lead only)		Vb
ECG Gain		×1
Speed		25 mm/sec
Filter		OR: Surgery CCU: Diagnostic Other departments: Monitor
Notch Filter		On
Lead Set		Auto
Smart Lead		On
QRS Volume		General and OR: 2 Other department : 0
Baseline Drift Removal (for 12-lead only)		On
Waveform Layout (for 12-lead only)		Standard
QRS Threshold		0.16 mV
Paced		Adult: Unspecified Pediatric/neonate: No
Pacer Reject		Off

C.1.2 Arrhythmia Default Settings

C.1.2.1 Arrhythmia Alarm Default Settings

Item	Alarm Switch	Priority	Alarm Outputs
Asystole	On	High, unadjustable	Off
V-Fib/V-Tach	On	High, unadjustable	Off
V-Tach	On	High, unadjustable	Off
Vent Brady	On	High, unadjustable	Off
Extreme Tachy	On	High, unadjustable	Off
Extreme Brady	On	High, unadjustable	Off
R on T	CCU: On Other departments: Off	Med	Off
Run PVCs	Off	Low	Off
Couplet	Off	Prompt	Off
Multiform PVC	Off	Med	Off
PVC	Off	Prompt	Off
Bigeminy	CCU: On Other departments: Off	Med	Off
Trigeminy	CCU: On Other departments: Off	Med	Off
Tachy	Off	Med	Off
Brady	Off	Med	Off
Pacer Not Capture	Off	Prompt	Off
Pacer Not Pacing	Off	Prompt	Off
Missed Beats	Off	Prompt	Off
Nonsus V-Tach	CCU: On Other departments: Off	Med	Off
Vent Rhythm	CCU: On Other departments: Off	Med	Off
Pause	Off	Low	Off
Irr. Rhythm	Off	Prompt	Off
A-Fib	Off	Prompt	Off
PVCs/min	CCU: On Other departments: Off	Med	Off
Pauses/min	CCU: On Other departments: Off	Med	Off

C.1.2.2 Arrhythmia Threshold Default Settings

Item	Default Setting		
	Adult	Pediatric	Neonate
Asystole Delay	5 sec	5 sec	5 sec
Tachy	120 bpm	160 bpm	200 bpm
Brady	50 bpm	75 bpm	100 bpm
Extreme Tachy	160 bpm	180 bpm	220 bpm
Extreme Brady	35 bpm	50 bpm	60 bpm
Multiform PVC Window	15 beats	15 beats	15 beats
PVCs/min	10	10	10
Pauses/min	8	8	8
Pause Threshold	2.0 sec	2.0 sec	2.0 sec
AF/Irr Rhy End Time	2 min	2 min	2 min
V-Tach Rate	130 bpm	130 bpm	160 bpm
V Brady Rate	40 bpm	40 bpm	40 bpm
V-Tach PVCs	6	6	6
V-Brady PVCs	5	5	5

C.1.3 ST Default Settings

Item	Default Setting	
ST Alarm Mode	Absolute	
ST-I, ST-II, ST-III, ST-aVR, ST-aVL, ST-aVF, ST-V1, ST-V2, ST-V3, ST-V4, ST-V5, ST-V6, ST-Va, ST-Vb (ST Alarm Mode set to Absolute)	Alarm switch	Off
	High limit	0.2 mV
	Low limit	-0.2 mV
	Priority	Med
	Alarm Outputs	Off
ST Single, ST Dual (ST Alarm Mode set to Relative)	Alarm switch	Off
	High limit	0.1 mV
	Low limit	-0.1 mV
	Priority	Med
	Alarm Outputs	Off
ST Analysis	Off	
ST Segment	Auto	
Show Marker	Off	
ST Point	J+60	
Auto Adjust	On	
J	48	
ISO	-80	

C.1.4 QT Default Settings

Item		Default Setting
QTc	Alarm switch	Off
	High limit	Adult: 500 Pediatric: 480 Neonate: 460
	Priority	Med
	Alarm Outputs	Off
ΔQTc	Alarm switch	Off
	High limit	60
	Priority	Med
	Alarm Outputs	Off
QT Analysis		Off
QT Lead		All

C.1.5 Glasgow 12-lead ECG Algorithm Default Settings

Item	Default Setting
Filter	35 Hz
Baseline Drift Removal	On
Tachy	100
Brady	50
Waveform Layout	Standard
Median Complex	Off
Measurements	On
Interpretation	On
Interpretation Summary	On

C.2 Respiration Default Settings

Item		Default Setting
RR	Alarm switch	On
	High limit	Adult: 30 Pediatric: 30 Neonate: 100
	Low limit	Adult: 8 Pediatric: 8 Neonate: 30
	Priority	Med
	Alarm Outputs	Off

Item		Default Setting
Zero RR	Alarm switch	On
	Priority	High, unadjustable
	Alarm Outputs	Off
Zero RR Delay		Adult: 20 sec Pediatric: 20 sec Neonate: 15 sec
RR Source		Auto
Resp Lead		Adult: Auto Pediatric: Auto Neonate: II
Gain		×2
Speed		6.25 mm/s
Auto Threshold Detection		On

C.3 SpO₂ Default Settings

Item		Default Setting
SpO ₂	Alarm switch	On
	High limit	Adult: 100% Pediatric: 100% Neonate: 95%
	Low limit	90%
	Priority	Med
	Alarm Outputs	Off
SpO ₂ Desat	Alarm switch	On
	Low limit	80%
	Priority	High
	Alarm Outputs	Off
Satsecond (for Nellcor SpO ₂)		Off
NIBP Simul		Off
Sensitivity (for Mindray SpO ₂)		Medium
Display PI (for Mindray SpO ₂ and Masimo SpO ₂)		On
Speed		25 mm/s

Item		Default Setting
PR	Alarm switch	On
	High limit	Adult: 120 Pediatric: 160 Neonate: 200
	Low limit	Adult: 50 Pediatric: 75 Neonate: 100
	Priority	Med
	Alarm Outputs	Off
	Alarm Source	Auto
	PR Source	Auto
	QRS Volume	General, OR: 2 Other departments: 0

C.4 Temperature Default Settings

C.4.1 Temperature Default Settings

Item		Default Setting
T1, T2	Alarm switch	On
	High limit	38.0 °C
	Low limit	35.0 °C
	Priority	Med
	Alarm Outputs	Off
ΔT	Alarm switch	On
	High limit	2.0 °C
	Priority	Med
	Alarm Outputs	Off

C.5 NIBP Default Settings

Item		Default Setting
NIBP-S	Alarm switch	On
	High limit	Adult: 160 mmHg Pediatric: 120 mmHg Neonate: 90 mmHg
	Low limit	Adult: 90 mmHg Pediatric: 70 mmHg Neonate: 40 mmHg
	Priority	Med
	Alarm Outputs	Off

Item		Default Setting
NIBP-D	Alarm switch	On
	High limit	Adult: 90 mmHg Pediatric: 70 mmHg Neonate: 60 mmHg
	Low limit	Adult: 50 mmHg Pediatric: 40 mmHg Neonate: 20 mmHg
	Priority	Med
	Alarm Outputs	Off
NIBP-M	Alarm switch	On
	High limit	Adult: 110 mmHg Pediatric: 90 mmHg Neonate: 70 mmHg
	Low limit	Adult: 60 mmHg Pediatric: 50 mmHg Neonate: 25 mmHg
	Priority	Med
	Alarm Outputs	Off
NIBP-S Extreme	Alarm switch	Off
	High limit	Adult: 175 mmHg Pediatric: 130 mmHg Neonate: 95 mmHg
	Low limit	Adult: 75 mmHg Pediatric: 60 mmHg Neonate: 35 mmHg
	Priority	High
	Alarm Outputs	Off
NIBP-D Extreme	Alarm switch	Off
	High limit	Adult: 105 mmHg Pediatric: 80 mmHg Neonate: 65 mmHg
	Low limit	Adult: 35 mmHg Pediatric: 30 mmHg Neonate: 15 mmHg
	Priority	High
	Alarm Outputs	Off
NIBP-M Extreme	Alarm switch	Off
	High limit	Adult: 125 mmHg Pediatric: 100 mmHg Neonate: 75 mmHg
	Low limit	Adult: 45 mmHg Pediatric: 40 mmHg Neonate: 20 mmHg
	Priority	High
	Alarm Outputs	Off

Item	Default Setting
Initial Pressure	Adult: 160 mmHg Pediatric: 140 mmHg Neonate: 90 mmHg
Interval	OR: 5 min NICU: 30 min Other departments: 15 min
Start Mode	Clock
NIBP End Tone	Off
Venipuncture Pressure	Auto

C.6 IBP Default Settings

Item	Default Setting	
IBP-S	Alarm switch	On
	High limit	<ul style="list-style-type: none"> ■ Art/pArt/Ao/UAP/BAP/FAP/LV/P1-P4 arterial pressure Adult: 160 mmHg Pediatric: 120 mmHg Neonate: 90 mmHg ■ PA Adult: 35 mmHg Pediatric and neonate: 60 mmHg
	Low limit	<ul style="list-style-type: none"> ■ Art/pArt/Ao/UAP/BAP/FAP/LV/P1-P4 arterial pressure Adult: 90 mmHg Pediatric: 70 mmHg Neonate: 55 mmHg ■ PA Adult: 10 mmHg Pediatric and neonate: 24 mmHg
	Priority	Med
	Alarm Outputs	Off

Item		Default Setting
IBP-D	Alarm switch	On
	High limit	<ul style="list-style-type: none"> ■ Art/pArt/Ao/UAP/BAP/FAP/LV/P1-P4 arterial pressure Adult: 90 mmHg Pediatric: 70 mmHg Neonate: 60 mmHg ■ PA Adult: 16 mmHg Pediatric and neonate: 4 mmHg
	Low limit	<ul style="list-style-type: none"> ■ Art/pArt/Ao/UAP/BAP/FAP/LV/P1-P4 arterial pressure Adult: 50 mmHg Pediatric: 40 mmHg Neonate: 20 mmHg ■ PA Adult: 0 mmHg Pediatric and neonate: -4 mmHg
	Priority	Med
	Alarm Outputs	Off
IBP-M	Alarm switch	On
	High limit	<ul style="list-style-type: none"> ■ Art/pArt/Ao/UAP/BAP/FAP/LV/P1-P4 arterial pressure Adult: 110 mmHg Pediatric: 90 mmHg Neonate: 70 mmHg ■ PA Adult: 20 mmHg Pediatric and neonate: 26 mmHg ■ CVP//pCVP/ICP/RAP/LAP/UVP/P1-P4 venous pressure Adult: 10 mmHg Pediatric and neonate: 4 mmHg
	Low limit	<ul style="list-style-type: none"> ■ Art/pArt/Ao/UAP/BAP/FAP/LV/P1-P4 arterial pressure Adult: 70 mmHg Pediatric: 50 mmHg Neonate: 35 mmHg ■ PA Adult: 0 mmHg Pediatric and neonate: 12 mmHg ■ CVP/pCVP//ICP/RAP/LAP/UVP/P1-P4 venous pressure Adult: 0 mmHg Pediatric and neonate: 0 mmHg
	Priority	Med
	Alarm Outputs	Off

Item		Default Setting
Art-S Extreme	Alarm switch	Off
	High limit	Adult: 175 mmHg Pediatric: 130 mmHg Neonate: 95 mmHg
	Low limit	Adult: 75 mmHg Pediatric: 60 mmHg Neonate: 50 mmHg
	Priority	High
	Alarm Outputs	Off
Art-D Extreme	Alarm switch	Off
	High limit	Adult: 105 mmHg Pediatric: 80 mmHg Neonate: 65 mmHg
	Low limit	Adult: 35mmHg Pediatric: 30 mmHg Neonate: 15 mmHg
	Priority	High
	Alarm Outputs	Off
Art-M Extreme	Alarm switch	Off
	High limit	Adult: 125 mmHg Pediatric: 100 mmHg Neonate: 75 mmHg
	Low limit	Adult: 55 mmHg Pediatric: 40 mmHg Neonate: 30 mmHg
	Priority	High
	Alarm Outputs	Off
CPP	Alarm switch	On
	High limit	Adult: 130 mmHg Pediatric: 100 mmHg Neonate: 90 mmHg
	Low limit	Adult: 50 mmHg Pediatric: 40 mmHg Neonate: 30 mmHg
	Priority	Med
	Alarm Outputs	Off
Measure (for P1, P2)		All
Measure (for P3, P4)		Mean only
Sensitivity		Med
Speed		25 mm/sec

Item		Default Setting
Scale(mmHg)	CVP/pCVP/ICP/RAP/ LAP/UVV venous pressure	0-20
	Art/pArt/Ao/BAP/FAP/ LV/P1/P2 arterial pressure	0-160
	UAP/P3/P4 venous pressure	0-80
	PA	0-30
PPV Measure		Off
PPV Source		Auto
PAWP	Reference Waveform 1	II
	Reference Waveform 2	Resp
	Speed	12.5 mm/sec
	PA Scale(mmHg)	0-30
Overlapping Waveform Setup	Left Scale(mmHg)	0-160
	Right Scale(mmHg)	0-20
	CVP Scale(mmHg)	0-20
	ICP Scale(mmHg)	0-20
	PA Scale(mmHg)	0-30
	Speed	25 mm/sec
	Gridlines	Off

C.7 CO₂ Default Settings

C.7.1 General Settings

Item		Default Setting
EtCO ₂	Alarm switch	On
	High limit	Adult and pediatric: 50 mmHg Neonate: 45 mmHg
	Low limit	Adult and pediatric: 25mmHg Neonate: 30mmHg
	Priority	Med
	Alarm Outputs	Off
FiCO ₂	Alarm switch	On
	High limit	4 mmHg
	Priority	Med
	Alarm Outputs	Off
Zero RR Delay		Adult and pediatric: 20 s Neonate: 15 s
RR Source		Auto

Item	Default Setting
Speed	6.25 mm/s
Scale	50 mmHg
Waveform Type	Draw

C.7.2 Sidestream CO₂ Default Settings

Item	Default Setting	
EtO ₂	Alarm switch	On
	High limit	88%
	Low limit	18%
	Priority	Med
	Alarm Outputs	Off
FiO ₂	Alarm switch	On
	High limit	Adult and pediatric: 100% Neonate: 90%
	Low limit	18%
	Priority	Med
	Alarm Outputs	Off
BTPS Compensation	Off	
O ₂ Compensation	OR: 100% Other departments: 21%	
N ₂ O Compensation	0%	
AG Compensation	0%	
Auto Standby	60 min	
Operating Mode	Measure	

C.7.3 Microstream CO₂ Default Settings

Item	Default Setting
BTPS Compen	Off
Maximum Hold	20 sec
Auto Standby	Off
Operating Mode	Measure

C.7.4 Mainstream CO₂ Default Settings

Item	Default Setting
Maximum Hold	10 sec
O ₂ Compensation	Off

Item	Default Setting
Balance Gas	Room Air
AG Compensation	0%
Operating Mode	Measure

C.8 Alarm Default Settings

Item	Default Setting
Alarm Volume	2
High Alarm Volume	Alarm Volume + 2
Reminder Volume	2
Zero RR Delay	Adult: 20 sec pediatric:20sec Neonate:15sec
Printing Duration on Alarm	20 sec

D Alarm Messages

D.1 Physiological Alarm Messages

This section lists major physiological alarms, their default priority, and the actions that can be taken when an alarm occurs. Some of alarms may not be included.

D.1.1 General Physiological Alarm Messages

Alarm messages	Default priority	Cause and solution
XX High	High/Med, configurable	XX value has risen above the high alarm limit or fallen below the low alarm limit. Check the patient's condition and check if the patient category and alarm limit settings are correct.
XX Low	High/Med, configurable	

Note: XX represents a measurement or parameter label, such as HR, NIBP, PVCs, RR, SpO₂, PR, and so on.

D.1.2 Arrhythmia Alarm Messages

Alarm message	Default priority
Asystole	High
V-Fib/V-Tach	High
V-Tach	High
Vent Brady	High
Extreme Tachy	High
Extreme Brady	High
PVCs/min	Med
Pauses/min	Med
R on T	Med
Bigeminy	Med
Trigeminy	Med
Tachy	Med
Brady	Med
Multiform PVC	Med
Vent Rhythm	Med
Nonsus V-Tach	Med
Run PVCs	Low
Pause	Low
Couplet	Prompt
PVC	Prompt
Irr Rhythm	Prompt
Pacer Not Pacing	Prompt

Alarm message	Default priority
Pacer Not Capture	Prompt
Missed Beats	Prompt
A-Fib	Prompt

Note: When arrhythmia alarms occur, check the patient's condition and the ECG connections.

D.1.3 Resp Physiological Alarm Messages

Alarm message	Default priority	Cause and solution
Resp Artifact	High	The patient's heartbeat has interfered with his respiration. Check the patient's condition and the Resp connections.
Zero RR	High	The respiration signal was so weak that the monitor cannot perform respiration analysis. Check the patient's condition, module and patient connections.

D.1.4 SpO₂ Physiological Alarm Messages

Alarm message	Default priority	Cause and solution
SpO ₂ Desat	High	The SpO ₂ value falls below the desaturation alarm limit. Check the patient's condition and check if the alarm limit settings are correct.

D.1.5 PR Physiological Alarm Messages

Alarm message	Default priority	Cause and solution
No Pulse	High	The pulse signal was so weak that the monitor cannot perform pulse analysis. Check the patient's condition, SpO ₂ sensor and measurement site.

D.1.6 NIBP Physiological Alarm Messages

Alarm message	Default priority	Cause and solution
NIBP-S/NIBP-D/NIBP-M Extremely High	High	The NIBP value is higher than the NIBP Extreme alarm high limit. Check the patient's condition and check if the alarm limit settings are correct.
NIBP-S/NIBP-D/NIBP-M Extremely Low	High	The NIBP value is lower than the NIBP Extreme alarm low limit. Check the patient's condition and check if the alarm limit settings are correct.

D.1.7 IBP Physiological Alarm Messages

Alarm message	Default priority	Cause and solution
Art-S/Art-D/Art-M Extremely High	High	The Art value is higher than the Art Extreme alarm high limit. Check the patient's condition and check if the alarm limit settings are correct.
Art-S/Art-D/Art-M Extremely Low	High	The Art value is lower than the Art Extreme alarm low limit. Check the patient's condition and check if the alarm limit settings are correct.

D.1.8 CO₂ Physiological Alarm Messages

Alarm message	Default priority	Cause and solution
FiO ₂ Shortage	High	FiO ₂ concentration is less than 18%. Check the patient's condition, the ventilated O ₂ content and the airway connection.

D.2 Technical Alarm Messages

This section lists major technical alarms, their default priority, indication on alarm reset, and the actions that can be taken when an alarm occurs. Some of alarms may not be included.

Technical alarms give different alarm indicators when the alarm system is reset. In this section we classify the technical alarms into three categories for easy clarification:

- A: technical alarms are cleared. The monitor gives no alarm indications.
- B: technical alarms are changed to the prompt messages.
- C: the alarm is silenced and a √ appears before the alarm message, indicating that the alarm is acknowledged.

In the following tables we will use A, B, and C to refer to the indications on alarm reset.

D.2.1 General Technical Alarm Messages

Alarm message	Default priority	Indication on alarm reset	Cause and solution
XX Module Error	High	C	XX module does not work properly. Replug the module, if the alarm persists, contact your service personnel.

Note: XX represents a measurement or parameter label, such as ECG, SpO₂, NIBP, IBP, CO₂, and so on.

D.2.2 ECG Technical Alarm Messages

Alarm message	Default priority	Indication on alarm reset	Cause and solution
ECG Noisy	Low/Prompt	A	The ECG signal is noisy. Check for any possible sources of signal noise around the cable and electrode, and check the patient for excessive motion.
ECG Amplitude Too Small	Low	C	The ECG amplitude does not reach the detected threshold. Check for any possible source of interference around the cable and electrode.
ECG Lead Off	High, Med, or Low, configurable	B	The electrode has become detached from the patient or the lead wire has become disconnected from the adapter cable. Check the connections of the electrodes and leadwires.
ECG XX Lead Off	High, Med, or Low, configurable	B	The electrode has become detached from the patient or the lead wire has become disconnected from the adapter cable. Check the connections of the electrodes and leadwires.
ECG Signal Invalid	Low	A	Patient skin impedance is too high. Check ECG electrode application.
ECG Learning	Prompt	/	ECG learning is manually or automatically triggered.

Alarm message	Default priority	Indication on alarm reset	Cause and solution
Cannot Analyze QT	Prompt	/	/

Note: XX represents ECG lead name, for example RL, LL, V, Va, Vb, and so on.

D.2.3 Resp Technical Alarm Messages

Alarm message	Default priority	Indication on alarm reset	Cause and solution
Resp Interference	Prompt	/	The respiration circuit is disturbed. Check for any possible sources of signal noise.
Electrode Poor Contact	Prompt	/	Check the electrode application. Reposition or replace the electrodes if necessary.

D.2.4 SpO₂ Technical Alarm Messages

Alarm message	Default priority	Indication on alarm reset	Cause and solution
SpO ₂ Sensor Off	High, Med, or Low, configurable	B	The SpO ₂ sensor has become detached from the patient or the module. Check the sensor connection. If the alarm persists, replace the sensor.
SpO ₂ No Sensor	Low	A	The SpO ₂ extension cable is detached from the SpO ₂ module, or the SpO ₂ sensor is detached from the SpO ₂ extension cable. Check the SpO ₂ cable and the sensor connection. If the alarm persists, replace the sensor.
SpO ₂ Excess Light	Low	C	Ambient light is too strong. Move the sensor to a place with lower level of ambient light or cover the sensor to minimize the ambient light.
SpO ₂ No Pulse	Low	C	The SpO ₂ sensor failed to obtain pulse signal. Check the patient's condition and replace the sensor application site. If the alarm persists, replace the sensor.
SpO ₂ Sensor Incompatible	Low	C	Incompatible or an unspecified SpO ₂ sensor is used. Use specified sensors.
SpO ₂ Low Signal Quality	Low	C	<ol style="list-style-type: none"> 1. Check the sensor and sensor position. 2. Make sure the patient is not shivering or moving. 3. The patient's pulse may be too low to be measured.
SpO ₂ Interference	Low	C	The SpO ₂ signal has been interfered. Check for any possible sources of signal noise and check the patient for excessive motion.
SpO ₂ Sensor Error	Low	C	Replace the sensor and measure again.
SpO ₂ Searching Pulse	Prompt	/	SpO ₂ is searching for pulse.
SpO ₂ Low Perfusion	Prompt	/	<p>The SpO₂ sensor is not properly placed or the patient's perfusion index is too low.</p> <ol style="list-style-type: none"> 1. Check the sensor and sensor position. 2. Reposition the sensor if necessary.

D.2.5 Temp Technical Alarm Messages

Alarm message	Default priority	Indication on alarm reset	Cause and solution
T1/T2 Sensor Off	Low	A	Check the sensor connection and reconnect the sensor.

D.2.6 NIBP Technical Alarm Messages

Alarm message	Default priority	Indication on alarm reset	Cause and solution
NIBP Cuff Loose	Low	A	There is a leak in the cuff or air tubing. Use a cuff of correct type based on the patient size. Apply the cuff and connect the air tubing as instructed in the manual.
NIBP Cuff or Airway Leak	Low	A	Check the NIBP cuff and pump for leakages.
NIBP Airway Error	Low	A	The air tubing may be occluded. Check the air tubing for an occlusion or kinking. If the alarm persists, contact your service personnel.
NIBP Weak Signal	Low	A	The patient's pulse is weak or the cuff is loose. Check the patient's condition and replace the cuff application site.
NIBP Overrange	Low	A	The measured NIBP value exceeds the module measurement range. Check the patient's condition.
NIBP Excessive Motion	Low	A	Check the patient's condition and reduce patient motion.
NIBP Cuff Overpressure	Low	A	The NIBP airway may be occluded. Check the airway and measure again. If the alarm persists, contact your service personnel.
NIBP Timeout	Low	A	The measurement time exceeds 120 seconds in the adult or pediatric mode, or exceeds 90 seconds in the neonatal mode, and the BP value cannot be obtained. Check the patient's condition and NIBP connections, or replace the cuff and measure again.
NIBP Cuff and Patient Mismatch	Low	A	The cuff type mismatches the patient category. Verify the patient category or replace the cuff if necessary. If patient category is correct, check that the tubing is not bent and the airway is not occluded.
NIBP Airway Leak	Low	A	Airway leakage is found during the NIBP leakage test. Check the NIBP cuff and pump for leakages.

D.2.7 IBP Technical Alarm Messages

Alarm message	Default priority	Indication on alarm reset	Cause and solution
XX Sensor Error	Med	C	The IBP sensor fails. Replace the sensor.
XX No Sensor	High, Med, or Low, configurable	A	The IBP patient cable and/or corresponding IBP sensor is not connected or detached. Check the cable and sensor connection.

Alarm message	Default priority	Indication on alarm reset	Cause and solution
XX No Pulse	Low	A	The catheter may be occluded. Please flush the catheter.
XX Disconnected	High	C	The liquid way is disconnected from the patient, or the three-way valve is open to the air. Check the connection of the liquid way, or check the valve is open to the patient. If the alarm persists, contact your service personnel.

Note: XX represents an IBP label, for example PA, CVP, FAP, P1, and so on.

D.2.8 CO₂ Technical Alarm Messages

Alarm message	Default priority	Indication on alarm reset	Cause and solution
CO ₂ Module High Temp	Low	C	Ambient temperature is too high or there is a module failure. <ol style="list-style-type: none"> 1. Lower the operating temperature. 2. Replug the module. 3. If the alarm persists, the CO₂ module may fail, contact your service personnel.
CO ₂ Module Low Temp	Low	C	Ambient temperature is too low or there is a module failure. <ol style="list-style-type: none"> 1. Raise the operating temperature. 2. Replug the module. 3. If the alarm persists, the CO₂ module may fail, contact your service personnel.
CO ₂ Zero Failed	Low	C	For mainstream CO ₂ module, check the connections between the adapter and CO ₂ transducer. Wait till the sensor's temperature becomes stabilized, and then perform a zero calibration again. For sidestream CO ₂ module, replug the module. If the alarm persists, contact your service personnel.
CO ₂ No Watertrap	Low	B	Check the watertrap connections.
CO ₂ High Airway Pressure	Low	C	<ol style="list-style-type: none"> 1. Check the airway pressure settings of the ventilator/anesthesia machine. 2. Disconnect the module from the ventilator/anesthesia machine. 3. Replug the module. 4. If the alarm persists, contact your service personnel.
CO ₂ Low Airway Pressure	Low	C	<ol style="list-style-type: none"> 1. Check the airway pressure settings of the ventilator/anesthesia machine. 2. Disconnect the module from the ventilator/anesthesia machine. 3. Replug the module. 4. If the alarm persists, contact your service personnel.
CO ₂ High Barometric	Low	C	The ambient pressure exceeds the operating pressure range or CO ₂ module fails. <ol style="list-style-type: none"> 1. Make sure that the ambient pressure meets the specifications, and check for sources that affect the ambient pressure. 2. Replug the module. If the alarm persists, contact your service personnel.

Alarm message	Default priority	Indication on alarm reset	Cause and solution
CO ₂ Low Barometric	Low	C	The ambient pressure exceeds the operating pressure range or CO ₂ module fails. 1. Make sure that the ambient pressure meets the specifications, and check for sources that affect the ambient pressure. 2. Replug the module. If the alarm persists, contact your service personnel.
CO ₂ Airway Occluded	Low	C	1. Check if the sample line is kinked or occluded. 2. Replace the sample line. 3. Replug the module. 4. If the alarm persists, contact your service personnel.
CO ₂ No Filterline	Low	A	Make sure that the filterline is connected.
CO ₂ Calibration Required	Low	C	Perform a calibration.
CO ₂ Airway Error	Low	C	1. Check if the sample line is kinked or occluded. 2. Replace the sample line. 3. Replug the module. 4. If the alarm persists, contact your service personnel.
CO ₂ Adapter Error	Low	A	Check, clean or replace the airway adapter. Perform a zero calibration.
CO ₂ No Sensor	Low	A	Make sure that the CO ₂ transducer is connected.
CO ₂ : Change Watertrap	Low	C	Replace the watertrap.
CO ₂ Watertrap and Patient Mismatch	Low	C	Check the patient category and use a correct watertrap.

D.2.9 Power Supply Technical Alarm Messages

Alarm message	Default priority	Indication on alarm reset	Cause and solution
Low Battery	Med	C	Connect the monitor to an AC power source and allow the batteries to charge.
Critically Low Battery	High	C	Connect the monitor to an AC power source and allow the batteries to charge.
Battery Service Required	Low	B	The battery reaches its lifetime. Replace the battery.
Power Board Comm Error	High	C	Restart the monitor. If the alarm persists, contact your service personnel.
Battery Error	High	C	The battery may fail. Contact your service personnel.
Battery Charging Error	High	C	The charging circuit fails or the battery fails. Contact your service personnel.
Battery Temperature Too High	High	C	Stop using the monitor after this alarm appears, and contact your service personnel.
Battery Off	High	C	Restart the monitor. If the alarm persists, contact your service personnel.
RT Clock Need Reset	High	C	Contact your service personnel.
RT Clock Not Exist	High	C	Contact your service personnel.

Alarm message	Default priority	Indication on alarm reset	Cause and solution
XX V Too High	High	C	There is a problem with the system power supply. Restart the monitor.
XX V Too Low	High	C	

Note: XX represents 2.5 V, 3.3 V, 5 V, or 12 V.

D.2.10 Printer Technical Alarm Messages

Alarm message	Default priority	Indication on alarm reset	Cause and solution
Printer Buffer Full	Prompt	/	The printer buffer is full. Wait till the printer finishes the printing task.
Fail	Prompt	/	The printer runs out of paper or cannot be connected. Check the printer.
Printing Stopped	Prompt	/	Printing is manually stopped.
Printer Unavailable	Prompt	/	The printer may fail. Check the printer.

D.2.11 Technical Alarm Messages Related to Networked Monitoring

Alarm message	Default priority	Indication on alarm reset	Cause and solution
No CMS	Low	B	The monitor is disconnected from the CMS. Check the network connection.
View Bed XX YY-ZZ, Network Disconnected.	Low	A	The network is interrupted when the monitor is viewing the remote device. Check the network connection.
Viewed by Bed XX YY-ZZ, Network Disconnected.	Low	A	The network is interrupted when the monitor is viewed by another remote device. Check the network connection.
WLAN IP Address Conflict	Low	C	Wireless network IP network conflicts. Check the network settings.
LAN1 IP Address Conflict	Low	C	Wired network LAN1 IP network conflicts. Check the network settings.
Fail To Get WLAN IP Address	Low	C	Unable to automatically obtain the wireless network IP address. Check the network settings.
Fail To Get LAN1 IP Address	Low	C	Unable to automatically obtain the wired network LAN1 IP address. Check the network settings.

Note: XX refers to the department name, YY refers to the room number, and ZZ refers to the bed number.

D.2.12 Other System Technical Alarm Messages

Alarm message	Default priority	Indication on alarm reset	Cause and solution
Storage Card Error	High	C	The storage card fails or files are damaged. Restart the monitor to format the storage card. If the alarm persists, contact your service personnel.

Alarm message	Default priority	Indication on alarm reset	Cause and solution
Loading Default Config Failed	Low	A	The default configuration is not correctly loaded. The monitor will restore to the factory default configuration for the current patient category.
Read dock E2PROM error!	High	C	<ol style="list-style-type: none"> Check if you're using the specified external display. <ul style="list-style-type: none"> If you're using the specified external display, remove the N1 from the Dock, and reconnect the N1 and the Dock. If you're not using the specified external display, replace current external display with the specified external display. Then remove the N1 from the Dock, and reconnect the N1 and the Dock. If the alarm persists, contact your service personnel.
XX Conflicts (XX refers to the module label)	Prompt	/	The same type of corresponding module being used exceeds the supported number. Remove the conflict module.
XXX Measurement has been closed (XX refers to the module label)	Prompt	/	The parameter module is disabled. Switch on the module if you want to use it. For more information, see <i>3.11.1 Switching On or Off a Parameter</i> .
The display setup for XXX is disabled. (XX refers to the parameter label)	Prompt	/	The parameter of the newly inserted module is not displayed on the screen. Select a desired area to display the parameter numerics and waveforms. For more information, see <i>3.11.2 Displaying Parameter Numerics and Waveforms</i> .

E Electrical Safety Inspection

The following electrical safety tests are recommended as part of a comprehensive preventive maintenance program. They are a proven means of detecting abnormalities that, if undetected, could prove dangerous to either the patient or the operator. Additional tests may be required according to local regulations.

All tests can be performed using commercially available safety analyzer test equipment. These procedures assume the use of a 601PROXL International Safety Analyzer or equivalent safety analyzer. Other popular testers complying with IEC 60601-1 used in Europe, such as Fluke, Metron, or Gerb, may require modifications to the procedure. Please follow the instructions of the analyzer manufacturer.

The electrical safety inspection should be periodically performed every two years. The safety analyzer also proves to be an excellent troubleshooting tool to detect abnormalities of line voltage and grounding, as well as total current loads.

E.1 Power Cord Plug

Test Item		Acceptance Criteria
The power plug	The power plug pins	No broken or bent pin. No discolored pins.
	The plug body	No physical damage to the plug body.
	The strain relief	No physical damage to the strain relief. No plug warmth for device in use.
	The power plug	No loose connections.
The power cord		No physical damage to the cord. No deterioration to the cord.
		For devices with detachable power cords, inspect the connection at the device.
		For devices with non-detachable power cords, inspect the strain relief at the device.

E.2 Device Enclosure and Accessories

E.2.1 Visual Inspection

Test Item	Acceptance Criteria
The enclosure and accessories	No physical damage to the enclosure and accessories.
	No physical damage to meters, switches, connectors, etc.
	No residue of fluid spillage (e.g., water, coffee, chemicals, etc.).
	No loose or missing parts (e.g., knobs, dials, terminals, etc.).

E.2.2 Contextual Inspection

Test Item	Acceptance Criteria
The enclosure and accessories	No unusual noises (e.g., a rattle inside the case).
	No unusual smells (e.g., burning or smoky smells, particularly from ventilation holes).
	No taped notes that may suggest device deficiencies or operator concerns.

E.3 Device Labeling

Check the labels provided by the manufacturer or the healthcare facilities are present and legible.

- Main unit label
- Integrated warning labels

E.4 Protective Earth Resistance

1. Plug the probes of the analyzer into the device's protective earth terminal and protective earth terminal of the AC power cord.
2. Test the earth resistance with a current of 25 A.
3. Verify the resistance is less than limits.

LIMITS

For all countries, $R = 0.2 \Omega$ Maximum

E.5 Earth Leakage Test

Run an Earth Leakage test on the device being tested before performing any other leakage tests.

The following outlet conditions apply when performing the Earth Leakage test:

- normal polarity (Normal Condition),
- reverse polarity (Normal Condition),
- normal polarity with open neutral (Single Fault Condition),
- reverse polarity with open neutral (Single Fault Condition)

LIMITS

For UL60601-1,

- ◆ 300 μ A in Normal Condition
- ◆ 1000 μ A in Single Fault Condition

For IEC60601-1,

- ◆ 500 μ A in Normal Condition
- ◆ 1000 μ A in Single Fault Condition

E.6 Patient Leakage Current

Patient leakage currents are measured between a selected applied part and mains earth. All measurements have a true RMS only

The following outlet conditions apply when performing the Patient Leakage Current test.

- normal polarity (Normal Condition);
- reverse polarity (Normal Condition),
- normal polarity with open neutral (Single Fault Condition);
- reverse polarity with open neutral (Single Fault Condition).
- normal polarity with open earth (Single Fault Condition);
- reverse polarity with open earth (Single Fault Condition).

LIMITS

For CF  applied parts

- ◆ 10 μA in Normal Condition
- ◆ 50 μA in Single Fault Condition

For BF  applied parts

- ◆ 100 μA in Normal Condition
- ◆ 500 μA in Single Fault Condition

E.7 Mains on Applied Part Leakage

The Mains on Applied Part test applies a test voltage, which is 110% of the mains voltage, through a limiting resistance, to selected applied part terminals. Current measurements are then taken between the selected applied part and earth. Measurements are taken with the test voltage (110% of mains) to applied parts in the normal and reverse polarity conditions

The following outlet conditions apply when performing the Mains on Applied Part test.

- Normal Polarity;
- Reversed Polarity

LIMITS

- ◆ For CF  applied parts: 50 μA
- ◆ For BF  applied parts: 5000 μA

E.8 Patient Auxiliary Current

Patient Auxiliary currents are measured between any selected Applied Part connector and the remaining Applied Part connectors. All measurements may have a true RMS only response.

The following outlet conditions apply when performing the Patient Auxiliary Current test.

- normal polarity (Normal Condition);
- reverse polarity (Normal Condition),
- normal polarity with open neutral (Single Fault Condition);
- reverse polarity with open neutral (Single Fault Condition).
- normal polarity with open earth (Single Fault Condition);
- reverse polarity with open earth (Single Fault Condition).

LIMITS

For CF  applied parts,

- ◆ 10 μ A in Normal Condition
- ◆ 50 μ A in Single Fault Condition

For BF  applied parts,

- ◆ 100 μ A in Normal Condition
- ◆ 500 μ A in Single Fault Condition

NOTE

-
- **Make sure the safety analyzer is authorized comply with requirement of IEC60601-1.**
 - **Follow the instructions of the analyzer manufacturer.**
-

F SpO₂ Sensor Accuracy

F.1 The Accuracy of Mindray SpO₂ Sensors

Sensor	Measurement range(%)	Accuracy
520A	70~100	1.3188
	90~100	1.2538
	80~90	1.0394
	70~80	1.7183
520I	70~100	1.4844
	90~100	1.1488
	80~90	1.5224
	70~80	1.7336
520P	70~100	1.2520
	90~100	1.0370
	80~90	1.1660
	70~80	1.5222
520N	70~100	1.4023
	90~100	1.3253
	80~90	1.2187
	70~80	1.7246
512H	70~100	1.3518
	90~100	1.2644
	80~90	1.2367
	70~80	1.5493
512E	70~100	1.3644
	90~100	1.0298
	80~90	1.0584
	70~80	1.8796
512F	70~100	1.1510
	90~100	1.1005
	80~90	0.8595
	70~80	1.4488
512G	70~100	1.5572
	90~100	1.1648
	80~90	1.3474
	70~80	2.0564

Sensor	Measurement range(%)	Accuracy
518B, 518C	70~100	1.8380
	90~100	1.2487
	80~90	1.6938
	70~80	2.4207
512FLH	90~100	1.4192
	80~90	1.5238
	70~80	2.3300

The Linear Matching Graph of 520A SpO₂ Sensor

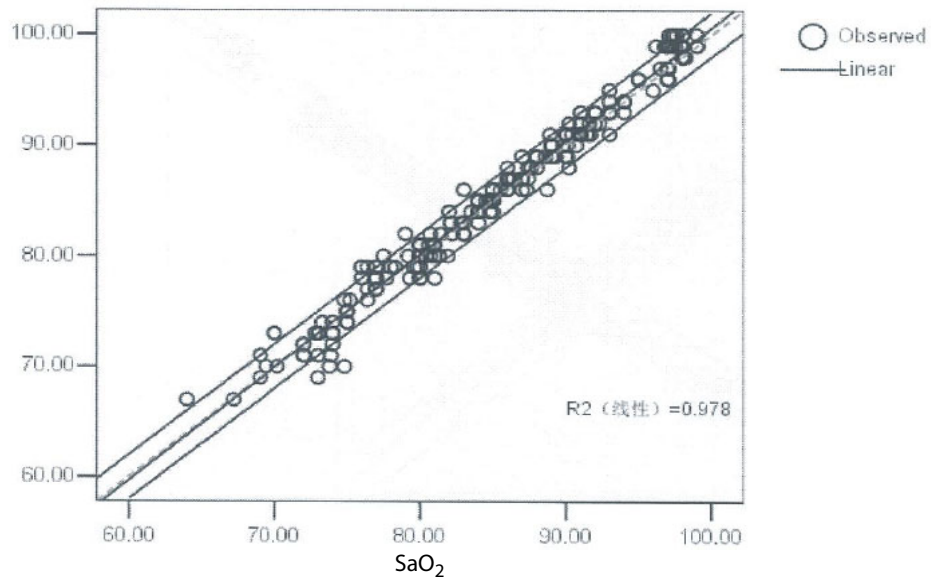

Matching results of SpO₂ measured by the EUT with 520A SpO₂ sensor and the reference equipment

The Linear Matching Graph of 520I SpO₂ Sensor

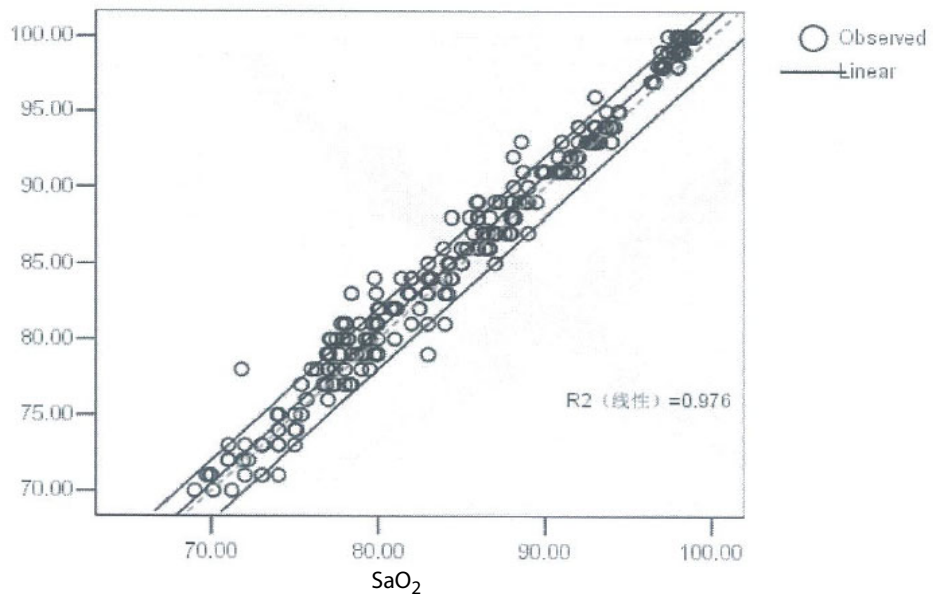

Matching results of SpO₂ measured by the EUT with 520I SpO₂ sensor and the reference equipment

The Linear Matching Graph of 520P SpO₂ Sensor

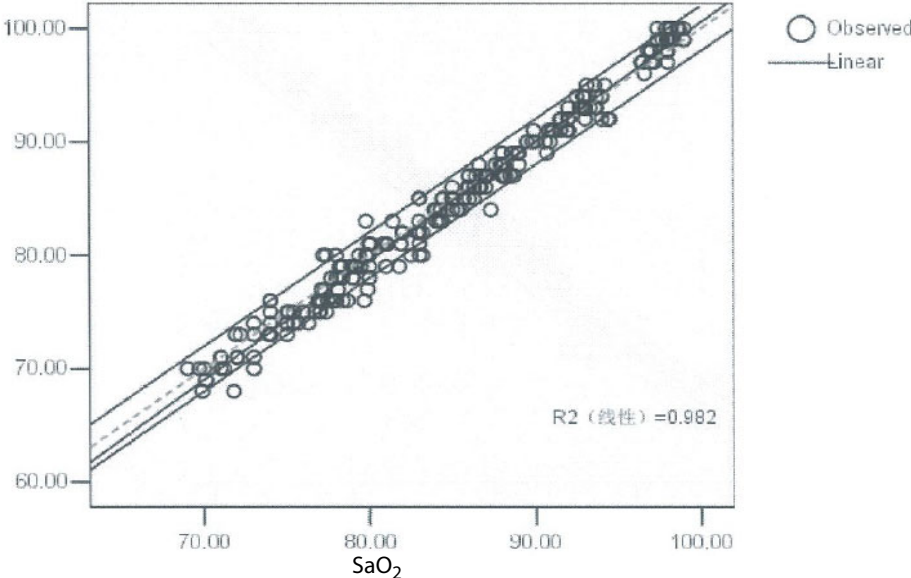

Matching results of SpO₂ measured by the EUT with 520P SpO₂ sensor and the reference equipment

The Linear Matching Graph of 520N SpO₂ Sensor

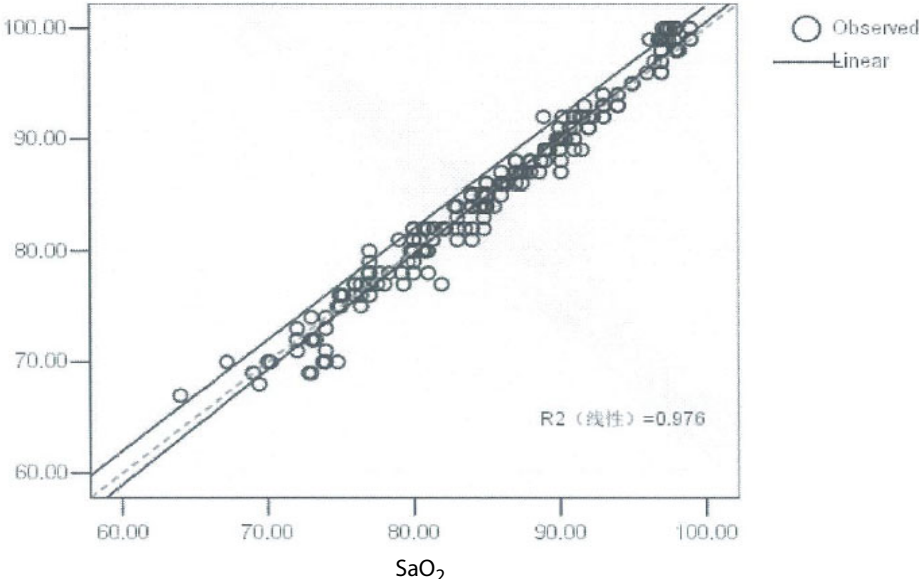

Matching results of SpO₂ measured by the EUT with 520N SpO₂ sensor and the reference equipment

The Linear Matching Graph of 512H SpO₂ Sensor

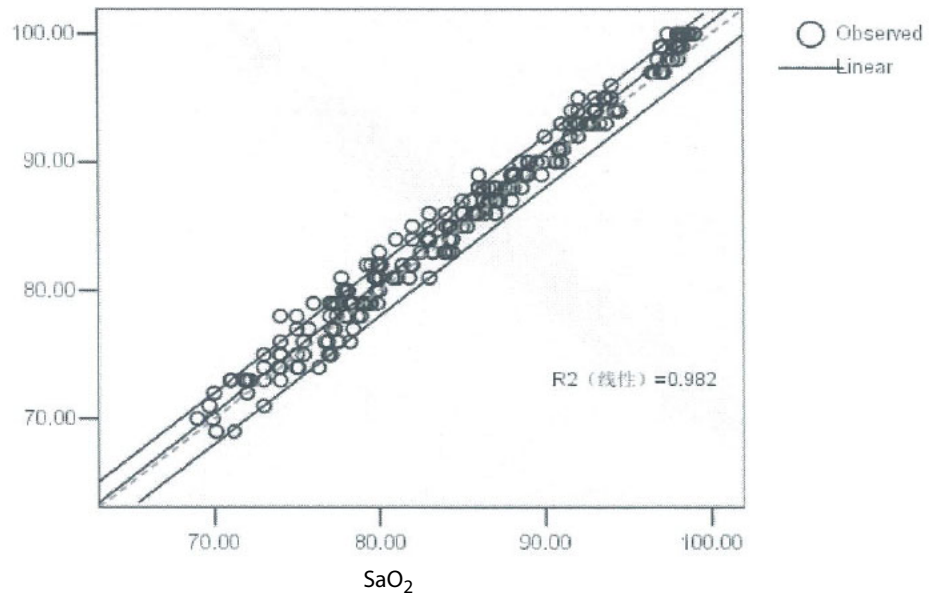

Matching results of SpO₂ measured by the EUT with 512H SpO₂ sensor and the reference equipment

The Linear Matching Graph of 512E SpO₂ Sensor

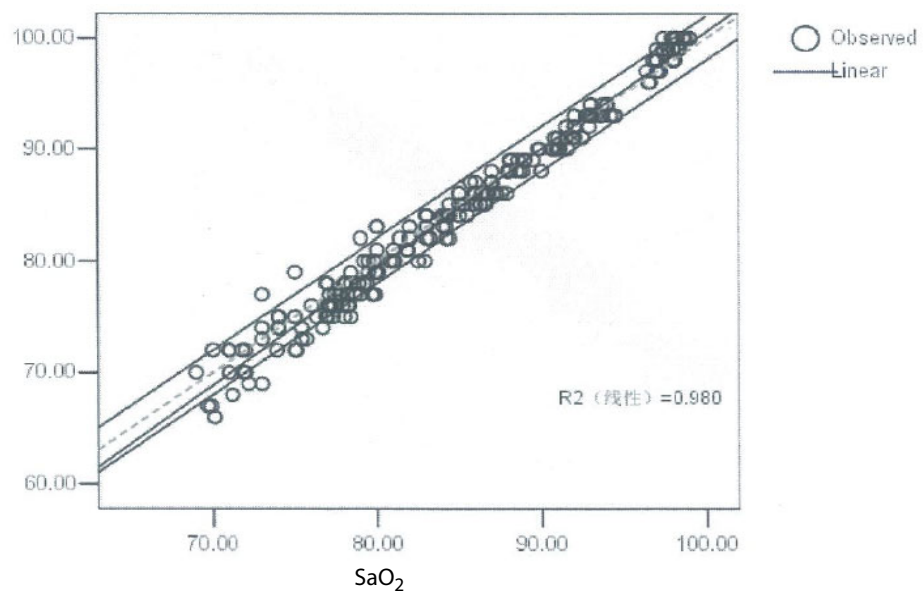

Matching results of SpO₂ measured by the EUT with 512E SpO₂ sensor and the reference equipment

The Linear Matching Graph of 512F SpO₂ Sensor

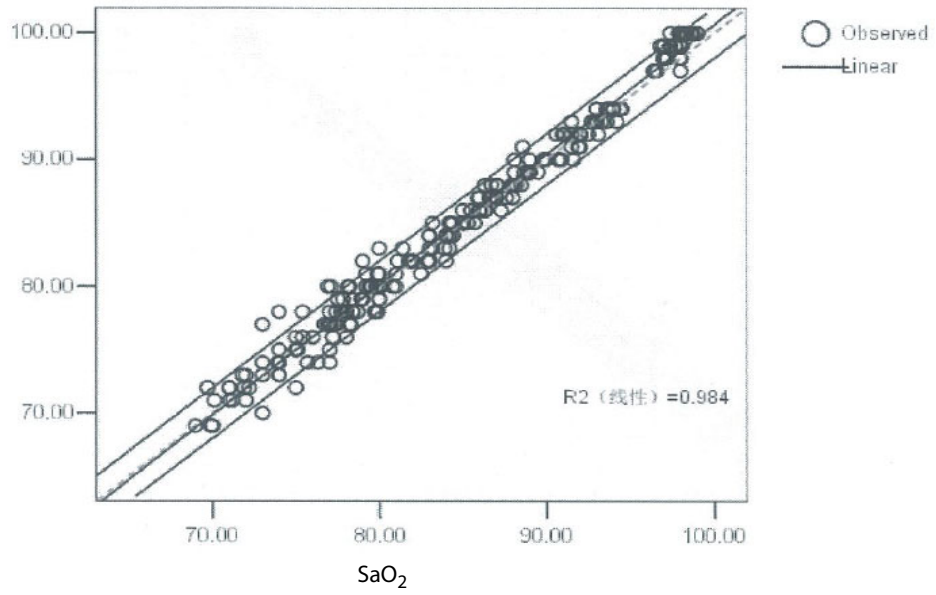

Matching results of SpO₂ measured by the EUT with 512F SpO₂ sensor and the reference equipment

The Linear Matching Graph of 512G SpO₂ Sensor

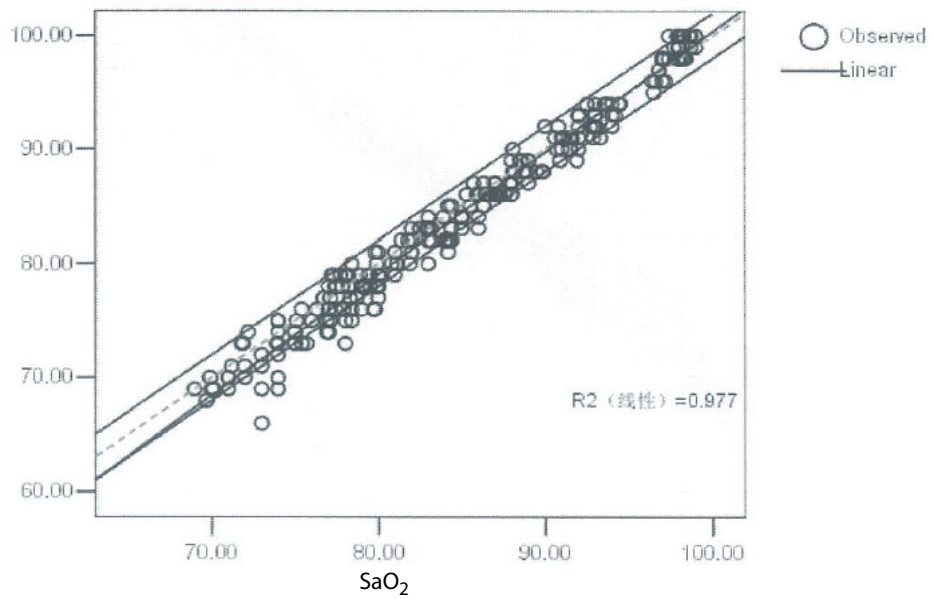

Matching results of SpO₂ measured by the EUT with 512G SpO₂ sensor and the reference equipment

The Linear Matching Graph of 518B/518C SpO₂ Sensor

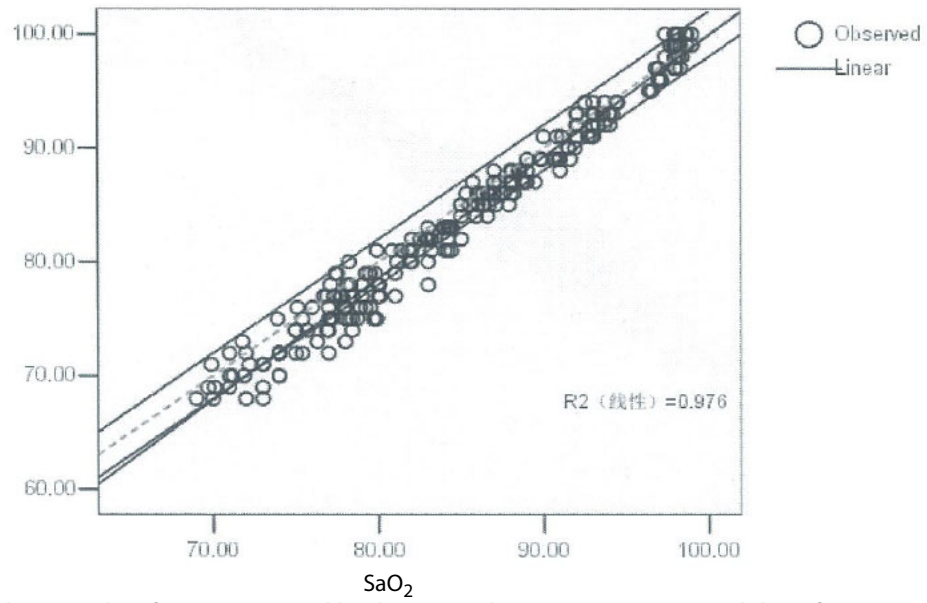

Matching results of SpO₂ measured by the EUT with 518B SpO₂ sensor and the reference equipment

The Linear Matching Graph of 512FLH SpO₂ Sensor

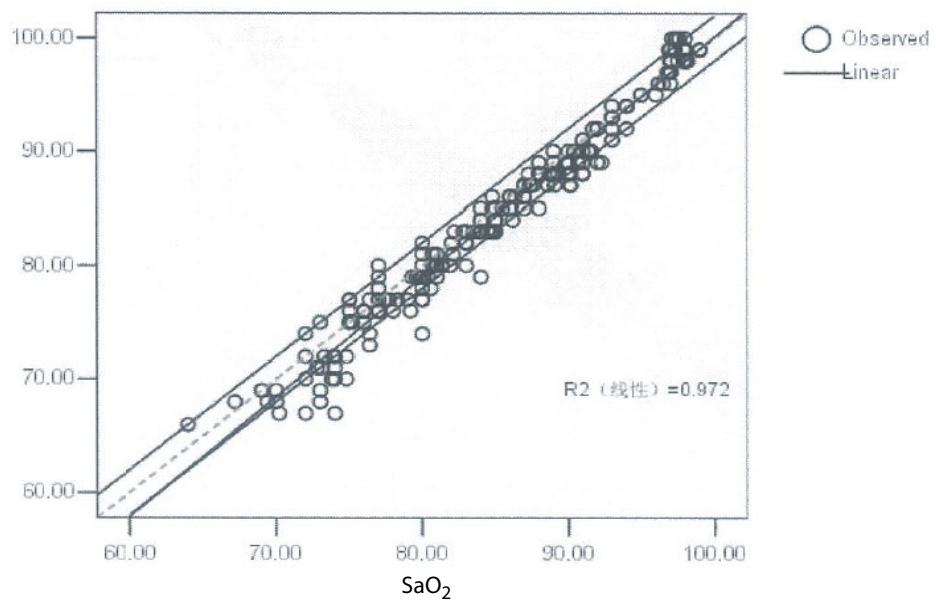

Matching results of SpO₂ measured by the EUT with 512FLH SpO₂ sensor and the reference equipment

F.2 The Accuracy of Masimo SpO₂ Sensors

Table information for the plots below show A_{RMS} values measured with Masimo Set Oximetry Technology in a clinical study.

Adtx/Pdtx/4000/4001

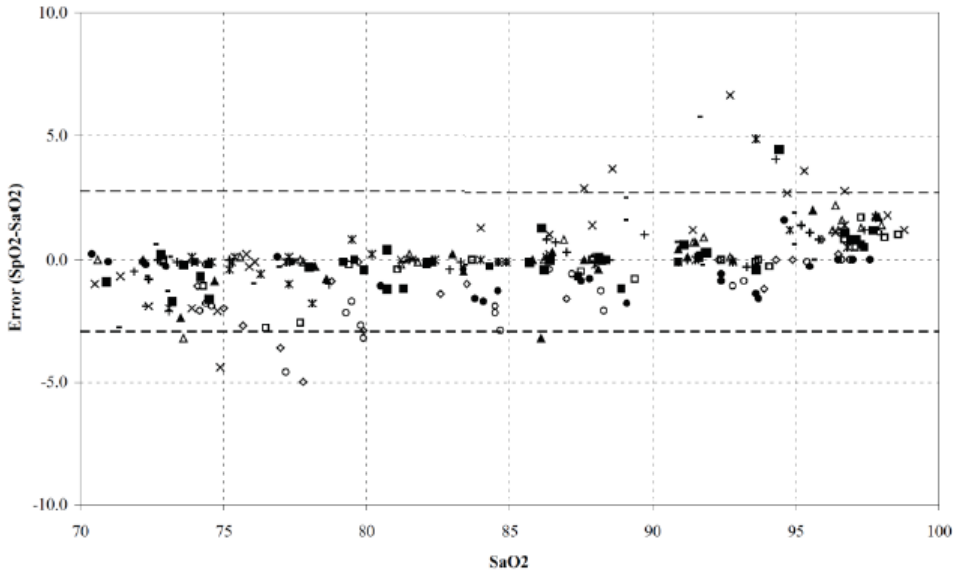

MEASURED A _{RMS} VALUES	
Range	A _{RMS}
90-100%	1.64%
80-90%	1.07%
70-80%	1.55%
Range	A _{RMS}
70-100%	± 2 %
Overall Claimed Accuracy Value	

Inf/Neo/NeoPt/4002/4003/4004/4005

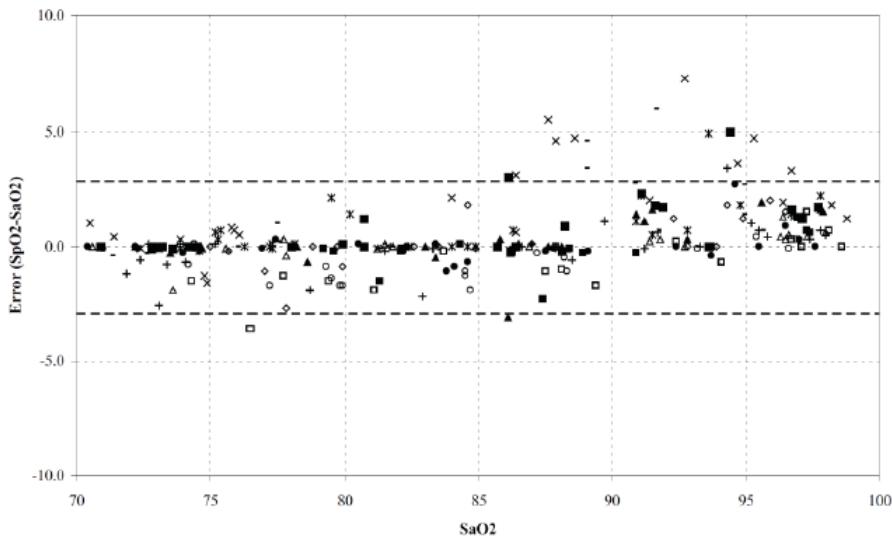

MEASURED A _{RMS} VALUES	
Range	A _{RMS}
90-100%	1.85%
80-90%	1.44%
70-80%	0.89%

Range	A _{RMS}		
	Inf	Neo*	Neo Pt*
70-100%	± 2 %	±2 % Adult ±3 % Neonatal	±3 %
Overall Claimed Accuracy Value			

*The saturation accuracy of the Neonate and Preterm sensors were validated on adult volunteers and 1% was added to account for the properties of fetal hemoglobin.

DCI/DCIP/4050/4051

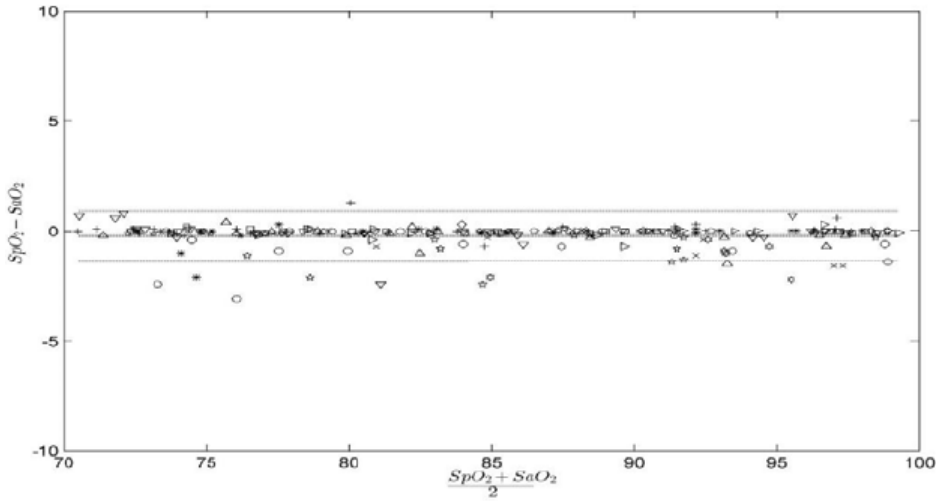

MEASURED A_{RMS} VALUES	
Range	A_{RMS}
90-100%	0.60%
80-90%	0.54%
70-80%	0.67%
Range	A_{RMS}
70-100%	2 %
Overall Claimed Accuracy Value	

LNCS YI

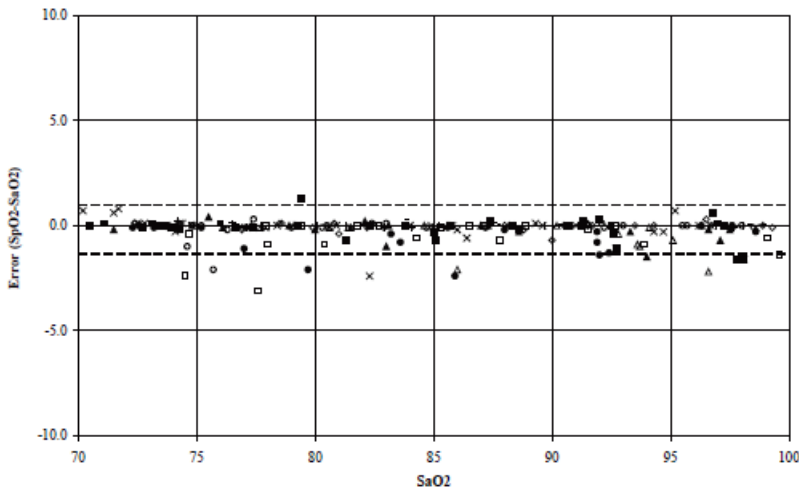

MEASURED A_{RMS} VALUES	
RANGE	A_{RMS}
90-100%	0.6%
80-90%	0.5%
70-80%	0.7%
OVERALL CLAIMED ACCURACY VALUE	
70-100%	$\pm 2\%$

4053

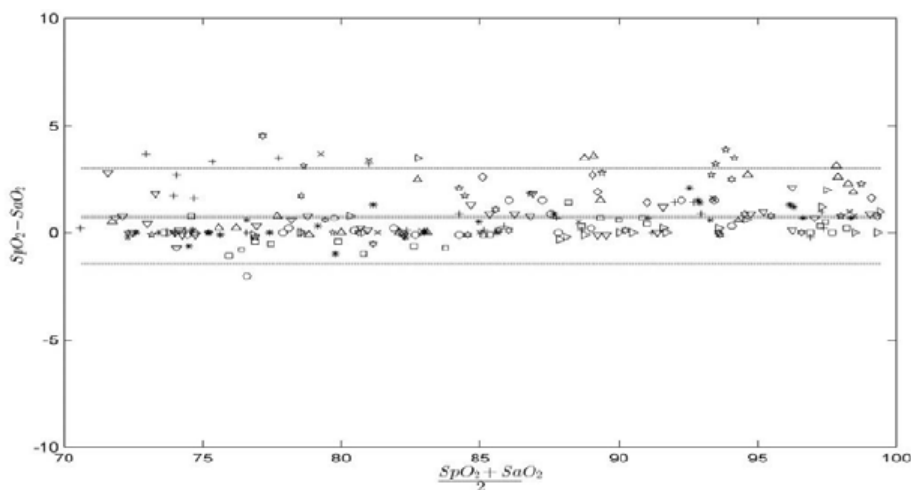

MEASURED A_{RMS} VALUES	
Range	A_{RMS}
90-100%	1.45%
80-90%	1.22%
70-80%	1.41%
Range	A_{RMS}
70-100%	2 %
Overall Claimed Accuracy Value	

F.3 The Accuracy of Nellcor SpO₂ Sensors

Sensor	Motion	# of Data Points	A _{RMS} (%)	SpO ₂ Acceptance Criteria 70% - 100% (%)	Pass/Fail
MAX-A, MAX-P	No	976	1.54	≤2.0	Pass
MAX-I, MAX-N	No	723	1.41	≤2.0	Pass
DS-100A	No	411	2.16	≤3.0	Pass
D-YS, OXI-P/I, OXI-A/N	No	458	1.96	≤3.5	Pass

Modified Bland-Altman for SpO₂ - MAX-A, MAX-P Sensors (No Motion): SaO₂ vs. (SpO₂ - SaO₂)

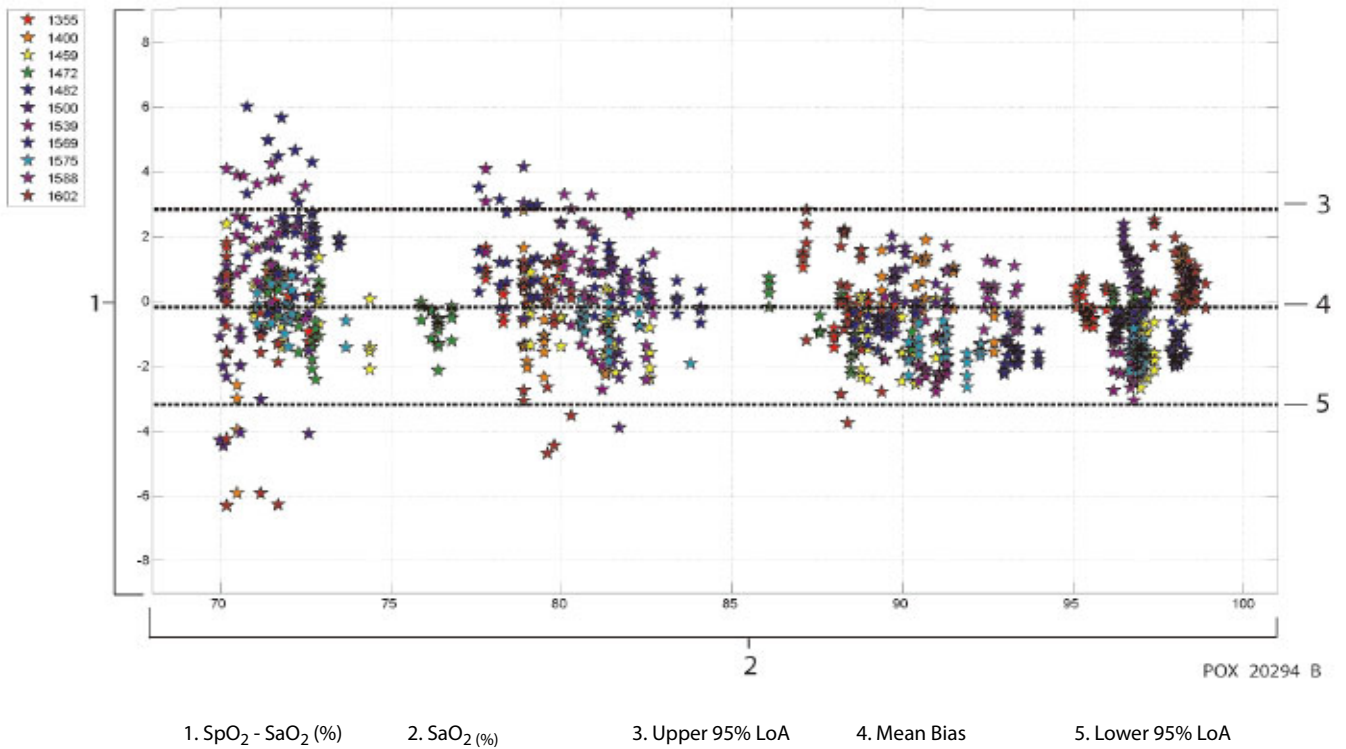

Modified Bland-Altman for SpO₂ - MAX-I, MAX-N Sensors (No Motion): SaO₂ vs. (SpO₂ - SaO₂)

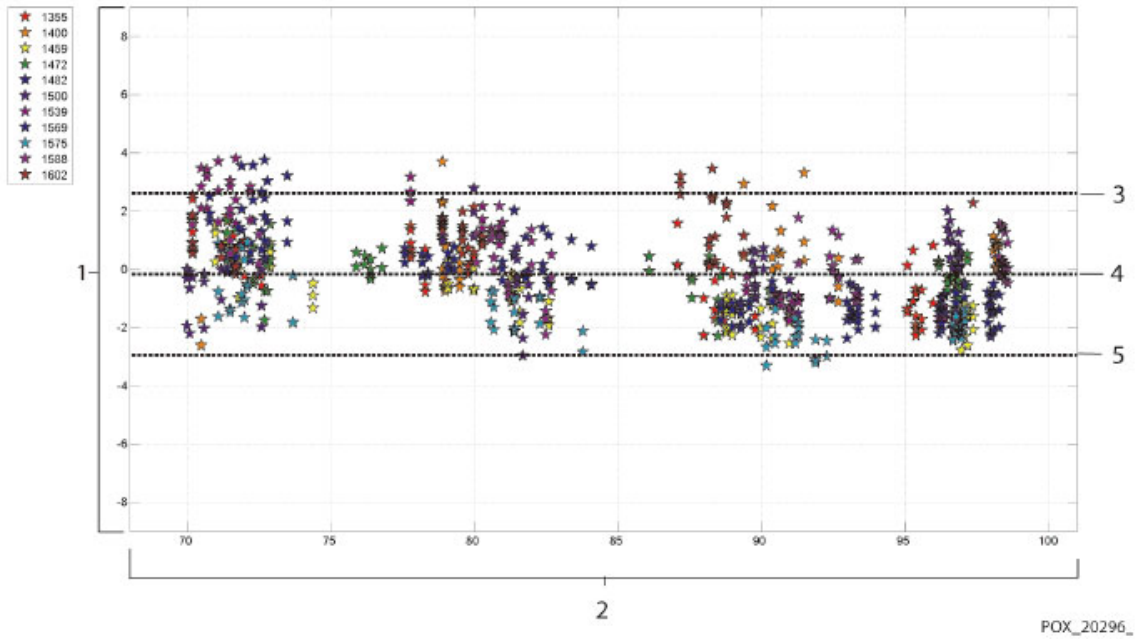

1. SpO₂ - SaO₂ (%) 2. SaO₂ (%) 3. Upper 95% LoA 4. Mean Bias 5. Lower 95% LoA

Modified Bland-Altman for SpO₂ - DS-100A Sensor (No Motion): SaO₂ vs. (SpO₂ - SaO₂)

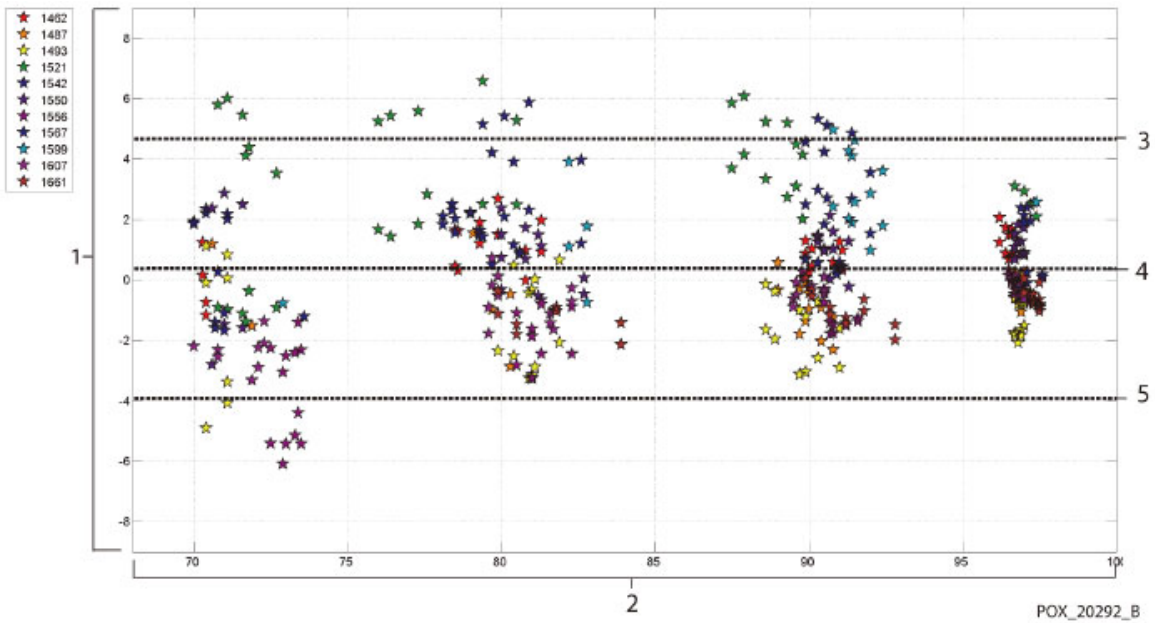

1. SpO₂ - SaO₂ (%) 2. SaO₂ (%) 3. Upper 95% LoA 4. Mean Bias 5. Lower 95% LoA

Modified Bland-Altman for SpO₂ - D-YS, OXI-A/N, OXI-P/I Sensors (No Motion): SaO₂ vs. (SpO₂ - SaO₂)

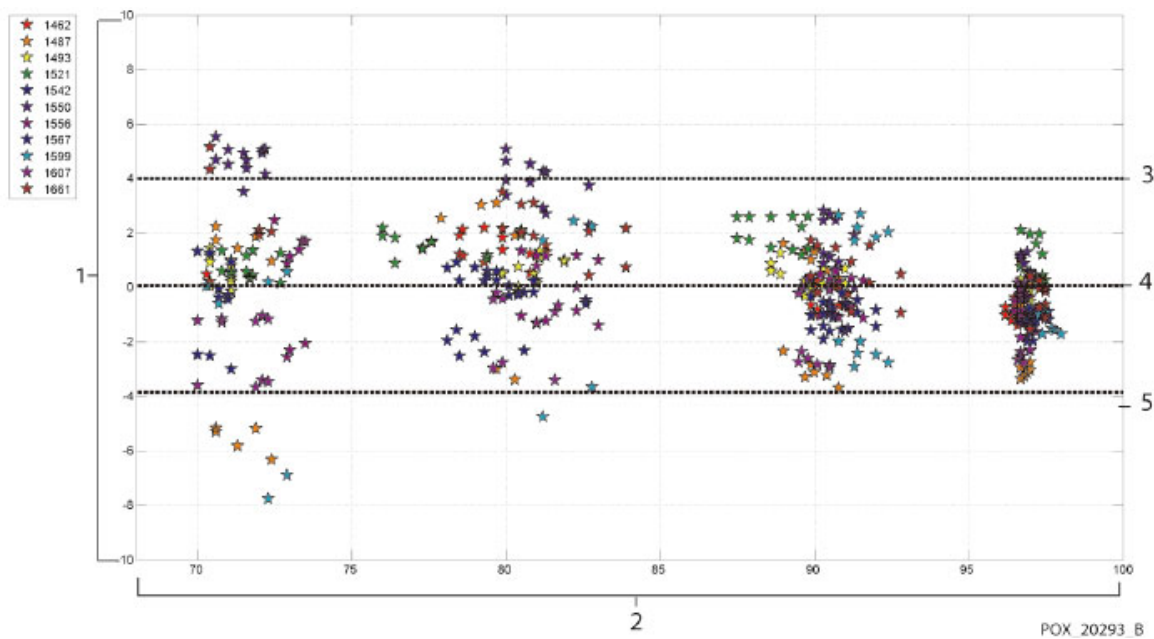

1. SpO₂ - SaO₂ (%)

2. SaO₂ (%)

3. Upper 95% LoA

4. Mean Bias

5. Lower 95% LoA

G Units, Symbols and Abbreviations

G.1 Units

Abbreviation	In Full
μA	microampere
μV	microvolt
μs	microsecond
A	ampere
Ah	ampere hour
bpm	beat per minute
bps	bit per second
°C	centigrade
cc	cubic centimeter
cm	centimeter
dB	decibel
DS	dyne second
°F	Fahrenheit
g	gram
GHz	gigahertz
GTT	gutta
h	hour
Hz	hertz
in	inch
k	kilo
kg	kilogram
kPa	kilopascal
L	litre
lb	pound
m	meter
mAh	milliampere hour
Mb	mega byte
mcg	microgram
mEq	milli-equivalents
mg	milligram
min	minute
ml	milliliter
mm	millimeter

Abbreviation	In Full
mmHg	millimeters of mercury
cmH ₂ O	centimeters of water
ms	millisecond
mV	millivolt
mW	milliwatt
MΩ	megaohm
nm	nanometer
rpm	breaths per minute
s	second
V	volt
VA	volt ampere
Ω	ohm
W	watt

G.2 Symbols

Symbol	Explanation
-	minus
-	negative
%	percent
/	per; divide; or
~	to
+	plus
=	equal to
<	less than
>	greater than
≤	less than or equal to
≥	greater than or equal to
±	plus or minus
×	multiply
©	copyright

G.3 Abbreviations

Abbreviation	In Full
AaDO ₂	alveolar-arterial oxygen gradient
AC	alternating current
Adu	adult
AG	anaesthesia gas
AHA	American Heart Association
Ao	aortic pressure
Art	arterial
ATMP	barometric pressure
AUC	area under the curve
aVF	left foot augmented lead
aVL	left arm augmented lead
aVR	right arm augmented lead
awRR	airway respiratory rate
BAP	brachial arterial pressure
BL	baseline
BT	blood temperature
BTPS	body temperature and pressure, saturated
CAA	Clinical Assistive Application
CaO ₂	arterial oxygen content
CCI	continuous cardiac index
CCO	continuous cardiac output
CCU	cardiac (coronary) care unit
CE	Conformité Européenne
CFI	cardiac function index
C.I.	cardiac index
CIS	clinical information system
CISPR	International Special Committee on Radio Interference
CMOS	complementary metal oxide semiconductor
CMS	central monitoring system
C.O.	cardiac output
CO ₂	carbon dioxide
COHb	carboxyhemoglobin
Compl	compliance
CPI	cardiac power index
CPO	cardiac power output
CVP	central venous pressure
DC	direct current

Abbreviation	In Full
Des	desflurane
Dia	diastolic
dpi	dot per inch
dPmx	left ventricular contractility
DVI	digital video interface
DO ₂	oxygen delivery
DO ₂ I	oxygen delivery index
ECG	electrocardiograph
EDV	end-diastolic volume
EE	Energy Expenditure
EEC	European Economic Community
EEG	electroencephalogram
EMC	electromagnetic compatibility
EMG	electromyograph
EMI	electromagnetic interference
Enf	enflurane
ESU	electrosurgical unit
Et	end-tidal
EtAA	end-tidal anesthetic agent
EtDes	end-tidal anesthetic agent
EtEnf	
EtHal	
EtIso	
EtSev	
EtCO ₂	
EtN ₂ O	end-tidal nitrous oxide
EtO	ethylene oxide
EtO ₂	end-tidal oxygen
EVLW	extravascular lung water
ELWI	extravascular lung water index
EWS	Early Warning Score
FAP	femoral arterial pressure
FCC	Federal Communication Commission
FDA	Food and Drug Administration
FeCO ₂	Mixed Expired CO ₂ Concentration
Fi	fraction of inspired
FiAA	inspired anesthetic agent

Abbreviation	In Full
FiDes	inspired anesthetic agent
FiEnf	
FiHal	
Filso	
FiSev	
FiCO ₂	fraction of inspired carbon oxygen
FiN ₂ O	fraction of inspired nitrous oxide
FiO ₂	fraction of inspired oxygen
FPGA	field programmable gate array
FV	flow-volume
GCS	Glasgow Coma Scale
GEDV	global end diastolic volume
GEDI	global end diastolic volume index
GEF	global ejection fraction
Hal	halothane
Hb	hemoglobin
Hct	haematocrit
HIS	hospital information system
HR	heart rate
IBP	invasive blood pressure
IBW	ideal body weight
ICG	impedance cardiography
ICP	intracranial pressure
ICT/B	intracranial catheter tip pressure transducer
ICU	intensive care unit
ID	identification
I:E	inspiratory time: expiratory time ratio
IEC	International Electrotechnical Commission
IEEE	Institute of Electrical and Electronic Engineers
IP	internet protocol
Iso	isoflurane
ITBI	intrathoracic blood volume index
ITBV	intrathoracic blood volume
LA	left arm
LAP	left atrial pressure
LCD	liquid crystal display
LCW	left cardiac work
LCWI	left cardiac work index
LED	light emitting diode

Abbreviation	In Full
LL	left leg
LVET	left ventricular ejection time
LVSW	left ventricular stroke work
LVSWI	left ventricular stroke work index
MAC	minimum alveolar concentration
MAP	mean arterial pressure
MetHb	methemoglobin
MEWS	Modified Early Warning Score
MRI	magnetic resonance imaging
MV	minute volume
MValv	Alveolar Minute Volume
MVCO ₂	CO ₂ minute production
MVe	expiratory minute volume
MVi	inspiratory minute volume
MVO ₂	O ₂ minute consumption
N/A	not applied
N ₂	nitrogen
N ₂ O	nitrous oxide
Neo	neonate
NEWS	National Early Warning Score
NIBP	noninvasive blood pressure
NIF	negative inspiratory force
O ₂	oxygen
O ₂ %	oxygen concentration
OR	operating room
oxyCRG	oxygen cardio-respirogram
PA	pulmonary artery
pArt	artery pressure
pArt-D	diastolic artery pressure
pArt-M	mean artery pressure
pArt-S	systolic artery pressure
Paw	airway pressure
PAWP	pulmonary artery wedge pressure
pCVP	central venous pressure
Ped	pediatric
PEEP	positive end expiratory pressure
PEF	peak expiratory flow
PEP	pre-ejection period
PIF	peak inspiratory flow

Abbreviation	In Full
PIP	peak inspiratory pressure
Pleth	plethysmogram
Pmean	mean pressure
PO ₂	oxygen supply pressure
Pplat	plateau pressure
PPV	pulse pressure variation
PR	pulse rate
PVC	premature ventricular contraction
PVPI	pulmonary vascular permeability index
PVR	pulmonary vascular resistance
PVRI	pulmonary vascular resistance index
qSOFA	quick Sepsis-Related Organ Failure Assessment
RA	right arm
RAP	right atrial pressure
Raw	airway resistance
Rec	record, recording
Resp	respiration
RL	right leg
RM	respiratory mechanics
RQ	respiratory quotient
RR	respiration rate
RSBI	rapid shallow breathing index
SaO ₂	arterial oxygen saturation
ScvO ₂	central venous oxygen saturation
SEF	spectral edge frequency
Sev	sevoflurane
SI	stroke index
SlopeCO ₂	Slope of the alveolar plateau
SMR	satellite module rack
SOFA	Sepsis-Related Organ Failure Assessment
SpO ₂	arterial oxygen saturation from pulse oximetry
SQI	signal quality index
SR	suppression ratio
SSC	Surviving Sepsis Campaign
SSI	signal strength index
STR	systolic time ratio
SV	stroke volume
SVI	stroke volume index
SVR	systemic vascular resistance

Abbreviation	In Full
SVRI	systemic vascular resistance index
SVV	stroke volume variation
SvO ₂	venous oxygen saturation
Sync	synchronization
Sys	systolic pressure
TB	Blood Temperature
TD	temperature difference
Temp	temperature
TFT	thin-film technology
TI	injectate temperature
TRC	tube resistance compensation
UAP	umbilical arterial pressure
UPS	uninterruptible power supply
USB	universal serial bus
UVP	umbilical venous pressure
VAC	volts alternating current
VEPT	volume of electrically participating tissue
VI	velocity index
VO ₂	O ₂ consumption for one breath
VO ₂ I	oxygen consumption index

Caution:

This device complies with Part 15 of the FCC rules and Industry Canada license-exempt RSS standard(s). Operation is subject to the following two conditions: (1) this device may not cause harmful interference, and (2) this device must accept any interference received, including interference that may cause undesired operation.

The manufacturer is not responsible for any radio or TV interference caused by unauthorized modifications or change to this equipment. Such modifications or change could void the user's authority to operate the equipment.

This radio transmitter (identify the device by certification number or model number if Category II) has been approved by Industry Canada to operate with the antenna types listed below with the maximum permissible gain indicated. Antenna types not included in this list, having a gain greater than the maximum gain indicated for that type, are strictly prohibited for use with this device.

This equipment has been tested and found to comply with the limits for a Class B digital device, pursuant to part 15 of the FCC Rules. These limits are designed to provide reasonable protection against harmful interference in a residential installation. This equipment generates, uses and can radiate radio frequency energy and, if not installed and used in accordance with the instructions, may cause harmful interference to radio communications. However, there is no guarantee that interference will not occur in a particular installation. If this equipment does cause harmful interference to radio or television reception, which can be determined by turning the equipment off and on, the user is encouraged to try to correct the interference by one or more of the following measures:

- Reorient or relocate the receiving antenna.
- Increase the separation between the equipment and receiver.
- Connect the equipment into an outlet on a circuit different from that to which the receiver is connected.
- Consult the dealer or an experienced radio/TV technician for help.

The device has been evaluated to meet general RF exposure requirement.

To maintain compliance with FCC's RF exposure guidelines, this equipment should be installed and operated with a minimum distance of 20cm between the radiator and your body.