

CETECOM ICT Services is now

**CTC** | **advanced**  
member of RWTÜV group

## TEST REPORT

Test report no.: 1-2970/16-01-09



### Testing laboratory

**CTC advanced GmbH**

Untertuerkheimer Strasse 6 – 10  
66117 Saarbruecken / Germany  
Phone: + 49 681 5 98 - 0  
Fax: + 49 681 5 98 - 9075  
Internet: <http://www.ctcadvanced.com>  
e-mail: [mail@ctcadvanced.com](mailto:mail@ctcadvanced.com)

**Accredited Testing Laboratory:**

The testing laboratory (area of testing) is accredited according to DIN EN ISO/IEC 17025 (2005) by the Deutsche Akkreditierungsstelle GmbH (DAkkS). The accreditation is valid for the scope of testing procedures as stated in the accreditation certificate with the registration number: D-PL-12076-01-01

### Applicant

**FLIR Systems AB**

Antennvägen 6  
187 66 Täby / SWEDEN  
Phone: +46 87 53 25 00  
Fax: +46 87 53 23 64  
Contact: Göran Skedung  
e-mail: [goran.skedung@flir.se](mailto:goran.skedung@flir.se)  
Phone: +46 87 53 27 59

### Manufacturer

**FLIR Systems AB**

Antennvägen 6  
187 66 Täby / SWEDEN

### Test standard/s

47 CFR Part 15	Title 47 of the Code of Federal Regulations; Chapter I; Part 15 - Radio frequency devices
RSS - 247 Issue 2	Digital Transmission Systems (DTSs), Frequency Hopping Systems (FHSs) and Licence - Exempt Local Area Network (LE-LAN) Devices
RSS - Gen Issue 4	Spectrum Management and Telecommunications Radio Standards Specifications - General Requirements and Information for the Certification of Radio Apparatus

For further applied test standards please refer to section 3 of this test report.

### Test Item

<b>Kind of test item:</b>	<b>Thermal imaging camera</b>
<b>Model name:</b>	<b>FLIR-T8210</b>
<b>FCC ID:</b>	<b>ZLV-FLIRT8210</b>
<b>IC:</b>	<b>5306A-FLIRT8210</b>
<b>Frequency:</b>	DTS band 2400 MHz to 2483.5 MHz
<b>Technology tested:</b>	Bluetooth® LE
<b>Antenna:</b>	Integrated PIFA antenna
<b>Power supply:</b>	3.65 V DC by LiOn battery
<b>Temperature range:</b>	-20°C to +55°C



This test report is electronically signed and valid without handwriting signature. For verification of the electronic signatures, the public keys can be requested at the testing laboratory.

### Test report authorized:

Stefan Bös  
Lab Manager  
Radio Communications & EMC

### Test performed:

Mihail Dorongovskij  
Lab Manager  
Radio Communications & EMC

## 1 Table of contents

1	Table of contents.....	2
2	General information .....	3
2.1	Notes and disclaimer .....	3
2.2	Application details .....	3
2.3	Test laboratories sub-contracted .....	3
3	Test standard/s and references.....	4
4	Test environment .....	5
5	Test item .....	5
5.1	General description.....	5
5.2	Additional information .....	5
6	Description of the test setup .....	6
6.1	Shielded semi anechoic chamber .....	7
6.2	Shielded fully anechoic chamber .....	8
6.3	Radiated measurements > 18 GHz .....	9
6.4	Conducted measurements C.BER system .....	10
6.5	AC conducted .....	11
7	Sequence of testing .....	12
7.1	Sequence of testing radiated spurious 9 kHz to 30 MHz .....	12
7.2	Sequence of testing radiated spurious 30 MHz to 1 GHz .....	13
7.3	Sequence of testing radiated spurious 1 GHz to 18 GHz.....	14
7.4	Sequence of testing radiated spurious above 18 GHz .....	15
8	Measurement uncertainty.....	16
9	Summary of measurement results .....	17
10	Additional comments.....	18
11	Measurement results .....	19
11.1	System gain.....	19
11.2	Power spectral density .....	25
11.3	DTS bandwidth – 6 dB bandwidth.....	28
11.4	Occupied bandwidth – 99% emission bandwidth .....	31
11.5	Maximum output power .....	34
11.6	Detailed spurious emissions @ the band edge - conducted .....	37
11.7	Band edge compliance radiated .....	39
11.8	TX spurious emissions conducted .....	41
11.9	Spurious emissions radiated below 30 MHz .....	45
11.10	Spurious emissions radiated 30 MHz to 1 GHz .....	48
11.11	Spurious emissions radiated above 1 GHz .....	53
11.12	Spurious emissions conducted below 30 MHz (AC conducted).....	60
12	Observations .....	63
Annex A	Document history .....	63
Annex B	Further information.....	63
Annex C	Accreditation Certificate .....	64

## 2 General information

### 2.1 Notes and disclaimer

The test results of this test report relate exclusively to the test item specified in this test report. CTC advanced GmbH does not assume responsibility for any conclusions and generalizations drawn from the test results with regard to other specimens or samples of the type of the equipment represented by the test item.

The test report may only be reproduced or published in full. Reproduction or publication of extracts from the report requires the prior written approval of CTC advanced GmbH.

The testing service provided by CTC advanced GmbH has been rendered under the current "General Terms and Conditions for CTC advanced GmbH".

CTC advanced GmbH will not be liable for any loss or damage resulting from false, inaccurate, inappropriate or incomplete product information provided by the customer.

Under no circumstances does the CTC advanced GmbH test report include any endorsement or warranty regarding the functionality, quality or performance of any other product or service provided.

Under no circumstances does the CTC advanced GmbH test report include or imply any product or service warranties from CTC advanced GmbH, including, without limitation, any implied warranties of merchantability, fitness for purpose, or non-infringement, all of which are expressly disclaimed by CTC advanced GmbH.

All rights and remedies regarding vendor's products and services for which CTC advanced GmbH has prepared this test report shall be provided by the party offering such products or services and not by CTC advanced GmbH. In no case this test report can be considered as a Letter of Approval.

This test report is electronically signed and valid without handwritten signature. For verification of the electronic signatures, the public keys can be requested at the testing laboratory.

### 2.2 Application details

Date of receipt of order:	2017-01-20
Date of receipt of test item:	2017-03-13
Start of test:	2017-03-13
End of test:	2017-03-17
Person(s) present during the test:	Mr. Göran Skedung

### 2.3 Test laboratories sub-contracted

None

### 3 Test standard/s and references

Test standard	Date	Description
47 CFR Part 15	-/-	Title 47 of the Code of Federal Regulations; Chapter I; Part 15 - Radio frequency devices
RSS - 247 Issue 2	February 2017	Digital Transmission Systems (DTSs), Frequency Hopping Systems (FHSs) and Licence - Exempt Local Area Network (LE-LAN) Devices
RSS - Gen Issue 4	November 2014	Spectrum Management and Telecommunications Radio Standards Specifications - General Requirements and Information for the Certification of Radio Apparatus

Guidance	Version	Description
DTS: KDB 558074 D01	v03r05	Guidance for Performing Compliance Measurements on Digital Transmission Systems (DTS) Operating Under §15.247
ANSI C63.4-2014	-/-	American national standard for methods of measurement of radio-noise emissions from low-voltage electrical and electronic equipment in the range of 9 kHz to 40 GHz
ANSI C63.10-2013	-/-	American national standard of procedures for compliance testing of unlicensed wireless devices

#### 4 Test environment

Temperature	:	T <sub>nom</sub> T <sub>max</sub> T <sub>min</sub>	+23 °C during room temperature tests No tests under extreme temperature conditions required! No tests under extreme temperature conditions required!
Relative humidity content	:		55 %
Barometric pressure	:		1021 hpa
Power supply	:	V <sub>nom</sub> V <sub>max</sub> V <sub>min</sub>	3.65 V DC by LiOn battery No tests under extreme voltage conditions required! No tests under extreme voltage conditions required!

#### 5 Test item

##### 5.1 General description

Kind of test item	:	Thermal imaging camera	
Type identification	:	FLIR-T8210	
HMN	:	-/-	
PMN	:	T530, T540, T850 and T860	
HVIN	:	FLIR-T8210	
FVIN	:	-/-	
S/N serial number	:	Radiated unit:	79100425
		Conducted unit:	79100421
HW hardware status	:	1	
SW software status	:	RF test mode	
Frequency band	:	DTS band 2400 MHz to 2483.5 MHz (lowest channel 2402 MHz; highest channel 2480 MHz)	
Type of radio transmission	:	DSSS	
Use of frequency spectrum	:		
Type of modulation	:	GFSK	
Number of channels	:	40	
Antenna	:	Integrated PIFA antenna	
Power supply	:	3.65 V DC by LiOn battery	
Temperature range	:	-20°C to +55°C	

##### 5.2 Additional information

The content of the following annexes is defined in the QA. It may be that not all of the listed annexes are necessary for this report, thus some values in between may be missing.

Test setup- and EUT-photos are included in test report:

- 1-2970/16-01-10\_AnnexA
- 1-2970/16-01-10\_AnnexB
- 1-2970/16-01-10\_AnnexD

## 6 Description of the test setup

Typically, the calibrations of the test apparatus are commissioned to and performed by an accredited calibration laboratory. The calibration intervals are determined in accordance with the DIN EN ISO/IEC 17025. In addition to the external calibrations, the laboratory executes comparison measurements with other calibrated test systems or effective verifications. Weekly chamber inspections and range calibrations are performed. Where possible, RF generating and signaling equipment as well as measuring receivers and analyzers are connected to an external high-precision 10 MHz reference (GPS-based or rubidium frequency standard).

In order to simplify the identification of the equipment used at some special tests, some items of test equipment and ancillaries can be provided with an identifier or number in the equipment list below (Lab/Item).

### Agenda: Kind of Calibration

k	calibration / calibrated	EK	limited calibration
ne	not required (k, ev, izw, zw not required)	zw	cyclical maintenance (external cyclical maintenance)
ev	periodic self verification	izw	internal cyclical maintenance
Ve	long-term stability recognized	g	blocked for accredited testing
vkl!	Attention: extended calibration interval		
NK!	Attention: not calibrated	*)	next calibration ordered / currently in progress

## 6.1 Shielded semi anechoic chamber

The radiated measurements are performed in vertical and horizontal plane in the frequency range from 9 kHz to 1 GHz in semi-anechoic chambers. The EUT is positioned on a non-conductive support with a height of 0.80 m above a conductive ground plane that covers the whole chamber. The receiving antennas are confirmed with specifications ANSI C63. These antennas can be moved over the height range between 1.0 m and 4.0 m in order to search for maximum field strength emitted from EUT. The measurement distances between EUT and receiving antennas are indicated in the test setups for the various frequency ranges. For each measurement, the EUT is rotated in all three axes until the maximum field strength is received. The wanted and unwanted emissions are received by spectrum analyzers where the detector modes and resolution bandwidths over various frequency ranges are set according to requirement ANSI C63.

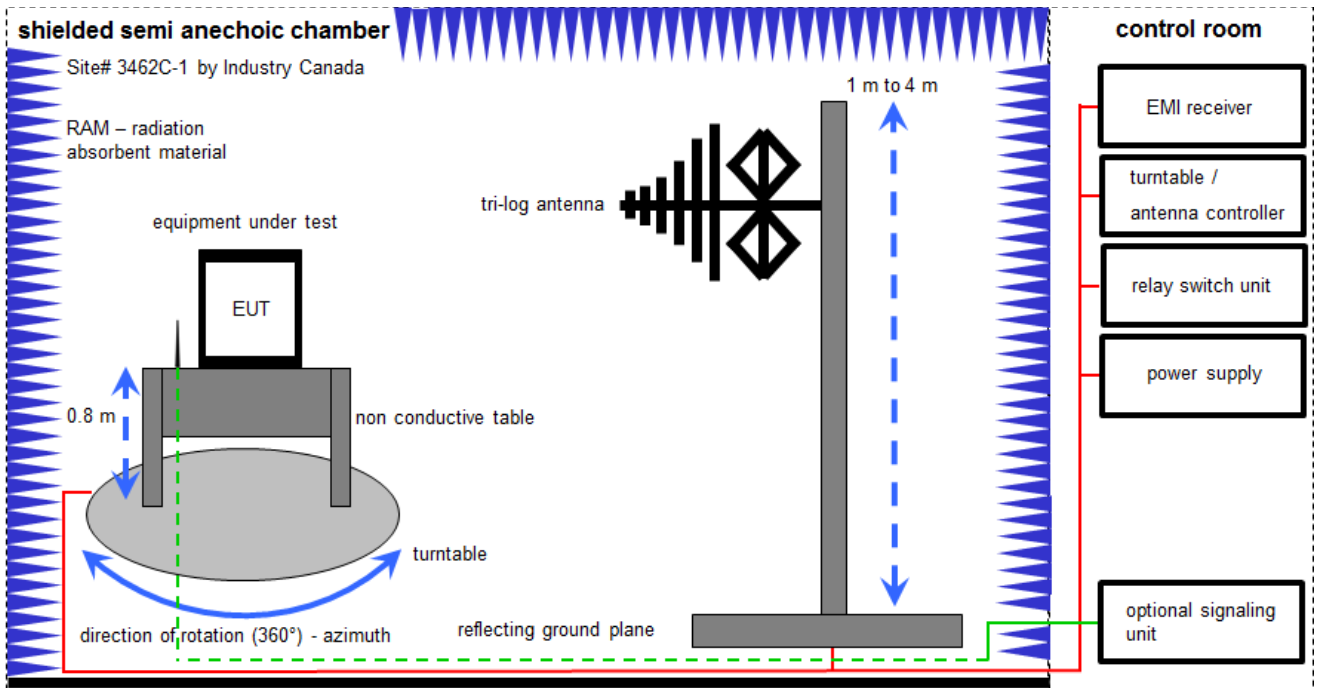

Measurement distance: tri-log antenna 10 meter

$$FS = UR + CL + AF$$

(FS-field strength; UR-voltage at the receiver; CL-loss of the cable; AF-antenna factor)

Example calculation:

$$FS [dB\mu V/m] = 12.35 [dB\mu V/m] + 1.90 [dB] + 16.80 [dB/m] = 31.05 [dB\mu V/m] (35.69 \mu V/m)$$

### Equipment table:

No.	Lab / Item	Equipment	Type	Manufacturer	Serial No.	INV. No.	Kind of Calibration	Last Calibration	Next Calibration
1	A	Switch-Unit	3488A	HP	2719A14505	300000368	ev	-/-	-/-
2	A	EMI Test Receiver	ESCI 3	R&S	100083	300003312	k	01.02.2017	31.01.2018
3	A	Antenna Tower	Model 2175	ETS-Lindgren	64762	300003745	izw	-/-	-/-
4	A	Positioning Controller	Model 2090	ETS-Lindgren	64672	300003746	izw	-/-	-/-
5	A	Analy zer-Reference-System (Harmonics and Flicker)	ARS 16/1	SPS	A3509 07/0 0205	300003314	Ve	02.02.2018	02.02.2020
6	A	Turntable Interface-Box	Model 105637	ETS-Lindgren	44583	300003747	izw	-/-	-/-
7	A	TRILOG Broadband Test-Antenna 30 MHz - 3 GHz	VULB9163	Schwarzbeck	295	300003787	k	25.04.2016	25.04.2018

## 6.2 Shielded fully anechoic chamber

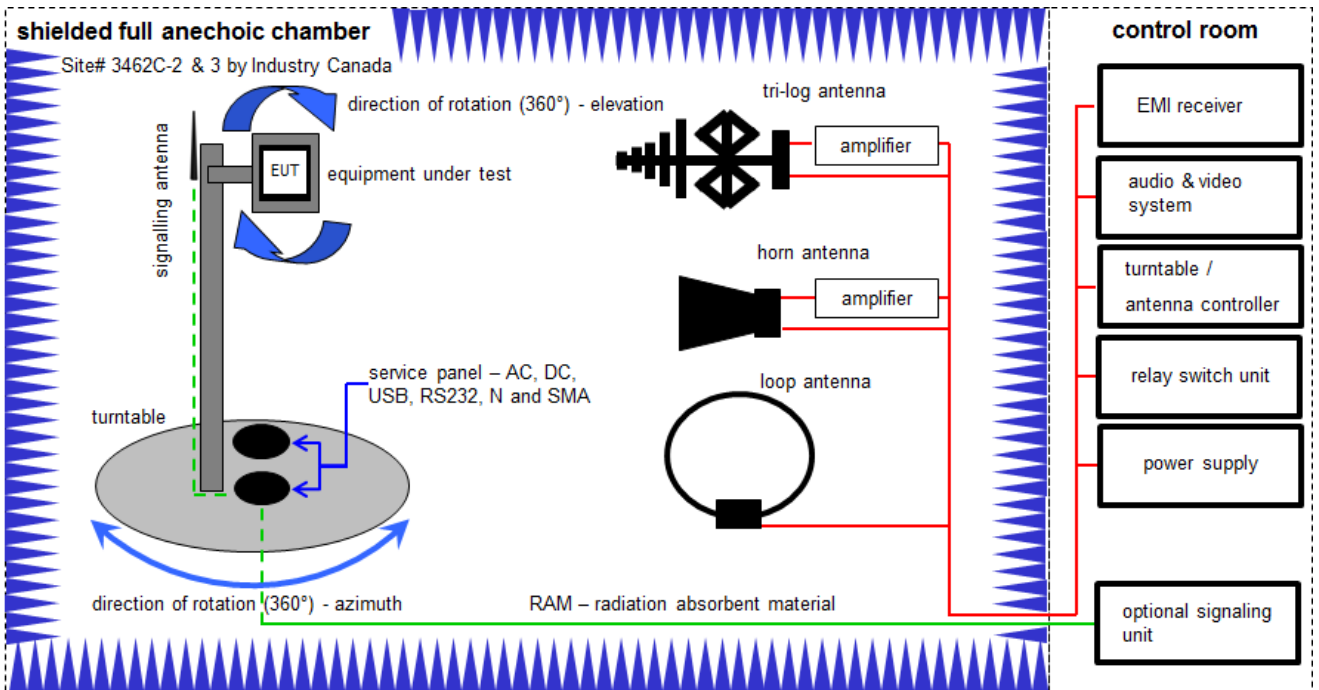

Measurement distance: tri-log antenna and horn antenna 3 meter; loop antenna 3 meter

$$FS = UR + CA + AF$$

(FS-field strength; UR-voltage at the receiver; CA-loss of the signal path; AF-antenna factor)

Example calculation:

$$FS [dB\mu V/m] = 40.0 [dB\mu V/m] + (-35.8) [dB] + 32.9 [dB/m] = 37.1 [dB\mu V/m] (71.61 \mu V/m)$$

### Equipment table:

No.	Lab / Item	Equipment	Type	Manufacturer	Serial No.	INV. No.	Kind of Calibration	Last Calibration	Next Calibration
1	A, B	Double-Ridged Wav eguide Horn Antenna 1-18.0GHz	3115	EMCO	8812-3088	300001032	v IKI!	20.05.2015	20.05.2017
2	A, B, C	Anechoic chamber	FAC 3/5m	MWB / TDK	87400/02	300000996	ev	-/-	-/-
	A, B, C	Switch / Control Unit	3488A	HP		300000199	ne	-/-	-/-
3	C	Active Loop Antenna 10 kHz to 30 MHz	6502	EMCO/2	8905-2342	300000256	k	24.06.2015	24.06.2017
4	B	Band Reject filter	WRCG2400/2483-2375/2505-50/10SS	Wainwright	11	300003351	ev	-/-	-/-
5	A, B, C	EMI Test Receiver 20Hz- 26,5GHz	ESU26	R&S	100037	300003555	k	31.01.2017	30.01.2018
6	B	Highpass Filter	WHKX7.0/18G-8SS	Wainwright	18	300003789	ne	-/-	-/-
7	A, B	Broadband Amplifier 0.5-18 GHz	CBLU5184540	CERNEX	22049	300004481	ev	-/-	-/-
8	A, B, C	4U RF Switch Platform	L4491A	Agilent Technologies	MY50000037	300004509	ne	-/-	-/-



**6.3 Radiated measurements > 18 GHz**

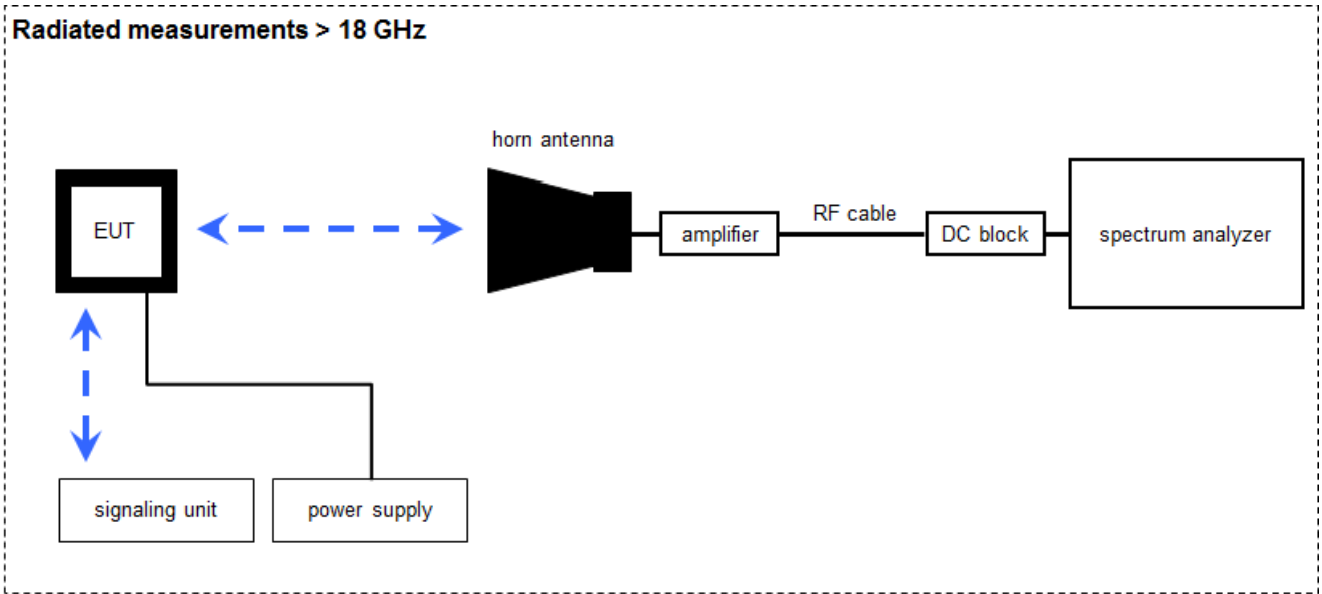

Measurement distance: horn antenna 50 cm

$$FS = U_R + CA + AF$$

(FS-field strength;  $U_R$ -voltage at the receiver; CA-loss signal path & distance correction; AF-antenna factor)

Example calculation:

$$FS [dB\mu V/m] = 40.0 [dB\mu V/m] + (-60.1) [dB] + 36.74 [dB/m] = 16.64 [dB\mu V/m] (6.79 \mu V/m)$$

**Equipment table:**

No.	Lab / Item	Equipment	Type	Manufacturer	Serial No.	INV. No.	Kind of Calibration	Last Calibration	Next Calibration
1	A	Std. Gain Horn Antenna 18.0 to 26.5 GHz	638	Narda	-/-	300000486	k	10.09.2015	10.09.2017
2	A	Signal Analyzer 40 GHz	FSV40	R&S	101042	300004517	k	25.01.2017	24.01.2018
3	A	Amplifier 2-40 GHz	JS32-02004000-57-5P	MITEQ	1777200	300004541	ev	-/-	-/-
4	A	RF-Cable	ST118/SMAM/SMAM/48	Huber & Suhner	Batch no. 600918	400001182	ev	-/-	-/-
5	A	RF-Cable	ST118/SMAM/SMm/48	Huber & Suhner	Batch no. 127377	400001183	ev	-/-	-/-
6	A	DC-Blocker 0.1-40 GHz	8141A	Inmet	Batch no. 127377	400001185	ev	-/-	-/-

**6.4 Conducted measurements C.BER system**

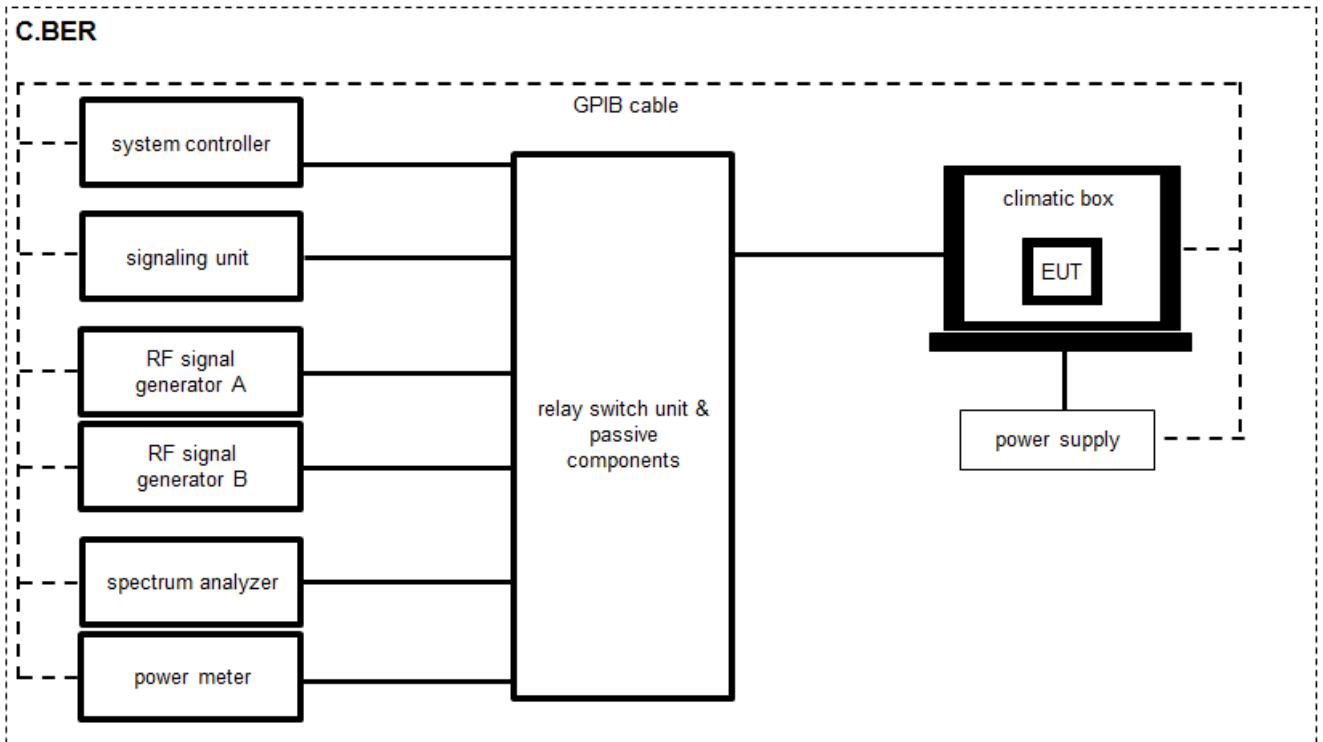

OP = AV + CA  
 (OP-output power; AV-analyzer value; CA-loss signal path)

Example calculation:

OP [dBm] = 6.0 [dBm] + 11.7 [dB] = 17.7 [dBm] (58.88 mW)

**Equipment table:**

No.	Lab / Item	Equipment	Type	Manufacturer	Serial No.	INV. No.	Kind of Calibration	Last Calibration	Next Calibration
1	A	Switch / Control Unit	3488A	HP		300000929	ne	-/-	-/-
2	A	USB/GPIB interface	82357B	Agilent Technologies	MY52103346	300004390	ne	-/-	-/-
3	A	Signal Analyzer 30GHz	FSV30	R&S	103170	300004855	k	30.012017	29.01.2019
4	A	USB-GPIB-Interface	82357B	Agilent Technologies	103170	300004852	ne	-/-	-/-
5	A	Power Sensor	NRP-Z81	R&S	100010	300003780	k	27.01.2017	26.01.2019
6	A	Directional Coupler	101020010	Krytar	70215	300002840	ev	-/-	-/-
7	A	DC-Blocker	8143	Inmet Corp.	none	300002842	ne	-/-	-/-
8	A	Powersplitter	6005-3	Inmet Corp.	none	300002841	ev	-/-	-/-
9	A	Messplatzrechner	Tecline	F+W	none	300003580	ne	-/-	-/-
10	A	RF-Cable	ST18/SMAm/SMAm/72	Huber & Suhner	Batch no. 605505	400001187	ev	-/-	-/-
11	A	RF-Cable	Sucoflex 104	Huber & Suhner	147636/4	400001188	ev	-/-	-/-

## 6.5 AC conducted

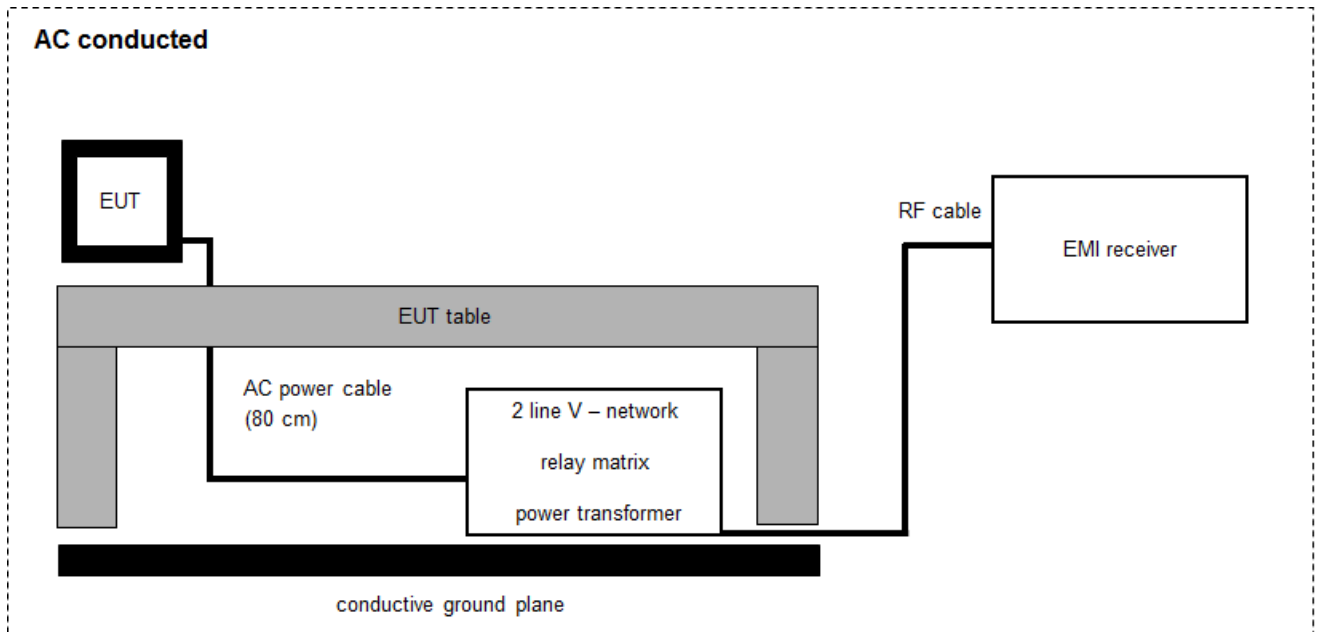

$$FS = UR + CF + VC$$

(FS-field strength; UR-voltage at the receiver; CR-loss of the cable and filter; VC-correction factor of the ISN)

Example calculation:

$$FS [dB\mu V/m] = 37.62 [dB\mu V/m] + 9.90 [dB] + 0.23 [dB] = 47.75 [dB\mu V/m] (244.06 \mu V/m)$$

Equipment table:

No.	Lab / Item	Equipment	Type	Manufacturer	Serial No.	INV. No.	Kind of Calibration	Last Calibration	Next Calibration
1	A	Two-line V-Network (LISN) 9 kHz to 30 MHz	ESH3-Z5	R&S	893045/004	300000584	k	31.01.2017	30.01.2018
2	A	RF-Filter-section	85420E	HP	3427A00162	300002214	ne	-/-	-/-
3	A	Analyzer-Reference-System (Harmonics and Flicker)	ARS 16/1	SPS	A3509 07/0 0205	300003314	Ve	02.02.2018	02.02.2020
4	A	Power Supply	NGSM 32/10	R&S	3939	400000192	ne	-/-	-/-
5	A	MXE EMI Receiver 20 Hz to 26,5 GHz	N9038A	Agilent Technologies	MY51210197	300004405	k	16.08.2016	16.08.2017
6	A	AC-Spannungsquelle variabel	MV2616-V	EM-Test	0397-12	300003259	k	11.12.2015	11.12.2017

## 7 Sequence of testing

### 7.1 Sequence of testing radiated spurious 9 kHz to 30 MHz

#### Setup

- The equipment is set up to simulate normal operation mode as described in the user manual or defined by the manufacturer.
- If the EUT is a tabletop system, a 2-axis positioner with 1.5 m height is used.
- If the EUT is a floor standing device, it is placed directly on the turn table.
- Auxiliary equipment and cables are positioned to simulate normal operation conditions as described in ANSI C 63.4.
- The AC power port of the EUT (if available) is connected to a power outlet below the turntable.
- Measurement distance is 3 m (see ANSI C 63.4) – see test details.
- EUT is set into operation.

#### Premeasurement

- The turntable rotates from 0° to 315° using 45° steps.
- The antenna height is 1.5 m.
- At each turntable position the analyzer sweeps with positive-peak detector to find the maximum of all emissions.

#### Final measurement

- Identified emissions during the premeasurement are maximized by the software by rotating the turntable from 0° to 360°. In case of the 2-axis positioner is used the elevation axis is also rotated from 0° to 360°.
- The final measurement is done in the position (turntable and elevation) causing the highest emissions with quasi-peak (as described in ANSI C 63.4).
- Final levels, frequency, measuring time, bandwidth, turntable position, correction factor, margin to the limit and limit will be recorded. A plot with the graph of the premeasurement and the limit is stored.

## 7.2 Sequence of testing radiated spurious 30 MHz to 1 GHz

### Setup

- The equipment is set up to simulate normal operation mode as described in the user manual or defined by the manufacturer.
- If the EUT is a tabletop system, a table with 0.8 m height is used, which is placed on the ground plane.
- If the EUT is a floor standing device, it is placed on the ground plane with insulation between both.
- Auxiliary equipment and cables are positioned to simulate normal operation conditions as described in ANSI C 63.4.
- The AC power port of the EUT (if available) is connected to a power outlet below the turntable.
- Measurement distance is 10 m or 3 m (see ANSI C 63.4) – see test details.
- EUT is set into operation.

### Premeasurement

- The turntable rotates from 0° to 315° using 45° steps.
- The antenna is polarized vertical and horizontal.
- The antenna height changes from 1 m to 3 m.
- At each turntable position, antenna polarization and height the analyzer sweeps three times in peak to find the maximum of all emissions.

### Final measurement

- The final measurement is performed for at least six highest peaks according to the requirements of the ANSI C63.4.
- Based on antenna and turntable positions at which the peak values are measured the software maximize the peaks by changing turntable position  $\pm 45^\circ$  and antenna height between 1 and 4 m.
- The final measurement is done with quasi-peak detector (as described in ANSI C 63.4).
- Final levels, frequency, measuring time, bandwidth, antenna height, antenna polarization, turntable angle, correction factor, margin to the limit and limit are recorded. A plot with the graph of the premeasurement with marked maximum final results and the limit is stored.

### 7.3 Sequence of testing radiated spurious 1 GHz to 18 GHz

#### Setup

- The equipment is set up to simulate normal operation mode as described in the user manual or defined by the manufacturer.
- If the EUT is a tabletop system, a 2-axis positioner with 1.5 m height is used.
- If the EUT is a floor standing device, it is placed directly on the turn table.
- Auxiliary equipment and cables are positioned to simulate normal operation conditions as described in ANSI C 63.4.
- The AC power port of the EUT (if available) is connected to a power outlet below the turntable.
- Measurement distance is 3 m (see ANSI C 63.4) – see test details.
- EUT is set into operation.

#### Premeasurement

- The turntable rotates from 0° to 315° using 45° steps.
- The antenna is polarized vertical and horizontal.
- The antenna height is 1.5 m.
- At each turntable position and antenna polarization the analyzer sweeps with positive peak detector to find the maximum of all emissions.

#### Final measurement

- The final measurement is performed for at least six highest peaks according to the requirements of the ANSI C63.4.
- Based on antenna and turntable positions at which the peak values are measured the software maximizes the peaks by rotating the turntable from 0° to 360°. This measurement is repeated for different EUT-table positions (0° to 150° in 30°-steps) and for both antenna polarizations.
- The final measurement is done in the position (turntable, EUT-table and antenna polarization) causing the highest emissions with Peak and RMS detector (as described in ANSI C 63.4).
- Final levels, frequency, measuring time, bandwidth, turntable position, EUT-table position, antenna polarization, correction factor, margin to the limit and limit are recorded. A plot with the graph of the premeasurement with marked maximum final results and the limit is stored.

## 7.4 Sequence of testing radiated spurious above 18 GHz

### Setup

- The equipment is set up to simulate normal operation mode as described in the user manual or defined by the manufacturer.
- Auxiliary equipment and cables are positioned to simulate normal operation conditions as described in ANSI C 63.4.
- The AC power port of the EUT (if available) is connected to a power outlet.
- The measurement distance is as appropriate (e.g. 0.5 m).
- The EUT is set into operation.

### Premeasurement

- The test antenna is handheld and moved carefully over the EUT to cover the EUT's whole sphere and different polarizations of the antenna.

### Final measurement

- The final measurement is performed at the position and antenna orientation causing the highest emissions with Peak and RMS detector (as described in ANSI C 63.4).
- Final levels, frequency, measuring time, bandwidth, correction factor, margin to the limit and limit are recorded. A plot with the graph of the premeasurement and the limit is stored.

## 8 Measurement uncertainty

Measurement uncertainty	
Test case	Uncertainty
Antenna gain	± 3 dB
Spectrum bandwidth	± 21.5 kHz absolute; ± 15.0 kHz relative
Maximum output power	± 1 dB
Detailed conducted spurious emissions @ the band edge	± 1 dB
Band edge compliance radiated	± 3 dB
Spurious emissions conducted	± 3 dB
Spurious emissions radiated below 30 MHz	± 3 dB
Spurious emissions radiated 30 MHz to 1 GHz	± 3 dB
Spurious emissions radiated 1 GHz to 12.75 GHz	± 3.7 dB
Spurious emissions radiated above 12.75 GHz	± 4.5 dB
Spurious emissions conducted below 30 MHz (AC conducted)	± 2.6 dB



## 9 Summary of measurement results

<input checked="" type="checkbox"/>	No deviations from the technical specifications were ascertained
<input type="checkbox"/>	There were deviations from the technical specifications ascertained
<input type="checkbox"/>	This test report is only a partial test report. The content and verdict of the performed test cases are listed below.

TC Identifier	Description	Verdict	Date	Remark
RF-Testing	CFR Part 15 RSS - 247, Issue 2	See table!	2017-04-12	-/-

Test specification clause	Test case	Guideline	Temperature conditions	Power source voltages	Mode	C	NC	NA	NP	Remark
§15.247(b)(4) RSS - 247 / 5.4 (d)	System gain	-/-	Nominal	Nominal	GFSK					Declared
§15.247(e) RSS - 247 / 5.2 (b)	Power spectral density	KDB 558074 DTS clause: 10.6	Nominal	Nominal	GFSK	<input checked="" type="checkbox"/>	<input type="checkbox"/>	<input type="checkbox"/>	<input type="checkbox"/>	-/-
§15.247(a)(2) RSS - 247 / 5.2 (a)	DTS bandwidth – 6 dB bandwidth	KDB 558074 DTS clause: 8.1	Nominal	Nominal	GFSK	<input checked="" type="checkbox"/>	<input type="checkbox"/>	<input type="checkbox"/>	<input type="checkbox"/>	-/-
RSS Gen clause 4.6.1	Occupied bandwidth	-/-	Nominal	Nominal	GFSK	<input checked="" type="checkbox"/>	<input type="checkbox"/>	<input type="checkbox"/>	<input type="checkbox"/>	-/-
§15.247(b)(3) RSS - 247 / 5.4 (d)	Maximum output power	KDB 558074 DTS clause: 9.1.1	Nominal	Nominal	GFSK	<input checked="" type="checkbox"/>	<input type="checkbox"/>	<input type="checkbox"/>	<input type="checkbox"/>	-/-
§15.247(d) RSS - 247 / 5.5	Detailed spurious emissions @ the band edge - conducted	-/-	Nominal	Nominal	GFSK	<input checked="" type="checkbox"/>	<input type="checkbox"/>	<input type="checkbox"/>	<input type="checkbox"/>	-/-
§15.205 RSS - 247 / 5.5 RSS - Gen	Band edge compliance radiated	KDB 558074 DTS clause: 13.3.2	Nominal	Nominal	GFSK	<input checked="" type="checkbox"/>	<input type="checkbox"/>	<input type="checkbox"/>	<input type="checkbox"/>	-/-
§15.247(d) RSS - 247 / 5.5	TX spurious emissions conducted	KDB 558074 DTS clause: 11.1 & 11.2 11.3	Nominal	Nominal	GFSK	<input checked="" type="checkbox"/>	<input type="checkbox"/>	<input type="checkbox"/>	<input type="checkbox"/>	-/-
§15.209(a) RSS - Gen	Spurious emissions radiated below 30 MHz	-/-	Nominal	Nominal	GFSK	<input checked="" type="checkbox"/>	<input type="checkbox"/>	<input type="checkbox"/>	<input type="checkbox"/>	-/-
§15.247(d) RSS - 247 / 5.5 §15.109 RSS - Gen	Spurious emissions radiated 30 MHz to 1 GHz	-/-	Nominal	Nominal	-/-	<input checked="" type="checkbox"/>	<input type="checkbox"/>	<input type="checkbox"/>	<input type="checkbox"/>	-/-
§15.247(d) RSS - 247 / 5.5 §15.109 RSS - Gen	Spurious emissions radiated above 1 GHz	-/-	Nominal	Nominal	GFSK	<input checked="" type="checkbox"/>	<input type="checkbox"/>	<input type="checkbox"/>	<input type="checkbox"/>	-/-
§15.107(a) §15.207	Conducted emissions below 30 MHz (AC conducted)	-/-	Nominal	Nominal	GFSK	<input checked="" type="checkbox"/>	<input type="checkbox"/>	<input type="checkbox"/>	<input type="checkbox"/>	-/-

**Note:** C = Compliant; NC = Not compliant; NA = Not applicable; NP = Not performed

## 10 Additional comments

The Bluetooth® word mark and logos are owned by the Bluetooth SIG Inc. and any use of such marks by CTC advanced GmbH is under license.

Reference documents: Customer Questionnaire

3-3-TECH-587 920-04 Flir Lennox antenna characterization A

Special test descriptions: None

Configuration descriptions: TX tests: were performed with LE packets (37 byte payload) and static PRBS pattern.

RX/Standby tests: BT enabled, TX Idle

Tested frequencies: lowest: 2402 MHz

middle: 2440 MHz

- highest: 2480 MHz

Test mode:

Bluetooth LE Test mode enabled  
 (EUT is controlled over CBT)

Special software is used.  
 EUT is transmitting pseudo random data by itself

Antennas and transmit operating modes:

Operating mode 1 (single antenna)

- *Equipment with 1 antenna,*

- *Equipment with 2 diversity antennas operating in switched diversity mode by which at any moment in time only 1 antenna is used,*

- *Smart antenna system with 2 or more transmit/receive chains, but operating in a mode where only 1 transmit/receive chain is used)*

Operating mode 2 (multiple antennas, no beamforming)

- *Equipment operating in this mode contains a smart antenna system using two or more transmit/receive chains simultaneously but without beamforming.*

Operating mode 3 (multiple antennas, with beamforming)

- *Equipment operating in this mode contains a smart antenna system using two or more transmit/receive chains simultaneously with beamforming.*

*In addition to the antenna assembly gain (G), the beamforming gain (Y) may have to be taken into account when performing the measurements.*

## 11 Measurement results

### 11.1 System gain

**Limits:**

FCC	IC
6 dBi / > 6 dBi output power and power density reduction required	

**Results:**

T <sub>nom</sub>	V <sub>nom</sub>	DTS band 2400 MHz to 2483.5 MHz
Gain [dBi] Declared by the customer		-1.5

**Plots:** antenna characterization and gain (provided by the customer)

**Plot 1:** plane definitions



Figure 3 Measurement plane definitions

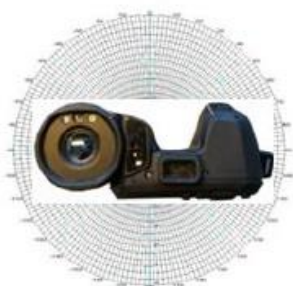

Figure 4 XY-plane



Figure 5 XZ-plane



Figure 6 YZ-plane

Plot 2: XY-plane

2.3.2 XY-plane

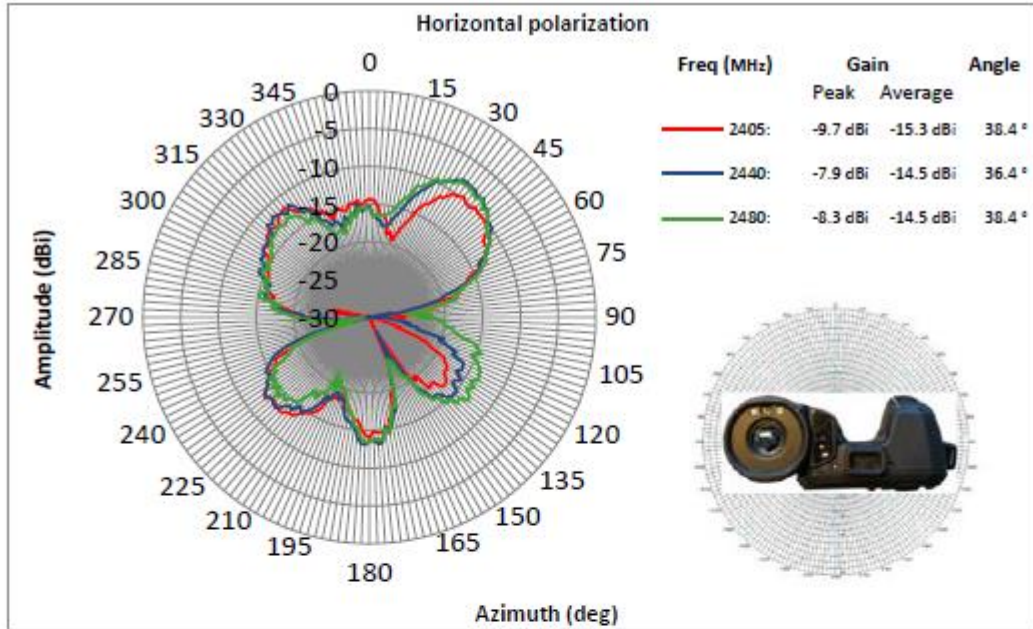

Figure 8 2,5GHz XY-plane, horizontal polarization

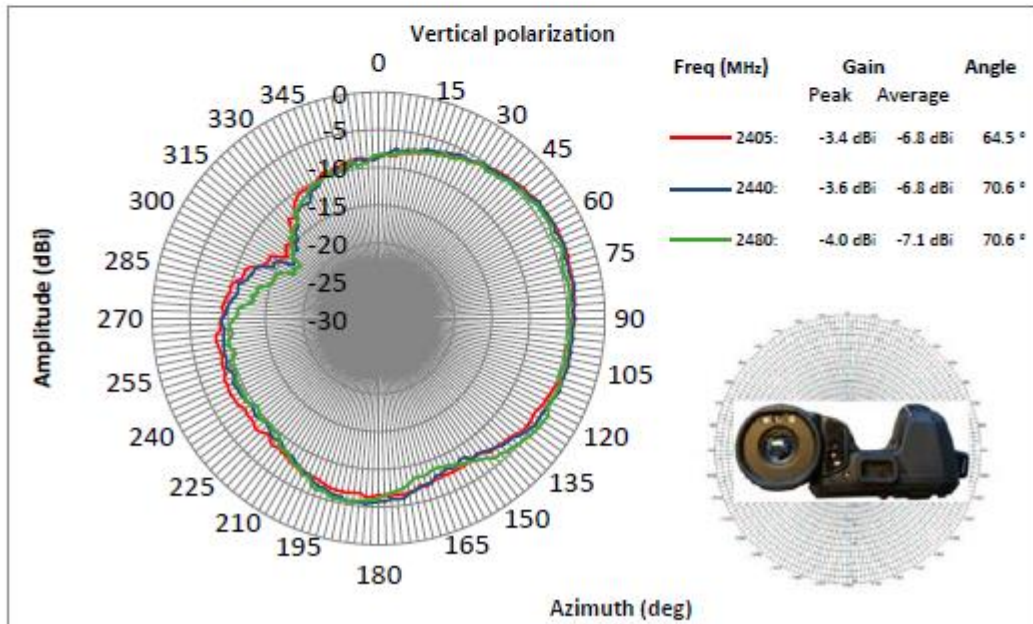

Figure 9 2,5GHz XY-plane, vertical polarization

Plot 3: XZ-plane

2.3.3 XZ-plane

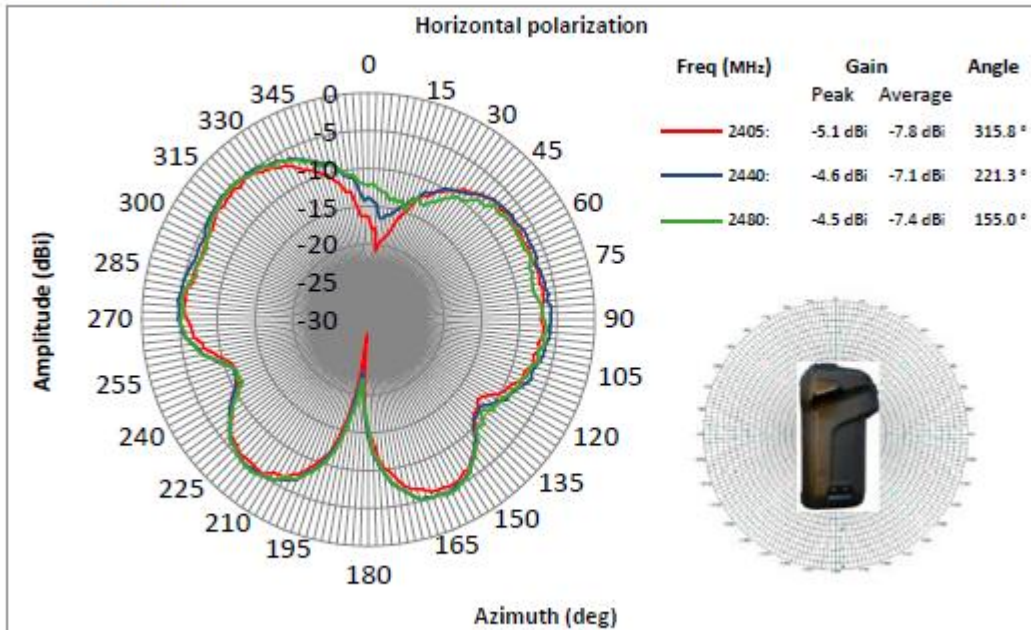

Figure 12 2,5GHz XZ-plane, horizontal polarization

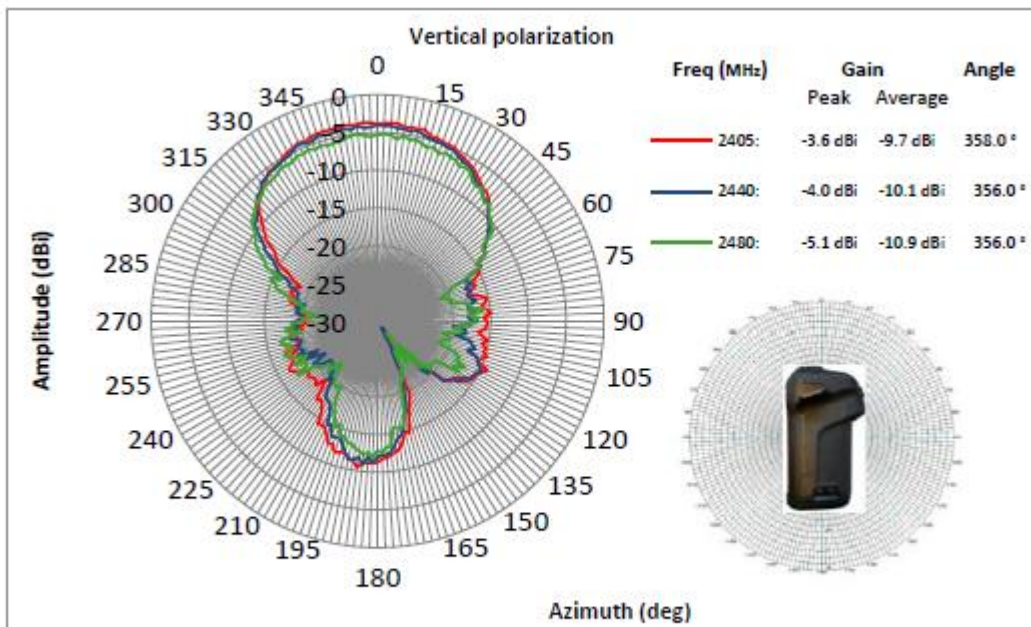

Figure 13 2,5GHz XZ-plane, vertical polarization

Plot 4: YZ-plane

2.3.4 YZ-plane

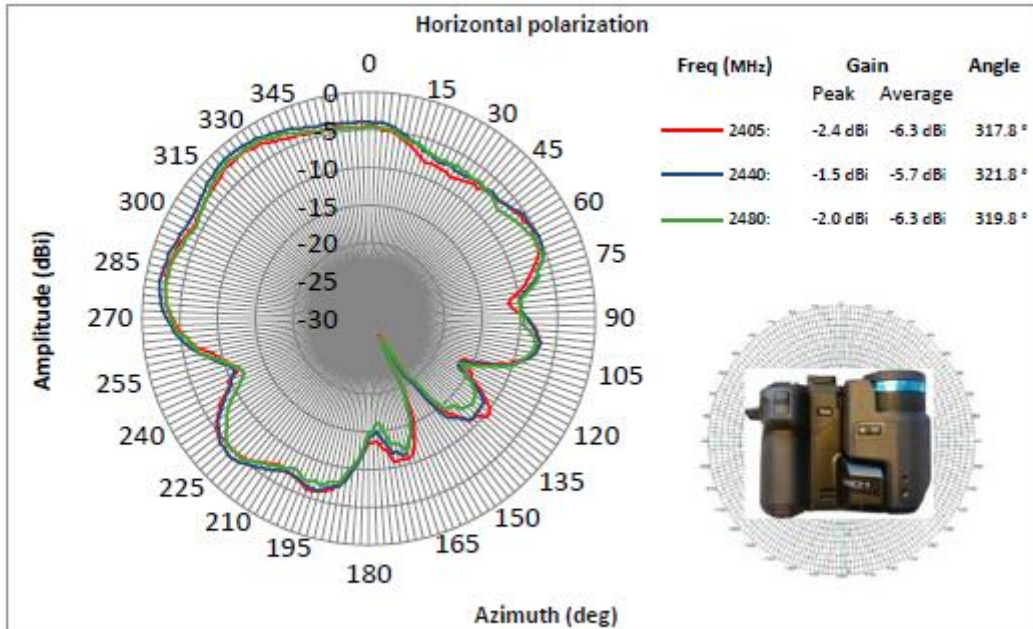

Figure 16 2,5GHz YZ-plane, horizontal polarization

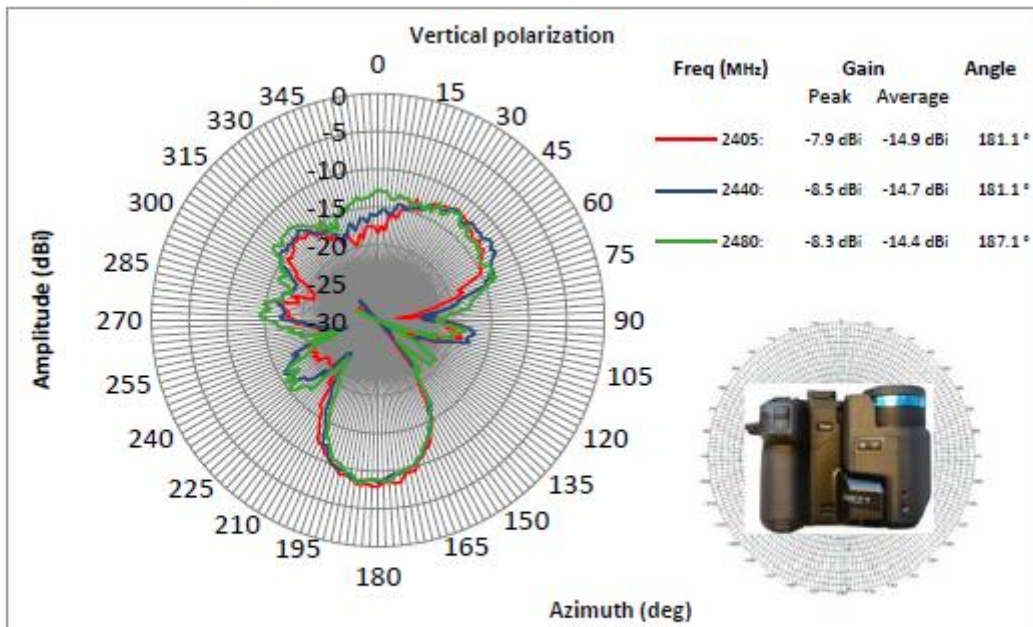

Figure 17 2,5GHz YZ-plane, vertical polarization

**Plot 5:** summary

### 3 Summary

The WiFi antenna within the *Flir Lennox* thermal camera has been characterized. The maximum antenna gain has been measured to be -1,5dBi for the 2.4GHz band and 2,0dBi for the 5GHz band.



## 11.2 Power spectral density

### Description:

Measurement of the power spectral density of a digital modulated system.

Measurement parameters	
Detector	Peak
Sweep time	Auto
Resolution bandwidth	3 kHz
Video bandwidth	10 kHz
Span	≥ EBW
Trace mode	Max hold
Test setup	See sub clause 6.4 A
Measurement uncertainty	See sub clause 8

### Limits:

FCC	IC
Power spectral density	
For digitally modulated systems the transmitter power spectral density conducted from the transmitter to the antenna shall not be greater than 8 dBm in any 3 kHz band during any time interval of continuous transmission or over 1.0 second if the transmission exceeds 1.0-second duration.	

### Results:

	Frequency		
	2402 MHz	2440 MHz	2480 MHz
Power spectral density [dBm / 3kHz]	-8.5	-8.3	-8.8

**Plots:**

**Plot 1: lowest channel**

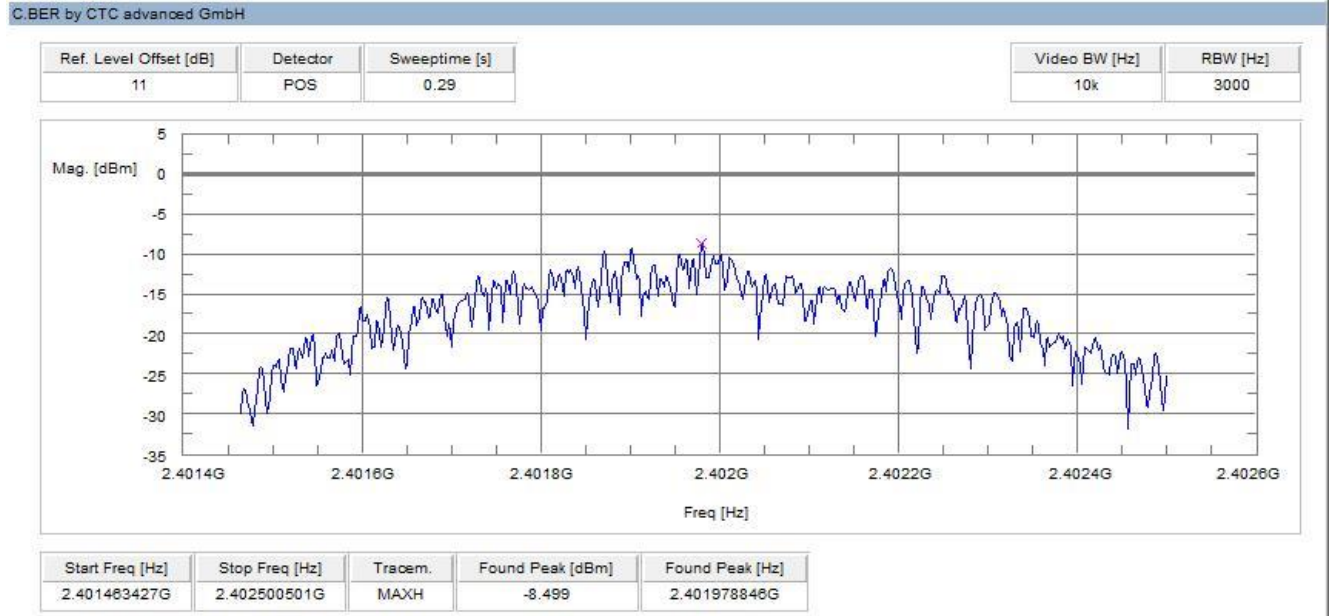

**Plot 2: mid channel**

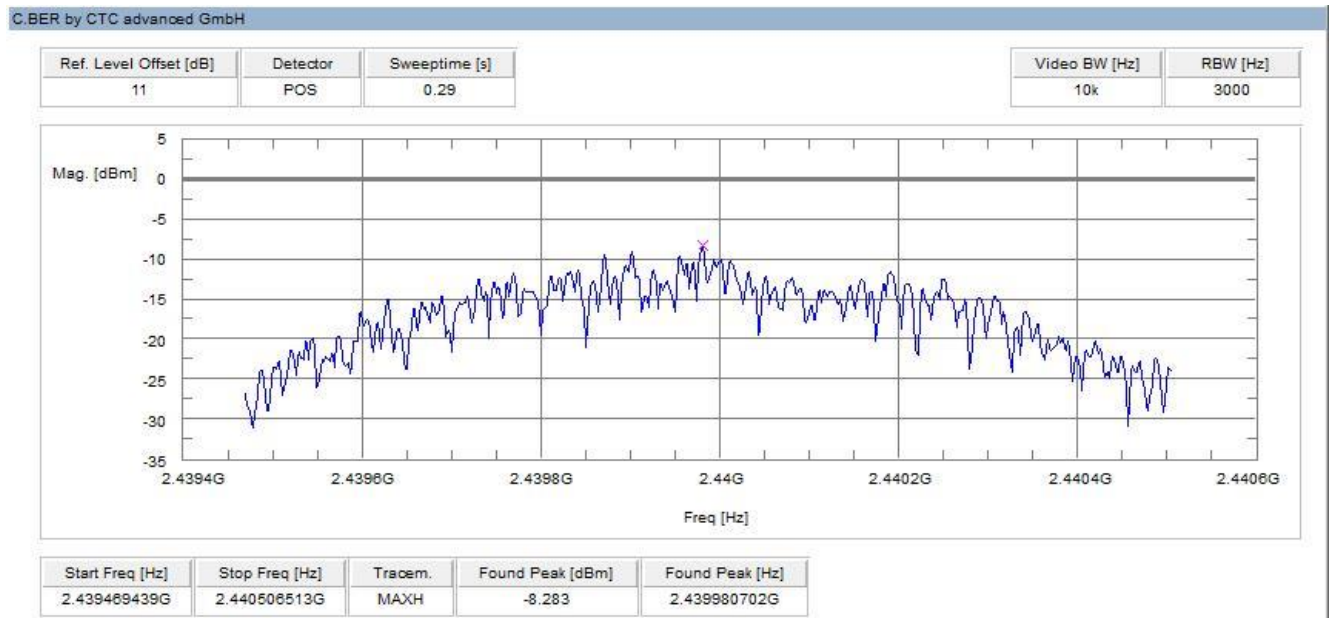

**Plot 3: highest channel**

C.BER by CTC advanced GmbH

Ref. Level Offset [dB]	Detector	Sweptime [s]	Video BW [Hz]	RBW [Hz]
11	POS	0.29	10k	3000

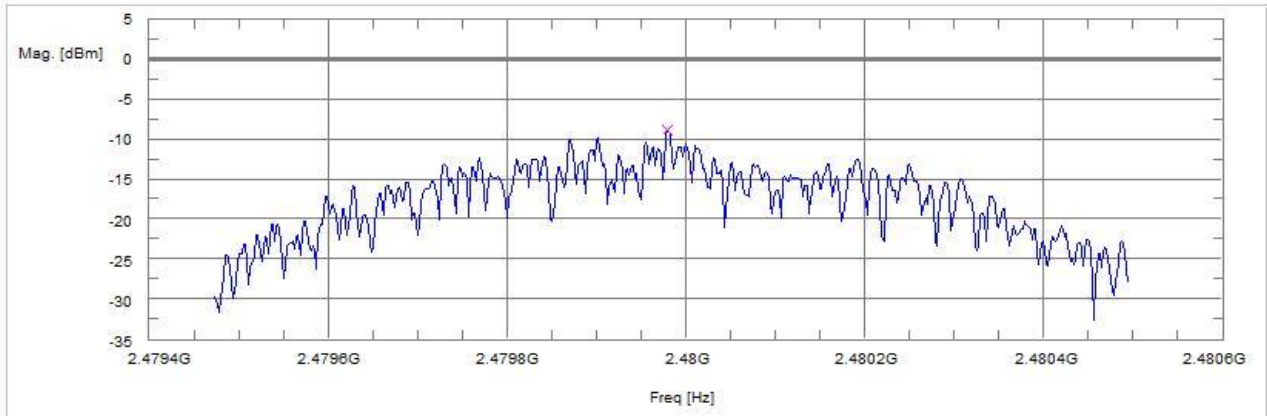

Start Freq [Hz]	Stop Freq [Hz]	Tracem.	Found Peak [dBm]	Found Peak [Hz]
2.479471944G	2.480493988G	MAXH	-8.759	2.479979894G

### 11.3 DTS bandwidth – 6 dB bandwidth

**Description:**

Measurement of the 6 dB bandwidth of the modulated signal.

Measurement parameters	
According to DTS clause: 8.1	
Detector	Peak
Sweep time	Auto
Resolution bandwidth	100 kHz
Video bandwidth	300 kHz
Span	5 MHz
Measurement procedure	Using 3 marker (max + 2x-6dB)
Trace mode	Max hold (allow trace to stabilize)
Test setup	See sub clause 6.4 A
Measurement uncertainty	See sub clause 8

**Limits:**

FCC	IC
DTS bandwidth – 6 dB bandwidth	
Systems using digital modulation techniques may operate in the 2400–2483.5 MHz band. The minimum 6 dB bandwidth shall be at least 500 kHz.	

**Results:**

	Frequency		
	2402 MHz	2440 MHz	2480 MHz
6 dB bandwidth [kHz]	711	711	701

**Plots:**

**Plot 1: lowest channel**

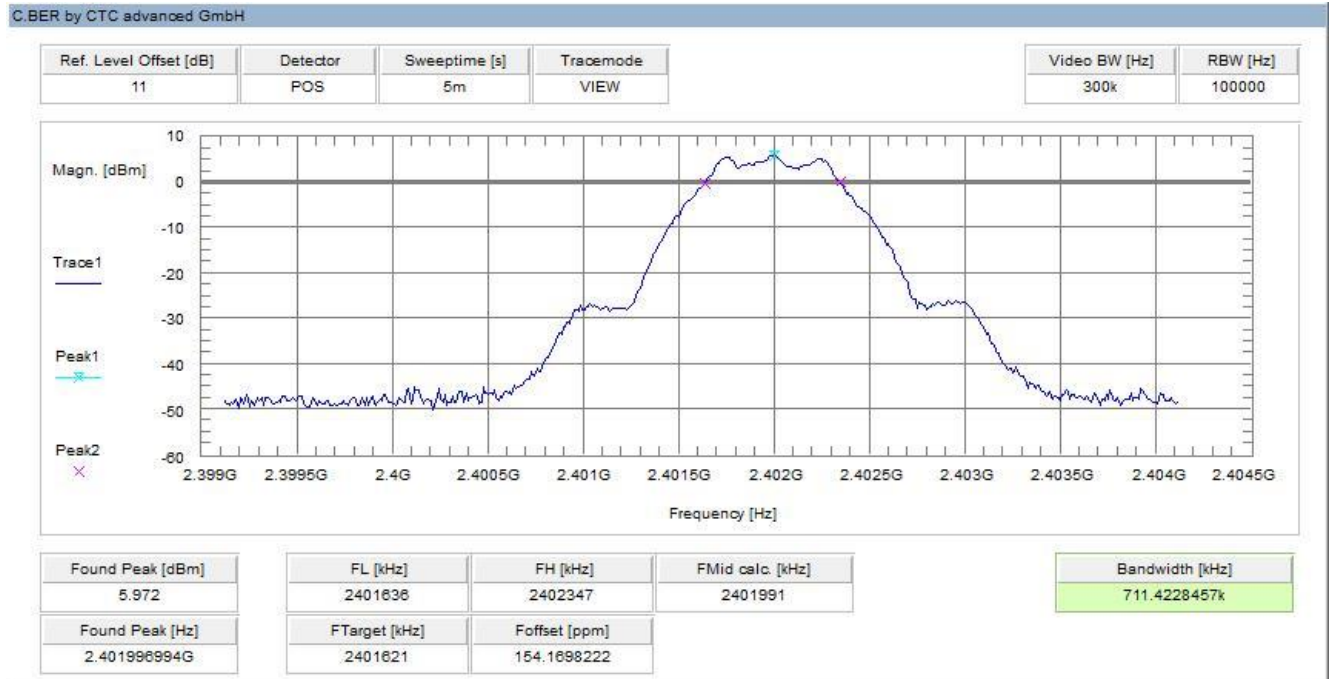

**Plot 2: mid channel**

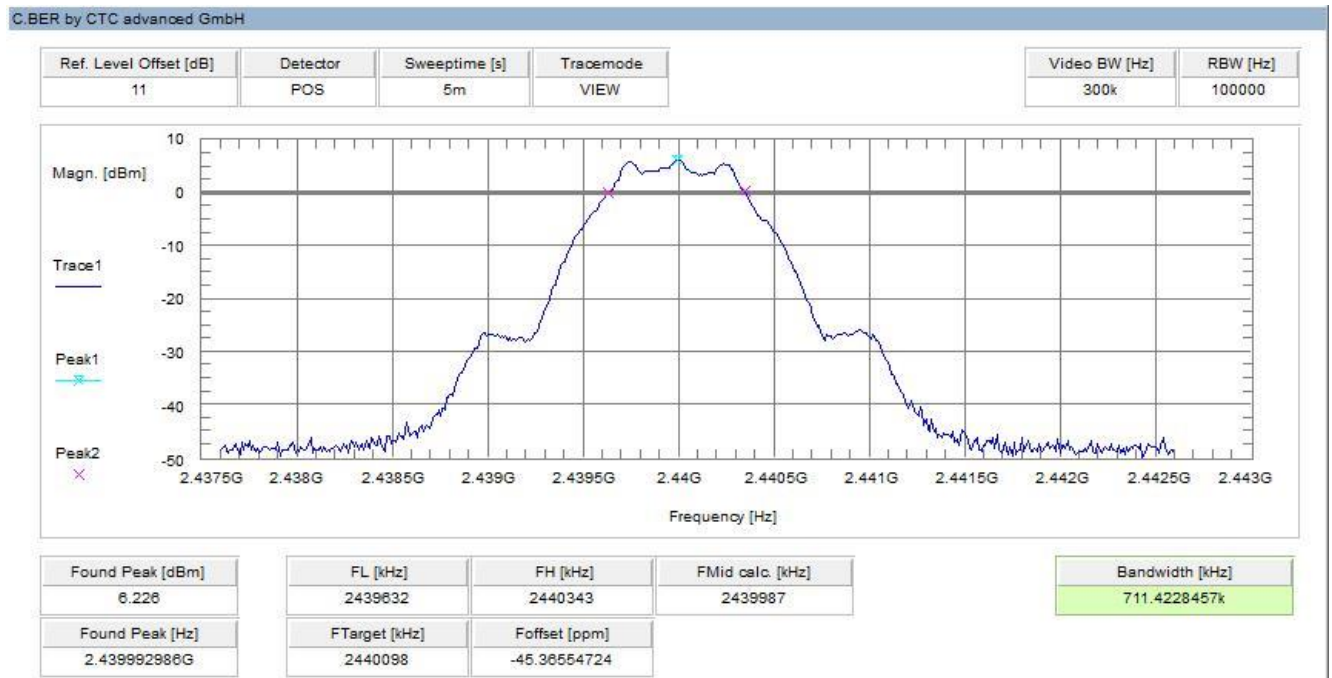

**Plot 3: highest channel**

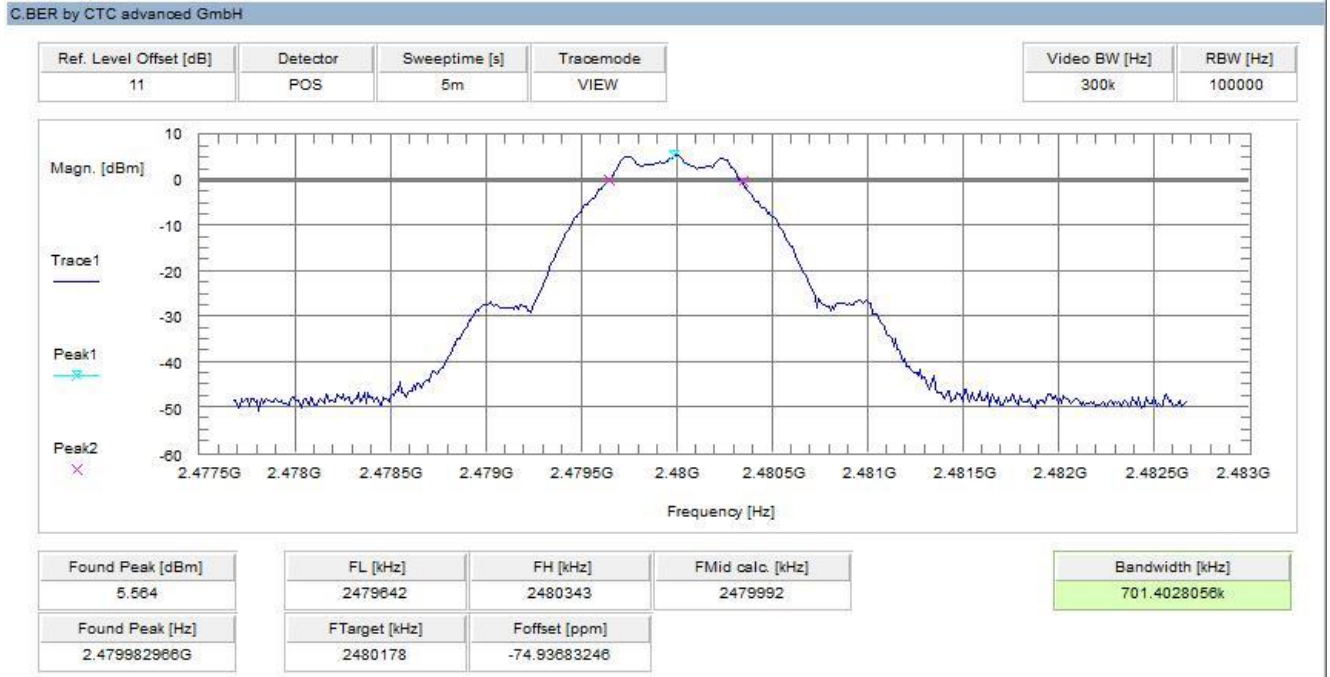

### 11.4 Occupied bandwidth – 99% emission bandwidth

**Description:**

Measurement of the 99% bandwidth of the modulated signal acc. RSS-GEN.

Measurement parameters	
Detector	Peak
Sweep time	Auto
Resolution bandwidth	30 kHz
Video bandwidth	100 kHz
Span	5 MHz
Measurement procedure	Measurement of the 99% bandwidth using the integration function of the analyzer
Trace mode	Max hold (allow trace to stabilize)
Test setup	See sub clause 6.4 A
Measurement uncertainty	See sub clause 8

**Usage:**

-/-	IC
Occupied bandwidth – 99% emission bandwidth	
OBW is necessary for emission designator	

**Results:**

	Frequency		
	2402 MHz	2440 MHz	2480 MHz
<b>99% bandwidth [kHz]</b>	1022	1012	1012

**Plots:**

**Plot 1: lowest channel**

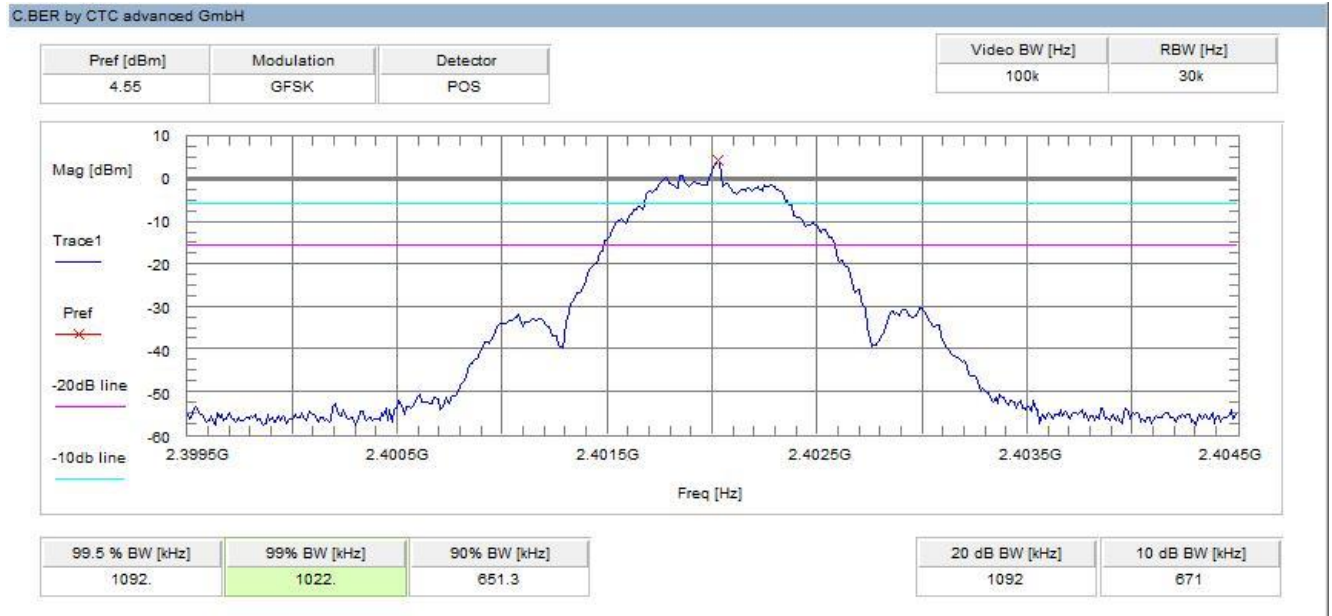

**Plot 2: mid channel**

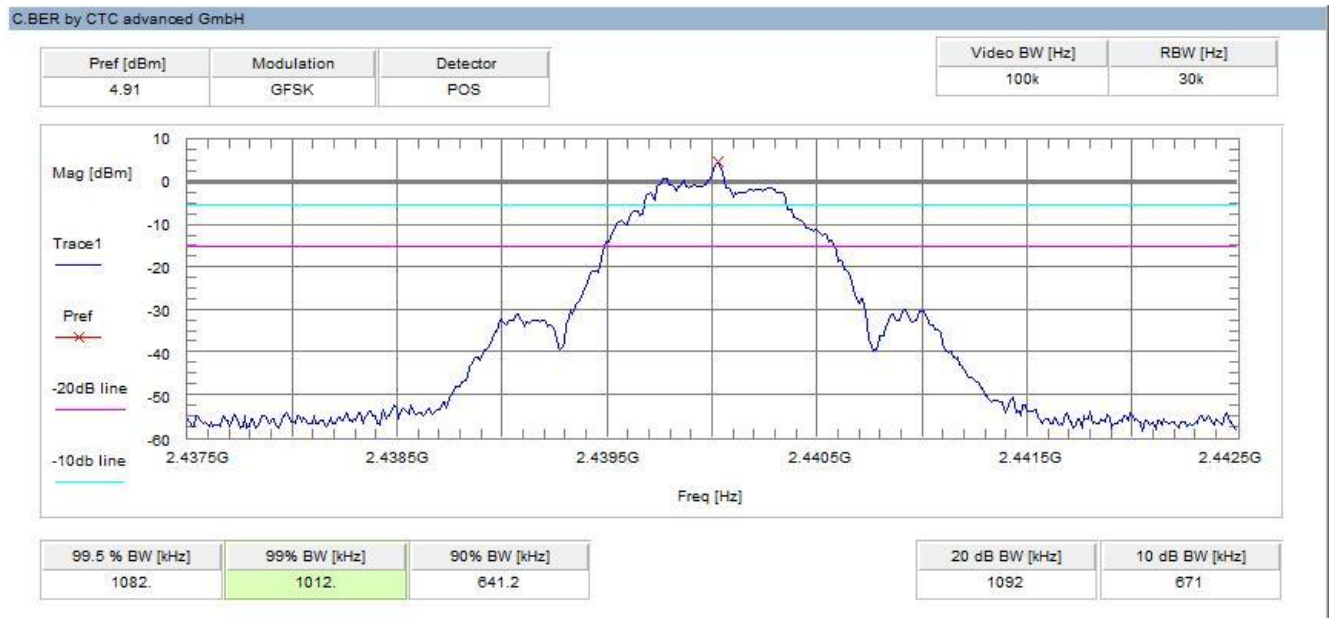



**Plot 3: highest channel**

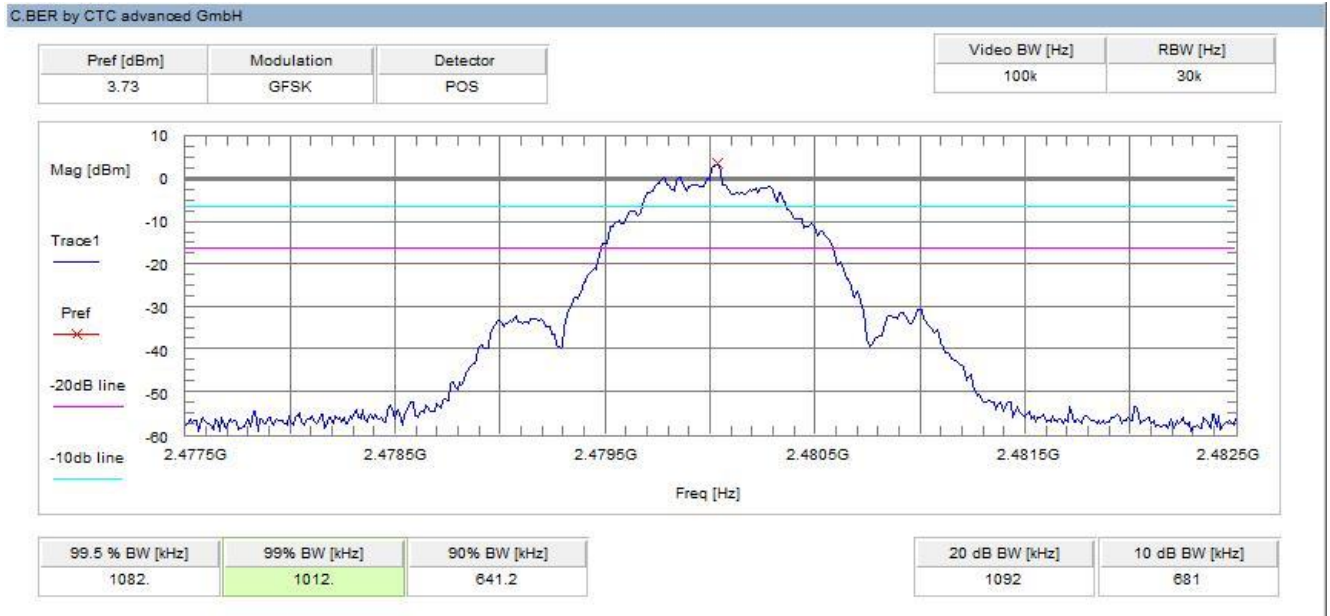

### 11.5 Maximum output power

**Description:**

Measurement of the maximum output power conducted and radiated. EUT in single channel mode.

Measurement parameters	
Detector	Peak
Sweep time	Auto
Resolution bandwidth	3 MHz
Video bandwidth	10 MHz
Span	10 MHz
Trace mode	Max hold
Test setup	See sub clause 6.4 A
Measurement uncertainty	See sub clause 8

**Limits:**

FCC	IC
Maximum output power	
[Conducted: 0.125 W – antenna gain max. 6 dBi] Systems using more than 75 hopping channels: Conducted: 1.0 W – antenna gain max. 6 dBi	

**Results:**

	Frequency		
	2402 MHz	2440 MHz	2480 MHz
<b>Maximum output power conducted [dBm]</b>	6.0	6.2	5.6

**Plots:**

**Plot 1: lowest channel**

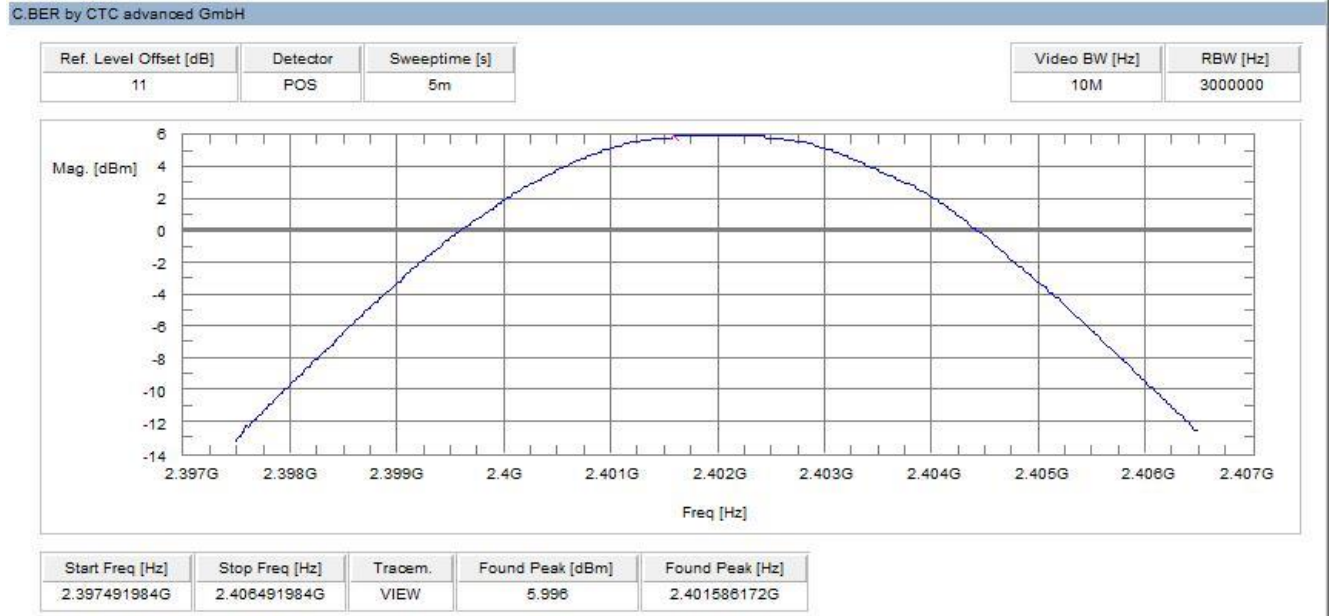

**Plot 2: mid channel**

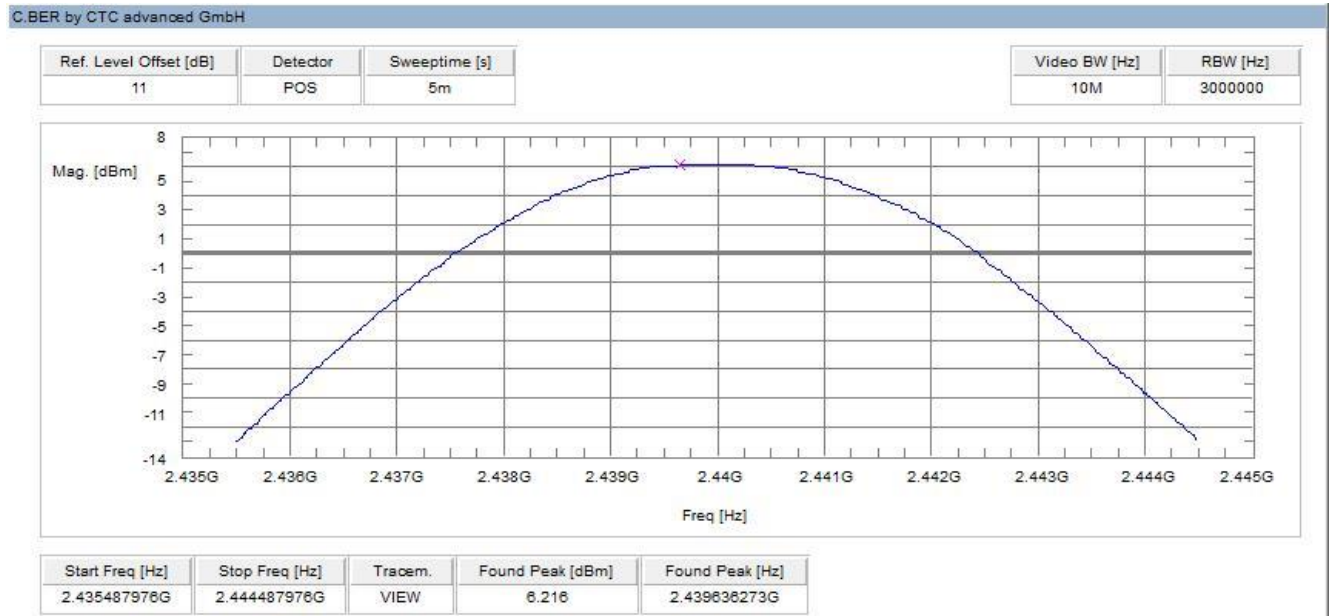

**Plot 3: highest channel**

C.BER by CTC advanced GmbH

Ref. Level Offset [dB]	Detector	Sweptime [s]
11	POS	5m

Video BW [Hz]	RBW [Hz]
10M	3000000

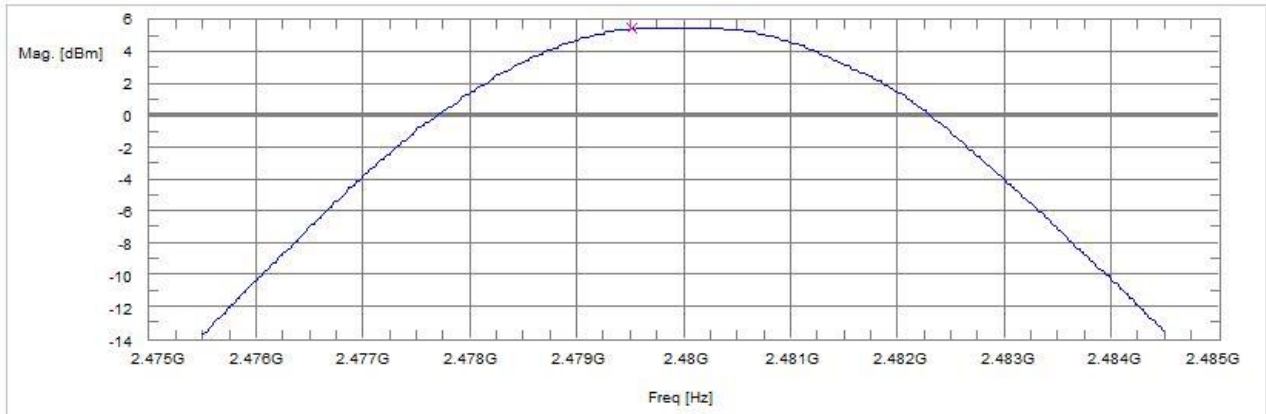

Start Freq [Hz]	Stop Freq [Hz]	Tracem.	Found Peak [dBm]	Found Peak [Hz]
2.475492986G	2.484492986G	VIEW	5.554	2.47951503G

**11.6 Detailed spurious emissions @ the band edge - conducted**

**Description:**

Measurement of the conducted band edge compliance. EUT is measured at the lower and upper band edge in single channel.

Measurement parameters	
Detector	Peak
Sweep time	Auto
Resolution bandwidth	100 kHz
Video bandwidth	300 kHz / 500 kHz
Span	Lower Band Edge: 2395 – 2405 MHz Upper Band Edge: 2478 – 2489 MHz
Trace mode	Max hold
Test setup	See sub clause 6.4 A
Measurement uncertainty	See sub clause 8

**Limits:**

FCC	IC
In any 100 kHz bandwidth outside the frequency band in which the spread spectrum or digitally modulated intentional radiator is operating, the radio frequency power that is produced by the intentional radiator shall be at least 20 dB below that in the 100 kHz bandwidth within the band that contains the highest level of the desired power, based on either an RF conducted or a radiated measurement. Attenuation below the general limits specified in Section 15.209(a) is not required.	

**Result:**

Scenario	Spurious band edge conducted [dB]
Modulation	GFSK
Lower band edge – hopping off	> 20 dB
Upper band edge – hopping off	> 20 dB

**Plots:**

**Plot 1: Lower band edge**

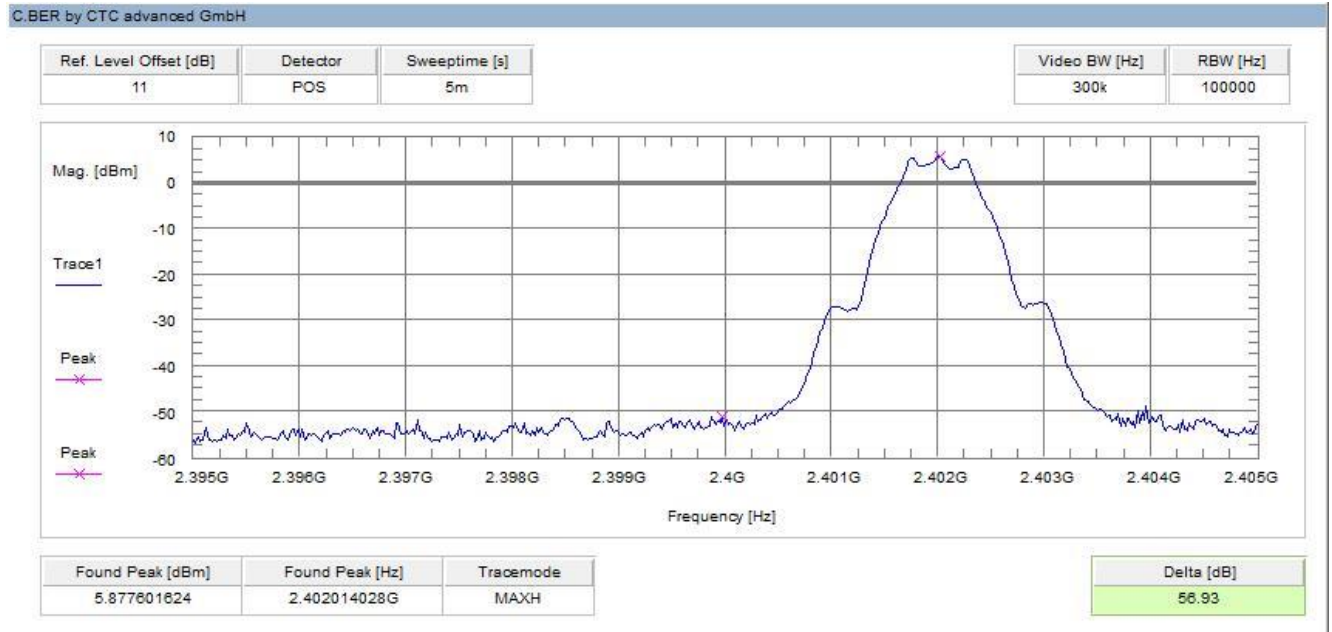

**Plot 2: Upper band edge**

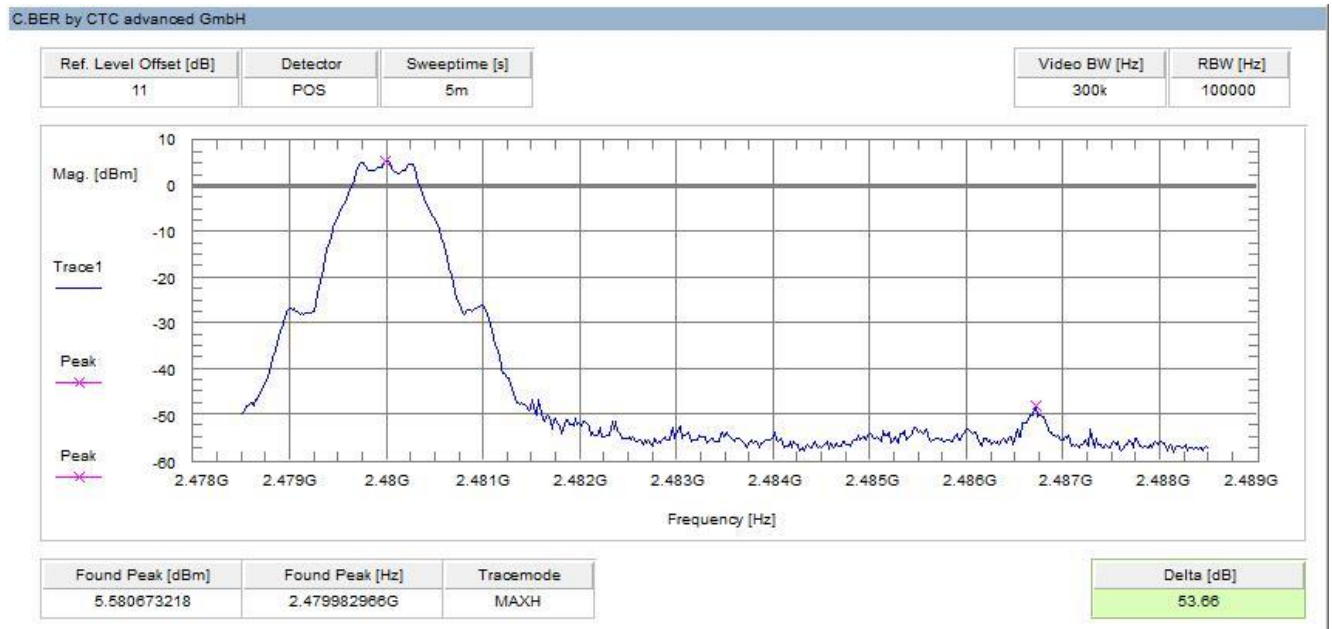

## 11.7 Band edge compliance radiated

### Description:

Measurement of the radiated band edge compliance. The EUT is turned in the position that results in the maximum level at the band edge. Then a sweep over the corresponding restricted band is performed. The EUT is set to single channel mode and the transmit frequency 2402 MHz for the lower restricted band and 2480 MHz for the upper restricted band. Measurement distance is 3m.

Measurement parameters	
Detector	Peak / RMS
Sweep time	Auto
Resolution bandwidth	1 MHz
Video bandwidth	3 MHz
Span	Lower Band: 2300 – 2400 MHz Upper Band: 2480 – 2500 MHz
Trace mode	Max hold
Test setup	See sub clause 6.2 B
Measurement uncertainty	See sub clause 8

### Limits:

FCC	IC
Band edge compliance radiated	
In any 100 kHz bandwidth outside the frequency band in which the spread spectrum or digitally modulated intentional radiator is operating, the radio frequency power that is produced by the intentional radiator shall be at least 20 dB below that in the 100 kHz bandwidth within the band that contains the highest level of the desired power, based on either an RF conducted or a radiated measurement. Attenuation below the general limits specified in Section 15.209(a) is not required. In addition, radiated emissions which fall in the restricted bands, as defined in Section 15.205(a), must also comply with the radiated emission limits specified in Section 15.209(a) (see Section 5.205(c)).	
54 dBµV/m AVG 74 dBµV/m Peak	

### Result:

Scenario	Band edge compliance radiated [dBµV/m]
Modulation	GFSK
Lower restricted band	< 54 AVG / < 74 PP
Upper restricted band	< 54 AVG / < 74 PP

**Plots:**

**Plot 1: Lower restricted band**

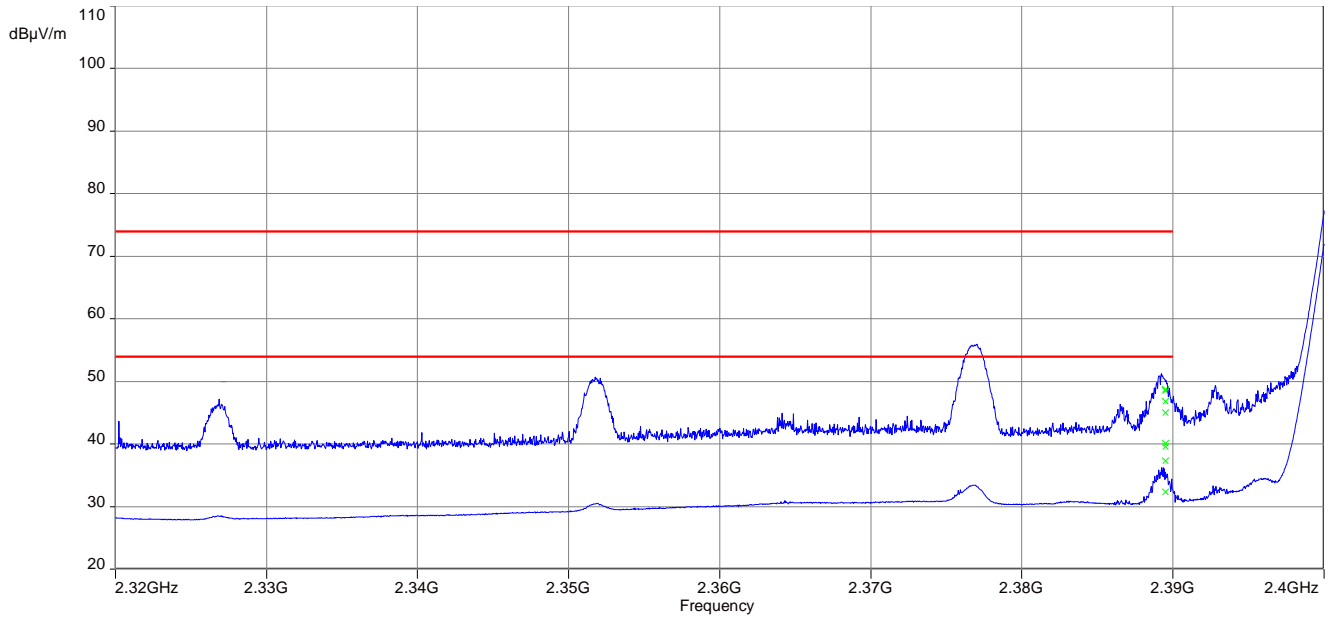

**Plot 2: Upper restricted band**

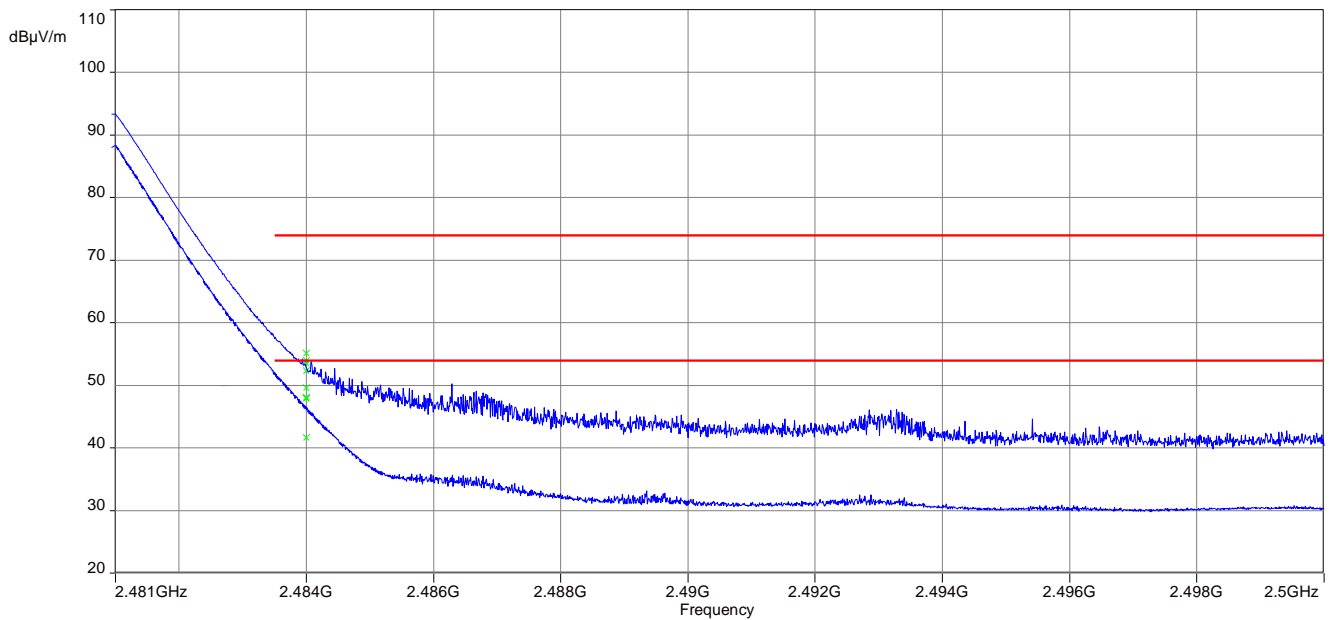



## 11.8 TX spurious emissions conducted

### Description:

Measurement of the conducted spurious emissions in transmit mode. The EUT is set to single channel mode and the transmit frequencies are 2402 MHz, 2440 MHz and 2480 MHz.

Measurement parameters	
Detector	Peak
Sweep time	Auto
Resolution bandwidth	100 kHz
Video bandwidth	300 kHz or 500 kHz
Span	9 kHz to 25 GHz
Trace mode	Max hold
Test setup	See sub clause 6.4 A
Measurement uncertainty	See sub clause 8

### Limits:

FCC	IC
TX spurious emissions conducted	
In any 100 kHz bandwidth outside the frequency band in which the spread spectrum or digitally modulated intentional radiator is operating, the radio frequency power that is produced by the intentional radiator shall be at least 20 dB below that in the 100 kHz bandwidth within the band that contains the highest level of the desired power, based on either an RF conducted or a radiated measurement. Attenuation below the general limits specified in Section 15.209(a) is not required	

### Results:

TX spurious emissions conducted					
f [MHz]		amplitude of emission [dBm]	limit max. allowed emission power	actual attenuation below frequency of operation [dB]	results
2402		5.8	30 dBm		Operating frequency
All detected emissions are compliant with the -20 dBc limit!			-20 dBc		compliant
2440		6.1	30 dBm		Operating frequency
All detected emissions are compliant with the -20 dBc limit!			-20 dBc		compliant
2480		5.3	30 dBm		Operating frequency
All detected emissions are compliant with the -20 dBc limit!			-20 dBc		compliant

**Plots:**

**Plot 1: lowest channel**

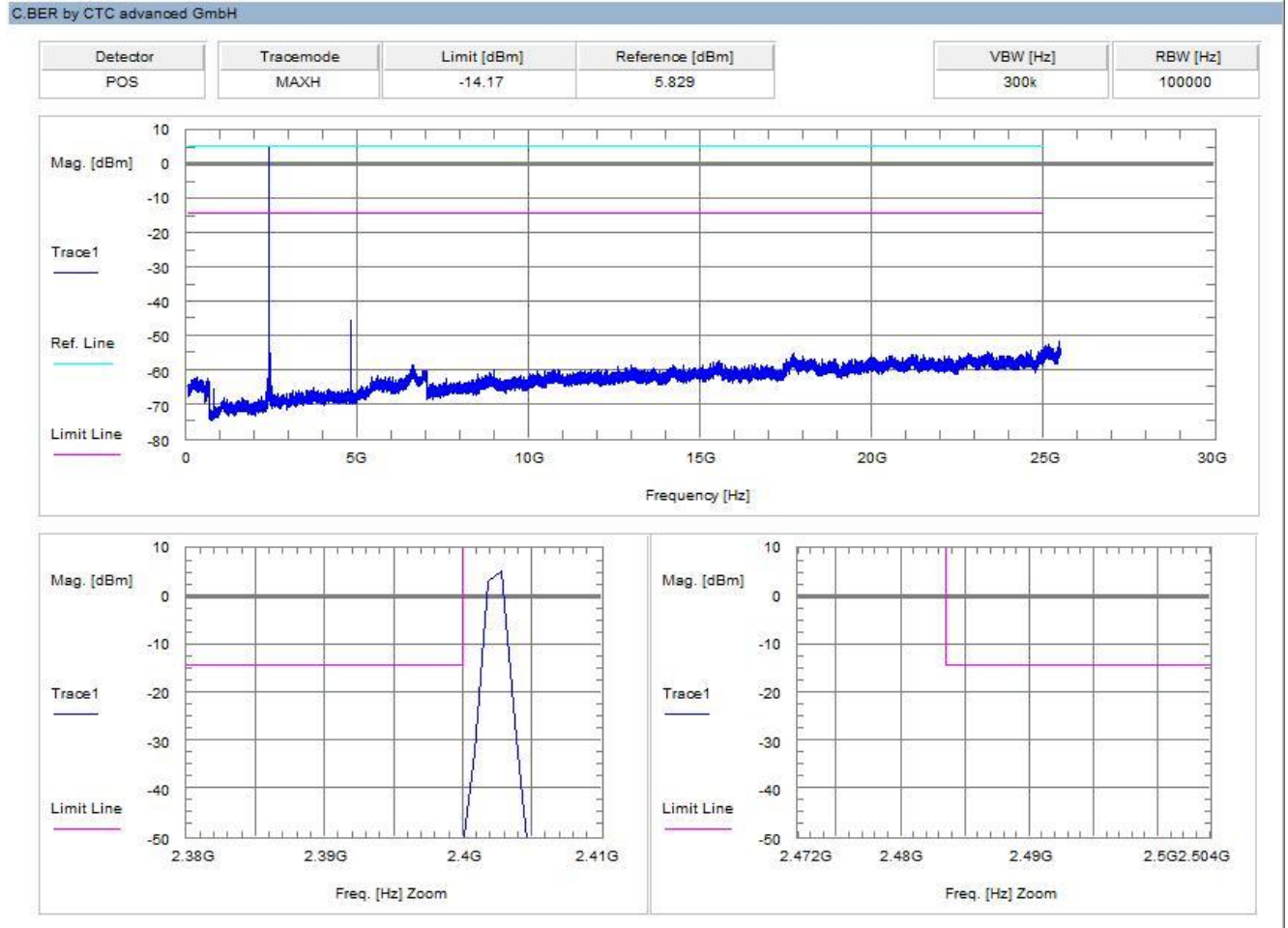

**Plot 2: mid channel**

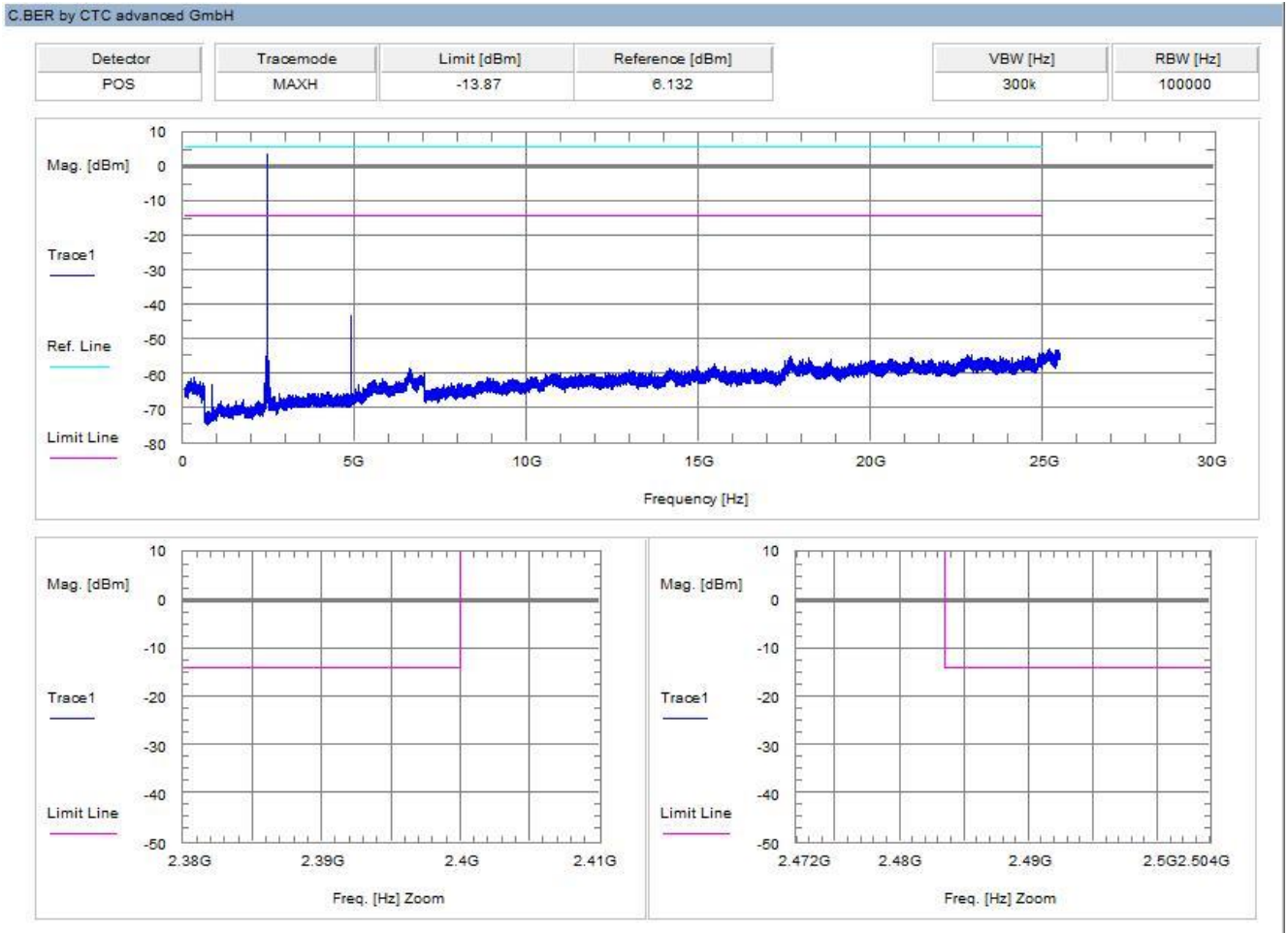

**Plot 3: highest channel**

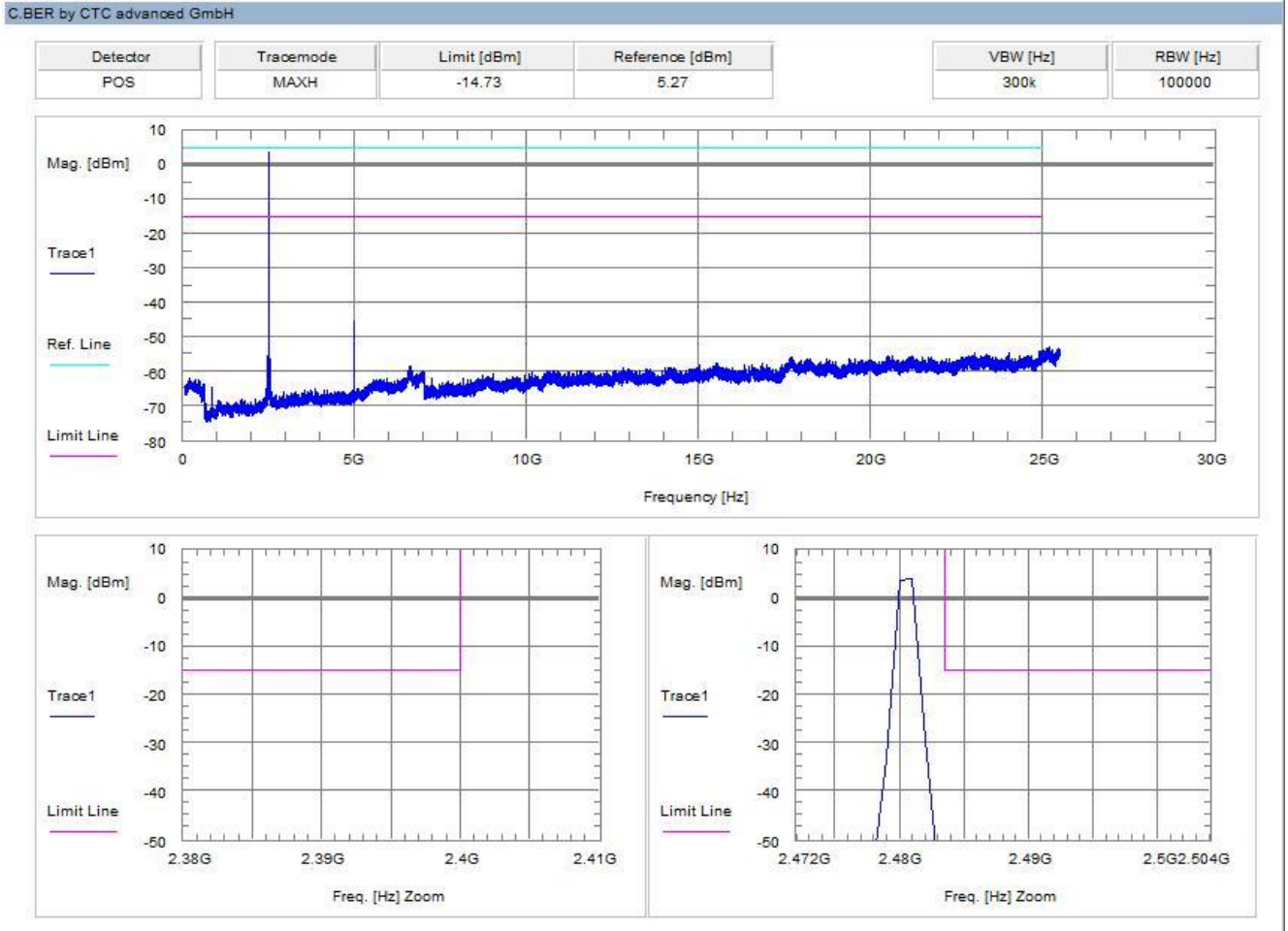

### 11.9 Spurious emissions radiated below 30 MHz

**Description:**

Measurement of the radiated spurious emissions in transmit mode below 30 MHz. The EUT is set to single channel mode and the transmit frequencies are 2402 MHz, 2440 MHz and 2480 MHz. The measurement is performed in the mode with the highest output power. The limits are recalculated to a measurement distance of 3 m according to the ANSI C63.10.

Measurement parameters	
Detector	Peak / Quasi peak
Sweep time	Auto
Resolution bandwidth	F < 150 kHz: 200 Hz F > 150 kHz: 9 kHz
Video bandwidth	F < 150 kHz: 1 kHz F > 150 kHz: 30 kHz
Span	9 kHz to 30 MHz
Trace mode	Max hold
Test setup	See sub clause 6.2 C
Measurement uncertainty	See sub clause 8

**Limits:**

FCC		IC
TX spurious emissions radiated below 30 MHz		
Frequency (MHz)	Field strength (dBµV/m)	Measurement distance
0.009 – 0.490	2400/F(kHz)	300
0.490 – 1.705	24000/F(kHz)	30
1.705 – 30.0	30	30

**Results:**

TX spurious emissions radiated below 30 MHz [dBµV/m]		
F [MHz]	Detector	Level [dBµV/m]
All detected emissions are more than 20 dB below the limit.		

**Plots:**

**Plot 1:** 9 kHz to 30 MHz, 2402 MHz, transmit mode

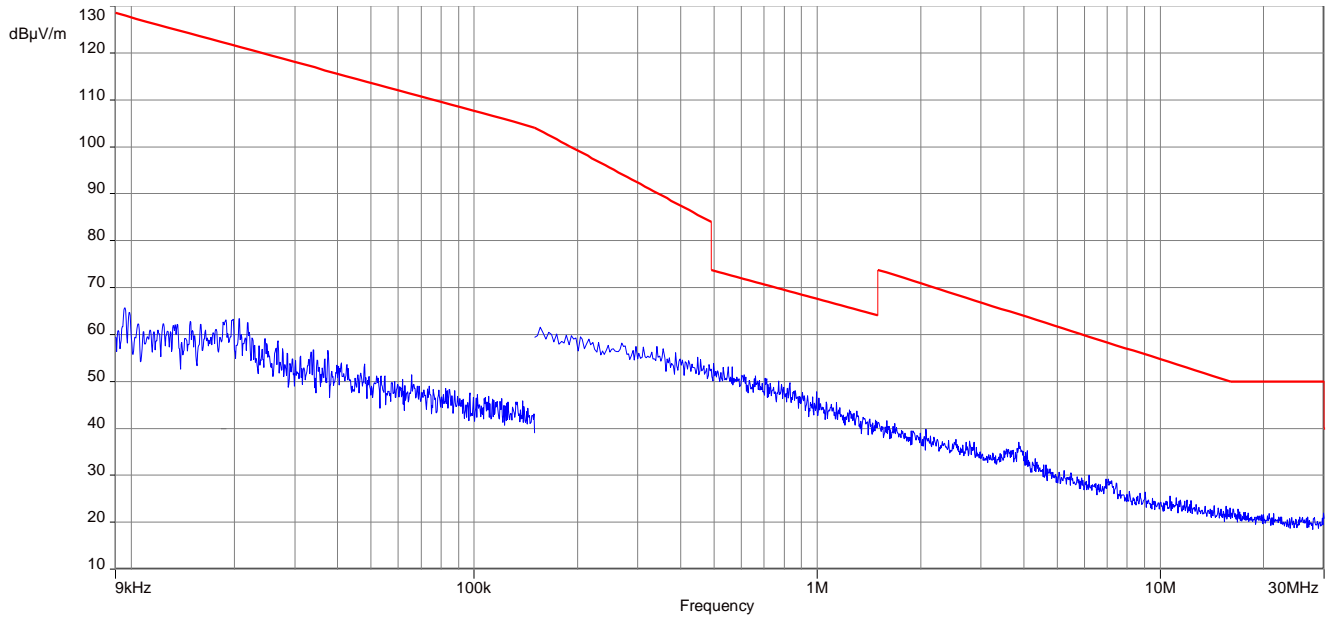

**Plot 2:** 9 kHz to 30 MHz, 2440 MHz, transmit mode

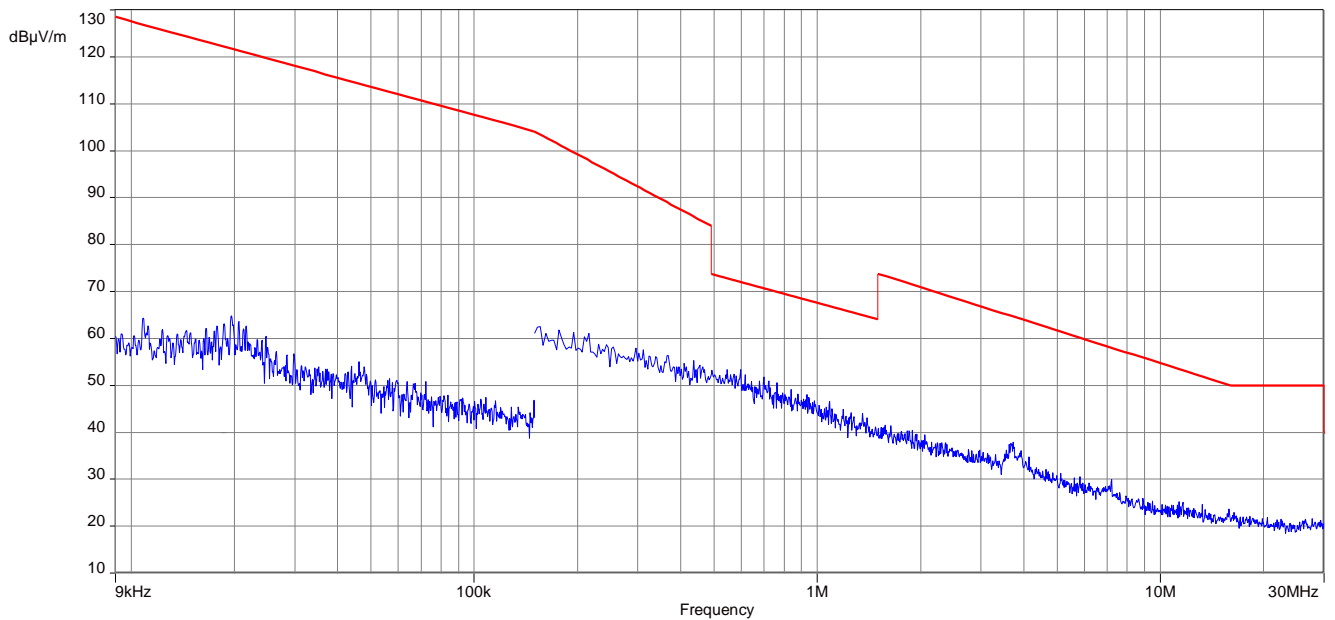

**Plot 3:** 9 kHz to 30 MHz, 2480 MHz, transmit mode

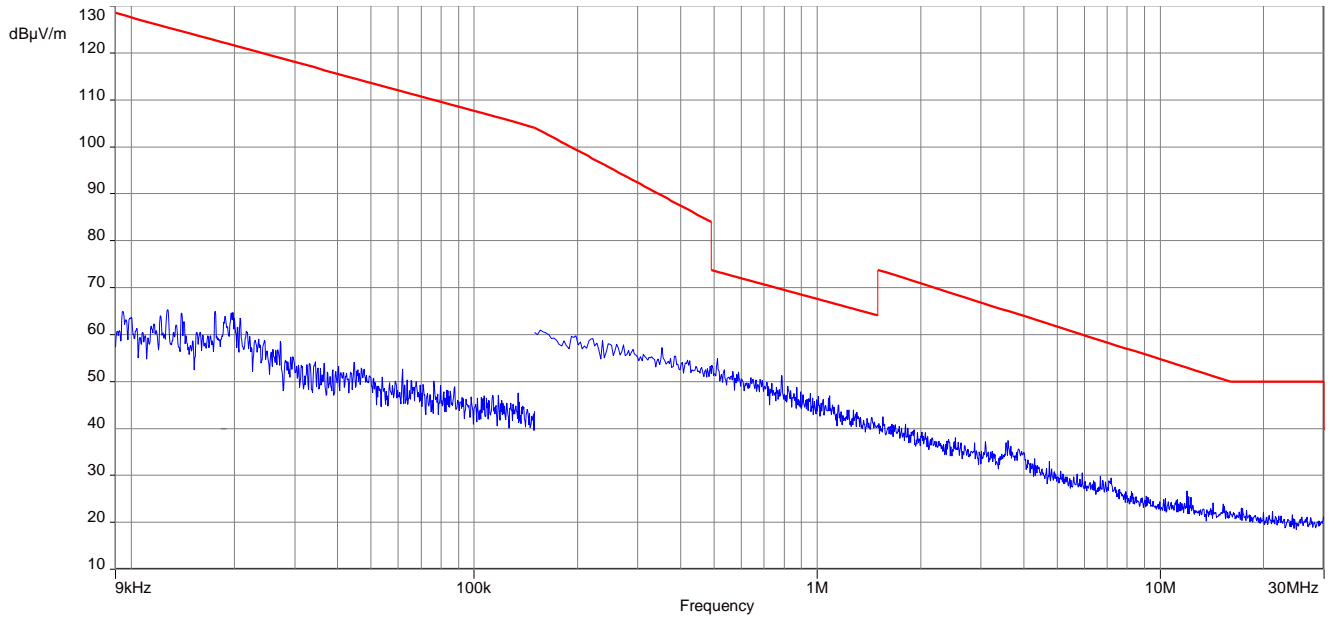

**11.10 Spurious emissions radiated 30 MHz to 1 GHz**

**Description:**

Measurement of the radiated spurious emissions in transmit mode. The EUT is set to single channel mode and the transmit frequencies are 2402 MHz, 2440 MHz and 2480 MHz. The measurement is performed in the mode with the highest output power.

Measurement parameters	
Detector	Peak / Quasi Peak
Sweep time	Auto
Resolution bandwidth	120 kHz
Video bandwidth	3 x RBW
Span	30 MHz to 1 GHz
Trace mode	Max hold
Measured modulation	GFSK
Test setup	See sub clause 6.1 A
Measurement uncertainty	See sub clause 8

The modulation with the highest output power was used to perform the transmitter spurious emissions. If spurious were detected a re-measurement was performed on the detected frequency with each modulation.

**Limits:**

FCC	IC	
TX spurious emissions radiated		
In any 100 kHz bandwidth outside the frequency band in which the spread spectrum or digitally modulated intentional radiator is operating, the radio frequency power that is produced by the intentional radiator shall be at least 20 dB below that in the 100 kHz bandwidth within the band that contains the highest level of the desired power, based on either an RF conducted or a radiated measurement. Attenuation below the general limits specified in Section 15.209(a) is not required. In addition, radiated emissions which fall in the restricted bands, as defined in §15.205(a), must also comply with the radiated emission limits specified in §15.209(a) (see §15.205(c)).		
§15.209		
Frequency (MHz)	Field strength (dBµV/m)	Measurement distance
30 - 88	30.0	10
88 – 216	33.5	10
216 – 960	36.0	10
Above 960	54.0	3



**Plots:** Transmit mode

**Plot 1:** 30 MHz to 1 GHz, TX mode, 2402 MHz, vertical & horizontal polarization

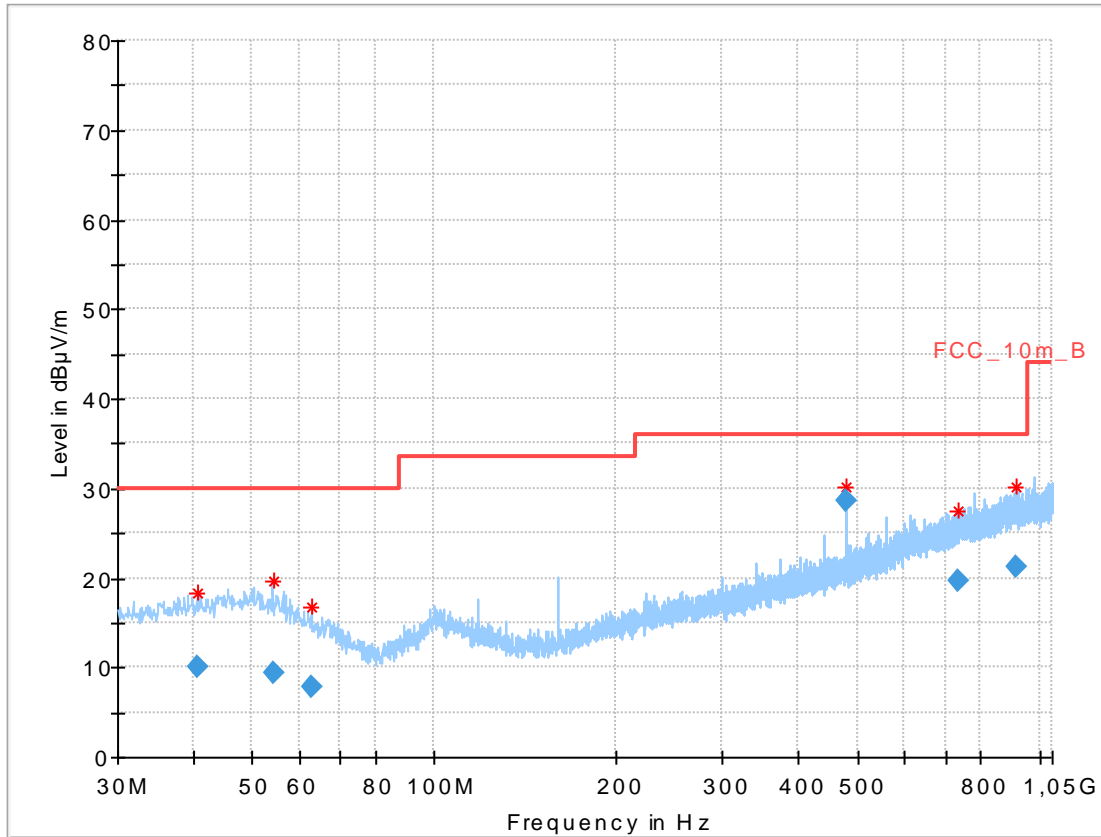

**Final results:**

Frequency (MHz)	QuasiPeak (dBµV/m)	Limit (dBµV/m)	Margin (dB)	Meas. Time (ms)	Bandwidth (kHz)	Height (cm)	Pol	Azimuth (deg)	Corr. (dB)
40.763400	10.06	30.00	19.94	1000.0	120.000	101.0	V	190.0	13.3
54.391800	9.36	30.00	20.64	1000.0	120.000	100.0	V	0.0	13.2
62.653650	7.89	30.00	22.11	1000.0	120.000	101.0	V	0.0	11.3
480.009900	28.53	36.00	7.47	1000.0	120.000	185.0	H	0.0	18.3
734.805600	19.63	36.00	16.37	1000.0	120.000	100.0	V	336.0	22.4
918.632250	21.23	36.00	14.77	1000.0	120.000	178.0	V	336.0	24.2

**Plot 2:** 30 MHz to 1 GHz, TX mode, 2440 MHz, vertical & horizontal polarization

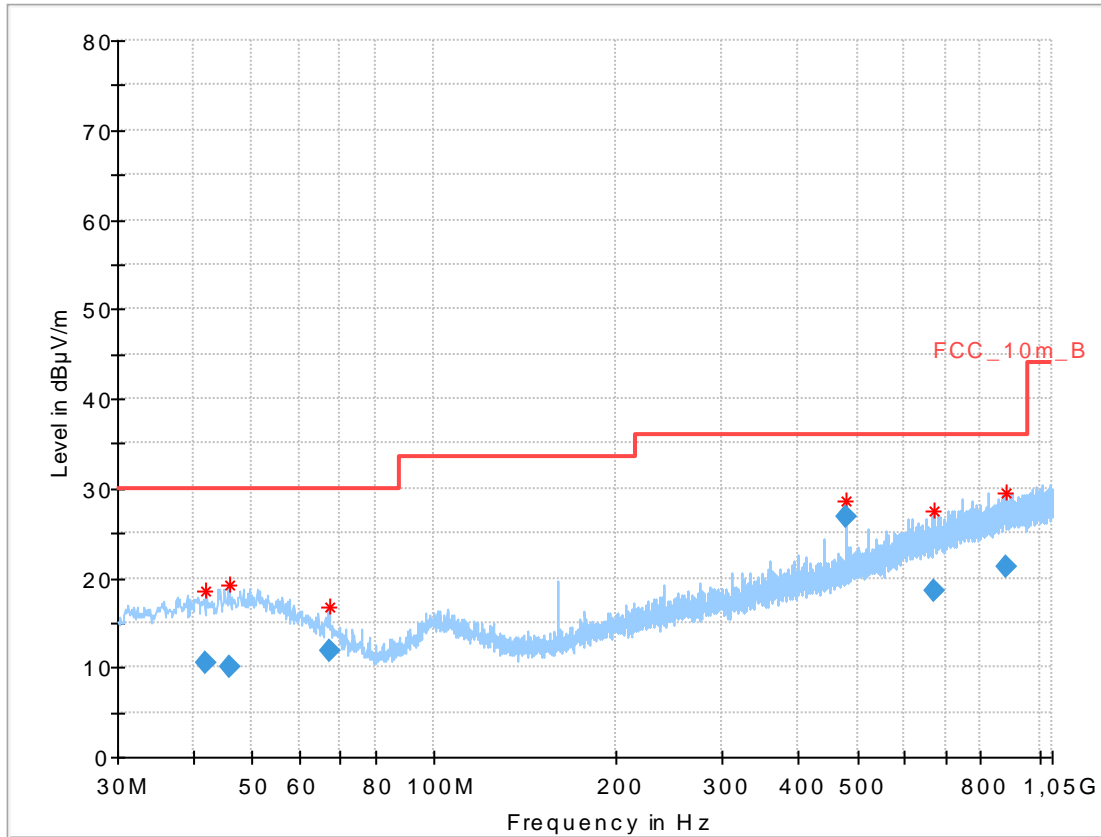

**Final results:**

Frequency (MHz)	QuasiPeak (dBµV/m)	Limit (dBµV/m)	Margin (dB)	Meas. Time (ms)	Bandwidth (kHz)	Height (cm)	Pol	Azimuth (deg)	Corr. (dB)
42.003750	10.49	30.00	19.51	1000.0	120.000	100.0	V	353.0	13.4
46.099500	10.10	30.00	19.90	1000.0	120.000	98.0	H	0.0	13.7
67.079700	11.93	30.00	18.07	1000.0	120.000	185.0	V	150.0	10.3
479.991000	26.76	36.00	9.24	1000.0	120.000	101.0	H	0.0	18.3
670.720200	18.51	36.00	17.49	1000.0	120.000	185.0	H	0.0	21.3
882.681600	21.14	36.00	14.86	1000.0	120.000	185.0	H	245.0	24.0

**Plot 3:** 30 MHz to 1 GHz, TX mode, 2480 MHz, vertical & horizontal polarization

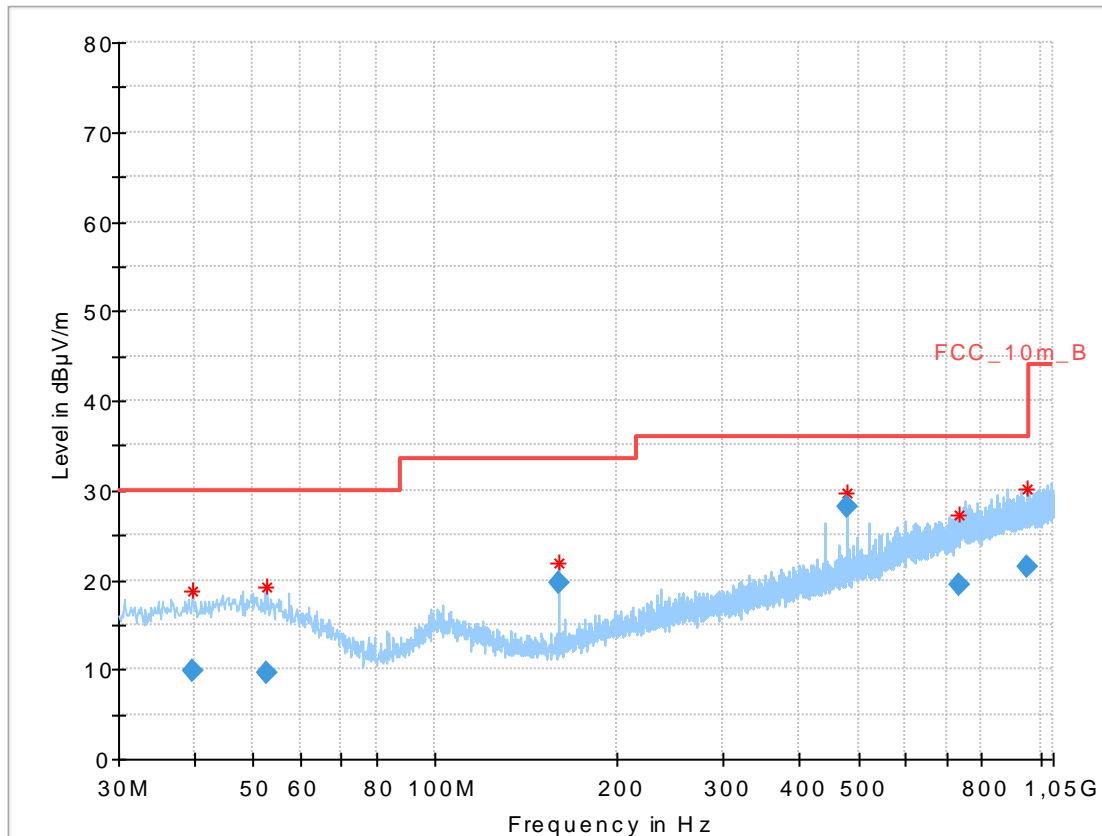

**Final results:**

Frequency (MHz)	QuasiPeak (dBµV/m)	Limit (dBµV/m)	Margin (dB)	Meas. Time (ms)	Bandwidth (kHz)	Height (cm)	Pol	Azimuth (deg)	Corr. (dB)
39.760350	9.91	30.00	20.09	1000.0	120.000	101.0	V	67.0	13.2
52.620450	9.59	30.00	20.41	1000.0	120.000	101.0	V	263.0	13.4
159.993600	19.59	33.50	13.91	1000.0	120.000	98.0	V	28.0	9.7
480.000900	28.05	36.00	7.95	1000.0	120.000	100.0	H	0.0	18.3
731.909850	19.48	36.00	16.52	1000.0	120.000	101.0	H	154.0	22.3
948.826650	21.41	36.00	14.59	1000.0	120.000	185.0	H	136.0	24.3

**Plots:** Receiver mode

**Plot 1:** 30 MHz to 1 GHz, RX / idle – mode, vertical & horizontal polarization

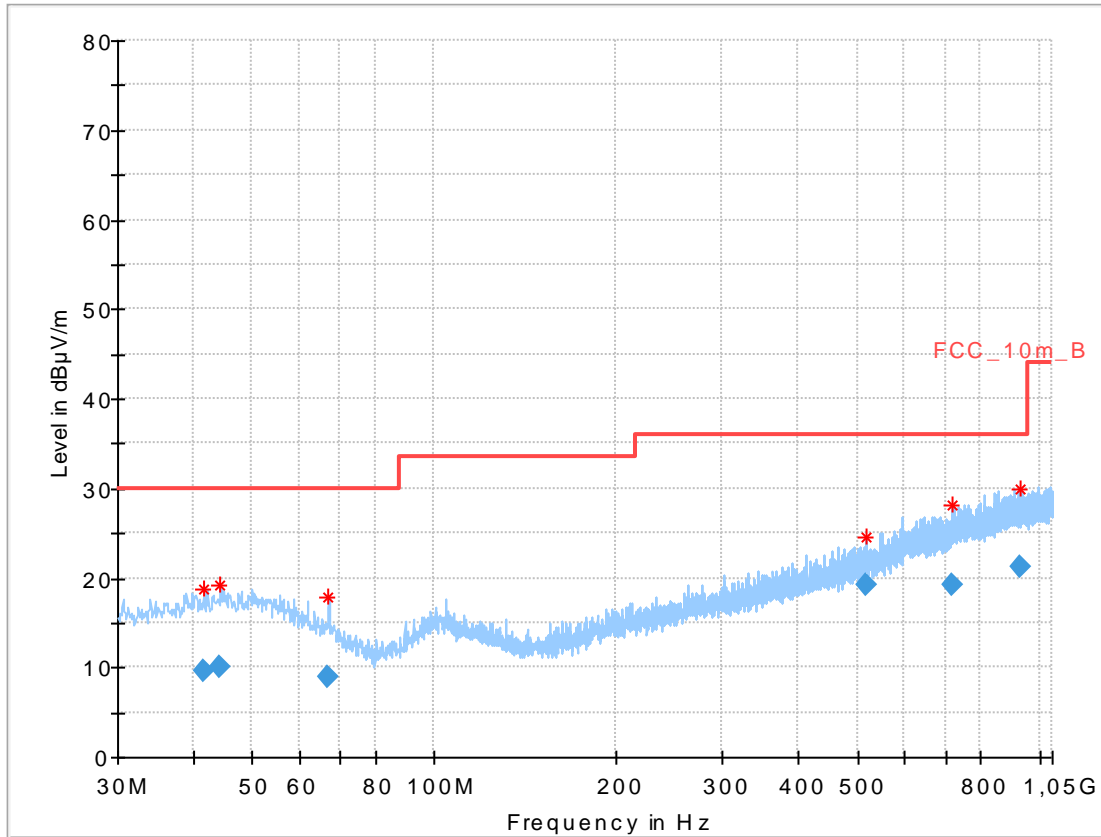

**Final results:**

Frequency (MHz)	QuasiPeak (dBµV/m)	Limit (dBµV/m)	Margin (dB)	Meas. Time (ms)	Bandwidth (kHz)	Height (cm)	Pol	Azimuth (deg)	Corr. (dB)
41.550900	9.64	30.00	20.36	1000.0	120.000	98.0	H	248.0	13.3
44.146500	10.14	30.00	19.86	1000.0	120.000	101.0	V	255.0	13.6
66.742350	9.01	30.00	20.99	1000.0	120.000	101.0	H	8.0	10.4
515.389200	19.28	36.00	16.72	1000.0	120.000	178.0	V	230.0	18.9
719.354100	19.27	36.00	16.73	1000.0	120.000	185.0	V	300.0	22.0
928.433550	21.23	36.00	14.77	1000.0	120.000	185.0	H	353.0	24.3

**11.11 Spurious emissions radiated above 1 GHz**

**Description:**

Measurement of the radiated spurious emissions in transmit mode. The EUT is set to single channel mode and the transmit frequencies are 2402 MHz, 2440 MHz and 2480 MHz. The measurement is performed in the mode with the highest output power.

Measurement parameters	
Detector	Peak / RMS
Sweep time	Auto
Resolution bandwidth	1 MHz
Video bandwidth	3 x RBW
Span	1 GHz to 26 GHz
Trace mode	Max hold
Measured modulation	GFSK
Test setup	See sub clause 6.2 A (1 GHz - 18 GHz) See sub clause 6.3 A (18 GHz - 26 GHz)
Measurement uncertainty	See sub clause 8

The modulation with the highest output power was used to perform the transmitter spurious emissions. If spurious were detected a re-measurement was performed on the detected frequency with each modulation.

**Limits:**

FCC		IC	
TX spurious emissions radiated			
In any 100 kHz bandwidth outside the frequency band in which the spread spectrum or digitally modulated intentional radiator is operating, the radio frequency power that is produced by the intentional radiator shall be at least 20 dB below that in the 100 kHz bandwidth within the band that contains the highest level of the desired power, based on either an RF conducted or a radiated measurement. Attenuation below the general limits specified in Section 15.209(a) is not required. In addition, radiated emissions which fall in the restricted bands, as defined in §15.205(a), must also comply with the radiated emission limits specified in §15.209(a) (see §15.205(c)).			
§15.209			
Frequency (MHz)	Field strength (dBµV/m)	Measurement distance	
Above 960	54.0 (Average)	3	
Above 960	74.0 (Peak)	3	

**Results:** Transmitter mode

TX spurious emissions radiated [dBµV/m]								
2402 MHz			2440 MHz			2480 MHz		
F [MHz]	Detector	Level [dBµV/m]	F [MHz]	Detector	Level [dBµV/m]	F [MHz]	Detector	Level [dBµV/m]
2376.8	Peak	55.9	All detected emissions are more than 20 dB below the limit.					
	AVG	35.7						
	Peak			Peak			Peak	
	AVG			AVG			AVG	
	Peak			Peak			Peak	
	AVG			AVG			AVG	

For radiated spurious emission the limits of 15.209 apply for all frequencies mentioned in 15.205. According to FCC Public Notice DA 00-705 (ANSI C63.10) the average emission shall be determined by using Video averaging (VBW = 10 Hz). If the dwell time of the hopping signal is less than 100 ms (per channel), the VBW=10 Hz reading may be adjusted by a factor:

$$F = 20 * \log(\text{dwell time}^* / 100 \text{ ms})$$

\*with TXon time as dwell time!

Bluetooth LE connected mode: Duty Cycle correction Scenarios

Tx payload bytes	Tx dwell time [ms]	Txon time [ms]	Rx dwell time min [ms]	No of TX within 100 ms 100ms/(TxDwell + RxDwell)	min no of hopping channels (AFH)	max TX time [ms]/channel within 100ms	DC correction F [dB]	Scenario
37	0.625	0.376	0.625	80.0	2	15	-16.46	TX Packet. Rx =ACK
224	1.875	1.875	0.625	40.0	2	38	-8.52	TX Packet. Rx =ACK (worst case)
255	2.500	2.120	0.625	32.0	2	34	-9.39	TX Packet. Rx =ACK
37	0.625	0.376	0.625	80.0	2	15	-16.46	TX Packet = RX Packet
255	2.500	2.120	2.500	20.0	2	21	-13.47	TX Packet = RX Packet

Note: For BT LE the dwell time is a multiple of 0.625ms

Bluetooth LE Advertising mode:

Advertising is always in none Hopping mode.

A Bluetooth LE packet in advertising mode consists of:

- Preamble (1 Byte)
- Access Address (4 Bytes):always: 0x8E89BED6
- PDU Header (2 Bytes)
- PDU MAC address (6 Bytes)
- PDU Data (0-31 Bytes) (connected undirected advertising (ADV\_IND))
- CRC (3 Bytes)

The maximum size of a complete advertising packet is 47 Bytes (376us)  
 Minimum possible advertising interval (per advertising channel): 20 ms  
 Duty cycle within 100ms:  $5 * 0.376 \text{ms} / 100 \text{ms} = 0.0188 = 1.88\%$   
 Correction factor for average calculation:

$$F = 20 * \log(0.0188) = -34.51 \text{dB}$$

**Results:** Receiver mode

RX spurious emissions radiated [dBµV/m]		
F [MHz]	Detector	Level [dBµV/m]
All detected emissions are more than 20 dB below the limit.		
-/-	Peak	
	AVG	

**Note:** The limit was recalculated with 20 dB / decade (Part 15.31) for all radiated spurious emissions 30 MHz to 1 GHz from 3 meter limit to a 10 meter distance. (40dB/decade for emissions < 30MHz)

**Plots:** Transmitter mode

**Plot 1:** 1 GHz to 18 GHz, TX mode, 2402 MHz, vertical & horizontal polarization

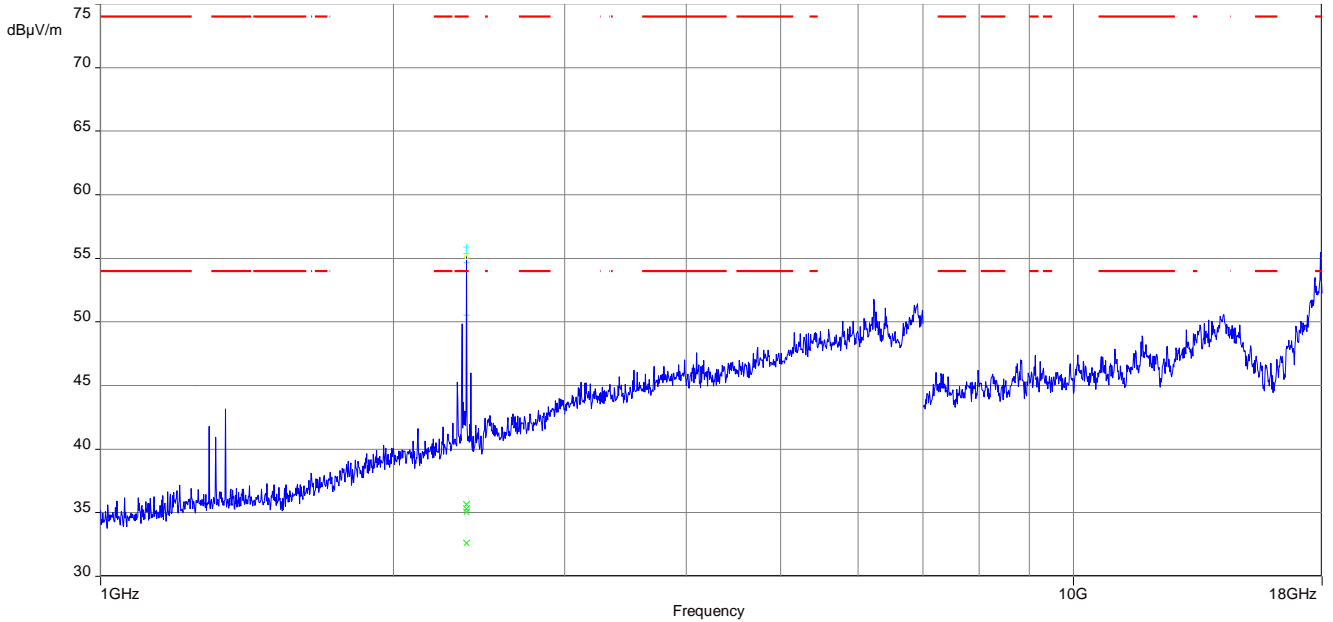

The carrier signal is notched with a 2.4 GHz band rejection filter.

**Plot 2:** 18 GHz to 26 GHz, TX mode, 2402 MHz, vertical & horizontal polarization

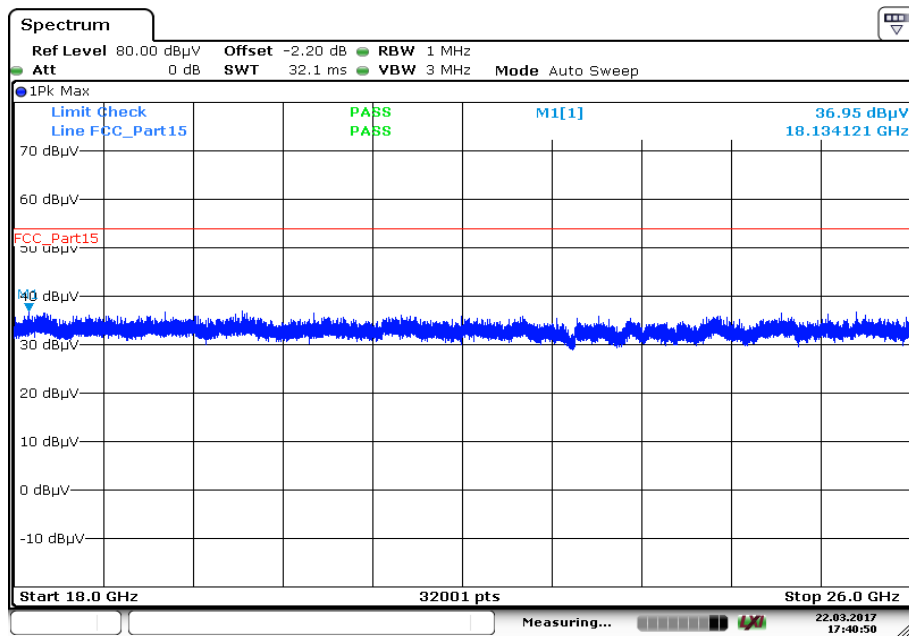

Date: 22.MAR.2017 17:40:50



**Plot 3:** 1 GHz to 18 GHz, TX mode, 2440 MHz, vertical & horizontal polarization

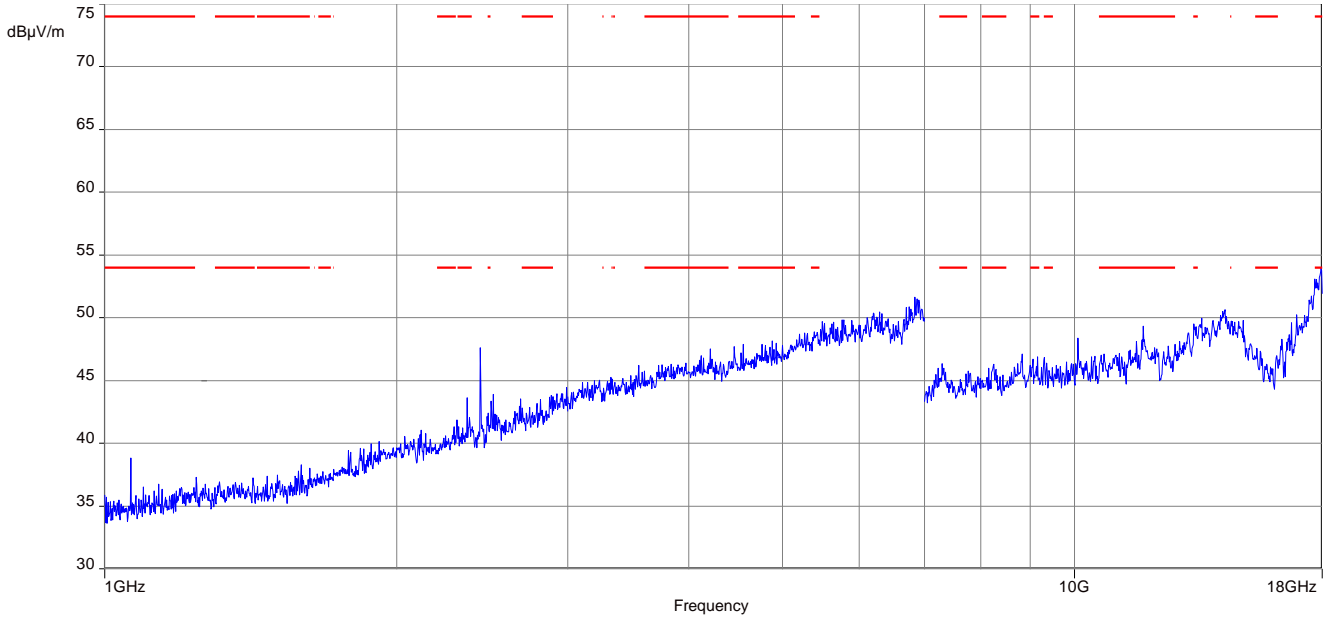

The carrier signal is notched with a 2.4 GHz band rejection filter.

**Plot 4:** 18 GHz to 26 GHz, TX mode, 2440 MHz, vertical & horizontal polarization

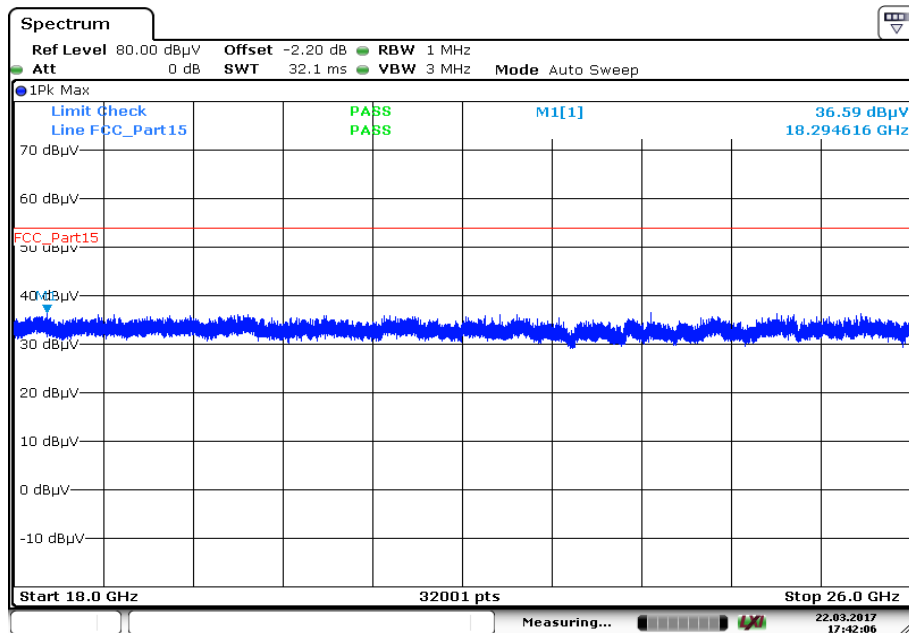

**Plot 5:** 1 GHz to 18 GHz, TX mode, 2480 MHz, vertical & horizontal polarization

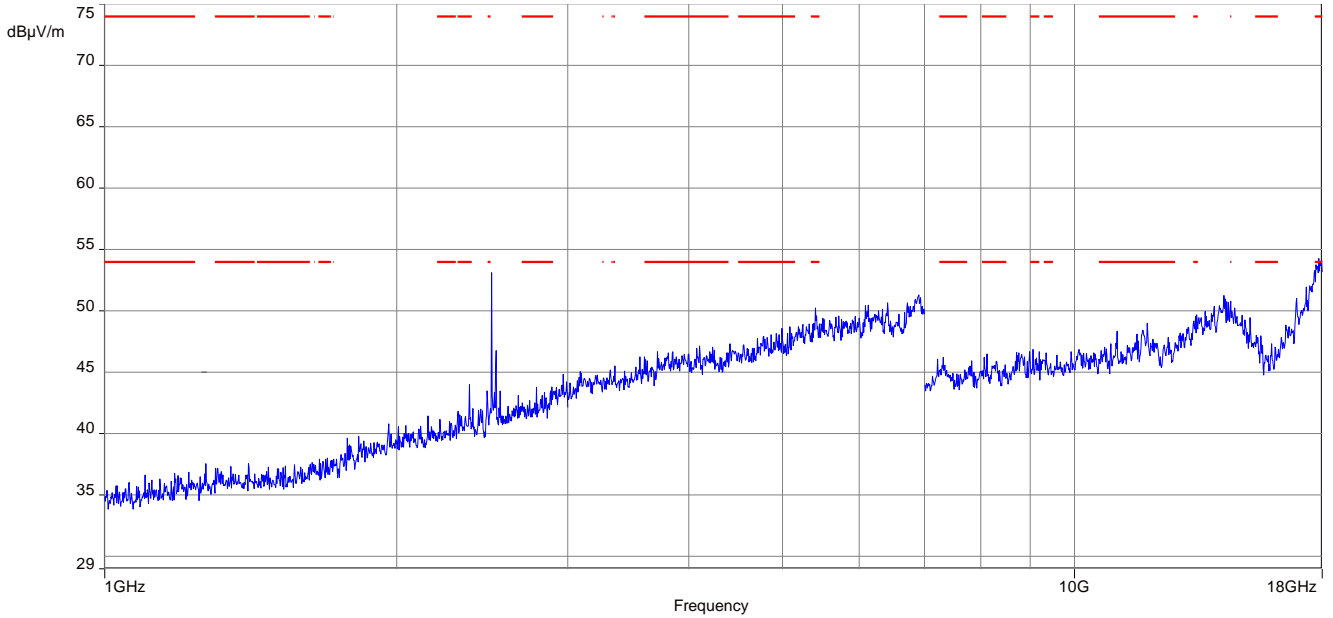

The carrier signal is notched with a 2.4 GHz band rejection filter.

**Plot 6:** 18 GHz to 26 GHz, TX mode, 2480 MHz, vertical & horizontal polarization

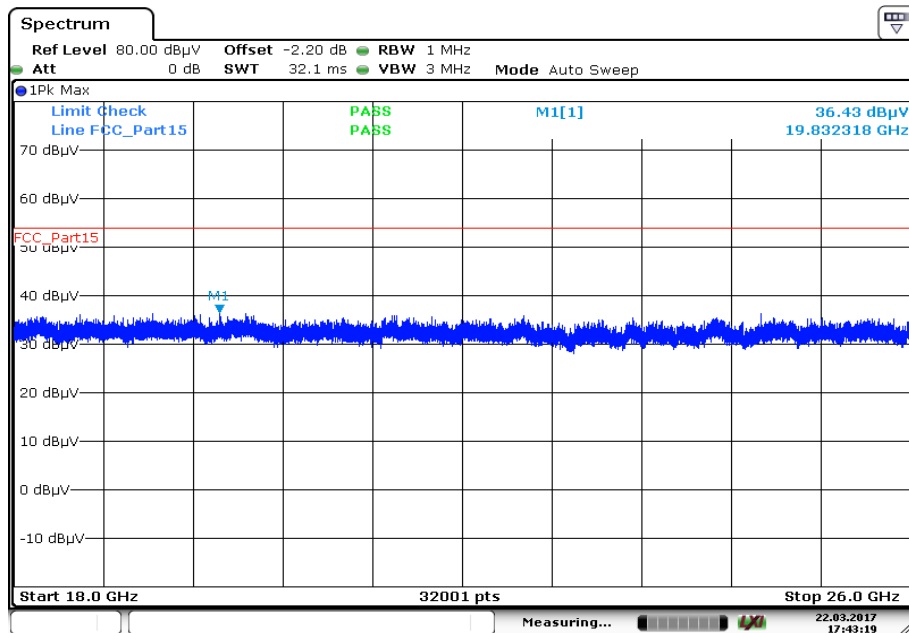

Date: 22.MAR.2017 17:43:18

**Plots:** Receiver mode

**Plot 1:** 1 GHz to 18 GHz, RX / idle – mode, vertical & horizontal polarization

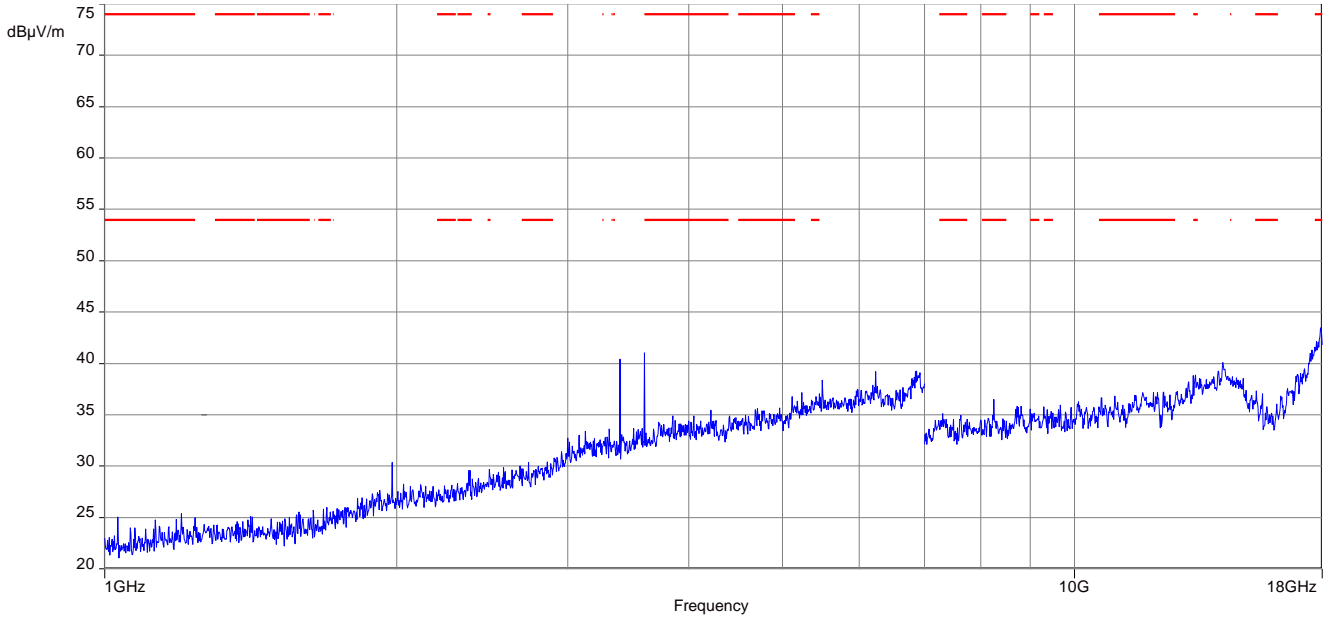

**Plot 2:** 18 GHz to 26 GHz, RX / idle – mode, vertical & horizontal polarization

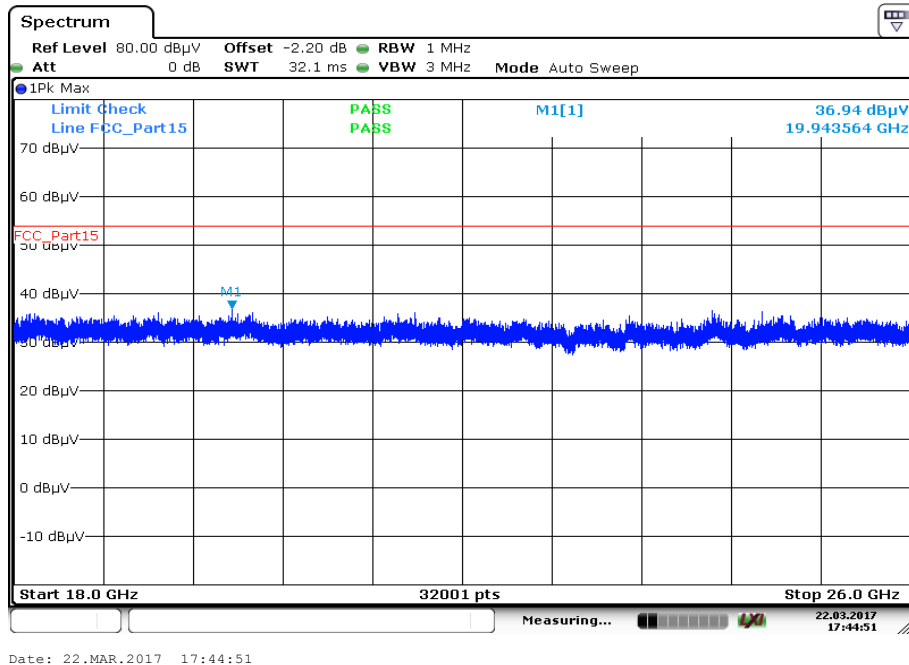

**11.12 Spurious emissions conducted below 30 MHz (AC conducted)**

**Description:**

Measurement of the conducted spurious emissions in transmit mode below 30 MHz. The EUT is set to single channel mode and the transmit frequency is 2440 MHz. This measurement is representative for all channels and modes. If critical peaks are found frequency 2402 MHz and 2480 MHz will be measured too. The measurement is performed in the mode with the highest output power. Both power lines, phase and neutral line, are measured. Found peaks are remeasured with average and quasi peak detection to show compliance to the limits.

Measurement parameters	
Detector	Peak - Quasi peak / average
Sweep time	Auto
Resolution bandwidth	F < 150 kHz: 200 Hz F > 150 kHz: 9 kHz
Video bandwidth	F < 150 kHz: 1 kHz F > 150 kHz: 100 kHz
Span:	9 kHz to 30 MHz
Trace mode:	Max hold
Test setup	See sub clause 6.5. A
Measurement uncertainty	See sub clause 8

**Limits:**

FCC		IC	
TX spurious emissions conducted < 30 MHz			
Frequency (MHz)	Quasi-peak (dBµV/m)	Average (dBµV/m)	
0.15 – 0.5	66 to 56*	56 to 46*	
0.5 – 5	56	46	
5 – 30.0	60	50	

\*Decreases with the logarithm of the frequency

**Results:**

Spurious emissions conducted < 30 MHz [dBµV/m]		
F [MHz]	Detector	Level [dBµV/m]
No emissions detected		

**Plots:**

**Plot 1:** 150 kHz to 30 MHz, phase line

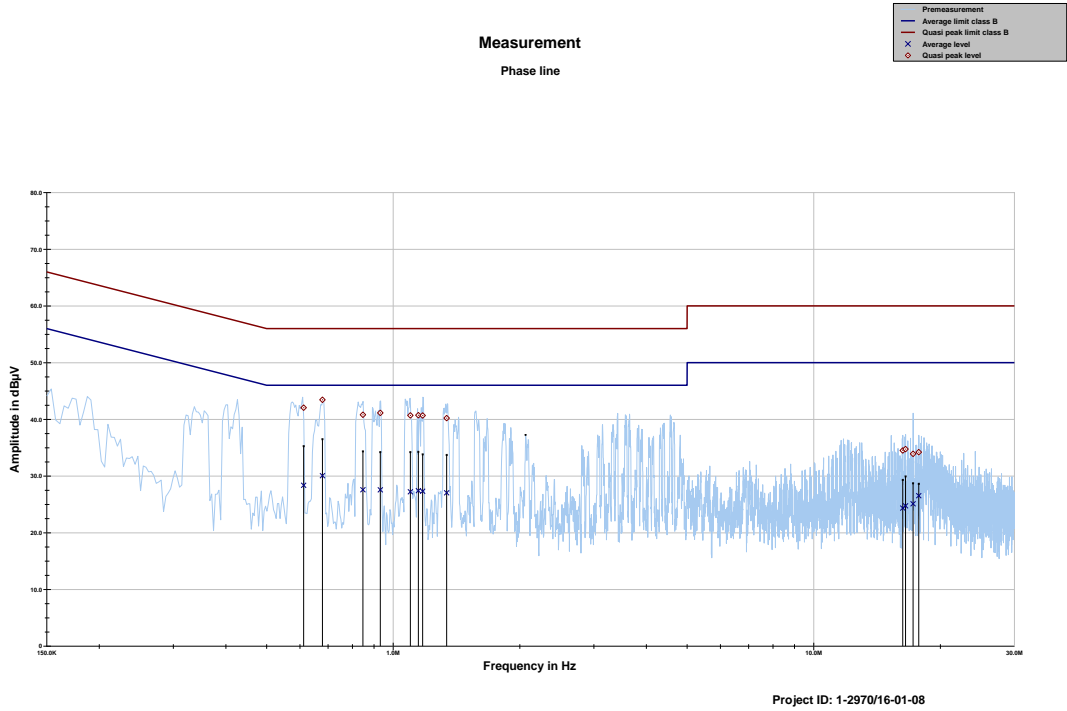

Frequency	Quasi peak level	Margin quasi peak	Limit QP	Average level	Margin average	Limit AV
MHz	dBµV	dB	dBµV	dBµV	dB	dBµV
0.612466	42.04	13.96	56.000	28.36	17.64	46.000
0.678829	43.44	12.56	56.000	30.06	15.94	46.000
0.847132	40.81	15.19	56.000	27.58	18.42	46.000
0.931748	41.14	14.86	56.000	27.56	18.44	46.000
1.098542	40.68	15.32	56.000	27.22	18.78	46.000
1.147725	40.73	15.27	56.000	27.41	18.59	46.000
1.174775	40.68	15.32	56.000	27.32	18.68	46.000
1.339907	40.21	15.79	56.000	27.03	18.97	46.000
16.282048	34.51	25.49	60.000	24.35	25.65	50.000
16.534299	34.75	25.25	60.000	24.73	25.27	50.000
17.230804	33.91	26.09	60.000	25.11	24.89	50.000
17.773301	34.21	25.79	60.000	26.52	23.48	50.000

Plot 2: 150 kHz to 30 MHz, neutral line

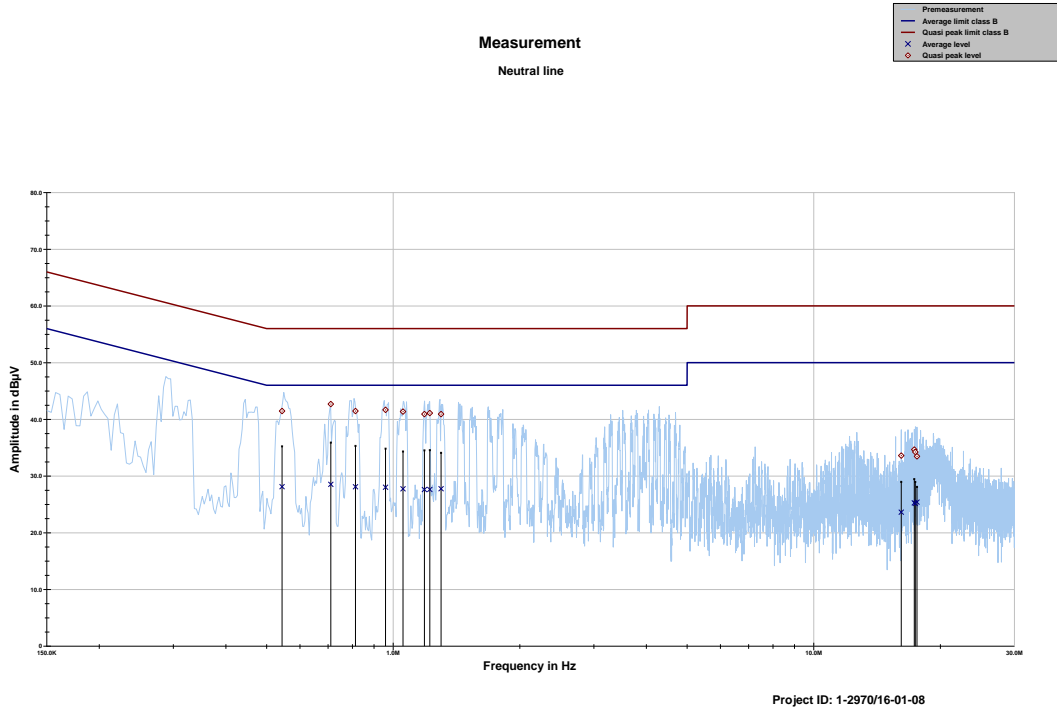

Frequency MHz	Quasi peak level dBµV	Margin quasi peak dB	Limit QP dBµV	Average level dBµV	Margin average dB	Limit AV dBµV
0.544159	41.47	14.53	56.000	28.11	17.89	46.000
0.710759	42.70	13.30	56.000	28.52	17.48	46.000
0.813534	41.45	14.55	56.000	28.11	17.89	46.000
0.959032	41.67	14.33	56.000	28.03	17.97	46.000
1.055167	41.35	14.65	56.000	27.74	18.26	46.000
1.186400	40.93	15.07	56.000	27.61	18.39	46.000
1.222142	41.10	14.90	56.000	27.63	18.37	46.000
1.299486	40.92	15.08	56.000	27.76	18.24	46.000
16.146618	33.61	26.39	60.000	23.63	26.37	50.000
17.343449	34.66	25.34	60.000	25.26	24.74	50.000
17.445771	34.24	25.76	60.000	25.17	24.83	50.000
17.605976	33.48	26.52	60.000	25.39	24.61	50.000

## 12 Observations

No observations except those reported with the single test cases have been made.

## Annex A Document history

Version	Applied changes	Date of release
	Initial release	2017-04-12

## Annex B Further information

### Glossary

AVG	- Average
DUT	- Device under test
EMC	- Electromagnetic Compatibility
EN	- European Standard
EUT	- Equipment under test
ETSI	- European Telecommunications Standard Institute
FCC	- Federal Communication Commission
FCC ID	- Company Identifier at FCC
HW	- Hardware
IC	- Industry Canada
Inv. No.	- Inventory number
N/A	- Not applicable
PP	- Positive peak
QP	- Quasi peak
S/N	- Serial number
SW	- Software
PMN	- Product marketing name
HMN	- Host marketing name
HVIN	- Hardware version identification number
FVIN	- Firmware version identification number
OBW	Occupied Bandwidth
OC	Operating Channel
OCW	Operating Channel Bandwidth
OOB	Out Of Band

**Annex C Accreditation Certificate**

first page

last page



Deutsche Akkreditierungsstelle GmbH

Befehlens gemäß § 8 Absatz 1 AkkStelleG i.V.m. § 1 Absatz 1 AkkStelleGBV  
Unterschriftsmitglied der Multilateralen Abkommen  
von EA, ILAC und IAF zur gegenseitigen Anerkennung

**Akkreditierung**



Die Deutsche Akkreditierungsstelle GmbH bestätigt hiermit, dass das Prüflaboratorium

**CTC advanced GmbH**  
Untertürkheimer Straße 6-10, 66117 Saarbrücken

die Kompetenz nach DIN EN ISO/IEC 17025:2005 besitzt, Prüfungen in folgenden Bereichen durchzuführen:

- Funk
- Mobilfunk (GSM / DCS) + OTA
- Elektromagnetische Verträglichkeit (EMV)
- Produktsicherheit
- SAR / EMF
- Umwelt
- Smart Card Technology
- Bluetooth\*
- Automotive
- Wi-Fi-Services
- Kanadische Anforderungen
- US-Anforderungen
- Akustik
- Near Field Communication (NFC)

Die Akkreditierungsurkunde gilt nur in Verbindung mit dem Bescheid vom 25.11.2016 mit der Akkreditierungsnummer D-PL-12076-01 und ist gültig bis 17.01.2018. Sie besteht aus diesem Deckblatt, der Rückseite des Deckblatts und der folgenden Anlage mit insgesamt 63 Seiten.

Registrierungsnummer der Urkunde: D-PL-12076-01-01

Frankfurt, 25.11.2016

Stelle Minister auf der Rückseite

Im Auftrag Dipl.-Ing. (FH) Ralf Egner  
Abteilungsleiter

Deutsche Akkreditierungsstelle GmbH

Standort Berlin  
Spittelmarkt 10  
10117 Berlin

Standort Frankfurt am Main  
Europa-Allee 52  
60327 Frankfurt am Main

Standort Braunschweig  
Bundesallee 100  
38116 Braunschweig

Die auszugsweise Veröffentlichung der Akkreditierungsurkunde bedarf der vorherigen schriftlichen Zustimmung der Deutsche Akkreditierungsstelle GmbH (DAkkS). Ausgenommen davon ist die separate Weiterverbreitung des Deckblatts durch die umseitig genannte Konformitätsbewertungsstelle in unveränderter Form.

Es darf nicht der Anschein erweckt werden, dass sich die Akkreditierung auch auf Bereiche erstreckt, die über den durch die DAkkS bestätigten Akkreditierungsbereich hinausgehen.

Die Akkreditierung erfolgte gemäß des Gesetzes über die Akkreditierungsstelle (AkkStelleG) vom 31. Juli 2009 (BGBl. I S. 2625) sowie der Verordnung (EG) Nr. 765/2008 des Europäischen Parlaments und des Rates vom 9. Juli 2008 über die Vorschriften für die Akkreditierung und Marktüberwachung im Zusammenhang mit der Vermarktung von Produkten (Abi. L 218 vom 9. Juli 2008, S. 30). Die DAkkS ist Unterzeichnerin der Multilateralen Abkommen zur gegenseitigen Anerkennung der European co-operation for Accreditation (EA), des International Accreditation Forum (IAF) und der International Laboratory Accreditation Cooperation (ILAC). Die Unterzeichner dieser Abkommen erkennen ihre Akkreditierungen gegenseitig an.

Der aktuelle Stand der Mitgliedschaft kann folgenden Webseiten entnommen werden:  
EA: [www.european-accrreditation.org](http://www.european-accrreditation.org)  
ILAC: [www.ilac.org](http://www.ilac.org)  
IAF: [www.iaf.nu](http://www.iaf.nu)

**Note:**  
The current certificate including annex can be received on request.