

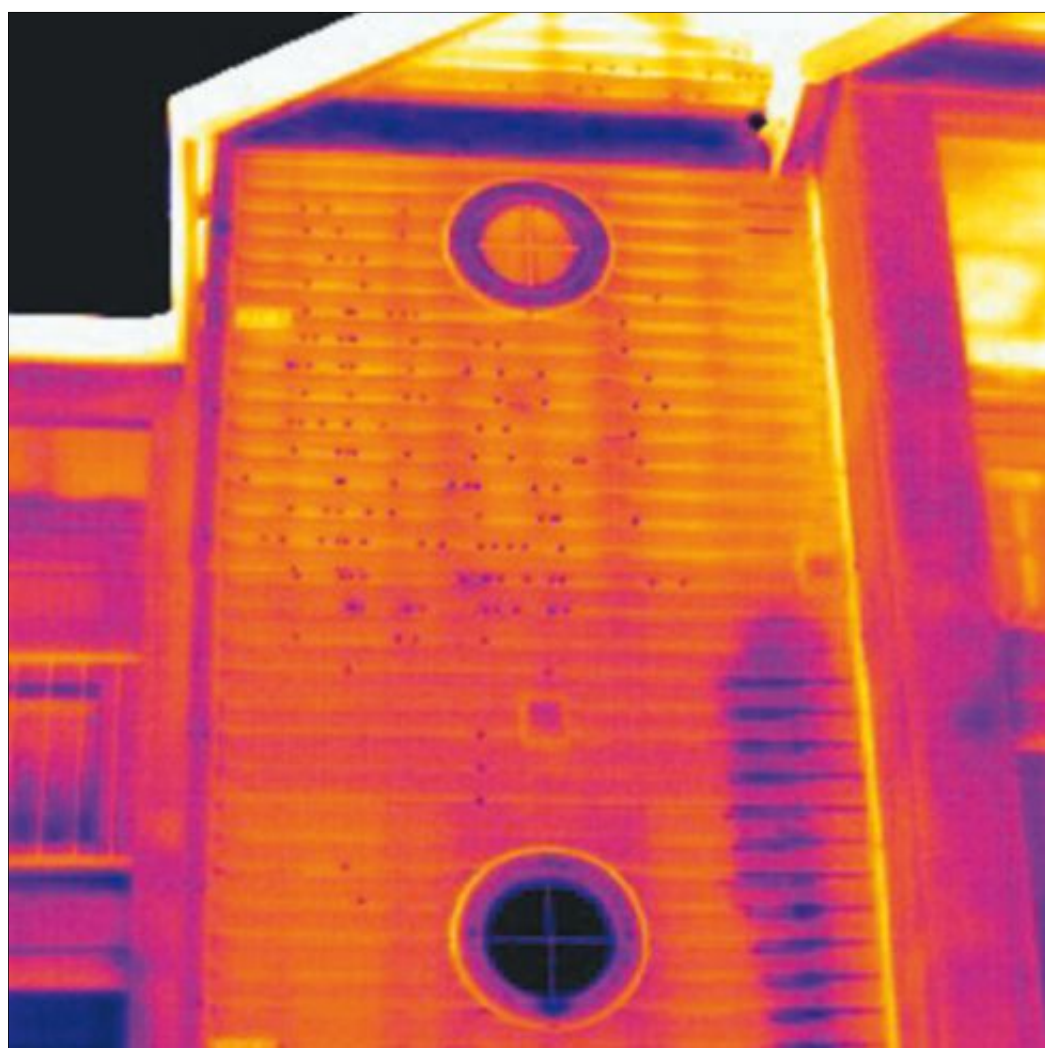

---

# User's manual

## Flir T4xx series







---

# User's manual

## Flir T4xx series





# Table of contents

---

<b>1</b>	<b>Legal disclaimer</b> .....	<b>1</b>
1.1	Legal disclaimer .....	1
1.2	U.S. Government Regulations .....	1
1.3	Copyright .....	1
1.4	Quality assurance .....	2
1.5	Patents .....	2
1.6	EULA Terms .....	2
<b>2</b>	<b>Warnings &amp; Cautions</b> .....	<b>4</b>
<b>3</b>	<b>Notice to user</b> .....	<b>8</b>
3.1	User-to-user forums .....	8
3.2	Calibration .....	8
3.3	Accuracy .....	8
3.4	Disposal of electronic waste .....	8
3.5	Training .....	8
3.6	Documentation updates .....	8
3.7	Important note about this manual .....	8
<b>4</b>	<b>Customer help</b> .....	<b>9</b>
4.1	General .....	9
4.2	Submitting a question .....	9
4.3	Downloads .....	9
<b>5</b>	<b>Quick Start Guide</b> .....	<b>10</b>
5.1	Procedure .....	10
<b>6</b>	<b>Parts lists</b> .....	<b>11</b>
6.1	Contents of the transport case .....	11
6.2	List of accessories and services .....	11
<b>7</b>	<b>A note about ergonomics</b> .....	<b>14</b>
7.1	General .....	14
7.2	Figure .....	14
<b>8</b>	<b>Camera parts</b> .....	<b>15</b>
8.1	Rear view .....	15
8.1.1	Figure .....	15
8.1.2	Explanation .....	15
8.2	Front view .....	16
8.2.1	Figure .....	16
8.2.2	Explanation .....	16
8.3	Bottom view .....	17
8.3.1	Figure .....	17
8.3.2	Explanation .....	17
8.4	Battery condition indicator .....	18
8.4.1	Figure .....	18
8.4.2	Explanation .....	18
8.5	Laser pointer .....	19
8.5.1	Figure .....	19
8.5.2	Laser warning label .....	19
8.5.3	Laser rules and regulations .....	19
<b>9</b>	<b>Screen elements</b> .....	<b>20</b>
9.1	Figure .....	20
9.2	Explanation .....	20
<b>10</b>	<b>Navigating the menu system</b> .....	<b>21</b>
10.1	Figure .....	21
10.2	Explanation .....	21
<b>11</b>	<b>External devices and storage media</b> .....	<b>22</b>
11.1	Figure .....	22

## Table of contents

---

11.2	Explanation .....	22
<b>12</b>	<b>Pairing Bluetooth devices .....</b>	<b>23</b>
12.1	General .....	23
12.2	Procedure .....	23
<b>13</b>	<b>Configuring Wi-Fi.....</b>	<b>24</b>
13.1	General .....	24
13.2	Setting up a peer-to-peer connection (most common use) .....	24
13.3	Connecting the camera to a wireless local area network (less common use) .....	24
<b>14</b>	<b>Fetching data from external Extech meters .....</b>	<b>25</b>
14.1	General .....	25
14.2	Figure.....	25
14.3	Supported Extech meters .....	25
14.4	Technical support for Extech meters .....	25
14.5	Procedure .....	25
14.6	Typical moisture measurement and documentation procedure .....	26
14.6.1	General.....	26
14.6.2	Procedure.....	26
<b>15</b>	<b>Handling the camera .....</b>	<b>27</b>
15.1	Charging the battery .....	27
15.1.1	General.....	27
15.1.2	Using the combined power supply and battery charger to charge the battery when it is inside the camera .....	27
15.1.3	Using the combined power supply and battery charger to charge the battery when it is outside the camera.....	27
15.1.4	Using the stand-alone battery charger to charge the battery .....	28
15.2	Inserting the battery .....	28
15.2.1	Procedure.....	28
15.3	Removing the battery .....	29
15.3.1	Procedure.....	29
15.4	Turning on and turning off the camera .....	30
15.5	Adjusting the angle of lens .....	30
15.5.1	Figure.....	30
15.5.2	Procedure.....	30
15.6	Mounting an additional lens .....	30
15.6.1	Procedure.....	30
15.7	Removing an additional infrared lens .....	32
15.7.1	Procedure.....	32
15.8	Attaching the sunshield .....	34
15.8.1	Procedure.....	34
15.9	Using the laser pointer .....	35
15.9.1	Figure.....	35
15.9.2	Procedure.....	35
15.10	Calibrating the compass .....	35
15.10.1	Figure .....	35
15.10.2	Procedure.....	35
15.11	Calibrating the touchscreen LCD .....	36
15.11.1	Figure .....	36
15.11.2	Procedure.....	36
<b>16</b>	<b>Working with images and folders .....</b>	<b>37</b>
16.1	Adjusting the infrared camera focus.....	37
16.1.1	Procedure.....	37
16.2	Previewing an image.....	37

## Table of contents

---

16.3	General .....	37
16.3.1	Procedure.....	37
16.4	Saving an image .....	37
16.4.1	General.....	37
16.4.2	Formatting memory cards.....	37
16.4.3	Image capacity .....	37
16.4.4	Procedure.....	38
16.5	Periodically saving an image.....	38
16.5.1	General.....	38
16.5.2	Procedure.....	38
16.6	Opening an image.....	38
16.6.1	General.....	38
16.6.2	Procedure.....	38
16.7	Adjusting an image manually .....	38
16.7.1	General.....	38
16.7.2	Example 1 .....	39
16.7.3	Example 2 .....	39
16.7.4	Changing the temperature scale level.....	39
16.7.5	Changing the temperature scale span .....	40
16.8	Hiding overlay graphics .....	40
16.8.1	General.....	40
16.8.2	Procedure.....	40
16.9	Deleting images.....	40
16.9.1	General.....	40
16.9.2	Procedure.....	40
16.10	Creating an Adobe PDF report .....	40
16.10.1	General.....	40
16.10.2	Procedure.....	40
<b>17</b>	<b>Working with fusion .....</b>	<b>42</b>
17.1	What is picture-in-picture?.....	42
17.2	What is thermal fusion? .....	42
17.3	Types .....	42
17.4	Image examples .....	42
17.5	Procedure .....	44
<b>18</b>	<b>Working with video .....</b>	<b>46</b>
18.1	Recording video clips.....	46
18.1.1	General.....	46
18.1.2	Procedure.....	46
<b>19</b>	<b>Working with measurement tools and isotherms.....</b>	<b>47</b>
19.1	Setting up measurement tools.....	47
19.1.1	General.....	47
19.1.2	Procedure.....	47
19.2	Setting up a difference calculation.....	47
19.2.1	General.....	47
19.2.2	Procedure.....	47
19.3	Setting up isotherms .....	47
19.3.1	General.....	47
19.3.2	Setting up a high-temperature isotherm .....	48
19.3.3	Setting up a low-temperature isotherm .....	48
19.3.4	Setting up an interval isotherm.....	48
19.3.5	Setting up a humidity isotherm.....	48
19.3.6	Setting up an insulation isotherm.....	49
19.4	Working with presets.....	49
19.4.1	General.....	49
19.4.2	Procedure.....	49

## Table of contents

---

19.5	Removing measurement tools.....	49
19.5.1	Procedure.....	49
19.6	Moving measurement tools .....	50
19.6.1	Procedure.....	50
19.7	Resizing areas .....	50
19.7.1	Procedure.....	50
19.8	Changing object parameters.....	50
19.8.1	General.....	50
19.8.2	Types of parameters.....	50
19.8.3	Recommended values.....	50
19.8.4	Procedure.....	51
<b>20</b>	<b>Annotating images.....</b>	<b>52</b>
20.1	General .....	52
20.2	Adding a digital photo automatically.....	52
20.2.1	General.....	52
20.2.2	Procedure.....	52
20.3	Adding a digital photo manually.....	52
20.3.1	General.....	52
20.3.2	Procedure.....	52
20.4	Creating a voice annotation .....	52
20.4.1	General.....	52
20.4.2	Procedure.....	53
20.5	Creating a text.....	53
20.5.1	General.....	53
20.5.2	Procedure.....	53
20.6	Creating a table .....	54
20.6.1	General.....	54
20.6.2	Definition of field and value .....	54
20.6.3	Procedure.....	55
20.7	Adding a sketch.....	56
20.7.1	General.....	56
20.7.2	Adding a separate sketch .....	56
20.7.3	Adding a sketch to an infrared image .....	57
20.7.4	Adding a sketch to a digital photo .....	57
<b>21</b>	<b>Programming the camera .....</b>	<b>58</b>
21.1	General .....	58
21.2	Procedure .....	58
<b>22</b>	<b>Changing settings .....</b>	<b>59</b>
22.1	Changing camera settings.....	59
22.1.1	General.....	59
22.1.2	Procedure.....	59
22.2	Changing preferences.....	59
22.2.1	General.....	59
22.2.2	Procedure.....	59
22.3	Changing connectivity.....	59
22.3.1	General.....	59
22.3.2	Procedure.....	60
22.4	Changing regional settings.....	60
22.4.1	General.....	60
22.4.2	Procedure.....	60
<b>23</b>	<b>Cleaning the camera .....</b>	<b>61</b>
23.1	Camera housing, cables, and other items .....	61
23.1.1	Liquids.....	61
23.1.2	Equipment.....	61
23.1.3	Procedure.....	61



## Table of contents

---

23.2	Infrared lens.....	61
23.2.1	Liquids.....	61
23.2.2	Equipment.....	61
23.2.3	Procedure.....	61
<b>24</b>	<b>Technical data .....</b>	<b>62</b>
<b>25</b>	<b>Pin configurations .....</b>	<b>63</b>
25.1	Pin configuration for USB Mini-B connector.....	63
25.2	Pin configuration for video connector.....	63
25.3	Pin configuration for USB-A connector.....	64
25.4	Pin configuration for power connector.....	64
<b>26</b>	<b>Dimensions.....</b>	<b>65</b>
26.1	Camera.....	65
26.1.1	Camera dimensions.....	65
26.1.2	Camera dimensions, continued.....	65
26.1.3	Camera dimensions, continued.....	66
26.1.4	Camera dimensions, continued (with 30 mm/15° lens).....	66
26.1.5	Camera dimensions, continued (with 10 mm/45° lens).....	66
26.2	Battery.....	67
26.2.1	Figure.....	67
26.3	Stand-alone battery charger.....	68
26.3.1	Figure.....	68
26.4	Stand-alone battery charger with the battery.....	69
26.4.1	Figure.....	69
26.5	Infrared lens (30 mm/15°).....	69
26.5.1	Figure.....	69
26.6	Infrared lens (10 mm/45°).....	70
26.6.1	Figure.....	70
<b>27</b>	<b>Application examples.....</b>	<b>71</b>
27.1	Moisture & water damage.....	71
27.1.1	General.....	71
27.1.2	Figure.....	71
27.2	Faulty contact in socket.....	71
27.2.1	General.....	71
27.2.2	Figure.....	71
27.3	Oxidized socket.....	72
27.3.1	General.....	72
27.3.2	Figure.....	72
27.4	Insulation deficiencies.....	73
27.4.1	General.....	73
27.4.2	Figure.....	73
27.5	Draft.....	74
27.5.1	General.....	74
27.5.2	Figure.....	74
<b>28</b>	<b>About Flir Systems.....</b>	<b>75</b>
28.1	More than just an infrared camera.....	76
28.2	Sharing our knowledge.....	76
28.3	Supporting our customers.....	76
28.4	A few images from our facilities.....	77
<b>29</b>	<b>Glossary.....</b>	<b>78</b>
<b>30</b>	<b>Thermographic measurement techniques.....</b>	<b>81</b>
30.1	Introduction.....	81
30.2	Emissivity.....	81

## Table of contents

---

	30.2.1 Finding the emissivity of a sample .....	81
	30.3 Reflected apparent temperature .....	84
	30.4 Distance .....	84
	30.5 Relative humidity.....	84
	30.6 Other parameters.....	84
<b>31</b>	<b>History of infrared technology .....</b>	<b>86</b>
<b>32</b>	<b>Theory of thermography .....</b>	<b>89</b>
	32.1 Introduction .....	89
	32.2 The electromagnetic spectrum .....	89
	32.3 Blackbody radiation .....	89
	32.3.1 Planck's law .....	90
	32.3.2 Wien's displacement law .....	91
	32.3.3 Stefan-Boltzmann's law.....	92
	32.3.4 Non-blackbody emitters .....	93
	32.4 Infrared semi-transparent materials .....	95
<b>33</b>	<b>The measurement formula .....</b>	<b>96</b>
<b>34</b>	<b>Emissivity tables .....</b>	<b>100</b>
	34.1 References.....	100
	34.2 Tables .....	100

## 1.1 Legal disclaimer

All products manufactured by Flir Systems are warranted against defective materials and workmanship for a period of one (1) year from the delivery date of the original purchase, provided such products have been under normal storage, use and service, and in accordance with Flir Systems instruction.

Uncooled handheld infrared cameras manufactured by Flir Systems are warranted against defective materials and workmanship for a period of two (2) years from the delivery date of the original purchase, provided such products have been under normal storage, use and service, and in accordance with Flir Systems instruction, and provided that the camera has been registered within 60 days of original purchase.

Detectors for uncooled handheld infrared cameras manufactured by Flir Systems are warranted against defective materials and workmanship for a period of ten (10) years from the delivery date of the original purchase, provided such products have been under normal storage, use and service, and in accordance with Flir Systems instruction, and provided that the camera has been registered within 60 days of original purchase.

Products which are not manufactured by Flir Systems but included in systems delivered by Flir Systems to the original purchaser, carry the warranty, if any, of the particular supplier only. Flir Systems has no responsibility whatsoever for such products.

The warranty extends only to the original purchaser and is not transferable. It is not applicable to any product which has been subjected to misuse, neglect, accident or abnormal conditions of operation. Expendable parts are excluded from the warranty.

In the case of a defect in a product covered by this warranty the product must not be further used in order to prevent additional damage. The purchaser shall promptly report any defect to Flir Systems or this warranty will not apply.

Flir Systems will, at its option, repair or replace any such defective product free of charge if, upon inspection, it proves to be defective in material or workmanship and provided that it is returned to Flir Systems within the said one-year period.

Flir Systems has no other obligation or liability for defects than those set forth above.

No other warranty is expressed or implied. Flir Systems specifically disclaims the implied warranties of merchantability and fitness for a particular purpose.

Flir Systems shall not be liable for any direct, indirect, special, incidental or consequential loss or damage, whether based on contract, tort or any other legal theory.

This warranty shall be governed by Swedish law.

Any dispute, controversy or claim arising out of or in connection with this warranty, shall be finally settled by arbitration in accordance with the Rules of the Arbitration Institute of the Stockholm Chamber of Commerce. The place of arbitration shall be Stockholm. The language to be used in the arbitral proceedings shall be English.

## 1.2 U.S. Government Regulations

The products described in the user documentation may require government authorization for export/re-export, or transfer. Contact Flir Systems for details.

## 1.3 Copyright

© 2012, Flir Systems. All rights reserved worldwide. No parts of the software including source code may be reproduced, transmitted, transcribed or translated into any language or computer language in any form or by any means, electronic, magnetic, optical, manual or otherwise, without the prior written permission of Flir Systems.

This documentation must not, in whole or part, be copied, photocopied, reproduced, translated or transmitted to any electronic medium or machine readable form without prior consent, in writing, from Flir Systems.

---

Names and marks appearing on the products herein are either registered trademarks or trademarks of Flir Systems and/or its subsidiaries. All other trademarks, trade names or company names referenced herein are used for identification only and are the property of their respective owners.

#### 1.4 Quality assurance

The Quality Management System under which these products are developed and manufactured has been certified in accordance with the ISO 9001 standard.

Flir Systems is committed to a policy of continuous development; therefore we reserve the right to make changes and improvements on any of the products described in this manual without prior notice.

#### 1.5 Patents

One or several of the following patents or design patents apply to the products and/or features described in this manual:

0002258-2; 000279476-0001; 000439161; 000499579-0001; 000653423; 000726344; 000859020; 001106306-0001; 001707738; 001707746; 001707787; 001776519; 0101577-5; 0102150-0; 1144833; 1182246; 1182620; 1285345; 1299699; 1325808; 1336775; 1391114; 1402918; 1404291; 1411581; 1415075; 1421497; 1678485; 1732314; 2106017; 3006596; 3006597; 466540; 483782; 484155; 4889913; 60122153.2; 602004011681.5-08; 6707044; 68657; 7034300; 7110035; 7154093; 7157705; 7237946; 7312822; 7332716; 7336823; 7544944; 75530; 7667198; 7809258; 7826736; 8,018,649 B2; 8,153,971; 8212210 B2; D540838; D549758; D579475; D584755; D599,392; DI6702302-9; DI6803572-1; DI6903617-9; DI7002221-6; DI7005799-0; DM/057692; DM/061609; ZL01823221.3; ZL01823226.4; ZL02331553.9; ZL02331554.7; ZL200480034894.0; ZL200530120994.2; ZL200610088759.5; ZL200630130114.4; ZL200730151141.4; ZL200730339504.7; ZL200820105768.8; ZL200830128581.2; ZL200880105769.2; ZL200930190061.9; ZL201030176127.1; ZL201030176130.3; ZL201030176157.2; ZL201030595931.3

#### 1.6 EULA Terms

- You have acquired a device (“INFRARED CAMERA”) that includes software licensed by Flir Systems AB from Microsoft Licensing, GP or its affiliates (“MS”). Those installed software products of MS origin, as well as associated media, printed materials, and “online” or electronic documentation (“SOFTWARE”) are protected by international intellectual property laws and treaties. The SOFTWARE is licensed, not sold. All rights reserved.
- IF YOU DO NOT AGREE TO THIS END USER LICENSE AGREEMENT (“EULA”), DO NOT USE THE DEVICE OR COPY THE SOFTWARE. INSTEAD, PROMPTLY CONTACT Flir Systems AB FOR INSTRUCTIONS ON RETURN OF THE UNUSED DEVICE(S) FOR A REFUND. **ANY USE OF THE SOFTWARE, INCLUDING BUT NOT LIMITED TO USE ON THE DEVICE, WILL CONSTITUTE YOUR AGREEMENT TO THIS EULA (OR RATIFICATION OF ANY PREVIOUS CONSENT).**

- **GRANT OF SOFTWARE LICENSE.** This EULA grants you the following license:
  - You may use the SOFTWARE only on the DEVICE.
  - **NOT FAULT TOLERANT.** THE SOFTWARE IS NOT FAULT TOLERANT. Flir Systems AB HAS INDEPENDENTLY DETERMINED HOW TO USE THE SOFTWARE IN THE DEVICE, AND MS HAS RELIED UPON Flir Systems AB TO CONDUCT SUFFICIENT TESTING TO DETERMINE THAT THE SOFTWARE IS SUITABLE FOR SUCH USE.
  - **NO WARRANTIES FOR THE SOFTWARE.** THE SOFTWARE is provided “AS IS” and with all faults. THE ENTIRE RISK AS TO SATISFACTORY QUALITY, PERFORMANCE, ACCURACY, AND EFFORT (INCLUDING LACK OF NEGLIGENCE) IS WITH YOU. ALSO, THERE IS NO WARRANTY AGAINST INTERFERENCE WITH YOUR ENJOYMENT OF THE SOFTWARE OR AGAINST INFRINGEMENT. **IF YOU HAVE RECEIVED ANY WARRANTIES REGARDING THE DEVICE OR THE SOFTWARE, THOSE WARRANTIES DO NOT ORIGINATE FROM, AND ARE NOT BINDING ON, MS.**
  - **No Liability for Certain Damages.** EXCEPT AS PROHIBITED BY LAW, MS SHALL HAVE NO LIABILITY FOR ANY INDIRECT, SPECIAL, CONSEQUENTIAL OR INCIDENTAL DAMAGES ARISING FROM OR IN CONNECTION WITH THE USE OR PERFORMANCE OF THE SOFTWARE. THIS LIMITATION SHALL APPLY EVEN IF ANY REMEDY FAILS OF ITS ESSENTIAL PURPOSE. IN NO EVENT SHALL MS BE LIABLE FOR ANY AMOUNT IN EXCESS OF U.S. TWO HUNDRED FIFTY DOLLARS (U.S.\$250.00).
  - **Limitations on Reverse Engineering, Decompilation, and Disassembly.** You may not reverse engineer, decompile, or disassemble the SOFTWARE, except and only to the extent that such activity is expressly permitted by applicable law notwithstanding this limitation.
  - **SOFTWARE TRANSFER ALLOWED BUT WITH RESTRICTIONS.** You may permanently transfer rights under this EULA only as part of a permanent sale or transfer of the Device, and only if the recipient agrees to this EULA. If the SOFTWARE is an upgrade, any transfer must also include all prior versions of the SOFTWARE.
  - **EXPORT RESTRICTIONS.** You acknowledge that SOFTWARE is subject to U.S. export jurisdiction. You agree to comply with all applicable international and national laws that apply to the SOFTWARE, including the U.S. Export Administration Regulations, as well as end-user, end-use and destination restrictions issued by U.S. and other governments. For additional information see <http://www.microsoft.com/exporting/>.

**WARNING**

- (Applies only to Class A digital devices.) This equipment generates, uses, and can radiate radio frequency energy and if not installed and used in accordance with the instruction manual, may cause interference to radio communications. It has been tested and found to comply with the limits for a Class A computing device pursuant to Subpart J of Part 15 of FCC Rules, which are designed to provide reasonable protection against such interference when operated in a commercial environment. Operation of this equipment in a residential area is likely to cause interference in which case the user at his own expense will be required to take whatever measures may be required to correct the interference.
- (Applies only to Class B digital devices.) This equipment has been tested and found to comply with the limits for a Class B digital device, pursuant to Part 15 of the FCC Rules. These limits are designed to provide reasonable protection against harmful interference in a residential installation. This equipment generates, uses and can radiate radio frequency energy and, if not installed and used in accordance with the instructions, may cause harmful interference to radio communications. However, there is no guarantee that interference will not occur in a particular installation. If this equipment does cause harmful interference to radio or television reception, which can be determined by turning the equipment off and on, the user is encouraged to try to correct the interference by one or more of the following measures:
  - Reorient or relocate the receiving antenna.
  - Increase the separation between the equipment and receiver.
  - Connect the equipment into an outlet on a circuit different from that to which the receiver is connected.
  - Consult the dealer or an experienced radio/TV technician for help.
- (Applies only to digital devices subject to 15.19/RSS-210.) **NOTICE:** This device complies with Part 15 of the FCC Rules and with RSS-210 of Industry Canada. Operation is subject to the following two conditions:
  1. this device may not cause harmful interference, and
  2. this device must accept any interference received, including interference that may cause undesired operation.
- (Applies only to digital devices subject to 15.21.) **NOTICE:** Changes or modifications made to this equipment not expressly approved by (manufacturer name) may void the FCC authorization to operate this equipment.
- (Applies only to digital devices subject to 2.1091/2.1093/OET Bulletin 65.) **Radiofrequency radiation exposure Information:** The radiated output power of the device is far below the FCC radio frequency exposure limits. Nevertheless, the device shall be used in such a manner that the potential for human contact during normal operation is minimized.
- (Applies only to cameras featuring Wi-Fi.) **Radiofrequency radiation exposure Information:** For body worn operation, this camera has been tested and meets the FCC RF exposure guidelines when used with the Flir Systems accessories supplied or designated for this product. Use of other accessories may not ensure compliance with FCC RF exposure guidelines.
- (Applies only to cameras with laser pointer.) Do not look directly into the laser beam. The laser beam can cause eye irritation.

- Applies only to cameras with battery:
  - Do not disassemble or do a modification to the battery. The battery contains safety and protection devices which, if they become damaged, can cause the battery to become hot, or cause an explosion or an ignition.
  - If there is a leak from the battery and the fluid gets into your eyes, do not rub your eyes. Flush well with water and immediately get medical care. The battery fluid can cause injury to your eyes if you do not do this.
  - Do not continue to charge the battery if it does not become charged in the specified charging time. If you continue to charge the battery, it can become hot and cause an explosion or ignition.
  - Only use the correct equipment to discharge the battery. If you do not use the correct equipment, you can decrease the performance or the life cycle of the battery. If you do not use the correct equipment, an incorrect flow of current to the battery can occur. This can cause the battery to become hot, or cause an explosion and injury to persons.
- Make sure that you read all applicable MSDS (Material Safety Data Sheets) and warning labels on containers before you use a liquid: the liquids can be dangerous.
- If mounting the A3xx pt/A3xx f series camera on a pole, tower or any elevated location, use industry standard safe practices to avoid injuries.

**CAUTION**

- Do not point the infrared camera (with or without the lens cover) at intensive energy sources, for example devices that emit laser radiation, or the sun. This can have an unwanted effect on the accuracy of the camera. It can also cause damage to the detector in the camera.
- Do not use the camera in a temperature higher than +50°C (+122°F), unless specified otherwise in the user documentation. High temperatures can cause damage to the camera.
- (Applies only to cameras with laser pointer:) Protect the laser pointer with the protective cap when you do not operate the laser pointer.

- Applies only to cameras with battery:
  - Do not attach the batteries directly to a car's cigarette lighter socket, unless a specific adapter for connecting the batteries to a cigarette lighter socket is provided by Flir Systems.
  - Do not connect the positive terminal and the negative terminal of the battery to each other with a metal object (such as wire).
  - Do not get water or salt water on the battery, or permit the battery to get wet.
  - Do not make holes in the battery with objects. Do not hit the battery with a hammer. Do not step on the battery, or apply strong impacts or shocks to it.
  - Do not put the batteries in or near a fire, or into direct sunlight. When the battery becomes hot, the built-in safety equipment becomes energized and can stop the battery charging process. If the battery becomes hot, damage can occur to the safety equipment and this can cause more heat, damage or ignition of the battery.
  - Do not put the battery on a fire or increase the temperature of the battery with heat.
  - Do not put the battery on or near fires, stoves, or other high-temperature locations.
  - Do not solder directly onto the battery.
  - Do not use the battery if, when you use, charge, or store the battery, there is an unusual smell from the battery, the battery feels hot, changes color, changes shape, or is in an unusual condition. Contact your sales office if one or more of these problems occurs.
  - Only use a specified battery charger when you charge the battery.
  - The temperature range through which you can charge the battery is  $\pm 0^{\circ}\text{C}$  to  $+45^{\circ}\text{C}$  ( $+32^{\circ}\text{F}$  to  $+113^{\circ}\text{F}$ ), unless specified otherwise in the user documentation. If you charge the battery at temperatures out of this range, it can cause the battery to become hot or to break. It can also decrease the performance or the life cycle of the battery.
  - The temperature range through which you can discharge the battery is  $-15^{\circ}\text{C}$  to  $+50^{\circ}\text{C}$  ( $+5^{\circ}\text{F}$  to  $+122^{\circ}\text{F}$ ), unless specified otherwise in the user documentation. Use of the battery out of this temperature range can decrease the performance or the life cycle of the battery.
  - When the battery is worn, apply insulation to the terminals with adhesive tape or similar materials before you discard it.
  - Remove any water or moisture on the battery before you install it.
- Do not apply solvents or similar liquids to the camera, the cables, or other items. This can cause damage.
- Be careful when you clean the infrared lens. The lens has a delicate anti-reflective coating.
- Do not clean the infrared lens too vigorously. This can damage the anti-reflective coating.
- In furnace and other high-temperature applications, you must mount a heatshield on the camera. Using the camera in furnace and other high-temperature applications without a heatshield can cause damage to the camera.
- (Applies only to cameras with an automatic shutter that can be disabled.) Do not disable the automatic shutter in the camera for a prolonged time period (typically max. 30 minutes). Disabling the shutter for a longer time period may harm, or irreparably damage, the detector.
- The encapsulation rating is valid only when all openings on the camera are sealed with their designated covers, hatches, or caps. This includes, but is not limited to, compartments for data storage, batteries, and connectors.



- (Applies only to Flir A3xx f/A3xx pt series cameras.)
  - Except as described in this manual, do not open the Flir A3xx pt/A3xx f series camera for any reason. Disassembly of the camera (including removal of the cover) can cause permanent damage and will void the warranty.
  - Do not to leave fingerprints on the Flir A3xx pt/A3xx f series camera's infrared optics.
  - The Flir A3xx pt/A3xx f series camera requires a power supply of 24 VDC. Operating the camera outside of the specified input voltage range or the specified operating temperature range can cause permanent damage.
  - When lifting the Flir A3xx pt series camera use the camera body and base, not the tubes.
  
- (Applies only to Flir GF309 cameras.) **CAUTION:** The exceptionally wide temperature range of the Flir GF309 infrared camera is designed for performing highly accurate electrical and mechanical inspections and can also “see through flames” for inspecting gas-fired furnaces, chemical heaters and coal-fired boilers. IN ORDER TO DERIVE ACCURATE TEMPERATURE MEASUREMENTS IN THESE ENVIRONMENTS THE GF309 OPERATOR MUST HAVE A STRONG UNDERSTANDING OF RADIOMETRIC FUNDAMENTALS AS WELL AS THE PRODUCTS AND CONDITIONS OF COMBUSTION THAT IMPACT REMOTE TEMPERATURE MEASUREMENT. The Infrared Training Center (itc) offers a wide range of world class infrared training for thermography professionals including GF309 operators. For more information about obtaining the training and certification you require, contact your Flir sales representative or itc at [www.infraredtraining.com](http://www.infraredtraining.com).

## 3.1 User-to-user forums

Exchange ideas, problems, and infrared solutions with fellow thermographers around the world in our user-to-user forums. To go to the forums, visit:

<http://www.infraredtraining.com/community/boards/>

## 3.2 Calibration

We recommend that you send in the camera for calibration once a year. Contact your local sales office for instructions on where to send the camera.

## 3.3 Accuracy

For very accurate results, we recommend that you wait 5 minutes after you have started the camera before measuring a temperature.

## 3.4 Disposal of electronic waste



As with most electronic products, this equipment must be disposed of in an environmentally friendly way, and in accordance with existing regulations for electronic waste.

Please contact your Flir Systems representative for more details.

## 3.5 Training

To read about infrared training, visit:

- <http://www.infraredtraining.com>
- <http://www.irtraining.com>
- <http://www.irtraining.eu>

## 3.6 Documentation updates

Our manuals are updated several times per year, and we also issue product-critical notifications of changes on a regular basis.

To access the latest manuals and notifications, go to the Download tab at:

<http://support.flir.com>

It only takes a few minutes to register online. In the download area you will also find the latest releases of manuals for our other products, as well as manuals for our historical and obsolete products.

## 3.7 Important note about this manual

Flir Systems issues generic manuals that cover several cameras within a model line.

This means that this manual may contain descriptions and explanations that do not apply to your particular camera model.

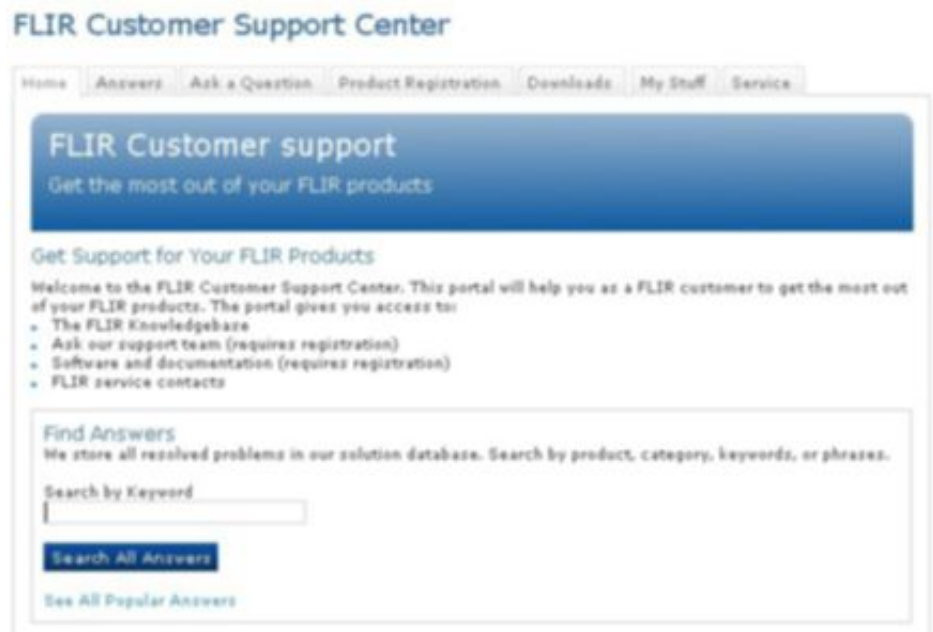

## 4.1 General

For customer help, visit:

<http://support.flir.com>

## 4.2 Submitting a question

To submit a question to the customer help team, you must be a registered user. It only takes a few minutes to register online. If you only want to search the knowledgebase for existing questions and answers, you do not need to be a registered user.

When you want to submit a question, make sure that you have the following information to hand:

- The camera model
- The camera serial number
- The communication protocol, or method, between the camera and your device (for example, HDMI, Ethernet, USB, or FireWire)
- Device type (PC/Mac/iPhone/iPad/Android device, etc.)
- Version of any programs from Flir Systems
- Full name, publication number, and revision number of the manual

## 4.3 Downloads

On the customer help site you can also download the following:

- Firmware updates for your infrared camera.
- Program updates for your PC/Mac software.
- Freeware and evaluation versions of PC/Mac software.
- User documentation for current, obsolete, and historical products.
- Mechanical drawings (in \*.dxf and \*.pdf format).
- Cad data models (in \*.stp format).
- Application stories.
- Technical datasheets.
- Product catalogs.

## 5.1 Procedure

Follow this procedure:

1. Charge the battery for four hours.
2. Insert the battery into the camera.
3. Insert an SD Memory Card into the card slot at the bottom of the camera.
4. Push the On/Off button to turn on the camera. Allow 45 seconds for the startup sequence.
5. Aim the camera toward your target of interest.
6. Push the Preview/Save button halfway down to autofocus the camera.
7. Push the Preview/Save button fully down to save an image.
8. Do one of the following:
  - Remove the SD Memory Card and insert it into a card reader connected to a computer.
  - Connect a computer to the camera using a USB Mini-B cable.
9. Move the image from the card or camera using a drag-and-drop operation.

### 6.1 Contents of the transport case

- Infrared camera with lens
- Battery (2 ea.)
- Battery charger
- Bluetooth headset\*
- Calibration certificate
- Camera lens cap
- Downloads brochure
- Flir ResearchIR scratchcard\*
- Flir Tools download card
- Flir apps card
- Getting started guide
- Hard transport case
- Important information guide
- Memory card
- Neckstrap
- Optics brochure
- Power supply, incl. multi-plugs
- Service & training brochure
- Sunshield
- Thank you card
- USB cable
- User documentation CD-ROM
- Video cable
- Warranty extension card

\* The inclusion of this item is dependent on model.

#### Note

Flir Systems reserves the right to discontinue models, parts or accessories, and other items, or to change specifications at any time without prior notice.

### 6.2 List of accessories and services

Part No	Product name
1123970	Sun shield
1124544	Neck strap
1196398	Battery
1196895	Hard transport case for Flir T/B2xx-4xx
1196960	IR lens, f = 10 mm, 45° incl. case
1196961	IR lens, f = 30 mm, 15° incl. case
1910423	USB cable Std A <-> Mini-B
1910475	Adapter, SD memory card to USB
1910490	Cigarette lighter adapter kit, 12 VDC, 1.2 m/3.9 ft.
1910582	Video cable
19250-100	IR Window 2 in
19251-100	IR Window 3 in.
19252-100	IR Window 4 in.
APP-10002	Flir Tools Mobile (Android Application)
APP-10003	Flir Tools Mobile (iPad/iPhone Application)
DSW-10000	Flir IR Camera Player
ITC-ADV-3021	ITC Advanced General Thermography Course - attendance, 1 pers.
ITC-ADV-3029	ITC Advanced General Thermography Course- group of 10 pers.

Part No	Product name
ITC-CER-5101	ITC Level 1 Thermography Course - attendance, 1 pers.
ITC-CER-5105	ITC Level 1 Thermography Course - additional student to on site class, 1 pers
ITC-CER-5109	ITC Level 1 Thermography Course – group of 10 pers.
ITC-CER-5201	ITC Level 2 Thermography Course - attendance, 1 pers.
ITC-CER-5205	ITC Level 2 Thermography Course - additional student to on site class, 1 pers
ITC-CER-5209	ITC Level 2 Thermography Course – group of 10 pers.
ITC-CER-6101	EN473 IT Certification course Category 1, excl. Certification, 1 pers.
ITC-CER-6109	EN473 IT Certification course Category 1, excl. Certification, group up to 10 pers.
ITC-CON-1001	ITC conference fee
ITC-EXP-0511	ITC Getting Started with Thermography - attendance, 1 pers.
ITC-EXP-0521	ITC Getting Started with Thermography (evening or weekend) - attendance, 1 pers.
ITC-EXP-1001	ITC Training 1 day - attendance 1 pers.
ITC-EXP-1009	ITC Training 1 day - group up to 10 pers.
ITC-EXP-1011	ITC Short course Introduction to thermography -attendance 1 pers. (1 day)
ITC-EXP-1019	ITC Short course Introduction to thermography - inclusive 10 pers. (1 day)
ITC-EXP-1021	ITC In-house training - additional attendance 1 pers. (per day)
ITC-EXP-1029	ITC In-house training - group up to 10 pers. (per day)
ITC-EXP-2001	ITC Training 2 days - attendance 1 pers.
ITC-EXP-2009	ITC Training 2 days - group up to 10 pers.
ITC-EXP-2041	ITC Short course electrical thermography - attendance 1 pers. (2 days)
ITC-EXP-2049	ITC Short course electrical thermography - inclusive 10 pers. (2 days)
ITC-EXP-3001	ITC Training 3 days - attendance 1 pers.
ITC-EXP-3009	ITC Training 3 days - group up to 10 pers.
ITC-FEE-0120	Certification EN473 IT Category 1
ITC-FEE-0130	Repeat Certification EN473 IT Category 1
ITC-PRA-2011	ITC Practical Course - Solar panel inspection - attendance, 1 pers (2 days)
ITC-PRA-2019	ITC Practical Course - Solar panel inspection - group up to 10 pers (2 days)
ITC-SOW-0001	ITC Software course - attendance 1 pers. (per day)
ITC-SOW-0009	ITC Software course - group up to 10 pers. (per day)
ITC-SOW-1001	ITC Training Flir Software - attendance 1 pers. (1 day)
ITC-SOW-2001	ITC Training Flir Software - attendance 1 pers. (2 days)
ITC-TFT-0100	ITC travel time for instructor
ITC-TOL-1001	Travel and lodging expenses instructor (Europe, Balcans, Turkey, Cyprus)
ITC-TOL-1002	Travel and lodging expenses instructor (Russia/GUS, Middle East, North Africa)
ITC-TOL-1003	Travel and lodging expenses instructor (Center and South Africa)
ITC-TOL-1004	Travel and lodging expenses instructor (various)
ITC-TOL-1005	Travel and lodging expenses instructor (other)
T127451	Flir Reporter Professional (license only)
T127597	Flir ResearchIR 3 (license only)
T127597L10	Flir ResearchIR 3 (license only), 10 user licenses
T127597L5	Flir ResearchIR 3 (license only), 5 user licenses
T127598	Flir ResearchIR 3 Max (license only)

Part No	Product name
T127598L10	Flir ResearchIR 3 Max (license only), 10 user licenses
T127598L5	Flir ResearchIR 3 Max (license only), 5 user licenses
T127648	Flir Tools+ (license only)
T197000	High temp. option +1200°C/+2192°F for Flir T/B2xx to T/B4xx and A3xx, A3xxf, A3xxpt, A3xxsc series
T197214	Close-up 2× (50 µm) incl. case
T197215	Close-up 4× (100 µm) incl. case
T197408	IR lens, 76 mm (6°) with case and mounting support for T/B-200/400
T197412	IR lens, 4 mm (90°) with case and mounting support for T/B2xx-4xx
T197650	2-bay battery charger, incl. power supply with multi plugs
T197667	Battery package
T197717	Flir Reporter Professional (DVD)
T197771	Bluetooth Headset
T197965	Flir Tools
T198206	Flir ResearchIR 3 (CD)
T198209	Flir ResearchIR 3 Max (CD)
T198290	Upgrade Flir ResearchIR 3 to Flir ResearchIR 3 Max
T198291	Upgrade previous version to Flir ResearchIR 3 Max
T198292	Upgrade previous version to Flir ResearchIR 3
T199802	Calibration including General maintenance T2xx-T4xx series
T199815	One year extended warranty for T2xx-4xx series
T910737	Memory card micro-SD with adapters
T910750	Power supply, incl. multi plugs
T910972	EX845: Clamp meter + IR therm TRMS 1000A AC/DC
T910973	MO297: Moisture meter, pinless with memory
T911048	Pouch for Flir T6xx and T4xx series
T911093	Tool belt

**Note**

Flir Systems reserves the right to discontinue models, parts or accessories, and other items, or to change specifications at any time without prior notice.

## 7.1 General

To prevent strain injuries, it is important that you hold the camera ergonomically correct. This section gives advice and examples on how to hold the camera.

### Note

Please note the following:

- Always adjust the angle of the lens to suit your work position.
- When you hold the camera, make sure that you support the camera housing with your left hand too. This decreases the strain on your right hand.

## 7.2 Figure

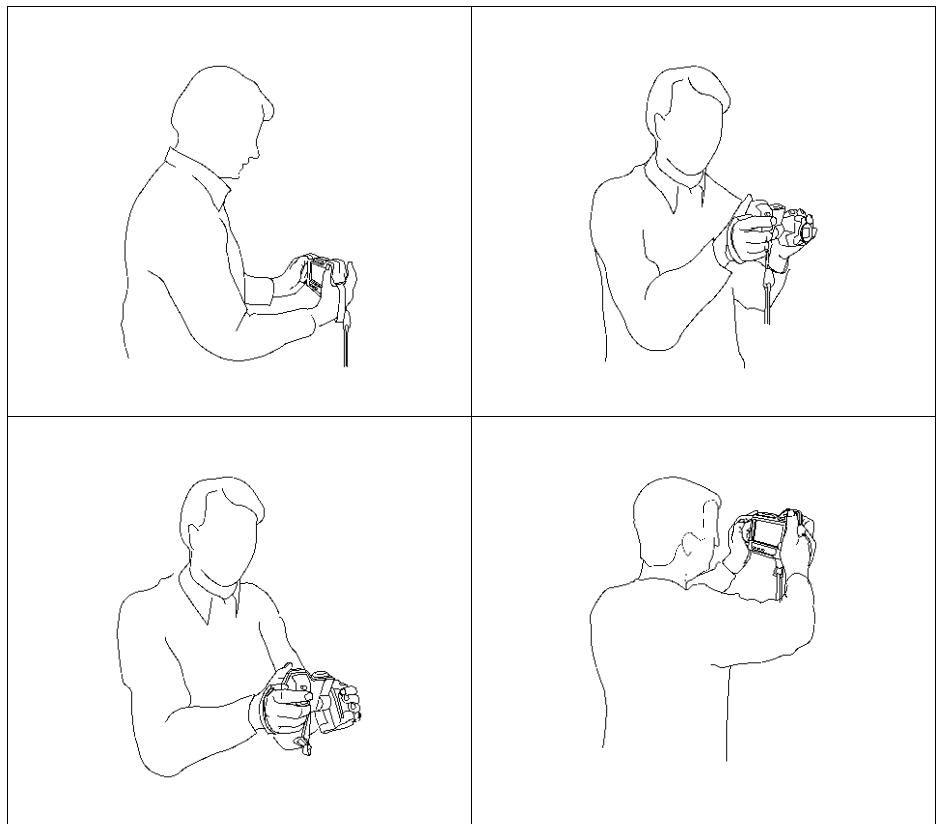



## 8.1 Rear view

### 8.1.1 Figure

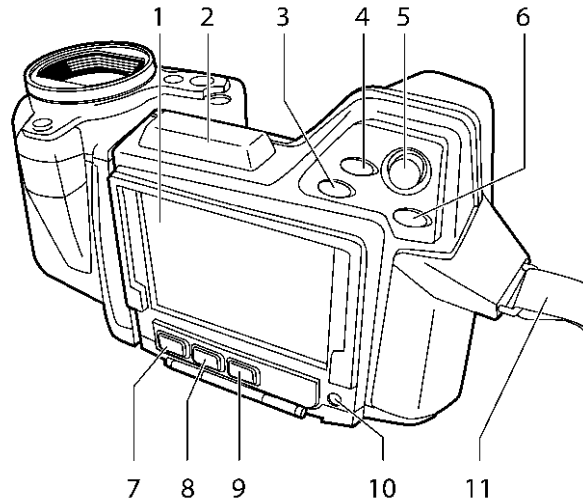

### 8.1.2 Explanation

1. Touch screen LCD.
2. Antenna for wireless communication.
3. Digital zoom button.
4. Programmable button.
5. Joystick: Move up/down or left/right to navigate on menus, in dialog boxes, and in the image archive. Push to confirm choices.
6. Menu/Back button: Push to display the menu on the screen, and to go back in dialog boxes.
7. Mode button: Push to display the mode selector and select a camera mode. The modes that can be selected are:
  - *Thermal camera*: Using this mode, the camera captures infrared images.
  - *Digital camera*: Using this mode, the camera captures visual images.
  - *Thermal fusion*: Using this mode, the camera captures an image where some parts are displayed as an infrared image and some parts as a visual image, depending on the temperature.
  - *Picture in Picture*: Using this mode, the camera captures an image where the middle part is displayed as an infrared image and the outer frame as a visual image.
  - *MSX (Multi Spectral Dynamic Imaging)*: Using this mode, the camera captures infrared images where the edges of the objects are enhanced.

8. A/M button: This button has two main functions:

1. Push to switch between automatic and manual adjustment modes. The manual adjustment modes that can be selected are the following:
  - *Manual*: Using this mode, the top and bottom temperature levels in the scale can be changed simultaneously, by pushing the joystick up/down. The temperature span can be changed by pushing the joystick left/right.
  - *Manual min.*: Using this mode, the bottom temperature level in the scale can be changed by pushing the joystick up/down, while the top temperature level remains fixed.
  - *Manual max.*: Using this mode, the top temperature level in the scale can be changed by pushing the joystick up/down, while the bottom temperature level remains fixed.
2. Push and hold the button until you hear a clicking sound to autoadjust the image.

9. Archive button: Push to open/close the image gallery.

10. On/Off button: Push to turn on/turn off the camera. Allow 45 seconds for the startup sequence.

11. Hand strap.

## 8.2 Front view

### 8.2.1 Figure

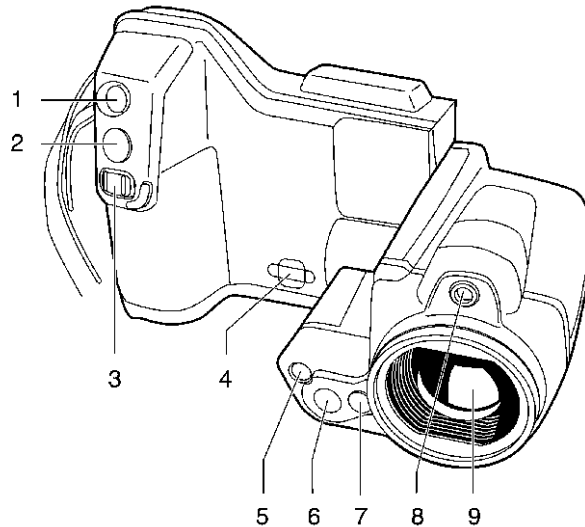

### 8.2.2 Explanation

1. Laser pointer button: Push to activate the laser pointer.

2. This button has two main functions:

1. Preview/Save: Push the button fully down to save an infrared image and a digital photo simultaneously.

#### Note

The behavior of this button can be changed under *Settings* to one of the following:

- *Preview/Save*.
- *Save directly* (default).
- *Always preview*.

2. Autofocus: Push the button halfway down to autofocus the camera.

- 
3. Focus button: Move left/right to manually focus the camera.
  4. Attachment point for the neck strap.
  5. Video lamp.
  6. Digital camera lens.
  7. Release button for additional infrared lenses.
  8. Laser pointer.
  9. Infrared lens.

**Note**

The laser pointer may not be enabled in all markets.

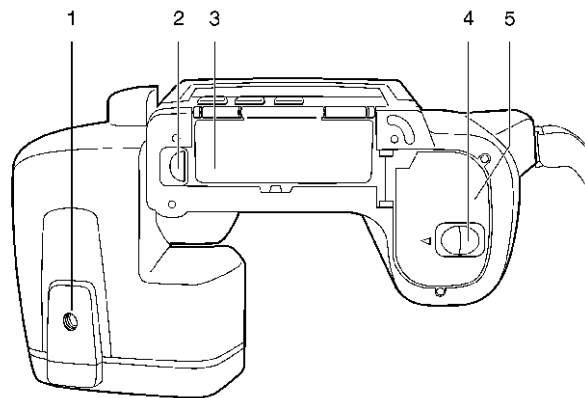
**8.3 Bottom view****8.3.1 Figure****8.3.2 Explanation**

1. Tripod mount 1/4"-20
2. Release button for the cover to the connector bay
3. Cover for the connector bay
4. Release button for the battery compartment cover
5. Cover for the battery compartment

---

## 8.4 Battery condition indicator

### 8.4.1 Figure

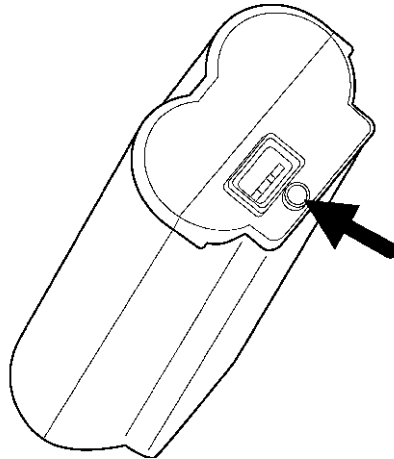

### 8.4.2 Explanation

Type of signal	Explanation
The green light flashes.	The power supply or the stand-alone battery charger is charging the battery.
The green light is continuous.	The battery is fully charged.
The green light is off.	The camera is using the battery (instead of the power supply).

## 8.5 Laser pointer

### 8.5.1 Figure

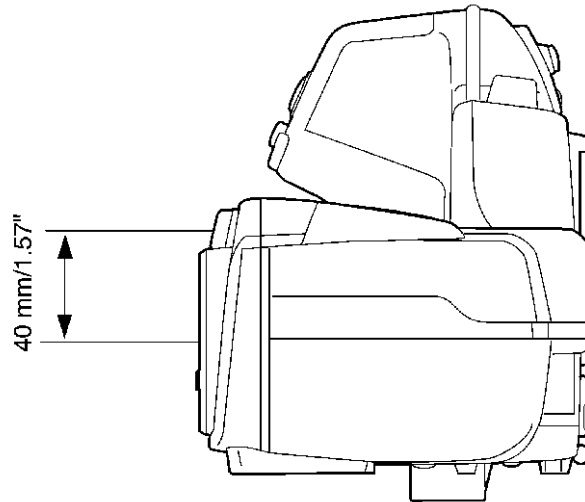

**Figure 8.1** This figure shows the difference in position between the laser pointer and the optical center of the infrared lens.



#### WARNING

Do not look directly into the laser beam. The laser beam can cause eye irritation.



#### CAUTION

Protect the laser pointer with the protective cap when you are not using the laser pointer.

#### Note

The laser pointer may not be enabled in all markets.

#### Note

The symbol  is displayed on the screen when the laser pointer is on.

### 8.5.2 Laser warning label

A laser warning label with the following information is attached to the camera:



### 8.5.3 Laser rules and regulations

Wavelength: 635 nm. Maximum output power: 1 mW.

This product complies with 21 CFR 1040.10 and 1040.11 except for deviations pursuant to Laser Notice No. 50, dated June 24, 2007.

## 9.1 Figure

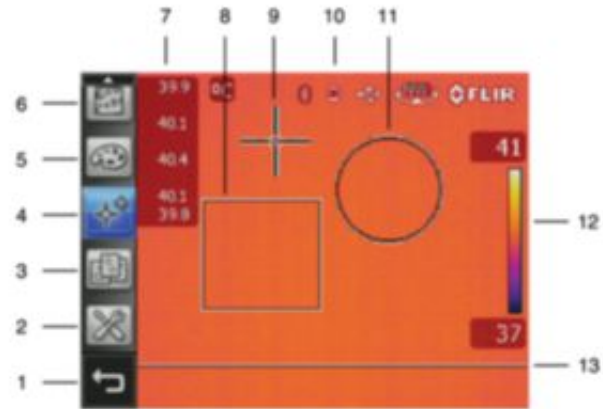

## 9.2 Explanation

1. Back toolbar button.
2. Mode toolbar button.
3. Presets toolbar button.
4. Tools toolbar button.
5. Palette toolbar button.
6. Parameters toolbar button.
7. Result table.
8. Measurement box.
9. Measurement spotmeter.
10. Various status and mode icons, e.g., Bluetooth, battery, USB, and compass.
11. Measurement circle.
12. Temperature scale.
13. Measurement line.

## 10.1 Figure

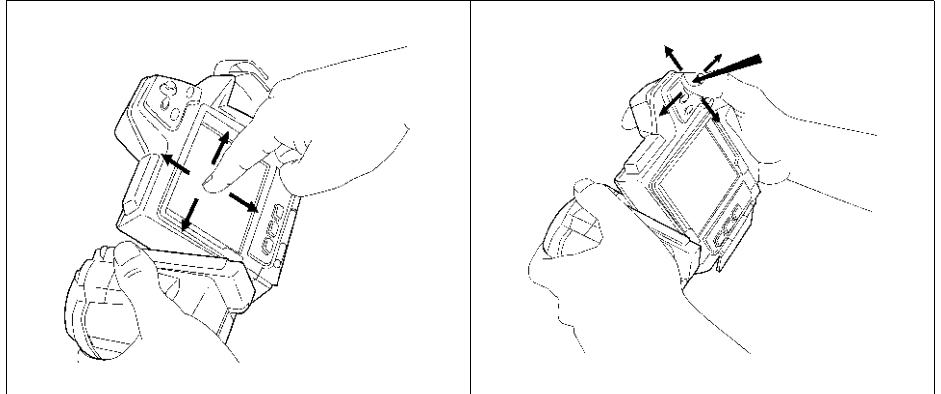

## 10.2 Explanation

The figure above shows the two ways to navigate the menu system in the camera:

- Using the index finger or a stylus pen to navigate the menu system (left).
- Using the joystick to navigate the menu system (right).

You can also use a combination of the two.

In this manual it is assumed that the joystick is used, but most tasks can also be carried out using the index finger or a stylus pen.

11.1 Figure

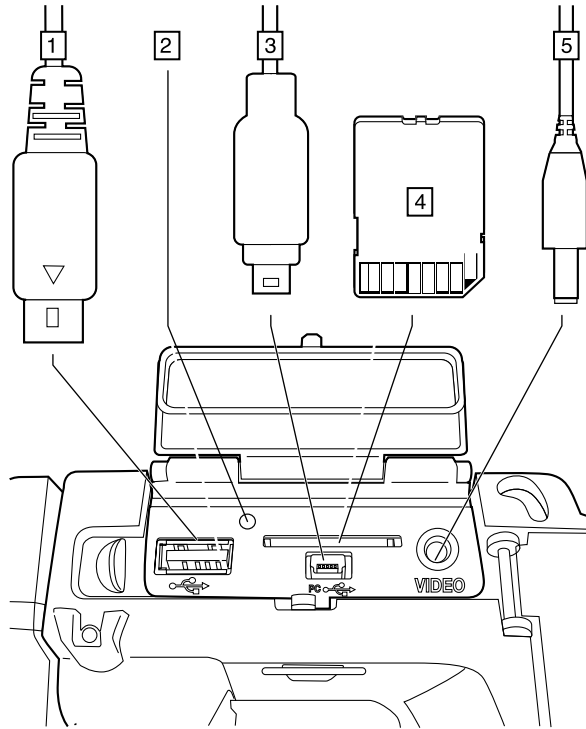

## 11.2 Explanation

1. To connect an external USB device to the camera, use a USB-A cable and this socket.
2. Indicator showing that the memory card is busy.

### Note

- Do not eject the SD memory card when this LED is flashing.
- Do not connect the camera to a computer when this LED is flashing.

3. To connect a computer to the camera to move images and files to and from the camera, use a USB Mini-B cable and this socket.
4. To insert an SD memory card, use this card slot.
5. To connect a video monitor to the camera, use a CVBS (composite video) cable and this socket.



## 12.1 General

Before you can use a Bluetooth device with the camera, you need to pair the devices.

## 12.2 Procedure

Follow this procedure:

1. Turn on the camera.
2. Push the Menu/Back button.
3. On the main menu, go to the *Mode* button  and push the joystick.
4. On the *Mode* menu, select *Settings* and push the joystick.
5. On the *Connectivity* tab, go to *Bluetooth* and push the joystick to enable Bluetooth connectivity.
6. On the same tab, go to *Add device* and push the joystick to begin scanning for devices.

At this stage you need to refer to the user documentation for your Bluetooth device.

## 13.1 General

Depending on your camera configuration, you can connect the camera to a wireless local area network (WLAN) using Wi-Fi, or let the camera provide Wi-Fi access to another device.

You can connect the camera in two different ways:

- *Most common use*: Setting up a peer-to-peer connection (also called *ad hoc* or *P2P* connection). This method is primarily used with other devices, e.g., an iPhone or iPad.
- *Less common use*: Connecting the camera to a WLAN.

## 13.2 Setting up a peer-to-peer connection (most common use)

Follow this procedure:

1. On the main menu, go to the *Mode* button  and push the joystick.
2. On the *Mode* menu, select *Settings* and push the joystick.
3. Go to the *Connectivity* tab.
4. Under *Wi-Fi*, select *Connect device*.
5. Select *Wi-Fi settings*.
6. Enter values for the following parameters:
  - *SSID* (the name of the network).
  - *Channel* (the channel that the other device is broadcasting on).
  - *Encryption* (the encryption algorithm, e.g., None or WEP).
  - *Key* (the access key to the network).
  - *Address* (the IP address for the network).
  - *Gateway* (the gateway IP address for the network).

### Note

These parameters are set for your camera's network. They will be used by the external device to connect that device to the network.

7.

## 13.3 Connecting the camera to a wireless local area network (less common use)

Follow this procedure:

1. On the main menu, go to the *Mode* button  and push the joystick.
2. On the *Mode* menu, select *Settings* and push the joystick.
3. Go to the *Connectivity* tab.
4. Under *Wi-Fi*, select *Connect to WLAN*.
5. Select *Wi-Fi settings*.
6. Select one of the available networks.

Password-protected networks are indicated with a padlock icon, and for these you will need to enter an access key.

7.

### Note

Some networks do not broadcast their existence. To connect to such a network, select *Add manually* and set all parameters manually according to that network.

# Fetching data from external Extech meters

## 14.1 General

You can fetch data from an external Extech meter and merge this data into the result table in the infrared image.

## 14.2 Figure

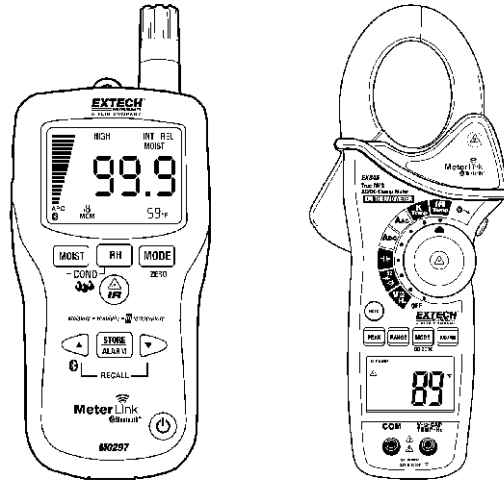

## 14.3 Supported Extech meters

- Extech Moisture Meter MO297
- Extech Clamp Meter EX845

## 14.4 Technical support for Extech meters

support@extech.com

This support is for Extech meters only. For technical support for infrared cameras, go to <http://support.flir.com>.

For more information about products from Extech Instruments, go to <http://www.extech.com/instruments/>.

## 14.5 Procedure

### Note

This procedure assumes that you have paired the Bluetooth devices and set the functionality of the Save button to Preview/Save.

Follow this procedure:

1. Turn on the camera.
2. Turn on the Extech meter.
3. On the meter, enable Bluetooth mode. Refer to the user documentation for the meter for information on how to do this.
4. On the meter, choose the quantity that you want to use (voltage, current, resistance, etc.). Refer to the user documentation for the meter for information on how to do this.

Results from the meter will now automatically be displayed in the result table in the top left corner of the infrared camera screen.

5. Do one of the following:

- To preview an image, push the Preview/Save button. At this stage, you can add additional values. To do so, take a new measurement with the meter and select *Add* on the infrared camera screen.
- To save an image without previewing, push and hold down the Preview/Save button.
- (Dependent on camera model) To add a value to a recalled image, turn on the meter after you have recalled the image, then select *Add* on the infrared camera screen. A maximum of eight values can be added, but note that some values are broken into two lines.

6. Click *Close* or *Save* (depending on camera model).

## **14.6 Typical moisture measurement and documentation procedure**

### **14.6.1 General**

The following procedure can form the basis for other procedures using Extech meters and infrared cameras.

### **14.6.2 Procedure**

Follow this procedure:

1. Use the infrared camera to identify any potential damp areas behind walls and ceilings.
2. Use the moisture meter to measure the moisture levels at various suspect locations that may have been found.
3. When a spot of particular interest is located, store the moisture reading in the moisture meter's memory and identify the measurement spot with a handprint or other thermal identifying marker.
4. Recall the reading from the meter memory. The moisture meter will now continuously transmit this reading to the infrared camera.
5. Use the camera to take a thermal image of the area with the identifying marker. The stored data from the moisture meter will also be saved on the image.

## 15.1 Charging the battery

**Note**

You must charge the battery for four hours before you start using the camera for the first time.

### 15.1.1 General

You must charge the battery when a low battery voltage warning is displayed on the screen.

Follow one of these procedures to charge the battery:

- Use the combined power supply and battery charger to charge the battery when it is inside the camera.
- Use the combined power supply and battery charger to charge the battery when it is outside the camera.
- Use the stand-alone battery charger to charge the battery

### 15.1.2 *Using the combined power supply and battery charger to charge the battery when it is inside the camera*

**Note**

For brevity, the 'combined power supply and battery charger' is called the 'power supply' below.

#### 15.1.2.1 Procedure

Follow this procedure:

1. Open the battery compartment lid.
2. Connect the power supply cable plug to the connector on the battery.
3. Connect the power supply mains-electricity plug to a mains socket.
4. Disconnect the power supply cable plug when the green light of the battery condition indicator is continuous.

See also:

For information about the battery condition indicator, see 8.4 *Battery condition indicator*, page 18.

### 15.1.3 *Using the combined power supply and battery charger to charge the battery when it is outside the camera*

**Note**

For brevity, the 'combined power supply and battery charger' is called the 'power supply' below.

#### 15.1.3.1 Procedure

Follow this procedure:

1. Put the battery on a flat surface.
2. Connect the power supply cable plug to the connector on the battery.
3. Connect the power supply mains-electricity plug to a mains socket.
4. Disconnect the power supply cable plug when the green light of the battery condition indicator is continuous.

See also:

For information about the battery condition indicator, see 8.4 *Battery condition indicator*, page 18.

### 15.1.4 Using the stand-alone battery charger to charge the battery

#### 15.1.4.1 Procedure

Follow this procedure:

1. Put the battery in the stand-alone battery charger.
2. Connect the power supply cable plug to the connector on the stand-alone battery charger.
3. Connect the power supply mains-electricity plug to a mains socket.
4. Disconnect the power supply cable plug when the green light of the battery condition indicator is continuous.

See also:

For information about the battery condition indicator, see 8.4 *Battery condition indicator*, page 18.

### 15.2 Inserting the battery

#### Note

Use a clean, dry cloth to remove any water or moisture on the battery before you insert it.

#### 15.2.1 Procedure

Follow this procedure:

1. Push the release button on the battery compartment cover to unlock it.

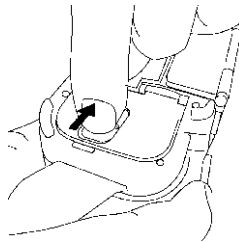

2. Open the cover to the battery compartment.

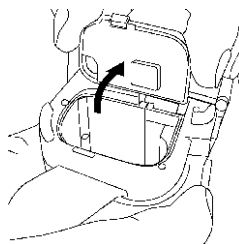

3. Push the battery into the battery compartment until the battery locking mechanism engages.

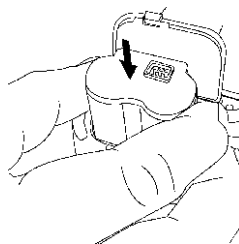

4. Close the cover to the battery compartment.

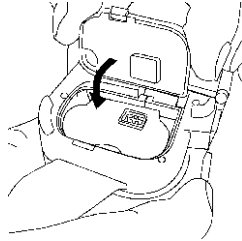

### 15.3 Removing the battery

#### 15.3.1 Procedure

Follow this procedure:

1. Push the release button on the battery compartment cover to unlock it.

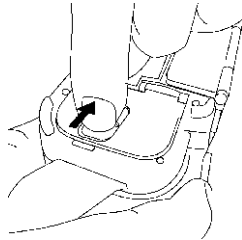

2. Open the cover to the battery compartment.

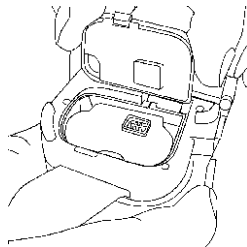

3. Push the red release button in the direction of the arrow to unlock the battery.

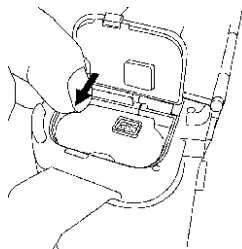

4. Pull out the battery from the battery compartment.

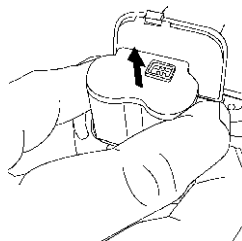

#### 15.4 Turning on and turning off the camera

- To turn on the camera, push and release the On/Off button.
- To turn off the camera, push and release the On/Off button.

#### 15.5 Adjusting the angle of lens

##### 15.5.1 Figure

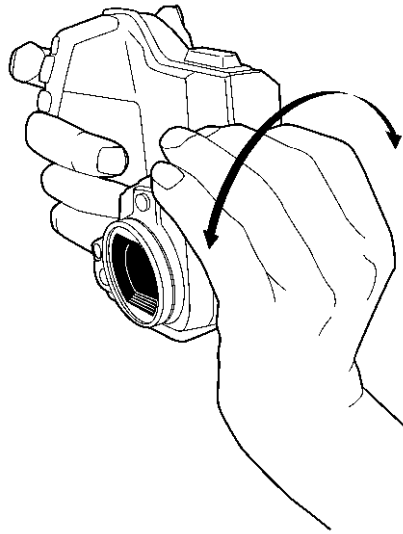

##### 15.5.2 Procedure

To adjust the angle, tilt the lens up or down.

#### 15.6 Mounting an additional lens

**Note**

Do not touch the lens surface when you mount an infrared lens. If this happens, clean the lens according to the instructions in 23.2 *Infrared lens*, page 61

##### 15.6.1 Procedure

Follow this procedure:

1. Push the lens release button to unlock the lens cap.

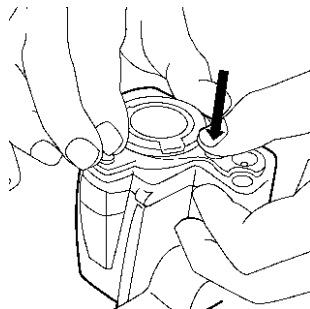



2. Rotate the lens cap 30° counter-clockwise (looking at the front of the lens).

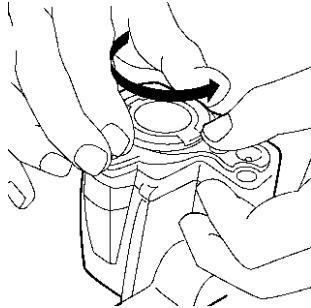

3. Carefully pull out the lens cap from the bayonet ring.

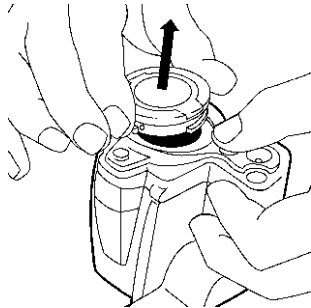

4. Correctly position the lens in front of the bayonet ring.

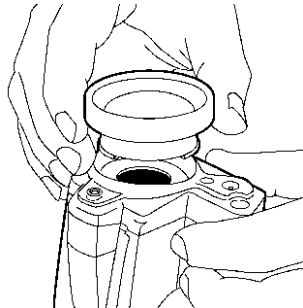

5. Carefully push the lens into position.

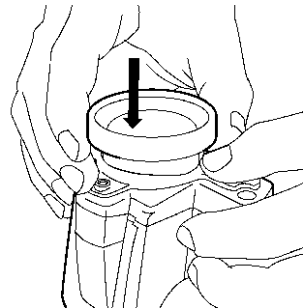

6. Rotate the lens 30° clockwise (looking at the front of the lens).



### 15.7 Removing an additional infrared lens

**Note**

Do not touch the lens surface when you mount an infrared lens. If this happens, clean the lens according to the instructions in 23.2 *Infrared lens*, page 61

When you have removed the lens, put the lens caps on the lens immediately, to protect it from dust and fingerprints.

#### 15.7.1 Procedure

Follow this procedure:

1. Push the lens release button to unlock the lens.

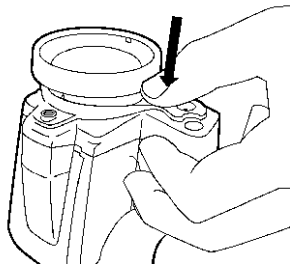

2. Rotate the lens counter-clockwise 30° (looking at the front of the lens).



3. Carefully pull out the lens from the bayonet ring.

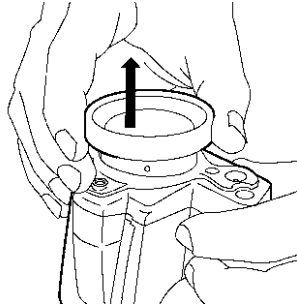

4. Correctly position the lens cap in front of the bayonet ring.

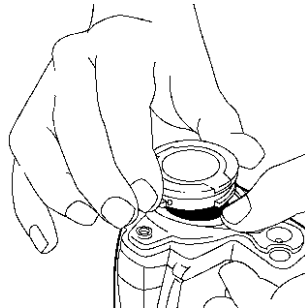

5. Carefully push the lens cap into position.

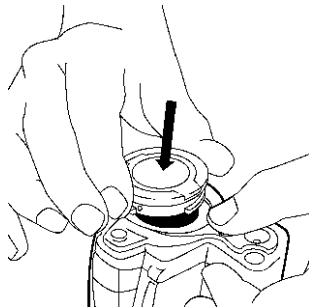

6. Rotate the lens cap 30° clockwise (looking at the front of the lens).

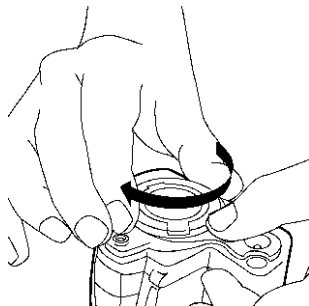

## 15.8 Attaching the sunshield

### 15.8.1 Procedure

Follow this procedure:

1. Align the two front tabs of the sunshield with the corresponding two notches at the top of the screen.

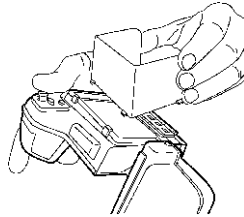

2. Push the front part of the sunshield into position. Make sure that the two tabs mate with the corresponding notches.

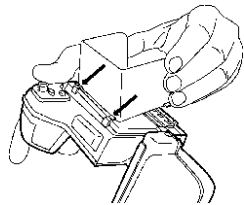

3. Carefully hold together the two rear wings of the sunshield.

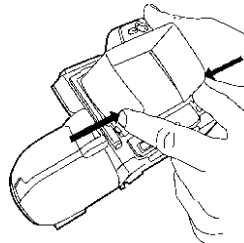

4. Push the rear part of the sunshield toward the screen, and then release your grip. Make sure that the two tabs mate with the corresponding notches.

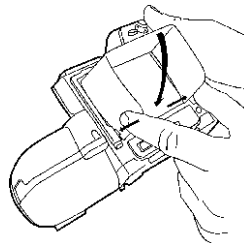

## 15.9 Using the laser pointer

### 15.9.1 Figure

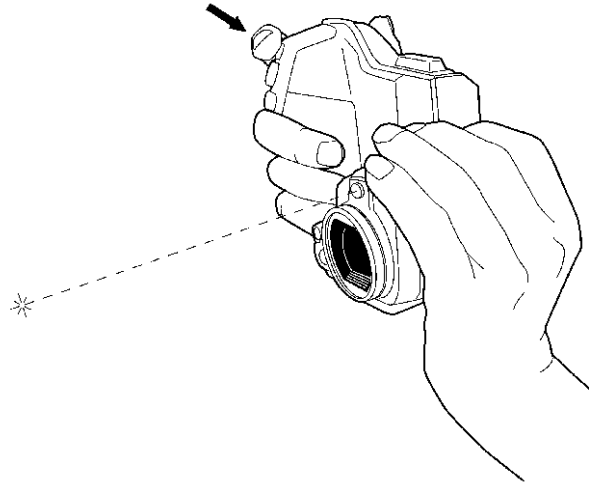

### 15.9.2 Procedure

Follow this procedure:

1. To turn on the laser pointer, push and hold the laser pointer button.
2. To turn off the laser pointer, release the laser pointer button.

#### Note

The laser pointer may not be enabled in all markets.

#### Note

The symbol  is displayed on the screen when the laser pointer is on.

## 15.10 Calibrating the compass

### 15.10.1 Figure

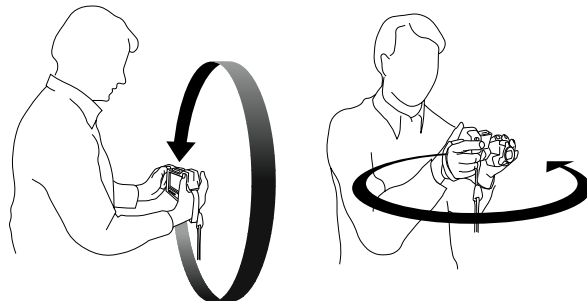

### 15.10.2 Procedure

Follow this procedure:

1. Push the Menu/Back button.
2. On the main menu, go to the *Mode* button  and push the joystick.
3. On the *Mode* menu, select *Settings* and push the joystick.
4. Go to the *Camera* tab.

- 
5. On the *Camera* tab, select *Calibrate compass* and push the joystick.
  6. Click *Start*.
  7. Calibrate the compass by rotating the camera vertically one revolution and horizontally one revolution.

### 15.11 Calibrating the touchscreen LCD

#### 15.11.1 Figure

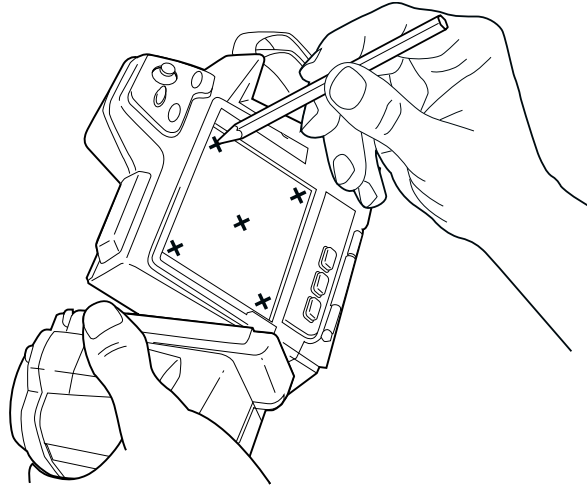

#### 15.11.2 Procedure

Follow this procedure:

1. Push the Menu/Back button.
2. On the main menu, go to the *Mode* button  and push the joystick.
3. On the *Mode* menu, select *Settings* and push the joystick.
4. Go to the *Camera* tab.
5. On the *Camera* tab, select *Calibrate touchscreen* and push the joystick.
6. Click *Start*.
7. Calibrate the touchscreen by tapping the five crosshairs that appear on the screen using a pencil.

## 16.1 Adjusting the infrared camera focus

### 16.1.1 Procedure

To adjust the infrared camera focus, do one of the following:

- Push the focus button left for far focus.
- Push the focus button right for near focus.
- Push the Preview/Save button halfway down to autofocus the camera.

#### Note

It is important that you hold the camera steady while autofocusing.

## 16.2 Previewing an image

### 16.3 General

In preview mode, you can add various types of annotations to the image before you save it, such as a text, a table with textual information, a voice comment, a sketch, etc. You do this by selecting the type of annotation on the toolbar that is automatically displayed when you preview an image.

In preview mode you can also check that the image contains the required information before you save it to the SD Memory Card.

### 16.3.1 Procedure

Follow this procedure:

1. When the camera leaves the factory, it is configured to save an image directly, without previewing. To enable previewing, do the following:
  1. Push the Menu/Back button.
  2. On the main menu, go to the *Mode* button  and push the joystick.
  3. On the *Mode* menu, select *Settings* and push the joystick.
  4. On the *Preferences* tab, go to *Save button* and select *Always preview*.
2. To preview an image, push the Preview/Save button fully down.

## 16.4 Saving an image

### 16.4.1 General

You can save one or more images to the SD Memory Card.

### 16.4.2 Formatting memory cards

For best performance, memory cards should be formatted to the FAT (FAT16) file system. Using FAT32-formatted memory cards may result in inferior performance. To format a memory card to FAT (FAT16), follow this procedure:

1. Insert the memory card into a card reader that is connected to your computer.
2. In Windows Explorer, select *My Computer* and right-click the memory card.
3. Select *Format*.
4. Under *File system*, select *FAT*.
5. Click *Start*.

### 16.4.3 Image capacity

This table gives information on the *approximate* number of images that can be saved on SD Memory Cards:

Card size	No voice annotation	Incl. 30 seconds voice annotation
256 MB	500	250
512 MB	1000	500
1 GB	2000	1000

#### 16.4.4 Procedure

To save an image without previewing, push the Preview/Save button fully down.

##### Note

The behavior of the Preview/Save button can be changed on the *Preferences* tab (*Mode > Settings > Preferences*).

### 16.5 Periodically saving an image

#### 16.5.1 General

You can periodically save images to the SD Memory card.

#### 16.5.2 Procedure

Follow this procedure:

1. Push the Menu/Back button.
2. On the main menu, go to the *Mode* button  and push the joystick.
3. On the *Mode* menu, select *Program* and push the joystick.
4. Use the joystick to set the desired parameters. These include the following:
  - Duration between images.
  - Stop conditions:
    - *Manually*.
    - *Number of images*.
    - *Total time duration*.
5. Push the Menu/Back button.
6.
  - To start the periodic saving, push the Preview/Save button fully down.
  - To stop the periodic saving, push the Preview/Save button fully down.

### 16.6 Opening an image

#### 16.6.1 General

When you save an image, it is stored on the SD Memory Card. To display the image again, you can recall it from the SD Memory Card.

##### Note

To leave archive mode, push the Archive button.

#### 16.6.2 Procedure

Follow this procedure:

1. Push the Archive button to display a thumbnail view of recently saved images.
2. Move the joystick left/right or up/down to select a specific image.
3. Push the joystick to display the image.

### 16.7 Adjusting an image manually

#### 16.7.1 General

An image can be adjusted *automatically* or *manually*.



You use the A/M button to switch between these two modes.

### 16.7.2 Example 1

This figure shows two infrared images of cable connection points. In the left image a correct analysis of the circled cable is difficult if you only auto-adjust the image. You can analyze this cable in more detail if you

- change the temperature scale level
- change the temperature scale span.

In the left image, the image is auto-adjusted. In the right image the maximum and minimum temperature levels have been changed to temperature levels near the object. On the temperature scale to the right of each image you can see how the temperature levels were changed.

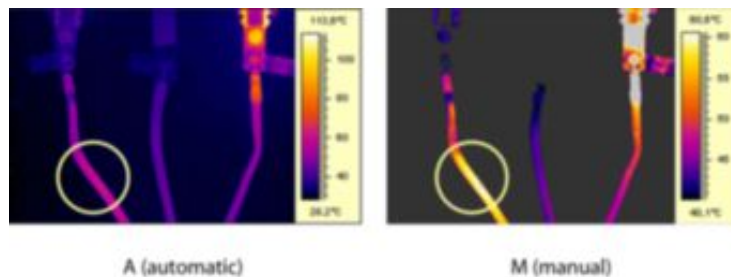

### 16.7.3 Example 2

This figure shows two infrared images of an isolator in a power line.

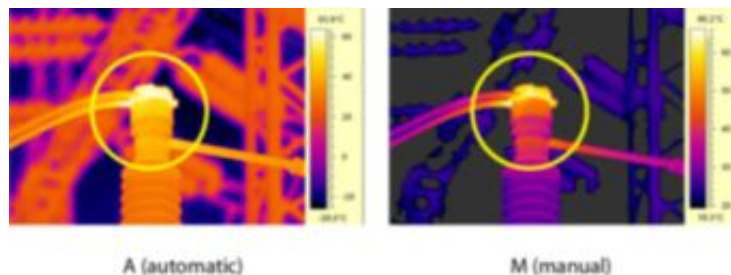

In the left image, the cold sky and the power line structure are recorded at a minimum temperature of  $-26.0^{\circ}\text{C}$  ( $-14.8^{\circ}\text{F}$ ). In the right image the maximum and minimum temperature levels have been changed to temperature levels near the isolator. This makes it easier to analyze the temperature variations in the isolator.



### 16.7.4 Changing the temperature scale level

Follow this procedure:

1. Push the A/M button repeatedly to select one of the following manual modes:

- *Manual* 
- *Manual max.* 
- *Manual min.* 

2. To change the temperature scale level (-s), move the joystick up/down.

### 16.7.5 Changing the temperature scale span

Follow this procedure:

1. Push the A/M button repeatedly to select *Manual* .
2. To change the temperature span, move the joystick left/right.

## 16.8 Hiding overlay graphics

### 16.8.1 General

Overlay graphics provide information about an image. You can choose to hide some or all overlay graphics.

### 16.8.2 Procedure

Follow this procedure:

1. Push the Menu/Back button.
2. On the main menu, go to the *Mode* button  and push the joystick.
3. On the *Mode* menu, select *Settings* and push the joystick.
4. On the *Preferences* tab, go to *View* and disable the overlay graphics that you do not want to display.

## 16.9 Deleting images

### 16.9.1 General

You can delete one or more images from the SD Memory Card.

### 16.9.2 Procedure

Follow this procedure:

1. Push the Archive button.
2. Select the image you want to delete by using the joystick.
3. Push the joystick to open the image.
4. Push the joystick to display a menu.
5. On the menu, select one of the following:
  - *Delete*.
  - *Delete all*.
6. Push the joystick to confirm.

## 16.10 Creating an Adobe PDF report

### 16.10.1 General

You can create an Adobe PDF report about any image on the SD Memory Card. The report may include the following:

- The infrared image, including any associated visual image.
- A list of text annotations.
- A list of measurement results.
- A list of object parameters.
- A sketch.
- An image description.

### 16.10.2 Procedure

Follow this procedure:

1. Insert an SD memory card into the card slot.
2. Push the Archive button.

3. Select the image for which you want to create a report.
4. Push the joystick to open the image.
5. Push the joystick to display a menu.
6. On the menu, select *Create report page* by using the joystick. At this stage you can also add information to the report header and footer.

**Note**

To view the report on the PC, you need Adobe Reader. This software can be downloaded for free from:  
<http://get.adobe.com/reader/>

**Note**

To add your own logotype to your report, put a small \*.jpg file in a folder named \reportlogo on the SD memory card.

## 17.1 What is picture-in-picture?

Picture-in-picture is similar to thermal fusion in that it lets you display part of a digital photo as an infrared image.

However, picture-in-picture displays an infrared image frame on top of a digital photo.

## 17.2 What is thermal fusion?

Thermal fusion is a function that lets you display part of a digital photo as an infrared image.

For example, you can set the camera to display all areas of an image that have a certain temperature in infrared, with all other areas displayed as a digital photo.

## 17.3 Types

The number of image modes is subject to camera models. These include:

- *Above*: All areas in the digital photo with a temperature above the specified temperature level are displayed in infrared.
- *Below*: All areas in the digital photo with a temperature below the specified temperature level are displayed in infrared.
- *Interval*: All areas in the digital photo with a temperature between two specified temperature levels are displayed in infrared.
- *Picture-in-Picture*: An infrared image frame is displayed on top of the digital photo.

### Note

*Picture-in-Picture* only works for calibrated lenses. The lens that ships with the camera is factory-calibrated. To have a new lens calibrated, you must send in the camera and the lens to your local service department.

- *MSX* (Multi Spectral Dynamic Imaging): Using this mode, the camera captures infrared images where the edges of the objects are enhanced.



### Note

*MSX* only works for calibrated lenses. The lens that ships with the camera is factory-calibrated. To have a new lens calibrated, you must send in the camera and the lens to your local service department.

## 17.4 Image examples

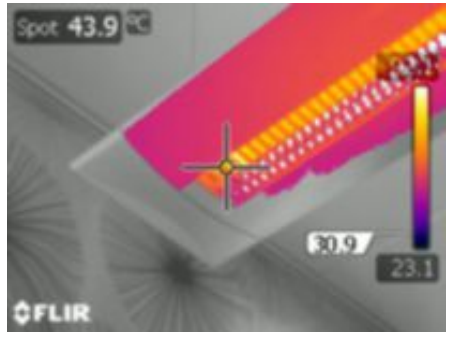
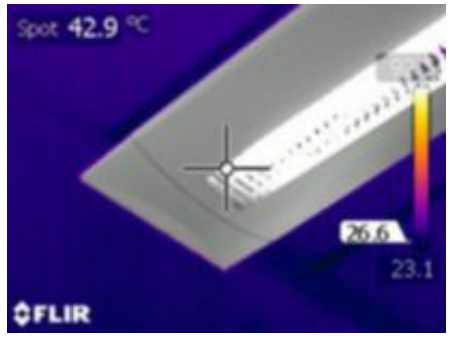
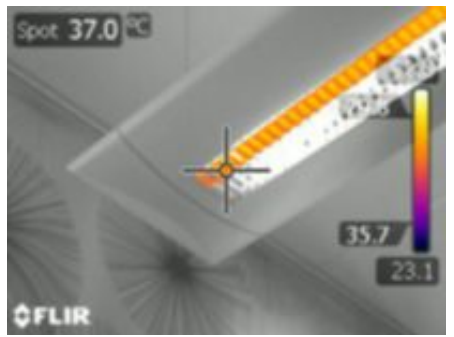
This table explains the different types:



Fusion type	Image
<i>Above</i>	
<i>Below</i>	
<i>Interval</i>	

Fusion type	Image
<i>Picture-in-Picture</i>	
MSX	



### 17.5 Procedure

Follow this procedure:

1. Push the Mode button to select one of the following:

- *Thermal fusion* 
- *Picture in Picture* 

2. Push the A/M button to select one of the following:

- *Above* 
- *Below* 
- *Interval* 

3. (This step applies to *Thermal fusion*.)

Do one or more of the following:

- If you chose *Above* or *Below*, move the joystick up or down to adjust the temperature level. The temperature level that you set will be the level beyond which the infrared image will be displayed as a visual photo.
- If you chose *Interval*, do one or more of the following:
  - Push the joystick up/down to move the interval up/down.
  - Push the joystick left/right to increase/decrease the interval.

The temperature levels that you set will be the level beyond which the infrared image will be displayed as a visual photo.

4. (This step applies to *Picture in Picture*.)

Do one or more of the following:

- If you chose *Above* or *Below*, move the joystick up or down to adjust the temperature level in the infrared portion of the image.
- If you chose *Interval*, do one or more of the following:
  - Push the joystick up/down to move the temperature interval up/down in the infrared portion of the image.
  - Push the joystick left/right to increase/decrease the temperature interval in the infrared portion of the image.

5. To deactivate *Fusion*, push the Mode button to select *Thermal camera*.

## 18.1 Recording video clips

### 18.1.1 General

You can record non-radiometric infrared or visual video clips. In this mode, the camera can be regarded as an ordinary digital video camera.

The video clips can be played back in Windows Media Player, but it will not be possible to retrieve radiometric information from the video clips.

### 18.1.2 Procedure

Follow this procedure:

1. Push the Menu/Back button.
2. On the main menu, go to the *Mode* button  and push the joystick.
3. On the *Mode* menu, select *Video* and push the Preview/Save button. This will display a notification indicating that the recording has started.
4. To stop the video recording, push the Preview/Save button again.

When you stop the video recording you can play back the recording in the camera, using the tools on the video recording toolbar.

#### Note

- You can only view the most recently recorded video clips in this mode. To view another video clip, go to the archive mode.
- To be able to view the clips with Windows Media Player for Windows XP, you need a decoder that supports MPEG-4 video. Such a decoder can be downloaded from <http://www.cole2k.net/> (retrieved July 11, 2012).
- Other video players may also work, for example `ffdshow` from <http://sourceforge.net/projects/ffdshow>.
- Flir Systems does not take any responsibility for the functionality of third-party video players and codecs.







## 19.1 Setting up measurement tools

### 19.1.1 General

To measure the temperature, you use one or more measurement tools. This section gives you examples how you set up a spotmeter or an area.

### 19.1.2 Procedure

Follow this procedure:

1. Push the Menu/Back button.
2. On the main menu, go to the *Tools* button  and push the joystick.
3. On the *Tools* menu, select one of the following:
  - *Add spot* .
  - *Add box* .
  - *Add circle* .

#### Note

- The area inside the center of the spotmeter must be covered by the object of interest, to display a correct temperature.
- For accurate measurements, you must set the object parameters. See 19.8 *Changing object parameters*, page 50.



## 19.2 Setting up a difference calculation

### 19.2.1 General

You can let the camera calculate the temperature difference between, for example, a spotmeter and an area. This assumes that you have previously set up at least two measurement tools.

### 19.2.2 Procedure

Follow this procedure:

1. Push the Menu/Back button.
2. On the main menu, go to the *Tools* button  and push the joystick.
3. On the *Tools* menu, select *Add difference* . This will display a dialog box where you can select the two measurement tools from which you want to calculate the difference.
4. Push the joystick to confirm the choice.

## 19.3 Setting up isotherms

### 19.3.1 General



You can make the camera display an isotherm color when certain measurement conditions are met. The following isotherms can be set up:

- An isotherm color that is displayed when a temperature rises above a preset value.
- An isotherm color that is displayed when a temperature falls below a preset value.
- An isotherm color that is displayed when a temperature is between two values.
- An isotherm color that is displayed when the camera detects an area where there may be a risk of humidity in a building structure.

- An isotherm color that is displayed when the camera detects what may be an insulation deficiency in a wall.



### 19.3.2 Setting up a high-temperature isotherm

Follow this procedure:

1. Push the Menu/Back button.
2. On the main menu, go to the *Tools* button  and push the joystick.
3. On the *Tools* menu, select *Add isotherm*  and push the joystick.
4. Select *Above*.
5. Move the joystick up/down to set the temperature at which you want the isotherm color to be displayed. The screen will now display the isotherm color when the temperature exceeds the set temperature level.



### 19.3.3 Setting up a low-temperature isotherm

Follow this procedure:

1. Push the Menu/Back button.
2. On the main menu, go to the *Tools* button  and push the joystick.
3. On the *Tools* menu, select *Add isotherm*  and push the joystick.
4. Select *Below*.
5. Move the joystick up/down to set the temperature at which you want the isotherm color to be displayed. The screen will now display the isotherm color when the temperature falls below the set temperature level.

### 19.3.4 Setting up an interval isotherm



Follow this procedure:

1. Push the Menu/Back button.
2. On the main menu, go to the *Tools* button  and push the joystick.
3. On the *Tools* menu, select *Add isotherm*  and push the joystick.
4. Select *Interval*.
5. Do one of the following:
  - Move the joystick up/down to set the temperature levels *between which* you want the isotherm color to be displayed.
  - Move the joystick left/right to set the temperature span *within which* you want the isotherm color to be displayed.

The screen will now display the isotherm color when the temperature is between the set temperature levels.

### 19.3.5 Setting up a humidity isotherm

Follow this procedure:



1. Push the Menu/Back button.
2. On the main menu, go to the *Tools* button  and push the joystick.
3. On the *Tools* menu, select *Add isotherm*  and push the joystick.
4. Select *Humidity*.

5. Use the joystick to set the following parameters:

- *Rel. humidity limit*: The critical limit of relative humidity that you want to detect in a building structure. For example, mold will grow in areas where the relative humidity is less than 100%, and you may want to find such areas.
- *Rel. hum. %*: The current relative humidity at the inspection site.
- *Atm. temp.*: The current atmospheric temperature at the inspection site.

### 19.3.6 Setting up an insulation isotherm

Follow this procedure:

1. Push the Menu/Back button.
2. On the main menu, go to the *Tools* button  and push the joystick.
3. On the *Tools* menu, select *Add isotherm*  and push the joystick.
4. Select *Insulation*.
5. Use the joystick to set the following parameters:
  - *Inside temp.*: The temperature inside the building you are inspecting.
  - *Outside temp.*: The temperature outside the building you are inspecting.
  - *Thermal index*: The accepted energy loss through the wall. Different building codes recommend different values, but typical values are 60–80 for new buildings. Refer to your national building code for recommendations.

## 19.4 Working with presets

### 19.4.1 General

A *preset* is a measurement tool, or a group of measurement tools, with predefined characteristics. By selecting a preset you save time compared to creating each individual measurement tool, one at a time.

### 19.4.2 Procedure



Follow this procedure:

1. Push the Menu/Back button.
2. Use the joystick to go to .
3. Push the joystick to display a submenu.
4. Use the joystick to go to a preset.
5. Push the joystick. This will display the preset on the screen.

## 19.5 Removing measurement tools

### 19.5.1 Procedure



Follow this procedure:

1. Push the Menu/Back button.
2. On the main menu, go to the *Tools* button  and push the joystick.
3. On the *Tools* menu, select *Adjust tools*  and push the joystick.
4. Select the measurement tool that you wish to remove. This will display a submenu.
5. On the submenu, select *Remove* and push the joystick.

## 19.6 Moving measurement tools

### 19.6.1 Procedure



Follow this procedure:

1. Push the Menu/Back button.
2. On the main menu, go to the *Tools* button  and push the joystick.
3. On the *Tools* menu, select *Adjust tools*  and push the joystick.
4. Select the measurement tool that you wish to move. This will display a submenu.
5. On the submenu, select *Move* and push the joystick. This will make the center of the measurement tool turn blue. You can now move the measurement tool using the joystick.

## 19.7 Resizing areas

### 19.7.1 Procedure

Follow this procedure:

1. Push the Menu/Back button.
2. On the main menu, go to the *Tools* button  and push the joystick.
3. On the *Tools* menu, select *Adjust tools*  and push the joystick.
4. Select the measurement tool that you wish to resize. This will display a submenu.
5. On the submenu, select *Resize* and push the joystick. This will create resizing handles for the area. You can now resize the area using the joystick.

## 19.8 Changing object parameters

### 19.8.1 General

For accurate measurements, you must set the object parameters. This procedure describes how to change the parameters.

### 19.8.2 Types of parameters

The camera can use these object parameters:

- *Emissivity*, which determines how much of the radiation originates from the object as opposed to being reflected by it.
- *Reflected apparent temperature*, which is used when compensating for the radiation from the surroundings reflected by the object into the camera. This property of the object is called reflectivity.
- *Object distance*, i.e. the distance between the camera and the object of interest.
- *Atmospheric temperature*, i.e. the temperature of the air between the camera and the object of interest.
- *Relative humidity*, i.e. the relative humidity of the air between the camera and the object of interest.
- *External optics temperature*, i.e., the temperature of any protective windows etc. that are set up between the camera and the object of interest. If no protective window or protective shield is used, this value is irrelevant.
- *External optics transmission*, i.e., the optical transmission of any protective windows, etc. that are set up between the camera and the object of interest.

### 19.8.3 Recommended values

If you are unsure about the values, the following are recommended:

---

Emissivity	0.95
Reflected apparent temperature	+20°C (+69°F)
Object distance	1.0 m (3.3 ft.)
Atmospheric temperature	+20°C (+69°F)
Relative humidity	50%

#### 19.8.4 Procedure

Follow this procedure:

1. Push the Menu/Back button.
2. On the main menu, go to the *Parameters* button  and push the joystick.
3. On the *Parameters* menu, select the parameter that you want to change and push the joystick.
4. Move the joystick up/down to change the value.
5. Push the joystick to confirm.

#### Note

Of the five parameters above, *emissivity* and *reflected apparent temperature* are the two most important to set correctly in the camera.

See also:



For more information about parameters, and how to correctly set emissivity and reflected apparent temperature, see 30 *Thermographic measurement techniques*, page 81.

## 20.1 General

This section describes how to save additional information to an infrared image by using annotations.

The reason for using annotations is to make reporting and post-processing more efficient by providing essential information about the image, such as conditions, photos, sketches, where it was taken, and so on.

### Note

Many of the procedures in this section assume that the camera is set to preview images before saving them. If it is not, use the joystick to go to  (*Mode*) > *Settings* >  (*Preferences*) > *Save button*.

## 20.2 Adding a digital photo automatically

### 20.2.1 General

When you save an infrared image you can *automatically* add a digital photo of the object of interest. This digital photo will be associated with the infrared image, which will simplify post-processing and reporting in, for example, Flir Reporter.

### 20.2.2 Procedure

Follow this procedure:

1. Make sure that the camera is configured to save a digital photo simultaneously:
  1. Push the Menu/Back button.
  2. On the main menu, go to the *Mode* button  and push the joystick.
  3. On the *Mode* menu, select *Settings* and push the joystick.
  4. On the *Preferences* tab, enable *Simultaneously save photo*.
2. To automatically add a digital photo, push the Preview/Save button fully down.

## 20.3 Adding a digital photo manually

### 20.3.1 General

When you save an infrared image you can *manually* add a digital photo of the object of interest. This digital photo will be associated with the infrared image, which will simplify post-processing and reporting in, for example, Flir Reporter.

### 20.3.2 Procedure

Follow this procedure:

1. Push the Preview/Save button fully down.
2. On the toolbar at the bottom of the screen, select .
3. On the menu that is displayed, select *Digital camera photo* and push the joystick.
4. Push the Preview/Save button to save the digital photo.

## 20.4 Creating a voice annotation

### 20.4.1 General

A voice annotation is an audio recording that is stored in an infrared image file.





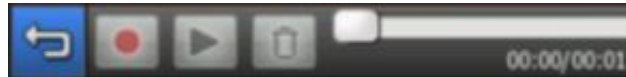

The voice annotation is recorded using a Bluetooth headset. The recording can be played back in the camera, and in image analysis and reporting software from Flir Systems.

### 20.4.2 Procedure

Follow this procedure:

1. To preview an image, push and release the Autofocus/Save button fully down.
2. Use the joystick to select .
3. Push the joystick to display a submenu.
4. On the submenu, select *Voice*. This will display a voice recording toolbar.



5. Do one or more of the following, and push the joystick to confirm each choice. Some buttons have more than one function.
  - To start a recording, select .
  - To pause/resume a recording, select .
  - To stop a recording, select .
  - To listen to a recording, select .
  - To pause a voice annotation that you are listening to, select .
  - To go to the beginning of a recording, select .
  - To delete a recording, move the joystick left/right or up/down and select .
  - To save a recording, select *Save*.

## 20.5 Creating a text

### 20.5.1 General

A text is grouped with an image file. Using this feature, you can annotate images by entering free-form text. This text can be revised later.

### 20.5.2 Procedure

Follow this procedure:

1. To preview an image, push the Autofocus/Save button fully down and release it.
2. Use the joystick to select .
3. Push the joystick to display a submenu.

- On the submenu, select *Text*. This will display a soft keyboard where you can enter the text you want to save.

**Note**

To select special characters, press and hold down the corresponding key on the soft keyboard.

- Click *OK*.

## 20.6 Creating a table

### 20.6.1 General

A table with textual information can be saved in an infrared image.

This feature is a very efficient way of recording information when you are inspecting a large number of similar objects. The idea behind using a table with textual information is to avoid filling out forms or inspection protocols manually.

### 20.6.2 Definition of field and value

A *table* is based on two important concepts—*field* and *value*. See below.

Field (examples)	Value (examples)
Company	Company A Company B Company C
Building	Workshop 1 Workshop 2 Workshop 3
Section	Room 1 Room 2 Room 3
Equipment	Tool 1 Tool 2 Tool 3
Recommendation	Recommendation 1 Recommendation 2 Recommendation 3



---



Table	
Site	Company A
Location	Substation A
Object	Engine
ObjectID	A1a1
Deviation	Overload
Remedy	Replace

**Figure 20.1** The table as it appears in the camera software.

### 20.6.3 Procedure

Follow this procedure:



1. To preview an image, push the Autofocus/Save button fully down and release it.
2. Use the joystick to select .
3. Push the joystick to display a submenu.
4. On the submenu, select *Table*. This will display the following dialog box.



Table	
Site	Company A
Location	Substation A
Object	Engine
ObjectID	A1a1
Deviation	Overload
Remedy	Replace

This is the default table annotations template that ships with the camera.

5. Do one of the following:

- To edit a *field*, click . This will display the following dialog box.



- Insert field*: Select this option to insert a new field.
  - Duplicate field*: Select this option to duplicate the currently selected field.
  - Rename field*: Select this option to rename the currently selected field.
  - Keep as default value*: Enable this option to keep the current value as a default value. The default value will be displayed for this field the next time you create a table.
  - Store added values*: Enable this option to store added values in a glossary, which make them easier to find the next time you create a table.
- To edit a *value*, click the value. This will display the following dialog box where you can create new values, edit existing values or delete values:

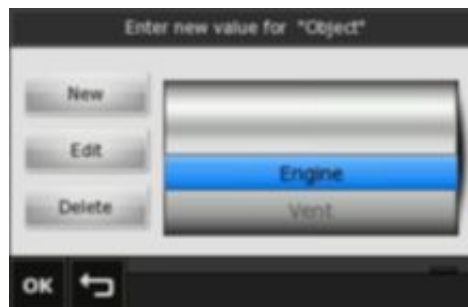

6. Click **OK**. The table will now be added to to what is called a *group*, and will be grouped together with the infrared image in the image archive, and also when moving files from the camera to reporting software on the computer.

## 20.7 Adding a sketch

### 20.7.1 General

A sketch is freehand drawing that you create in a sketch work area separate from the infrared image using a stylus pen or your index finger. You can use the sketch feature to create a simple drawing, write down comments, add dimensions, etc.

Sketches can be added to any of the following:

- A separate sketch.
- A sketch on an infrared image.
- A sketch on a digital photo.

### 20.7.2 Adding a separate sketch

Follow this procedure:

- To preview an image, push the Autofocus/Save button fully down and release it.
- Use the joystick to select .
- Push the joystick to display a submenu.

4. Use the joystick to select *Sketch*.
5. Push the joystick to display a sketchboard.

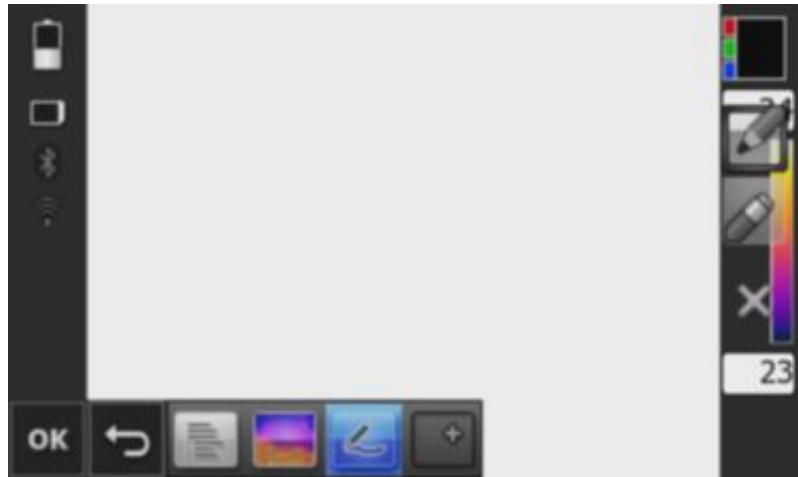

6. On this sketchboard you can:
  - Draw a sketch, using the stylus pen.
  - Change the color of the lines.
  - Erase lines and start again.
  - Erase the entire sketch.

The sketch will now be added to what is called a *group*, and will be grouped together with the infrared image in the image archive, and also when moving files from the camera to reporting software on the computer.

### 20.7.3 Adding a sketch to an infrared image

Follow this procedure:

1. To preview an image, push the Autofocus/Save button fully down and release it.
2. On the bottom toolbar, select the infrared image and push the joystick.
3. On the left toolbar, select the *Sketch* toolbar button and push the joystick.
4. Do one or more of the following:
  - Draw a sketch, using the stylus pen.
  - Change the color of the lines.
  - Erase lines and start again.
  - Erase the entire sketch.

### 20.7.4 Adding a sketch to a digital photo

Follow this procedure:

1. To preview an image, push the Autofocus/Save button fully down and release it.
2. On the bottom toolbar, select the digital photo and push the joystick.
3. On the left toolbar, select the *Sketch* toolbar button and push the joystick.
4. Do one or more of the following:
  - Draw a sketch, using the stylus pen.
  - Change the color of the lines.
  - Erase lines and start again.
  - Erase the entire sketch.

## 21.1 General

You can program the camera to save images periodically.

## 21.2 Procedure

Follow this procedure:

1. Push the Menu/Back button or tap the screen to display the menu system.
2. Use the joystick to go to  (*Mode*). This will display the *Mode* submenu.
3. On the *Mode* submenu, select *Program* and push the joystick. This will display the *Program* dialog box.

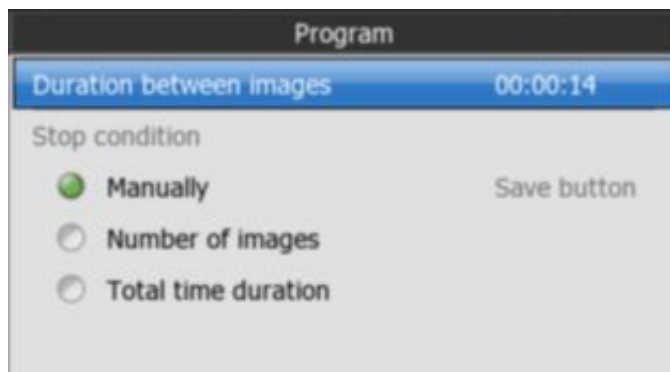

4. Select *Duration between images* and push the joystick. This will display a dialog box where you can set the time interval between each saved image.
5. Set the stop condition. You can choose between three different stop conditions:
  - *Manually*: Select this option to manually stop the periodic saving by pushing the Preview/Save button.
  - *Number of images*: Select this option to stop the periodic saving after a set number of images has been saved. When you select this option a dialog box appears.
  - *Total time duration*: Select this option to stop the periodic saving after a defined period of time. When you select this option a dialog box appears.
6. When you are finished, push the Menu/Back button.
7. Start the periodic saving by pushing the Autofocus/Save button.

## 22.1 Changing camera settings

### 22.1.1 General

On this tab you can change the following:

- Temperature range, i.e. the temperature range used for measuring objects. You must change the temperature range according to the expected temperature of the object you are inspecting.
- Add-on lens.
- Display intensity.
- Auto power off.
- Digital camera lamp.
- Calibrate touchscreen.
- Calibrate compass.
- Reset to default settings.

### 22.1.2 Procedure

Follow this procedure:

1. Push the Menu/Back button.
2. On the main menu, go to the *Mode* button  and push the joystick.
3. On the *Mode* menu, select *Settings* and push the joystick.
4. On the *Camera* tab, go to the setting that you want to change.
5. Push the joystick.
6. Move the joystick up/down to select a new value.
7. Push the joystick to confirm.

## 22.2 Changing preferences

### 22.2.1 General

On this tab you can change the following:

- Save button.
- Simultaneously save photo.
- Same field of view.
- Programmable button.
- Visibility of overlay graphics.

### 22.2.2 Procedure

Follow this procedure:

1. Push the Menu/Back button.
2. On the main menu, go to the *Mode* button  and push the joystick.
3. On the *Mode* menu, select *Settings* and push the joystick.
4. On the *Preferences* tab, go to the setting that you want to change.
5. Push the joystick.
6. Move the joystick up/down to select a new value.
7. Push the joystick to confirm.

## 22.3 Changing connectivity

### 22.3.1 General

On this tab you can change the following:

- Wi-Fi.
- Bluetooth.

### 22.3.2 Procedure

Follow this procedure:

1. Push the Menu/Back button.
2. On the main menu, go to the *Mode* button  and push the joystick.
3. On the *Mode* menu, select *Settings* and push the joystick.
4. On the *Connectivity* tab, go to the setting that you want to change.
5. Push the joystick.
6. Move the joystick up/down to select a new value.
7. Push the joystick to confirm.

## 22.4 Changing regional settings

### 22.4.1 General

On this tab you can change the following:

- Language.
- Time zone.
- Set date and time.
- Date format.
- Time format.
- Temperature unit.
- Distance unit.
- Video format.

### 22.4.2 Procedure

Follow this procedure:

1. Push the Menu/Back button.
2. On the main menu, go to the *Mode* button  and push the joystick.
3. On the *Mode* menu, select *Settings* and push the joystick.
4. On the *Regional* tab, go to the setting that you want to change.
5. Push the joystick.
6. Move the joystick up/down to select a new value.
7. Push the joystick to confirm.

## 23.1 Camera housing, cables, and other items

### 23.1.1 Liquids

Use one of these liquids:

- Warm water
- A weak detergent solution

### 23.1.2 Equipment

A soft cloth

### 23.1.3 Procedure

Follow this procedure:

1. Soak the cloth in the liquid.
2. Twist the cloth to remove excess liquid.
3. Clean the part with the cloth.



#### CAUTION

Do not apply solvents or similar liquids to the camera, the cables, or other items. This can cause damage.

## 23.2 Infrared lens

### 23.2.1 Liquids

Use one of these liquids:

- A commercial lens cleaning liquid with more than 30% isopropyl alcohol.
- 96% ethyl alcohol ( $C_2H_5OH$ ).
- DEE (= 'ether' = diethylether,  $C_4H_{10}O$ ).
- 50% acetone (= dimethylketone,  $(CH_3)_2CO$ ) + 50% ethyl alcohol (by volume). This liquid prevents drying marks on the lens.

### 23.2.2 Equipment

Cotton wool

### 23.2.3 Procedure

Follow this procedure:

1. Soak the cotton wool in the liquid.
2. Twist the cotton wool to remove excess liquid.
3. Clean the lens one time only and discard the cotton wool.



#### WARNING

Make sure that you read all applicable MSDS (Material Safety Data Sheets) and warning labels on containers before you use a liquid: the liquids can be dangerous.



#### CAUTION

- Be careful when you clean the infrared lens. The lens has a delicate anti-reflective coating.
- Do not clean the infrared lens too vigorously. This can damage the anti-reflective coating.

For technical data on this product, refer to the product catalog and/or technical data-sheets on the User Documentation CD-ROM that comes with the product.

The product catalog and the datasheets are also available at <http://support.flir.com>.



## 25.1 Pin configuration for USB Mini-B connector

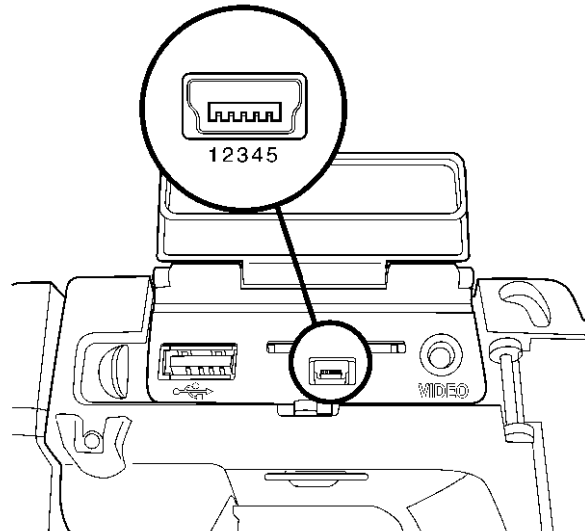

1. +5 V (out)
2. USB -
3. USB +
4. N/C
5. Ground

## 25.2 Pin configuration for video connector

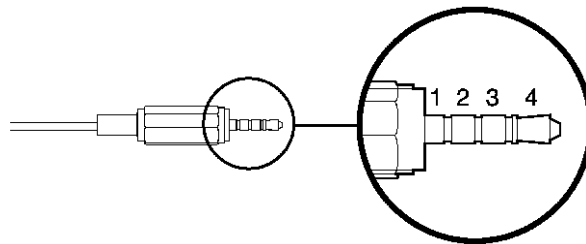

1. Audio right
2. Ground
3. Video out
4. Audio left

---

### 25.3 Pin configuration for USB-A connector

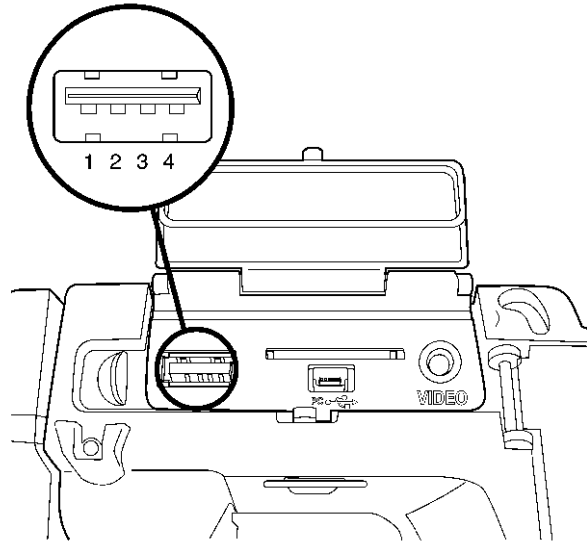

1. +5 V (in)
2. USB -
3. USB +
4. Ground

### 25.4 Pin configuration for power connector

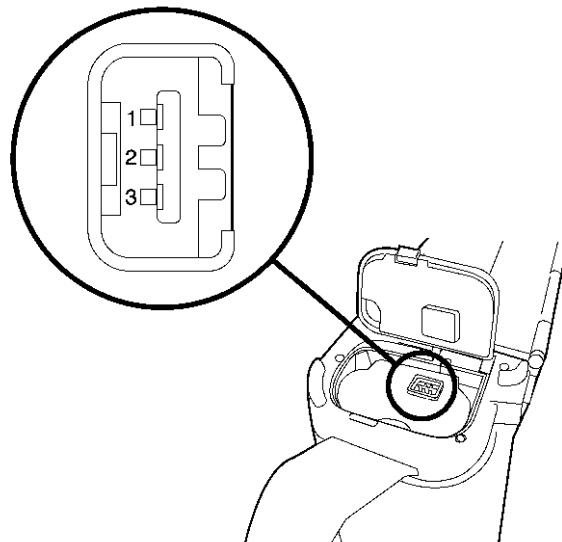

1. +12 V
2. GND
3. GND

## 26.1 Camera

### 26.1.1 Camera dimensions

#### 26.1.1.1 Figure

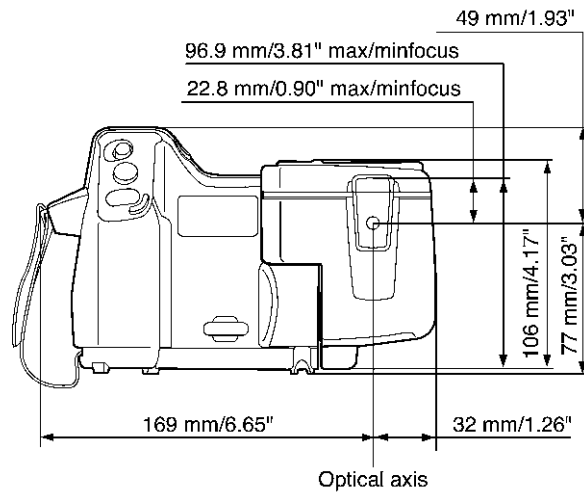

### 26.1.2 Camera dimensions, continued

#### 26.1.2.1 Figure

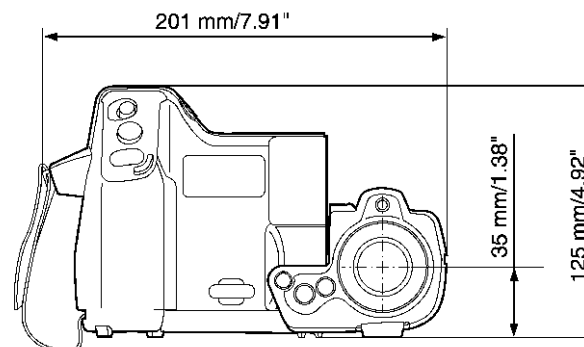

**26.1.3 Camera dimensions, continued**

26.1.3.1 Figure

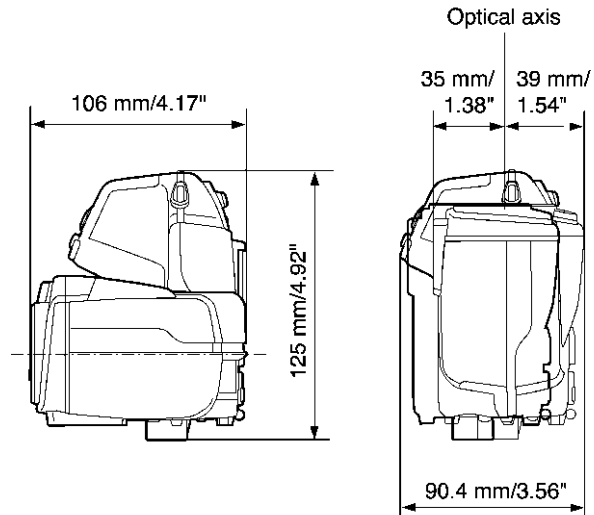

**26.1.4 Camera dimensions, continued (with 30 mm/15° lens)**

26.1.4.1 Figure

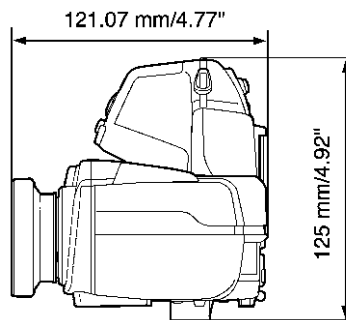

**26.1.5 Camera dimensions, continued (with 10 mm/45° lens)**

26.1.5.1 Figure

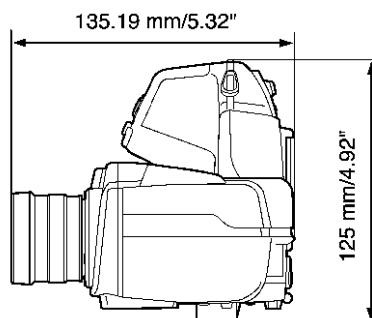

---

## 26.2 Battery

### 26.2.1 Figure

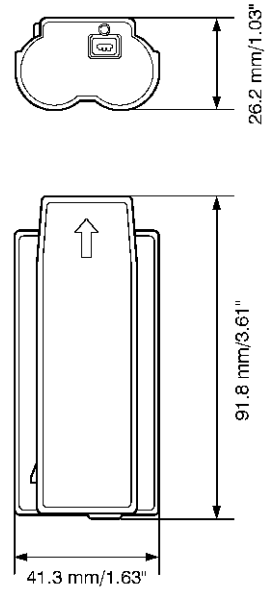
**Note**

Use a clean, dry cloth to remove any water or moisture on the battery before you install it.

---

### 26.3 Stand-alone battery charger

#### 26.3.1 Figure

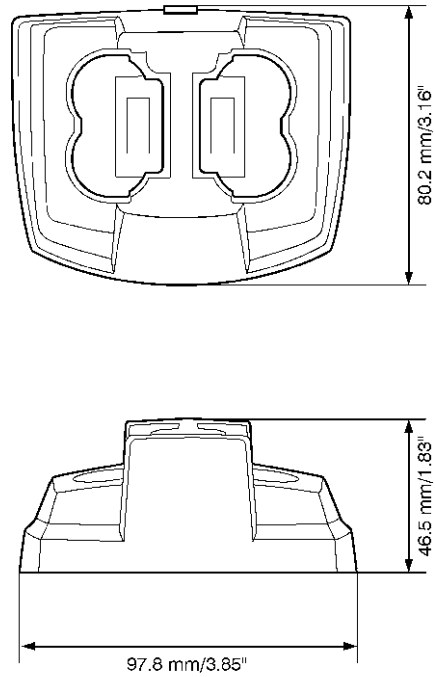
**Note**

Use a clean, dry cloth to remove any water or moisture on the battery before you install it.

---

## 26.4 Stand-alone battery charger with the battery

### 26.4.1 Figure

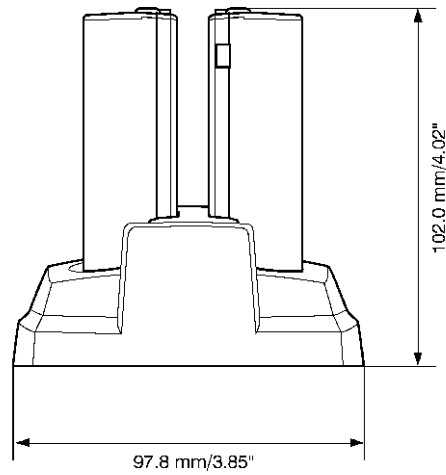
**Note**

Use a clean, dry cloth to remove any water or moisture on the battery before you install it.

## 26.5 Infrared lens (30 mm/15°)

### 26.5.1 Figure

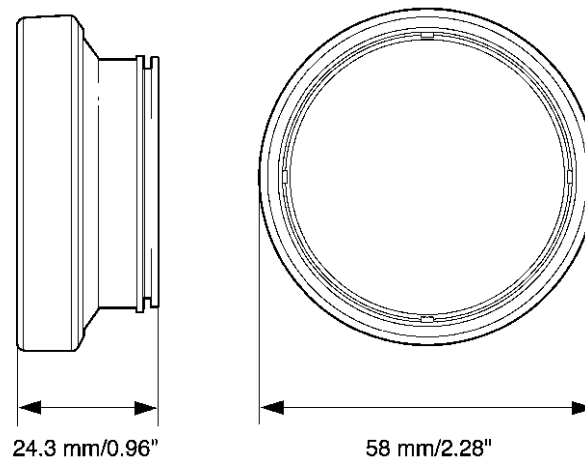

---

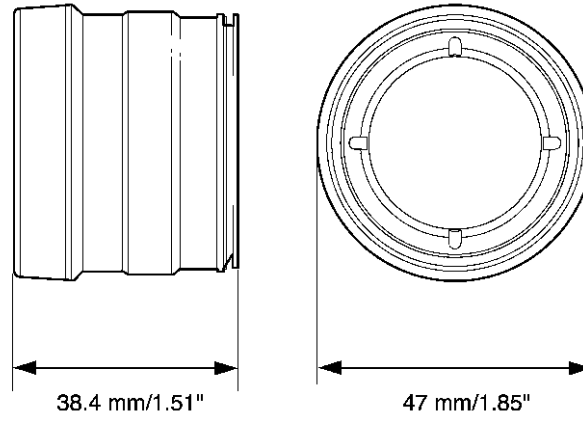
**26.6 Infrared lens (10 mm/45°)****26.6.1 Figure**



## 27.1 Moisture & water damage

### 27.1.1 General

It is often possible to detect moisture and water damage in a house by using an infrared camera. This is partly because the damaged area has a different heat conduction property and partly because it has a different thermal capacity to store heat than the surrounding material.

#### Note

Many factors can come into play as to how moisture or water damage will appear in an infrared image.

For example, heating and cooling of these parts takes place at different rates depending on the material and the time of day. For this reason, it is important that other methods are used as well to check for moisture or water damage.

### 27.1.2 Figure

The image below shows extensive water damage on an external wall where the water has penetrated the outer facing because of an incorrectly installed window ledge.

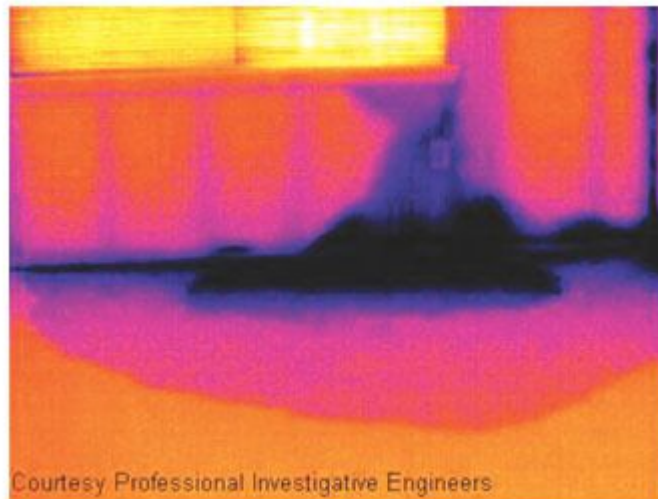

## 27.2 Faulty contact in socket

### 27.2.1 General

Depending on the type of connection a socket has, an improperly connected wire can result in local temperature increase. This temperature increase is caused by the reduced contact area between the connection point of the incoming wire and the socket, and can result in an electrical fire.

#### Note

A socket's construction may differ dramatically from one manufacturer to another. For this reason, different faults in a socket can lead to the same typical appearance in an infrared image.

Local temperature increase can also result from improper contact between wire and socket, or from difference in load.

### 27.2.2 Figure

The image below shows a connection of a cable to a socket where improper contact in the connection has resulted in local temperature increase.

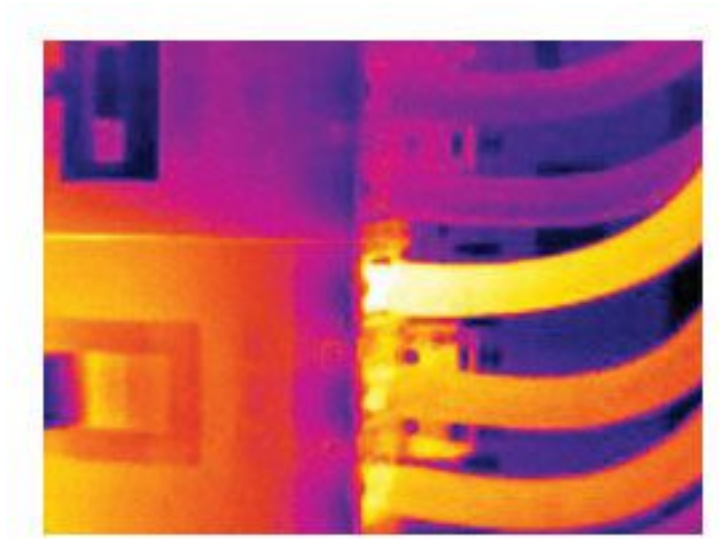

### 27.3 Oxidized socket

#### 27.3.1 General

Depending on the type of socket and the environment in which the socket is installed, oxides may occur on the socket's contact surfaces. These oxides can lead to locally increased resistance when the socket is loaded, which can be seen in an infrared image as local temperature increase.

##### Note

A socket's construction may differ dramatically from one manufacturer to another. For this reason, different faults in a socket can lead to the same typical appearance in an infrared image.

Local temperature increase can also result from improper contact between a wire and socket, or from difference in load.

#### 27.3.2 Figure

The image below shows a series of fuses where one fuse has a raised temperature on the contact surfaces against the fuse holder. Because of the fuse holder's blank metal, the temperature increase is not visible there, while it is visible on the fuse's ceramic material.

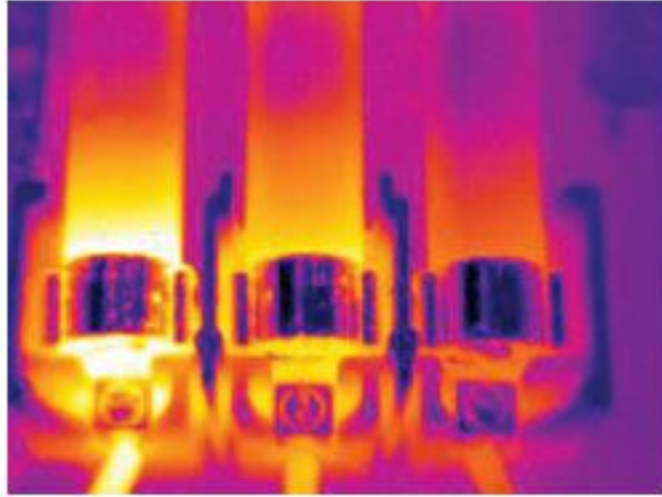

## 27.4 Insulation deficiencies

### 27.4.1 General

Insulation deficiencies may result from insulation losing volume over the course of time and thereby not entirely filling the cavity in a frame wall.

An infrared camera allows you to see these insulation deficiencies because they either have a different heat conduction property than sections with correctly installed insulation, and/or show the area where air is penetrating the frame of the building.

#### Note

When you are inspecting a building, the temperature difference between the inside and outside should be at least 10°C (18°F). Studs, water pipes, concrete columns, and similar components may resemble an insulation deficiency in an infrared image. Minor differences may also occur naturally.

### 27.4.2 Figure

In the image below, insulation in the roof framing is lacking. Due to the absence of insulation, air has forced its way into the roof structure, which thus takes on a different characteristic appearance in the infrared image.

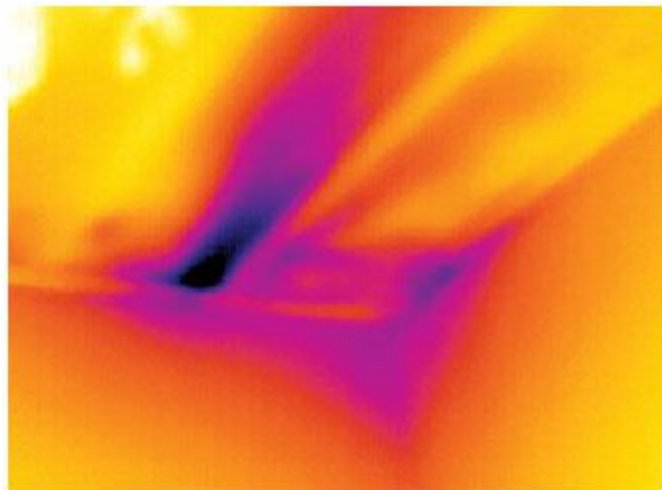

## 27.5 Draft

### 27.5.1 General

Draft can be found under baseboards, around door and window casings, and above ceiling trim. This type of draft is often possible to see with an infrared camera, as a cooler air-stream cools down the surrounding surface.

**Note**

When you are investigating draft in a house, there should be sub-atmospheric pressure in the house. Close all doors, windows, and ventilation ducts, and allow the kitchen fan to run for a while before you take the infrared images.

An infrared image of draft often shows a typical stream pattern. You can see this stream pattern clearly in the picture below.

Also keep in mind that drafts can be concealed by heat from floor heating circuits.

### 27.5.2 Figure

The image below shows a ceiling hatch where faulty installation has resulted in a strong draft.

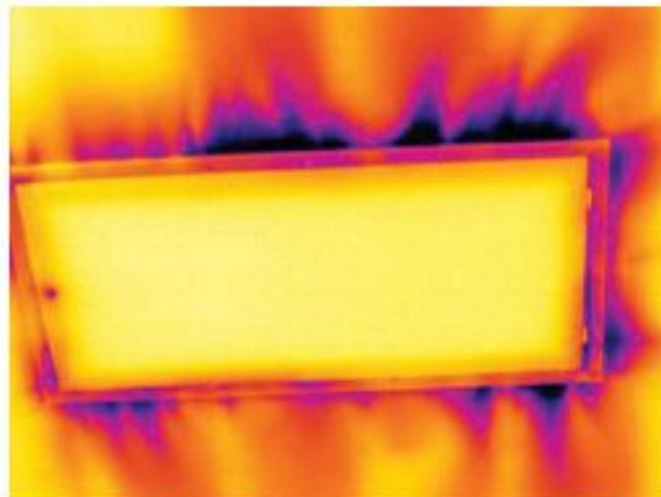

Flir Systems was established in 1978 to pioneer the development of high-performance infrared imaging systems, and is the world leader in the design, manufacture, and marketing of thermal imaging systems for a wide variety of commercial, industrial, and government applications. Today, Flir Systems embraces five major companies with outstanding achievements in infrared technology since 1958—the Swedish AGEMA Infrared Systems (formerly AGA Infrared Systems), the three United States companies Indigo Systems, FSI, and Inframetrics, and the French company Cedip. In November 2007, Extech Instruments was acquired by Flir Systems.



**Figure 28.1** Patent documents from the early 1960s

The company has sold more than 221,000 infrared cameras worldwide for applications such as predictive maintenance, R & D, non-destructive testing, process control and automation, and machine vision, among many others.

Flir Systems has three manufacturing plants in the United States (Portland, OR, Boston, MA, Santa Barbara, CA) and one in Sweden (Stockholm). Since 2007 there is also a manufacturing plant in Tallinn, Estonia. Direct sales offices in Belgium, Brazil, China, France, Germany, Great Britain, Hong Kong, Italy, Japan, Korea, Sweden, and the USA—together with a worldwide network of agents and distributors—support our international customer base.

Flir Systems is at the forefront of innovation in the infrared camera industry. We anticipate market demand by constantly improving our existing cameras and developing new ones. The company has set milestones in product design and development such as the introduction of the first battery-operated portable camera for industrial inspections, and the first uncooled infrared camera, to mention just two innovations.



**Figure 28.2** LEFT: Thermovision Model 661 from 1969. The camera weighed approximately 25 kg (55 lb.), the oscilloscope 20 kg (44 lb.), and the tripod 15 kg (33 lb.). The operator also needed a 220 VAC generator set, and a 10 L (2.6 US gallon) jar with liquid nitrogen. To the left of the oscilloscope the Polaroid attachment (6 kg/13 lb.) can be seen. RIGHT: Flir i7 from 2012. Weight: 0.34 kg (0.75 lb.), including the battery.

Flir Systems manufactures all vital mechanical and electronic components of the camera systems itself. From detector design and manufacturing, to lenses and system electronics, to final testing and calibration, all production steps are carried out and supervised by our own engineers. The in-depth expertise of these infrared specialists ensures the accuracy and reliability of all vital components that are assembled into your infrared camera.

### 28.1 More than just an infrared camera

At Flir Systems we recognize that our job is to go beyond just producing the best infrared camera systems. We are committed to enabling all users of our infrared camera systems to work more productively by providing them with the most powerful camera–software combination. Especially tailored software for predictive maintenance, R & D, and process monitoring is developed in-house. Most software is available in a wide variety of languages.

We support all our infrared cameras with a wide variety of accessories to adapt your equipment to the most demanding infrared applications.

### 28.2 Sharing our knowledge

Although our cameras are designed to be very user-friendly, there is a lot more to thermography than just knowing how to handle a camera. Therefore, Flir Systems has founded the Infrared Training Center (ITC), a separate business unit, that provides certified training courses. Attending one of the ITC courses will give you a truly hands-on learning experience.

The staff of the ITC are also there to provide you with any application support you may need in putting infrared theory into practice.

### 28.3 Supporting our customers

Flir Systems operates a worldwide service network to keep your camera running at all times. If you discover a problem with your camera, local service centers have all the equipment and expertise to solve it within the shortest possible time. Therefore, there is no need to send your camera to the other side of the world or to talk to someone who does not speak your language.

---

#### 28.4 A few images from our facilities



**Figure 28.3** LEFT: Development of system electronics; RIGHT: Testing of an FPA detector



**Figure 28.4** LEFT: Diamond turning machine; RIGHT: Lens polishing



**Figure 28.5** LEFT: Testing of infrared cameras in the climatic chamber; RIGHT: Robot used for camera testing and calibration

---

absorption (absorption factor)	The amount of radiation absorbed by an object relative to the received radiation. A number between 0 and 1.
atmosphere	The gases between the object being measured and the camera, normally air.
autoadjust	A function making a camera perform an internal image correction.
autopalette	The IR image is shown with an uneven spread of colors, displaying cold objects as well as hot ones at the same time.
blackbody	Totally non-reflective object. All its radiation is due to its own temperature.
blackbody radiator	An IR radiating equipment with blackbody properties used to calibrate IR cameras.
calculated atmospheric transmission	A transmission value computed from the temperature, the relative humidity of air and the distance to the object.
cavity radiator	A bottle shaped radiator with an absorbing inside, viewed through the bottleneck.
color temperature	The temperature for which the color of a blackbody matches a specific color.
conduction	The process that makes heat diffuse into a material.
continuous adjust	A function that adjusts the image. The function works all the time, continuously adjusting brightness and contrast according to the image content.
convection	Convection is a heat transfer mode where a fluid is brought into motion, either by gravity or another force, thereby transferring heat from one place to another.
dual isotherm	An isotherm with two color bands, instead of one.
emissivity (emissivity factor)	The amount of radiation coming from an object, compared to that of a blackbody. A number between 0 and 1.
emittance	Amount of energy emitted from an object per unit of time and area ( $W/m^2$ )
environment	Objects and gases that emit radiation towards the object being measured.
estimated atmospheric transmission	A transmission value, supplied by a user, replacing a calculated one
external optics	Extra lenses, filters, heat shields etc. that can be put between the camera and the object being measured.
filter	A material transparent only to some of the infrared wavelengths.



---

FOV	Field of view: The horizontal angle that can be viewed through an IR lens.
FPA	Focal plane array: A type of IR detector.
graybody	An object that emits a fixed fraction of the amount of energy of a blackbody for each wavelength.
IFOV	Instantaneous field of view: A measure of the geometrical resolution of an IR camera.
image correction (internal or external)	A way of compensating for sensitivity differences in various parts of live images and also of stabilizing the camera.
infrared	Non-visible radiation, having a wavelength from about 2–13 $\mu\text{m}$ .
IR	infrared
isotherm	A function highlighting those parts of an image that fall above, below or between one or more temperature intervals.
isothermal cavity	A bottle-shaped radiator with a uniform temperature viewed through the bottleneck.
Laser LocatIR	An electrically powered light source on the camera that emits laser radiation in a thin, concentrated beam to point at certain parts of the object in front of the camera.
laser pointer	An electrically powered light source on the camera that emits laser radiation in a thin, concentrated beam to point at certain parts of the object in front of the camera.
level	The center value of the temperature scale, usually expressed as a signal value.
manual adjust	A way to adjust the image by manually changing certain parameters.
NETD	Noise equivalent temperature difference. A measure of the image noise level of an IR camera.
noise	Undesired small disturbance in the infrared image
object parameters	A set of values describing the circumstances under which the measurement of an object was made, and the object itself (such as emissivity, reflected apparent temperature, distance etc.)
object signal	A non-calibrated value related to the amount of radiation received by the camera from the object.
palette	The set of colors used to display an IR image.
pixel	Stands for <i>picture element</i> . One single spot in an image.
radiance	Amount of energy emitted from an object per unit of time, area and angle ( $\text{W}/\text{m}^2/\text{sr}$ )
radiant power	Amount of energy emitted from an object per unit of time (W)

---

radiation	The process by which electromagnetic energy, is emitted by an object or a gas.
radiator	A piece of IR radiating equipment.
range	The current overall temperature measurement limitation of an IR camera. Cameras can have several ranges. Expressed as two black-body temperatures that limit the current calibration.
reference temperature	A temperature which the ordinary measured values can be compared with.
reflection	The amount of radiation reflected by an object relative to the received radiation. A number between 0 and 1.
relative humidity	Relative humidity represents the ratio between the current water vapour mass in the air and the maximum it may contain in saturation conditions.
saturation color	The areas that contain temperatures outside the present level/span settings are colored with the saturation colors. The saturation colors contain an 'overflow' color and an 'underflow' color. There is also a third red saturation color that marks everything saturated by the detector indicating that the range should probably be changed.
span	The interval of the temperature scale, usually expressed as a signal value.
spectral (radiant) emittance	Amount of energy emitted from an object per unit of time, area and wavelength ( $W/m^2/\mu m$ )
temperature difference, or difference of temperature.	A value which is the result of a subtraction between two temperature values.
temperature range	The current overall temperature measurement limitation of an IR camera. Cameras can have several ranges. Expressed as two black-body temperatures that limit the current calibration.
temperature scale	The way in which an IR image currently is displayed. Expressed as two temperature values limiting the colors.
thermogram	infrared image
transmission (or transmittance) factor	Gases and materials can be more or less transparent. Transmission is the amount of IR radiation passing through them. A number between 0 and 1.
transparent isotherm	An isotherm showing a linear spread of colors, instead of covering the highlighted parts of the image.
visual	Refers to the video mode of a IR camera, as opposed to the normal, thermographic mode. When a camera is in video mode it captures ordinary video images, while thermographic images are captured when the camera is in IR mode.

## 30.1 Introduction

An infrared camera measures and images the emitted infrared radiation from an object. The fact that radiation is a function of object surface temperature makes it possible for the camera to calculate and display this temperature.

However, the radiation measured by the camera does not only depend on the temperature of the object but is also a function of the emissivity. Radiation also originates from the surroundings and is reflected in the object. The radiation from the object and the reflected radiation will also be influenced by the absorption of the atmosphere.

To measure temperature accurately, it is therefore necessary to compensate for the effects of a number of different radiation sources. This is done on-line automatically by the camera. The following object parameters must, however, be supplied for the camera:

- The emissivity of the object
- The reflected apparent temperature
- The distance between the object and the camera
- The relative humidity
- Temperature of the atmosphere

## 30.2 Emissivity

The most important object parameter to set correctly is the emissivity which, in short, is a measure of how much radiation is emitted from the object, compared to that from a perfect blackbody of the same temperature.

Normally, object materials and surface treatments exhibit emissivity ranging from approximately 0.1 to 0.95. A highly polished (mirror) surface falls below 0.1, while an oxidized or painted surface has a higher emissivity. Oil-based paint, regardless of color in the visible spectrum, has an emissivity over 0.9 in the infrared. Human skin exhibits an emissivity 0.97 to 0.98.

Non-oxidized metals represent an extreme case of perfect opacity and high reflexivity, which does not vary greatly with wavelength. Consequently, the emissivity of metals is low – only increasing with temperature. For non-metals, emissivity tends to be high, and decreases with temperature.

### 30.2.1 Finding the emissivity of a sample

#### 30.2.1.1 Step 1: Determining reflected apparent temperature

Use one of the following two methods to determine reflected apparent temperature:

---

### 30.2.1.1.1 Method 1: Direct method

Follow this procedure:

1. Look for possible reflection sources, considering that the incident angle = reflection angle ( $a = b$ ).

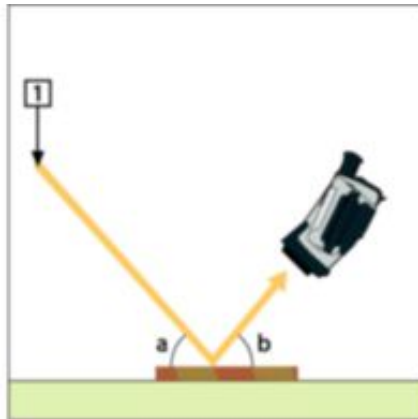

1 = Reflection source

2. If the reflection source is a spot source, modify the source by obstructing it using a piece of cardboard.

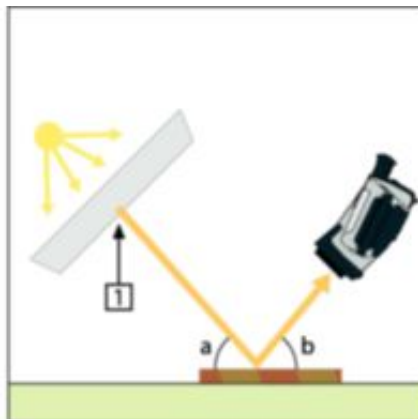

1 = Reflection source

3. Measure the radiation intensity (= apparent temperature) from the reflecting source using the following settings:

- Emissivity: 1.0
- $D_{obj}$ : 0

You can measure the radiation intensity using one of the following two methods:

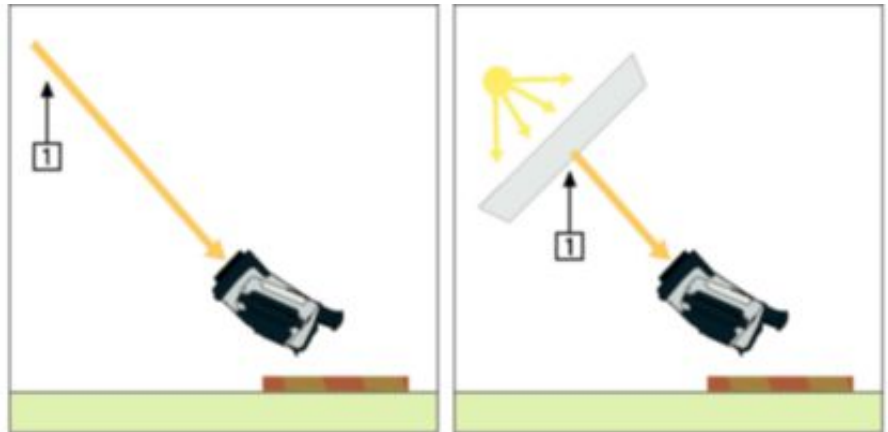

1 = Reflection source

**Note**

Using a thermocouple to measure reflected apparent temperature is not recommended for two important reasons:

- A thermocouple does not measure radiation intensity
- A thermocouple requires a very good thermal contact to the surface, usually by gluing and covering the sensor by a thermal isolator.

**30.2.1.1.2 Method 2: Reflector method**

Follow this procedure:

1. Crumble up a large piece of aluminum foil.
2. Uncrumble the aluminum foil and attach it to a piece of cardboard of the same size.
3. Put the piece of cardboard in front of the object you want to measure. Make sure that the side with aluminum foil points to the camera.
4. Set the emissivity to 1.0.
5. Measure the apparent temperature of the aluminum foil and write it down.

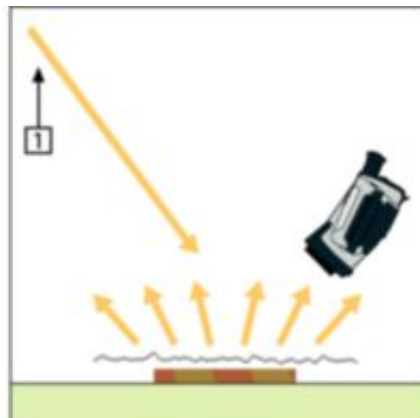

Measuring the apparent temperature of the aluminum foil.

### 30.2.1.2 Step 2: Determining the emissivity

Follow this procedure:

1. Select a place to put the sample.
2. Determine and set reflected apparent temperature according to the previous procedure.
3. Put a piece of electrical tape with known high emissivity on the sample.
4. Heat the sample at least 20 K above room temperature. Heating must be reasonably even.
5. Focus and auto-adjust the camera, and freeze the image.
6. Adjust *Level* and *Span* for best image brightness and contrast.
7. Set emissivity to that of the tape (usually 0.97).
8. Measure the temperature of the tape using one of the following measurement functions:
  - *Isotherm* (helps you to determine both the temperature and how evenly you have heated the sample)
  - *Spot* (simpler)
  - *Box Avg* (good for surfaces with varying emissivity).
9. Write down the temperature.
10. Move your measurement function to the sample surface.
11. Change the emissivity setting until you read the same temperature as your previous measurement.
12. Write down the emissivity.

#### Note

- Avoid forced convection
- Look for a thermally stable surrounding that will not generate spot reflections
- Use high quality tape that you know is not transparent, and has a high emissivity you are certain of
- This method assumes that the temperature of your tape and the sample surface are the same. If they are not, your emissivity measurement will be wrong.

### 30.3 Reflected apparent temperature

This parameter is used to compensate for the radiation reflected in the object. If the emissivity is low and the object temperature relatively far from that of the reflected it will be important to set and compensate for the reflected apparent temperature correctly.

### 30.4 Distance

The distance is the distance between the object and the front lens of the camera. This parameter is used to compensate for the following two facts:

- That radiation from the target is absorbed by the atmosphere between the object and the camera.
- That radiation from the atmosphere itself is detected by the camera.

### 30.5 Relative humidity

The camera can also compensate for the fact that the transmittance is also dependent on the relative humidity of the atmosphere. To do this set the relative humidity to the correct value. For short distances and normal humidity the relative humidity can normally be left at a default value of 50%.

### 30.6 Other parameters

In addition, some cameras and analysis programs from Flir Systems allow you to compensate for the following parameters:

- Atmospheric temperature – *i.e.* the temperature of the atmosphere between the camera and the target
- External optics temperature – *i.e.* the temperature of any external lenses or windows used in front of the camera

- External optics transmittance – *i.e.* the transmission of any external lenses or windows used in front of the camera

Before the year 1800, the existence of the infrared portion of the electromagnetic spectrum wasn't even suspected. The original significance of the infrared spectrum, or simply 'the infrared' as it is often called, as a form of heat radiation is perhaps less obvious today than it was at the time of its discovery by Herschel in 1800.



**Figure 31.1** Sir William Herschel (1738–1822)

The discovery was made accidentally during the search for a new optical material. Sir William Herschel – Royal Astronomer to King George III of England, and already famous for his discovery of the planet Uranus – was searching for an optical filter material to reduce the brightness of the sun's image in telescopes during solar observations. While testing different samples of colored glass which gave similar reductions in brightness he was intrigued to find that some of the samples passed very little of the sun's heat, while others passed so much heat that he risked eye damage after only a few seconds' observation.

Herschel was soon convinced of the necessity of setting up a systematic experiment, with the objective of finding a single material that would give the desired reduction in brightness as well as the maximum reduction in heat. He began the experiment by actually repeating Newton's prism experiment, but looking for the heating effect rather than the visual distribution of intensity in the spectrum. He first blackened the bulb of a sensitive mercury-in-glass thermometer with ink, and with this as his radiation detector he proceeded to test the heating effect of the various colors of the spectrum formed on the top of a table by passing sunlight through a glass prism. Other thermometers, placed outside the sun's rays, served as controls.

As the blackened thermometer was moved slowly along the colors of the spectrum, the temperature readings showed a steady increase from the violet end to the red end. This was not entirely unexpected, since the Italian researcher, Landriani, in a similar experiment in 1777 had observed much the same effect. It was Herschel, however, who was the first to recognize that there must be a point where the heating effect reaches a maximum, and that measurements confined to the visible portion of the spectrum failed to locate this point.



**Figure 31.2** Marsilio Landriani (1746–1815)

Moving the thermometer into the dark region beyond the red end of the spectrum, Herschel confirmed that the heating continued to increase. The maximum point, when he found it, lay well beyond the red end – in what is known today as the 'infrared wavelengths'.



---

When Herschel revealed his discovery, he referred to this new portion of the electromagnetic spectrum as the 'thermometrical spectrum'. The radiation itself he sometimes referred to as 'dark heat', or simply 'the invisible rays'. Ironically, and contrary to popular opinion, it wasn't Herschel who originated the term 'infrared'. The word only began to appear in print around 75 years later, and it is still unclear who should receive credit as the originator.

Herschel's use of glass in the prism of his original experiment led to some early controversies with his contemporaries about the actual existence of the infrared wavelengths. Different investigators, in attempting to confirm his work, used various types of glass indiscriminately, having different transparencies in the infrared. Through his later experiments, Herschel was aware of the limited transparency of glass to the newly-discovered thermal radiation, and he was forced to conclude that optics for the infrared would probably be doomed to the use of reflective elements exclusively (i.e. plane and curved mirrors). Fortunately, this proved to be true only until 1830, when the Italian investigator, Melloni, made his great discovery that naturally occurring rock salt (NaCl) – which was available in large enough natural crystals to be made into lenses and prisms – is remarkably transparent to the infrared. The result was that rock salt became the principal infrared optical material, and remained so for the next hundred years, until the art of synthetic crystal growing was mastered in the 1930's.



**Figure 31.3** Macedonio Melloni (1798–1854)

Thermometers, as radiation detectors, remained unchallenged until 1829, the year Nobili invented the thermocouple. (Herschel's own thermometer could be read to 0.2 °C (0.036 °F), and later models were able to be read to 0.05 °C (0.09 °F)). Then a breakthrough occurred; Melloni connected a number of thermocouples in series to form the first thermopile. The new device was at least 40 times as sensitive as the best thermometer of the day for detecting heat radiation – capable of detecting the heat from a person standing three meters away.

The first so-called 'heat-picture' became possible in 1840, the result of work by Sir John Herschel, son of the discoverer of the infrared and a famous astronomer in his own right. Based upon the differential evaporation of a thin film of oil when exposed to a heat pattern focused upon it, the thermal image could be seen by reflected light where the interference effects of the oil film made the image visible to the eye. Sir John also managed to obtain a primitive record of the thermal image on paper, which he called a 'thermograph'.



**Figure 31.4** Samuel P. Langley (1834–1906)

The improvement of infrared-detector sensitivity progressed slowly. Another major breakthrough, made by Langley in 1880, was the invention of the bolometer. This consisted of a thin blackened strip of platinum connected in one arm of a Wheatstone bridge circuit upon which the infrared radiation was focused and to which a sensitive galvanometer responded. This instrument is said to have been able to detect the heat from a cow at a distance of 400 meters.

An English scientist, Sir James Dewar, first introduced the use of liquefied gases as cooling agents (such as liquid nitrogen with a temperature of  $-196\text{ }^{\circ}\text{C}$  ( $-320.8\text{ }^{\circ}\text{F}$ )) in low temperature research. In 1892 he invented a unique vacuum insulating container in which it is possible to store liquefied gases for entire days. The common 'thermos bottle', used for storing hot and cold drinks, is based upon his invention.

Between the years 1900 and 1920, the inventors of the world 'discovered' the infrared. Many patents were issued for devices to detect personnel, artillery, aircraft, ships – and even icebergs. The first operating systems, in the modern sense, began to be developed during the 1914–18 war, when both sides had research programs devoted to the military exploitation of the infrared. These programs included experimental systems for enemy intrusion/detection, remote temperature sensing, secure communications, and 'flying torpedo' guidance. An infrared search system tested during this period was able to detect an approaching airplane at a distance of 1.5 km (0.94 miles), or a person more than 300 meters (984 ft.) away.

The most sensitive systems up to this time were all based upon variations of the bolometer idea, but the period between the two wars saw the development of two revolutionary new infrared detectors: the image converter and the photon detector. At first, the image converter received the greatest attention by the military, because it enabled an observer for the first time in history to literally 'see in the dark'. However, the sensitivity of the image converter was limited to the near infrared wavelengths, and the most interesting military targets (i.e. enemy soldiers) had to be illuminated by infrared search beams. Since this involved the risk of giving away the observer's position to a similarly-equipped enemy observer, it is understandable that military interest in the image converter eventually faded.

The tactical military disadvantages of so-called 'active' (i.e. search beam-equipped) thermal imaging systems provided impetus following the 1939–45 war for extensive secret military infrared-research programs into the possibilities of developing 'passive' (no search beam) systems around the extremely sensitive photon detector. During this period, military secrecy regulations completely prevented disclosure of the status of infrared-imaging technology. This secrecy only began to be lifted in the middle of the 1950's, and from that time adequate thermal-imaging devices finally began to be available to civilian science and industry.

### 32.1 Introduction

The subjects of infrared radiation and the related technique of thermography are still new to many who will use an infrared camera. In this section the theory behind thermography will be given.

### 32.2 The electromagnetic spectrum

The electromagnetic spectrum is divided arbitrarily into a number of wavelength regions, called *bands*, distinguished by the methods used to produce and detect the radiation. There is no fundamental difference between radiation in the different bands of the electromagnetic spectrum. They are all governed by the same laws and the only differences are those due to differences in wavelength.

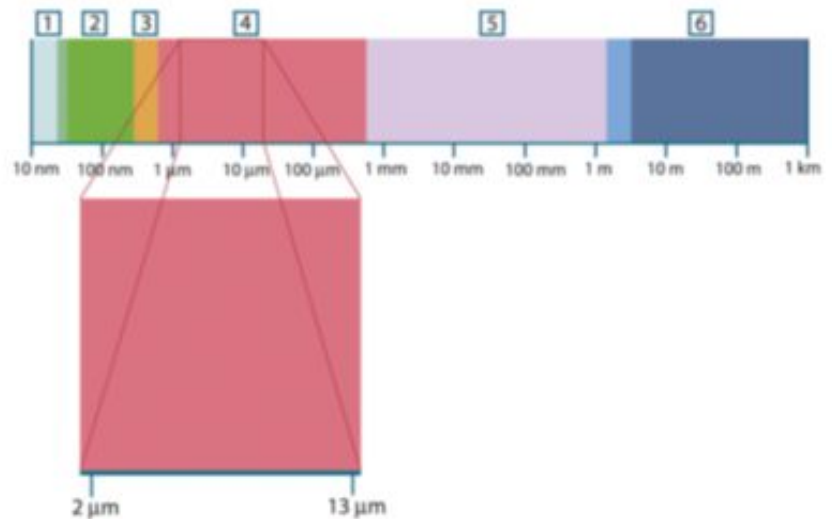

**Figure 32.1** The electromagnetic spectrum. 1: X-ray; 2: UV; 3: Visible; 4: IR; 5: Microwaves; 6: Radiowaves.

Thermography makes use of the infrared spectral band. At the short-wavelength end the boundary lies at the limit of visual perception, in the deep red. At the long-wavelength end it merges with the microwave radio wavelengths, in the millimeter range.

The infrared band is often further subdivided into four smaller bands, the boundaries of which are also arbitrarily chosen. They include: the *near infrared* (0.75–3  $\mu\text{m}$ ), the *middle infrared* (3–6  $\mu\text{m}$ ), the *far infrared* (6–15  $\mu\text{m}$ ) and the *extreme infrared* (15–100  $\mu\text{m}$ ). Although the wavelengths are given in  $\mu\text{m}$  (micrometers), other units are often still used to measure wavelength in this spectral region, e.g. nanometer (nm) and Ångström (Å).

The relationships between the different wavelength measurements is:

$$10\,000\ \text{Å} = 1\,000\ \text{nm} = 1\ \mu = 1\ \mu\text{m}$$

### 32.3 Blackbody radiation

A blackbody is defined as an object which absorbs all radiation that impinges on it at any wavelength. The apparent misnomer *black* relating to an object emitting radiation is explained by Kirchhoff's Law (after *Gustav Robert Kirchhoff*, 1824–1887), which states that a body capable of absorbing all radiation at any wavelength is equally capable in the emission of radiation.



**Figure 32.2** Gustav Robert Kirchhoff (1824–1887)

The construction of a blackbody source is, in principle, very simple. The radiation characteristics of an aperture in an isothermal cavity made of an opaque absorbing material represents almost exactly the properties of a blackbody. A practical application of the principle to the construction of a perfect absorber of radiation consists of a box that is light tight except for an aperture in one of the sides. Any radiation which then enters the hole is scattered and absorbed by repeated reflections so only an infinitesimal fraction can possibly escape. The blackness which is obtained at the aperture is nearly equal to a blackbody and almost perfect for all wavelengths.

By providing such an isothermal cavity with a suitable heater it becomes what is termed a *cavity radiator*. An isothermal cavity heated to a uniform temperature generates blackbody radiation, the characteristics of which are determined solely by the temperature of the cavity. Such cavity radiators are commonly used as sources of radiation in temperature reference standards in the laboratory for calibrating thermographic instruments, such as a Flir Systems camera for example.

If the temperature of blackbody radiation increases to more than 525°C (977°F), the source begins to be visible so that it appears to the eye no longer black. This is the incipient red heat temperature of the radiator, which then becomes orange or yellow as the temperature increases further. In fact, the definition of the so-called *color temperature* of an object is the temperature to which a blackbody would have to be heated to have the same appearance.

Now consider three expressions that describe the radiation emitted from a blackbody.

### 32.3.1 Planck's law



**Figure 32.3** Max Planck (1858–1947)

*Max Planck* (1858–1947) was able to describe the spectral distribution of the radiation from a blackbody by means of the following formula:

$$W_{\lambda} = \frac{2\pi hc^2}{\lambda^5 \left( e^{hc/\lambda T} - 1 \right)} \times 10^{-6} [\text{Watt} / \text{m}^2, \mu\text{m}]$$

where:

$W_{\lambda b}$	Blackbody spectral radiant emittance at wavelength $\lambda$ .
$c$	Velocity of light = $3 \times 10^8$ m/s
$h$	Planck's constant = $6.6 \times 10^{-34}$ Joule sec.
$k$	Boltzmann's constant = $1.4 \times 10^{-23}$ Joule/K.
$T$	Absolute temperature (K) of a blackbody.
$\lambda$	Wavelength ( $\mu\text{m}$ ).

**Note**  
The factor  $10^{-6}$  is used since spectral emittance in the curves is expressed in Watt/m<sup>2</sup>,  $\mu\text{m}$ .

Planck's formula, when plotted graphically for various temperatures, produces a family of curves. Following any particular Planck curve, the spectral emittance is zero at  $\lambda = 0$ , then increases rapidly to a maximum at a wavelength  $\lambda_{\text{max}}$  and after passing it approaches zero again at very long wavelengths. The higher the temperature, the shorter the wavelength at which maximum occurs.

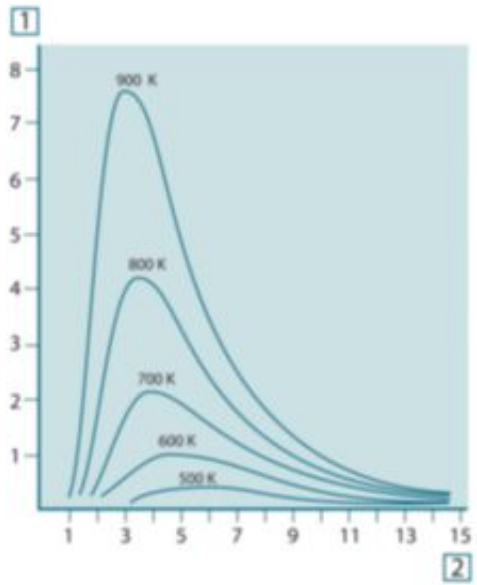

**Figure 32.4** Blackbody spectral radiant emittance according to Planck's law, plotted for various absolute temperatures. 1: Spectral radiant emittance (W/cm<sup>2</sup> × 10<sup>3</sup>( $\mu\text{m}$ )); 2: Wavelength ( $\mu\text{m}$ )

**32.3.2 Wien's displacement law**

By differentiating Planck's formula with respect to  $\lambda$ , and finding the maximum, we have:

$$\lambda_{\text{max}} = \frac{2898}{T} [\mu\text{m}]$$

This is Wien's formula (after *Wilhelm Wien*, 1864–1928), which expresses mathematically the common observation that colors vary from red to orange or yellow as the temperature of a thermal radiator increases. The wavelength of the color is the same as the wavelength calculated for  $\lambda_{\text{max}}$ . A good approximation of the value of  $\lambda_{\text{max}}$  for a given blackbody temperature is obtained by applying the rule-of-thumb  $3\,000/T \mu\text{m}$ . Thus, a very hot star such as Sirius (11 000 K), emitting bluish-white light, radiates with the peak of spectral radiant emittance occurring within the invisible ultraviolet spectrum, at wavelength  $0.27 \mu\text{m}$ .



**Figure 32.5** Wilhelm Wien (1864–1928)

The sun (approx. 6 000 K) emits yellow light, peaking at about 0.5  $\mu\text{m}$  in the middle of the visible light spectrum.

At room temperature (300 K) the peak of radiant emittance lies at 9.7  $\mu\text{m}$ , in the far infra-red, while at the temperature of liquid nitrogen (77 K) the maximum of the almost insignificant amount of radiant emittance occurs at 38  $\mu\text{m}$ , in the extreme infrared wavelengths.

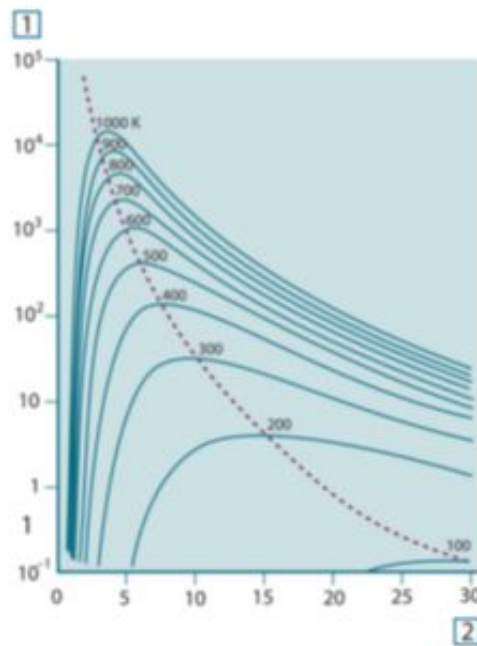

**Figure 32.6** Planckian curves plotted on semi-log scales from 100 K to 1000 K. The dotted line represents the locus of maximum radiant emittance at each temperature as described by Wien's displacement law. 1: Spectral radiant emittance ( $\text{W}/\text{cm}^2$  ( $\mu\text{m}$ )); 2: Wavelength ( $\mu\text{m}$ ).

### 32.3.3 Stefan-Boltzmann's law

By integrating Planck's formula from  $\lambda = 0$  to  $\lambda = \infty$ , we obtain the total radiant emittance ( $W_b$ ) of a blackbody:

$$W_b = \sigma T^4 \quad [\text{Watt}/\text{m}^2]$$

This is the Stefan-Boltzmann formula (after *Josef Stefan*, 1835–1893, and *Ludwig Boltzmann*, 1844–1906), which states that the total emissive power of a blackbody is proportional to the fourth power of its absolute temperature. Graphically,  $W_b$  represents the area below the Planck curve for a particular temperature. It can be shown that the radiant emittance in the interval  $\lambda = 0$  to  $\lambda_{\text{max}}$  is only 25% of the total, which represents about the amount of the sun's radiation which lies inside the visible light spectrum.



**Figure 32.7** Josef Stefan (1835–1893), and Ludwig Boltzmann (1844–1906)

Using the Stefan-Boltzmann formula to calculate the power radiated by the human body, at a temperature of 300 K and an external surface area of approx. 2 m<sup>2</sup>, we obtain 1 kW. This power loss could not be sustained if it were not for the compensating absorption of radiation from surrounding surfaces, at room temperatures which do not vary too drastically from the temperature of the body – or, of course, the addition of clothing.

### 32.3.4 Non-blackbody emitters

So far, only blackbody radiators and blackbody radiation have been discussed. However, real objects almost never comply with these laws over an extended wavelength region – although they may approach the blackbody behavior in certain spectral intervals. For example, a certain type of white paint may appear perfectly *white* in the visible light spectrum, but becomes distinctly *gray* at about 2 μm, and beyond 3 μm it is almost *black*.

There are three processes which can occur that prevent a real object from acting like a blackbody: a fraction of the incident radiation  $\alpha$  may be absorbed, a fraction  $\rho$  may be reflected, and a fraction  $\tau$  may be transmitted. Since all of these factors are more or less wavelength dependent, the subscript  $\lambda$  is used to imply the spectral dependence of their definitions. Thus:

- The spectral absorptance  $\alpha_\lambda$  = the ratio of the spectral radiant power absorbed by an object to that incident upon it.
- The spectral reflectance  $\rho_\lambda$  = the ratio of the spectral radiant power reflected by an object to that incident upon it.
- The spectral transmittance  $\tau_\lambda$  = the ratio of the spectral radiant power transmitted through an object to that incident upon it.

The sum of these three factors must always add up to the whole at any wavelength, so we have the relation:

$$\alpha_\lambda + \rho_\lambda + \tau_\lambda = 1$$

For opaque materials  $\tau_\lambda = 0$  and the relation simplifies to:

$$\alpha_\lambda + \rho_\lambda = 1$$

Another factor, called the emissivity, is required to describe the fraction  $\varepsilon$  of the radiant emittance of a blackbody produced by an object at a specific temperature. Thus, we have the definition:

The spectral emissivity  $\varepsilon_\lambda$  = the ratio of the spectral radiant power from an object to that from a blackbody at the same temperature and wavelength.

Expressed mathematically, this can be written as the ratio of the spectral emittance of the object to that of a blackbody as follows:

$$\varepsilon_\lambda = \frac{W_{\lambda o}}{W_{\lambda b}}$$

Generally speaking, there are three types of radiation source, distinguished by the ways in which the spectral emittance of each varies with wavelength.

- A blackbody, for which  $\varepsilon_\lambda = \varepsilon = 1$
- A graybody, for which  $\varepsilon_\lambda = \varepsilon = \text{constant less than } 1$

- A selective radiator, for which  $\epsilon$  varies with wavelength

According to Kirchhoff's law, for any material the spectral emissivity and spectral absorptance of a body are equal at any specified temperature and wavelength. That is:

$$\epsilon_\lambda = \alpha_\lambda$$

From this we obtain, for an opaque material (since  $\alpha_\lambda + \rho_\lambda = 1$ ):

$$\epsilon_\lambda + \rho_\lambda = 1$$

For highly polished materials  $\epsilon_\lambda$  approaches zero, so that for a perfectly reflecting material (*i.e.* a perfect mirror) we have:

$$\rho_\lambda = 1$$

For a graybody radiator, the Stefan-Boltzmann formula becomes:

$$W = \epsilon \sigma T^4 \text{ [Watt/m}^2\text{]}$$

This states that the total emissive power of a graybody is the same as a blackbody at the same temperature reduced in proportion to the value of  $\epsilon$  from the graybody.

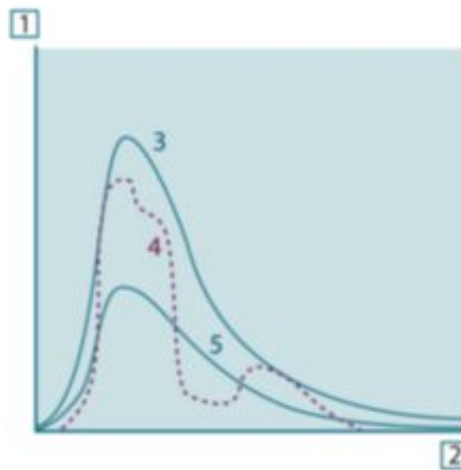

**Figure 32.8** Spectral radiant emittance of three types of radiators. 1: Spectral radiant emittance; 2: Wavelength; 3: Blackbody; 4: Selective radiator; 5: Graybody.



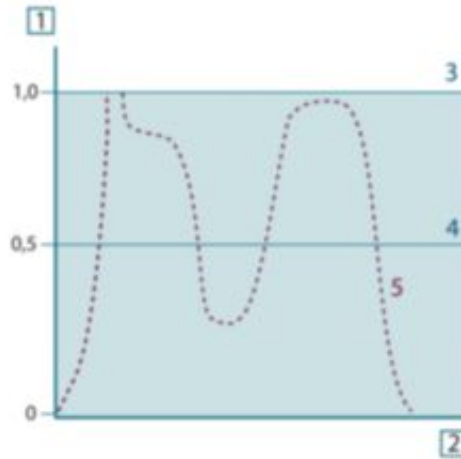

**Figure 32.9** Spectral emissivity of three types of radiators. 1: Spectral emissivity; 2: Wavelength; 3: Blackbody; 4: Graybody; 5: Selective radiator.

### 32.4 Infrared semi-transparent materials

Consider now a non-metallic, semi-transparent body – let us say, in the form of a thick flat plate of plastic material. When the plate is heated, radiation generated within its volume must work its way toward the surfaces through the material in which it is partially absorbed. Moreover, when it arrives at the surface, some of it is reflected back into the interior. The back-reflected radiation is again partially absorbed, but some of it arrives at the other surface, through which most of it escapes; part of it is reflected back again. Although the progressive reflections become weaker and weaker they must all be added up when the total emittance of the plate is sought. When the resulting geometrical series is summed, the effective emissivity of a semi-transparent plate is obtained as:

$$\epsilon_{\lambda} = \frac{(1 - \rho_{\lambda})(1 - \tau_{\lambda})}{1 - \rho_{\lambda}\tau_{\lambda}}$$

When the plate becomes opaque this formula is reduced to the single formula:

$$\epsilon_{\lambda} = 1 - \rho_{\lambda}$$

This last relation is a particularly convenient one, because it is often easier to measure reflectance than to measure emissivity directly.

As already mentioned, when viewing an object, the camera receives radiation not only from the object itself. It also collects radiation from the surroundings reflected via the object surface. Both these radiation contributions become attenuated to some extent by the atmosphere in the measurement path. To this comes a third radiation contribution from the atmosphere itself.

This description of the measurement situation, as illustrated in the figure below, is so far a fairly true description of the real conditions. What has been neglected could for instance be sun light scattering in the atmosphere or stray radiation from intense radiation sources outside the field of view. Such disturbances are difficult to quantify, however, in most cases they are fortunately small enough to be neglected. In case they are not negligible, the measurement configuration is likely to be such that the risk for disturbance is obvious, at least to a trained operator. It is then his responsibility to modify the measurement situation to avoid the disturbance e.g. by changing the viewing direction, shielding off intense radiation sources etc.

Accepting the description above, we can use the figure below to derive a formula for the calculation of the object temperature from the calibrated camera output.

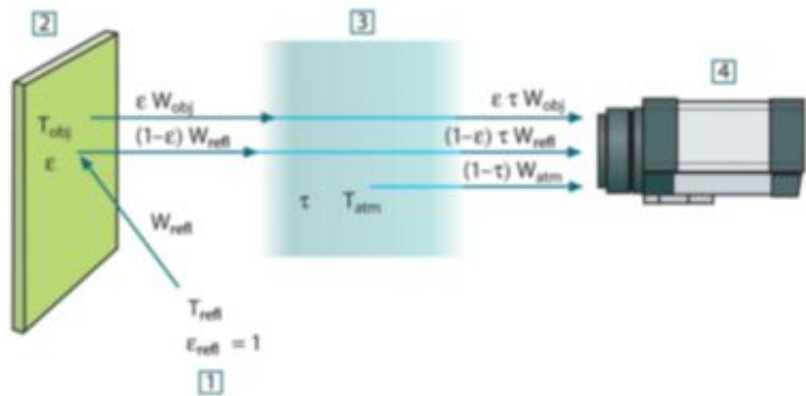

**Figure 33.1** A schematic representation of the general thermographic measurement situation. 1: Surroundings; 2: Object; 3: Atmosphere; 4: Camera

Assume that the received radiation power  $W$  from a blackbody source of temperature  $T_{\text{source}}$  on short distance generates a camera output signal  $U_{\text{source}}$  that is proportional to the power input (power linear camera). We can then write (Equation 1):

$$U_{\text{source}} = CW(T_{\text{source}})$$

or, with simplified notation:

$$U_{\text{source}} = CW_{\text{source}}$$

where  $C$  is a constant.

Should the source be a graybody with emissance  $\epsilon$ , the received radiation would consequently be  $\epsilon W_{\text{source}}$ .

We are now ready to write the three collected radiation power terms:

1. *Emission from the object* =  $\epsilon\tau W_{\text{obj}}$ , where  $\epsilon$  is the emissance of the object and  $\tau$  is the transmittance of the atmosphere. The object temperature is  $T_{\text{obj}}$ .

2. *Reflected emission from ambient sources* =  $(1 - \varepsilon)\tau W_{refl}$ , where  $(1 - \varepsilon)$  is the reflectance of the object. The ambient sources have the temperature  $T_{refl}$ .

It has here been assumed that the temperature  $T_{refl}$  is the same for all emitting surfaces within the halfsphere seen from a point on the object surface. This is of course sometimes a simplification of the true situation. It is, however, a necessary simplification in order to derive a workable formula, and  $T_{refl}$  can – at least theoretically – be given a value that represents an efficient temperature of a complex surrounding.

Note also that we have assumed that the emittance for the surroundings = 1. This is correct in accordance with Kirchhoff's law: All radiation impinging on the surrounding surfaces will eventually be absorbed by the same surfaces. Thus the emittance = 1. (Note though that the latest discussion requires the complete sphere around the object to be considered.)

3. *Emission from the atmosphere* =  $(1 - \tau)W_{atm}$ , where  $(1 - \tau)$  is the emittance of the atmosphere. The temperature of the atmosphere is  $T_{atm}$ .

The total received radiation power can now be written (Equation 2):

$$W_{tot} = \varepsilon\tau W_{obj} + (1 - \varepsilon)\tau W_{refl} + (1 - \tau)W_{atm}$$

We multiply each term by the constant C of Equation 1 and replace the CW products by the corresponding U according to the same equation, and get (Equation 3):

$$U_{tot} = \varepsilon\tau U_{obj} + (1 - \varepsilon)\tau U_{refl} + (1 - \tau)U_{atm}$$

Solve Equation 3 for  $U_{obj}$  (Equation 4):

$$U_{obj} = \frac{1}{\varepsilon\tau}U_{tot} - \frac{1 - \varepsilon}{\varepsilon}U_{refl} - \frac{1 - \tau}{\varepsilon\tau}U_{atm}$$

This is the general measurement formula used in all the Flir Systems thermographic equipment. The voltages of the formula are:

**Table 33.1** Voltages

$U_{obj}$	Calculated camera output voltage for a blackbody of temperature $T_{obj}$ i.e. a voltage that can be directly converted into true requested object temperature.
$U_{tot}$	Measured camera output voltage for the actual case.
$U_{refl}$	Theoretical camera output voltage for a blackbody of temperature $T_{refl}$ according to the calibration.
$U_{atm}$	Theoretical camera output voltage for a blackbody of temperature $T_{atm}$ according to the calibration.

The operator has to supply a number of parameter values for the calculation:

- the object emittance  $\varepsilon$ ,
- the relative humidity,
- $T_{atm}$
- object distance ( $D_{obj}$ )
- the (effective) temperature of the object surroundings, or the reflected ambient temperature  $T_{refl}$ , and
- the temperature of the atmosphere  $T_{atm}$

This task could sometimes be a heavy burden for the operator since there are normally no easy ways to find accurate values of emittance and atmospheric transmittance for the actual case. The two temperatures are normally less of a problem provided the surroundings do not contain large and intense radiation sources.

A natural question in this connection is: How important is it to know the right values of these parameters? It could though be of interest to get a feeling for this problem already here by looking into some different measurement cases and compare the relative

magnitudes of the three radiation terms. This will give indications about when it is important to use correct values of which parameters.

The figures below illustrates the relative magnitudes of the three radiation contributions for three different object temperatures, two emittances, and two spectral ranges: SW and LW. Remaining parameters have the following fixed values:

- $\tau = 0.88$
- $T_{\text{refl}} = +20^{\circ}\text{C}$  ( $+68^{\circ}\text{F}$ )
- $T_{\text{atm}} = +20^{\circ}\text{C}$  ( $+68^{\circ}\text{F}$ )

It is obvious that measurement of low object temperatures are more critical than measuring high temperatures since the 'disturbing' radiation sources are relatively much stronger in the first case. Should also the object emittance be low, the situation would be still more difficult.

We have finally to answer a question about the importance of being allowed to use the calibration curve above the highest calibration point, what we call extrapolation. Imagine that we in a certain case measure  $U_{\text{tot}} = 4.5$  volts. The highest calibration point for the camera was in the order of 4.1 volts, a value unknown to the operator. Thus, even if the object happened to be a blackbody, i.e.  $U_{\text{obj}} = U_{\text{tot}}$ , we are actually performing extrapolation of the calibration curve when converting 4.5 volts into temperature.

Let us now assume that the object is not black, it has an emittance of 0.75, and the transmittance is 0.92. We also assume that the two second terms of Equation 4 amount to 0.5 volts together. Computation of  $U_{\text{obj}}$  by means of Equation 4 then results in  $U_{\text{obj}} = 4.5 / 0.75 / 0.92 - 0.5 = 6.0$ . This is a rather extreme extrapolation, particularly when considering that the video amplifier might limit the output to 5 volts! Note, though, that the application of the calibration curve is a theoretical procedure where no electronic or other limitations exist. We trust that if there had been no signal limitations in the camera, and if it had been calibrated far beyond 5 volts, the resulting curve would have been very much the same as our real curve extrapolated beyond 4.1 volts, provided the calibration algorithm is based on radiation physics, like the Flir Systems algorithm. Of course there must be a limit to such extrapolations.

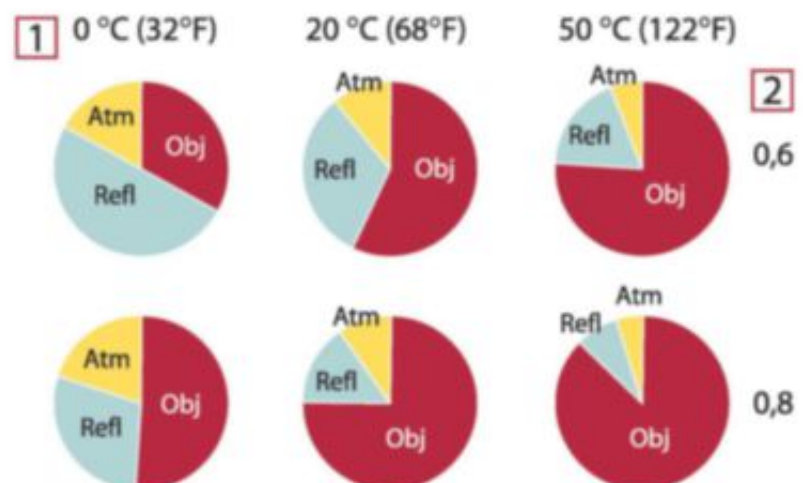

**Figure 33.2** Relative magnitudes of radiation sources under varying measurement conditions (SW camera). 1: Object temperature; 2: Emittance; Obj: Object radiation; Refl: Reflected radiation; Atm: atmosphere radiation. Fixed parameters:  $\tau = 0.88$ ;  $T_{\text{refl}} = 20^{\circ}\text{C}$  ( $+68^{\circ}\text{F}$ );  $T_{\text{atm}} = 20^{\circ}\text{C}$  ( $+68^{\circ}\text{F}$ ).

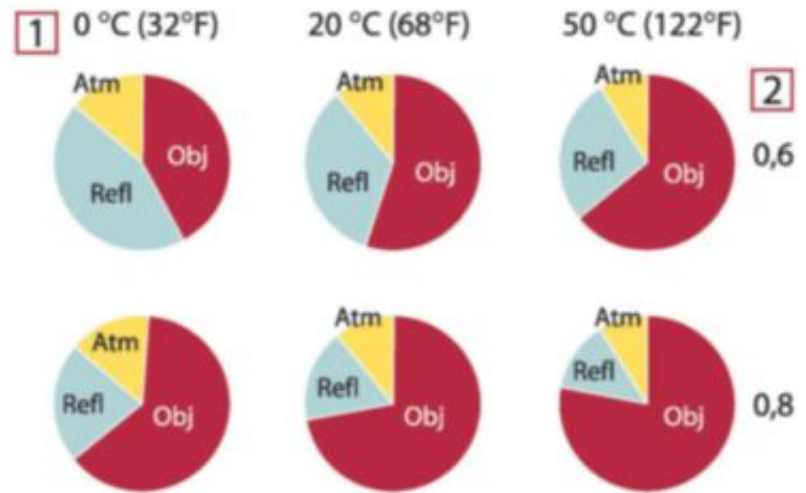

**Figure 33.3** Relative magnitudes of radiation sources under varying measurement conditions (LW camera). 1: Object temperature; 2: Emittance; Obj: Object radiation; Refl: Reflected radiation; Atm: atmosphere radiation. Fixed parameters:  $\tau = 0.88$ ;  $T_{\text{refl}} = 20^\circ\text{C}$  (+68°F);  $T_{\text{atm}} = 20^\circ\text{C}$  (+68°F).

This section presents a compilation of emissivity data from the infrared literature and measurements made by Flir Systems.

### 34.1 References

1. Mikael A. Bramson: *Infrared Radiation, A Handbook for Applications*, Plenum press, N.Y.
2. William L. Wolfe, George J. Zissis: *The Infrared Handbook*, Office of Naval Research, Department of Navy, Washington, D.C.
3. Madding, R. P.: *Thermographic Instruments and systems*. Madison, Wisconsin: University of Wisconsin – Extension, Department of Engineering and Applied Science.
4. William L. Wolfe: *Handbook of Military Infrared Technology*, Office of Naval Research, Department of Navy, Washington, D.C.
5. Jones, Smith, Probert: *External thermography of buildings...*, Proc. of the Society of Photo-Optical Instrumentation Engineers, vol.110, Industrial and Civil Applications of Infrared Technology, June 1977 London.
6. Paljak, Pettersson: *Thermography of Buildings*, Swedish Building Research Institute, Stockholm 1972.
7. Vlcek, J: *Determination of emissivity with imaging radiometers and some emissivities at  $\lambda = 5 \mu\text{m}$* . Photogrammetric Engineering and Remote Sensing.
8. Kern: *Evaluation of infrared emission of clouds and ground as measured by weather satellites*, Defence Documentation Center, AD 617 417.
9. Öhman, Claes: *Emittansmätningar med AGEMA E-Box*. Teknisk rapport, AGEMA 1999. (Emittance measurements using AGEMA E-Box. Technical report, AGEMA 1999.)
10. Mattei, S., Tang-Kwor, E: *Emissivity measurements for Nextel Velvet coating 811-21 between  $-36^{\circ}\text{C}$  AND  $82^{\circ}\text{C}$* .
11. Lohrengel & Todtenhaupt (1996)
12. ITC Technical publication 32.
13. ITC Technical publication 29.

#### Note

The emissivity values in the table below are recorded using a shortwave (SW) camera. The values should be regarded as recommendations only and used with caution.

### 34.2 Tables

**Table 34.1** T: Total spectrum; SW: 2–5  $\mu\text{m}$ ; LW: 8–14  $\mu\text{m}$ , LLW: 6.5–20  $\mu\text{m}$ ; 1: Material; 2: Specification; 3: Temperature in  $^{\circ}\text{C}$ ; 4: Spectrum; 5: Emissivity; 6: Reference

1	2	3	4	5	6
3M type 35	Vinyl electrical tape (several colors)	< 80	LW	Ca. 0.96	13
3M type 88	Black vinyl electrical tape	< 105	LW	Ca. 0.96	13
3M type 88	Black vinyl electrical tape	< 105	MW	< 0.96	13
3M type Super 33+	Black vinyl electrical tape	< 80	LW	Ca. 0.96	13
Aluminum	anodized sheet	100	T	0.55	2
Aluminum	anodized, black, dull	70	SW	0.67	9
Aluminum	anodized, black, dull	70	LW	0.95	9
Aluminum	anodized, light gray, dull	70	SW	0.61	9
Aluminum	anodized, light gray, dull	70	LW	0.97	9

**Table 34.1** T: Total spectrum; SW: 2–5  $\mu\text{m}$ ; LW: 8–14  $\mu\text{m}$ , LLW: 6.5–20  $\mu\text{m}$ ; 1: Material; 2: Specification; 3: Temperature in  $^{\circ}\text{C}$ ; 4: Spectrum; 5: Emissivity; 6: Reference (continued)

1	2	3	4	5	6
Aluminum	as received, plate	100	T	0.09	4
Aluminum	as received, sheet	100	T	0.09	2
Aluminum	cast, blast cleaned	70	SW	0.47	9
Aluminum	cast, blast cleaned	70	LW	0.46	9
Aluminum	dipped in $\text{HNO}_3$ , plate	100	T	0.05	4
Aluminum	foil	27	10 $\mu\text{m}$	0.04	3
Aluminum	foil	27	3 $\mu\text{m}$	0.09	3
Aluminum	oxidized, strongly	50–500	T	0.2–0.3	1
Aluminum	polished	50–100	T	0.04–0.06	1
Aluminum	polished plate	100	T	0.05	4
Aluminum	polished, sheet	100	T	0.05	2
Aluminum	rough surface	20–50	T	0.06–0.07	1
Aluminum	roughened	27	10 $\mu\text{m}$	0.18	3
Aluminum	roughened	27	3 $\mu\text{m}$	0.28	3
Aluminum	sheet, 4 samples differently scratched	70	SW	0.05–0.08	9
Aluminum	sheet, 4 samples differently scratched	70	LW	0.03–0.06	9
Aluminum	vacuum deposited	20	T	0.04	2
Aluminum	weathered, heavily	17	SW	0.83–0.94	5
Aluminum bronze		20	T	0.60	1
Aluminum hydroxide	powder		T	0.28	1
Aluminum oxide	activated, powder		T	0.46	1
Aluminum oxide	pure, powder (alumina)		T	0.16	1
Asbestos	board	20	T	0.96	1
Asbestos	fabric		T	0.78	1
Asbestos	floor tile	35	SW	0.94	7
Asbestos	paper	40–400	T	0.93–0.95	1
Asbestos	powder		T	0.40–0.60	1
Asbestos	slate	20	T	0.96	1
Asphalt paving		4	LLW	0.967	8
Brass	dull, tarnished	20–350	T	0.22	1
Brass	oxidized	100	T	0.61	2
Brass	oxidized	70	SW	0.04–0.09	9
Brass	oxidized	70	LW	0.03–0.07	9
Brass	oxidized at $600^{\circ}\text{C}$	200–600	T	0.59–0.61	1
Brass	polished	200	T	0.03	1
Brass	polished, highly	100	T	0.03	2

**Table 34.1** T: Total spectrum; SW: 2–5  $\mu\text{m}$ ; LW: 8–14  $\mu\text{m}$ , LLW: 6.5–20  $\mu\text{m}$ ; 1: Material; 2: Specification; 3: Temperature in  $^{\circ}\text{C}$ ; 4: Spectrum; 5: Emissivity; 6: Reference (continued)

1	2	3	4	5	6
Brass	rubbed with 80-grit emery	20	T	0.20	2
Brass	sheet, rolled	20	T	0.06	1
Brass	sheet, worked with emery	20	T	0.2	1
Brick	alumina	17	SW	0.68	5
Brick	common	17	SW	0.86–0.81	5
Brick	Dinas silica, glazed, rough	1100	T	0.85	1
Brick	Dinas silica, refractory	1000	T	0.66	1
Brick	Dinas silica, unglazed, rough	1000	T	0.80	1
Brick	firebrick	17	SW	0.68	5
Brick	fireclay	1000	T	0.75	1
Brick	fireclay	1200	T	0.59	1
Brick	fireclay	20	T	0.85	1
Brick	masonry	35	SW	0.94	7
Brick	masonry, plastered	20	T	0.94	1
Brick	red, common	20	T	0.93	2
Brick	red, rough	20	T	0.88–0.93	1
Brick	refractory, corundum	1000	T	0.46	1
Brick	refractory, magnesite	1000–1300	T	0.38	1
Brick	refractory, strongly radiating	500–1000	T	0.8–0.9	1
Brick	refractory, weakly radiating	500–1000	T	0.65–0.75	1
Brick	silica, 95% $\text{SiO}_2$	1230	T	0.66	1
Brick	sillimanite, 33% $\text{SiO}_2$ , 64% $\text{Al}_2\text{O}_3$	1500	T	0.29	1
Brick	waterproof	17	SW	0.87	5
Bronze	phosphor bronze	70	SW	0.08	9
Bronze	phosphor bronze	70	LW	0.06	9
Bronze	polished	50	T	0.1	1
Bronze	porous, rough	50–150	T	0.55	1
Bronze	powder		T	0.76–0.80	1
Carbon	candle soot	20	T	0.95	2
Carbon	charcoal powder		T	0.96	1
Carbon	graphite powder		T	0.97	1
Carbon	graphite, filed surface	20	T	0.98	2
Carbon	lampblack	20–400	T	0.95–0.97	1
Chipboard	untreated	20	SW	0.90	6
Chromium	polished	50	T	0.10	1



**Table 34.1** T: Total spectrum; SW: 2–5  $\mu\text{m}$ ; LW: 8–14  $\mu\text{m}$ , LLW: 6.5–20  $\mu\text{m}$ ; 1: Material; 2: Specification; 3: Temperature in  $^{\circ}\text{C}$ ; 4: Spectrum; 5: Emissivity; 6: Reference (continued)

1	2	3	4	5	6
Chromium	polished	500–1000	T	0.28–0.38	1
Clay	fired	70	T	0.91	1
Cloth	black	20	T	0.98	1
Concrete		20	T	0.92	2
Concrete	dry	36	SW	0.95	7
Concrete	rough	17	SW	0.97	5
Concrete	walkway	5	LLW	0.974	8
Copper	commercial, burnished	20	T	0.07	1
Copper	electrolytic, carefully polished	80	T	0.018	1
Copper	electrolytic, polished	–34	T	0.006	4
Copper	molten	1100–1300	T	0.13–0.15	1
Copper	oxidized	50	T	0.6–0.7	1
Copper	oxidized to blackness		T	0.88	1
Copper	oxidized, black	27	T	0.78	4
Copper	oxidized, heavily	20	T	0.78	2
Copper	polished	50–100	T	0.02	1
Copper	polished	100	T	0.03	2
Copper	polished, commercial	27	T	0.03	4
Copper	polished, mechanical	22	T	0.015	4
Copper	pure, carefully prepared surface	22	T	0.008	4
Copper	scraped	27	T	0.07	4
Copper dioxide	powder		T	0.84	1
Copper oxide	red, powder		T	0.70	1
Ebonite			T	0.89	1
Emery	coarse	80	T	0.85	1
Enamel		20	T	0.9	1
Enamel	lacquer	20	T	0.85–0.95	1
Fiber board	hard, untreated	20	SW	0.85	6
Fiber board	masonite	70	SW	0.75	9
Fiber board	masonite	70	LW	0.88	9
Fiber board	particle board	70	SW	0.77	9
Fiber board	particle board	70	LW	0.89	9
Fiber board	porous, untreated	20	SW	0.85	6
Gold	polished	130	T	0.018	1
Gold	polished, carefully	200–600	T	0.02–0.03	1
Gold	polished, highly	100	T	0.02	2
Granite	polished	20	LLW	0.849	8
Granite	rough	21	LLW	0.879	8

**Table 34.1** T: Total spectrum; SW: 2–5  $\mu\text{m}$ ; LW: 8–14  $\mu\text{m}$ , LLW: 6.5–20  $\mu\text{m}$ ; 1: Material; 2: Specification; 3: Temperature in  $^{\circ}\text{C}$ ; 4: Spectrum; 5: Emissivity; 6: Reference (continued)

1	2	3	4	5	6
Granite	rough, 4 different samples	70	SW	0.95–0.97	9
Granite	rough, 4 different samples	70	LW	0.77–0.87	9
Gypsum		20	T	0.8–0.9	1
Ice: See Water					
Iron and steel	cold rolled	70	SW	0.20	9
Iron and steel	cold rolled	70	LW	0.09	9
Iron and steel	covered with red rust	20	T	0.61–0.85	1
Iron and steel	electrolytic	100	T	0.05	4
Iron and steel	electrolytic	22	T	0.05	4
Iron and steel	electrolytic	260	T	0.07	4
Iron and steel	electrolytic, carefully polished	175–225	T	0.05–0.06	1
Iron and steel	freshly worked with emery	20	T	0.24	1
Iron and steel	ground sheet	950–1100	T	0.55–0.61	1
Iron and steel	heavily rusted sheet	20	T	0.69	2
Iron and steel	hot rolled	130	T	0.60	1
Iron and steel	hot rolled	20	T	0.77	1
Iron and steel	oxidized	100	T	0.74	4
Iron and steel	oxidized	100	T	0.74	1
Iron and steel	oxidized	1227	T	0.89	4
Iron and steel	oxidized	125–525	T	0.78–0.82	1
Iron and steel	oxidized	200	T	0.79	2
Iron and steel	oxidized	200–600	T	0.80	1
Iron and steel	oxidized strongly	50	T	0.88	1
Iron and steel	oxidized strongly	500	T	0.98	1
Iron and steel	polished	100	T	0.07	2
Iron and steel	polished	400–1000	T	0.14–0.38	1
Iron and steel	polished sheet	750–1050	T	0.52–0.56	1
Iron and steel	rolled sheet	50	T	0.56	1
Iron and steel	rolled, freshly	20	T	0.24	1
Iron and steel	rough, plane surface	50	T	0.95–0.98	1
Iron and steel	rusted red, sheet	22	T	0.69	4
Iron and steel	rusted, heavily	17	SW	0.96	5
Iron and steel	rusty, red	20	T	0.69	1
Iron and steel	shiny oxide layer, sheet,	20	T	0.82	1
Iron and steel	shiny, etched	150	T	0.16	1
Iron and steel	wrought, carefully polished	40–250	T	0.28	1
Iron galvanized	heavily oxidized	70	SW	0.64	9
Iron galvanized	heavily oxidized	70	LW	0.85	9

**Table 34.1** T: Total spectrum; SW: 2–5  $\mu\text{m}$ ; LW: 8–14  $\mu\text{m}$ , LLW: 6.5–20  $\mu\text{m}$ ; 1: Material; 2: Specification; 3: Temperature in  $^{\circ}\text{C}$ ; 4: Spectrum; 5: Emissivity; 6: Reference (continued)

1	2	3	4	5	6
Iron galvanized	sheet	92	T	0.07	4
Iron galvanized	sheet, burnished	30	T	0.23	1
Iron galvanized	sheet, oxidized	20	T	0.28	1
Iron tinned	sheet	24	T	0.064	4
Iron, cast	casting	50	T	0.81	1
Iron, cast	ingots	1000	T	0.95	1
Iron, cast	liquid	1300	T	0.28	1
Iron, cast	machined	800–1000	T	0.60–0.70	1
Iron, cast	oxidized	100	T	0.64	2
Iron, cast	oxidized	260	T	0.66	4
Iron, cast	oxidized	38	T	0.63	4
Iron, cast	oxidized	538	T	0.76	4
Iron, cast	oxidized at 600 $^{\circ}\text{C}$	200–600	T	0.64–0.78	1
Iron, cast	polished	200	T	0.21	1
Iron, cast	polished	38	T	0.21	4
Iron, cast	polished	40	T	0.21	2
Iron, cast	unworked	900–1100	T	0.87–0.95	1
Krylon Ultra-flat black 1602	Flat black	Room temperature up to 175	LW	Ca. 0.96	12
Krylon Ultra-flat black 1602	Flat black	Room temperature up to 175	MW	Ca. 0.97	12
Lacquer	3 colors sprayed on Aluminum	70	SW	0.50–0.53	9
Lacquer	3 colors sprayed on Aluminum	70	LW	0.92–0.94	9
Lacquer	Aluminum on rough surface	20	T	0.4	1
Lacquer	bakelite	80	T	0.83	1
Lacquer	black, dull	40–100	T	0.96–0.98	1
Lacquer	black, matte	100	T	0.97	2
Lacquer	black, shiny, sprayed on iron	20	T	0.87	1
Lacquer	heat-resistant	100	T	0.92	1
Lacquer	white	100	T	0.92	2
Lacquer	white	40–100	T	0.8–0.95	1
Lead	oxidized at 200 $^{\circ}\text{C}$	200	T	0.63	1
Lead	oxidized, gray	20	T	0.28	1
Lead	oxidized, gray	22	T	0.28	4
Lead	shiny	250	T	0.08	1
Lead	unoxidized, polished	100	T	0.05	4
Lead red		100	T	0.93	4
Lead red, powder		100	T	0.93	1
Leather	tanned		T	0.75–0.80	1
Lime			T	0.3–0.4	1

**Table 34.1** T: Total spectrum; SW: 2–5  $\mu\text{m}$ ; LW: 8–14  $\mu\text{m}$ , LLW: 6.5–20  $\mu\text{m}$ ; 1: Material; 2: Specification; 3: Temperature in  $^{\circ}\text{C}$ ; 4: Spectrum; 5: Emissivity; 6: Reference (continued)

1	2	3	4	5	6
Magnesium		22	T	0.07	4
Magnesium		260	T	0.13	4
Magnesium		538	T	0.18	4
Magnesium	polished	20	T	0.07	2
Magnesium powder			T	0.86	1
Molybdenum		1500–2200	T	0.19–0.26	1
Molybdenum		600–1000	T	0.08–0.13	1
Molybdenum	filament	700–2500	T	0.1–0.3	1
Mortar		17	SW	0.87	5
Mortar	dry	36	SW	0.94	7
Nextel Velvet 811-21 Black	Flat black	–60–150	LW	> 0.97	10 and 11
Nichrome	rolled	700	T	0.25	1
Nichrome	sandblasted	700	T	0.70	1
Nichrome	wire, clean	50	T	0.65	1
Nichrome	wire, clean	500–1000	T	0.71–0.79	1
Nichrome	wire, oxidized	50–500	T	0.95–0.98	1
Nickel	bright matte	122	T	0.041	4
Nickel	commercially pure, polished	100	T	0.045	1
Nickel	commercially pure, polished	200–400	T	0.07–0.09	1
Nickel	electrolytic	22	T	0.04	4
Nickel	electrolytic	260	T	0.07	4
Nickel	electrolytic	38	T	0.06	4
Nickel	electrolytic	538	T	0.10	4
Nickel	electroplated on iron, polished	22	T	0.045	4
Nickel	electroplated on iron, unpolished	20	T	0.11–0.40	1
Nickel	electroplated on iron, unpolished	22	T	0.11	4
Nickel	electroplated, polished	20	T	0.05	2
Nickel	oxidized	1227	T	0.85	4
Nickel	oxidized	200	T	0.37	2
Nickel	oxidized	227	T	0.37	4
Nickel	oxidized at 600 $^{\circ}\text{C}$	200–600	T	0.37–0.48	1
Nickel	polished	122	T	0.045	4
Nickel	wire	200–1000	T	0.1–0.2	1
Nickel oxide		1000–1250	T	0.75–0.86	1
Nickel oxide		500–650	T	0.52–0.59	1
Oil, lubricating	0.025 mm film	20	T	0.27	2
Oil, lubricating	0.050 mm film	20	T	0.46	2
Oil, lubricating	0.125 mm film	20	T	0.72	2

**Table 34.1** T: Total spectrum; SW: 2–5  $\mu\text{m}$ ; LW: 8–14  $\mu\text{m}$ , LLW: 6.5–20  $\mu\text{m}$ ; 1: Material; 2: Specification; 3: Temperature in  $^{\circ}\text{C}$ ; 4: Spectrum; 5: Emissivity; 6: Reference (continued)

1	2	3	4	5	6
Oil, lubricating	film on Ni base: Ni base only	20	T	0.05	2
Oil, lubricating	thick coating	20	T	0.82	2
Paint	8 different colors and qualities	70	SW	0.88–0.96	9
Paint	8 different colors and qualities	70	LW	0.92–0.94	9
Paint	Aluminum, various ages	50–100	T	0.27–0.67	1
Paint	cadmium yellow		T	0.28–0.33	1
Paint	chrome green		T	0.65–0.70	1
Paint	cobalt blue		T	0.7–0.8	1
Paint	oil	17	SW	0.87	5
Paint	oil based, average of 16 colors	100	T	0.94	2
Paint	oil, black flat	20	SW	0.94	6
Paint	oil, black gloss	20	SW	0.92	6
Paint	oil, gray flat	20	SW	0.97	6
Paint	oil, gray gloss	20	SW	0.96	6
Paint	oil, various colors	100	T	0.92–0.96	1
Paint	plastic, black	20	SW	0.95	6
Paint	plastic, white	20	SW	0.84	6
Paper	4 different colors	70	SW	0.68–0.74	9
Paper	4 different colors	70	LW	0.92–0.94	9
Paper	black		T	0.90	1
Paper	black, dull		T	0.94	1
Paper	black, dull	70	SW	0.86	9
Paper	black, dull	70	LW	0.89	9
Paper	blue, dark		T	0.84	1
Paper	coated with black lacquer		T	0.93	1
Paper	green		T	0.85	1
Paper	red		T	0.76	1
Paper	white	20	T	0.7–0.9	1
Paper	white bond	20	T	0.93	2
Paper	white, 3 different glosses	70	SW	0.76–0.78	9
Paper	white, 3 different glosses	70	LW	0.88–0.90	9
Paper	yellow		T	0.72	1
Plaster		17	SW	0.86	5
Plaster	plasterboard, untreated	20	SW	0.90	6
Plaster	rough coat	20	T	0.91	2

**Table 34.1** T: Total spectrum; SW: 2–5 µm; LW: 8–14 µm, LLW: 6.5–20 µm; 1: Material; 2: Specification; 3: Temperature in °C; 4: Spectrum; 5: Emissivity; 6: Reference (continued)

1	2	3	4	5	6
Plastic	glass fibre laminate (printed circ. board)	70	SW	0.94	9
Plastic	glass fibre laminate (printed circ. board)	70	LW	0.91	9
Plastic	polyurethane isolation board	70	LW	0.55	9
Plastic	polyurethane isolation board	70	SW	0.29	9
Plastic	PVC, plastic floor, dull, structured	70	SW	0.94	9
Plastic	PVC, plastic floor, dull, structured	70	LW	0.93	9
Platinum		100	T	0.05	4
Platinum		1000–1500	T	0.14–0.18	1
Platinum		1094	T	0.18	4
Platinum		17	T	0.016	4
Platinum		22	T	0.03	4
Platinum		260	T	0.06	4
Platinum		538	T	0.10	4
Platinum	pure, polished	200–600	T	0.05–0.10	1
Platinum	ribbon	900–1100	T	0.12–0.17	1
Platinum	wire	1400	T	0.18	1
Platinum	wire	500–1000	T	0.10–0.16	1
Platinum	wire	50–200	T	0.06–0.07	1
Porcelain	glazed	20	T	0.92	1
Porcelain	white, shiny		T	0.70–0.75	1
Rubber	hard	20	T	0.95	1
Rubber	soft, gray, rough	20	T	0.95	1
Sand			T	0.60	1
Sand		20	T	0.90	2
Sandstone	polished	19	LLW	0.909	8
Sandstone	rough	19	LLW	0.935	8
Silver	polished	100	T	0.03	2
Silver	pure, polished	200–600	T	0.02–0.03	1
Skin	human	32	T	0.98	2
Slag	boiler	0–100	T	0.97–0.93	1
Slag	boiler	1400–1800	T	0.69–0.67	1
Slag	boiler	200–500	T	0.89–0.78	1
Slag	boiler	600–1200	T	0.76–0.70	1
Snow: See Water					
Soil	dry	20	T	0.92	2
Soil	saturated with water	20	T	0.95	2
Stainless steel	alloy, 8% Ni, 18% Cr	500	T	0.35	1
Stainless steel	rolled	700	T	0.45	1

**Table 34.1** T: Total spectrum; SW: 2–5 µm; LW: 8–14 µm, LLW: 6.5–20 µm; 1: Material; 2: Specification; 3: Temperature in °C; 4: Spectrum; 5: Emissivity; 6: Reference (continued)

1	2	3	4	5	6
Stainless steel	sandblasted	700	T	0.70	1
Stainless steel	sheet, polished	70	SW	0.18	9
Stainless steel	sheet, polished	70	LW	0.14	9
Stainless steel	sheet, untreated, somewhat scratched	70	SW	0.30	9
Stainless steel	sheet, untreated, somewhat scratched	70	LW	0.28	9
Stainless steel	type 18-8, buffed	20	T	0.16	2
Stainless steel	type 18-8, oxidized at 800°C	60	T	0.85	2
Stucco	rough, lime	10–90	T	0.91	1
Styrofoam	insulation	37	SW	0.60	7
Tar			T	0.79–0.84	1
Tar	paper	20	T	0.91–0.93	1
Tile	glazed	17	SW	0.94	5
Tin	burnished	20–50	T	0.04–0.06	1
Tin	tin-plated sheet iron	100	T	0.07	2
Titanium	oxidized at 540°C	1000	T	0.60	1
Titanium	oxidized at 540°C	200	T	0.40	1
Titanium	oxidized at 540°C	500	T	0.50	1
Titanium	polished	1000	T	0.36	1
Titanium	polished	200	T	0.15	1
Titanium	polished	500	T	0.20	1
Tungsten		1500–2200	T	0.24–0.31	1
Tungsten		200	T	0.05	1
Tungsten		600–1000	T	0.1–0.16	1
Tungsten	filament	3300	T	0.39	1
Varnish	flat	20	SW	0.93	6
Varnish	on oak parquet floor	70	SW	0.90	9
Varnish	on oak parquet floor	70	LW	0.90–0.93	9
Wallpaper	slight pattern, light gray	20	SW	0.85	6
Wallpaper	slight pattern, red	20	SW	0.90	6
Water	distilled	20	T	0.96	2
Water	frost crystals	–10	T	0.98	2
Water	ice, covered with heavy frost	0	T	0.98	1
Water	ice, smooth	0	T	0.97	1
Water	ice, smooth	–10	T	0.96	2
Water	layer >0.1 mm thick	0–100	T	0.95–0.98	1
Water	snow		T	0.8	1
Water	snow	–10	T	0.85	2

**Table 34.1** T: Total spectrum; SW: 2–5  $\mu\text{m}$ ; LW: 8–14  $\mu\text{m}$ , LLW: 6.5–20  $\mu\text{m}$ ; 1: Material; 2: Specification; 3: Temperature in  $^{\circ}\text{C}$ ; 4: Spectrum; 5: Emissivity; 6: Reference (continued)

1	2	3	4	5	6
Wood		17	SW	0.98	5
Wood		19	LLW	0.962	8
Wood	ground		T	0.5–0.7	1
Wood	pine, 4 different samples	70	SW	0.67–0.75	9
Wood	pine, 4 different samples	70	LW	0.81–0.89	9
Wood	planed	20	T	0.8–0.9	1
Wood	planed oak	20	T	0.90	2
Wood	planed oak	70	SW	0.77	9
Wood	planed oak	70	LW	0.88	9
Wood	plywood, smooth, dry	36	SW	0.82	7
Wood	plywood, untreated	20	SW	0.83	6
Wood	white, damp	20	T	0.7–0.8	1
Zinc	oxidized at 400 $^{\circ}\text{C}$	400	T	0.11	1
Zinc	oxidized surface	1000–1200	T	0.50–0.60	1
Zinc	polished	200–300	T	0.04–0.05	1
Zinc	sheet	50	T	0.20	1





---

**A note on the technical production of this publication**

This publication was produced using XML — the eXtensible Markup Language. For more information about XML, please visit <http://www.w3.org/XML/>

**A note on the typeface used in this publication**

This publication was typeset using Linotype Helvetica™ World. Helvetica™ was designed by Max Miedinger (1910–1980).

**LOEF (List Of Effective Files)**

T505471.xml.5933  
T505010.xml.5948  
T505469.xml.5929  
T505013.xml.5929  
T505217.xml.5861  
T505223.xml.5861  
T505218.xml.5910  
T505385.xml.5918  
T505386.xml.5916  
T505422.xml.5312  
T505219.xml.5908  
T505410.xml.5861  
T505472.xml.5910  
T505411.xml.5766  
T505387.xml.5892  
T505388.xml.5864  
T505423.xml.5864  
T505424.xml.5860  
T505389.xml.5910  
T505391.xml.5864  
T505661.xml.5912  
T505220.xml.5861  
T505470.xml.5935  
T505097.xml.5929  
T505412.xml.5861  
T505222.xml.5861  
T505012.xml.5433  
T505007.xml.5936  
T505004.xml.5937  
T505000.xml.5938  
T505005.xml.5939  
T505001.xml.5940  
T505006.xml.5941  
T505002.xml.5942





---

**Corporate Headquarters**

Flir System, Inc.  
27700 SW Parkway Ave.  
Wilsonville, OR 97070  
USA  
Telephone: +1-503-498-3547

**Website**

<http://www.flir.com>

**Customer support**

<http://support.flir.com>

Publ. No.: T559772  
Commit: 5948  
Head: 5948  
Language: en-US  
Modified: 2012-10-30  
Formatted: 2012-10-30