

CETECOM ICT Services is now

CTC | advanced
member of RWTÜV group

TEST REPORT

Test report no.: 1-2698/16-01-08



Testing laboratory

CTC advanced GmbH

Untertuerkheimer Strasse 6 – 10

66117 Saarbruecken / Germany

Phone: + 49 681 5 98 - 0

Fax: + 49 681 5 98 - 9075

Internet: <http://www.ctcadvanced.com>

e-mail: mail@ctcadvanced.com

Accredited Testing Laboratory:

The testing laboratory (area of testing) is accredited according to DIN EN ISO/IEC 17025 (2005) by the Deutsche Akkreditierungsstelle GmbH (DAkkS)

The accreditation is valid for the scope of testing procedures as stated in the accreditation certificate with the registration number: D-PL-12076-01-01

Applicant

FLIR Systems AB

Antennvägen 6

187 66 Täby / SWEDEN

Phone: +46 87 53 25 00

Fax: +46 87 53 23 64

Contact: Göran Skedung

e-mail: goran.skedung@flir.se

Phone: +46 87 53 27 59

Manufacturer

FLIR Systems AB

Antennvägen 6

187 66 Täby / SWEDEN

Test standard/s

47 CFR Part 15	Title 47 of the Code of Federal Regulations; Chapter I; Part 15 - Radio frequency devices
RSS - 247 Issue 1	Digital Transmission Systems (DTSS), Frequency Hopping Systems (FHSs) and Licence - Exempt Local Area Network (LE-LAN) Devices
RSS - Gen Issue 4	Spectrum Management and Telecommunications Radio Standards Specifications - General Requirements and Information for the Certification of Radio Apparatus

For further applied test standards please refer to section 3 of this test report.

Test Item

Kind of test item:	Thermal imaging camera
Model name:	FLIR-E6390
FCC ID:	ZLV-FLIRE6390
IC:	5306A-FLIRE6390
Frequency:	UNII band 5150 MHz to 5250 MHz
Technology tested:	WLAN (OFDM/a- & n HT20-mode)
Antenna:	Integrated PCB antenna
Power supply:	3.6 V DC by Li-ion battery
Temperature range:	-15°C to +50°C



This test report is electronically signed and valid without handwriting signature. For verification of the electronic signatures, the public keys can be requested at the testing laboratory.

Test report authorized:

Marco Bertolino
Lab Manager
Radio Communications & EMC

Test performed:

Andreas Luckenbill
Lab Manager
Radio Communications & EMC

1 Table of contents	
1	Table of contents2
2	General information3
2.1	Notes and disclaimer3
2.2	Application details.....3
2.3	Test laboratories sub-contracted3
3	Test standard/s and references4
4	Test environment.....5
5	Test item.....5
5.1	General description5
5.2	Additional information5
6	Description of the test setup.....6
6.1	Shielded semi anechoic chamber.....7
6.2	Shielded fully anechoic chamber8
6.3	Radiated measurements > 18 GHz.....9
6.4	AC conducted10
6.5	Conducted measurements11
7	Sequence of testing12
7.1	Sequence of testing radiated spurious 9 kHz to 30 MHz.....12
7.2	Sequence of testing radiated spurious 30 MHz to 1 GHz.....13
7.3	Sequence of testing radiated spurious 1 GHz to 18 GHz.....14
7.4	Sequence of testing radiated spurious above 18 GHz15
8	Measurement uncertainty16
9	Summary of measurement results17
10	Additional comments18
11	Measurement results19
11.1	Identify worst case data rate.....19
11.2	Gain20
11.3	Duty cycle24
11.4	Maximum output power.....26
11.4.1	Maximum output power conducted – for FCC requirements26
11.4.2	Maximum output power – for IC requirements.....32
11.5	Power spectral density.....38
11.5.1	Power spectral density – for FCC requirements.....38
11.5.2	Power spectral density – for IC requirements.....40
11.6	Spectrum bandwidth – 26 dB bandwidth42
11.7	Occupied bandwidth – 99% emission bandwidth.....47
11.8	Band edge compliance radiated.....53
11.9	TX spurious emissions radiated.....55
11.10	RX spurious emissions radiated69
11.11	Spurious emissions radiated < 30 MHz73
11.12	Spurious emissions conducted < 30 MHz.....76
12	Observations79
Annex A	Document history79
Annex B	Further information.....79
Annex C	Accreditation Certificate80

2 General information

2.1 Notes and disclaimer

The test results of this test report relate exclusively to the test item specified in this test report. CTC advanced GmbH does not assume responsibility for any conclusions and generalizations drawn from the test results with regard to other specimens or samples of the type of the equipment represented by the test item.

The test report may only be reproduced or published in full. Reproduction or publication of extracts from the report requires the prior written approval of CTC advanced GmbH.

The testing service provided by CTC advanced GmbH has been rendered under the current "General Terms and Conditions for CTC advanced GmbH".

CTC advanced GmbH will not be liable for any loss or damage resulting from false, inaccurate, inappropriate or incomplete product information provided by the customer.

Under no circumstances does the CTC advanced GmbH test report include any endorsement or warranty regarding the functionality, quality or performance of any other product or service provided.

Under no circumstances does the CTC advanced GmbH test report include or imply any product or service warranties from CTC advanced GmbH, including, without limitation, any implied warranties of merchantability, fitness for purpose, or non-infringement, all of which are expressly disclaimed by CTC advanced GmbH.

All rights and remedies regarding vendor's products and services for which CTC advanced GmbH has prepared this test report shall be provided by the party offering such products or services and not by CTC advanced GmbH. In no case this test report can be considered as a Letter of Approval.

This test report is electronically signed and valid without handwritten signature. For verification of the electronic signatures, the public keys can be requested at the testing laboratory.

2.2 Application details

Date of receipt of order:	2017-01-17
Date of receipt of test item:	2017-01-24
Start of test:	2017-01-24
End of test:	2017-01-27
Person(s) present during the test:	Mr. Göran Skedung

2.3 Test laboratories sub-contracted

None

3 Test standard/s and references

Test standard	Date	Description
47 CFR Part 15	-/-	Title 47 of the Code of Federal Regulations; Chapter I; Part 15 - Radio frequency devices
RSS - 247 Issue 1	May 2015	Digital Transmission Systems (DTSs), Frequency Hopping Systems (FHSs) and Licence - Exempt Local Area Network (LE-LAN) Devices
RSS - Gen Issue 4	November 2014	Spectrum Management and Telecommunications Radio Standards Specifications - General Requirements and Information for the Certification of Radio Apparatus

Guidance	Version	Description
UNII: KDB 789033 D02	v01r03	Guidelines for Compliance Testing of Unlicensed National Information Infrastructure (U-NII) Devices - Part 15, Subpart E
ANSI C63.4-2014	-/-	American national standard for methods of measurement of radio-noise emissions from low-voltage electrical and electronic equipment in the range of 9 kHz to 40 GHz
ANSI C63.10-2013	-/-	American national standard of procedures for compliance testing of unlicensed wireless devices

4 Test environment

Temperature	: T _{nom} T _{max} T _{min}	+23 °C during room temperature tests No tests under extreme conditions required. No tests under extreme conditions required.
Relative humidity content	:	35 %
Barometric pressure	:	1021 hpa
Power supply	: V _{nom} V _{max} V _{min}	3.6 V DC by Li-ion battery No tests under extreme conditions required. No tests under extreme conditions required.

5 Test item

5.1 General description

Kind of test item	:	Thermal imaging camera
Type identification	:	FLIR-E6390
HMN	:	-/-
PMN	:	E4, E5, E6, E8
HVIN	:	FLIR-E6390
FVIN	:	-/-
S/N serial number	:	Radiated unit: 63992323 Conducted unit: 63992115 Photos: 63992323
HW hardware status	:	1
SW software status	:	RF test mode
Frequency band	:	UNII band 5150 MHz to 5250 MHz (lowest channel 5180 MHz; highest channel 5240 MHz)
Type of radio transmission	:	OFDM
Use of frequency spectrum	:	
Type of modulation	:	(D)BPSK, (D)QPSK, 16 – QAM, 64 – QAM
Number of channels	:	4
Antenna	:	Integrated PCB antenna
Power supply	:	3.6 V DC by Li-ion battery
Temperature range	:	-15°C to +50°C

5.2 Additional information

The content of the following annexes is defined in the QA. It may be that not all of the listed annexes are necessary for this report, thus some values in between may be missing.

Test setup- and EUT-photos are included in test report: 1-2698/16-01-01_AnnexA
 1-2698/16-01-01_AnnexB
 1-2698/16-01-01_AnnexD

6 Description of the test setup

Typically, the calibrations of the test apparatus are commissioned to and performed by an accredited calibration laboratory. The calibration intervals are determined in accordance with the DIN EN ISO/IEC 17025. In addition to the external calibrations, the laboratory executes comparison measurements with other calibrated test systems or effective verifications. Weekly chamber inspections and range calibrations are performed. Where possible, RF generating and signaling equipment as well as measuring receivers and analyzers are connected to an external high-precision 10 MHz reference (GPS-based or rubidium frequency standard).

In order to simplify the identification of the equipment used at some special tests, some items of test equipment and ancillaries can be provided with an identifier or number in the equipment list below (Lab/Item).

Agenda: Kind of Calibration

k	calibration / calibrated	EK	limited calibration
ne	not required (k, ev, izw, zw not required)	zw	cyclical maintenance (external cyclical maintenance)
ev	periodic self verification	izw	internal cyclical maintenance
Ve	long-term stability recognized	g	blocked for accredited testing
v/k!	Attention: extended calibration interval		
NK!	Attention: not calibrated	*)	next calibration ordered / currently in progress

6.1 Shielded semi anechoic chamber

The radiated measurements are performed in vertical and horizontal plane in the frequency range from 9 kHz to 1 GHz in semi-anechoic chambers. The EUT is positioned on a non-conductive support with a height of 0.80 m above a conductive ground plane that covers the whole chamber. The receiving antennas are confirmed with specifications ANSI C63. These antennas can be moved over the height range between 1.0 m and 4.0 m in order to search for maximum field strength emitted from EUT. The measurement distances between EUT and receiving antennas are indicated in the test setups for the various frequency ranges. For each measurement, the EUT is rotated in all three axes until the maximum field strength is received. The wanted and unwanted emissions are received by spectrum analyzers where the detector modes and resolution bandwidths over various frequency ranges are set according to requirement ANSI C63.

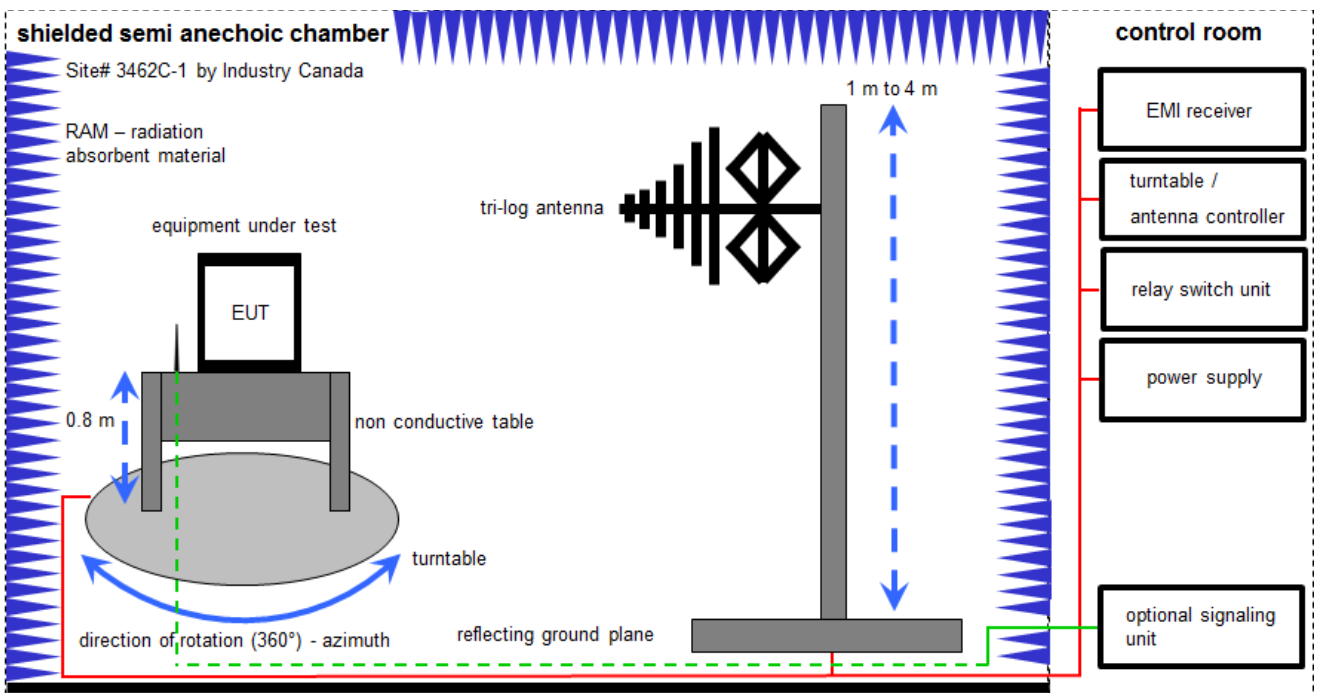

Measurement distance: tri-log antenna 10 meter

$$FS = UR + CL + AF$$

(FS-field strength; UR-voltage at the receiver; CL-loss of the cable; AF-antenna factor)

Example calculation:

$$FS [dB\mu V/m] = 12.35 [dB\mu V/m] + 1.90 [dB] + 16.80 [dB/m] = 31.05 [dB\mu V/m] (35.69 \mu V/m)$$

Equipment table:

No.	Lab / Item	Equipment	Type	Manufacturer	Serial No.	INV. No.	Kind of Calibration	Last Calibration	Next Calibration
1	A	Switch-Unit	3488A	HP	2719A14505	300000368	ev	-/-	-/-
2	A	EMI Test Receiver	ESCI 3	R&S	100083	300003312	k	08.03.2016	08.03.2017
3	A	Antenna Tower	Model 2175	ETS-Lindgren	64762	300003745	izw	-/-	-/-
4	A	Positioning Controller	Model 2090	ETS-Lindgren	64672	300003746	izw	-/-	-/-
5	A	Turntable Interface-Box	Model 105637	ETS-Lindgren	44583	300003747	izw	-/-	-/-
6	A	TRILOG Broadband Test-Antenna 30 MHz - 3 GHz	VULB9163	Schwarzbeck	295	300003787	k	25.04.2016	25.04.2018

6.2 Shielded fully anechoic chamber

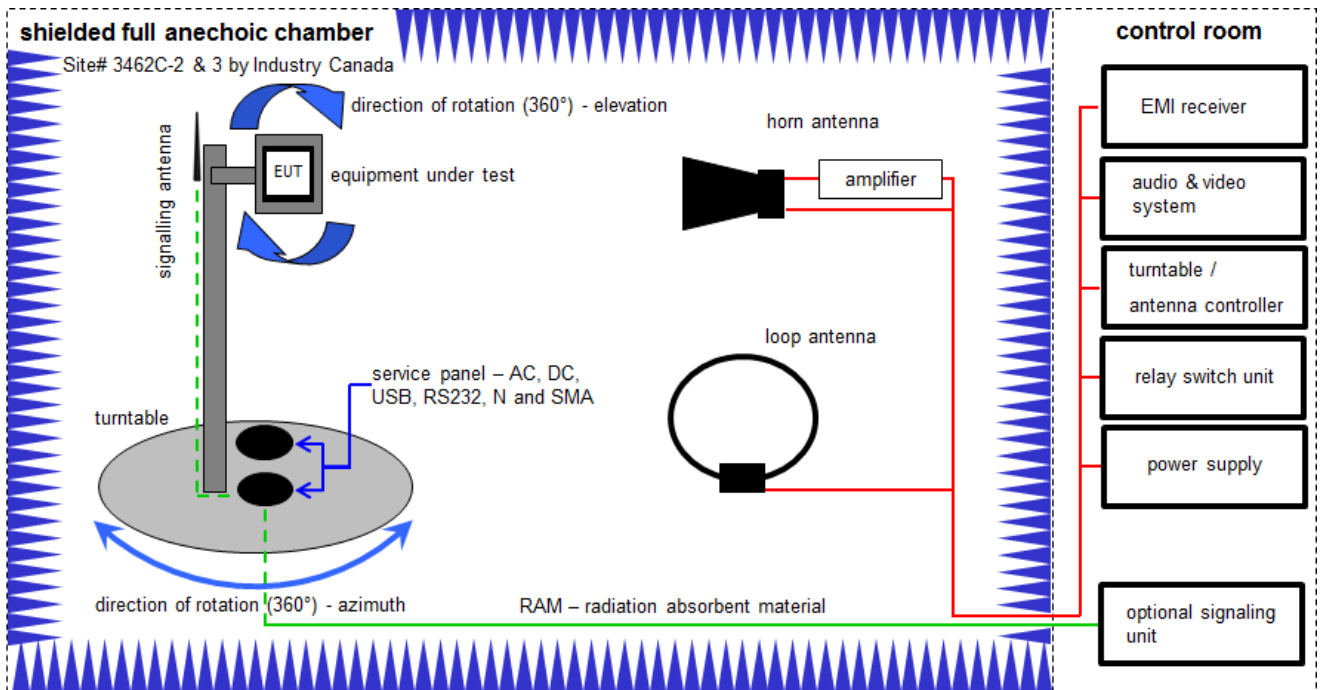

Measurement distance: horn antenna 3 meter; loop antenna 3 meter / 1 meter

$$FS = UR + CA + AF$$

(FS-field strength; UR-voltage at the receiver; CA-loss of the signal path; AF-antenna factor)

Example calculation:

$$FS [dB\mu V/m] = 40.0 [dB\mu V/m] + (-35.8) [dB] + 32.9 [dB/m] = 37.1 [dB\mu V/m] (71.61 \mu V/m)$$

Equipment table:

No.	Lab / Item	Equipment	Type	Manufacturer	Serial No.	INV. No.	Kind of Calibration	Last Calibration	Next Calibration
1	A	Active Loop Antenna 10 kHz to 30 MHz	6502	EMCO	2210	300001015	k	20.05.2015	20.05.2017
2	B	Double-Ridged Waveguide Horn Antenna 1-18.0GHz	3115	EMCO	9709-5290	300000212	k	13.08.2015	13.08.2017
3	A, B	EMI Test Receiver 20Hz- 26,5GHz	ESU26	R&S	100037	300003555	k	02.02.2016	02.02.2017
4	B	Highpass Filter	WHK1.1/15G-10SS	Wainwright	37	400000148	ne	-/-	-/-
5	B	Band Reject Filter	WRCG2400/2483- 2375/2505-50/10SS	Wainwright	26	300003792	ne	-/-	-/-
6	B	Broadband Amplifier 0.5-18 GHz	CBLU5184540	CERNEX	22050	300004482	ev	-/-	-/-
7	B	Broadband Amplifier 5-13 GHz	CBLU5135235	CERNEX	22011	300004492	ev	-/-	-/-
8	A, B	4U RF Switch Platform	L4491A	Agilent Technologies	MY50000032	300004510	ne	-/-	-/-
9	A, B	Messrechner und Monitor	Intel Core i3 3220/3,3 GHz, Prozessor	Agilent Technologies	2V2403033A54 21	300004591	ne	-/-	-/-
10	A, B	NEXIO EMV- Software	BAT EMC	EMCO	2V2403033A54 21	300004682	ne	-/-	-/-
11	A, B	Vollabsorberkammer	BAT EMC	TDK	2V2403033A54 21	300003726	ne	-/-	-/-

6.3 Radiated measurements > 18 GHz

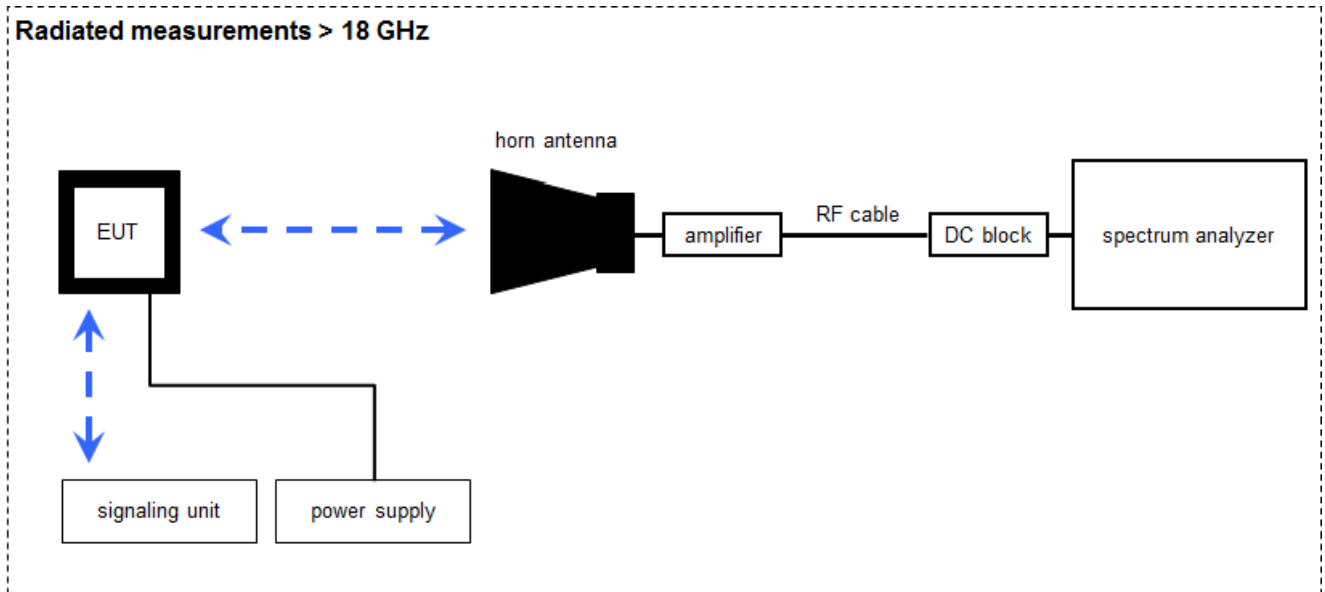

Measurement distance: horn antenna 50 cm

$$FS = U_R + CA + AF$$

(FS-field strength; U_R -voltage at the receiver; CA-loss signal path & distance correction; AF-antenna factor)

Example calculation:

$$FS [dB\mu V/m] = 40.0 [dB\mu V/m] + (-60.1) [dB] + 36.74 [dB/m] = 16.64 [dB\mu V/m] (6.79 \mu V/m)$$

Equipment table:

No.	Lab / Item	Equipment	Type	Manufacturer	Serial No.	INV. No.	Kind of Calibration	Last Calibration	Next Calibration
1	A	RF-Cable	ST18/SMAm/SMAm/48	Huber & Suhner	Batch no. 600918	400001182	ev	-/-	-/-
2	A	RF-Cable	ST18/SMAm/SMm/48	Huber & Suhner	Batch no. 127377	400001183	ev	-/-	-/-
3	A	Amplifier 2-40 GHz	JS32-02004000-57-5P	MITEQ	1777200	300004541	ev	-/-	-/-
4	A	DC-Blocker 0.1-40 GHz	8141A	Inmet	Batch no. 127377	400001185	ev	-/-	-/-
5	A	Std. Gain Horn Antenna 18.0 to 26.5 GHz	638	Narda	8402	300000486	k	10.09.2015	10.09.2017
6	A	Std. Gain Horn Antenna 26.5 to 40.0 GHz	V637	Narda	82-16	300000510	k	14.08.2015	14.08.2017
7	A	Signal Analyzer 40 GHz	FSV40	R&S	101353	300004819	k	19.09.2016	19.09.2017

6.4 AC conducted

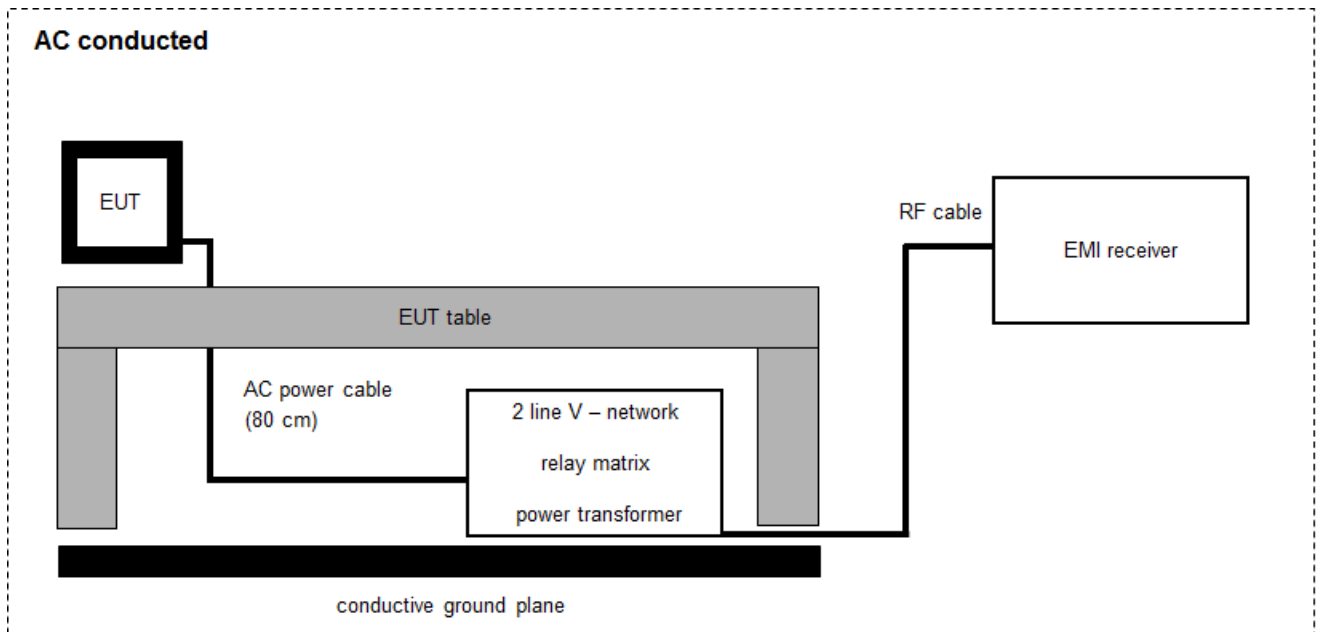

$$FS = UR + CF + VC$$

(FS-field strength; UR-voltage at the receiver; CR-loss of the cable and filter; VC-correction factor of the ISN)

Example calculation:

$$FS [dB\mu V/m] = 37.62 [dB\mu V/m] + 9.90 [dB] + 0.23 [dB] = 47.75 [dB\mu V/m] (244.06 \mu V/m)$$

Equipment table:

No.	Lab / Item	Equipment	Type	Manufacturer	Serial No.	INV. No.	Kind of Calibration	Last Calibration	Next Calibration
1	A	Two-line V-Network (LISN) 9 kHz to 30 MHz	ESH3-Z5	R&S	893045/004	300000584	k	02.02.2016	02.02.2017
2	A	RF-Filter-section	85420E	HP	3427A00162	300002214	k	27.11.2006	-/-
3	A	AC-Spannungsquelle variabel	MV2616-V	EM-Test	0397-12	300003259	k	11.12.2015	11.12.2017
4	A	Analyzer-Reference-System (Harmonics and Flicker)	ARS 16/1	SPS	A3509 07/0 0205	300003314	Ve	02.02.2016	02.02.2018
5	A	Hochpass 150 kHz	EZ-25	R&S	100010	300003798	ev	08.04.2008	-/-
6	A	Power Supply	NGSM 32/10	R&S	3939	400000192	vIK!	22.01.2015	22.01.2017
7	A	MXE EMI Receiver 20 Hz to 26,5 GHz	N9038A	Agilent Technologies	MY51210197	300004405	k	16.08.2016	16.08.2017

6.5 Conducted measurements

Conducted measurements normal conditions

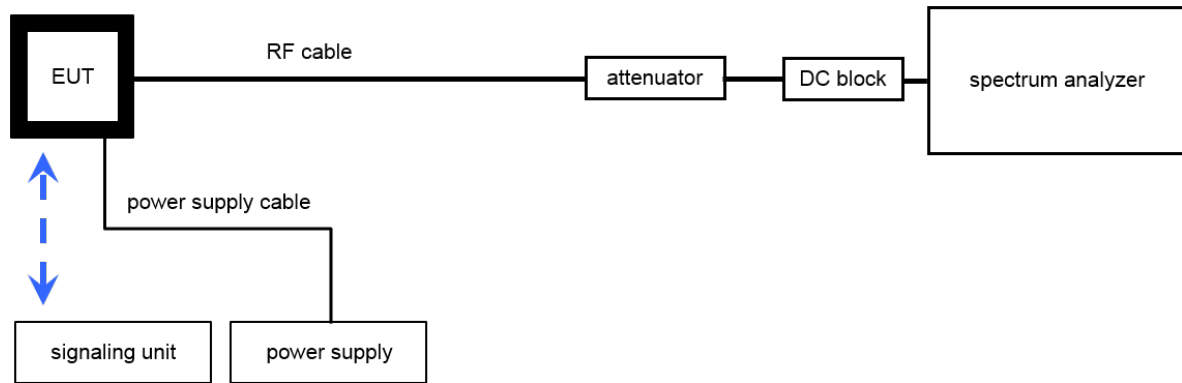

OP = AV + CA
 (OP-output power; AV-analyzer value; CA-loss signal path)

Example calculation:

OP [dBm] = 6.0 [dBm] + 11.7 [dB] = 17.7 [dBm] (58.88 mW)

Equipment table:

No.	Lab / Item	Equipment	Type	Manufacturer	Serial No.	INV. No.	Kind of Calibration	Last Calibration	Next Calibration
1	A	Teststand	Teststand Custom Sequence Editor	National Instruments GmbH	2V2403033A4523	300004590	ne	-/-	-/-
2	A	PowerSplitter/Combiner 150-6000MHz N-Type	ZB3PD-63-N+	Mini-Circuits	100010	400000451	ev	-/-	-/-
3	A	RF-Cable	ST18/SMAm/SMAm/60	Huber & Suhner	Batch no. 606844	400001181	ev	-/-	-/-
4	A	DC-Blocker 0.1-40 GHz	8141A	Inmet	Batch no. 127377	400001185	ev	-/-	-/-
5	A	Coax Attenuator 10 dB 2W 0-40 GHz	MCL BW-K10-2W44+	Mini Circuits	Batch no. 127377	400001186	ev	-/-	-/-
6	A	Switch / Control Unit	3488A	HP	2719A15013	300000151	ne	-/-	-/-
7	A	Hygro-Thermometer	-/-, 5-45C, 20-100rF	HP	-/-	400000108	ev	07.09.2015	07.09.2017
8	A	Signal Analyzer 40 GHz	FSV40	R&S	101353	300004819	k	19.09.2016	19.09.2017

7 Sequence of testing

7.1 Sequence of testing radiated spurious 9 kHz to 30 MHz

Setup

- The equipment is set up to simulate normal operation mode as described in the user manual or defined by the manufacturer.
- If the EUT is a tabletop system, a 2-axis positioner with 1.5 m height is used.
- If the EUT is a floor standing device, it is placed directly on the turn table.
- Auxiliary equipment and cables are positioned to simulate normal operation conditions as described in ANSI C 63.4.
- The AC power port of the EUT (if available) is connected to a power outlet below the turntable.
- Measurement distance is 3 m (see ANSI C 63.4) – see test details.
- EUT is set into operation.

Premeasurement

- The turntable rotates from 0° to 315° using 45° steps.
- The antenna height is 1.5 m.
- At each turntable position the analyzer sweeps with positive-peak detector to find the maximum of all emissions.

Final measurement

- Identified emissions during the premeasurement are maximized by the software by rotating the turntable from 0° to 360°. In case of the 2-axis positioner is used the elevation axis is also rotated from 0° to 360°.
- The final measurement is done in the position (turntable and elevation) causing the highest emissions with quasi-peak (as described in ANSI C 63.4).
- Final levels, frequency, measuring time, bandwidth, turntable position, correction factor, margin to the limit and limit will be recorded. A plot with the graph of the premeasurement and the limit is stored.

7.2 Sequence of testing radiated spurious 30 MHz to 1 GHz

Setup

- The equipment is set up to simulate normal operation mode as described in the user manual or defined by the manufacturer.
- If the EUT is a tabletop system, a table with 0.8 m height is used, which is placed on the ground plane.
- If the EUT is a floor standing device, it is placed on the ground plane with insulation between both.
- Auxiliary equipment and cables are positioned to simulate normal operation conditions as described in ANSI C 63.4.
- The AC power port of the EUT (if available) is connected to a power outlet below the turntable.
- Measurement distance is 10 m or 3 m (see ANSI C 63.4) – see test details.
- EUT is set into operation.

Premeasurement

- The turntable rotates from 0° to 315° using 45° steps.
- The antenna is polarized vertical and horizontal.
- The antenna height changes from 1 m to 3 m.
- At each turntable position, antenna polarization and height the analyzer sweeps three times in peak to find the maximum of all emissions.

Final measurement

- The final measurement is performed for at least six highest peaks according to the requirements of the ANSI C63.4.
- Based on antenna and turntable positions at which the peak values are measured the software maximize the peaks by changing turntable position $\pm 45^\circ$ and antenna height between 1 and 4 m.
- The final measurement is done with quasi-peak detector (as described in ANSI C 63.4).
- Final levels, frequency, measuring time, bandwidth, antenna height, antenna polarization, turntable angle, correction factor, margin to the limit and limit are recorded. A plot with the graph of the premeasurement with marked maximum final results and the limit is stored.

7.3 Sequence of testing radiated spurious 1 GHz to 18 GHz

Setup

- The equipment is set up to simulate normal operation mode as described in the user manual or defined by the manufacturer.
- If the EUT is a tabletop system, a 2-axis positioner with 1.5 m height is used.
- If the EUT is a floor standing device, it is placed directly on the turn table.
- Auxiliary equipment and cables are positioned to simulate normal operation conditions as described in ANSI C 63.4.
- The AC power port of the EUT (if available) is connected to a power outlet below the turntable.
- Measurement distance is 3 m (see ANSI C 63.4) – see test details.
- EUT is set into operation.

Premeasurement

- The turntable rotates from 0° to 315° using 45° steps.
- The antenna is polarized vertical and horizontal.
- The antenna height is 1.5 m.
- At each turntable position and antenna polarization the analyzer sweeps with positive peak detector to find the maximum of all emissions.

Final measurement

- The final measurement is performed for at least six highest peaks according to the requirements of the ANSI C63.4.
- Based on antenna and turntable positions at which the peak values are measured the software maximizes the peaks by rotating the turntable from 0° to 360°. This measurement is repeated for different EUT-table positions (0° to 150° in 30°-steps) and for both antenna polarizations.
- The final measurement is done in the position (turntable, EUT-table and antenna polarization) causing the highest emissions with Peak and RMS detector (as described in ANSI C 63.4).
- Final levels, frequency, measuring time, bandwidth, turntable position, EUT-table position, antenna polarization, correction factor, margin to the limit and limit are recorded. A plot with the graph of the premeasurement with marked maximum final results and the limit is stored.

7.4 Sequence of testing radiated spurious above 18 GHz

Setup

- The equipment is set up to simulate normal operation mode as described in the user manual or defined by the manufacturer.
- Auxiliary equipment and cables are positioned to simulate normal operation conditions as described in ANSI C 63.4.
- The AC power port of the EUT (if available) is connected to a power outlet.
- The measurement distance is as appropriate (e.g. 0.5 m).
- The EUT is set into operation.

Premeasurement

- The test antenna is handheld and moved carefully over the EUT to cover the EUT's whole sphere and different polarizations of the antenna.

Final measurement

- The final measurement is performed at the position and antenna orientation causing the highest emissions with Peak and RMS detector (as described in ANSI C 63.4).
- Final levels, frequency, measuring time, bandwidth, correction factor, margin to the limit and limit are recorded. A plot with the graph of the premeasurement and the limit is stored.

8 Measurement uncertainty

Measurement uncertainty	
Test case	Uncertainty
Antenna gain	± 3 dB
Power spectral density	± 1.5 dB
Spectrum bandwidth	± 100 kHz (depends on the used RBW)
Occupied bandwidth	± 100 kHz (depends on the used RBW)
Maximum output power	± 1.5 dB
Minimum emissions bandwidth	± 100 kHz (depends on the used RBW)
Spurious emissions conducted	± 3 dB
Spurious emissions radiated below 30 MHz	± 3 dB
Spurious emissions radiated 30 MHz to 1 GHz	± 3 dB
Spurious emissions radiated 1 GHz to 12.75 GHz	± 3.7 dB
Spurious emissions radiated above 12.75 GHz	± 4.5 dB
Spurious emissions conducted below 30 MHz (AC conducted)	± 2.6 dB

9 Summary of measurement results

<input checked="" type="checkbox"/>	No deviations from the technical specifications were ascertained
<input type="checkbox"/>	There were deviations from the technical specifications ascertained
<input type="checkbox"/>	This test report is only a partial test report. The content and verdict of the performed test cases are listed below.

TC Identifier	Description	Verdict	Date	Remark
RF-Testing	CFR Part 15 RSS 247, Issue 1	see table	2017-02-09	-/-

Test specification clause	Test case	Temperature conditions	Power source voltages	C	NC	NA	NP	Remark
-/-	Output power verification (conducted)	Nominal	Nominal	-/-				-/-
-/-	Antenna gain	Nominal	Nominal	-/-				-/-
U-NII Part 15	Duty cycle	Nominal	Nominal	-/-				-/-
§15.407(a) RSS - 247 (6.2.1) (1) RSS - 247 (6.2.2) (1) RSS - 247 (6.2.3) (1) RSS - 247 (6.2.4) (1)	Maximum output power (conducted & radiated)	Nominal	Nominal	<input checked="" type="checkbox"/>	<input type="checkbox"/>	<input type="checkbox"/>	<input type="checkbox"/>	-/-
§15.407(a) RSS - 247 (6.2.1) (1) RSS - 247 (6.2.2) (1) RSS - 247 (6.2.3) (1) RSS - 247 (6.2.4) (1)	Power spectral density	Nominal	Nominal	<input checked="" type="checkbox"/>	<input type="checkbox"/>	<input type="checkbox"/>	<input type="checkbox"/>	-/-
RSS - 247 (6.2.4)	Spectrum bandwidth 6dB bandwidth	Nominal	Nominal	<input checked="" type="checkbox"/>	<input type="checkbox"/>	<input type="checkbox"/>	<input type="checkbox"/>	-/-
§15.407(a)	Spectrum bandwidth 26dB bandwidth	Nominal	Nominal	<input checked="" type="checkbox"/>	<input type="checkbox"/>	<input type="checkbox"/>	<input type="checkbox"/>	-/-
RSS Gen clause 6.6	Spectrum bandwidth 99% bandwidth	Nominal	Nominal	-/-				-/-
§15.205 RSS - 247 (6.2.1) (2) RSS - 247 (6.2.2) (2) RSS - 247 (6.2.3) (2) RSS - 247 (6.2.4) (2)	Band edge compliance radiated	Nominal	Nominal	<input checked="" type="checkbox"/>	<input type="checkbox"/>	<input type="checkbox"/>	<input type="checkbox"/>	-/-
§15.407(b) RSS - 247 (6.2.1) (2) RSS - 247 (6.2.2) (2) RSS - 247 (6.2.3) (2) RSS - 247 (6.2.4) (2)	TX spurious emissions radiated	Nominal	Nominal	<input checked="" type="checkbox"/>	<input type="checkbox"/>	<input type="checkbox"/>	<input type="checkbox"/>	-/-
§15.109 RSS-Gen	RX spurious emissions radiated	Nominal	Nominal	<input checked="" type="checkbox"/>	<input type="checkbox"/>	<input type="checkbox"/>	<input type="checkbox"/>	-/-
§15.209(a) RSS-Gen	Spurious emissions radiated < 30 MHz	Nominal	Nominal	<input checked="" type="checkbox"/>	<input type="checkbox"/>	<input type="checkbox"/>	<input type="checkbox"/>	-/-
§15.107(a) §15.207	Spurious emissions conducted emissions < 30 MHz	Nominal	Nominal	<input checked="" type="checkbox"/>	<input type="checkbox"/>	<input type="checkbox"/>	<input type="checkbox"/>	-/-
§15.407 RSS - 247 (6.3)	DFS	Nominal	Nominal	<input type="checkbox"/>	<input type="checkbox"/>	<input checked="" type="checkbox"/>	<input type="checkbox"/>	-/-

Note: C = Compliant; NC = Not compliant; NA = Not applicable; NP = Not performed

10 Additional comments

- Reference documents: 3-3-TECH-587 930-02 Flir Astra antenna characterization A
 Customer Questionnaire FLIR E8
 CONN-GUIDE-LRU (RF test mode commands)
- Special test descriptions: None
- Configuration descriptions: None
- Test mode: No test mode available.
 Iperf was used to ping another device with the largest support packet size
- Special software is used.
 EUT is transmitting pseudo random data by itself
- Antennas and transmit operating modes: Operating mode 1 (single antenna)
- *Equipment with 1 antenna,*
 - *Equipment with 2 diversity antennas operating in switched diversity mode by which at any moment in time only 1 antenna is used,*
 - *Smart antenna system with 2 or more transmit/receive chains, but operating in a mode where only 1 transmit/receive chain is used)*
- Operating mode 2 (multiple antennas, no beamforming)
- *Equipment operating in this mode contains a smart antenna system using two or more transmit/receive chains simultaneously but without beamforming.*
- Operating mode 3 (multiple antennas, with beamforming)
- *Equipment operating in this mode contains a smart antenna system using two or more transmit/receive chains simultaneously with beamforming.
 In addition to the antenna assembly gain (G), the beamforming gain (Y) may have to be taken into account when performing the measurements.*

11 Measurement results

11.1 Identify worst case data rate

Measurement:

All modes of the module will be measured with an average power meter or spectrum analyzer to identify the maximum transmission power.

In further tests only the identified worst case modulation scheme or bandwidth will be measured and this mode is used as representative mode for all other modulation schemes.

Additional the band edge compliance test will be performed in the lowest and highest modulation scheme.

Measurement parameters:

Measurement parameter	
Detector:	Peak
Sweep time:	Auto
Resolution bandwidth:	3 MHz
Video bandwidth:	3 MHz
Trace mode:	Max hold
Used test setup:	See chapter 6.5 A
Measurement uncertainty:	See chapter 8

Results:

Modulation Frequency	Modulation scheme / bandwidth					
	5180 MHz	5320 MHz	5500 MHz	5700 MHz	5745 MHz	5825 MHz
OFDM / a – mode	6 Mbit/s	-/-	-/-	-/-	-/-	-/-
OFDM / n HT20 – mode	MCS0	-/-	-/-	-/-	-/-	-/-

11.2 Gain

Limits:

Antenna Gain
6 dBi / > 6 dBi output power and power density reduction required

Results:

OFDM Band 5150 MHz to 5250 MHz Channel	Antenna gain UNII band 5150 MHz to 5250 MHz
Gain Declared by the customer!*	1.1

*see reference document: 3-3-TECH-587 930-02 Flir Astra antenna characterization A

3 Summary

The WiFi antenna within the *Flir ASTRA* thermal camera has been characterized.
 The maximum antenna gain has been measured to be -2,0 dBi for the 2.5GHz band
 and 1,1 dBi for the 5GHz band.

Plots:

Plot 1:

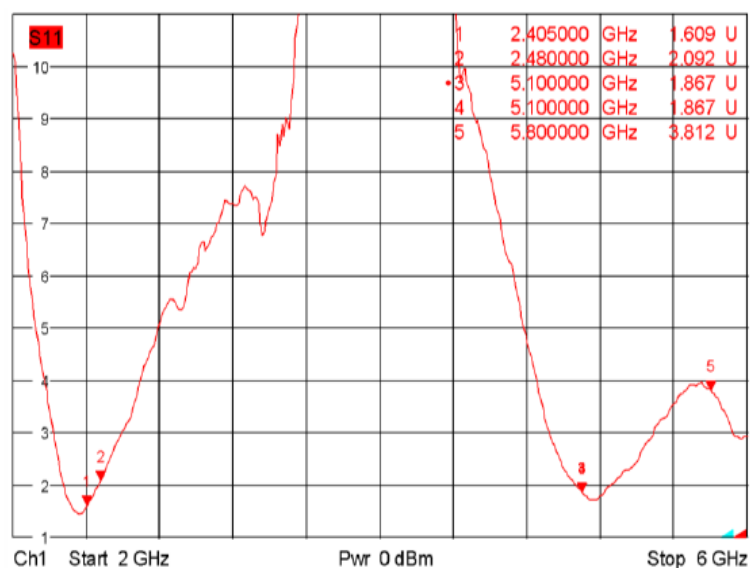

Figure 2 VSWR Flir ASTRA

Plot 2:

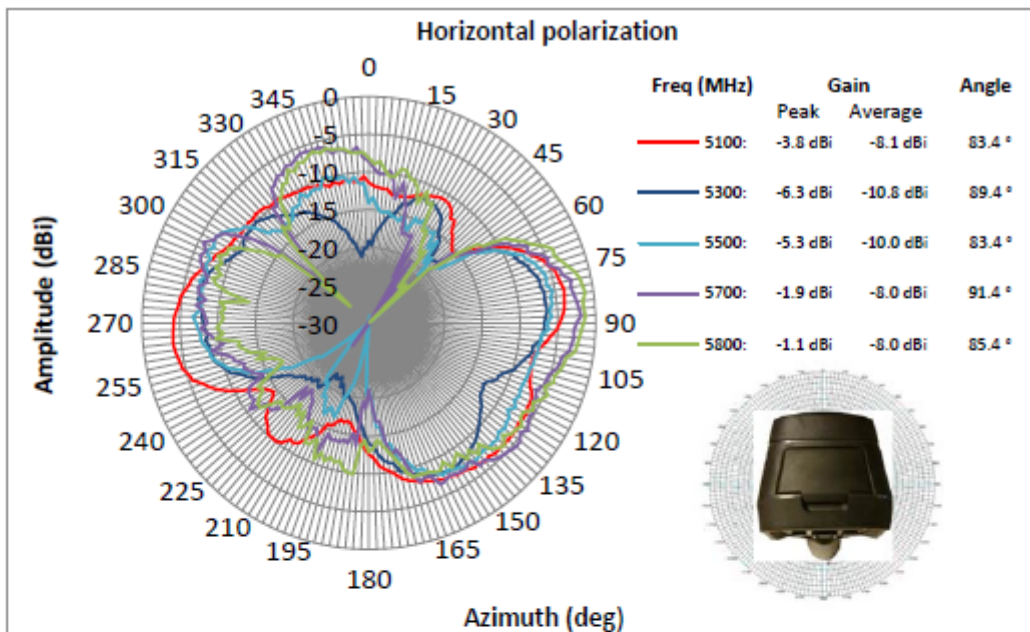

Figure 10 5GHz XY-plane, horizontal polarization

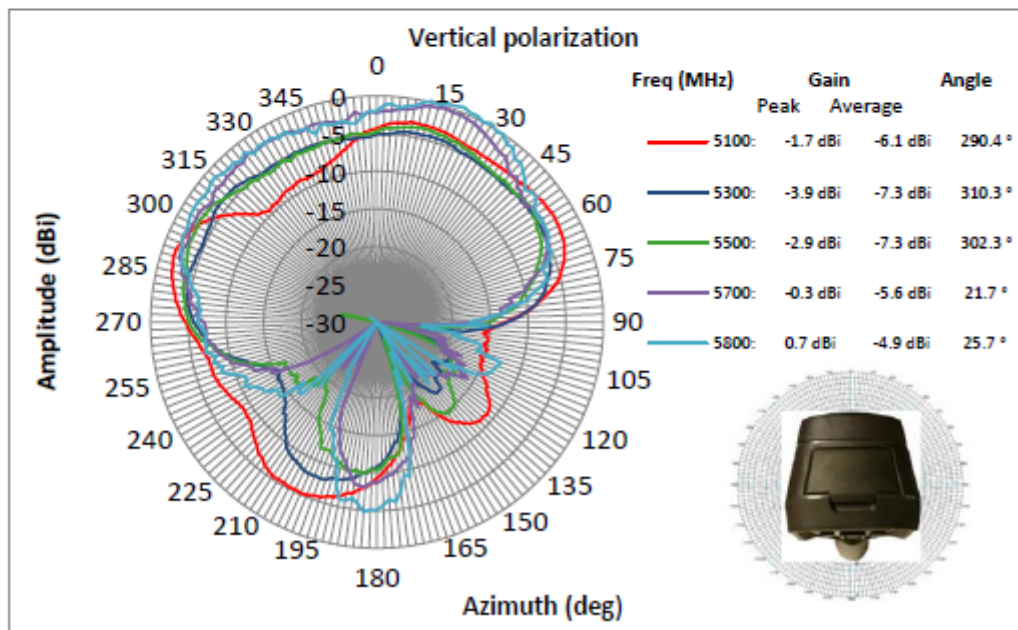

Figure 11 5GHz XY-plane, vertical polarization

Plot 3:

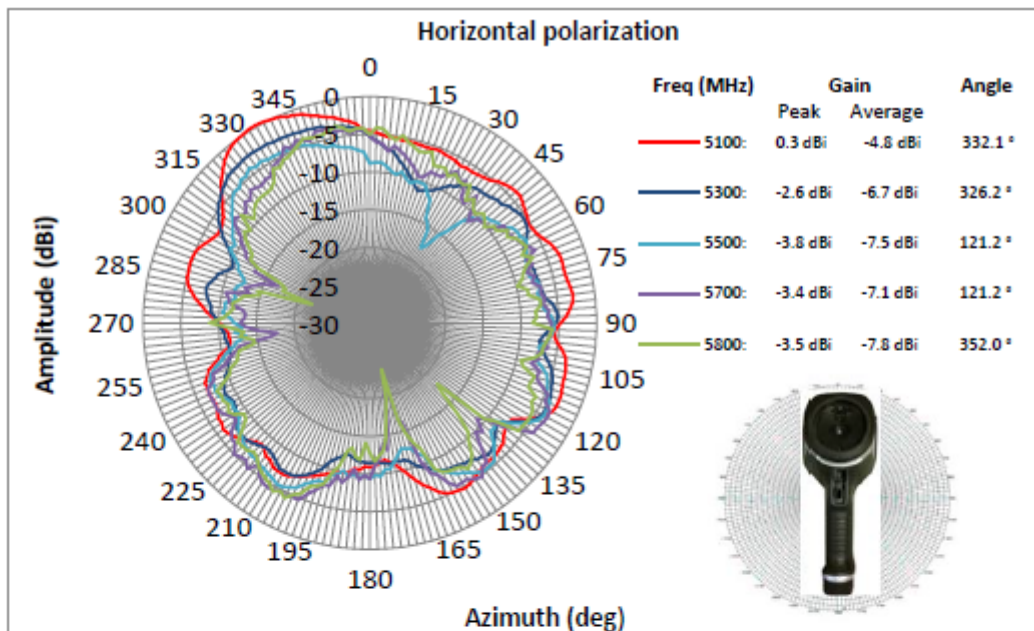

Figure 14 5GHz XZ-plane, horizontal polarization

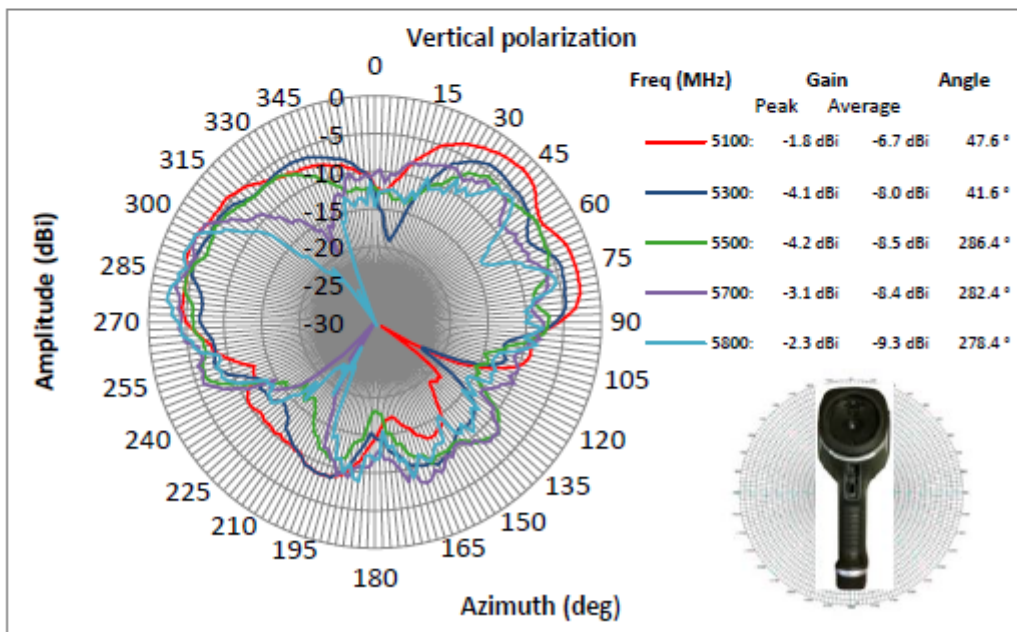

Figure 15 5GHz XZ-plane, vertical polarization

Plot 4:

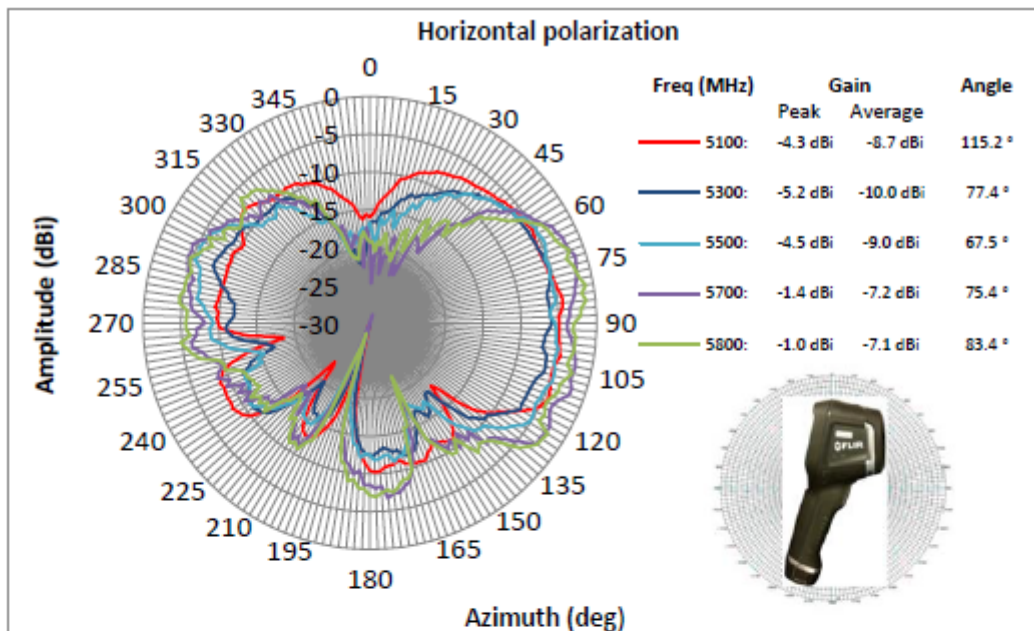

Figure 18 5GHz YZ-plane, horizontal polarization

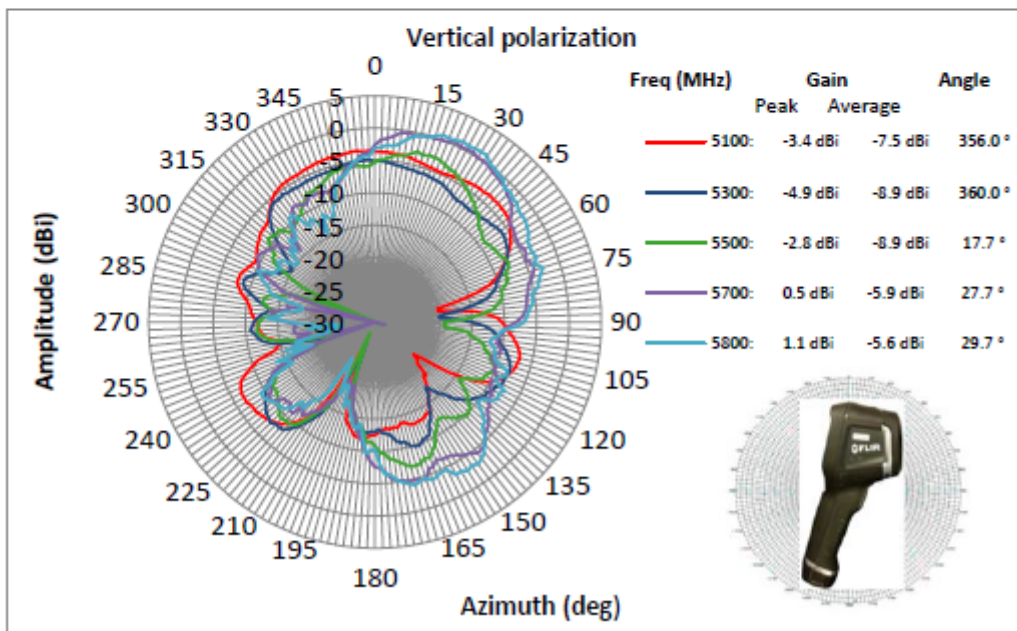

Figure 19 5GHz YZ-plane, vertical polarization

11.3 Duty cycle

Description:

The duty cycle is necessary to compute the maximum power during an actual transmission. The shown plots and values are to show an example of the measurement procedure. The real value is measured direct during the power measurement or power density measurement. The correction value is shown in each plot of these measurements.

Measurement:

Measurement parameter	
According to: KDB789033 D02, B.	
Detector:	Peak
Sweep time:	Auto
Resolution bandwidth:	10 MHz
Video bandwidth:	10 MHz
Span:	Zero
Trace mode:	Video trigger / view / single sweep
Used test setup:	See chapter 6.5 A
Measurement uncertainty:	See chapter 8

Results:

Duty cycle and correction factor:

OFDM / a – mode: 98.80 % duty cycle => 0.05 dB
 OFDM / n HT20 – mode: 98.50 % duty cycle => 0.07 dB

Plots:

Duty cycle and correction factor:

Plot 1: duty cycle of the transmitter – OFDM / a – mode

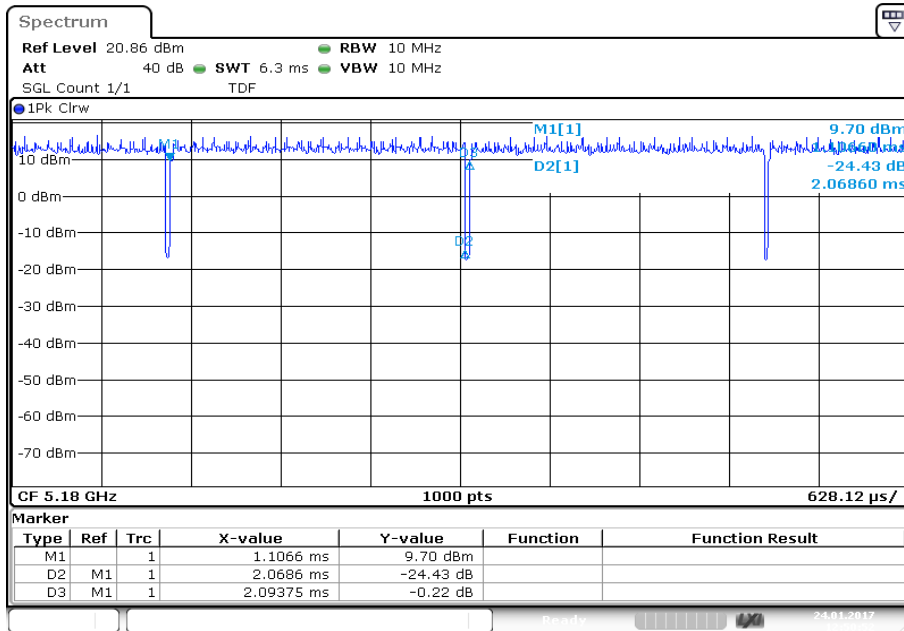

Date: 24.JAN.2017 12:50:53

Plot 2: duty cycle of the transmitter – OFDM / n HT20 – mode

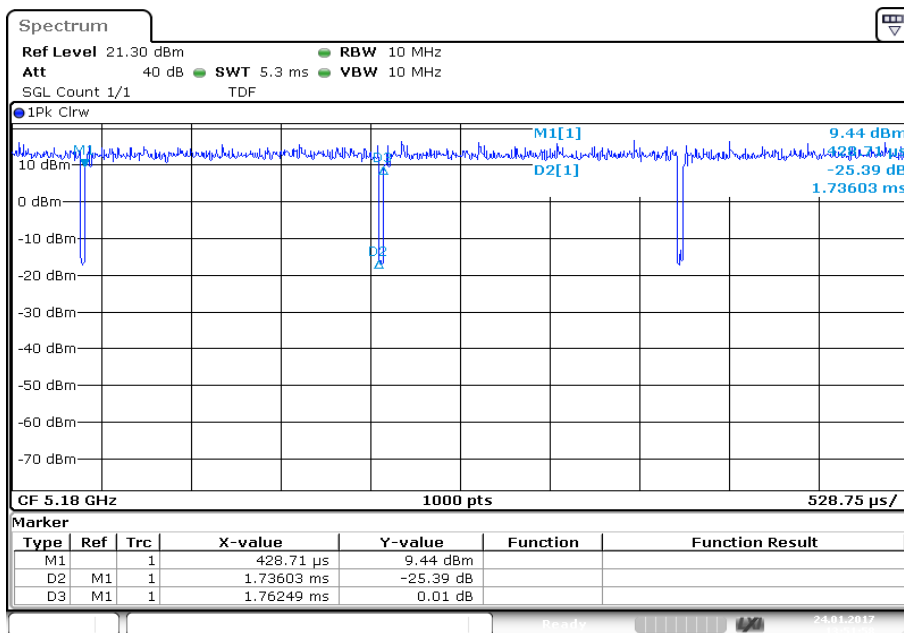

Date: 24.JAN.2017 13:51:59

11.4 Maximum output power

11.4.1 Maximum output power conducted – for FCC requirements

Description:

Measurement of the maximum output power conducted

Measurement:

Measurement parameter	
According to: KDB789033 D02, E.2.e.	
Detector:	RMS
Sweep time:	$\geq 10 * (\text{swp points}) * (\text{total on/off time})$
Resolution bandwidth:	1 MHz
Video bandwidth:	3 MHz
Span:	> EBW
Trace mode:	Max hold
Analyzer function	Band power / channel power Interval > 26 dB EBW
Used test setup:	See chapter 6.5 A
Measurement uncertainty:	See chapter 8

Limits:

Radiated output power	Conducted output power for mobile equipment
Conducted power + 6 dBi antenna gain	250mW 5.150-5.250 GHz

Result: OFDM / a – mode

OFDM / a – mode Channel	Maximum output power conducted [dBm]			
	5180 MHz	5200 MHz	5240 MHz	-/-
	9.07	8.99	9.22	-/-

Result: OFDM / n HT20 – mode

OFDM / n HT20 – mode Channel	Maximum output power conducted [dBm]			
	5180 MHz	5200 MHz	5240 MHz	-/-
	9.08	11.52	11.29	-/-

Plots: OFDM / a – mode

Plot 1: 5180 MHz

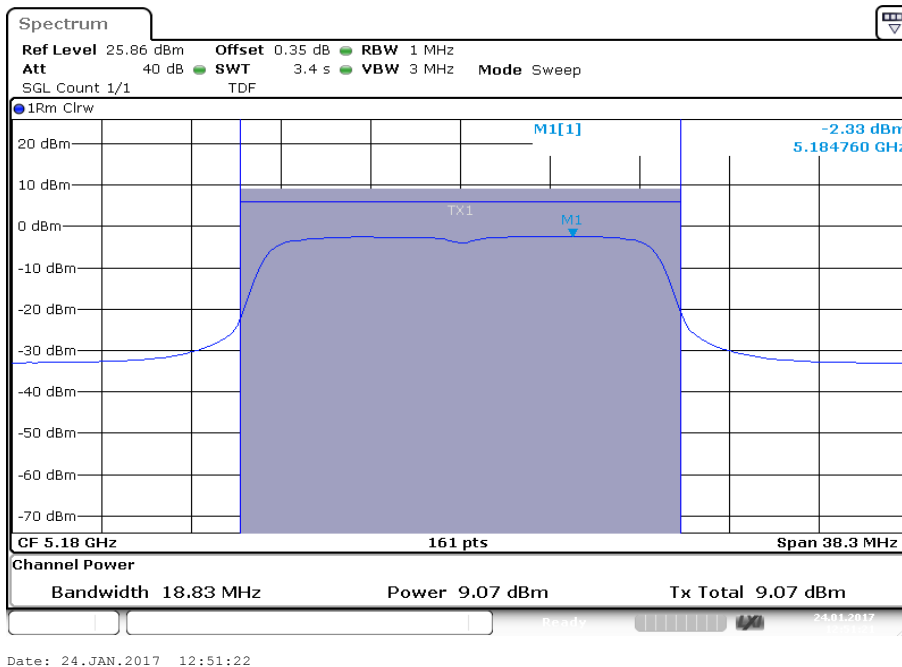

Plot 2: 5200 MHz

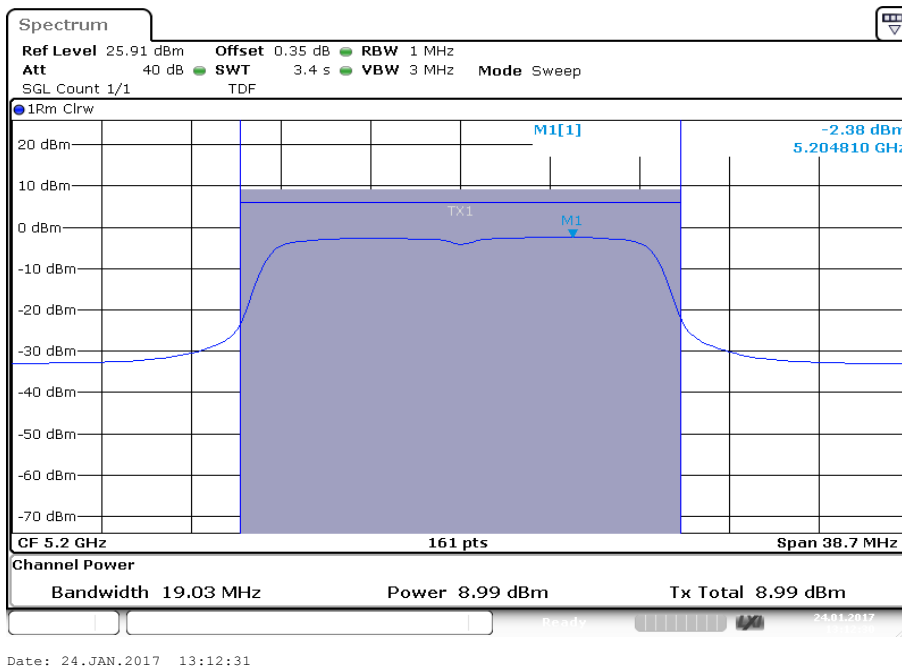

Plot 3: 5240 MHz

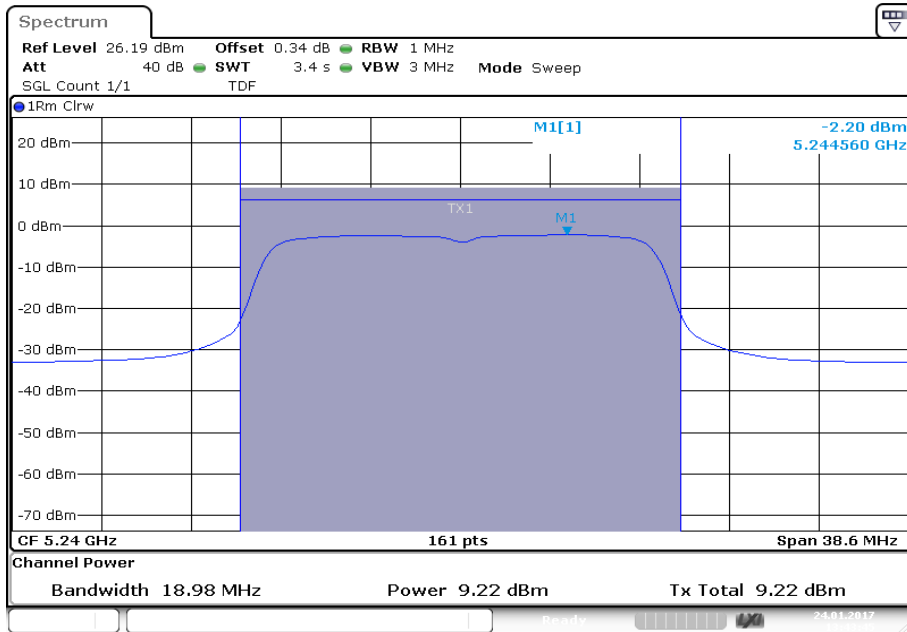

Date: 24.JAN.2017 13:43:45

Plots: OFDM / n HT20 – mode

Plot 1: 5180 MHz

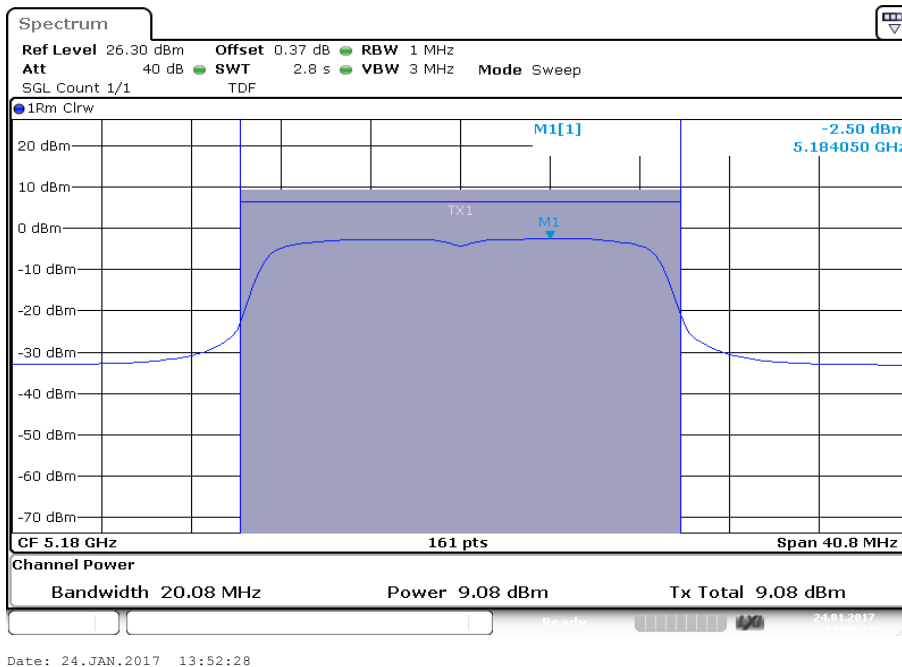

Plot 2: 5220 MHz

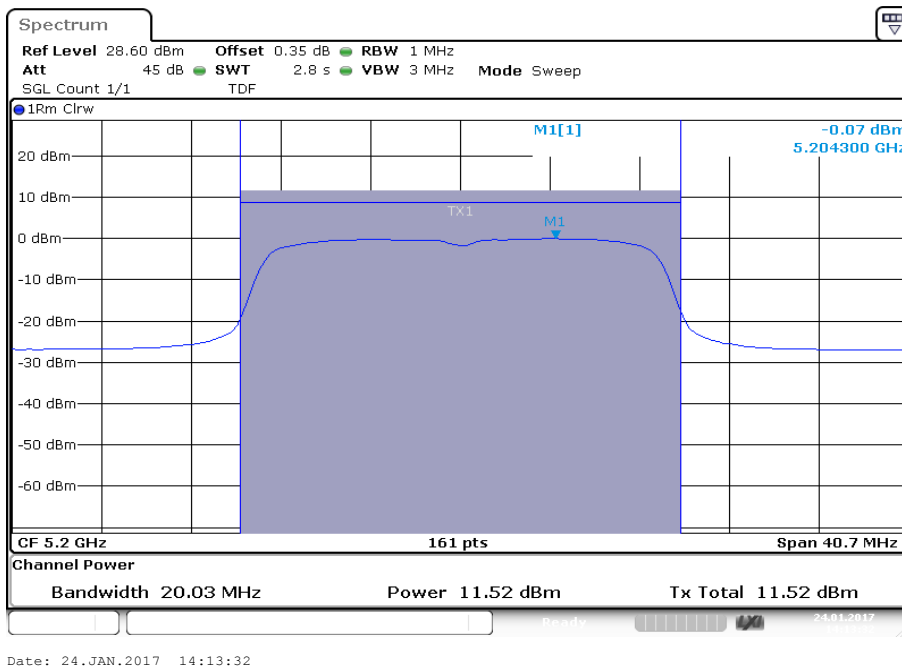

Plot 3: 5240 MHz

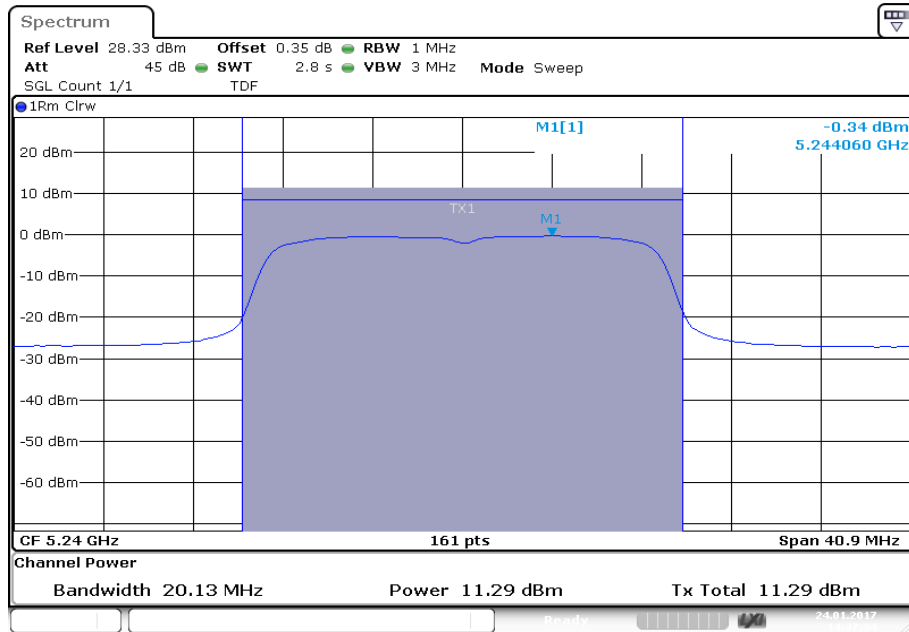

Date: 24.JAN.2017 14:37:34

11.4.2 Maximum output power – for IC requirements

Description:

Measurement of the maximum output power conducted + radiated

Measurement:

Measurement parameter	
Detector:	RMS
Sweep time:	$\geq 10 * (\text{swp points}) * (\text{total on/off time})$
Resolution bandwidth:	1 MHz
Video bandwidth:	≥ 3 MHz
Span:	> EBW
Trace mode:	Max hold
Analyzer function	Band power / channel power Interval > 99% OBW
Used test setup:	See chapter 6.5 A
Measurement uncertainty:	See chapter 8

Limits:

Radiated output power	Conducted output power for mobile equipment
The lesser one of 200 mW or 10 dBm + 10 log Bandwidth 5.150-5.250 GHz 1 W or 17 dBm + 10 log Bandwidth 5.250-5.350 GHz 1 W or 17 dBm + 10 log Bandwidth 5.470-5.725 GHz (where Bandwidth is the 99% Bandwidth [MHz]) Conducted power + 6dBi antenna gain 5.725-5.825 GHz	The lesser one of 250mW or 11 dBm + 10 log Bandwidth 5.250-5.350 GHz 250mW or 11 dBm + 10 log Bandwidth 5.470-5.725 GHz (where Bandwidth is the 99% Bandwidth [MHz]) 1W 5.725-5.825 GHz

Result: OFDM / a – mode

OFDM / a – mode Channel	Maximum output power [dBm]			
	5180 MHz	5200 MHz	5240 MHz	-/-
Including duty cycle correction factor	8.99	8.92	9.17	-/-

Result: OFDM / n HT20 – mode

OFDM / n HT20 – mode Channel	Maximum output power [dBm]			
	5180 MHz	5200 MHz	5240 MHz	-/-
Including duty cycle correction factor	9.02	11.44	11.23	-/-

Plots: OFDM / a – mode

Plot 1: 5180 MHz

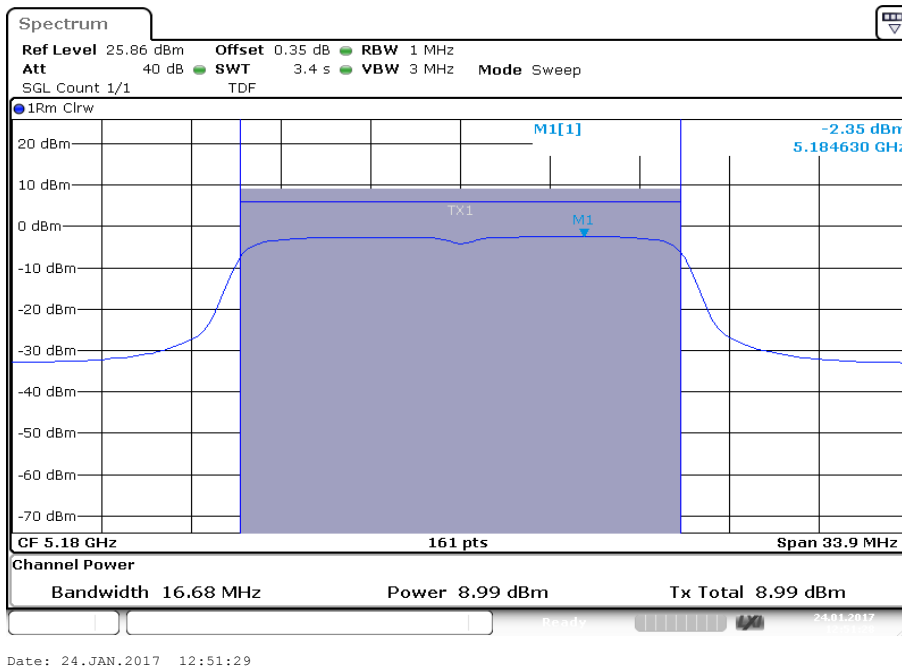

Plot 2: 5200 MHz

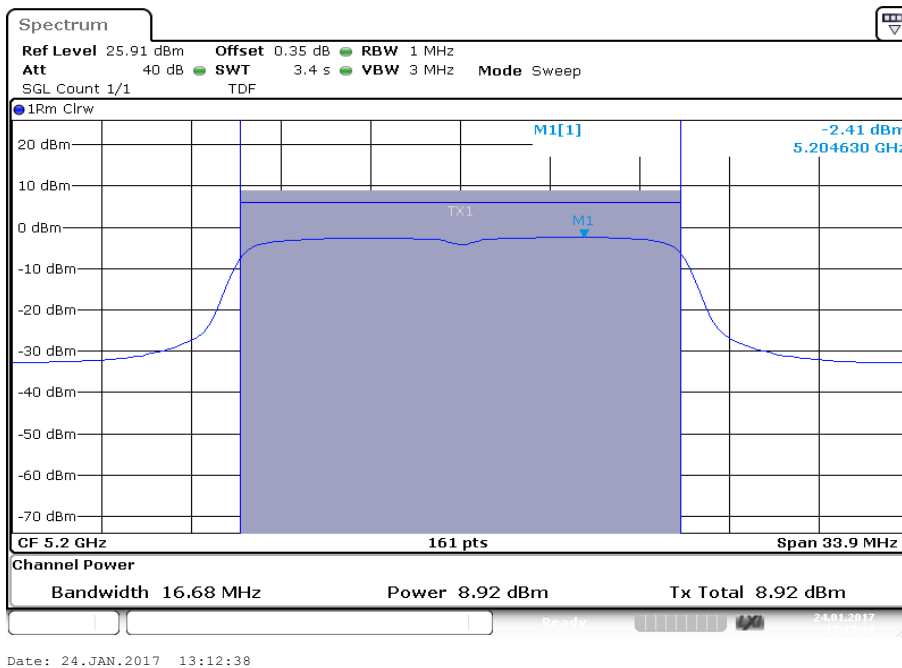

Plot 3: 5240 MHz

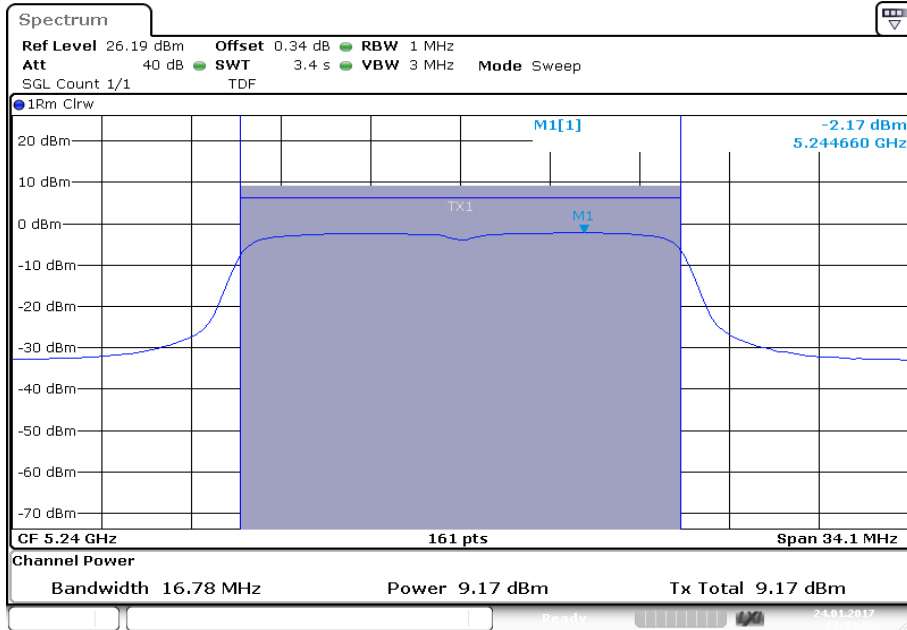

Date: 24.JAN.2017 13:43:52

Plots: OFDM / n HT20 – mode

Plot 1: 5180 MHz

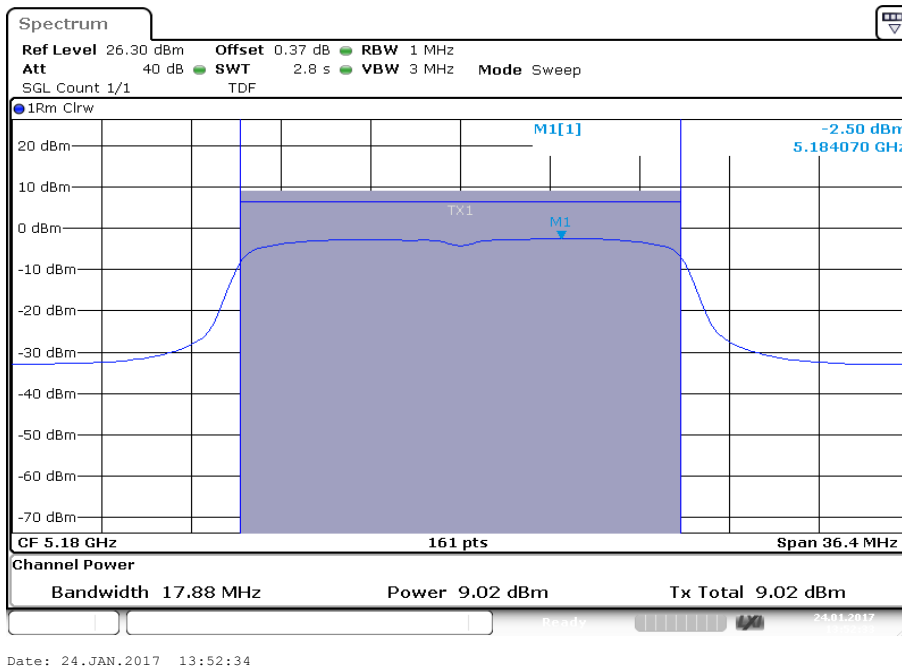

Plot 2: 5200 MHz

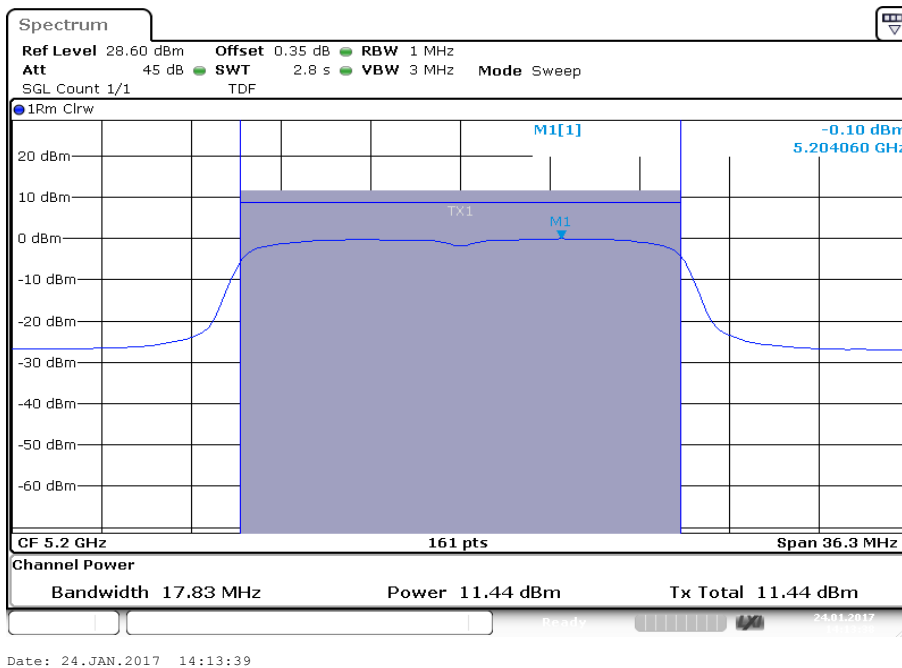

Plot 3: 5240 MHz

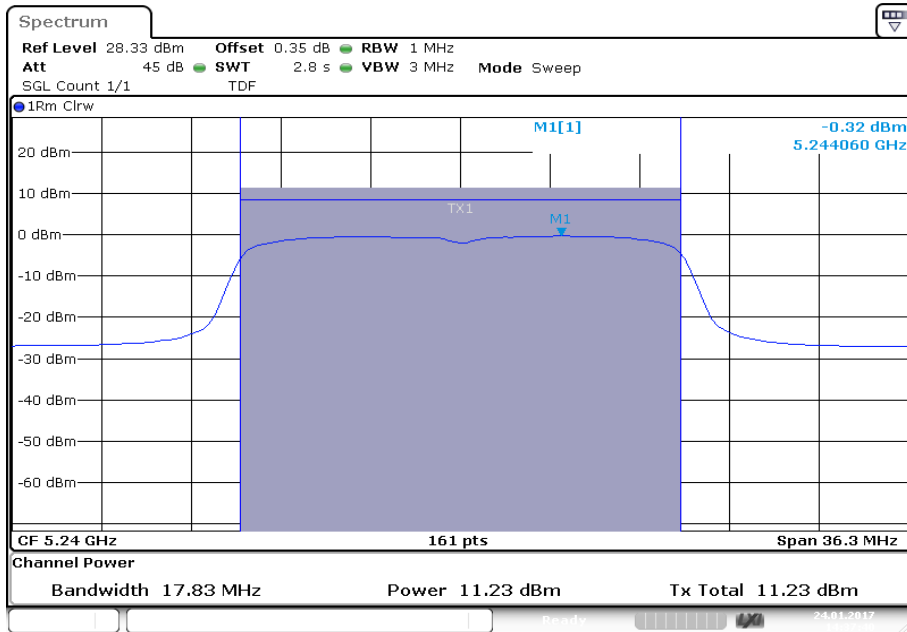

Date: 24.JAN.2017 14:37:41

11.5 Power spectral density

11.5.1 Power spectral density – for FCC requirements

Description:

Measurement of the power spectral density of a digital modulated system. The measurement is repeated at the lowest, middle and highest channel.

Measurement:

Measurement parameter	
According to: KDB789033 D02, F.	
Detector:	RMS
Sweep time:	$\geq 10 * (\text{swp points}) * (\text{total on/off time})$
Resolution bandwidth:	1 MHz (500 kHz for 5.8 GHz band)
Video bandwidth:	$\geq 3 * \text{RBW}$
Span:	> EBW
Trace mode:	Max hold
Used test setup:	See chapter 6.5 A
Measurement uncertainty:	See chapter 8

Limits:

Power Spectral Density
power spectral density conducted ≤ 11 dBm in any 1 MHz band (band 5150 – 5250 MHz)

Result: OFDM / a – mode

OFDM / a – mode Channel	Power spectral density [dBm/MHz]			
	5180 MHz	5200 MHz	5240 MHz	-/-
	-2.33	-2.38	-2.20	-/-

Result: OFDM / n HT20 – mode

OFDM / n HT20 – mode Channel	Power spectral density [dBm/MHz]			
	5180 MHz	5200 MHz	5240 MHz	-/-
	-2.50	-0.07	-0.34	-/-

11.5.2 Power spectral density – for IC requirements

Description:

Measurement of the power spectral density of a digital modulated system. The measurement is repeated at the lowest, middle and highest channel.

Measurement:

Measurement parameter	
Detector:	RMS
Sweep time:	$\geq 10 * (\text{swp points}) * (\text{total on/off time})$
Resolution bandwidth:	1 MHz (500 kHz for 5.8 GHz band)
Video bandwidth:	$\geq 3xRBW$
Span:	$> EBW$
Trace mode:	Max hold
Used test setup:	See chapter 6.5 A
Measurement uncertainty:	See chapter 8

Limits:

Power Spectral Density
power spectral density e.i.r.p. ≤ 10 dBm in any 1 MHz band (band 5150 – 5250 MHz)

Result: OFDM / a – mode

OFDM / a – mode Channel	Power spectral density [dBm/MHz]			
	5180 MHz	5200 MHz	5240 MHz	-/-
	-2.35	-2.41	-2.17	-/-

Result: OFDM / n HT20 – mode

OFDM / n HT20 – mode Channel	Power spectral density [dBm/MHz]			
	5180 MHz	5200 MHz	5240 MHz	-/-
	-2.50	-0.10	-0.32	-/-

11.6 Spectrum bandwidth – 26 dB bandwidth

Description:

Measurement of the 26 dB bandwidth of the modulated signal.

Measurement:

Measurement parameter	
According to: KDB789033 D02, C.1.	
Detector:	Peak
Sweep time:	Auto
Resolution bandwidth:	1% EBW
Video bandwidth:	≥ RBW
Span:	> complete signal!
Trace-Mode:	Max hold
Used test setup:	See chapter 6.5 A
Measurement uncertainty:	See chapter 8

Limits:

Spectrum Bandwidth – 26 dB Bandwidth
-/-

Result:

OFDM / a – mode	26 dB bandwidth [MHz]			
	5180 MHz	5200 MHz	5240 MHz	-/-
Channel	22.03	22.63	21.98	-/-

OFDM / n HT20 – mode	26 dB bandwidth [MHz]			
	5180 MHz	5200 MHz	5240 MHz	-/-
Channel	22.43	22.58	23.33	-/-

Plots: OFDM / a – mode

Plot 1: 5180 MHz

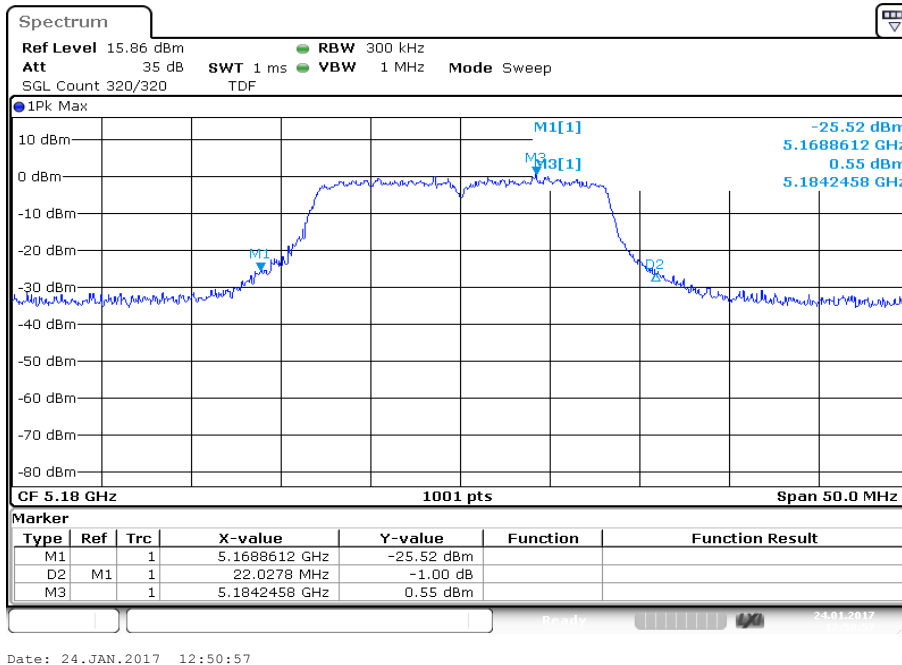

Plot 2: 5200 MHz

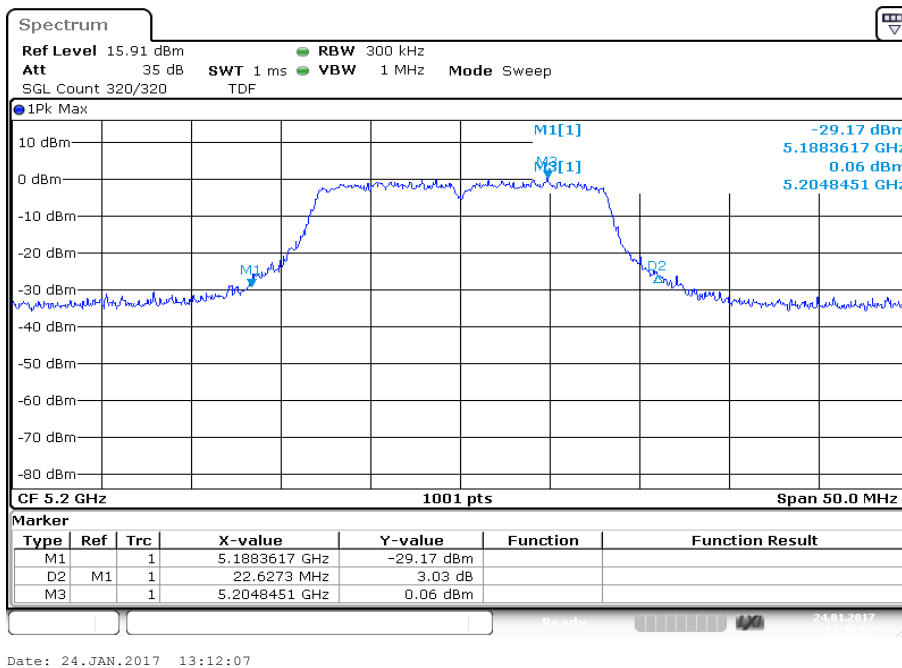

Plot 3: 5240 MHz

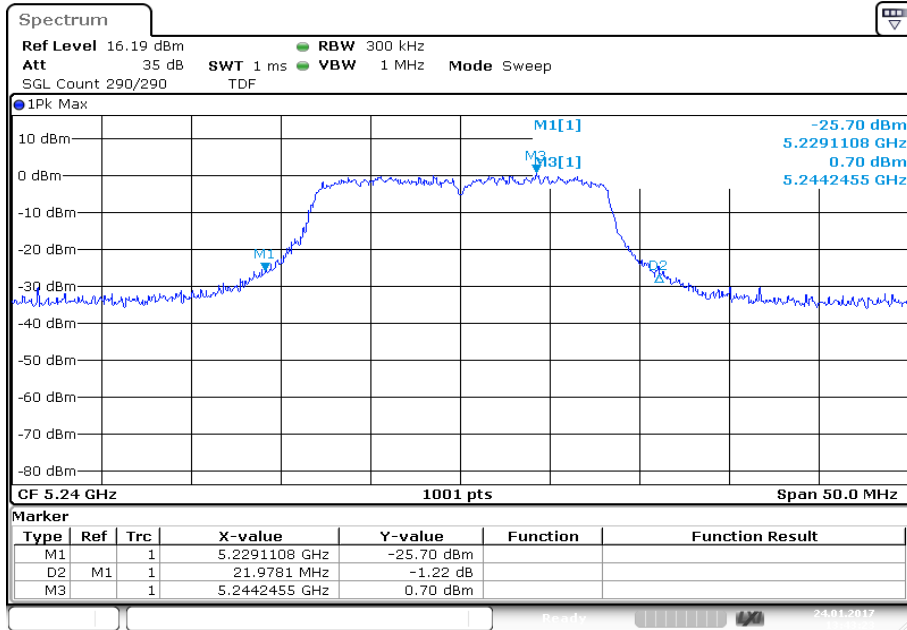

Date: 24.JAN.2017 13:43:24

Plots: OFDM / n HT20 – mode

Plot 1: 5180 MHz

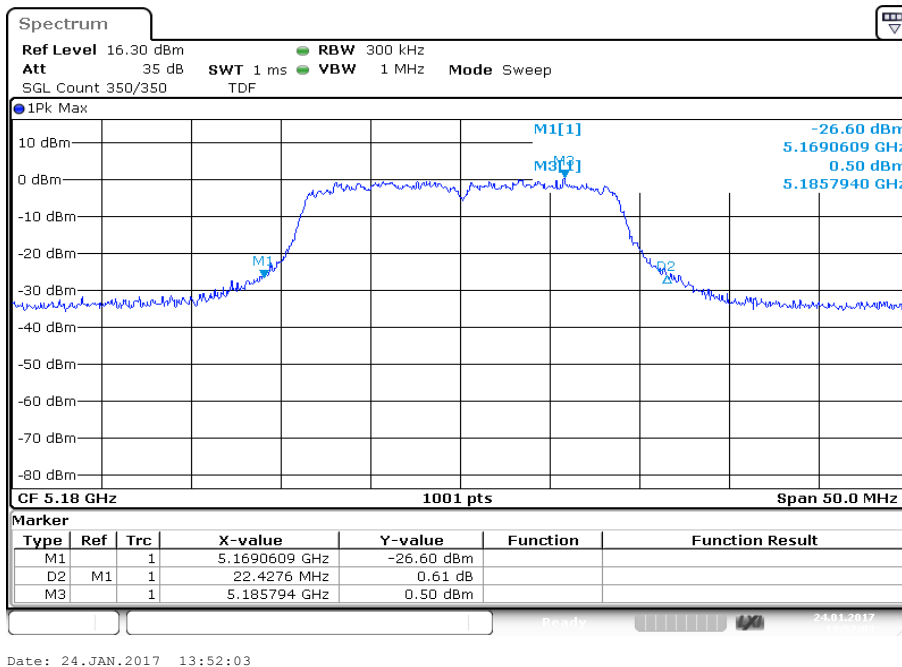

Plot 2: 5200 MHz

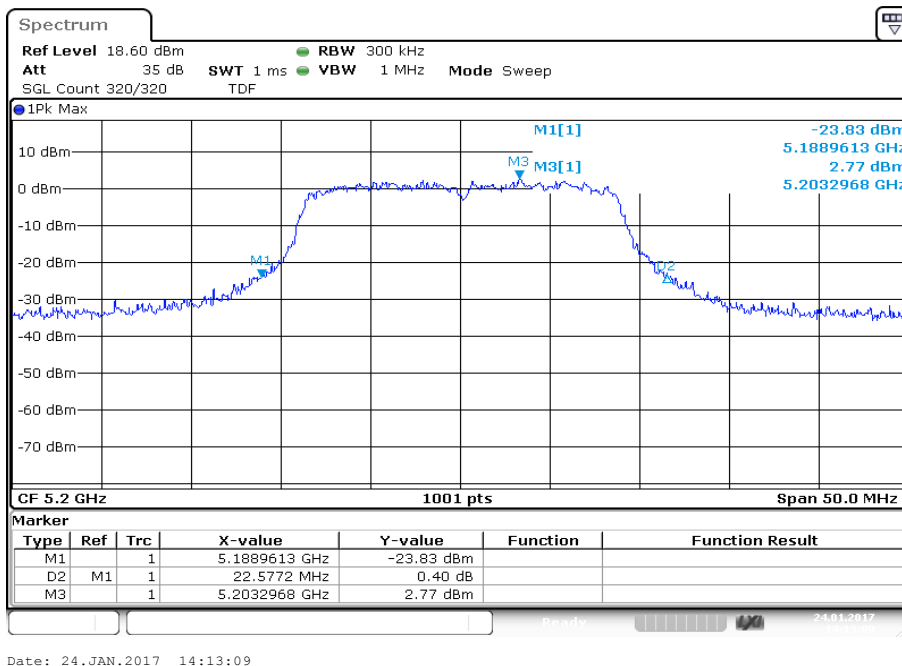

Plot 3: 5240 MHz

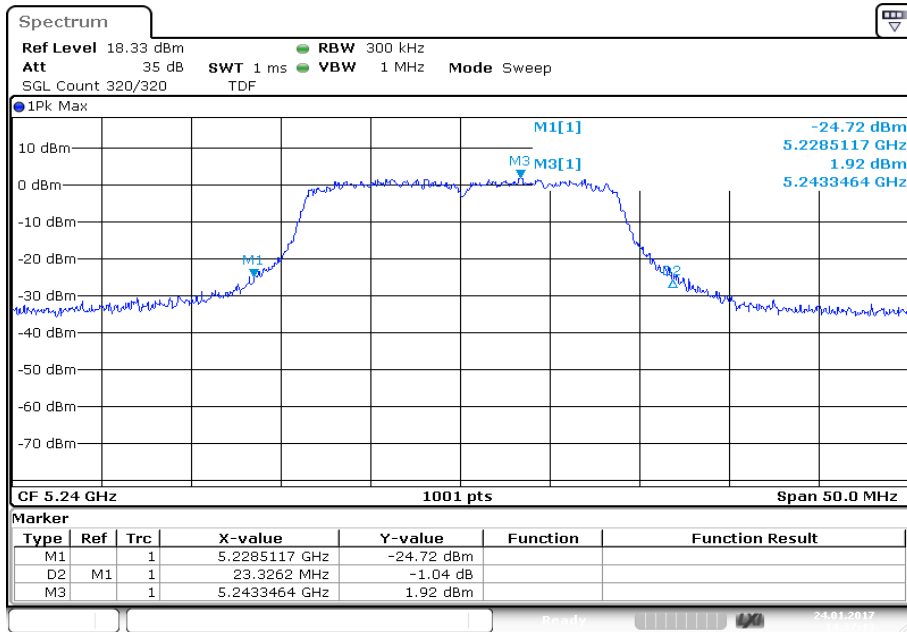

Date: 24.JAN.2017 14:37:13

11.7 Occupied bandwidth – 99% emission bandwidth

Description:

Measurement of the 99% bandwidth of the modulated signal acc. RSS-GEN.

Measurement:

Measurement parameter	
Detector:	Peak
Sweep time:	Auto
Resolution bandwidth:	300 kHz / 500 kHz
Video bandwidth:	1 MHz / 3 MHz
Span:	50 MHz / 100 MHz
Measurement procedure:	Measurement of the 99% bandwidth using the integration function of the analyzer
Trace – mode:	Max hold (allow trace to stabilize)
Test setup:	See chapter 6.5 A
Measurement uncertainty:	See chapter 8

Usage:

-/-	IC
Occupied Bandwidth – 99% emission bandwidth	
OBW is necessary for Emission Designator	

Result:

OFDM / a – mode Channel	99% bandwidth [kHz]			
	5180 MHz	5200 MHz	5240 MHz	-/-
	16683	16683	16783	-/-

Result:

OFDM / n HT20 – mode Channel	99% bandwidth [kHz]			
	5180 MHz	5200 MHz	5240 MHz	-/-
	17882	17832	17832	-/-

Plots: OFDM / a – mode

Plot 1: 5180 MHz

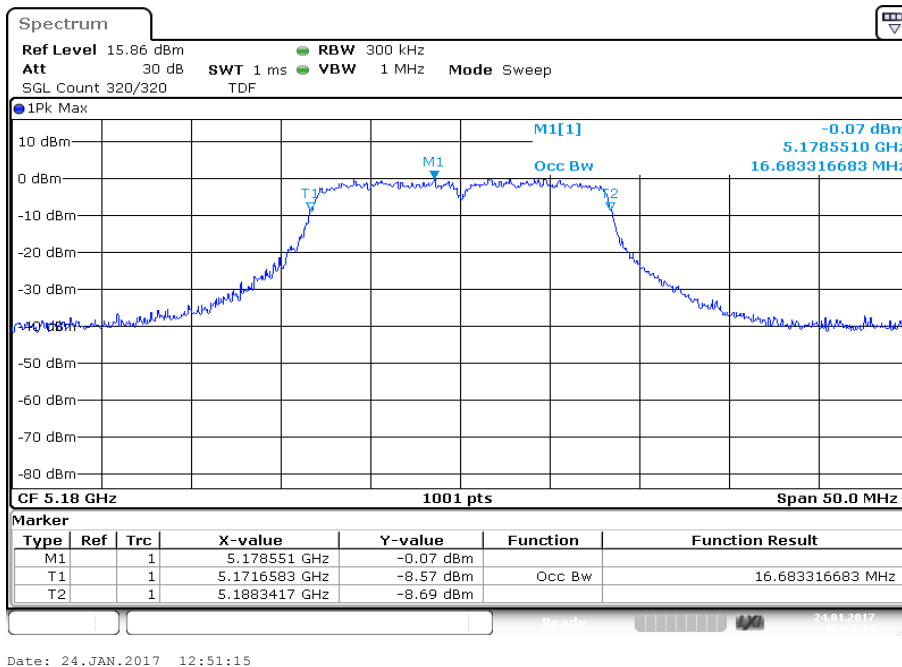

Plot 2: 5200 MHz

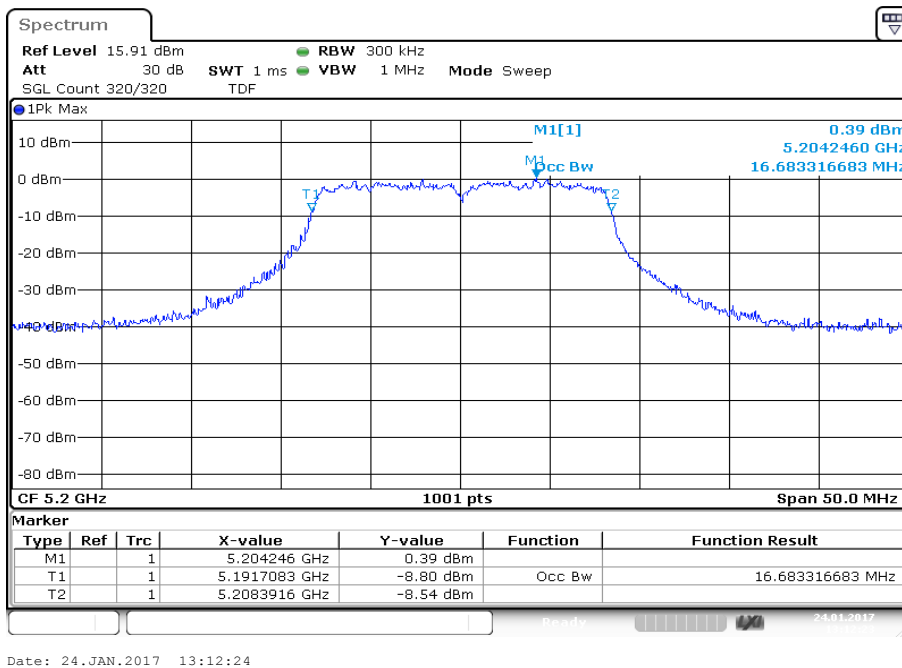

Plot 3: 5240 MHz

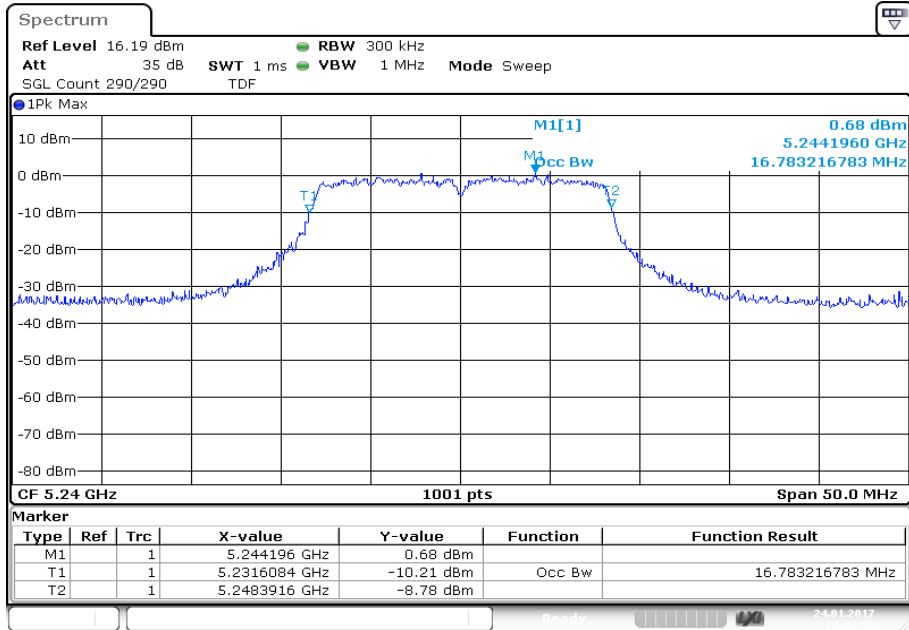

Date: 24.JAN.2017 13:43:38

Plots: OFDM / n HT20 – mode

Plot 1: 5180 MHz

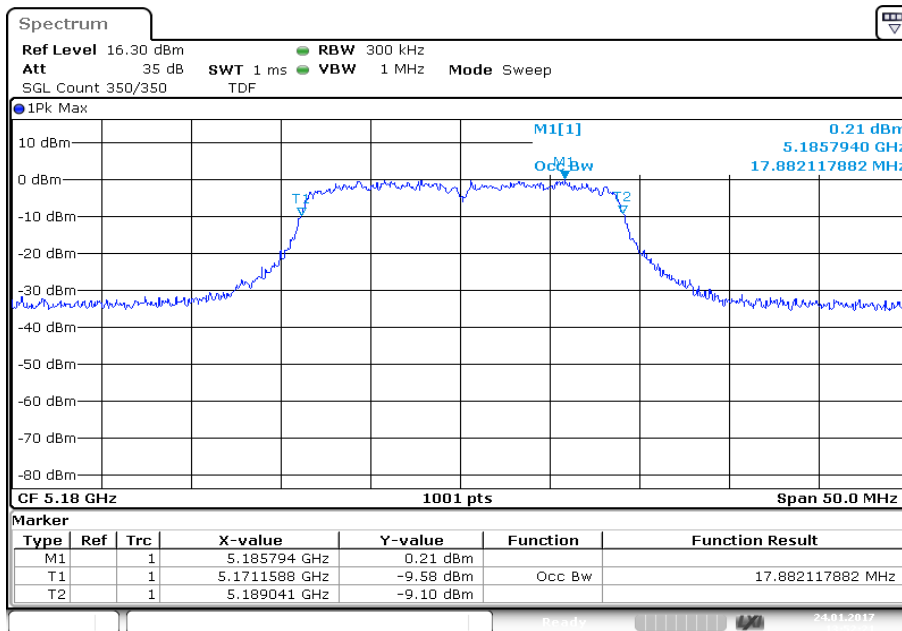

Date: 24.JAN.2017 13:52:22

Plot 2: 5200 MHz

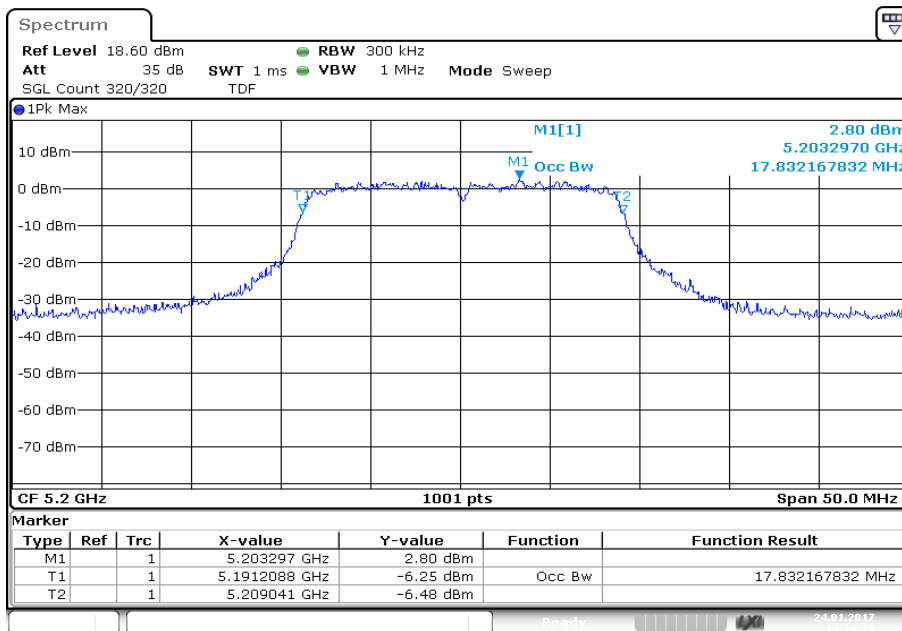

Date: 24.JAN.2017 14:13:26

Plot 3: 5240 MHz

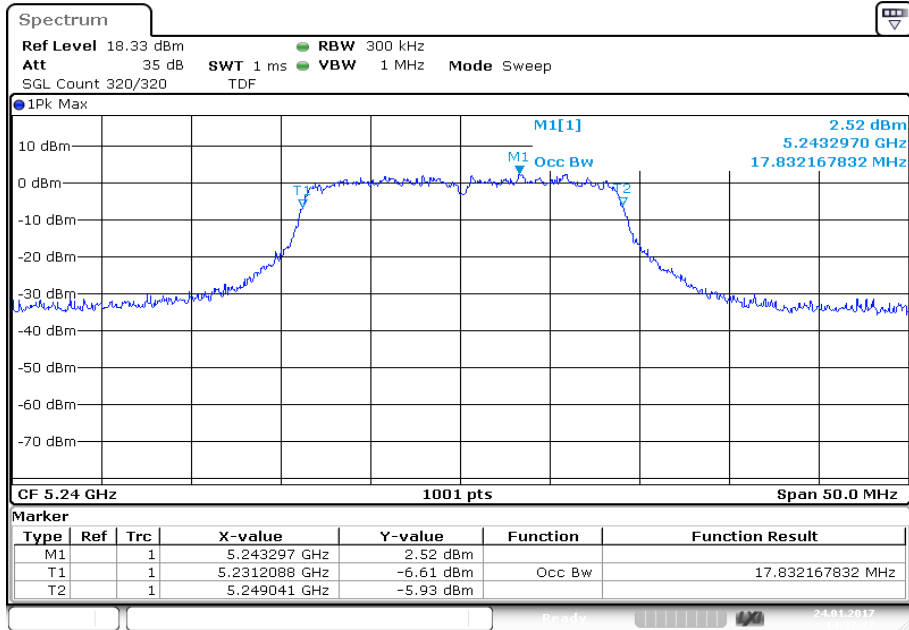

Date: 24.JAN.2017 14:37:28

11.8 Band edge compliance radiated

Description:

Measurement of the radiated band edge compliance. The EUT is turned in the position that results in the maximum level at the band edge. Then a sweep over the corresponding restricted band is performed. The EUT is set to the lowest channel for the lower restricted band and to the highest channel for the upper restricted band. Measurement distance is 3m.

Measurement:

Measurement parameter	
Detector:	Peak / RMS
Sweep time:	Auto
Resolution bandwidth:	1 MHz
Video bandwidth:	≥ 3 x RBW
Span:	See plots!
Trace – mode:	Max Hold
Test setup:	See sub clause 6.2 B
Measurement uncertainty:	See sub clause 8

Limits:

Band Edge Compliance Radiated
In any 100 kHz bandwidth outside the frequency band in which the spread spectrum or digitally modulated intentional radiator is operating, the radio frequency power that is produced by the intentional radiator shall be at least 20 dB below that in the 100 kHz bandwidth within the band that contains the highest level of the desired power, based on either an RF conducted or a radiated measurement. Attenuation below the general limits specified in Section 15.209(a) is not required. In addition, radiated emissions which fall in the restricted bands, as defined in Section 15.205(a), must also comply with the radiated emission limits specified in Section 15.209(a) (see Section 5.205(c)).
74 dBµV/m (peak) 54 dBµV/m (average)

Result:

Scenario	Band Edge Compliance Radiated [dBµV/m]
band edge	62.1 (peak) 47.0 (average)

Plots:

Plot 1: lower band edge, vertical & horizontal polarization – OFDM 20 MHz, 5180 MHz (a-mode)

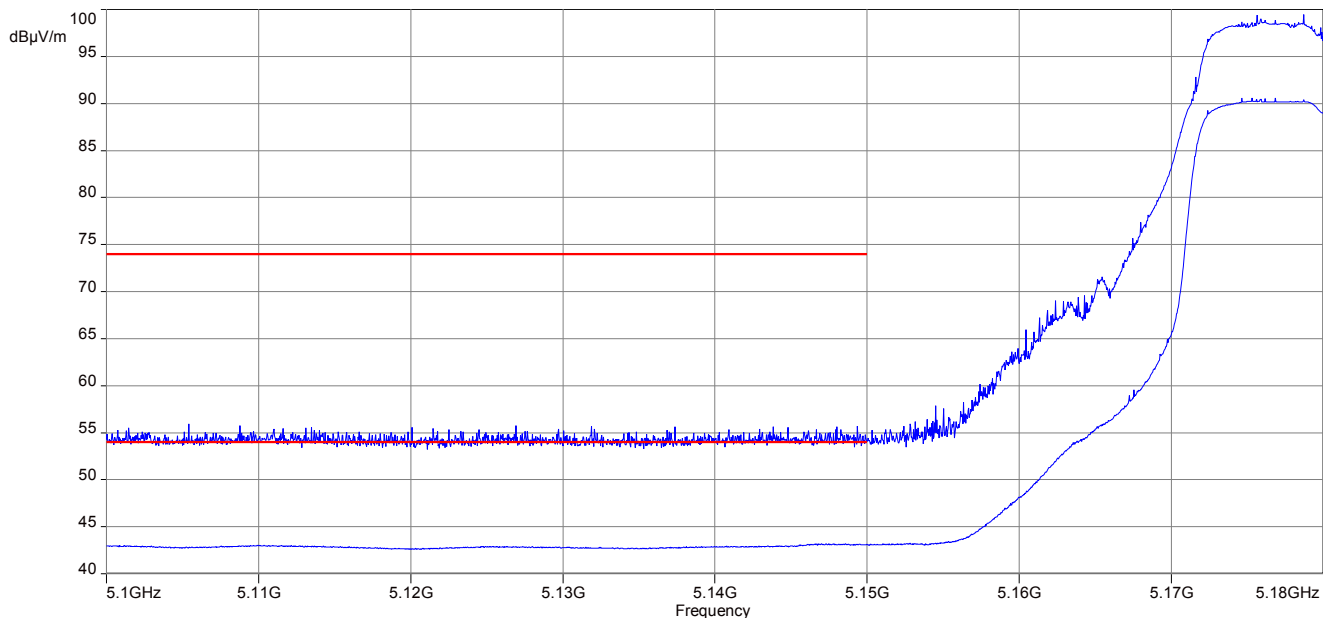

Plot 2: lower band edge, vertical & horizontal polarization – OFDM 20 MHz, 5180 MHz (n HT20-mode)

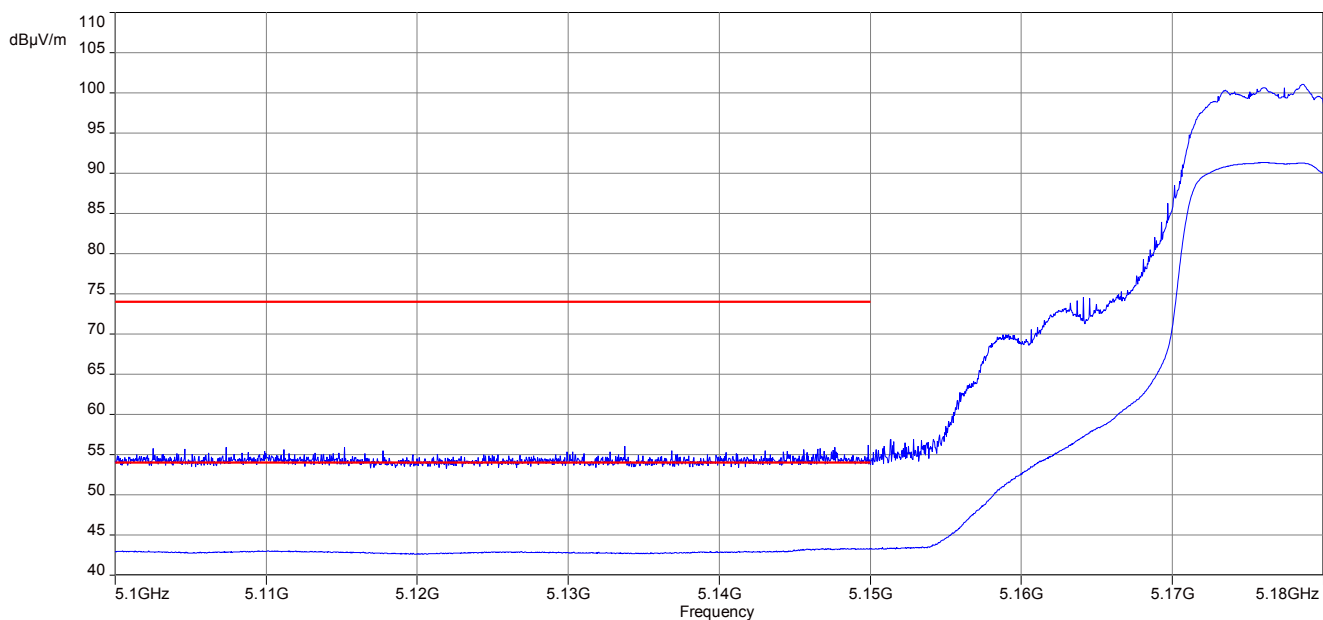

11.9 TX spurious emissions radiated

Description:

Measurement of the radiated spurious emissions in transmit mode. The measurement is performed at lowest, middle and highest channel.

Measurement:

Measurement parameter	
Detector:	Quasi Peak below 1 GHz (alternative Peak) Peak above 1 GHz / RMS
Sweep time:	Auto
Resolution bandwidth:	F < 1 GHz: 100 kHz F > 1 GHz: 1 MHz
Video bandwidth:	F < 1 GHz: 100 kHz F > 1 GHz: ≥ 3 MHz / 1 MHz
Span:	30 MHz to 40 GHz
Trace mode:	Max Hold / Average with 100 counts + 20 log (1 / X) for duty cycle lower than 100 %
Test setup:	See sub clause 6.1 A See sub clause 6.2 B See sub clause 6.3 A
Measurement uncertainty:	See sub clause 8

Limits:

TX Spurious Emissions Radiated		
§15.209		
Frequency (MHz)	Field Strength (dBµV/m)	Measurement distance
30 - 88	30.0	10
88 – 216	33.5	10
216 – 960	36.0	10
Above 960	54.0	3
§15.407		
Outside the restricted bands!	-27 dBm / MHz	

Results: OFDM (20 MHz bandwidth)

TX Spurious Emissions Radiated [dB μ V/m] / dBm								
Lowest channel 5180 MHz			Middle channel 5200 MHz			Highest channel 5240 MHz		
F [MHz]	Detector	Level [dB μ V/m]	F [MHz]	Detector	Level [dB μ V/m]	F [MHz]	Detector	Level [dB μ V/m]
For emissions below 1 GHz, please look at the table below the plot.			For emissions below 1 GHz, please look at the table below the plot.			For emissions below 1 GHz, please look at the table below the plot.		
All detected peak emissions between 1 GHz and 18 GHz are below the average limit.			All detected peak emissions between 1 GHz and 18 GHz are below the average limit.			All detected peak emissions between 1 GHz and 18 GHz are below the average limit.		
For emissions above 18 GHz please take look at the plots.			For emissions above 18 GHz please take look at the plots.			For emissions above 18 GHz please take look at the plots.		

Plots: OFDM / 20 MHz bandwidth

Plot 1: 30 MHz to 1 GHz, 5180 MHz, vertical & horizontal polarization

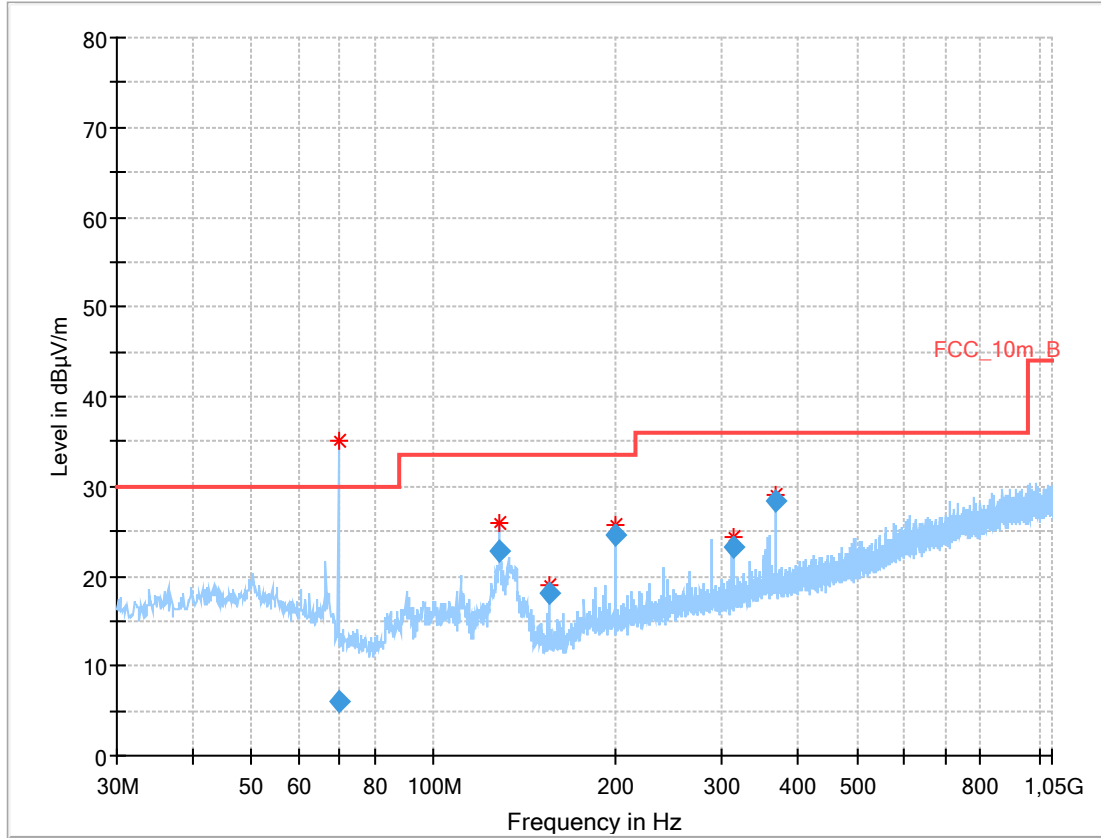

Final_Result:

Frequency (MHz)	QuasiPeak (dBµV/m)	Limit (dBµV/m)	Margin (dB)	Meas. Time (ms)	Bandwidth (kHz)	Height (cm)	Pol	Azimuth (deg)	Corr. (dB)
69.904950	6.08	30.00	23.92	1000.0	120.000	185.0	H	137.0	9.7
128.464500	22.90	33.50	10.60	1000.0	120.000	101.0	V	137.0	9.7
155.148900	18.08	33.50	15.42	1000.0	120.000	98.0	V	107.0	9.5
199.490550	24.50	33.50	9.00	1000.0	120.000	98.0	V	177.0	11.9
312.028650	23.35	36.00	12.65	1000.0	120.000	98.0	V	177.0	14.8
368.222250	28.47	36.00	7.53	1000.0	120.000	101.0	V	353.0	16.3

Plot 2: 1 GHz to 7 GHz, 5180 MHz, vertical & horizontal polarization

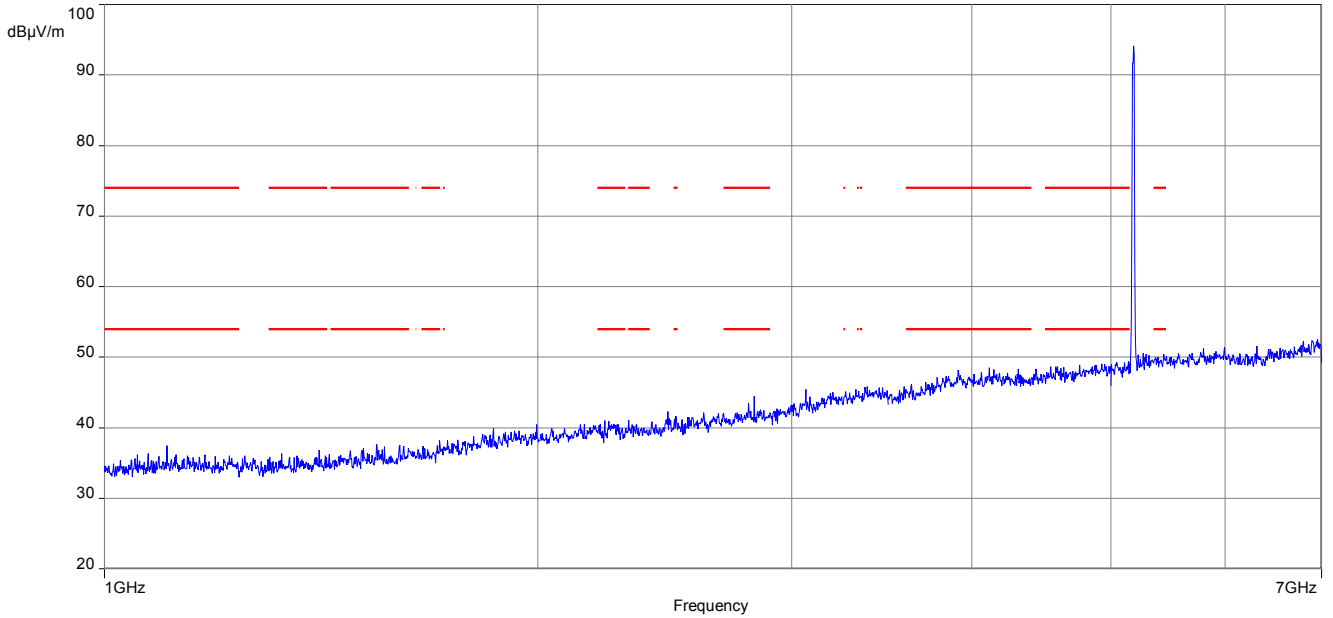

Plot 3: 7 GHz to 18 GHz, 5180 MHz, vertical & horizontal polarization

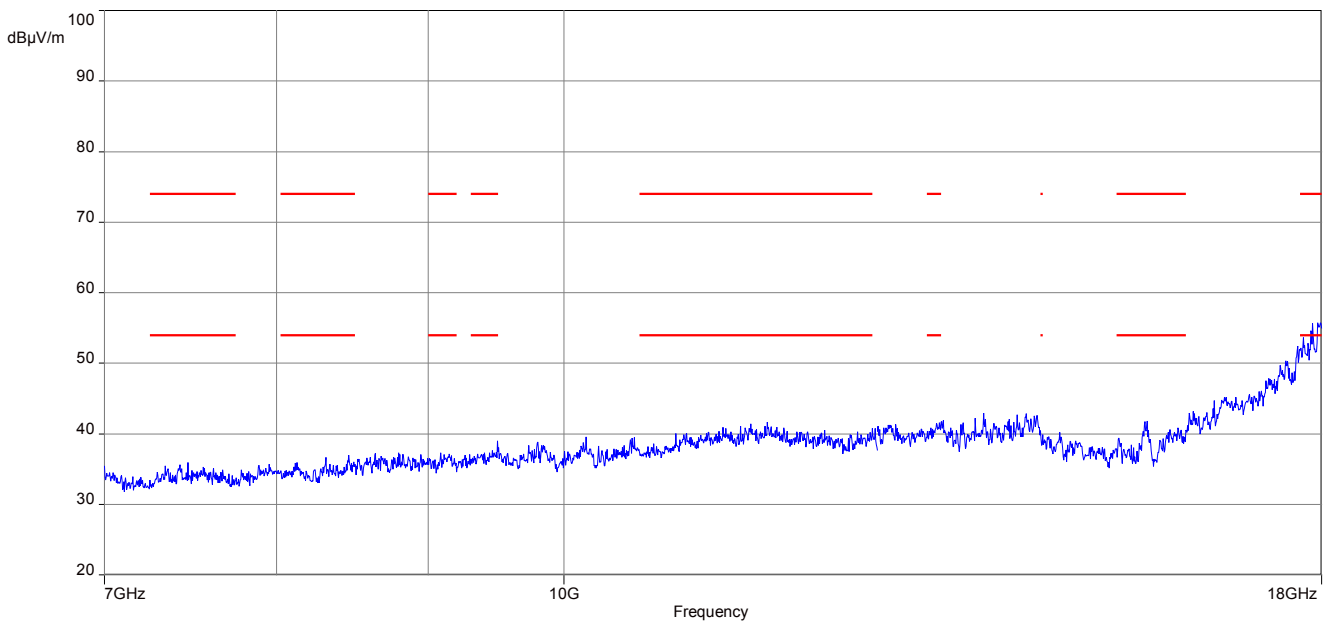

Plot 4: 17.7 GHz to 18 GHz, 5180 MHz, vertical & horizontal polarization

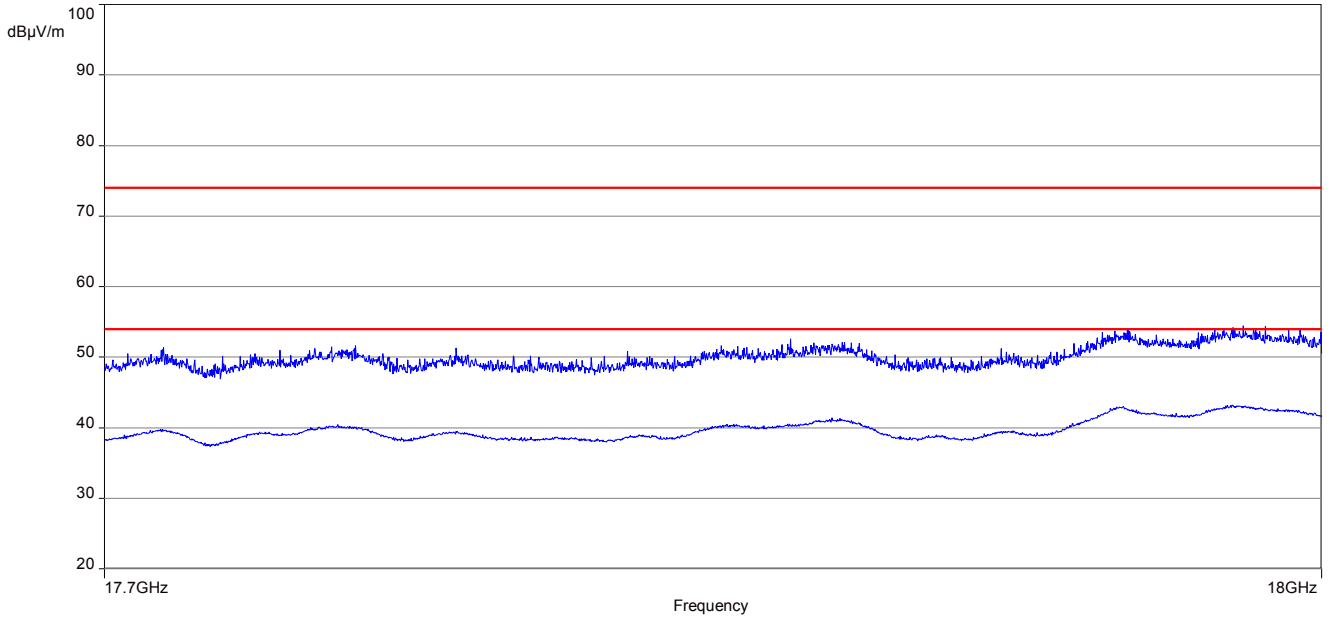

Plot 5: 18 GHz to 26 GHz, 5180 MHz, vertical & horizontal polarization

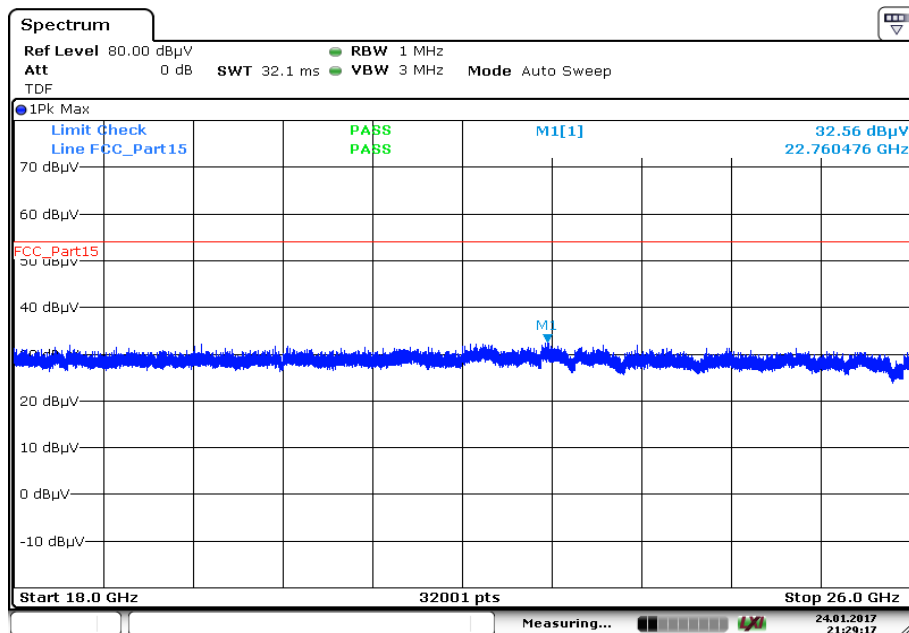

Date: 24.JAN.2017 21:29:18

Plot 6: 26 GHz to 40 GHz, 5180 MHz, vertical & horizontal polarization

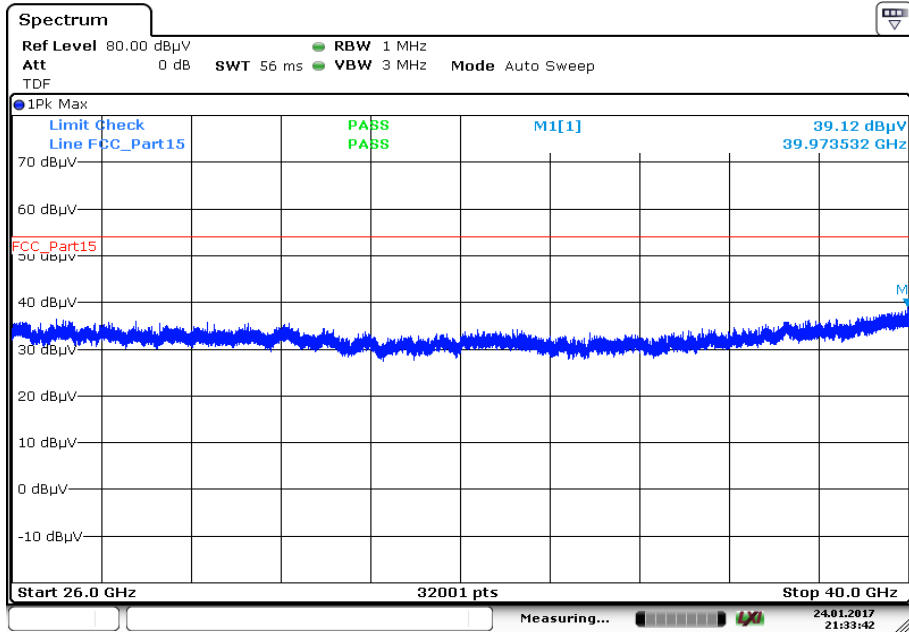

Date: 24.JAN.2017 21:33:41

Plot 7: 30 MHz to 1 GHz, 5200 MHz, vertical & horizontal polarization

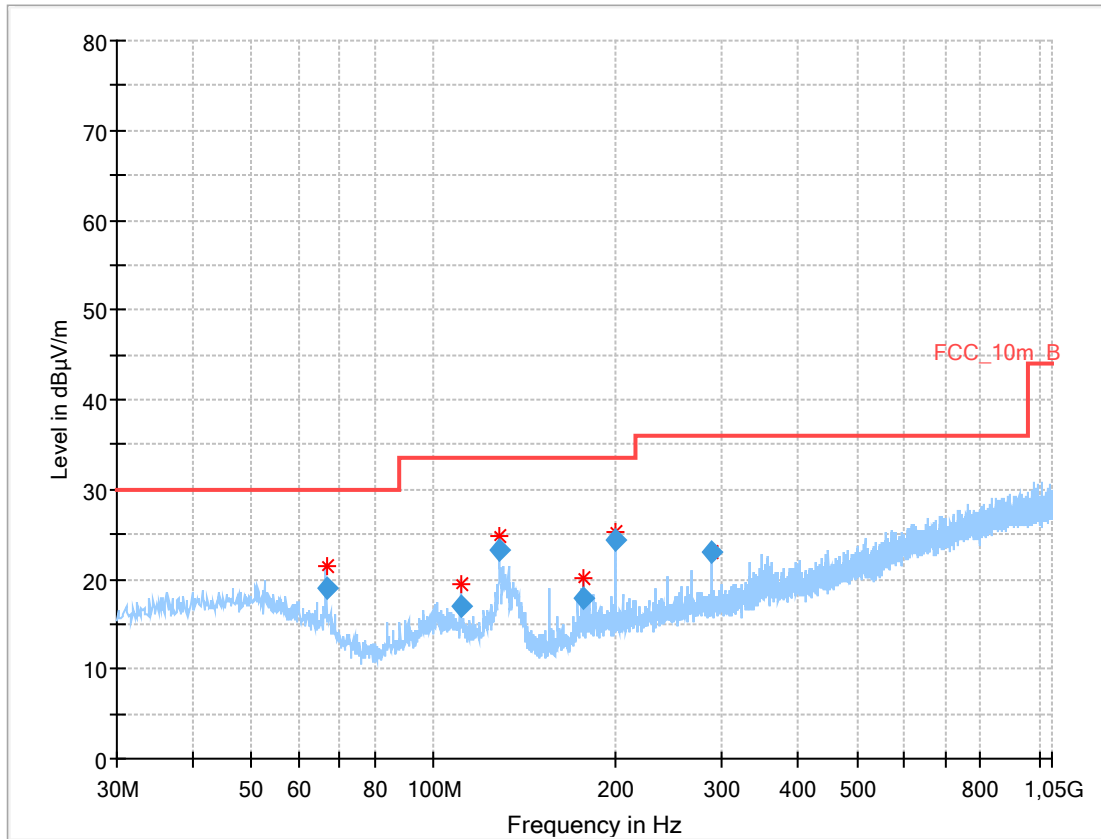

Final_Result:

Frequency (MHz)	QuasiPeak (dBµV/m)	Limit (dBµV/m)	Margin (dB)	Meas. Time (ms)	Bandwidth (kHz)	Height (cm)	Pol	Azimuth (deg)	Corr. (dB)
66.496500	19.10	30.00	10.90	1000.0	120.000	179.0	V	264.0	10.4
110.811900	16.91	33.50	16.59	1000.0	120.000	98.0	V	97.0	11.1
128.425800	23.23	33.50	10.27	1000.0	120.000	101.0	V	53.0	9.7
177.304200	17.97	33.50	15.53	1000.0	120.000	98.0	V	350.0	10.7
199.486050	24.40	33.50	9.10	1000.0	120.000	98.0	V	161.0	11.9
288.159450	22.95	36.00	13.05	1000.0	120.000	98.0	V	9.0	14.2

Plot 8: 1 GHz to 7 GHz, 5200 MHz, vertical & horizontal polarization

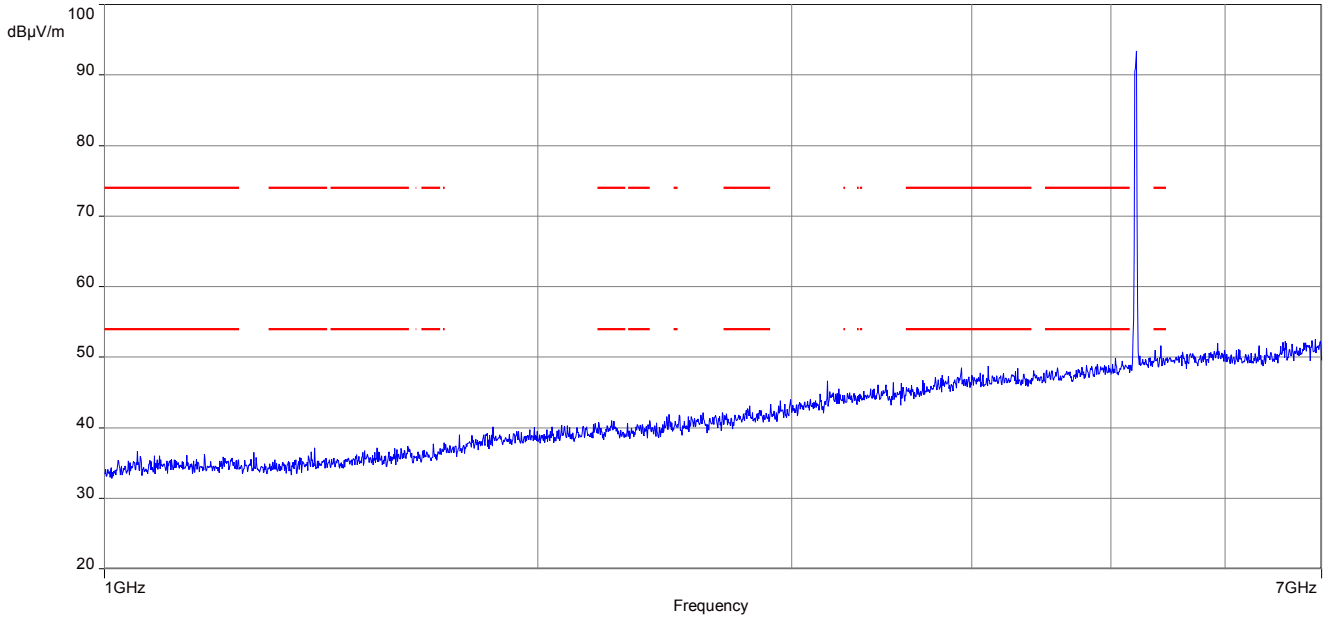

Plot 9: 7 GHz to 18 GHz, 5200 MHz, vertical & horizontal polarization

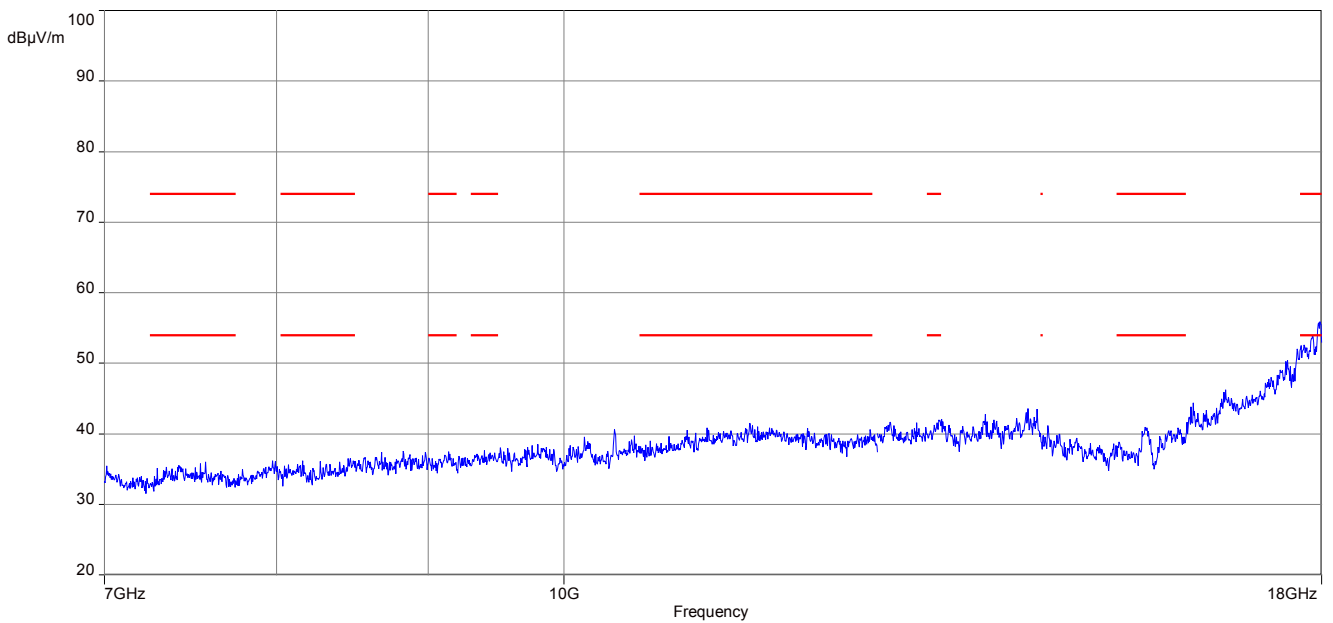

Plot 10: 17.7 GHz to 18 GHz, 5200 MHz, vertical & horizontal polarization

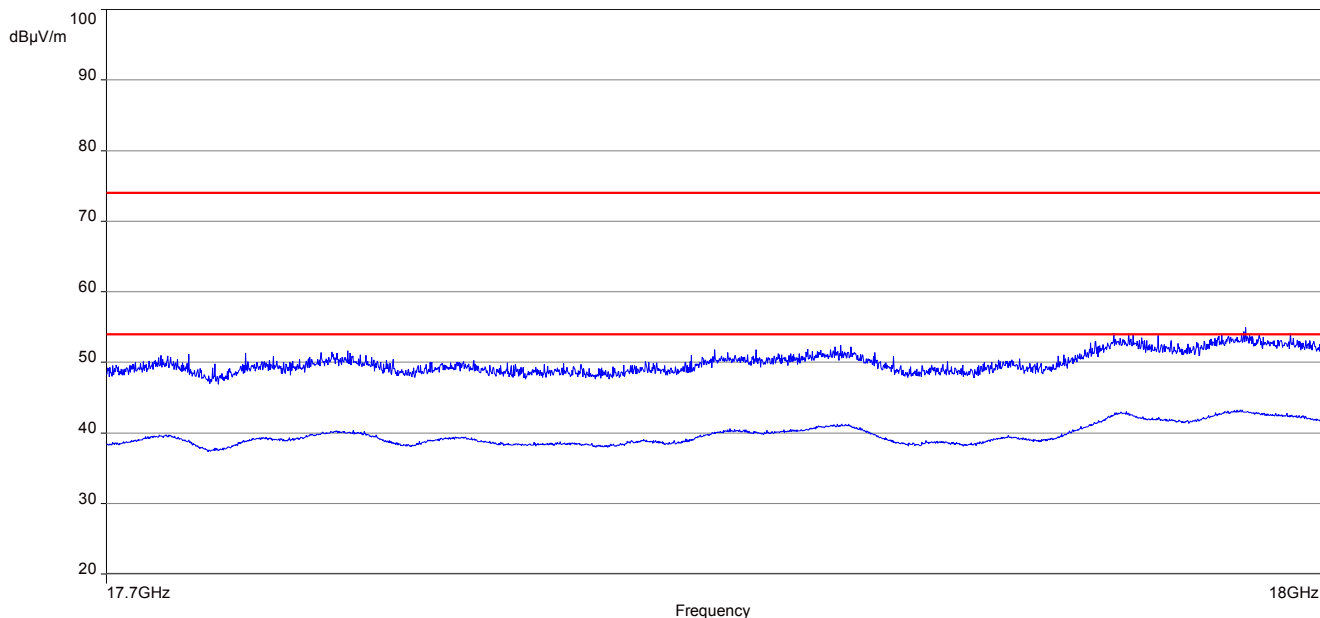

Plot 11: 18 GHz to 26 GHz, 5200 MHz, vertical & horizontal polarization

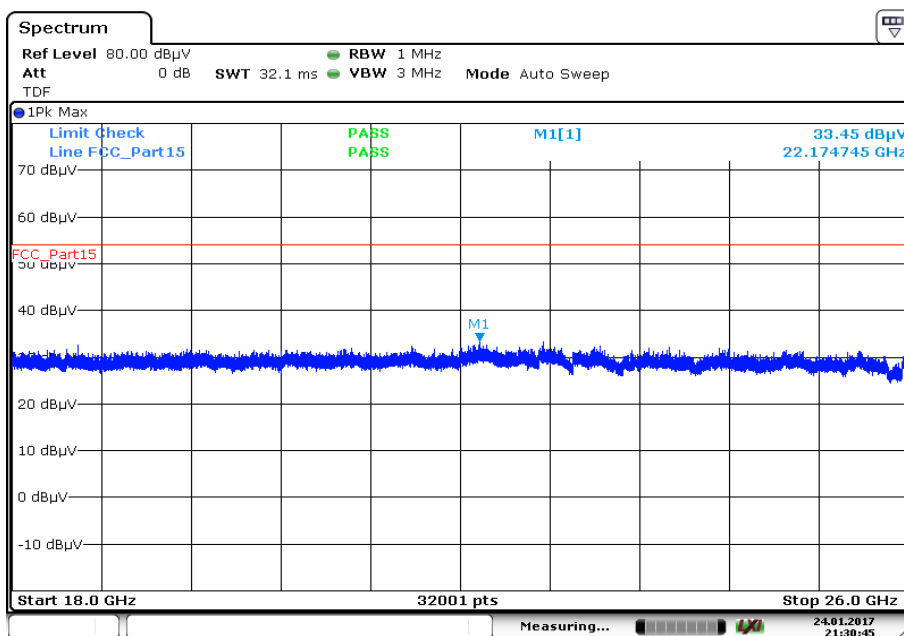

Date: 24.JAN.2017 21:30:45

Plot 12: 26 GHz to 40 GHz, 5200 MHz, vertical & horizontal polarization

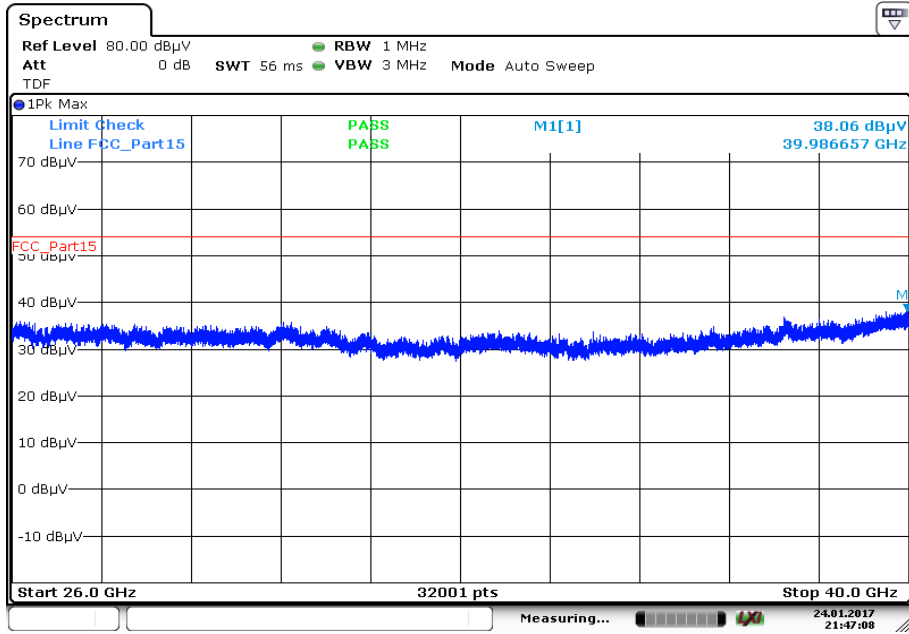

Date: 24.JAN.2017 21:47:09

Plot 13: 30 MHz to 1 GHz, 5240 MHz, vertical & horizontal polarization

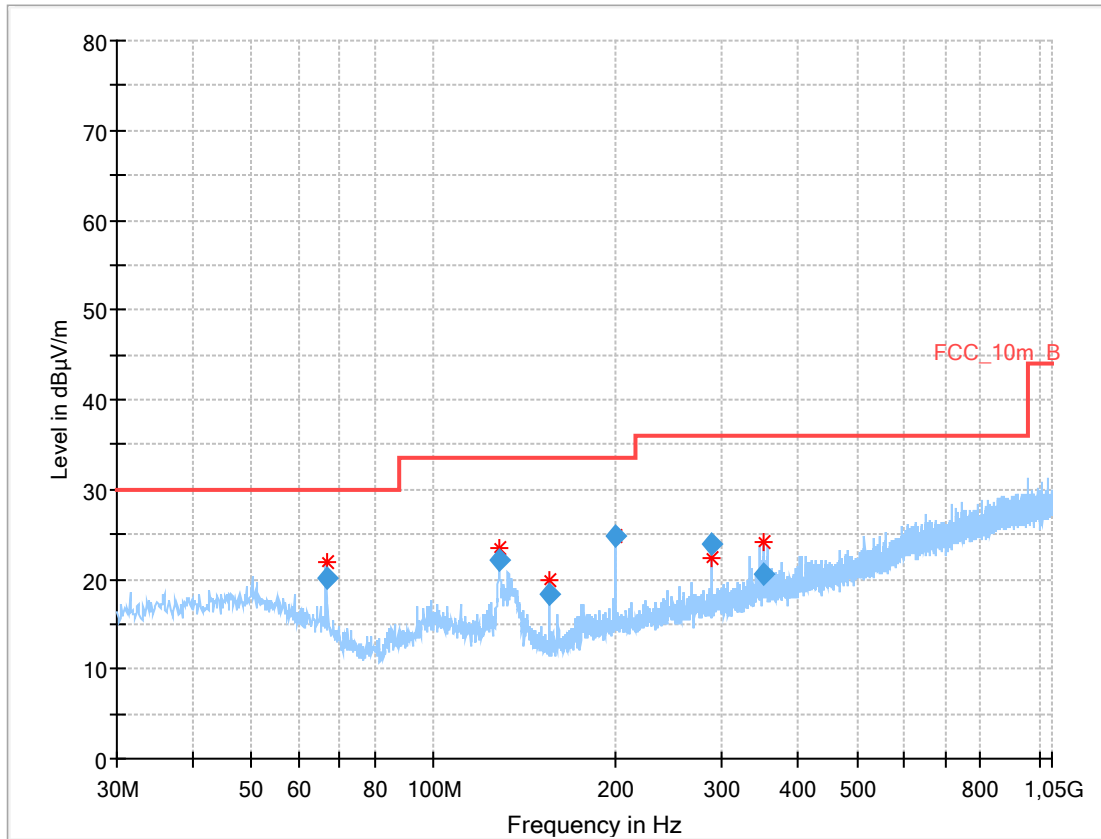

Final_Result:

Frequency (MHz)	QuasiPeak (dBµV/m)	Limit (dBµV/m)	Margin (dB)	Meas. Time (ms)	Bandwidth (kHz)	Height (cm)	Pol	Azimuth (deg)	Corr. (dB)
66.513750	20.21	30.00	9.79	1000.0	120.000	185.0	V	306.0	10.4
128.440800	22.02	33.50	11.48	1000.0	120.000	101.0	V	174.0	9.7
155.163150	18.36	33.50	15.14	1000.0	120.000	98.0	V	108.0	9.5
199.491600	24.80	33.50	8.70	1000.0	120.000	98.0	V	174.0	11.9
288.154050	23.92	36.00	12.08	1000.0	120.000	185.0	H	353.0	14.2
349.813050	20.46	36.00	15.54	1000.0	120.000	98.0	V	353.0	16.0

Plot 14: 1 GHz to 7 GHz, 5240 MHz, vertical & horizontal polarization

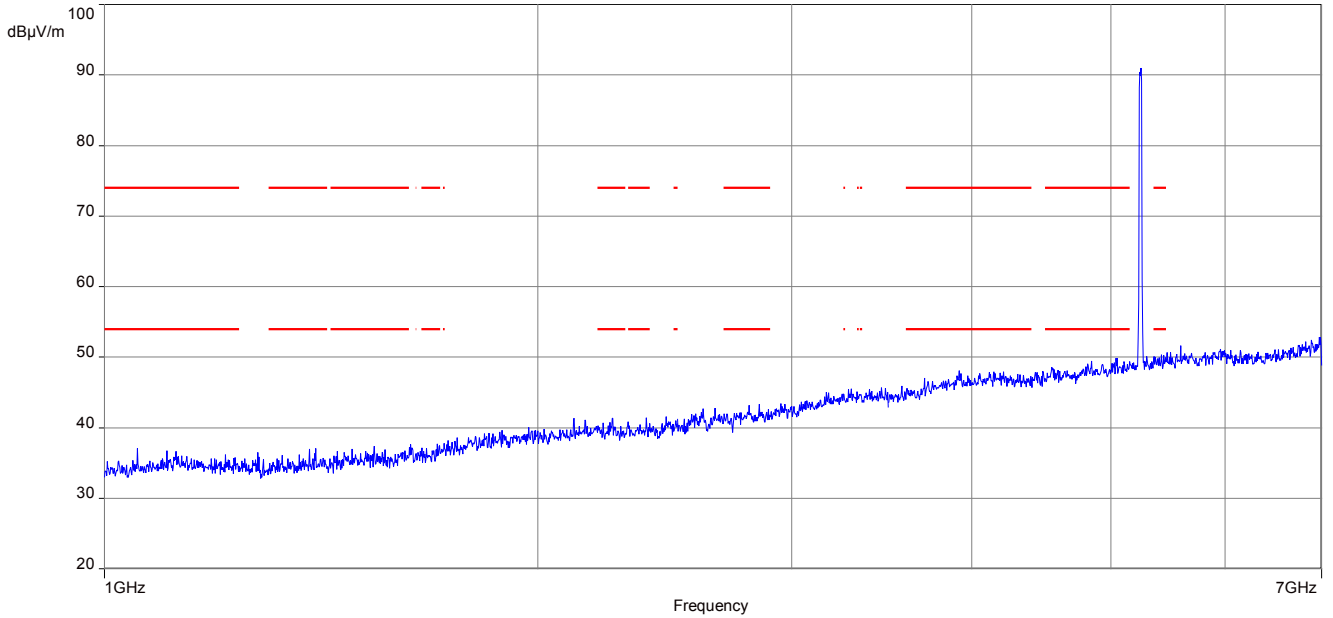

Plot 15: 7 GHz to 18 GHz, 5240 MHz, vertical & horizontal polarization

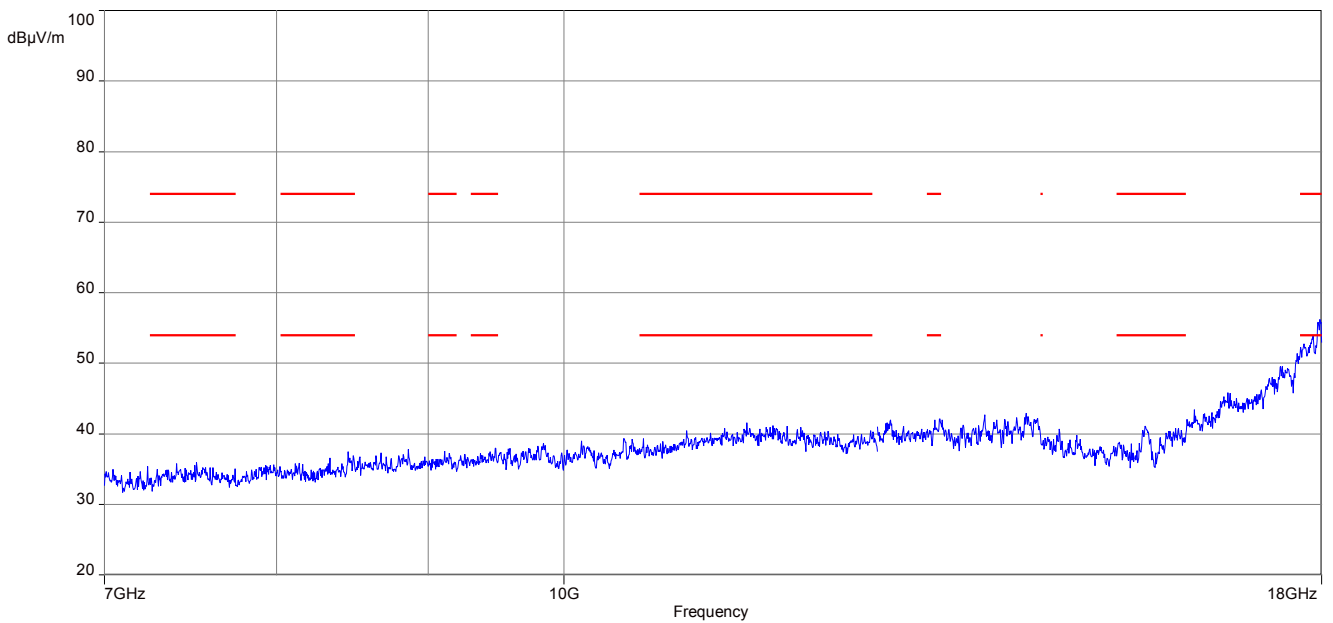

Plot 16: 17.7 GHz to 18 GHz, 5240 MHz, vertical & horizontal polarization

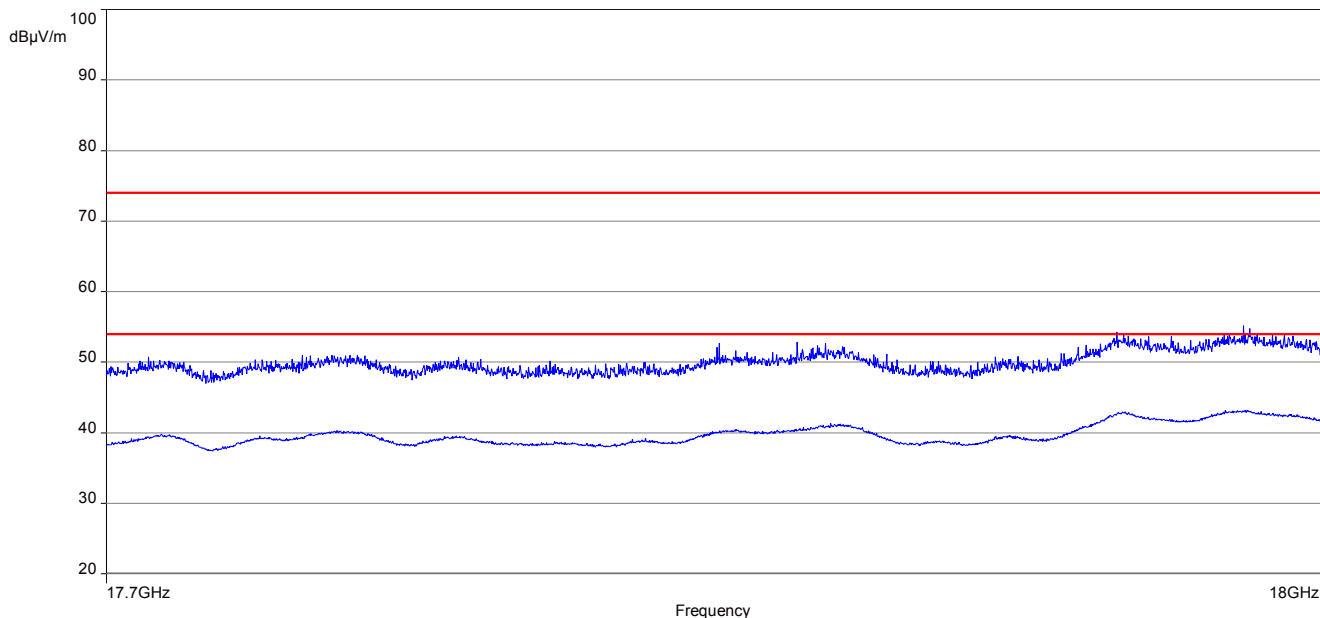

Plot 17: 18 GHz to 26 GHz, 5240 MHz, vertical & horizontal polarization

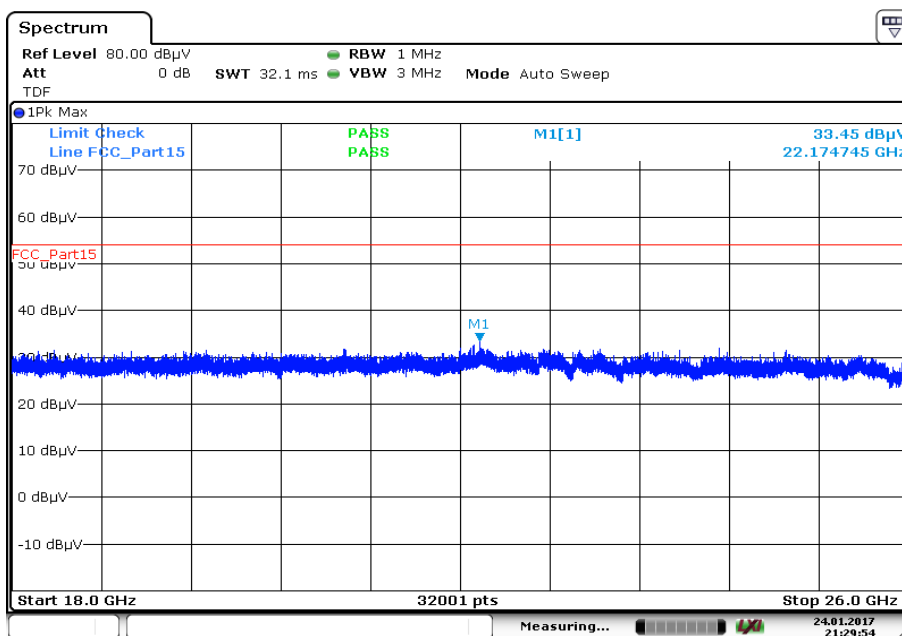

Date: 24.JAN.2017 21:29:54

Plot 18: 26 GHz to 40 GHz, 5240 MHz, vertical & horizontal polarization

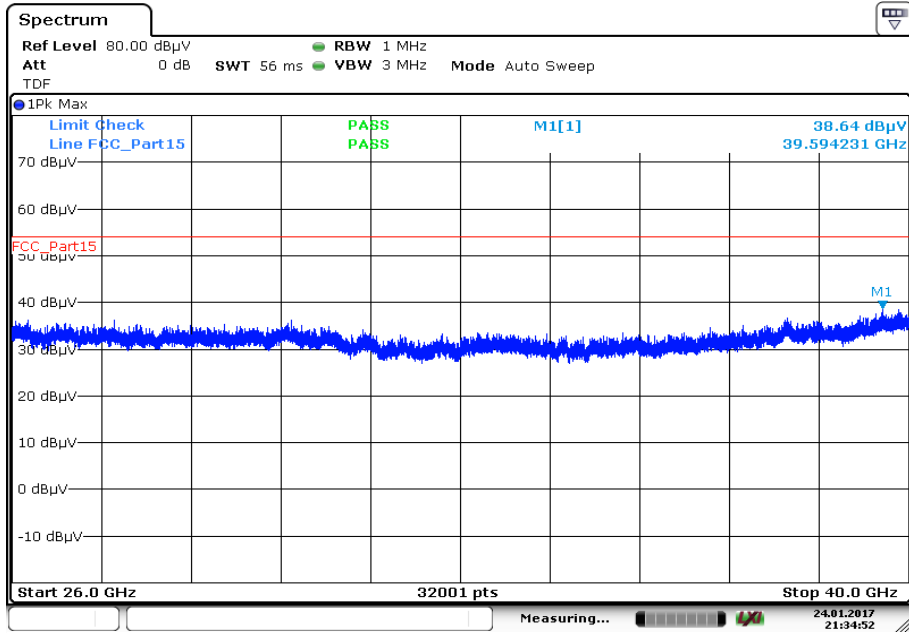

Date: 24.JAN.2017 21:34:52

11.10 RX spurious emissions radiated

Description:

Measurement of the radiated spurious emissions in idle/receive mode.

Measurement:

Measurement parameter	
Detector:	Quasi Peak below 1 GHz (alternative Peak) Peak above 1 GHz / RMS
Sweep time:	Auto
Resolution bandwidth:	F < 1 GHz: 100 kHz F > 1 GHz: 1 MHz
Video bandwidth:	F < 1 GHz: 100 kHz F > 1 GHz: ≥ 3 MHz
Span:	30 MHz to 40 GHz
Trace – mode:	Max Hold / Average with 100 counts + 20 log (1 / X) for duty cycle lower than 100 %
Test setup:	See sub clause 6.2 B See sub clause 6.3 A
Measurement uncertainty:	See sub clause 8

Limits:

RX Spurious Emissions Radiated		
Frequency (MHz)	Field Strength (dBµV/m)	Measurement distance
30 - 88	30.0	10
88 – 216	33.5	10
216 – 960	36.0	10
Above 960	54.0	3

Plots:

Plot 1: 30 MHz to 1 GHz, vertical & horizontal polarization

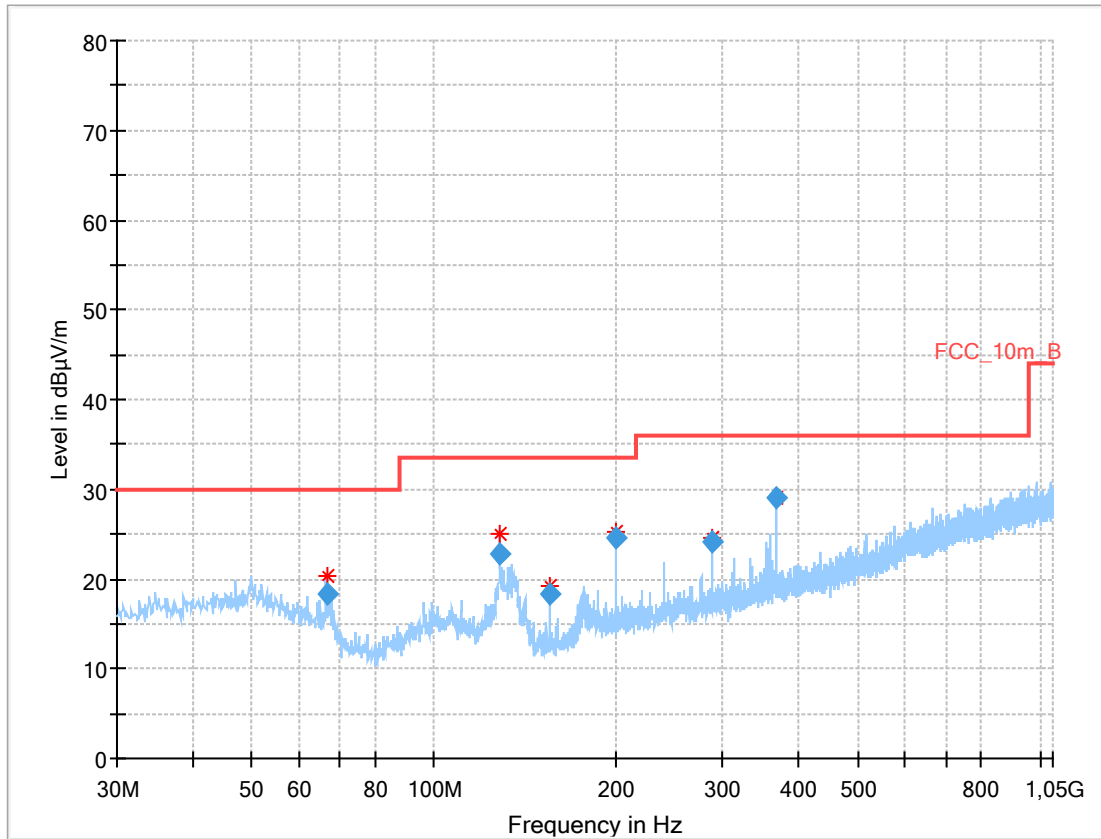

Final_Result:

Frequency (MHz)	QuasiPeak (dBµV/m)	Limit (dBµV/m)	Margin (dB)	Meas. Time (ms)	Bandwidth (kHz)	Height (cm)	Pol	Azimuth (deg)	Corr. (dB)
66.508050	18.30	30.00	11.70	1000.0	120.000	178.0	V	322.0	10.4
128.409750	22.88	33.50	10.62	1000.0	120.000	101.0	V	7.0	9.7
155.152500	18.37	33.50	15.13	1000.0	120.000	98.0	V	138.0	9.5
199.491300	24.64	33.50	8.86	1000.0	120.000	98.0	V	165.0	11.9
288.011550	24.05	36.00	11.95	1000.0	120.000	101.0	V	231.0	14.2
368.232600	29.07	36.00	6.93	1000.0	120.000	98.0	V	353.0	16.3

Plot 2: 1 GHz to 18 GHz, vertical & horizontal polarization

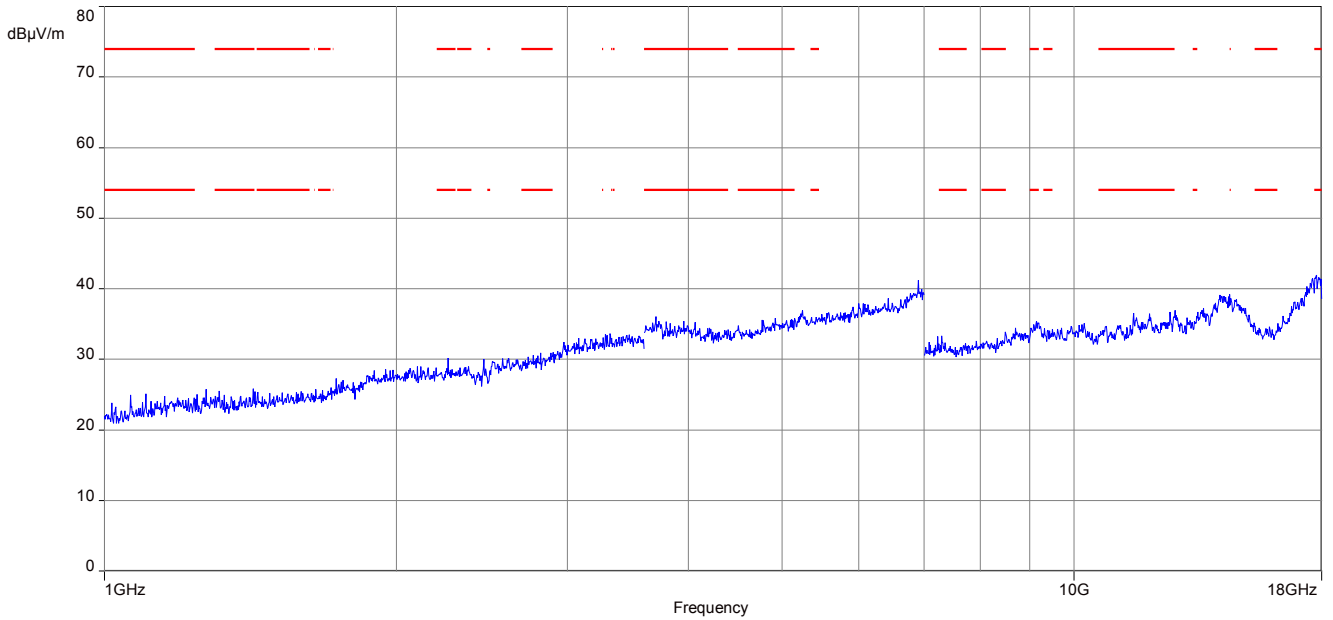

Plot 3: 18 GHz to 26 GHz, vertical & horizontal polarization

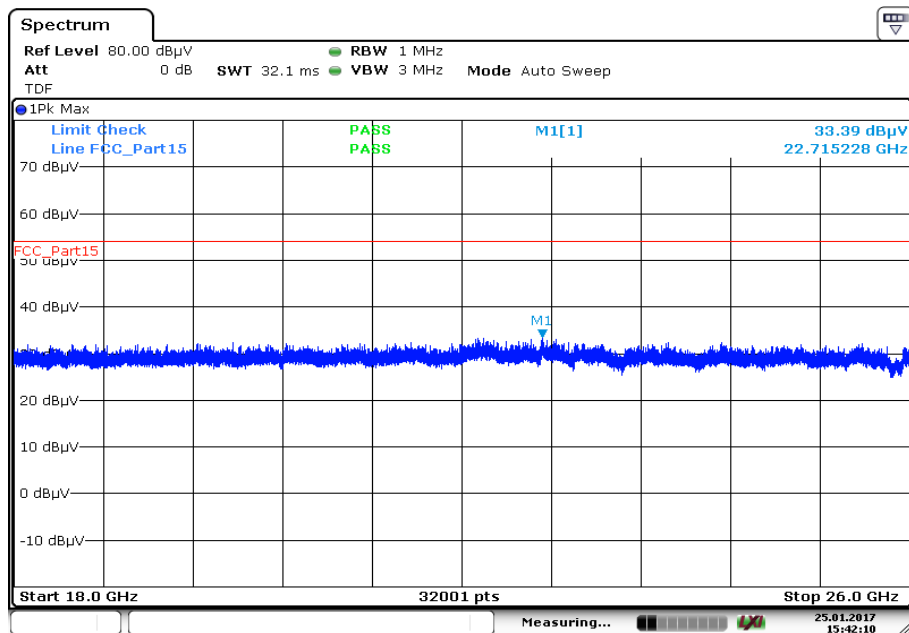

Date:25.JAN.2017 15:42:10

Plot 4: 26 GHz to 40 GHz, vertical & horizontal polarization

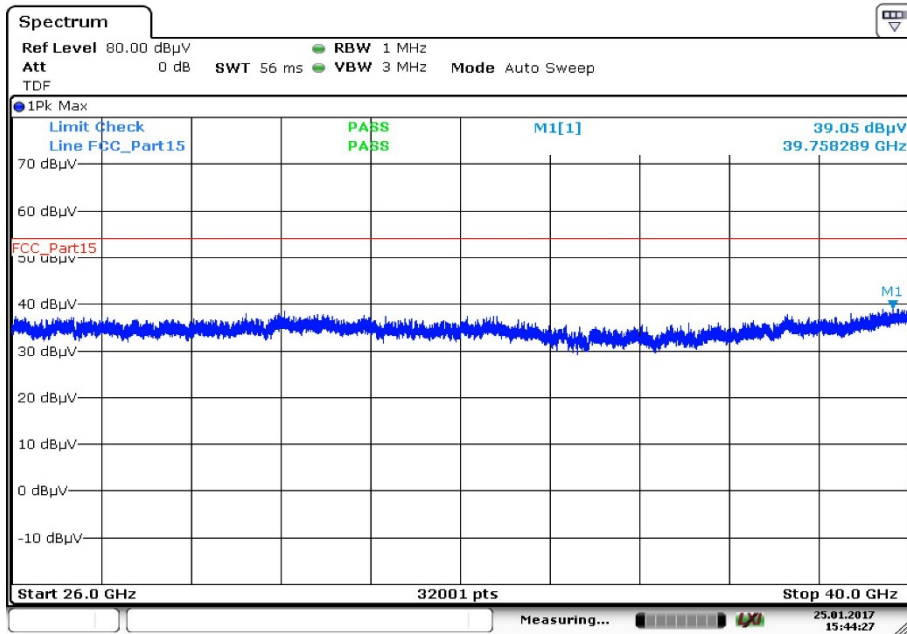

Date: 25.JAN.2017 15:44:27

11.11 Spurious emissions radiated < 30 MHz

Description:

Measurement of the radiated spurious emissions in transmit mode and receive mode below 30 MHz. The EUT is set first to middle channel. This measurement is representative for all channels and modes. If critical peaks are found the lowest channel and the highest channel will be measured too. Then the EUT is set to receive or idle mode. The limits are recalculated to a measurement distance of 3 m with 40 dB/decade according CFR Part 2.

Measurement:

Measurement parameter	
Detector:	Peak / Quasi Peak
Sweep time:	Auto
Video bandwidth:	F < 150 kHz: 200 Hz F > 150 kHz: 9 kHz
Resolution bandwidth:	F < 150 kHz: 1 kHz F > 150 kHz: 100 kHz
Span:	9 kHz to 30 MHz
Trace – mode:	Max Hold
Test setup:	See sub clause 6.2 A
Measurement uncertainty:	See sub clause 8

Limits:

Spurious Emissions Radiated < 30 MHz		
Frequency (MHz)	Field Strength (dBµV/m)	Measurement distance
0.009 – 0.490	2400/F(kHz)	300
0.490 – 1.705	24000/F(kHz)	30
1.705 – 30.0	30	30

Results:

Spurious Emissions Radiated < 30 MHz [dBµV/m]		
F [MHz]	Detector	Level [dBµV/m]
All detected peak emissions are below the average limit.		

Plots:

Plot 1: 9 kHz to 30 MHz, OFDM 20 MHz, 5180 MHz

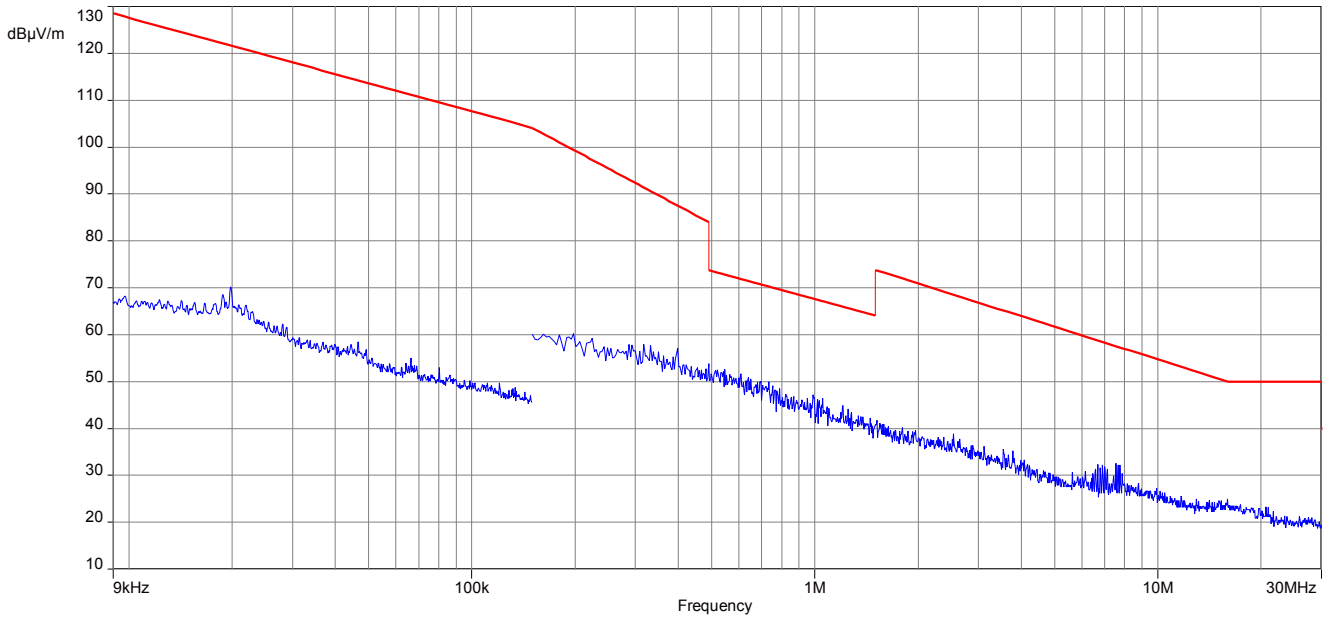

Plot 2: 9 kHz to 30 MHz, OFDM 20 MHz, 5200 MHz

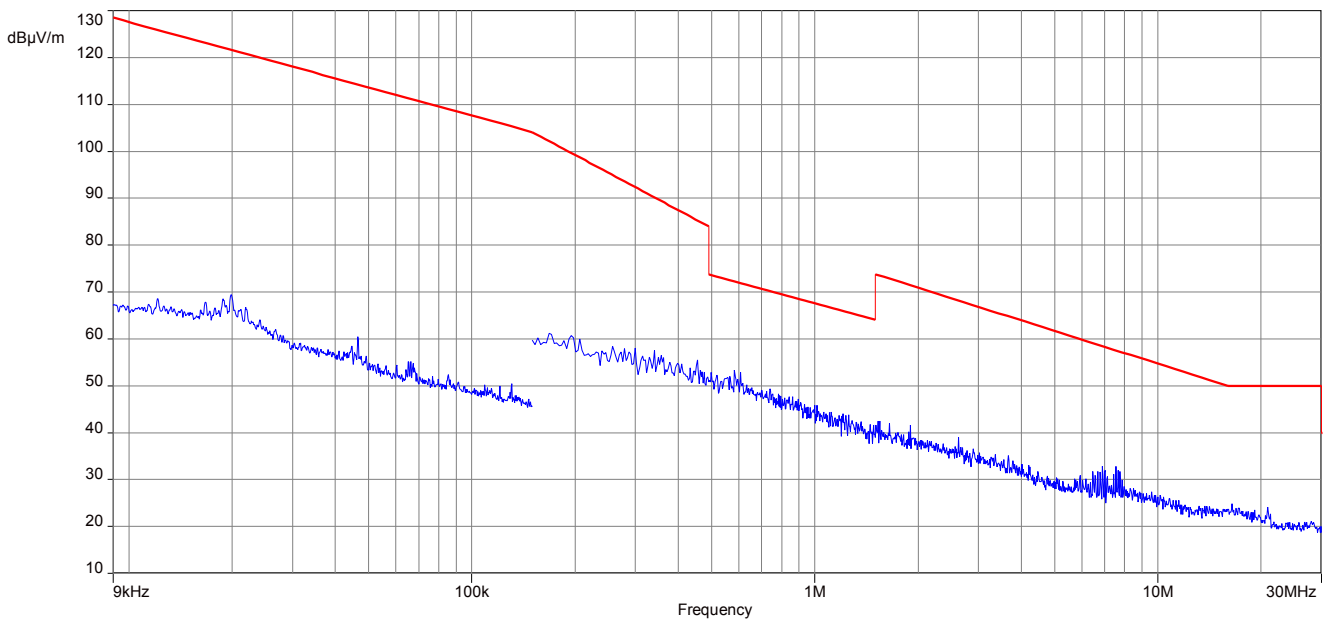

Plot 3: 9 kHz to 30 MHz, OFDM 20 MHz, 5240 MHz

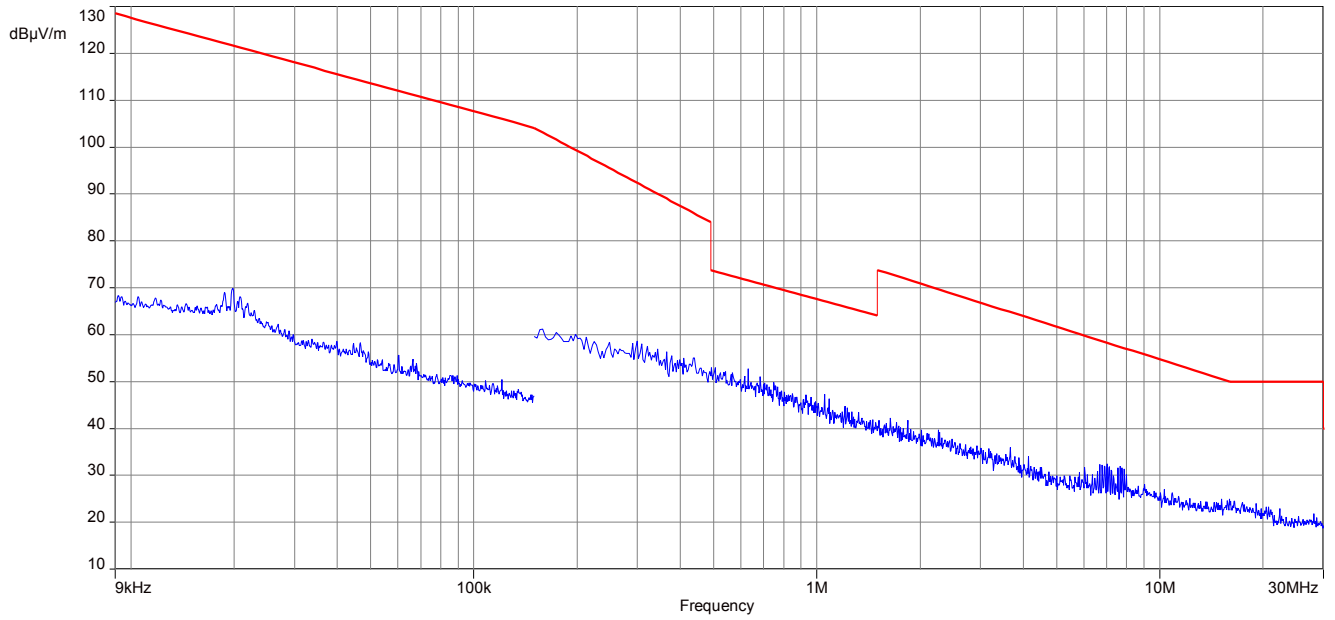

11.12 Spurious emissions conducted < 30 MHz

Description:

Measurement of the conducted spurious emissions in transmit mode below 30 MHz. The EUT is set to middle channel. If critical peaks are found the lowest channel and the highest channel will be measured too. Both power lines, phase and neutral line, are measured. Found peaks are re-measured with average and quasi peak detection to show compliance to the limits.

Measurement:

Measurement parameter	
Detector:	Peak - Quasi Peak / Average
Sweep time:	Auto
Video bandwidth:	9 kHz
Resolution bandwidth:	100 kHz
Span:	150 kHz to 30 MHz
Trace – mode:	Max Hold
Test setup:	See sub clause 6.4 A
Measurement uncertainty:	See sub clause 8

Limits:

Spurious Emissions Conducted < 30 MHz		
Frequency (MHz)	Quasi-Peak (dB μ V/m)	Average (dB μ V/m)
0.15 – 0.5	66 to 56*	56 to 46*
0.5 – 5	56	46
5 – 30.0	60	50

*Decreases with the logarithm of the frequency

Results:

Spurious Emissions Conducted < 30 MHz [dB μ V/m]		
F [MHz]	Detector	Level [dB μ V/m]
Please look at the table below the plots.		

Plots:

Plot 1: 150 kHz to 30 MHz, phase line

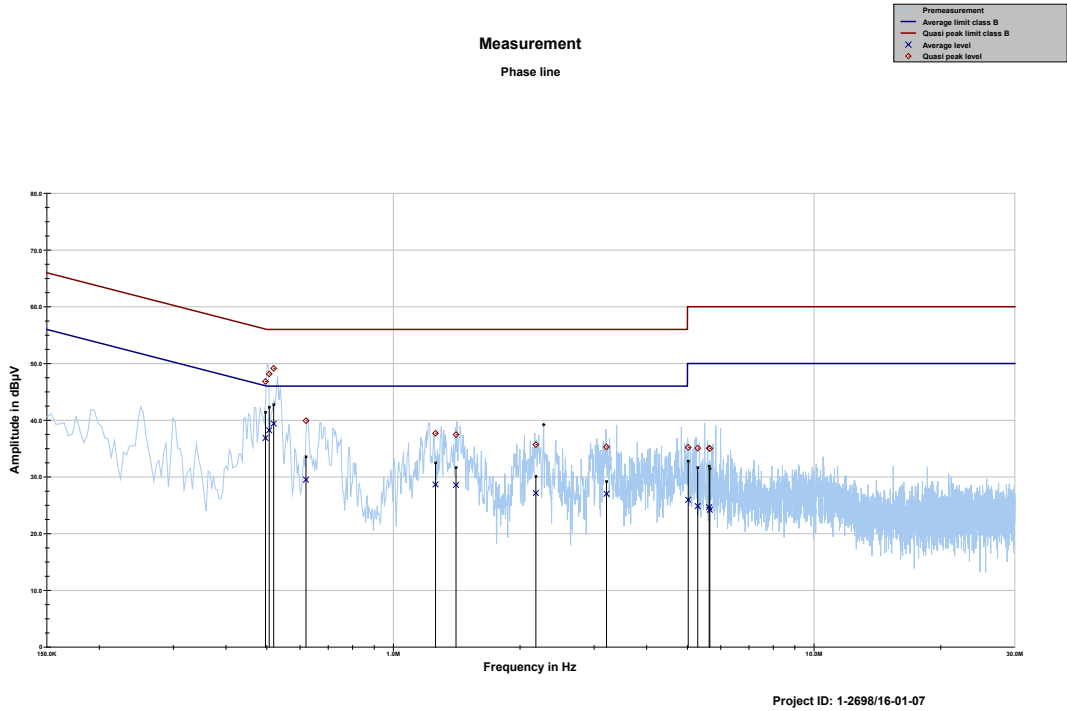

Frequency MHz	Quasi peak level dBµV	Margin quasi peak dB	Limit QP dBµV	Average level dBµV	Margin average dB	Limit AV dBµV
0.496600	46.83	9.23	56.057	36.86	9.23	46.097
0.506800	48.15	7.85	56.000	38.22	7.78	46.000
0.519145	49.15	6.85	56.000	39.41	6.59	46.000
0.619676	39.90	16.10	56.000	29.51	16.49	46.000
1.259152	37.70	18.30	56.000	28.68	17.32	46.000
1.409033	37.46	18.54	56.000	28.57	17.43	46.000
2.181163	35.70	20.30	56.000	27.15	18.85	46.000
3.211447	35.30	20.70	56.000	27.04	18.96	46.000
5.021331	35.21	24.79	60.000	25.97	24.03	50.000
5.288484	35.08	24.92	60.000	24.85	25.15	50.000
5.633079	35.07	24.93	60.000	24.66	25.34	50.000
5.653169	34.99	25.01	60.000	24.21	25.79	50.000

Plot 2: 150 kHz to 30 MHz, neutral line

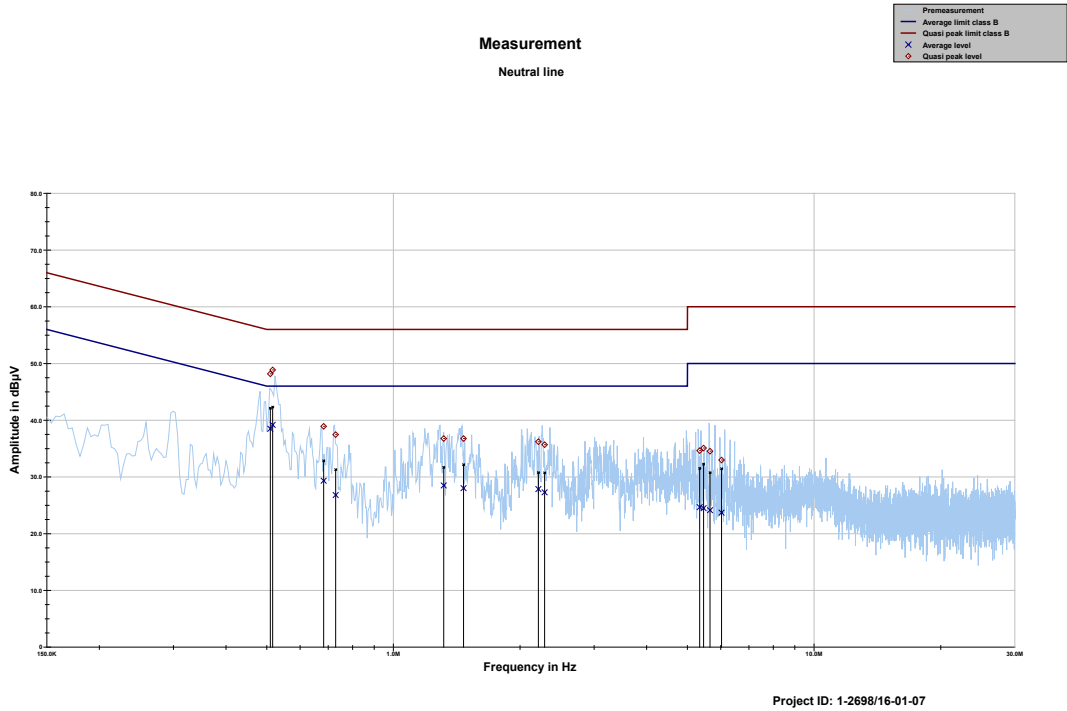

Frequency MHz	Quasi peak level dBµV	Margin quasi peak dB	Limit QP dBµV	Average level dBµV	Margin average dB	Limit AV dBµV
0.509885	48.17	7.83	56.000	38.49	7.51	46.000
0.516302	48.86	7.14	56.000	39.18	6.82	46.000
0.682556	38.92	17.08	56.000	29.33	16.67	46.000
0.729182	37.46	18.54	56.000	26.81	19.19	46.000
1.316882	36.77	19.23	56.000	28.49	17.51	46.000
1.468137	36.76	19.24	56.000	28.02	17.98	46.000
2.211775	36.21	19.79	56.000	27.85	18.15	46.000
2.288433	35.68	20.32	56.000	27.28	18.72	46.000
5.345631	34.64	25.36	60.000	24.67	25.33	50.000
5.462935	35.09	24.91	60.000	24.49	25.51	50.000
5.658933	34.53	25.47	60.000	24.13	25.87	50.000
6.026859	32.97	27.03	60.000	23.71	26.29	50.000

12 Observations

No observations except those reported with the single test cases have been made.

Annex A Document history

Version	Applied changes	Date of release
	Initial release	2017-02-09

Annex B Further information

Glossary

AVG	-	Average
DUT	-	Device under test
EMC	-	Electromagnetic Compatibility
EN	-	European Standard
EUT	-	Equipment under test
ETSI	-	European Telecommunications Standard Institute
FCC	-	Federal Communication Commission
FCC ID	-	Company Identifier at FCC
HW	-	Hardware
IC	-	Industry Canada
Inv. No.	-	Inventory number
N/A	-	Not applicable
PP	-	Positive peak
QP	-	Quasi peak
S/N	-	Serial number
SW	-	Software
PMN	-	Product marketing name
HMN	-	Host marketing name
HVIN	-	Hardware version identification number
FVIN	-	Firmware version identification number
OBW		Occupied Bandwidth
OC		Operating Channel
OCW		Operating Channel Bandwidth
OOB		Out Of Band

Annex C Accreditation Certificate

first page

last page



Deutsche Akkreditierungsstelle GmbH

Bellehene gemäß § 8 Absatz 1 AkkStelleG i.V.m. § 1 Absatz 1 AkkStelleGBV
 Unterzeichnerin der Multilateralen Abkommen
 von EA, ILAC und IAF zur gegenseitigen Anerkennung

Akkreditierung



Die Deutsche Akkreditierungsstelle GmbH bestätigt hiermit, dass das Prüflaboratorium

CTC advanced GmbH
 Untertürkheimer Straße 6-10, 66117 Saarbrücken

die Kompetenz nach DIN EN ISO/IEC 17025:2005 besitzt, Prüfungen in folgenden Bereichen durchzuführen:

- Funk**
- Mobilfunk (GSM / DCS) + OTA
- Elektromagnetische Verträglichkeit (EMV)
- Produktsicherheit
- SAR / EMF
- Umwelt
- Smart Card Technology
- Bluetooth*
- Automotive
- Wi-Fi-Services
- Kanadische Anforderungen
- US-Anforderungen
- Akustik
- Near Field Communication (NFC)

Die Akkreditierungsurkunde gilt nur in Verbindung mit dem Bescheid vom 25.11.2016 mit der Akkreditierungsnummer D-PL-12076-01 und ist gültig bis 17.01.2018. Sie besteht aus diesem Deckblatt, der Rückseite des Deckblatts und der folgenden Anlage mit insgesamt 63 Seiten.

Registrierungsnummer der Urkunde: D-PL-12076-01-01

Frankfurt, 25.11.2016

Siehe Hinweis auf der Rückseite

Im Auftrag Dipl.-Ing. Ralf Eigner
 Abteilungsleiter

Deutsche Akkreditierungsstelle GmbH

Standort Berlin
 Spittelmarkt 10
 10117 Berlin

Standort Frankfurt am Main
 Europa-Allee 52
 60327 Frankfurt am Main

Standort Braunschweig
 Bundesallee 100
 38116 Braunschweig

Die auszugsweise Veröffentlichung der Akkreditierungsurkunde bedarf der vorherigen schriftlichen Zustimmung der Deutsche Akkreditierungsstelle GmbH (DAkkS). Ausgenommen davon ist die separate Weiterverbreitung des Deckblatts durch die umseitig genannte Konformitätsbewertungsstelle in unveränderter Form.

Es darf nicht der Anschein erweckt werden, dass sich die Akkreditierung auch auf Bereiche erstreckt, die über den durch die DAkkS bestätigten Akkreditierungsbereich hinausgehen.

Die Akkreditierung erfolgte gemäß des Gesetzes über die Akkreditierungsstelle (AkkStelleG) vom 31. Juli 2009 (BGBl. I S. 2625) sowie der Verordnung (EG) Nr. 765/2008 des Europäischen Parlaments und des Rates vom 9. Juli 2008 über die Vorschriften für die Akkreditierung und Marktüberwachung im Zusammenhang mit der Vermarktung von Produkten (Abl. L 218 vom 9. Juli 2008, S. 30). Die DAkkS ist Unterzeichnerin der Multilateralen Abkommen zur gegenseitigen Anerkennung der European co-operation for Accreditation (EA), des International Accreditation Forum (IAF) und der International Laboratory Accreditation Cooperation (ILAC). Die Unterzeichner dieser Abkommen erkennen ihre Akkreditierungen gegenseitig an.

Der aktuelle Stand der Mitgliedschaft kann folgenden Webseiten entnommen werden:
 EA: www.european-accrreditation.org
 ILAC: www.ilac.org
 IAF: www.iaf.nu

Note:
 The current certificate including annex can be received on request.