

CETECOM ICT Services is now

CTC | advanced
member of RWTÜV group

TEST REPORT

Test report no.: 1-2698/16-01-07



Testing laboratory

CTC advanced GmbH

Untertuerkheimer Strasse 6 – 10

66117 Saarbruecken / Germany

Phone: + 49 681 5 98 - 0

Fax: + 49 681 5 98 - 9075

Internet: <http://www.ctcadvanced.com>

e-mail: mail@ctcadvanced.com

Accredited Testing Laboratory:

The testing laboratory (area of testing) is accredited according to DIN EN ISO/IEC 17025 (2005) by the Deutsche Akkreditierungsstelle GmbH (DAkkS)

The accreditation is valid for the scope of testing procedures as stated in the accreditation certificate with the registration number: D-PL-12076-01-01

Applicant

FLIR Systems AB

Antennvägen 6

187 66 Täby / SWEDEN

Phone: +46 87 53 25 00

Fax: +46 87 53 23 64

Contact: Göran Skedung

e-mail: goran.skedung@flir.se

Phone: +46 87 53 27 59

Manufacturer

FLIR Systems AB

Antennvägen 6

187 66 Täby / SWEDEN

Test standard/s

47 CFR Part 15	Title 47 of the Code of Federal Regulations; Chapter I; Part 15 - Radio frequency devices
RSS - 247 Issue 1	Digital Transmission Systems (DTSs), Frequency Hopping Systems (FHSs) and Licence - Exempt Local Area Network (LE-LAN) Devices
RSS - Gen Issue 4	Spectrum Management and Telecommunications Radio Standards Specifications - General Requirements and Information for the Certification of Radio Apparatus

For further applied test standards please refer to section 3 of this test report.

Test Item

Kind of test item:	Thermal imaging camera
Model name:	FLIR-E6390
FCC ID:	ZLV-FLIRE6390
IC:	5306A-FLIRE6390
Frequency:	DTS band 2400 MHz to 2483.5 MHz
Technology tested:	WLAN (b-mode, g-mode, n-HT20-mode)
Antenna:	Integrated PCB antenna
Power supply:	3.6 V DC by Li-ion battery
Temperature range:	-15°C to +50°C



This test report is electronically signed and valid without handwriting signature. For verification of the electronic signatures, the public keys can be requested at the testing laboratory.

Test report authorized:

Marco Bertolino
Lab Manager
Radio Communications & EMC

Test performed:

Andreas Luckenbill
Lab Manager
Radio Communications & EMC

1 Table of contents	
1	Table of contents 2
2	General information 3
2.1	Notes and disclaimer 3
2.2	Application details 3
2.3	Test laboratories sub-contracted 3
3	Test standard/s and references 4
4	Test environment 5
5	Test item 5
5.1	General description 5
5.2	Additional information 5
6	Description of the test setup 6
6.1	Shielded semi anechoic chamber 7
6.2	Shielded fully anechoic chamber 8
6.3	Radiated measurements > 18 GHz 9
6.4	AC conducted 10
6.5	Conducted measurements with peak power meter & spectrum analyzer 11
7	Sequence of testing 12
7.1	Sequence of testing radiated spurious 9 kHz to 30 MHz 12
7.2	Sequence of testing radiated spurious 30 MHz to 1 GHz 13
7.3	Sequence of testing radiated spurious 1 GHz to 18 GHz 14
7.4	Sequence of testing radiated spurious above 18 GHz 15
8	Measurement uncertainty 16
9	Summary of measurement results 17
10	Additional comments 18
11	Measurement results 19
11.1	Antenna gain 19
11.2	Identify worst case data rate 23
11.3	Maximum output power 24
11.4	Duty cycle 25
11.5	Peak power spectral density 31
11.6	6 dB DTS bandwidth 38
11.7	Occupied bandwidth – 99% emission bandwidth 45
11.8	Occupied bandwidth – 20 dB bandwidth 52
11.9	Band edge compliance conducted 59
11.10	Spurious emissions conducted 64
11.11	Spurious emissions radiated below 30 MHz 76
11.12	Spurious emissions radiated 30 MHz to 1 GHz 81
11.13	Spurious emissions radiated above 1 GHz 89
11.14	Spurious emissions conducted below 30 MHz (AC conducted) 98
12	Observations 101
Annex A	Document history 101
Annex B	Further information 101
Annex C	Accreditation Certificate 102

2 General information

2.1 Notes and disclaimer

The test results of this test report relate exclusively to the test item specified in this test report. CTC advanced GmbH does not assume responsibility for any conclusions and generalizations drawn from the test results with regard to other specimens or samples of the type of the equipment represented by the test item.

The test report may only be reproduced or published in full. Reproduction or publication of extracts from the report requires the prior written approval of CTC advanced GmbH.

The testing service provided by CTC advanced GmbH has been rendered under the current "General Terms and Conditions for CTC advanced GmbH".

CTC advanced GmbH will not be liable for any loss or damage resulting from false, inaccurate, inappropriate or incomplete product information provided by the customer.

Under no circumstances does the CTC advanced GmbH test report include any endorsement or warranty regarding the functionality, quality or performance of any other product or service provided.

Under no circumstances does the CTC advanced GmbH test report include or imply any product or service warranties from CTC advanced GmbH, including, without limitation, any implied warranties of merchantability, fitness for purpose, or non-infringement, all of which are expressly disclaimed by CTC advanced GmbH.

All rights and remedies regarding vendor's products and services for which CTC advanced GmbH has prepared this test report shall be provided by the party offering such products or services and not by CTC advanced GmbH. In no case this test report can be considered as a Letter of Approval.

This test report is electronically signed and valid without handwritten signature. For verification of the electronic signatures, the public keys can be requested at the testing laboratory.

2.2 Application details

Date of receipt of order:	2017-01-17
Date of receipt of test item:	2017-01-24
Start of test:	2017-01-24
End of test:	2017-01-27
Person(s) present during the test:	Mr. Göran Skedung

2.3 Test laboratories sub-contracted

None

3 Test standard/s and references

Test standard	Date	Description
47 CFR Part 15	-/-	Title 47 of the Code of Federal Regulations; Chapter I; Part 15 - Radio frequency devices
RSS - 247 Issue 1	May 2015	Digital Transmission Systems (DTSs), Frequency Hopping Systems (FHSs) and Licence - Exempt Local Area Network (LE-LAN) Devices
RSS - Gen Issue 4	November 2014	Spectrum Management and Telecommunications Radio Standards Specifications - General Requirements and Information for the Certification of Radio Apparatus

Guidance	Version	Description
DTS: KDB 558074 D01	v03r05	Guidance for Performing Compliance Measurements on Digital Transmission Systems (DTS) Operating Under §15.247
ANSI C63.4-2014	-/-	American national standard for methods of measurement of radio-noise emissions from low-voltage electrical and electronic equipment in the range of 9 kHz to 40 GHz
ANSI C63.10-2013	-/-	American national standard of procedures for compliance testing of unlicensed wireless devices

4 Test environment

Temperature	: T _{nom} T _{max} T _{min}	+23 °C during room temperature tests No tests under extreme conditions required. No tests under extreme conditions required.
Relative humidity content	:	35 %
Barometric pressure	:	1021 hpa
Power supply	: V _{nom} V _{max} V _{min}	3.6 V DC by Li-ion battery No tests under extreme conditions required. No tests under extreme conditions required.

5 Test item

5.1 General description

Kind of test item	:	Thermal imaging camera
Type identification	:	FLIR-E6390
HMN	:	-/-
PMN	:	E4, E5, E6, E8
HVIN	:	FLIR-E6390
FVIN	:	-/-
S/N serial number	:	Radiated unit: 63991217 Conducted unit: 63992115 Photos: 63992323
HW hardware status	:	1
SW software status	:	RF test mode
Frequency band	:	DTS band 2400 MHz to 2483.5 MHz (lowest channel 2412 MHz; highest channel 2462 MHz)
Type of radio transmission	:	DSSS, OFDM
Use of frequency spectrum	:	
Type of modulation	:	(D)BPSK, (D)QPSK, 16 – QAM, 64 – QAM
Number of channels	:	11
Antenna	:	Integrated PCB antenna
Power supply	:	3.6 V DC by Li-ion battery
Temperature range	:	-15°C to +50°C

5.2 Additional information

The content of the following annexes is defined in the QA. It may be that not all of the listed annexes are necessary for this report, thus some values in between may be missing.

Test setup- and EUT-photos are included in test report: 1-2698/16-01-01_AnnexA
 1-2698/16-01-01_AnnexB
 1-2698/16-01-01_AnnexD

6 Description of the test setup

Typically, the calibrations of the test apparatus are commissioned to and performed by an accredited calibration laboratory. The calibration intervals are determined in accordance with the DIN EN ISO/IEC 17025. In addition to the external calibrations, the laboratory executes comparison measurements with other calibrated test systems or effective verifications. Weekly chamber inspections and range calibrations are performed. Where possible, RF generating and signaling equipment as well as measuring receivers and analyzers are connected to an external high-precision 10 MHz reference (GPS-based or rubidium frequency standard).

In order to simplify the identification of the equipment used at some special tests, some items of test equipment and ancillaries can be provided with an identifier or number in the equipment list below (Lab/Item).

Agenda: Kind of Calibration

k	calibration / calibrated	EK	limited calibration
ne	not required (k, ev, izw, zw not required)	zw	cyclical maintenance (external cyclical maintenance)
ev	periodic self verification	izw	internal cyclical maintenance
Ve	long-term stability recognized	g	blocked for accredited testing
v/k!	Attention: extended calibration interval		
NK!	Attention: not calibrated	*)	next calibration ordered / currently in progress

6.1 Shielded semi anechoic chamber

The radiated measurements are performed in vertical and horizontal plane in the frequency range from 9 kHz to 1 GHz in semi-anechoic chambers. The EUT is positioned on a non-conductive support with a height of 0.80 m above a conductive ground plane that covers the whole chamber. The receiving antennas are confirmed with specifications ANSI C63. These antennas can be moved over the height range between 1.0 m and 4.0 m in order to search for maximum field strength emitted from EUT. The measurement distances between EUT and receiving antennas are indicated in the test setups for the various frequency ranges. For each measurement, the EUT is rotated in all three axes until the maximum field strength is received. The wanted and unwanted emissions are received by spectrum analyzers where the detector modes and resolution bandwidths over various frequency ranges are set according to requirement ANSI C63.

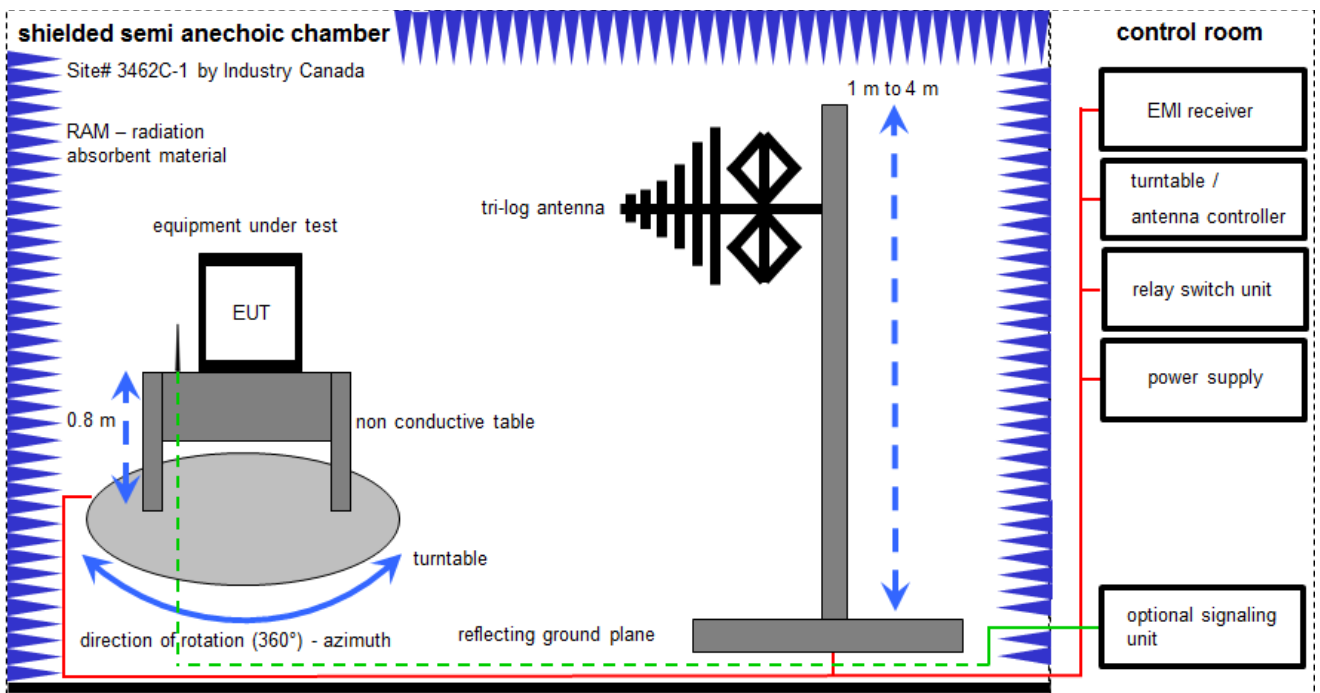

Measurement distance: tri-log antenna 10 meter

$$FS = UR + CL + AF$$

(FS-field strength; UR-voltage at the receiver; CL-loss of the cable; AF-antenna factor)

Example calculation:

$$FS [dB\mu V/m] = 12.35 [dB\mu V/m] + 1.90 [dB] + 16.80 [dB/m] = 31.05 [dB\mu V/m] (35.69 \mu V/m)$$

Equipment table:

No.	Lab / Item	Equipment	Type	Manufacturer	Serial No.	INV. No.	Kind of Calibration	Last Calibration	Next Calibration
1	A	Switch-Unit	3488A	HP	2719A14505	300000368	ev	-/-	-/-
2	A	EMI Test Receiver	ESCI 3	R&S	100083	300003312	k	08.03.2016	08.03.2017
3	A	Antenna Tower	Model 2175	ETS-Lindgren	64762	300003745	izw	-/-	-/-
4	A	Positioning Controller	Model 2090	ETS-Lindgren	64672	300003746	izw	-/-	-/-
5	A	Turntable Interface-Box	Model 105637	ETS-Lindgren	44583	300003747	izw	-/-	-/-
6	A	TRILOG Broadband Test-Antenna 30 MHz - 3 GHz	VULB9163	Schwarzbeck	295	300003787	k	25.04.2016	25.04.2018

6.2 Shielded fully anechoic chamber

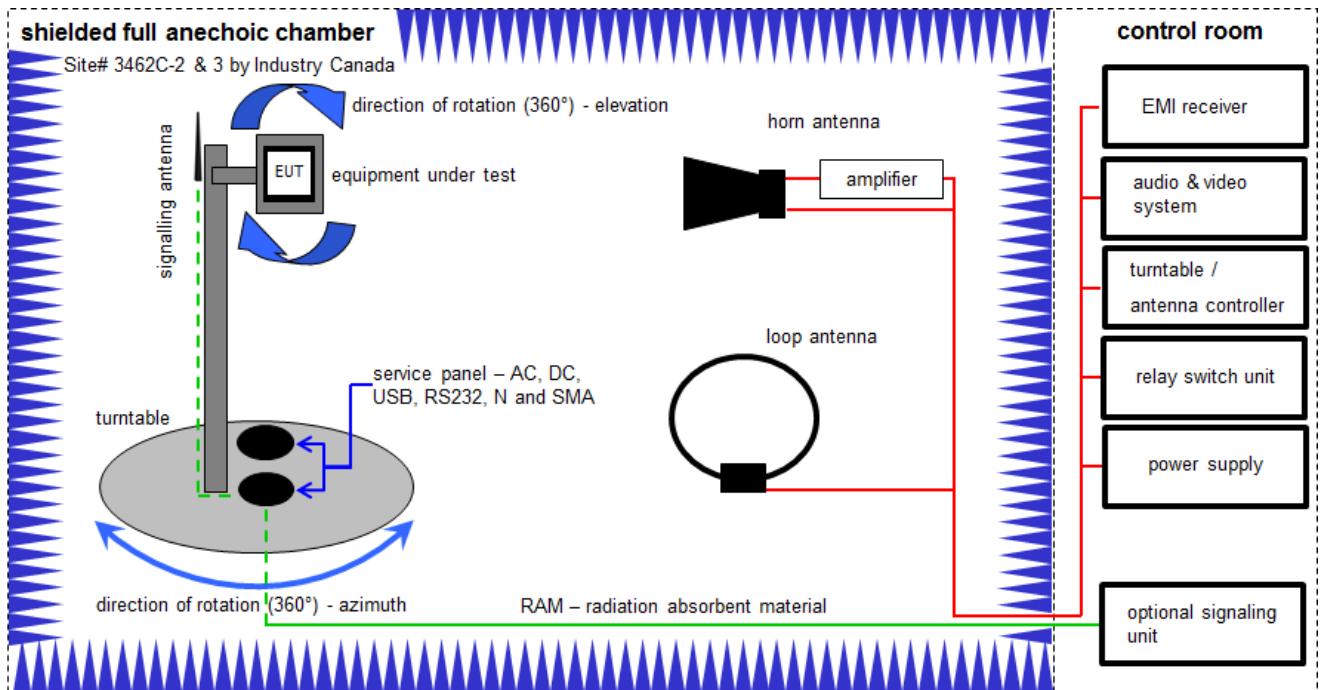

Measurement distance: tri-log antenna and horn antenna 3 meter & 1 meter; loop antenna 3 meter

$$FS = UR + CA + AF$$

(FS-field strength; UR-voltage at the receiver; CA-loss of the signal path; AF-antenna factor)

Example calculation:

$$FS [dB\mu V/m] = 40.0 [dB\mu V/m] + (-35.8) [dB] + 32.9 [dB/m] = 37.1 [dB\mu V/m] (71.61 \mu V/m)$$

Equipment table:

No.	Lab / Item	Equipment	Type	Manufacturer	Serial No.	INV. No.	Kind of Calibration	Last Calibration	Next Calibration
1	A	Active Loop Antenna 10 kHz to 30 MHz	6502	EMCO	2210	300001015	k	20.05.2015	20.05.2017
2	B	Double-Ridged Waveguide Horn Antenna 1-18.0GHz	3115	EMCO	9709-5290	300000212	k	13.08.2015	13.08.2017
3	A, B	EMI Test Receiver 20Hz- 26,5GHz	ESU26	R&S	100037	300003555	k	02.02.2016	02.02.2017
4	B	Highpass Filter	WHK1.1/15G-10SS	Wainwright	37	400000148	ne	-/-	-/-
5	B	Band Reject Filter	WRCG2400/2483- 2375/2505-50/10SS	Wainwright	26	300003792	ne	-/-	-/-
6	B	Broadband Amplifier 0.5-18 GHz	CBLU5184540	CERNEX	22050	300004482	ev	-/-	-/-
7	B	Broadband Amplifier 5-13 GHz	CBLU5135235	CERNEX	22011	300004492	ev	-/-	-/-
8	A, B	4U RF Switch Platform	L4491A	Agilent Technologies	MY50000032	300004510	ne	-/-	-/-
9	A, B	Messrechner und Monitor	Intel Core i3 3220/3,3 GHz, Prozessor	Agilent Technologies	2V2403033A54 21	300004591	ne	-/-	-/-
10	A, B	NEXIO EMV- Software	BAT EMC	EMCO	2V2403033A54 21	300004682	ne	-/-	-/-
11	A, B	Vollabsorberkammer	BAT EMC	TDK	2V2403033A54 21	300003726	ne	-/-	-/-

6.3 Radiated measurements > 18 GHz

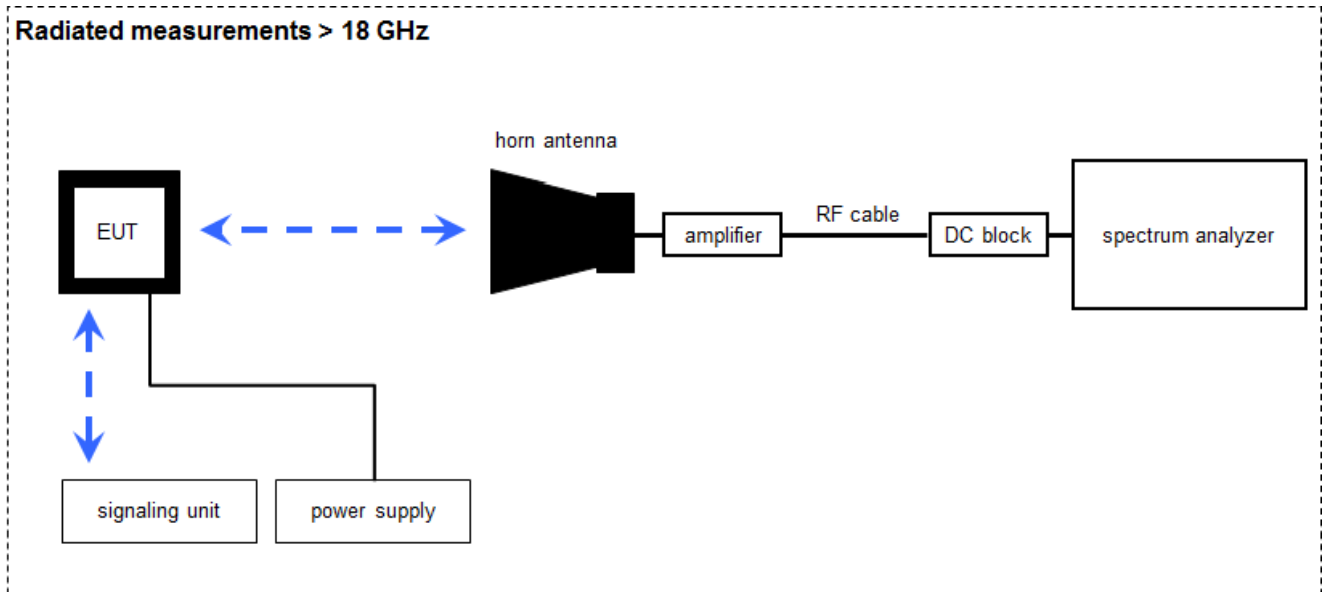

Measurement distance: horn antenna 50 cm

$$FS = U_R + CA + AF$$

(FS-field strength; U_R -voltage at the receiver; CA-loss signal path & distance correction; AF-antenna factor)

Example calculation:

$$FS [dB\mu V/m] = 40.0 [dB\mu V/m] + (-60.1) [dB] + 36.74 [dB/m] = 16.64 [dB\mu V/m] (6.79 \mu V/m)$$

Equipment table:

No.	Lab / Item	Equipment	Type	Manufacturer	Serial No.	INV. No.	Kind of Calibration	Last Calibration	Next Calibration
1	A	Amplifier 2-40 GHz	JS32-02004000-57-5P	MITEQ	1777200	300004541	ev	-/-	-/-
2	A	RF-Cable	ST18/SMAm/SMAm/48	Huber & Suhner	Batch no. 600918	400001182	ev	-/-	-/-
3	A	RF-Cable	ST18/SMAm/SMm/48	Huber & Suhner	Batch no. 127377	400001183	ev	-/-	-/-
4	A	DC-Blocker 0.1-40 GHz	8141A	Inmet	Batch no. 127377	400001185	ev	-/-	-/-
5	A	Std. Gain Horn Antenna 18.0 to 26.5 GHz	638	Narda	8402	300000486	k	10.09.2015	10.09.2017
6	A	Signal Analyzer 40 GHz	FSV40	R&S	101353	300004819	k	19.09.2016	19.09.2017

6.4 AC conducted

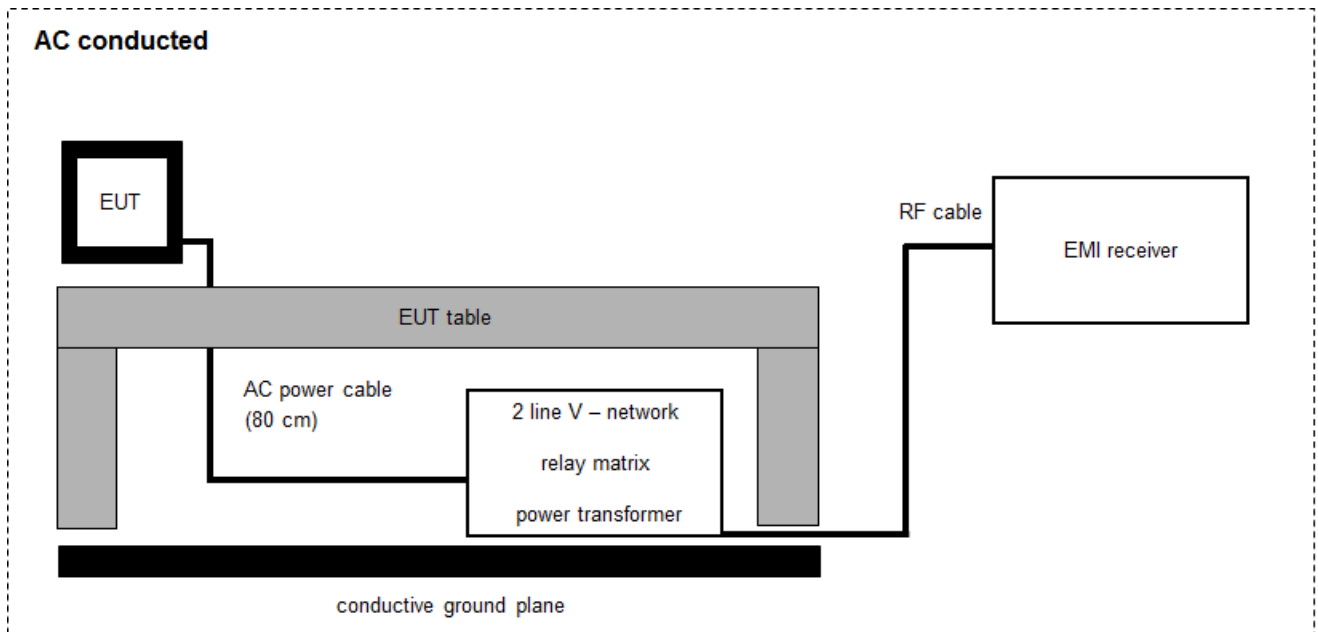

$$FS = UR + CF + VC$$

(FS-field strength; UR-voltage at the receiver; CR-loss of the cable and filter; VC-correction factor of the ISN)

Example calculation:

$$FS [dB\mu V/m] = 37.62 [dB\mu V/m] + 9.90 [dB] + 0.23 [dB] = 47.75 [dB\mu V/m] (244.06 \mu V/m)$$

Equipment table:

No.	Lab / Item	Equipment	Type	Manufacturer	Serial No.	INV. No.	Kind of Calibration	Last Calibration	Next Calibration
1	A	Two-line V-Network (LISN) 9 kHz to 30 MHz	ESH3-Z5	R&S	893045/004	300000584	k	02.02.2016	02.02.2017
2	A	RF-Filter-section	85420E	HP	3427A00162	300002214	k	27.11.2006	-/-
3	A	AC-Spannungsquelle variabel	MV2616-V	EM-Test	0397-12	300003259	k	11.12.2015	11.12.2017
4	A	Analyzer-Reference-System (Harmonics and Flicker)	ARS 16/1	SPS	A3509 07/0 0205	300003314	Ve	02.02.2016	02.02.2018
5	A	Hochpass 150 kHz	EZ-25	R&S	100010	300003798	ev	08.04.2008	-/-
6	A	Power Supply	NGSM 32/10	R&S	3939	400000192	vIK!	24.01.2017	24.01.2019
7	A	MXE EMI Receiver 20 Hz to 26,5 GHz	N9038A	Agilent Technologies	MY51210197	300004405	k	16.08.2016	16.08.2017

6.5 Conducted measurements with peak power meter & spectrum analyzer

Conducted measurements normal conditions

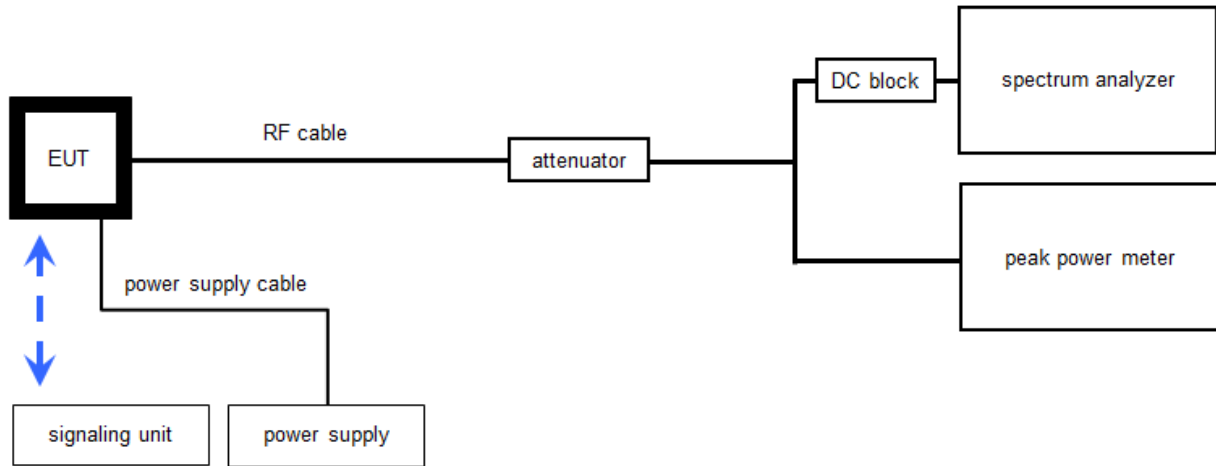

OP = AV + CA
 (OP-output power; AV-analyzer value; CA-loss signal path)

Example calculation:

OP [dBm] = 6.0 [dBm] + 11.7 [dB] = 17.7 [dBm] (58.88 mW)

Equipment table:

No.	Lab / Item	Equipment	Type	Manufacturer	Serial No.	INV. No.	Kind of Calibration	Last Calibration	Next Calibration
1	A, B	Switch / Control Unit	3488A	HP	2719A15013	300000151	ne	-/-	-/-
2	A, B	Hygro-Thermometer	-/, 5-45C, 20-100rF	HP	-/-	400000108	ev	07.09.2015	07.09.2017
3	A, B	Power Supply 0-20V, 0-5A	6632B	Agilent Technologies	GB42110541	400000562	vIK!	26.01.2016	26.01.2019
4	A, B	PC-WLAN Tester	Intel Core i3 3220/3,3 GHz, Prozessor	Agilent Technologies	2V2403033A45 23	300004589	ne	-/-	-/-
5	A, B	Teststand	Teststand Custom Sequence Editor	National Instruments GmbH	2V2403033A45 23	300004590	ne	-/-	-/-
6	B	Synchron Power Meter	SPM-4	CTC	1	400001294	ev	-/-	-/-
7	A, B	RF-Cable	ST18/SMAm/SMAm/60	Huber & Suhner	Batch no. 606844	400001181	ev	-/-	-/-
8	A	Coax Attenuator 10 dB 2W 0-40 GHz	MCL BW-K10-2W44+	Mini Circuits	Batch no. 606844	400001186	ev	-/-	-/-
9	A	Signal Analyzer 40 GHz	FSV40	R&S	101353	300004819	k	19.09.2016	19.09.2017
10	B	Power Sensor	NRP-Z81	R&S	100010	300003780	k	25.01.2016	25.01.2017

7 Sequence of testing

7.1 Sequence of testing radiated spurious 9 kHz to 30 MHz

Setup

- The equipment is set up to simulate normal operation mode as described in the user manual or defined by the manufacturer.
- If the EUT is a tabletop system, a 2-axis positioner with 1.5 m height is used.
- If the EUT is a floor standing device, it is placed directly on the turn table.
- Auxiliary equipment and cables are positioned to simulate normal operation conditions as described in ANSI C 63.4.
- The AC power port of the EUT (if available) is connected to a power outlet below the turntable.
- Measurement distance is 3 m (see ANSI C 63.4) – see test details.
- EUT is set into operation.

Premeasurement

- The turntable rotates from 0° to 315° using 45° steps.
- The antenna height is 1.5 m.
- At each turntable position the analyzer sweeps with positive-peak detector to find the maximum of all emissions.

Final measurement

- Identified emissions during the premeasurement are maximized by the software by rotating the turntable from 0° to 360°. In case of the 2-axis positioner is used the elevation axis is also rotated from 0° to 360°.
- The final measurement is done in the position (turntable and elevation) causing the highest emissions with quasi-peak (as described in ANSI C 63.4).
- Final levels, frequency, measuring time, bandwidth, turntable position, correction factor, margin to the limit and limit will be recorded. A plot with the graph of the premeasurement and the limit is stored.

7.2 Sequence of testing radiated spurious 30 MHz to 1 GHz

Setup

- The equipment is set up to simulate normal operation mode as described in the user manual or defined by the manufacturer.
- If the EUT is a tabletop system, a table with 0.8 m height is used, which is placed on the ground plane.
- If the EUT is a floor standing device, it is placed on the ground plane with insulation between both.
- Auxiliary equipment and cables are positioned to simulate normal operation conditions as described in ANSI C 63.4.
- The AC power port of the EUT (if available) is connected to a power outlet below the turntable.
- Measurement distance is 10 m or 3 m (see ANSI C 63.4) – see test details.
- EUT is set into operation.

Premeasurement

- The turntable rotates from 0° to 315° using 45° steps.
- The antenna is polarized vertical and horizontal.
- The antenna height changes from 1 m to 3 m.
- At each turntable position, antenna polarization and height the analyzer sweeps three times in peak to find the maximum of all emissions.

Final measurement

- The final measurement is performed for at least six highest peaks according to the requirements of the ANSI C63.4.
- Based on antenna and turntable positions at which the peak values are measured the software maximize the peaks by changing turntable position $\pm 45^\circ$ and antenna height between 1 and 4 m.
- The final measurement is done with quasi-peak detector (as described in ANSI C 63.4).
- Final levels, frequency, measuring time, bandwidth, antenna height, antenna polarization, turntable angle, correction factor, margin to the limit and limit are recorded. A plot with the graph of the premeasurement with marked maximum final results and the limit is stored.

7.3 Sequence of testing radiated spurious 1 GHz to 18 GHz

Setup

- The equipment is set up to simulate normal operation mode as described in the user manual or defined by the manufacturer.
- If the EUT is a tabletop system, a 2-axis positioner with 1.5 m height is used.
- If the EUT is a floor standing device, it is placed directly on the turn table.
- Auxiliary equipment and cables are positioned to simulate normal operation conditions as described in ANSI C 63.4.
- The AC power port of the EUT (if available) is connected to a power outlet below the turntable.
- Measurement distance is 3 m (see ANSI C 63.4) – see test details.
- EUT is set into operation.

Premeasurement

- The turntable rotates from 0° to 315° using 45° steps.
- The antenna is polarized vertical and horizontal.
- The antenna height is 1.5 m.
- At each turntable position and antenna polarization the analyzer sweeps with positive peak detector to find the maximum of all emissions.

Final measurement

- The final measurement is performed for at least six highest peaks according to the requirements of the ANSI C63.4.
- Based on antenna and turntable positions at which the peak values are measured the software maximizes the peaks by rotating the turntable from 0° to 360°. This measurement is repeated for different EUT-table positions (0° to 150° in 30°-steps) and for both antenna polarizations.
- The final measurement is done in the position (turntable, EUT-table and antenna polarization) causing the highest emissions with Peak and RMS detector (as described in ANSI C 63.4).
- Final levels, frequency, measuring time, bandwidth, turntable position, EUT-table position, antenna polarization, correction factor, margin to the limit and limit are recorded. A plot with the graph of the premeasurement with marked maximum final results and the limit is stored.

7.4 Sequence of testing radiated spurious above 18 GHz

Setup

- The equipment is set up to simulate normal operation mode as described in the user manual or defined by the manufacturer.
- Auxiliary equipment and cables are positioned to simulate normal operation conditions as described in ANSI C 63.4.
- The AC power port of the EUT (if available) is connected to a power outlet.
- The measurement distance is as appropriate (e.g. 0.5 m).
- The EUT is set into operation.

Premeasurement

- The test antenna is handheld and moved carefully over the EUT to cover the EUT's whole sphere and different polarizations of the antenna.

Final measurement

- The final measurement is performed at the position and antenna orientation causing the highest emissions with Peak and RMS detector (as described in ANSI C 63.4).
- Final levels, frequency, measuring time, bandwidth, correction factor, margin to the limit and limit are recorded. A plot with the graph of the premeasurement and the limit is stored.

8 Measurement uncertainty

Measurement uncertainty	
Test case	Uncertainty
Antenna gain	± 3 dB
Power spectral density	± 1.5 dB
DTS bandwidth	± 100 kHz (depends on the used RBW)
Occupied bandwidth	± 100 kHz (depends on the used RBW)
Maximum output power	± 1.5 dB
Detailed spurious emissions @ the band edge - conducted	± 1.5 dB
Band edge compliance radiated	± 3 dB
Spurious emissions conducted	± 3 dB
Spurious emissions radiated below 30 MHz	± 3 dB
Spurious emissions radiated 30 MHz to 1 GHz	± 3 dB
Spurious emissions radiated 1 GHz to 12.75 GHz	± 3.7 dB
Spurious emissions radiated above 12.75 GHz	± 4.5 dB
Spurious emissions conducted below 30 MHz (AC conducted)	± 2.6 dB

9 Summary of measurement results

<input checked="" type="checkbox"/>	No deviations from the technical specifications were ascertained
<input type="checkbox"/>	There were deviations from the technical specifications ascertained
<input type="checkbox"/>	This test report is only a partial test report. The content and verdict of the performed test cases are listed below.

TC Identifier	Description	Verdict	Date	Remark
RF-Testing	CFR Part 15 RSS - 247, Issue 1	See table!	2017-02-09	-/-

Test specification clause	Test case	Guideline	Temperature conditions	Power source voltages	Mode	C	NC	NA	NP	Remark
§15.247(b)(4) RSS - 247 / 5.4 (4)	Antenna gain	-/-	Nominal	Nominal	DSSS					-/-
RSS - 247 / 6.0	Duty cycle	-/-	Nominal	Nominal	DSSS OFDM					-/-
§15.247(e) RSS - 247 / 5.2 (2)	Power spectral density	KDB 558074 DTS clause: 10.2	Nominal	Nominal	DSSS OFDM	<input checked="" type="checkbox"/>	<input type="checkbox"/>	<input type="checkbox"/>	<input type="checkbox"/>	-/-
§15.247(a)(2) RSS - 247 / 5.2 (1)	DTS bandwidth	KDB 558074 DTS clause: 8.1	Nominal	Nominal	DSSS OFDM	<input checked="" type="checkbox"/>	<input type="checkbox"/>	<input type="checkbox"/>	<input type="checkbox"/>	-/-
RSS Gen clause 4.6.1	Occupied bandwidth	-/-	Nominal	Nominal	DSSS OFDM	<input checked="" type="checkbox"/>	<input type="checkbox"/>	<input type="checkbox"/>	<input type="checkbox"/>	-/-
§15.247(b)(3) RSS - 247 / 5.4 (4)	Maximum output power	KDB 558074 DTS clause: 9.1.2	Nominal	Nominal	DSSS OFDM	<input checked="" type="checkbox"/>	<input type="checkbox"/>	<input type="checkbox"/>	<input type="checkbox"/>	-/-
§15.247(d) RSS - 247 / 5.5	Detailed spurious emissions @ the band edge - conducted	-/-	Nominal	Nominal	DSSS OFDM	<input checked="" type="checkbox"/>	<input type="checkbox"/>	<input type="checkbox"/>	<input type="checkbox"/>	-/-
§15.205 RSS - 247 / 5.5 RSS - Gen	Band edge compliance conducted and radiated	KDB 558074 DTS clause: 13.3.2 and clause 12.2.2	Nominal	Nominal	DSSS OFDM	<input checked="" type="checkbox"/>	<input type="checkbox"/>	<input type="checkbox"/>	<input type="checkbox"/>	-/-
§15.247(d) RSS - 247 / 5.5	TX spurious emissions conducted	KDB 558074 DTS clause: 11.1 & 11.2 11.3	Nominal	Nominal	DSSS OFDM	<input checked="" type="checkbox"/>	<input type="checkbox"/>	<input type="checkbox"/>	<input type="checkbox"/>	-/-
§15.209(a) RSS-Gen	TX spurious emissions radiated below 30 MHz	-/-	Nominal	Nominal	DSSS OFDM	<input checked="" type="checkbox"/>	<input type="checkbox"/>	<input type="checkbox"/>	<input type="checkbox"/>	-/-
§15.247(d) RSS - 247 / 5.5 RSS-Gen	TX spurious emissions radiated 30 MHz to 1 GHz	-/-	Nominal	Nominal	DSSS OFDM	<input checked="" type="checkbox"/>	<input type="checkbox"/>	<input type="checkbox"/>	<input type="checkbox"/>	-/-
§15.247(d) RSS - 247 / 5.5 RSS-Gen	TX spurious emissions radiated above 1 GHz	-/-	Nominal	Nominal	DSSS OFDM	<input checked="" type="checkbox"/>	<input type="checkbox"/>	<input type="checkbox"/>	<input type="checkbox"/>	-/-
§15.109 RSS-Gen	RX spurious emissions radiated 30 MHz to 1 GHz	-/-	Nominal	Nominal	RX / idle	<input checked="" type="checkbox"/>	<input type="checkbox"/>	<input type="checkbox"/>	<input type="checkbox"/>	-/-
§15.109 RSS-Gen	RX spurious emissions radiated above 1 GHz	-/-	Nominal	Nominal	RX / idle	<input checked="" type="checkbox"/>	<input type="checkbox"/>	<input type="checkbox"/>	<input type="checkbox"/>	-/-
§15.107(a) §15.207	Conducted emissions < 30 MHz	-/-	Nominal	Nominal	DSSS OFDM	<input checked="" type="checkbox"/>	<input type="checkbox"/>	<input type="checkbox"/>	<input type="checkbox"/>	-/-

Note: C = Compliant; NC = Not compliant; NA = Not applicable; NP = Not performed

10 Additional comments

- Reference documents: 3-3-TECH-587 930-02 Flir Astra antenna characterization A
- Customer Questionnaire FLIR E8
- CONN-GUIDE-LRU (RF test mode commands)
- Special test descriptions: None
- Configuration descriptions: None
- Test mode: No test mode available.
 Iperf was used to ping another device with the largest support packet size
- Special software is used.
 EUT is transmitting pseudo random data by itself
- Antennas and transmit
operating modes: Operating mode 1 (single antenna)
- *Equipment with 1 antenna,*
- *Equipment with 2 diversity antennas operating in switched diversity mode by which at any moment in time only 1 antenna is used,*
- *Smart antenna system with 2 or more transmit/receive chains, but operating in a mode where only 1 transmit/receive chain is used)*
- Operating mode 2 (multiple antennas, no beamforming)
- *Equipment operating in this mode contains a smart antenna system using two or more transmit/receive chains simultaneously but without beamforming.*
- Operating mode 3 (multiple antennas, with beamforming)
- *Equipment operating in this mode contains a smart antenna system using two or more transmit/receive chains simultaneously with beamforming.
In addition to the antenna assembly gain (G), the beamforming gain (Y) may have to be taken into account when performing the measurements.*

11 Measurement results

11.1 Antenna gain

Limits:

FCC	IC
6 dBi / > 6 dBi output power and power density reduction required	

Results:

T _{nom}	V _{nom}	DTS band 2400 MHz to 2483.5 MHz
Gain [dBi] Declared by the customer!*		-2.0

*see reference document: 3-3-TECH-587 930-02 Flir Astra antenna characterization A

3 Summary

The WiFi antenna within the *Flir ASTRA* thermal camera has been characterized.
 The maximum antenna gain has been measured to be -2,0 dBi for the 2.5GHz band and 1,1 dBi for the 5GHz band.

Plots:

Plot 1:

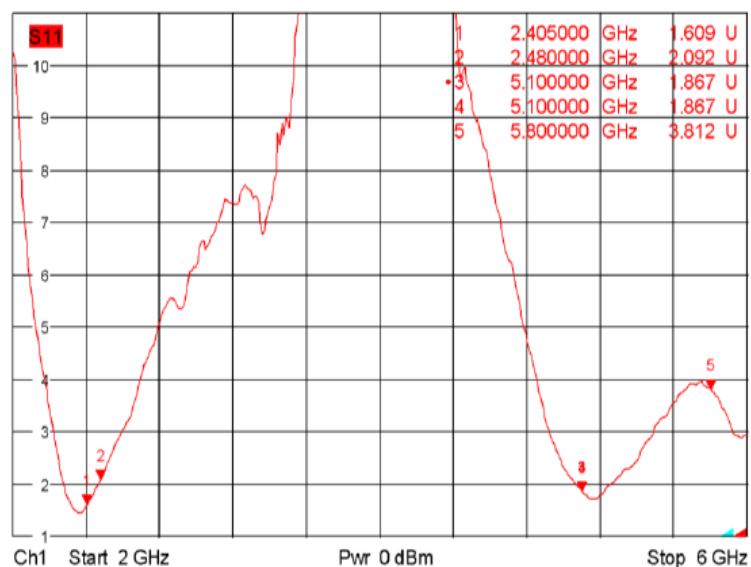

Figure 2 VSWR Flir ASTRA

Plot 2:

2.3.2 XY-plane

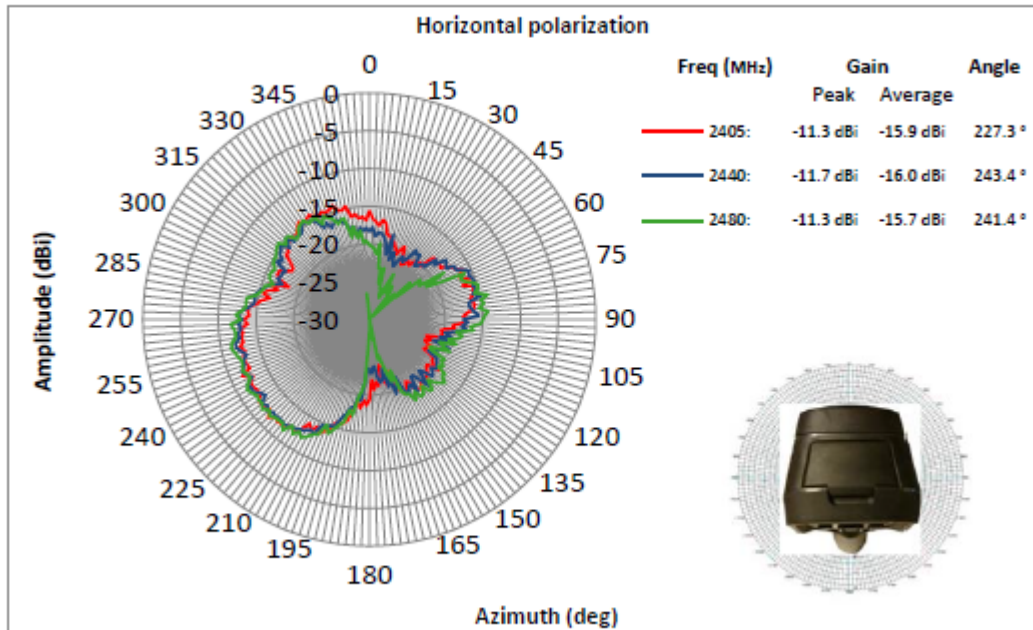

Figure 8 2,5GHz XY-plane, horizontal polarization

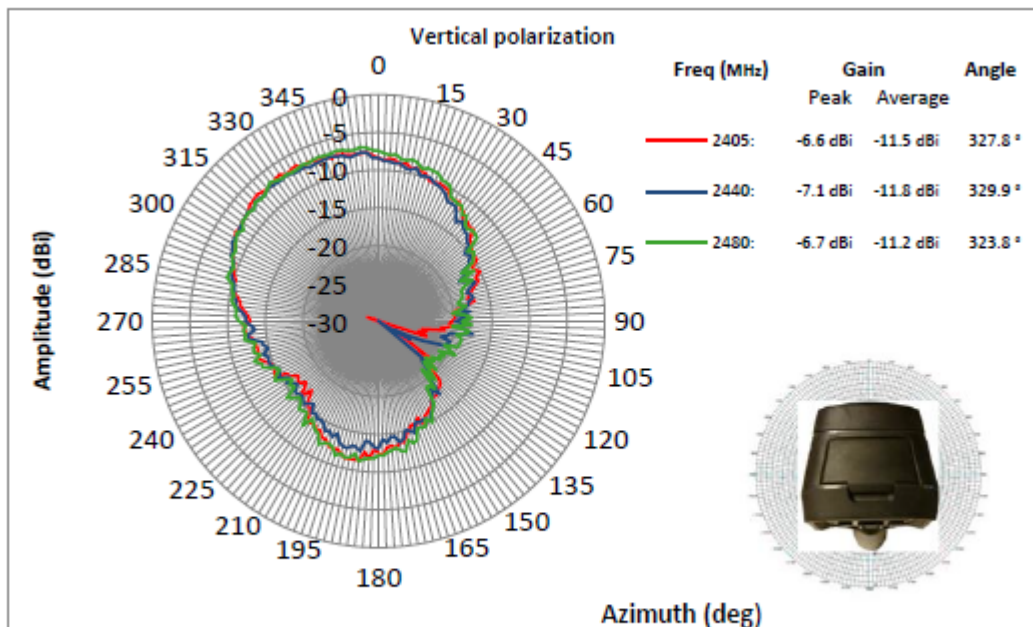

Figure 9 2,5GHz XY-plane, vertical polarization

Plot 3:

2.3.3 XZ-plane

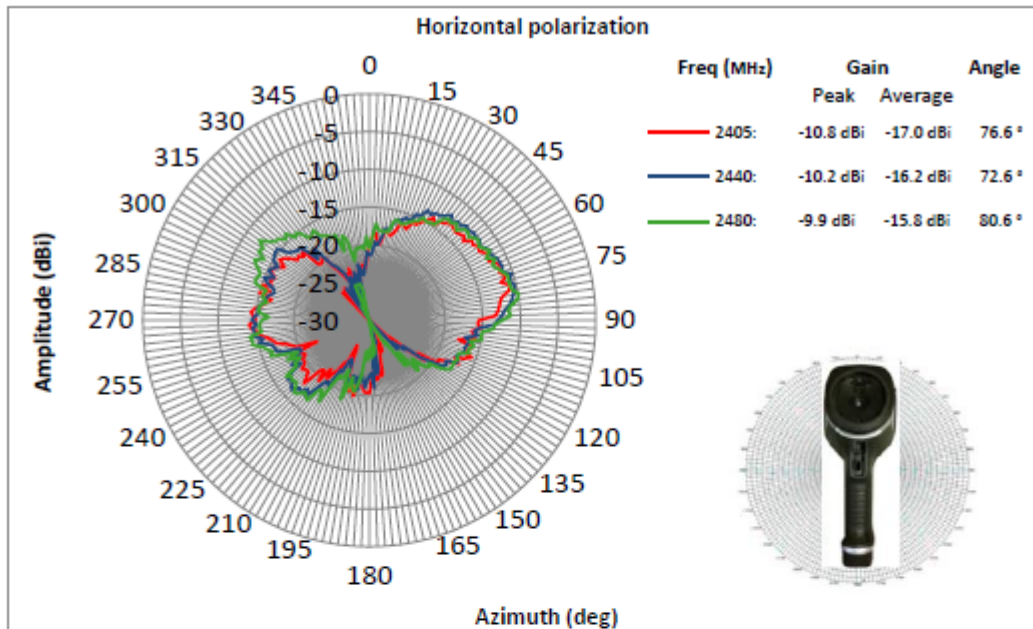

Figure 12 2,5GHz XZ-plane, horizontal polarization

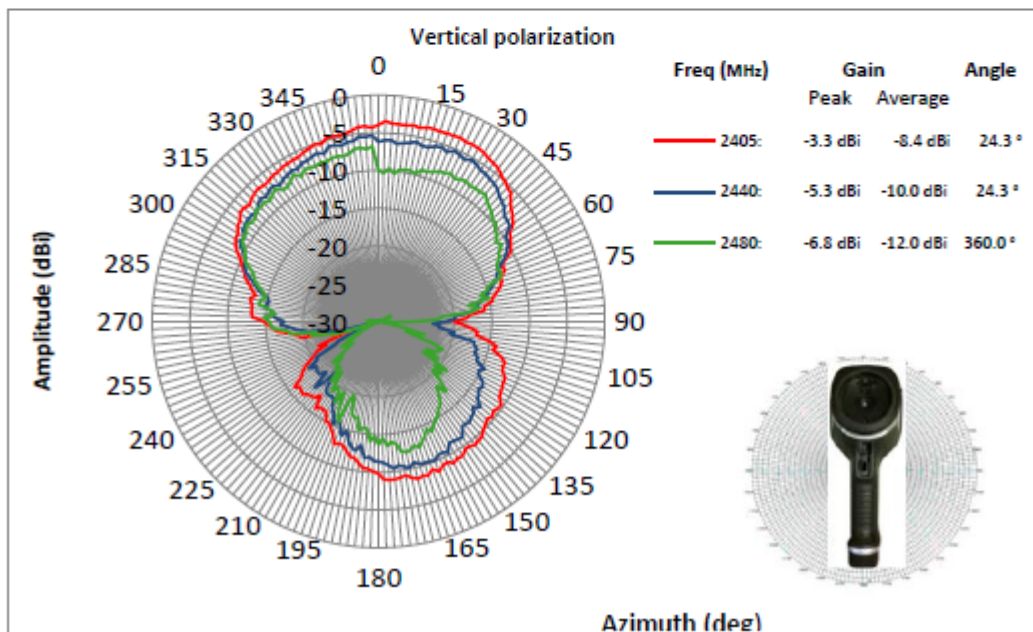

Figure 13 2,5GHz XZ-plane, vertical polarization

Plot 4:

2.3.4 YZ-plane

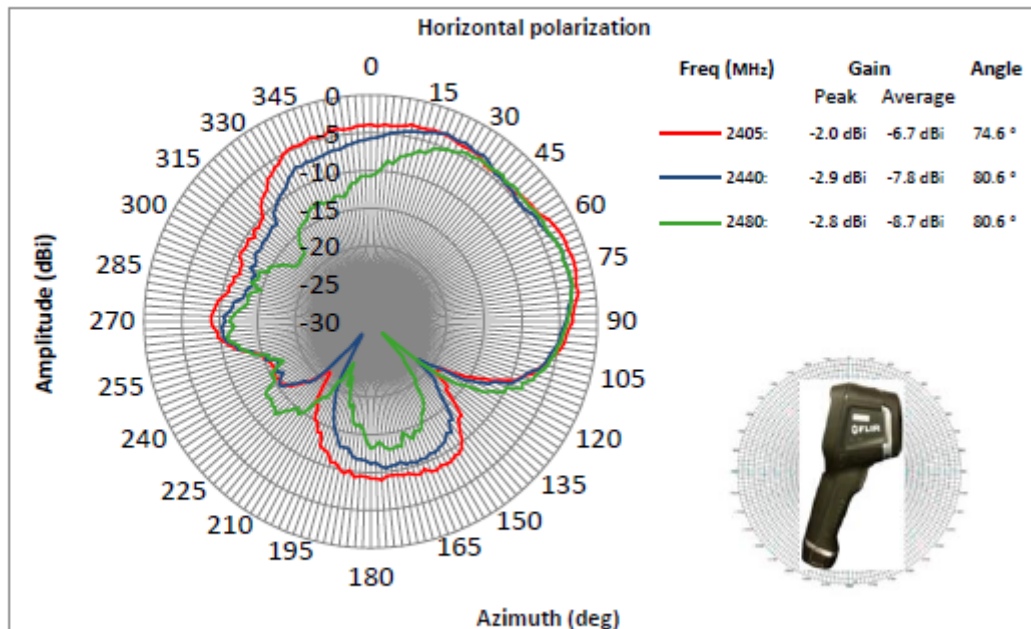

Figure 16 2,5GHz YZ-plane, horizontal polarization

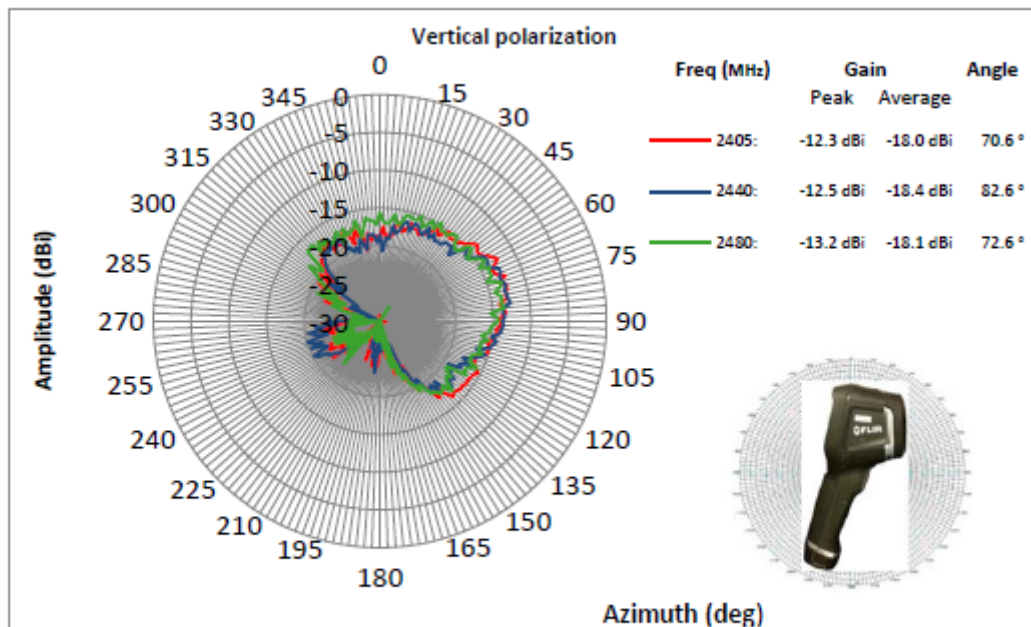

Figure 17 2,5GHz YZ-plane, vertical polarization

11.2 Identify worst case data rate

Measurement:

All modes of the module will be measured with an average power meter or spectrum analyzer to identify the maximum transmission power.

In further tests only the identified worst case modulation scheme or bandwidth will be measured and this mode is used as representative mode for all other modulation schemes.

Additional the band edge compliance test will be performed in the lowest and highest modulation scheme.

Measurement parameters:

Measurement parameter	
Detector:	Peak
Sweep time:	Auto
Resolution bandwidth:	3 MHz
Video bandwidth:	3 MHz
Trace mode:	Max hold
Test setup:	See sub clause 6.5 A
Measurement uncertainty:	-/-

Results:

Modulation	Modulation scheme / bandwidth
DSSS / b – mode	1 Mbit/s
OFDM / g – mode	6 Mbit/s
OFDM / n HT20 – mode	MCS0

11.3 Maximum output power

Description:

Measurement of the maximum output power conducted and radiated. The measurements are performed using the data rate producing the highest conducted output power.

Measurement:

Measurement parameter	
According to DTS clause: 9.1.2	
Peak power meter	
Test setup:	See sub clause 6.5 B
Measurement uncertainty	See sub clause 8

Limits:

FCC	IC
Conducted: 1.0 W – Antenna gain with max. 6 dBi	

Results:

Frequency	Maximum Output Power [dBm]		
	2412 MHz	2437 MHz	2462 MHz
Output power conducted DSSS / b – mode	17.9	18.7	18.1
Output power conducted OFDM / g – mode	23.6	23.4	23.0
Output power conducted OFDM / n HT20 – mode	23.6	23.2	23.1

11.4 Duty cycle

Measurement:

Measurement parameters:

Measurement parameter	
Detector:	Peak
Sweep time:	Depends on the signal see plot
Resolution bandwidth:	10 MHz
Video bandwidth:	10 MHz
Trace mode:	Max hold
Test setup:	See sub clause 6.5 A
Measurement uncertainty:	See sub clause 8

Limits:

FCC	IC
-/-	

Results:

T_{nom}	V_{nom}	lowest channel 2412 MHz	middle channel 2437 MHz	highest channel 2462 MHz
DSSS / b – mode		100 % / 0.00 dB	100 % / 0.00 dB	100 % / 0.00 dB
OFDM / g – mode		98.80 % / 0.05 dB	98.80 % / 0.05 dB	98.80 % / 0.05 dB
OFDM / n HT20 – mode		98.50 % / 0.07 dB	98.49 % / 0.07 dB	98.50 % / 0.07 dB

Plots: DSSS / b – mode

Plot 1: Lowest channel

100 %

Plot 2: Middle channel

100 %

Plot 3: Highest channel

100 %

Plots: OFDM / g – mode

Plot 1: Lowest channel

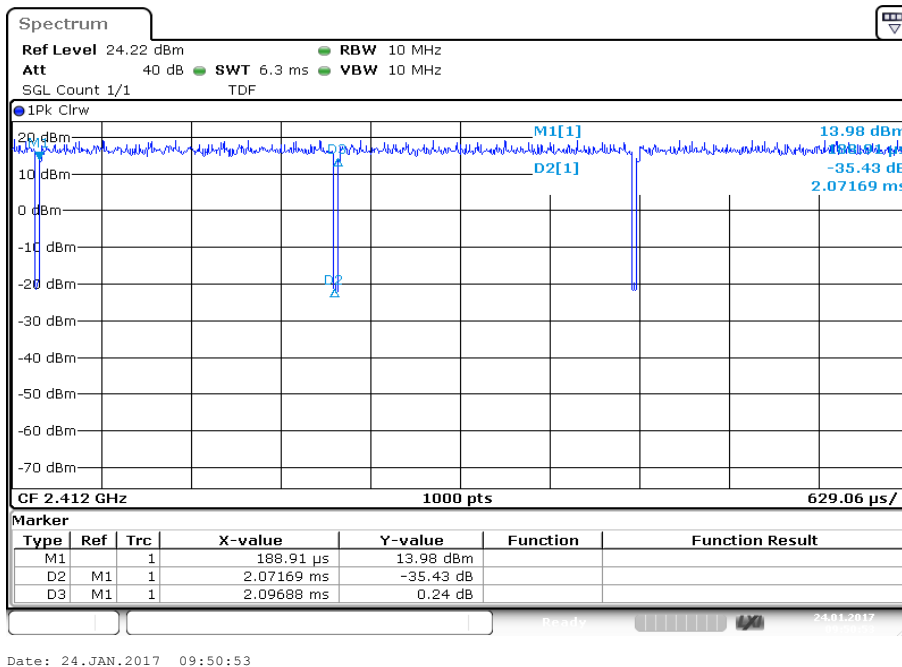

Plot 2: Middle channel

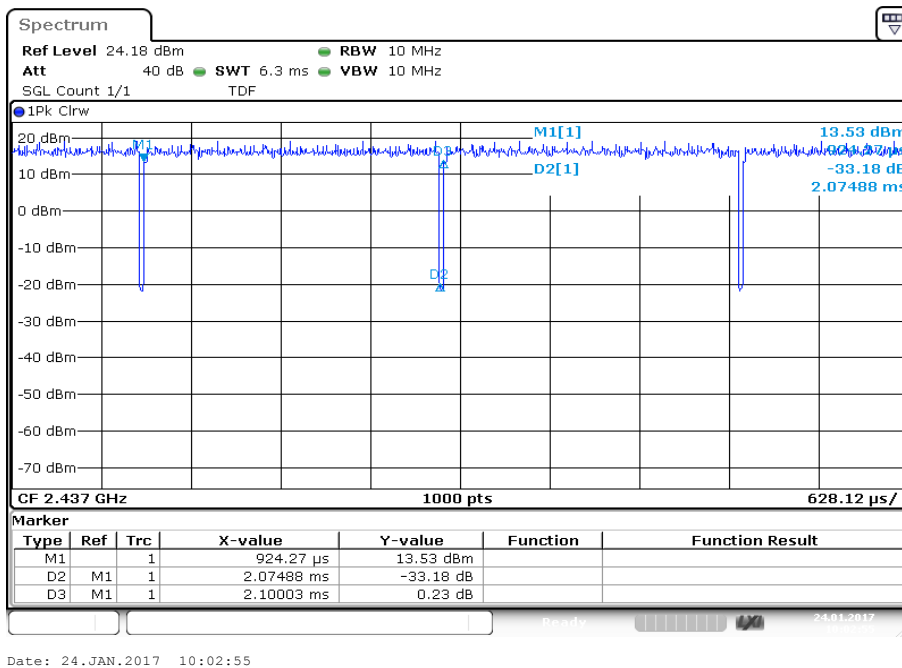

Plot 3: Highest channel

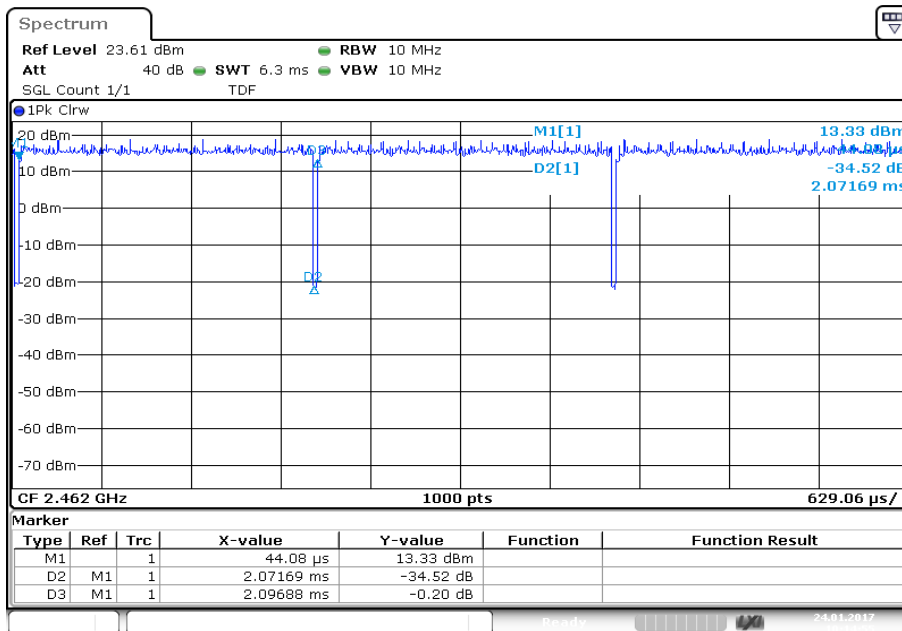

Date: 24.JAN.2017 10:14:56

Plots: OFDM / n HT20 – mode

Plot 1: Lowest channel

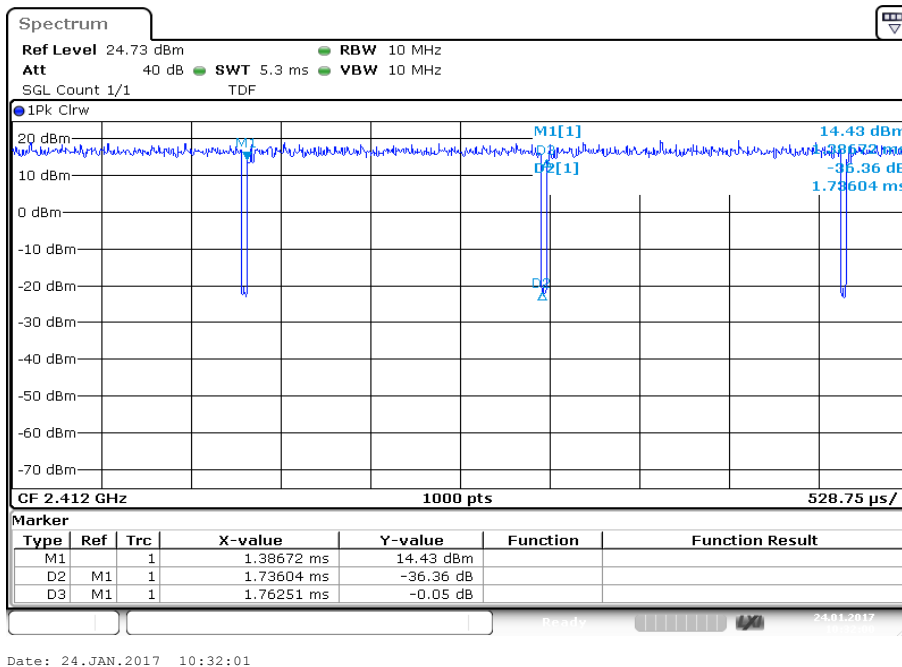

Plot 2: Middle channel

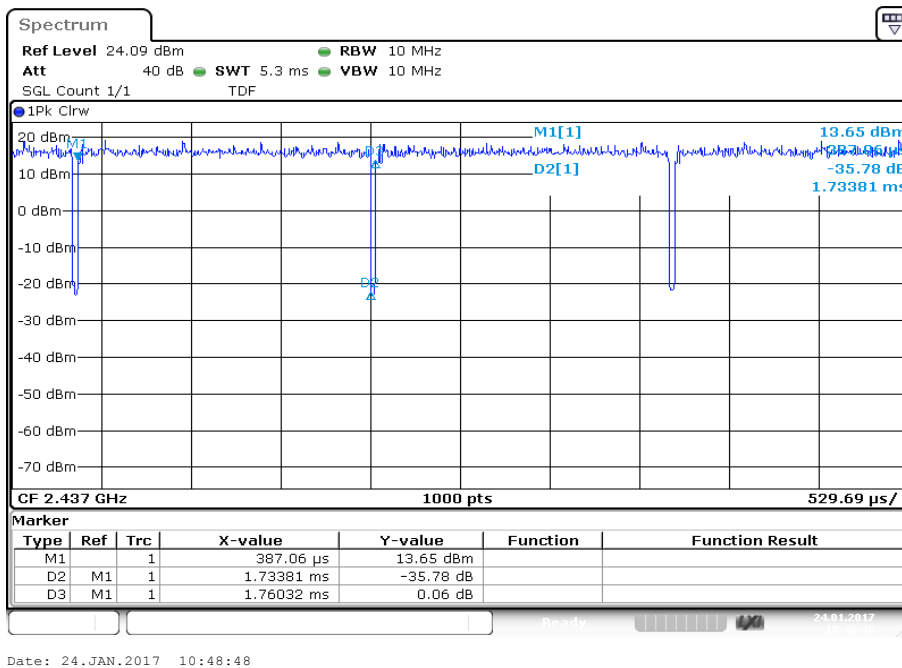

Plot 3: Highest channel

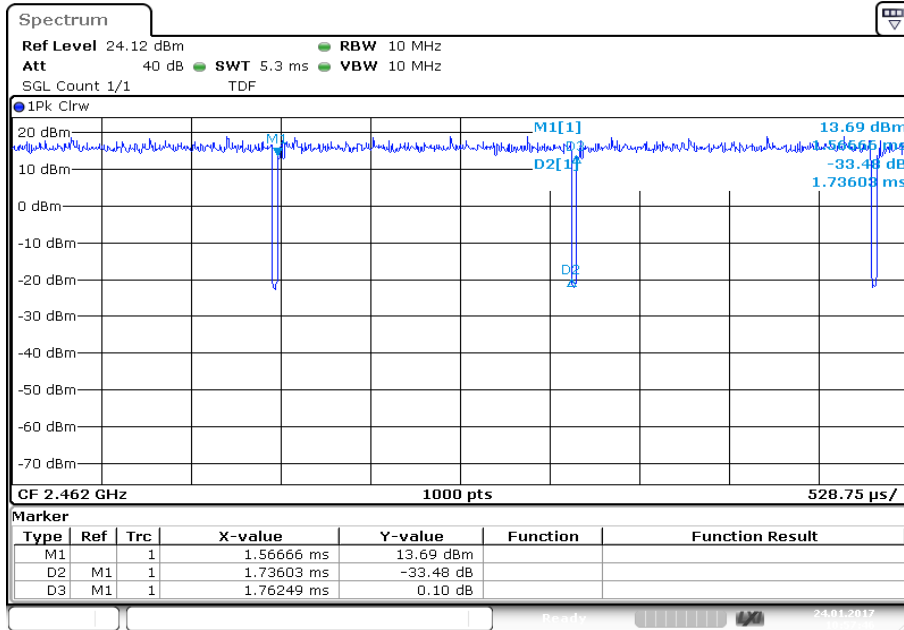

Date: 24.JAN.2017 10:57:47

11.5 Peak power spectral density

Description:

Measurement of the power spectral density of a digital modulated system. The measurement is repeated for both modulations at the lowest, middle and highest channel.

Measurement:

Measurement parameter	
According to DTS clause: 10.2	
Detector:	Positive Peak
Sweep time:	Auto
Resolution bandwidth:	100 kHz
Video bandwidth:	300 kHz
Span:	30 MHz
Trace mode:	Max hold (allow trace to fully stabilize)
Test setup:	See sub clause 6.5 A
Measurement uncertainty	See sub clause 8

Limits:

FCC	IC
8 dBm / 3kHz (conducted)	

Results:

Modulation Frequency	Peak power spectral density @ 100 kHz [dBm]		
	2412 MHz	2437 MHz	2462 MHz
DSSS / b – mode	3.49	4.20	3.60
OFDM / g – mode	1.38	1.07	0.43
OFDM / n HT20 – mode	1.67	0.89	1.02

Plots: DSSS / b – mode

Plot 1: Lowest channel

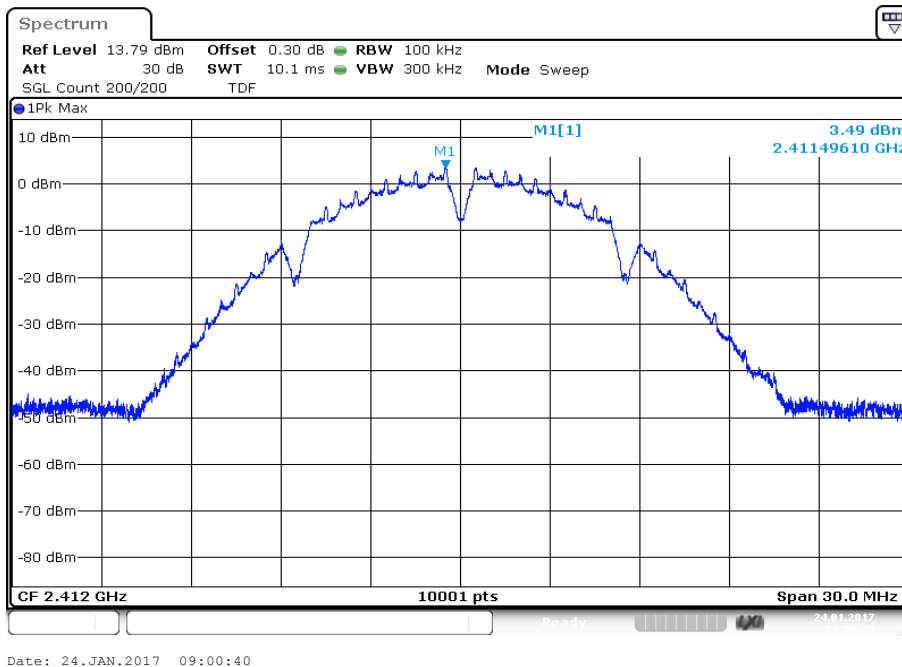

Plot 2: Middle channel

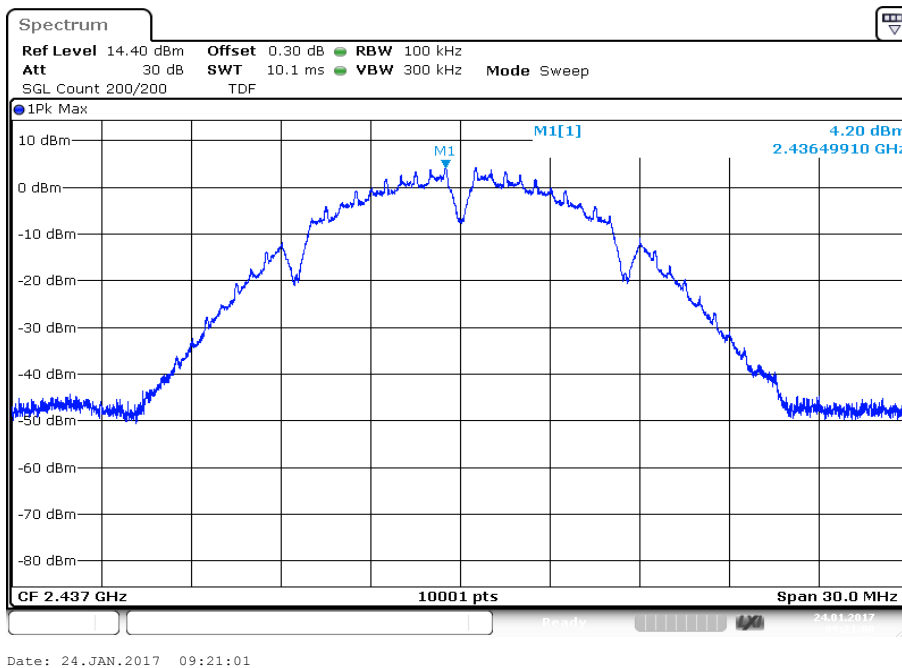

Plot 3: Highest channel

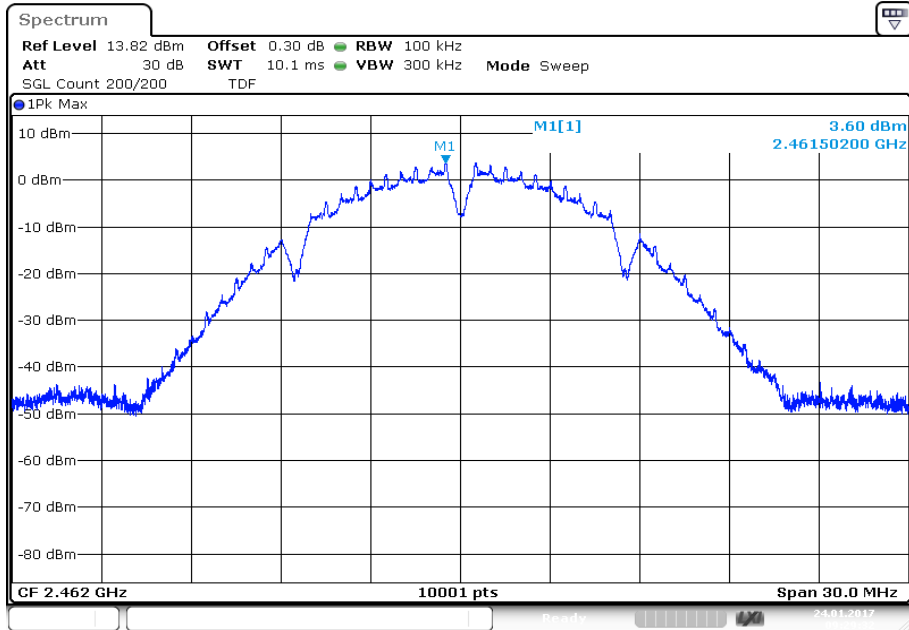

Date: 24.JAN.2017 09:29:32

Plots: OFDM / g – mode

Plot 1: Lowest channel

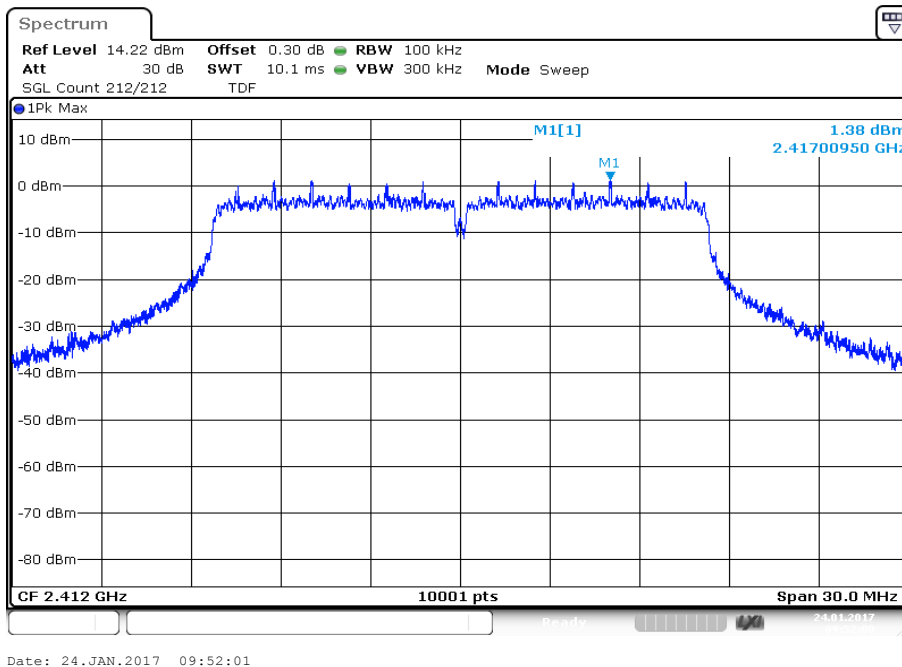

Plot 2: Middle channel

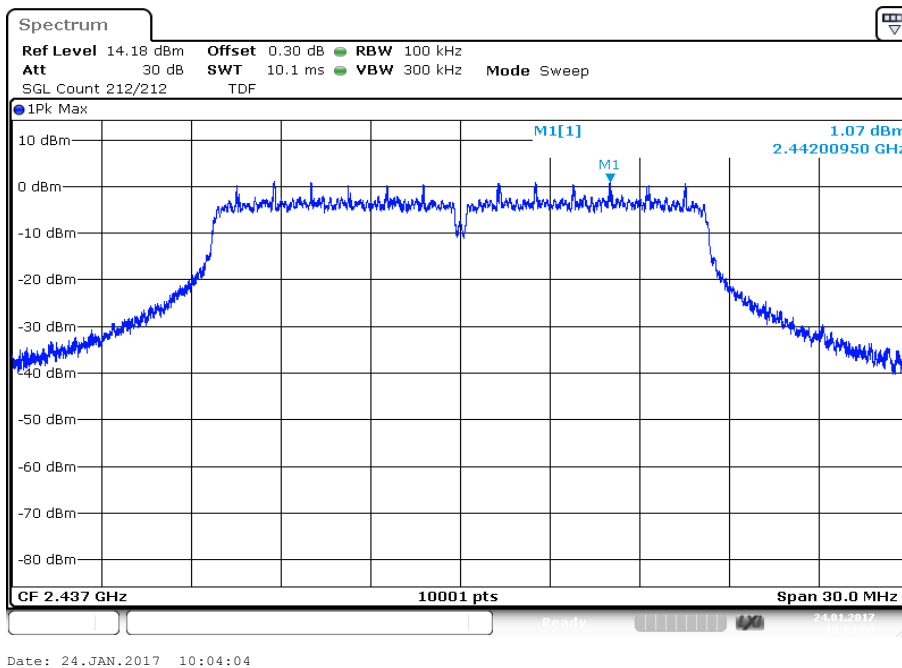

Plot 3: Highest channel

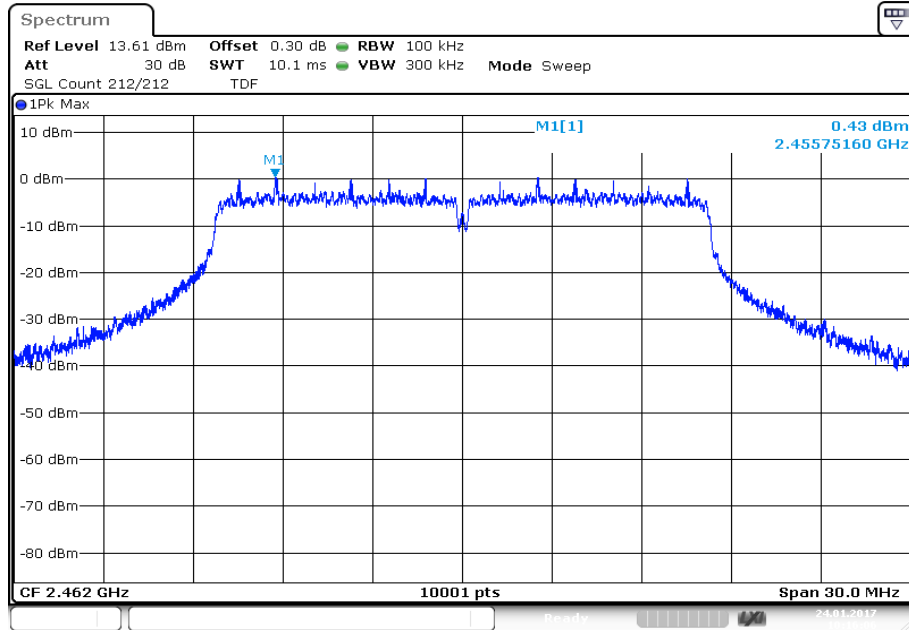

Date: 24.JAN.2017 10:16:06

Plots: OFDM / n HT20 – mode

Plot 1: Lowest channel

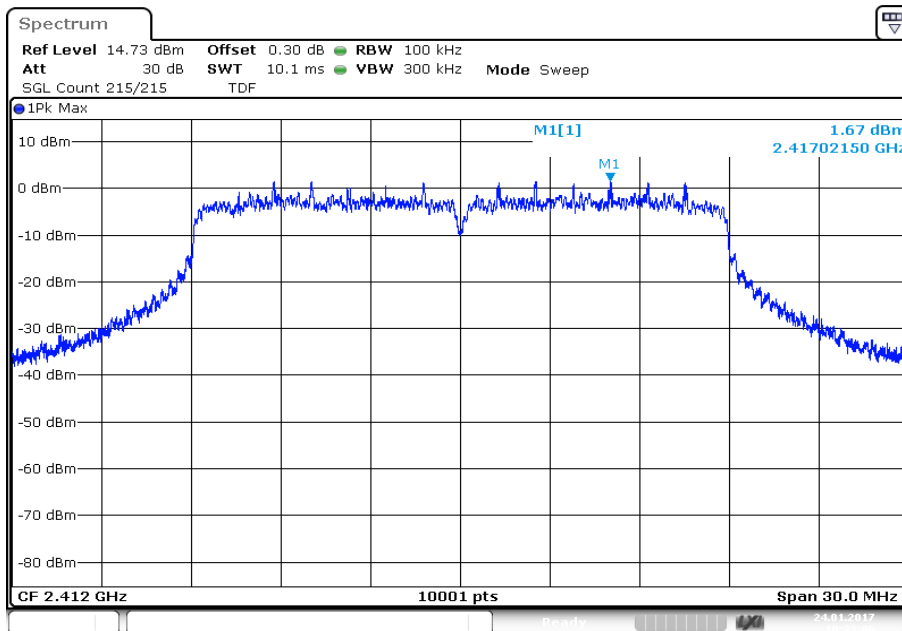

Date: 24.JAN.2017 10:33:06

Plot 2: Middle channel

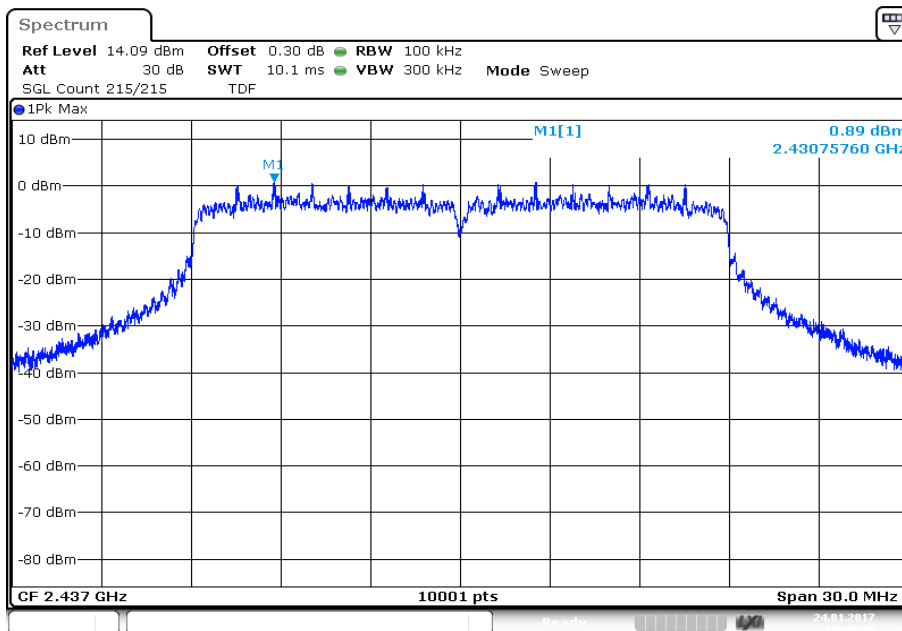

Date: 24.JAN.2017 10:49:56

Plot 3: Highest channel

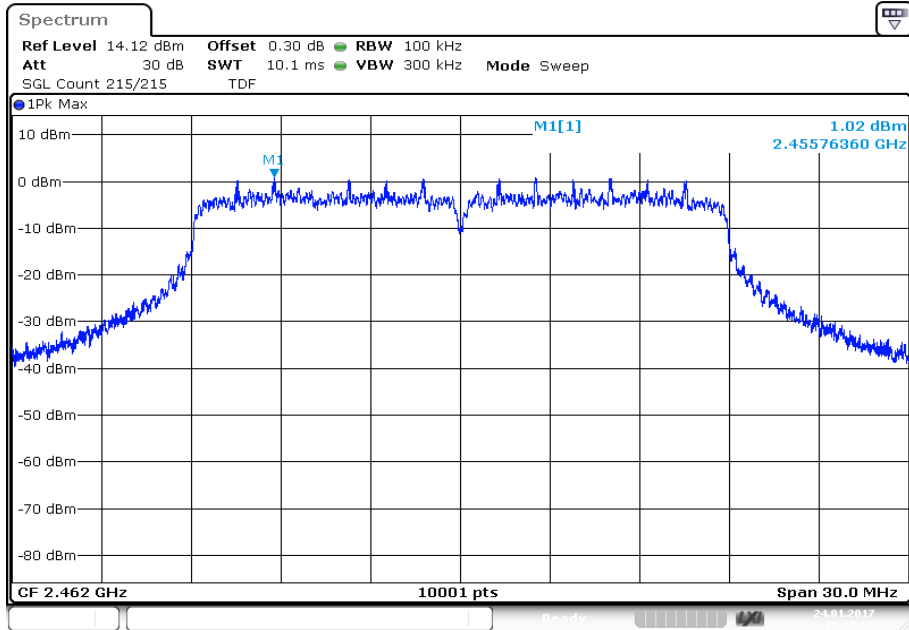

Date: 24.JAN.2017 10:58:57

11.6 6 dB DTS bandwidth

Description:

Measurement of the 6 dB bandwidth of the modulated signal.

Measurement:

Measurement parameter	
According to DTS clause: 8.1	
Detector:	Peak
Sweep time:	Auto
Resolution bandwidth:	100 kHz
Video bandwidth:	500 kHz
Span:	30 MHz / 50 MHz
Trace mode:	Single count with 200 counts
Test setup:	See sub clause 6.5 A
Measurement uncertainty	See sub clause 8

Limits:

FCC	IC
Systems using digital modulation techniques may operate in the 2400–2483.5 MHz band. The minimum 6 dB bandwidth shall be at least 500 kHz.	

Results:

Frequency	6 dB DTS bandwidth [kHz]		
	2412 MHz	2437 MHz	2462 MHz
DSSS / b – mode	7094	7097	7094
OFDM / g – mode	16310	16312	16318
OFDM / n HT20 – mode	17407	17.521	17527

Plots: DSSS / b – mode

Plot 1: Lowest channel

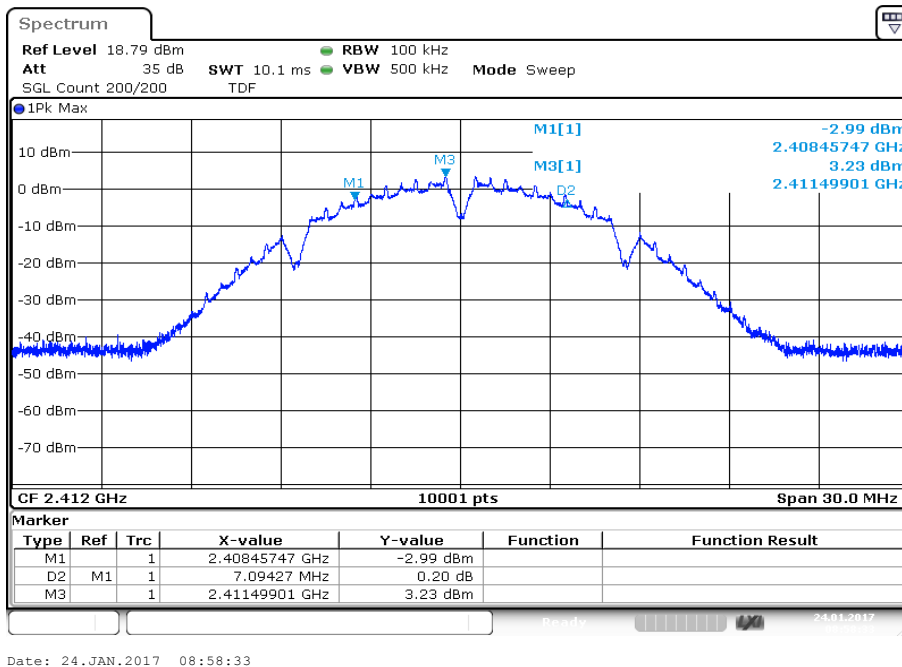

Plot 2: Middle channel

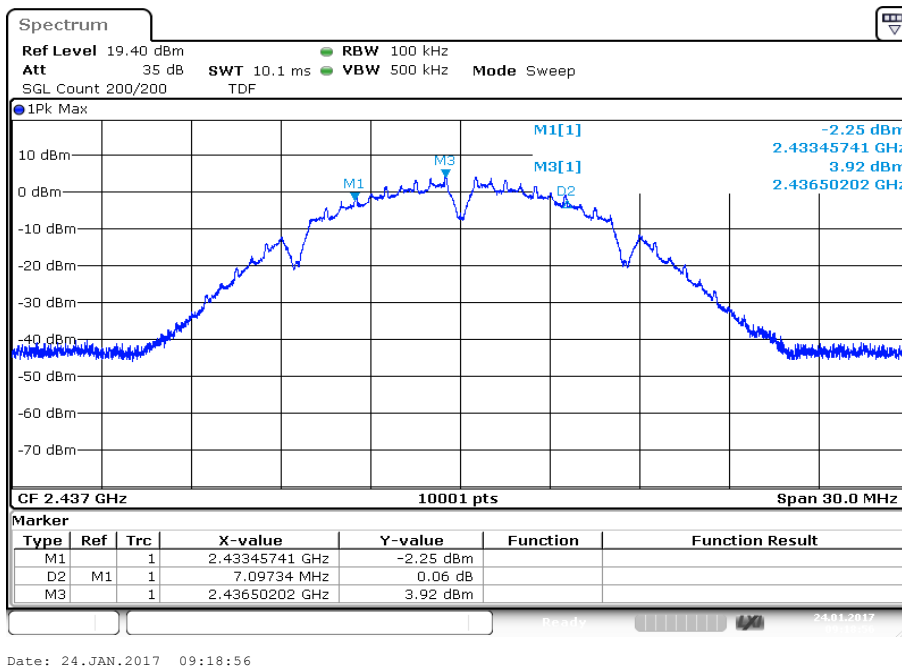

Plot 3: Highest channel

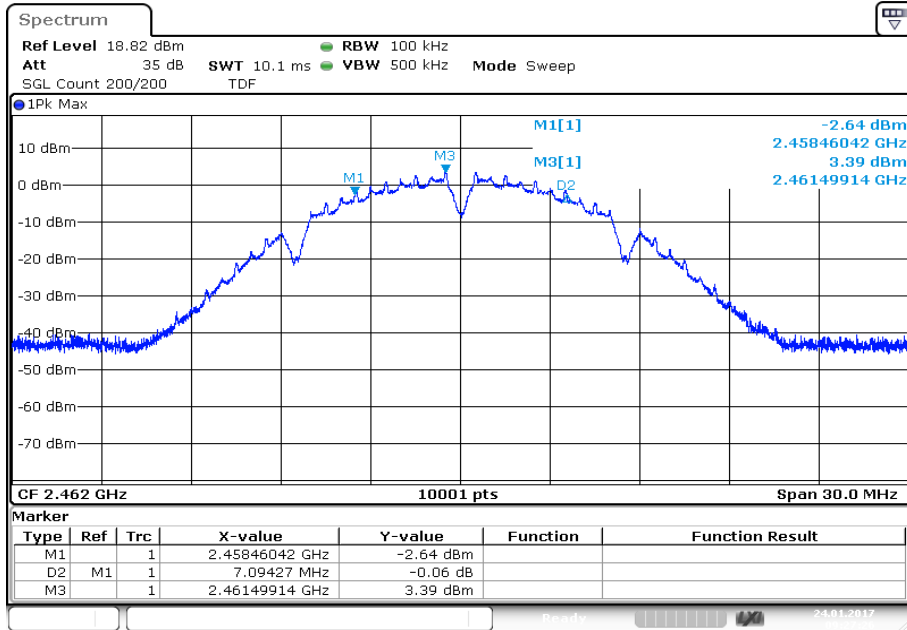

Date: 24.JAN.2017 09:27:26

Plots: OFDM / g – mode

Plot 1: Lowest channel

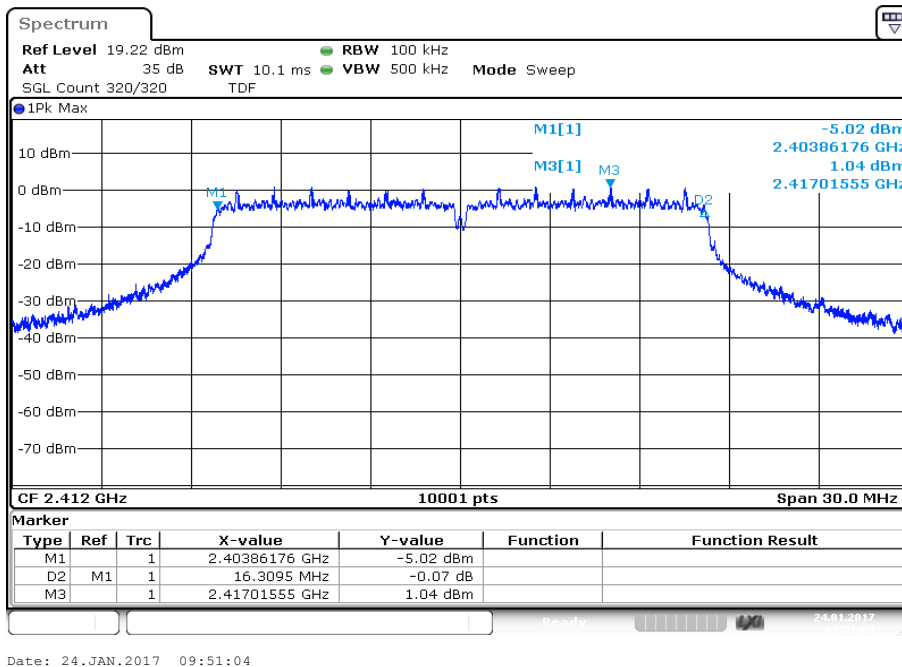

Plot 2: Middle channel

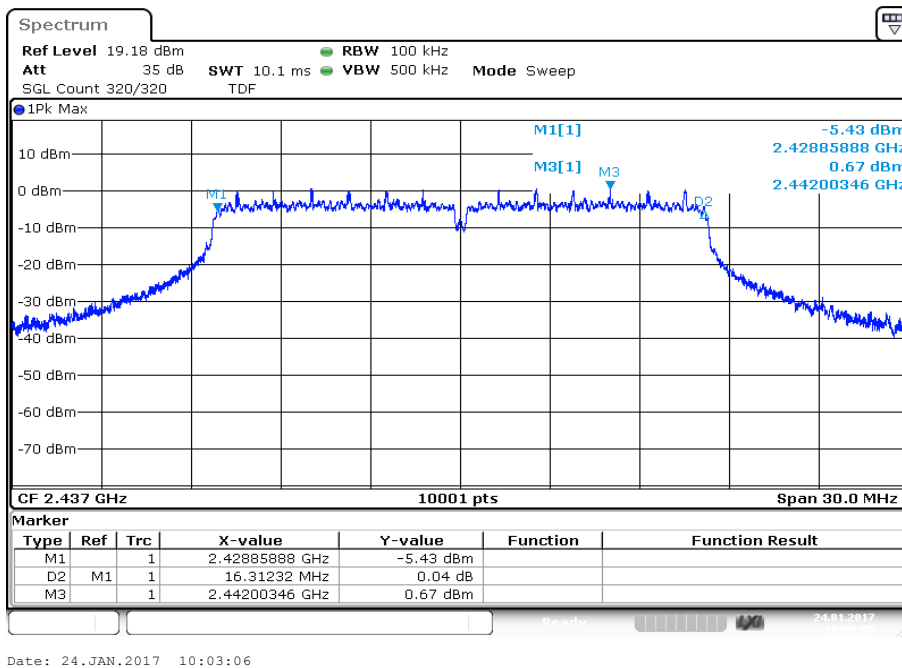

Plot 3: Highest channel

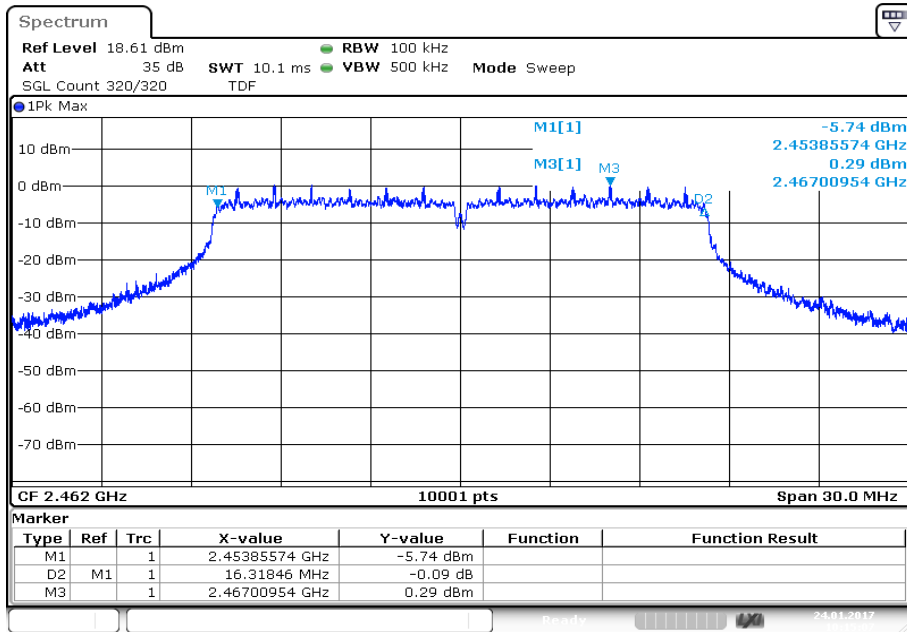

Plots: OFDM / n HT20 – mode

Plot 1: Lowest channel

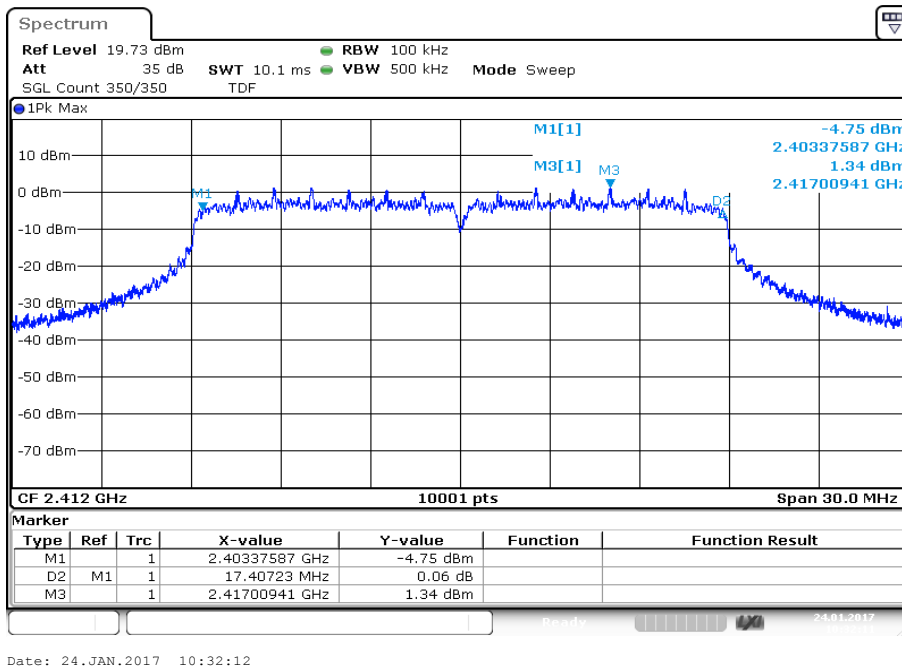

Plot 2: Middle channel

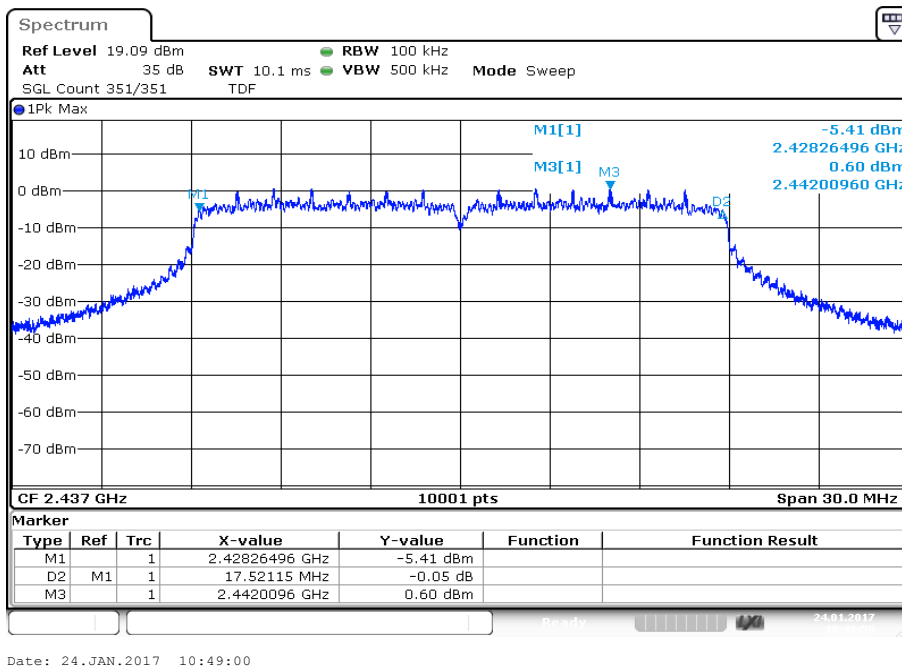

Plot 3: Highest channel

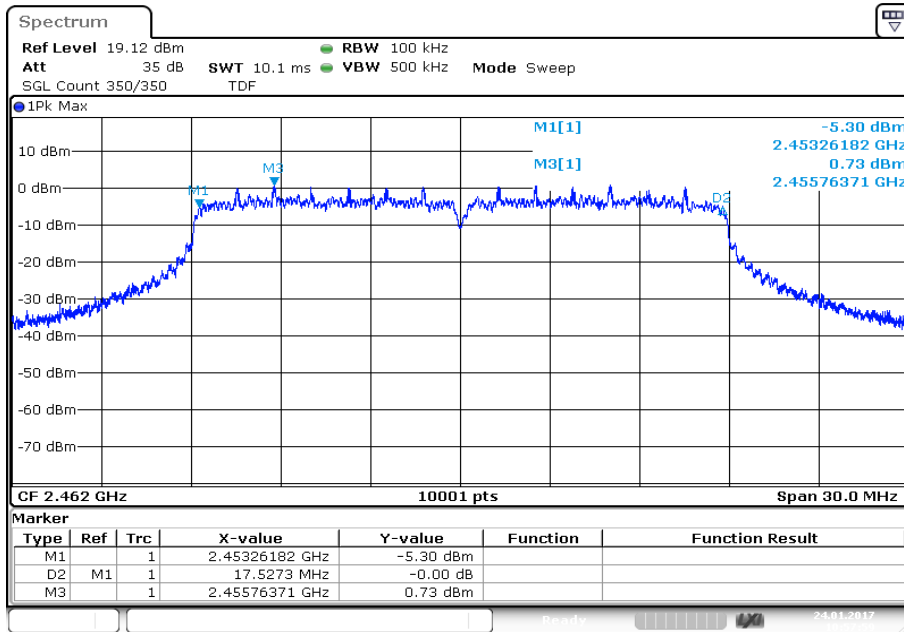

Date: 24.JAN.2017 10:58:00

11.7 Occupied bandwidth – 99% emission bandwidth

Description:

Measurement of the 99% bandwidth of the modulated signal acc. RSS-GEN.

Measurement:

Measurement parameter	
Detector:	Peak
Sweep time:	Auto
Resolution bandwidth:	300 kHz
Video bandwidth:	1 MHz
Span:	30 MHz / 50 MHz
Measurement procedure:	Measurement of the 99% bandwidth using the integration function of the analyzer
Trace mode:	Single count with 200 counts
Test setup:	See sub clause 6.5 A
Measurement uncertainty	See sub clause 8

Usage:

-/-	IC
OBW is necessary for Emission Designator	

Results:

Modulation	99% bandwidth [kHz]		
	2412 MHz	2437 MHz	2462 MHz
Frequency			
DSSS / b – mode	11840	11873	11885
OFDM / g – mode	16843	16849	16840
OFDM / n HT20 – mode	17974	17965	17977

Plots: DSSS / b – mode

Plot 1: Lowest channel

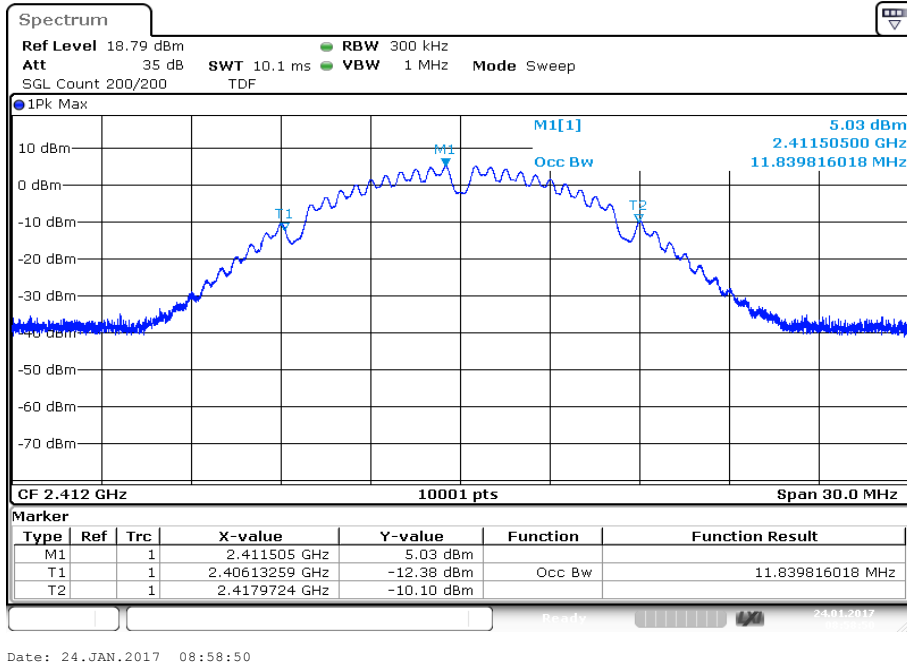

Plot 2: Middle channel

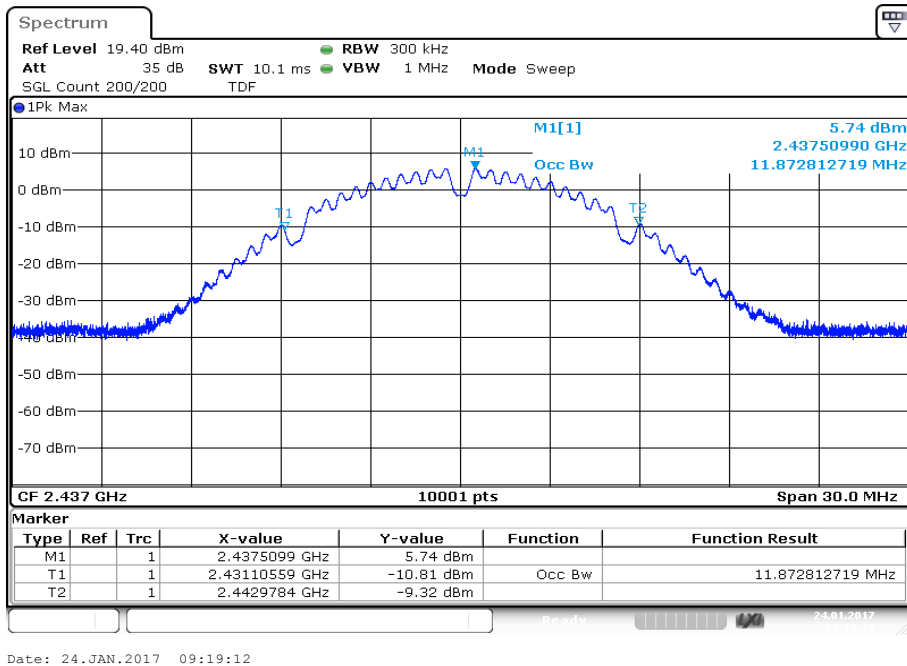

Plot 3: Highest channel

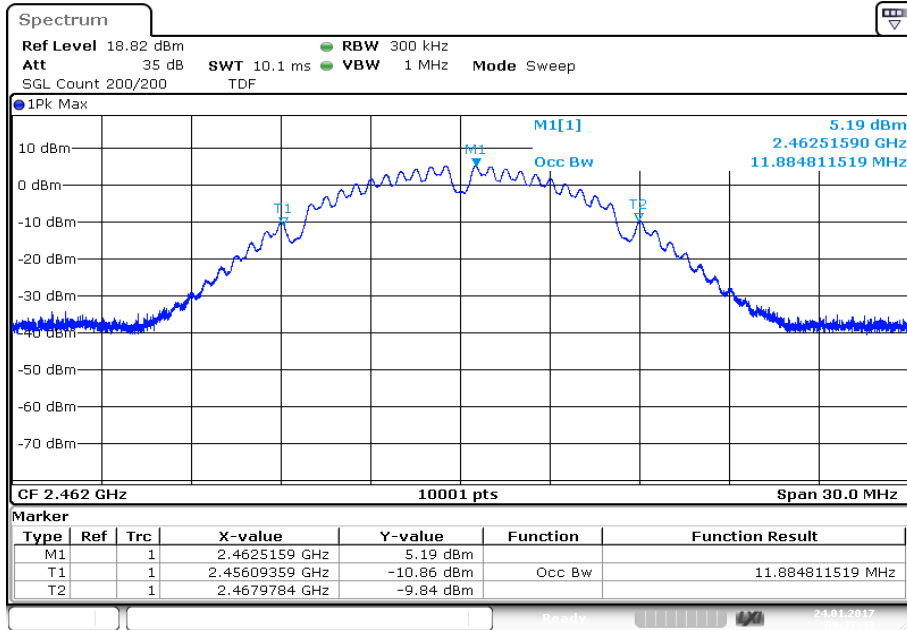

Date: 24.JAN.2017 09:27:43

Plots: OFDM / g – mode

Plot 1: Lowest channel

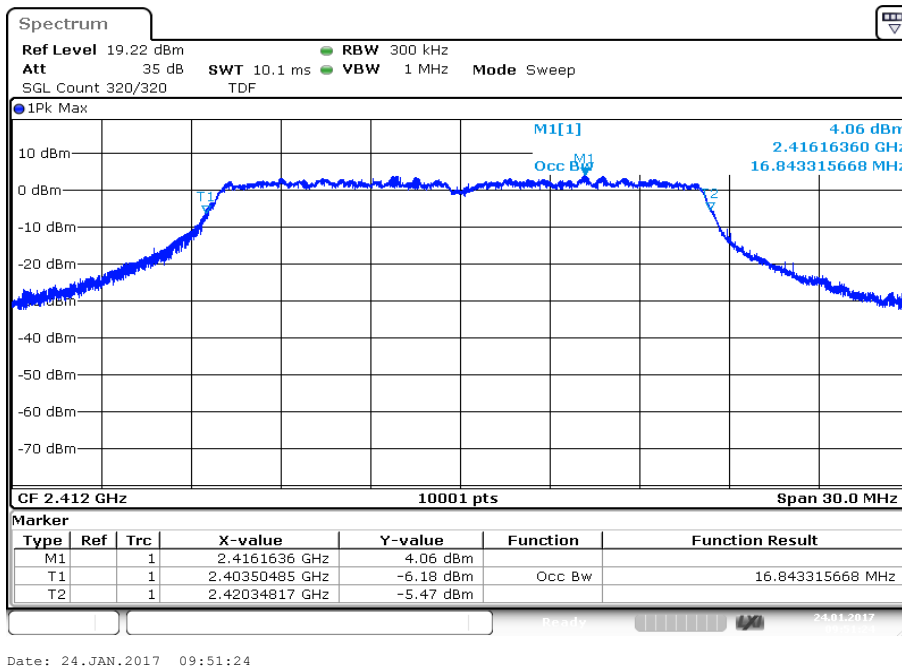

Plot 2: Middle channel

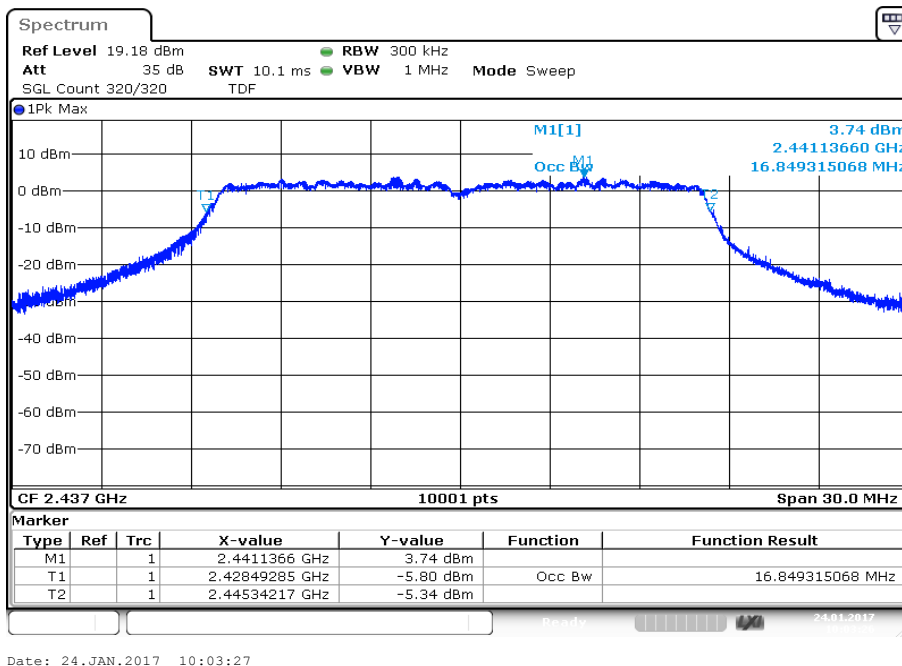

Plot 3: Highest channel

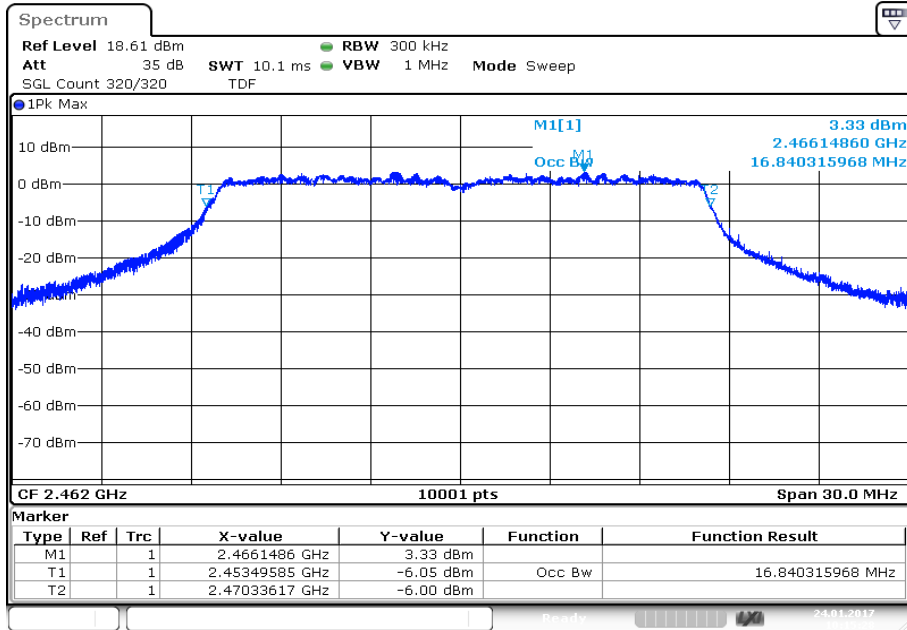

Date: 24.JAN.2017 10:15:29

Plots: OFDM / n HT20 – mode

Plot 1: Lowest channel

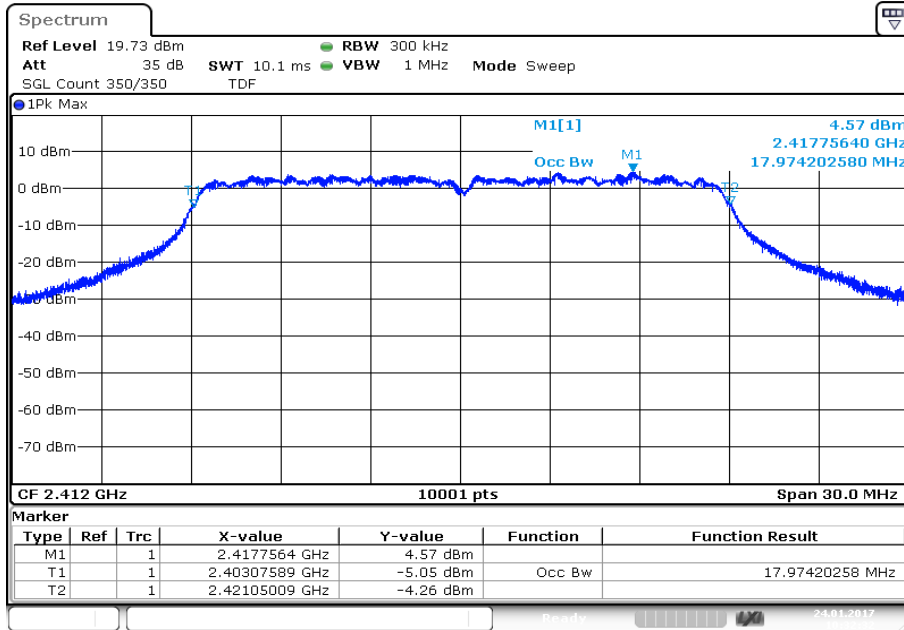

Date: 24.JAN.2017 10:32:33

Plot 2: Middle channel

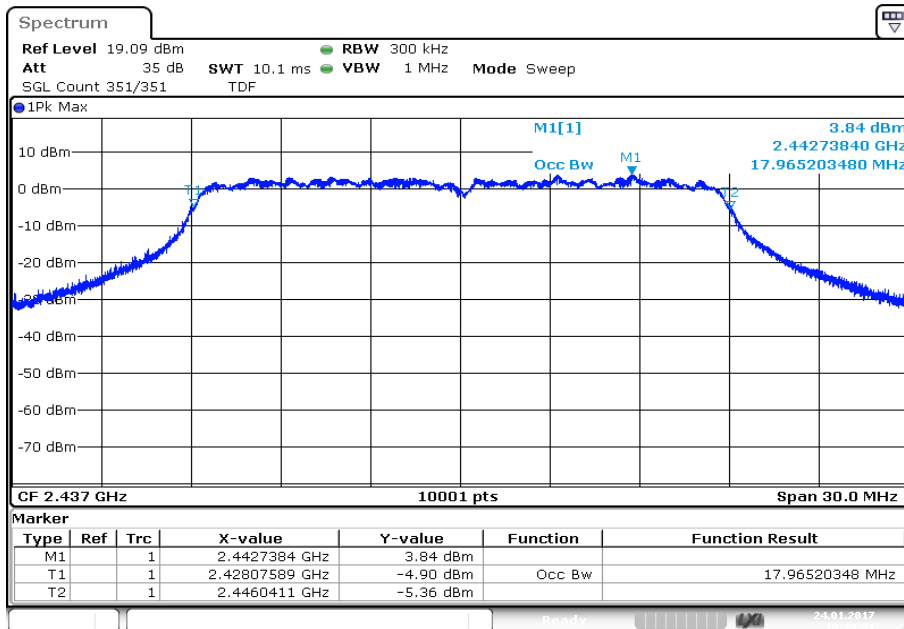

Date: 24.JAN.2017 10:49:22

Plot 3: Highest channel

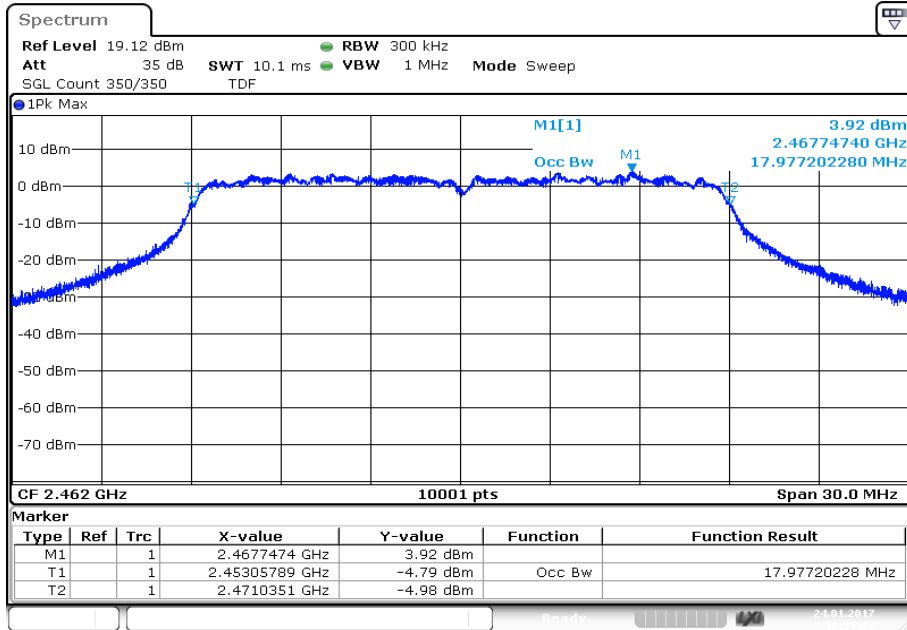

Date: 24.JAN.2017 10:58:22

11.8 Occupied bandwidth – 20 dB bandwidth

Description:

Measurement of the 20 dB bandwidth of the modulated carrier.

Measurement:

Measurement parameter	
Detector:	Peak
Sweep time:	Auto
Resolution bandwidth:	100 kHz
Video bandwidth:	500 kHz
Span:	30 MHz / 50 MHz
Trace mode:	Single count with min. 200 counts
Test setup:	See sub clause 6.5 A
Measurement uncertainty	See sub clause 8

Usage:

-/-	IC
Within the used band!	

Results:

Modulation Frequency	20 dB bandwidth [MHz]		
	2412 MHz	2437 MHz	2462 MHz
DSSS / b – mode	13.11	13.12	13.12
OFDM / g – mode	17.75	17.61	17.79
OFDM / n HT20 – mode	18.92	18.96	18.94

Plots: DSSS / b – mode

Plot 1: Lowest channel

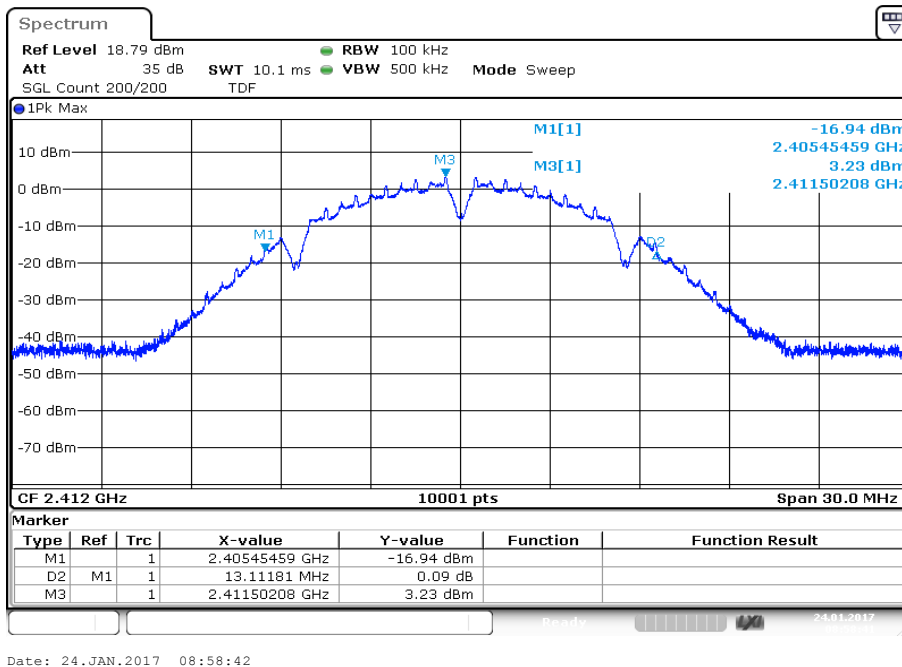

Plot 2: Middle channel

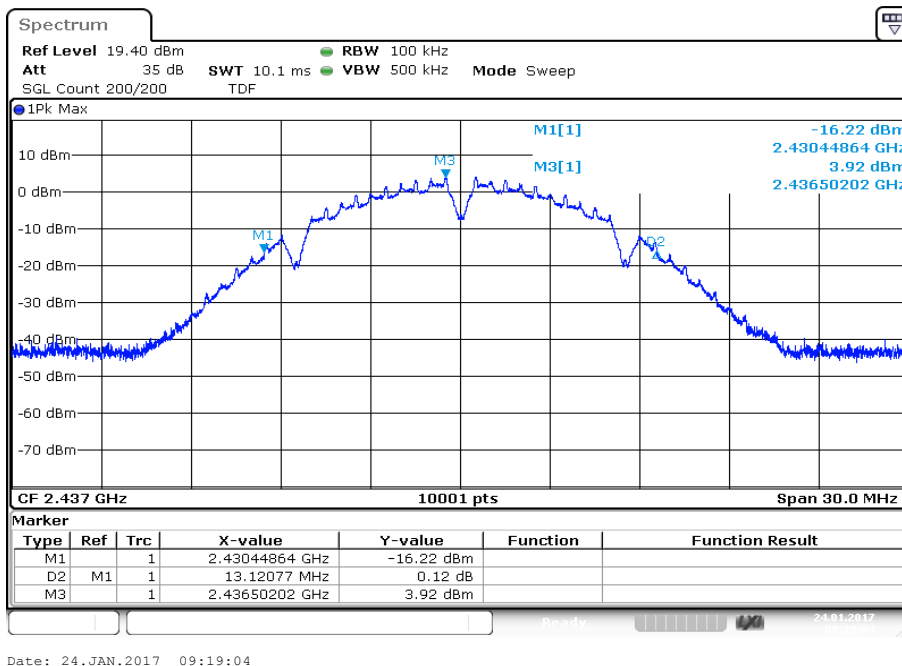

Plot 3: Highest channel

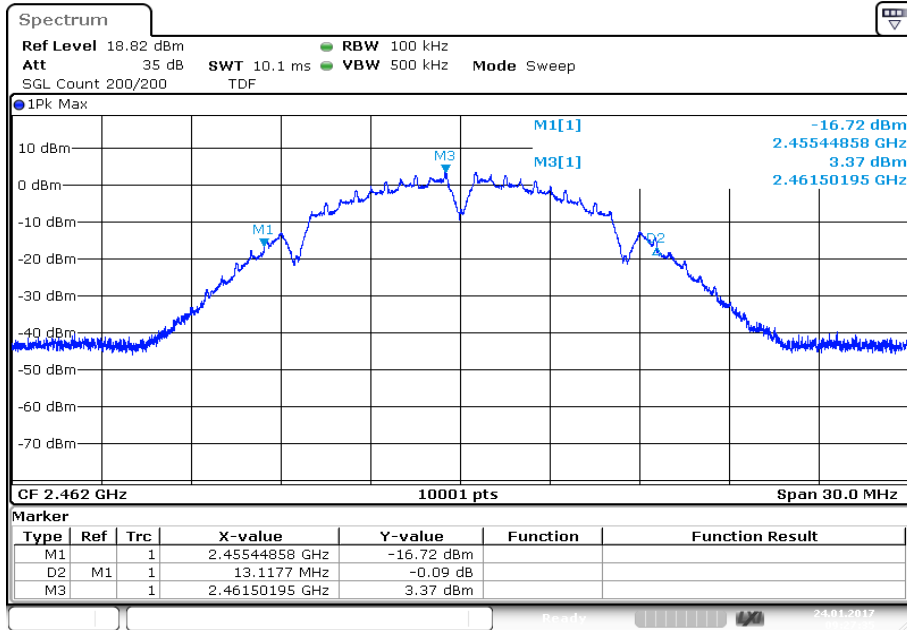

Date: 24.JAN.2017 09:27:35

Plots: OFDM / g – mode

Plot 1: Lowest channel

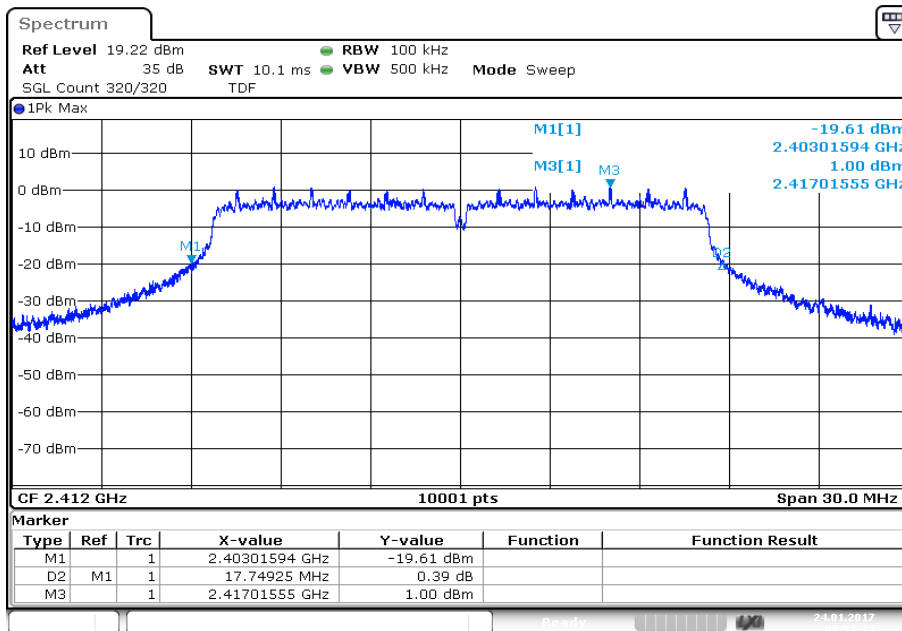

Date: 24.JAN.2017 09:51:14

Plot 2: Middle channel

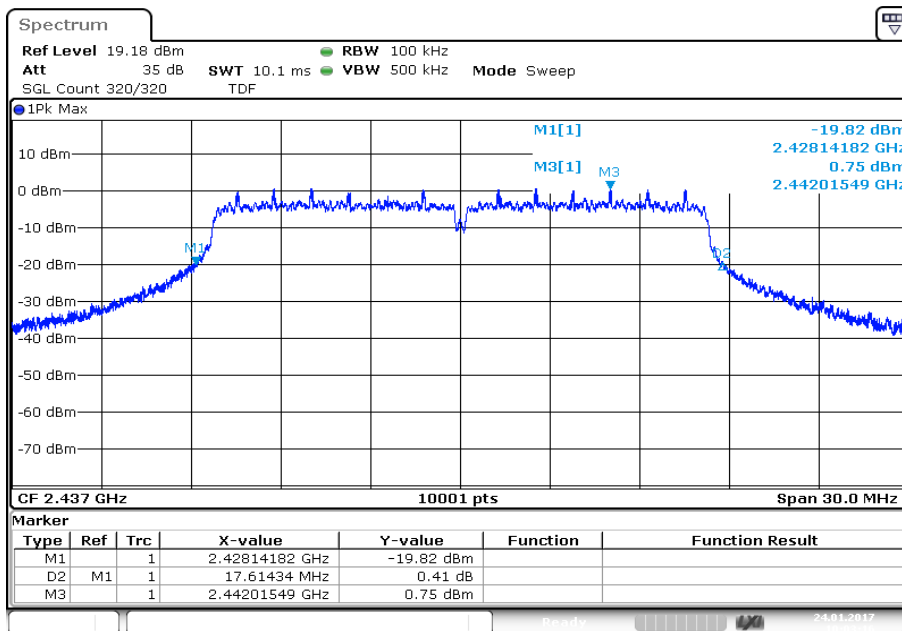

Date: 24.JAN.2017 10:03:17

Plot 3: Highest channel

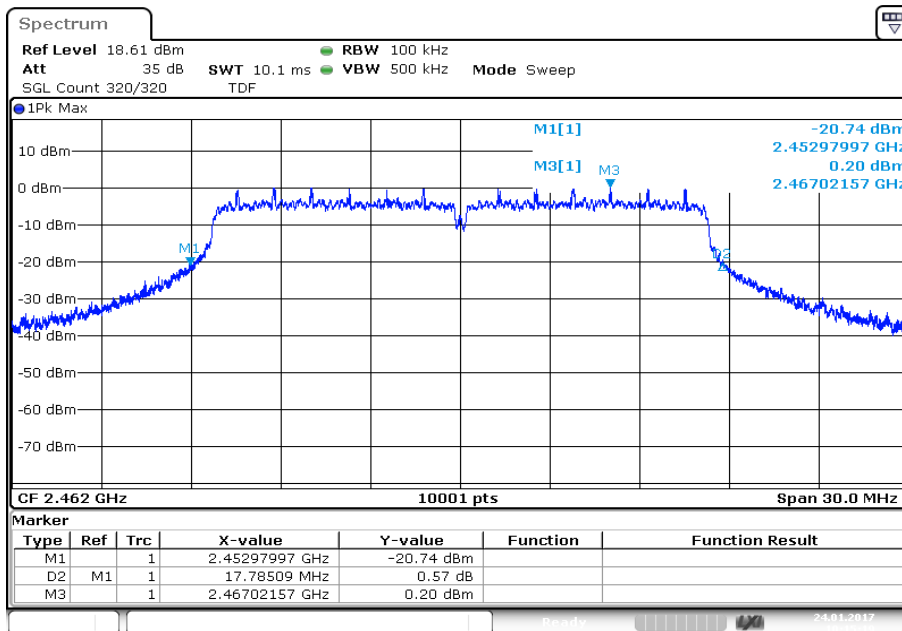

Plots: OFDM / n HT20 – mode

Plot 1: Lowest channel

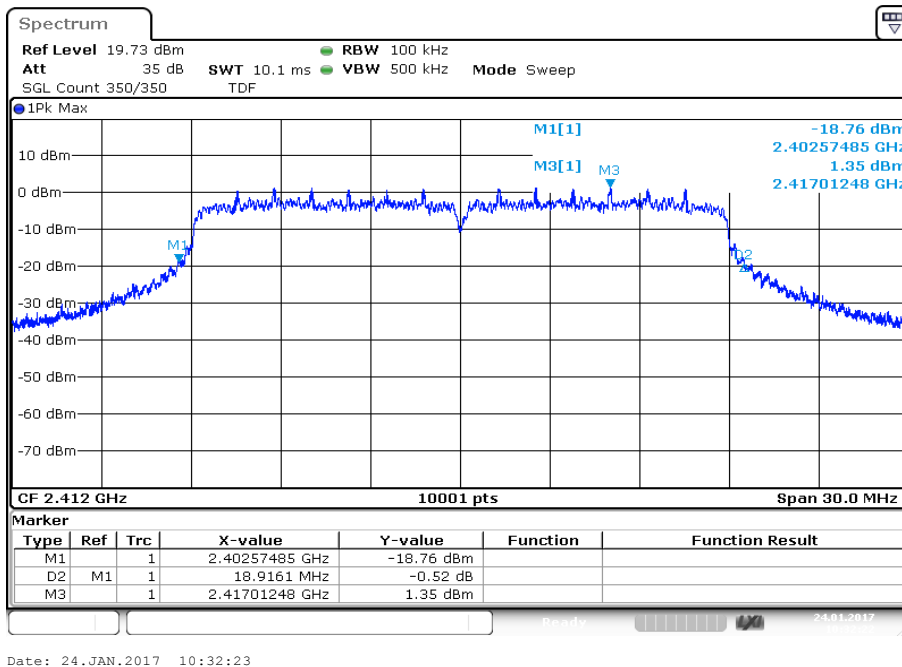

Plot 2: Middle channel

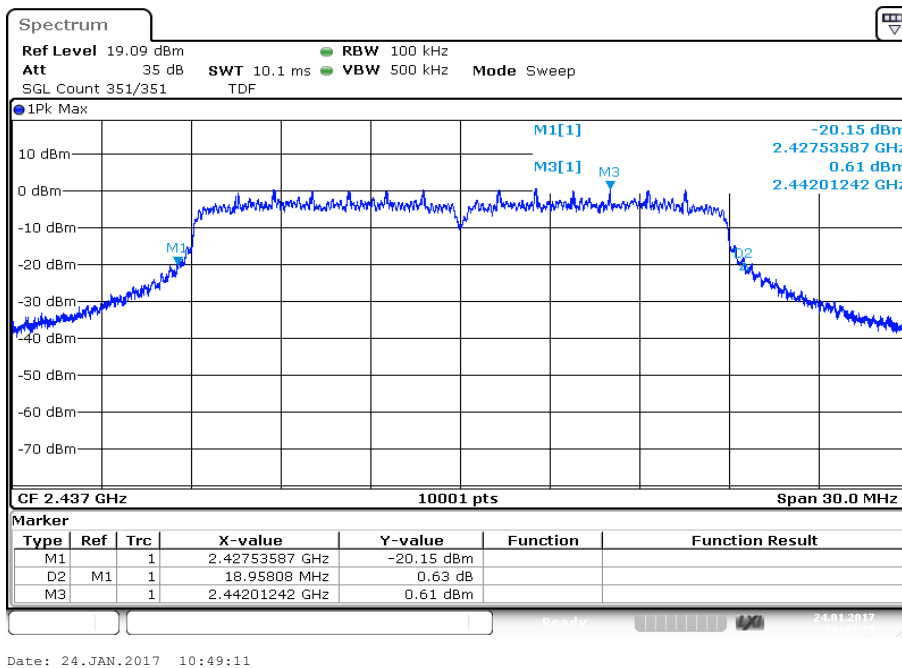

Plot 3: Highest channel

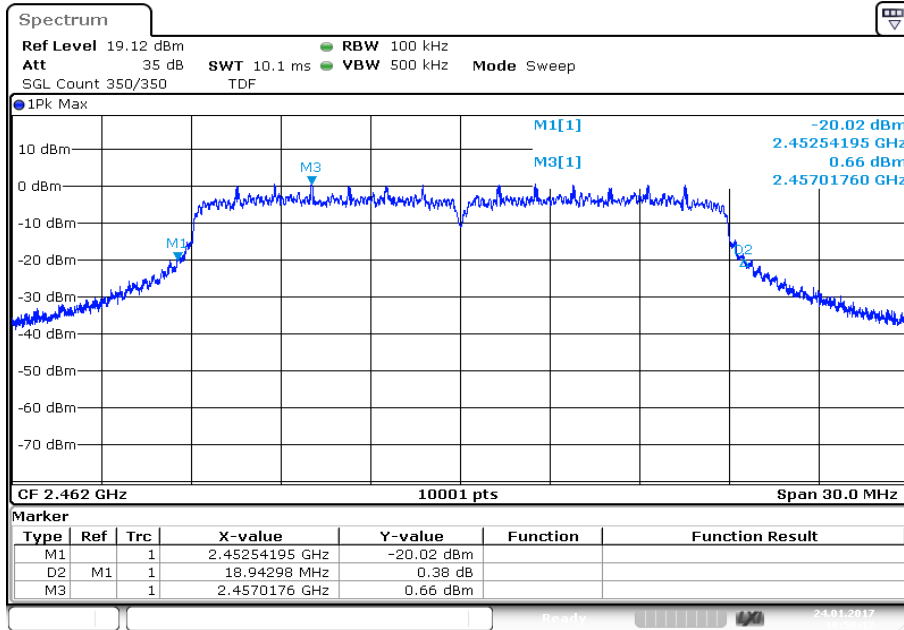

Date: 24.JAN.2017 10:58:12

11.9 Band edge compliance conducted

Description:

Measurement of the radiated band edge compliance with a conducted test setup.

Measurement:

Measurement parameter for measurements	
According to DTS clause: 13.3.2 and clause 12.2.2	
Detector:	RMS
Sweep time:	Auto
Resolution bandwidth:	100 kHz
Video bandwidth:	300 kHz
Span:	Lower band edge: 2388 MHz to 2390 MHz (2 MHz) Upper band edge: 2483.5 MHz to 2485.5 MHz (2 MHz)
Trace mode:	Trace average with 200 counts
Test setup:	See sub clause 6.5 A
Measurement uncertainty	See sub clause 8

Limits:

FCC	IC
-41.26 dBm	

Results:

Scenario Modulation	Band edge compliance [dBm]			
	DSSS / b – mode	OFDM / g – mode	OFDM / n HT20 – mode	OFDM / n HT40 – mode
Max. lower band edge power conducted	-59.30	-46.13	-44.07	-/-
Antenna gain	-2.0 dBi			
Max. lower band edge power radiated	-61.30	-48.13	-46.07	-/-
Max. upper band edge power conducted	-59.56	-46.68	-44.06	-/-
Antenna gain	-2.0 dBi			
Max. upper band edge power radiated	-61.56	-48.68	-46.06	-/-

Plots: DSSS / b – mode

Plot 1: Lower band edge

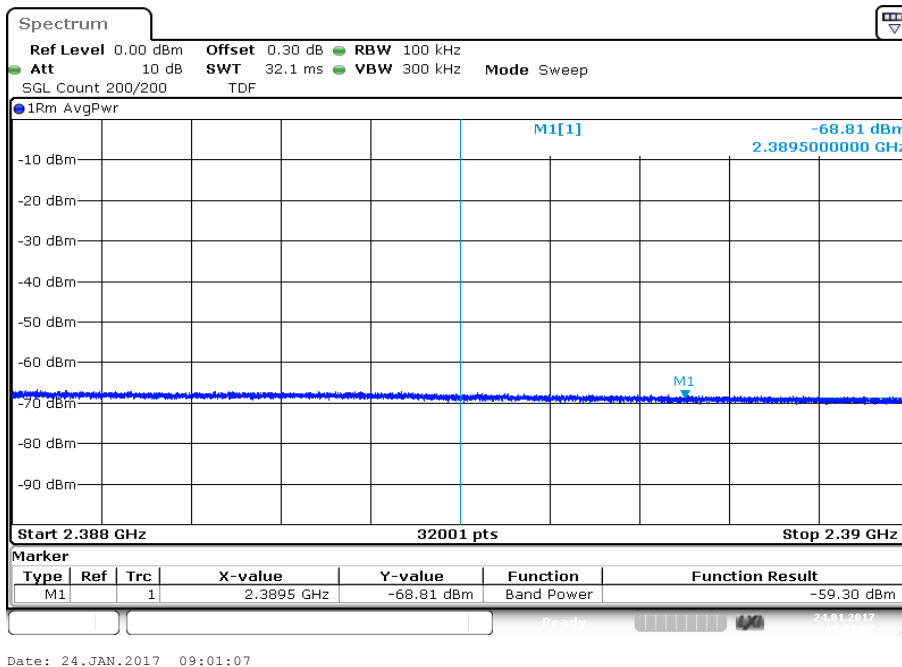

Plot 2: Upper band edge

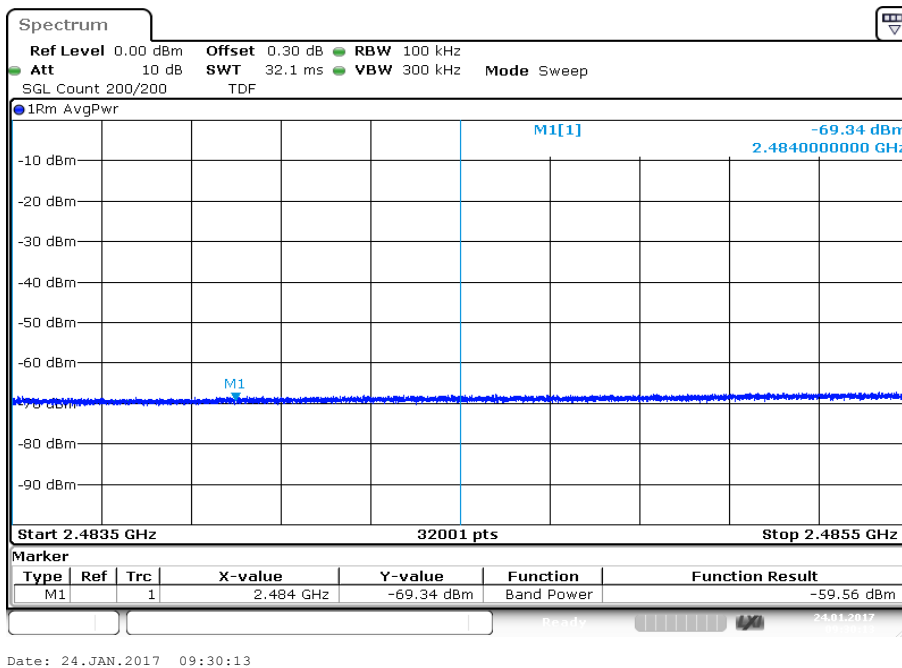

Plots: OFDM / g – mode

Plot 1: Lower band edge

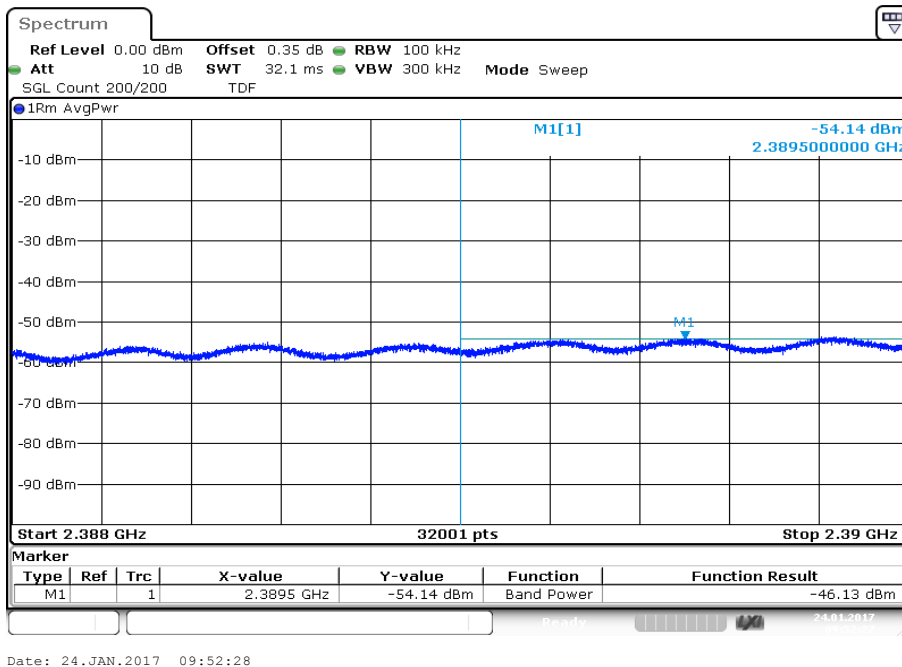

Plot 2: Upper band edge

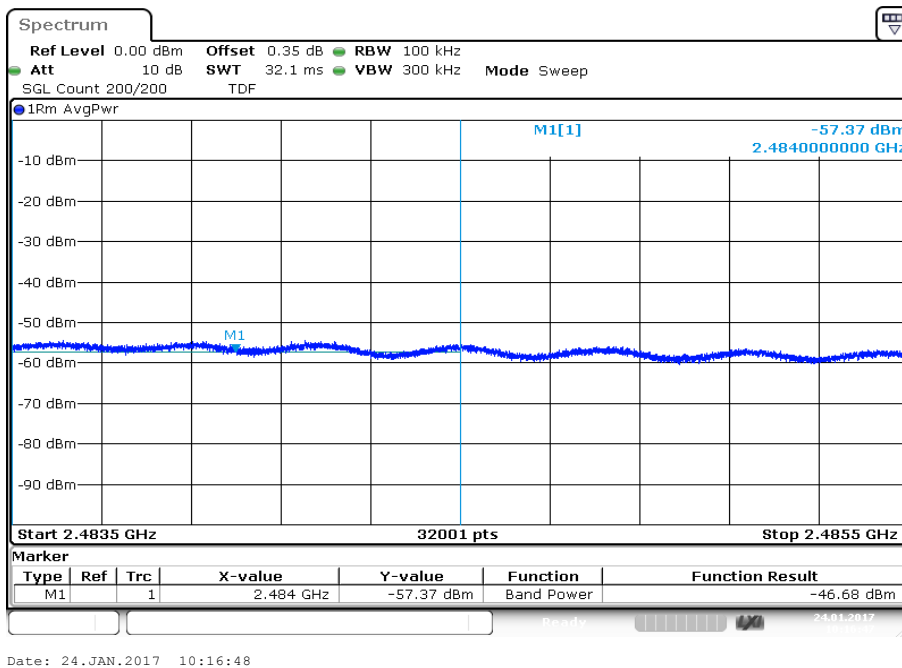

Plots: OFDM / n HT20 – mode

Plot 1: Lower band edge

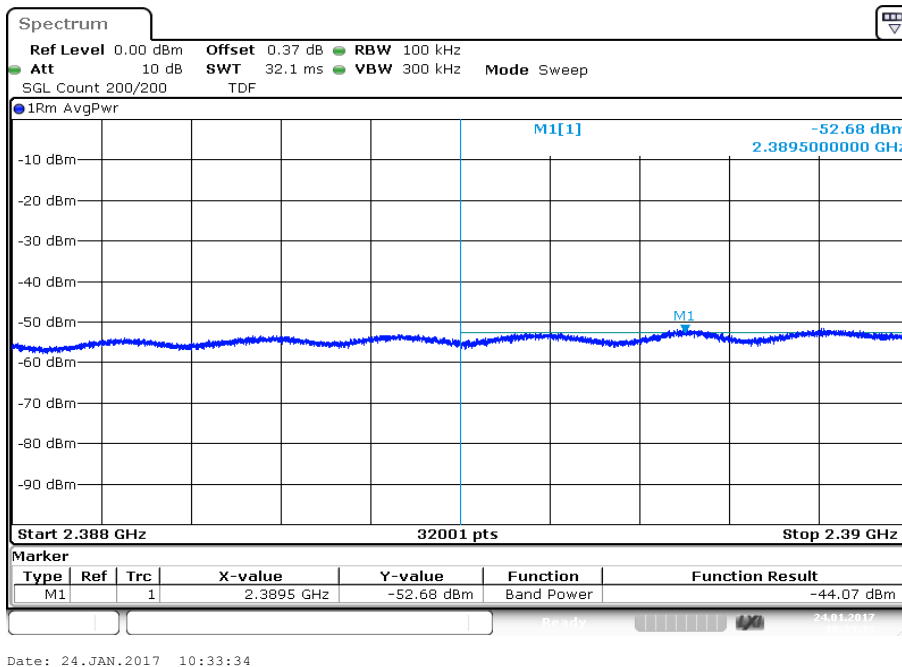

Plot 2: Upper band edge

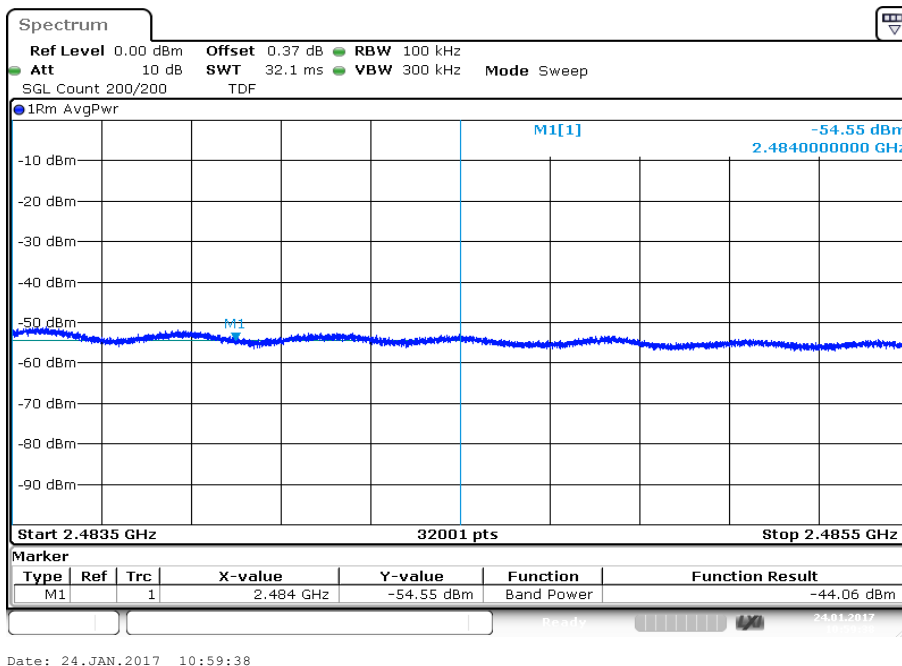

11.10 Spurious emissions conducted

Description:

Measurement of the conducted spurious emissions in transmit mode. The measurement is performed at channel 1, 6 and 11. The measurement is repeated for all modulations.

Measurement:

Measurement parameter	
Detector:	Peak
Sweep time:	Auto
Resolution bandwidth:	100 kHz
Video bandwidth:	500 kHz
Span:	9 kHz to 25 GHz (500 MHz steps)
Trace mode:	Max Hold
Test setup:	See sub clause 6.5 A
Measurement uncertainty	See sub clause 8

Limits:

FCC	IC
In any 100 kHz bandwidth outside the frequency band in which the spread spectrum or digitally modulated intentional radiator is operating, the radio frequency power that is produced by the intentional radiator shall be at least 30 dB below that in the 100 kHz bandwidth within the band that contains the highest level of the desired power, based on either an RF conducted or a radiated measurement. Attenuation below the general limits specified in Section 15.209(a) is not required	

Results: DSSS / b – mode

TX Spurious Emissions Conducted					
DSSS / b – mode					
f [MHz]		amplitude of emission [dBm]	limit max. allowed emission power	actual attenuation below frequency of operation [dB]	results
2412		2.82	30 dBm		Operating frequency
No peaks detected.			-20 dBc (peak) -30 dBc (average)		compliant
2437		3.07	30 dBm		Operating frequency
No peaks detected.			-20 dBc (peak) -30 dBc (average)		compliant
2462		3.04	30 dBm		Operating frequency
No peaks detected.			-20 dBc (peak) -30 dBc (average)		compliant

Results: OFDM / g – mode

TX Spurious Emissions Conducted					
OFDM / g – mode					
f [MHz]		amplitude of emission [dBm]	limit max. allowed emission power	actual attenuation below frequency of operation [dB]	results
2412		0.62	30 dBm		Operating frequency
No peaks detected.			-20 dBc (peak) -30 dBc (average)		compliant
2437		1.09	30 dBm		Operating frequency
No peaks detected.			-20 dBc (peak) -30 dBc (average)		compliant
2462		0.09	30 dBm		Operating frequency
No peaks detected.			-20 dBc (peak) -30 dBc (average)		compliant

Results: OFDM / n HT20 – mode

TX Spurious Emissions Conducted					
OFDM / n HT20 – mode					
f [MHz]		amplitude of emission [dBm]	limit max. allowed emission power	actual attenuation below frequency of operation [dB]	results
2412		0.67	30 dBm		Operating frequency
No peaks detected.			-20 dBc (peak) -30 dBc (average)		compliant
2437		-1.84	30 dBm		Operating frequency
No peaks detected.			-20 dBc (peak) -30 dBc (average)		compliant
2462		0.84	30 dBm		Operating frequency
No peaks detected.			-20 dBc (peak) -30 dBc (average)		compliant

Plots: DSSS / b – mode

Plot 1: Lowest channel, up to 25 GHz

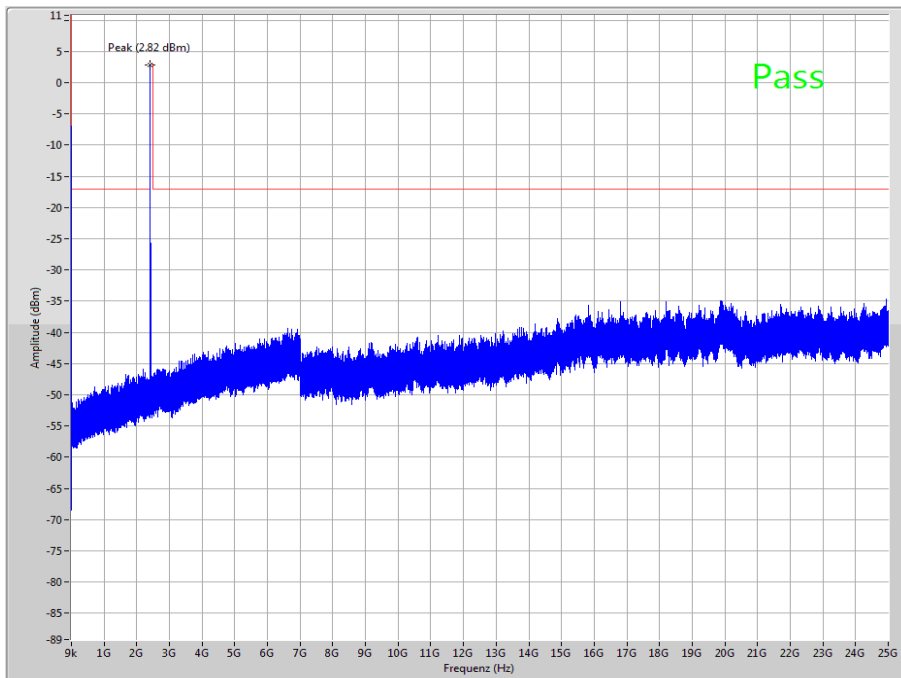

The peak at the beginning of the plot is the LO from the SA.

Plot 2: Lowest channel, zoomed carrier

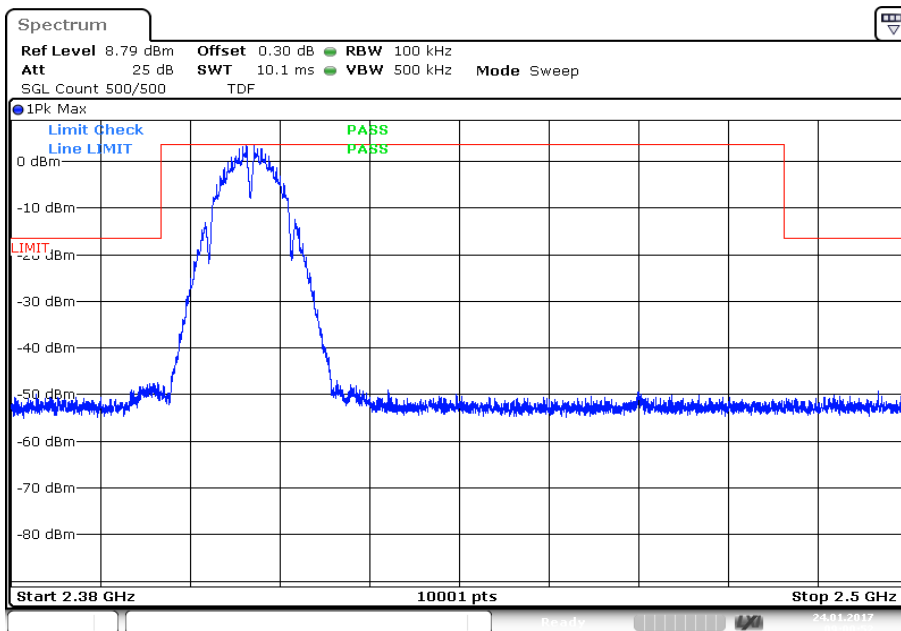

Plot 3: Middle channel, up to 25 GHz

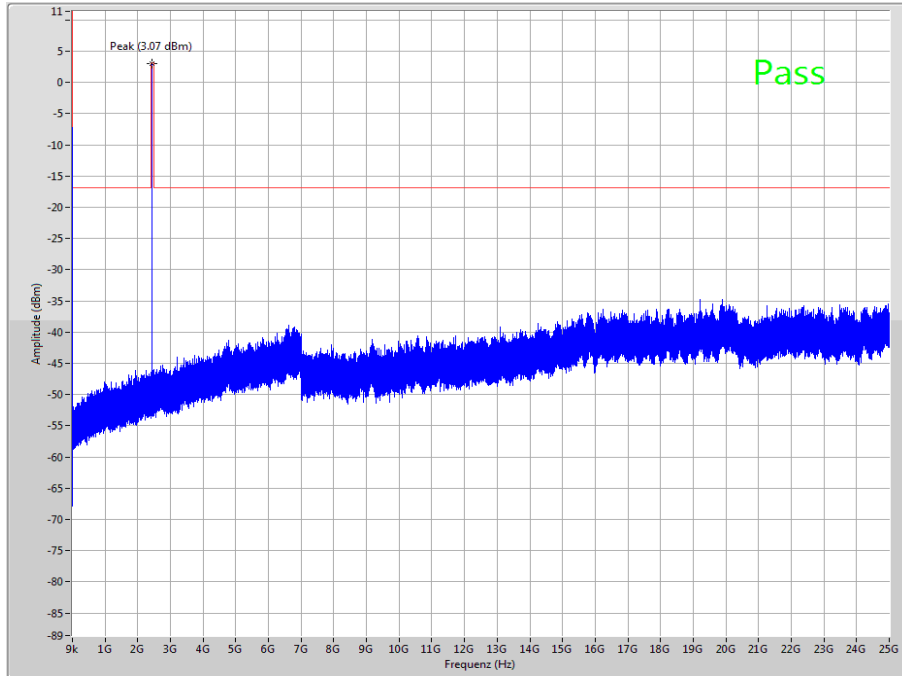

The peak at the beginning of the plot is the LO from the SA.

Plot 4: Middle channel, zoomed carrier

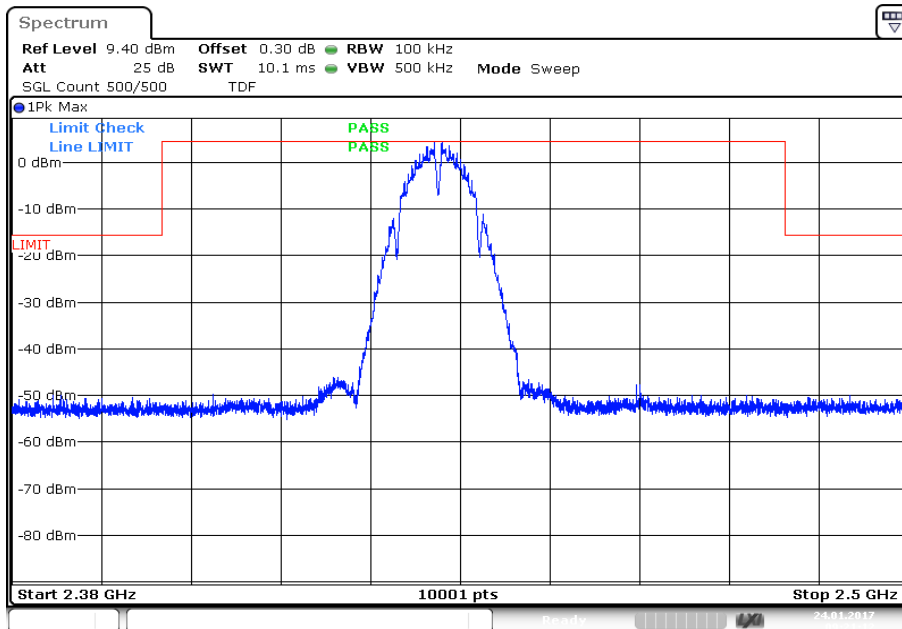

Plot 5: Highest channel, up to 25 GHz

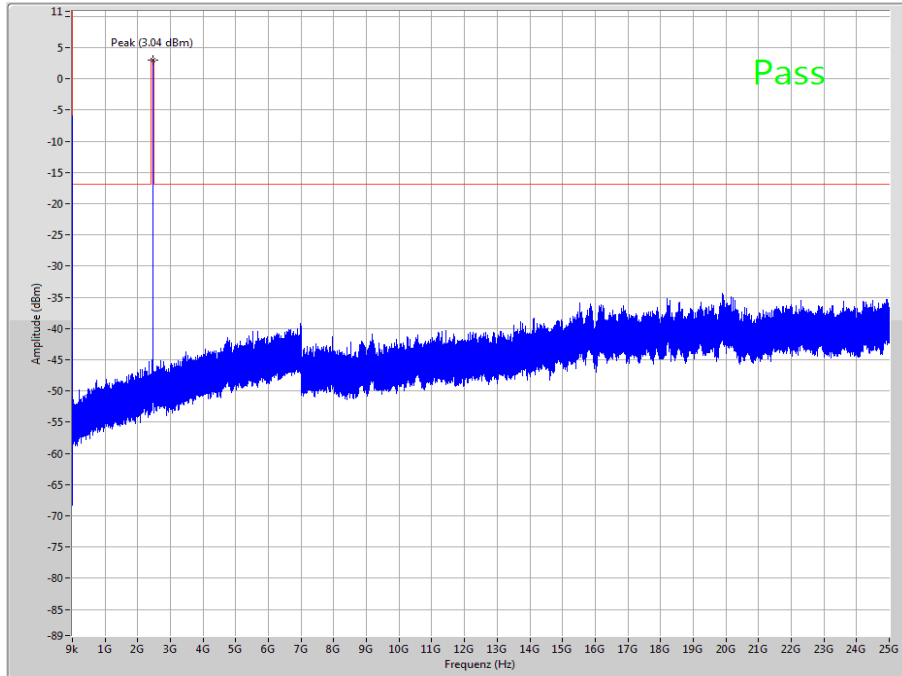

The peak at the beginning of the plot is the LO from the SA.

Plot 6: Highest channel, zoomed carrier

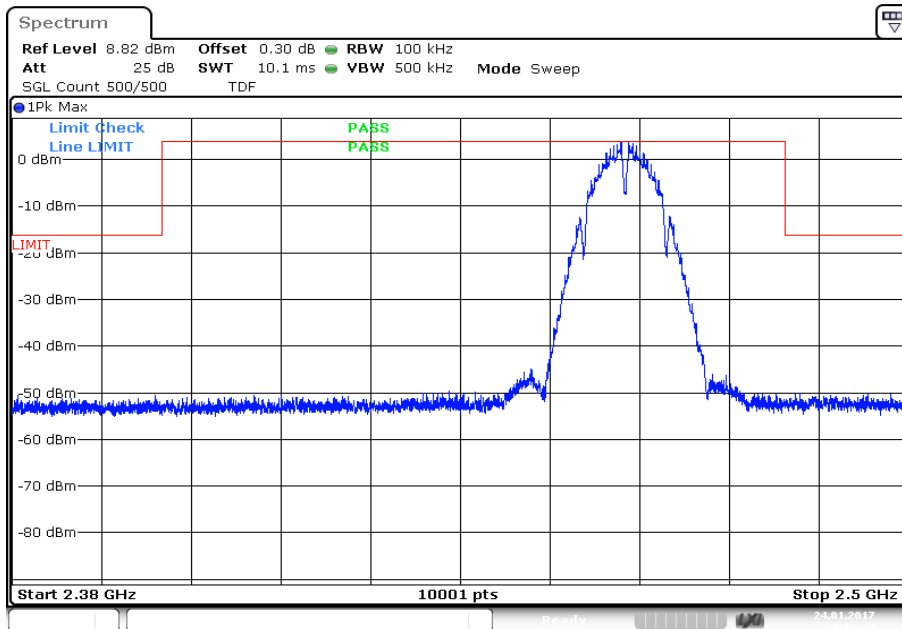

Plots: OFDM / g – mode

Plot 1: Lowest channel, up to 25 GHz

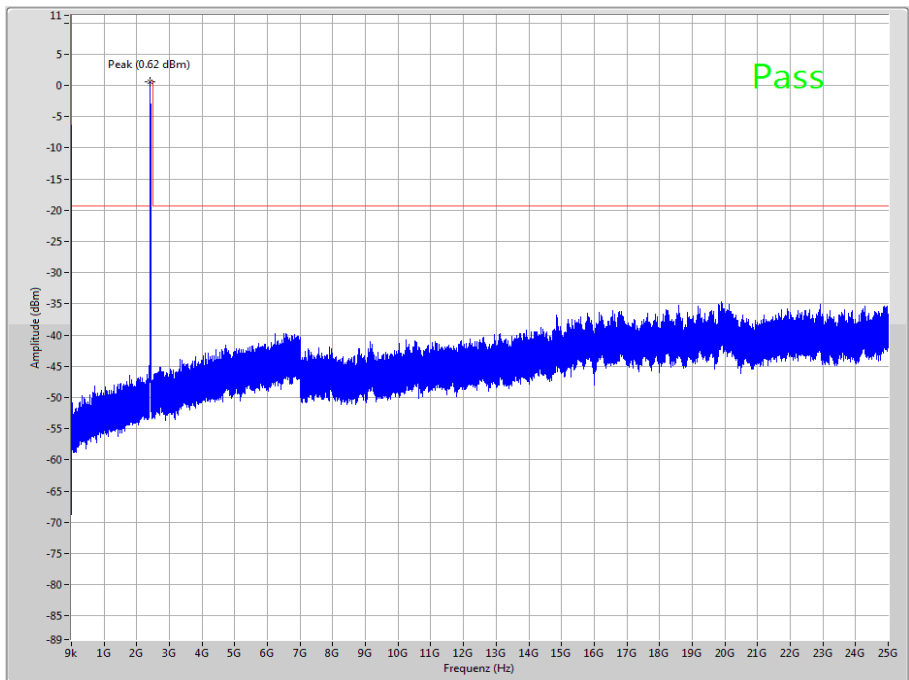

The peak at the beginning of the plot is the LO from the SA.

Plot 2: Lowest channel, zoomed carrier

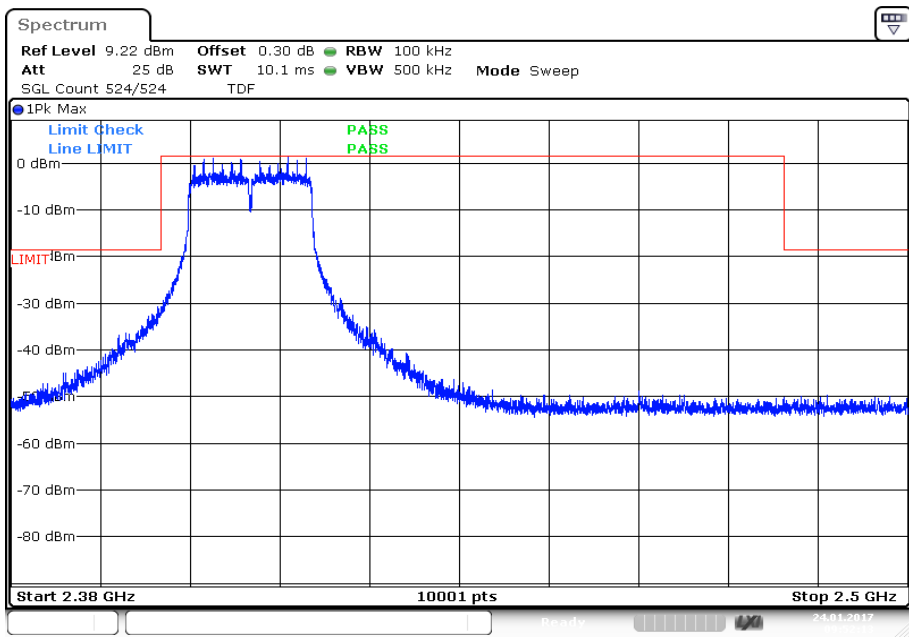

Date: 24.JAN.2017 09:52:13

Plot 3: Middle channel, up to 25 GHz

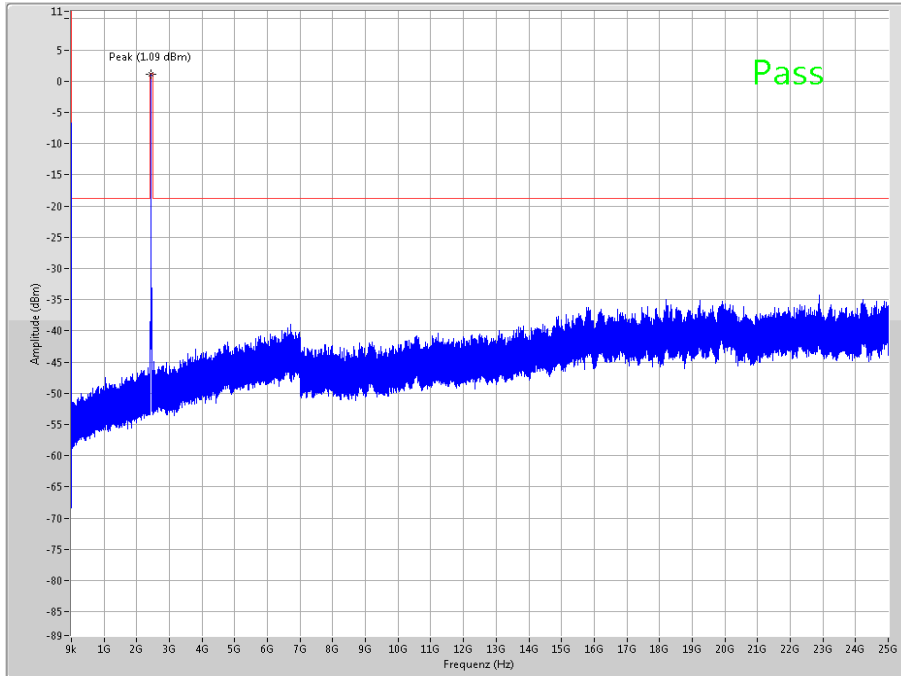

The peak at the beginning of the plot is the LO from the SA.

Plot 4: Middle channel, zoomed carrier

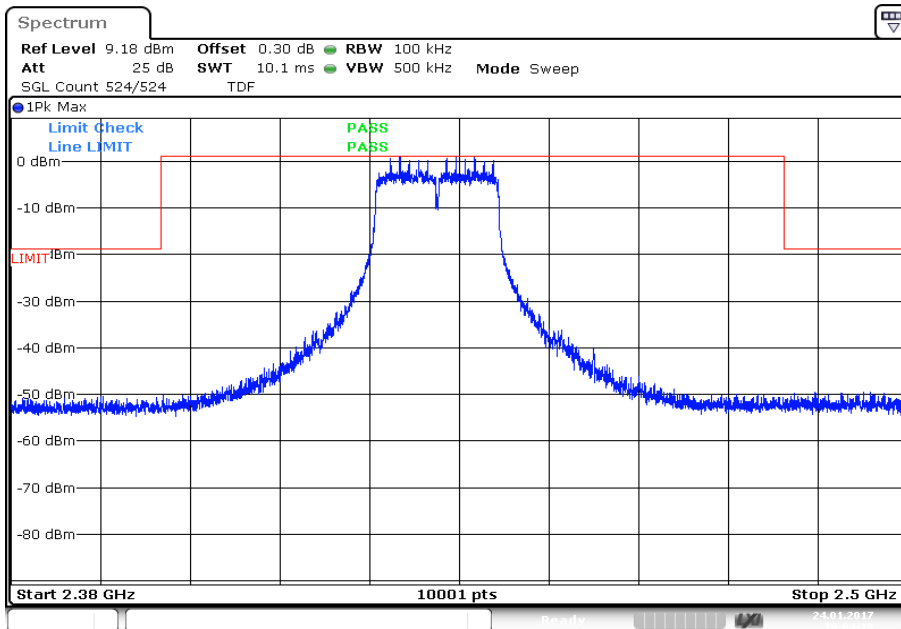

Date: 24.JAN.2017 10:04:16

Plot 5: Highest channel, up to 25 GHz

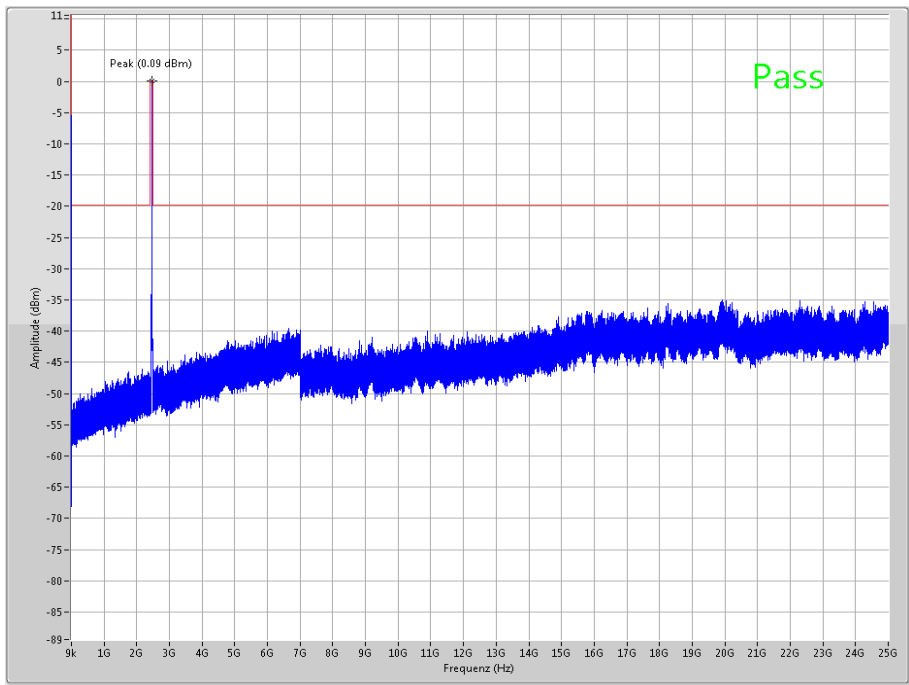

The peak at the beginning of the plot is the LO from the SA.

Plot 6: Highest channel, zoomed carrier

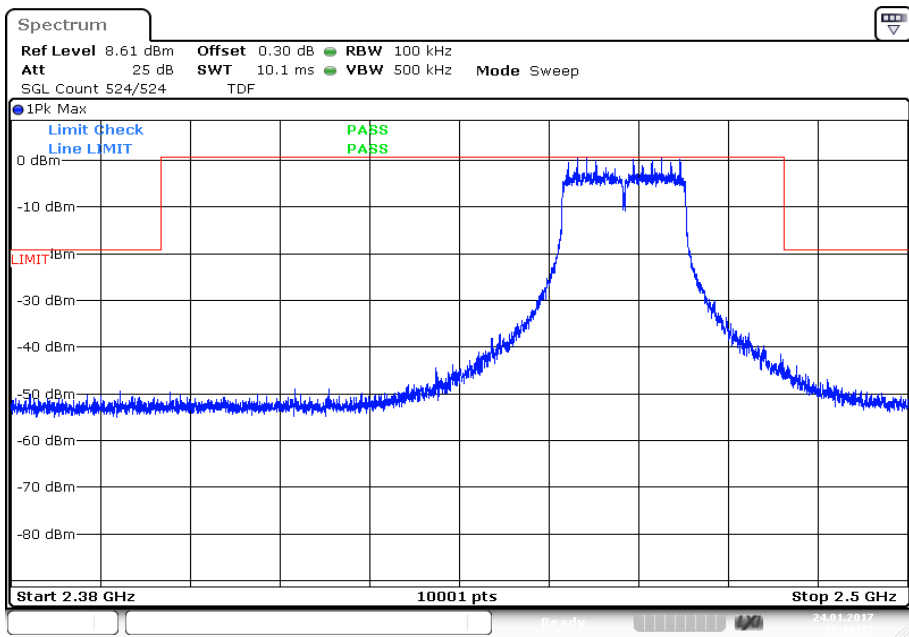

Plots: OFDM / n HT 20 – mode

Plot 1: Lowest channel, up to 25 GHz

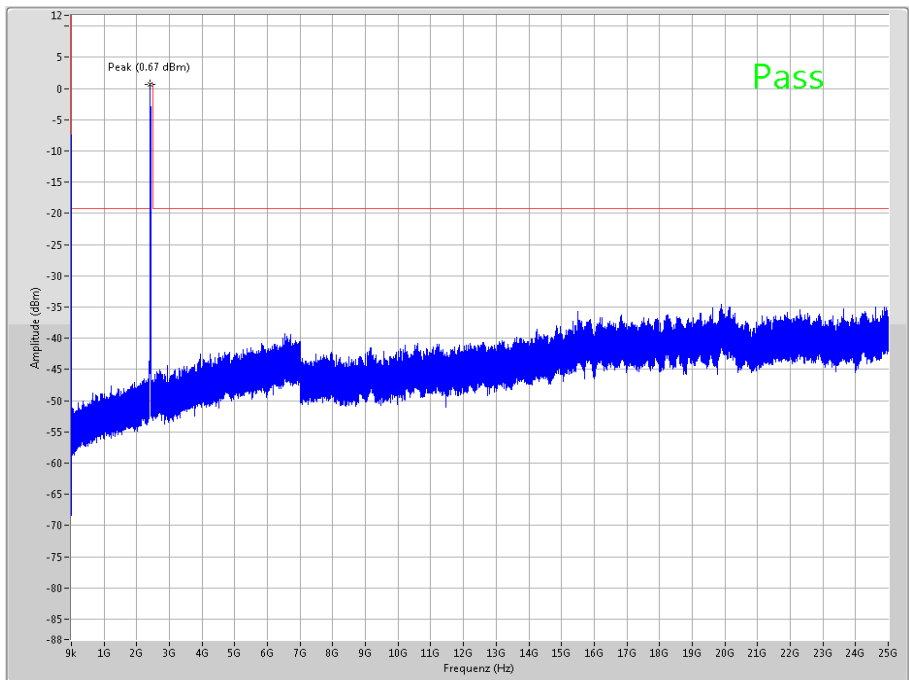

The peak at the beginning of the plot is the LO from the SA.

Plot 2: Lowest channel, zoomed carrier

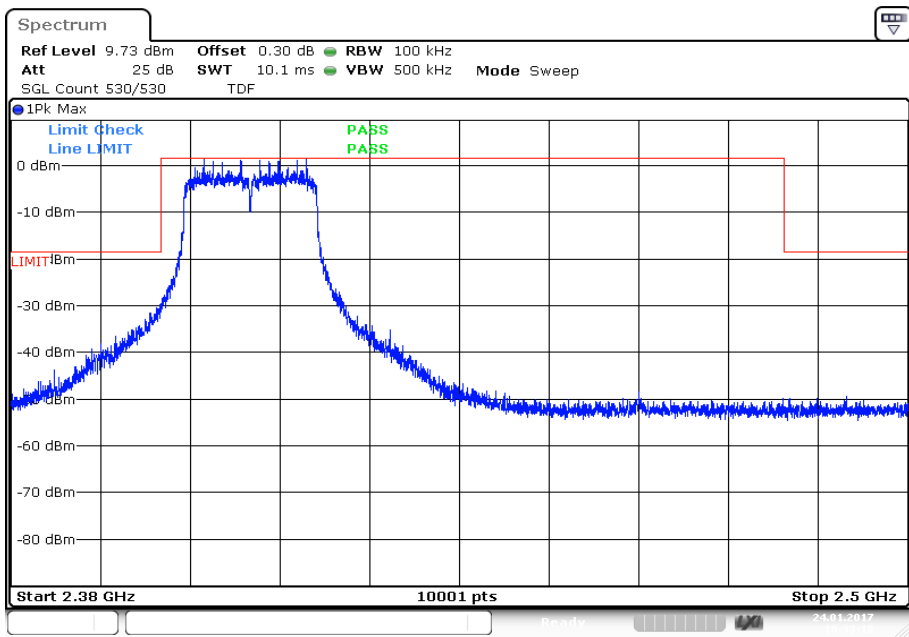

Plot 3: Middle channel, up to 25 GHz

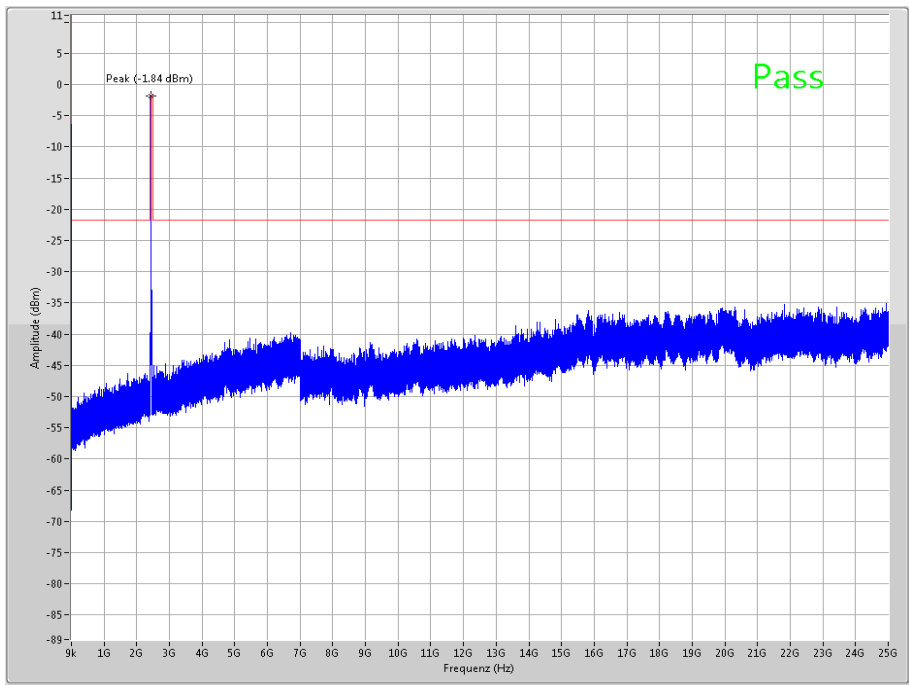

The peak at the beginning of the plot is the LO from the SA.

Plot 4: Middle channel, zoomed carrier

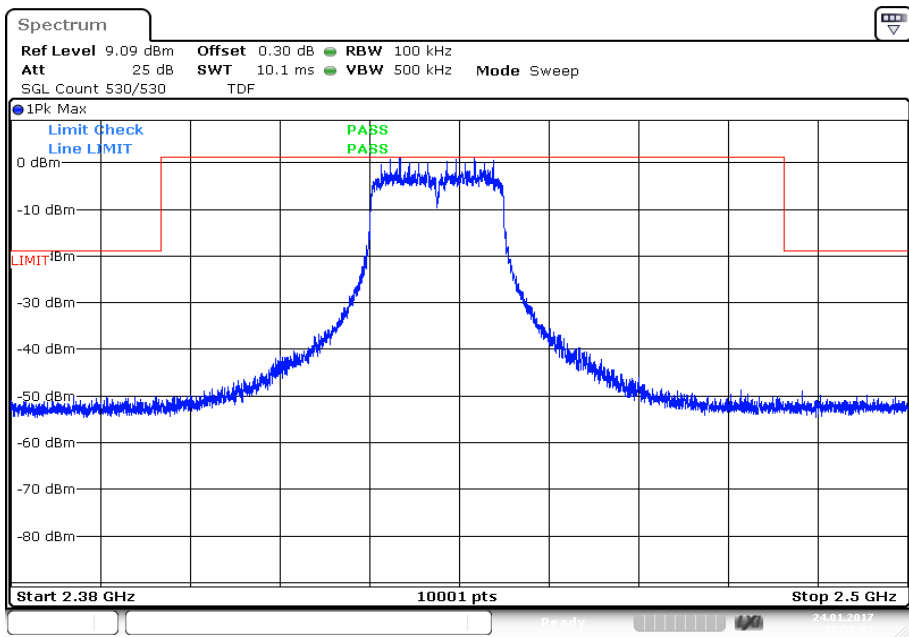

Date: 24.JAN.2017 10:50:08

Plot 5: Highest channel, up to 25 GHz

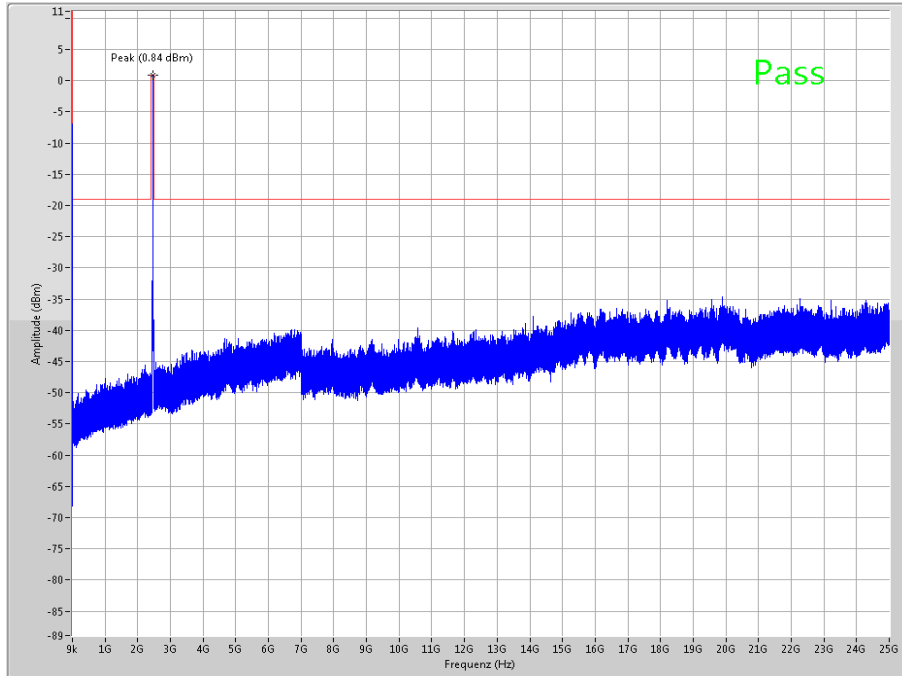

The peak at the beginning of the plot is the LO from the SA.

Plot 6: Highest channel, zoomed carrier

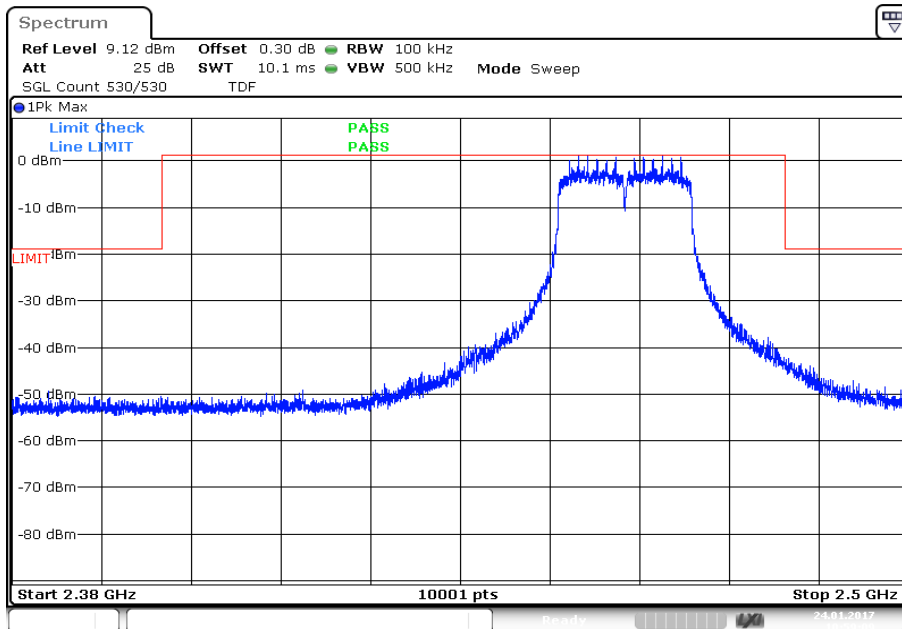

Date: 24.JAN.2017 10:59:09

11.11 Spurious emissions radiated below 30 MHz

Description:

Measurement of the radiated spurious emissions in transmit mode below 30 MHz. The EUT is set to channel 6. This measurement is representative for all channels and modes. If peaks are found channel 1 and channel 11 will be measured too. The measurement is performed with the data rate producing the highest output power. The limits are recalculated to a measurement distance of 3 m with 40 dB/decade according CFR Part 2.

Measurement:

Measurement parameter	
Detector:	Peak / Quasi Peak
Sweep time:	Auto
Resolution bandwidth:	F < 150 kHz: 200 Hz F > 150 kHz: 9 kHz
Video bandwidth:	F < 150 kHz: 1 kHz F > 150 kHz: 100 kHz
Span:	9 kHz to 30 MHz
Trace mode:	Max Hold
Measured modulation	<input checked="" type="checkbox"/> DSSS b – mode <input checked="" type="checkbox"/> OFDM g – mode <input type="checkbox"/> OFDM n HT20 – mode <input type="checkbox"/> OFDM n HT40 – mode
Test setup:	See sub clause 6.2 A
Measurement uncertainty	See sub clause 8

Limits:

FCC		IC
Frequency (MHz)	Field Strength (dBµV/m)	Measurement distance
0.009 – 0.490	2400/F(kHz)	300
0.490 – 1.705	24000/F(kHz)	30
1.705 – 30.0	30	30

Results:

TX Spurious Emissions Radiated < 30 MHz [dBµV/m]		
F [MHz]	Detector	Level [dBµV/m]
All detected peaks are more than 20 dB below the limit.		

Plots: DSSS

Plot 1: 9 kHz to 30 MHz, low channel

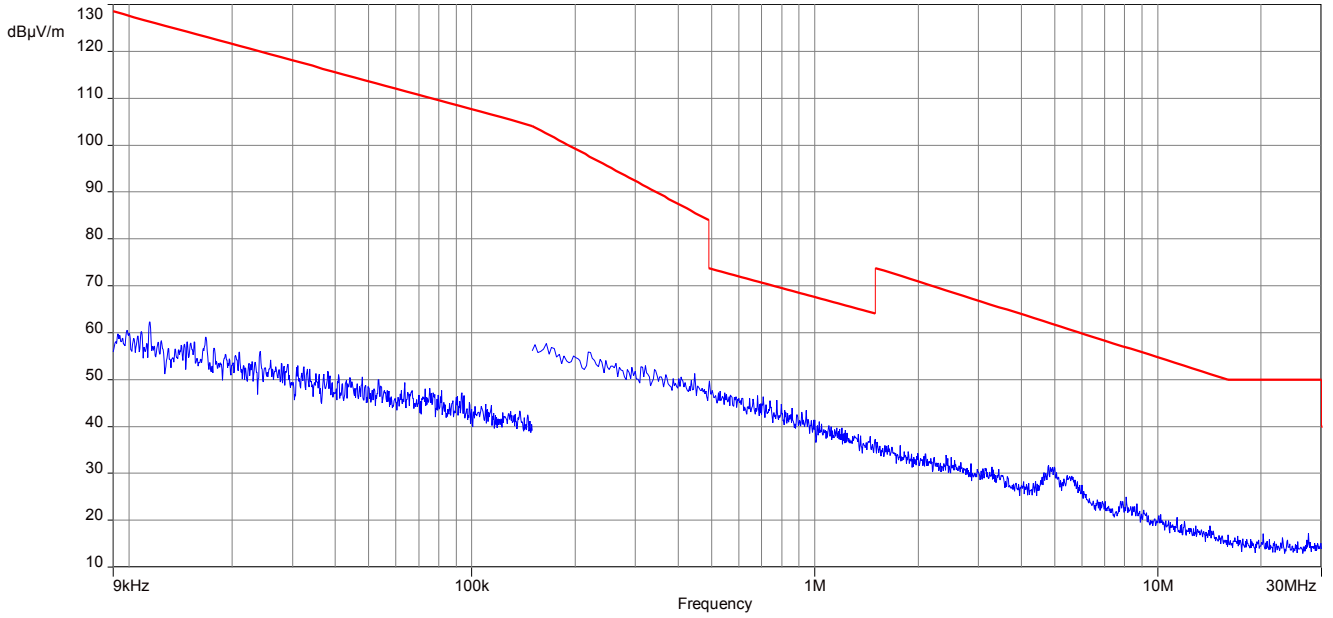

Plot 2: 9 kHz to 30 MHz, mid channel

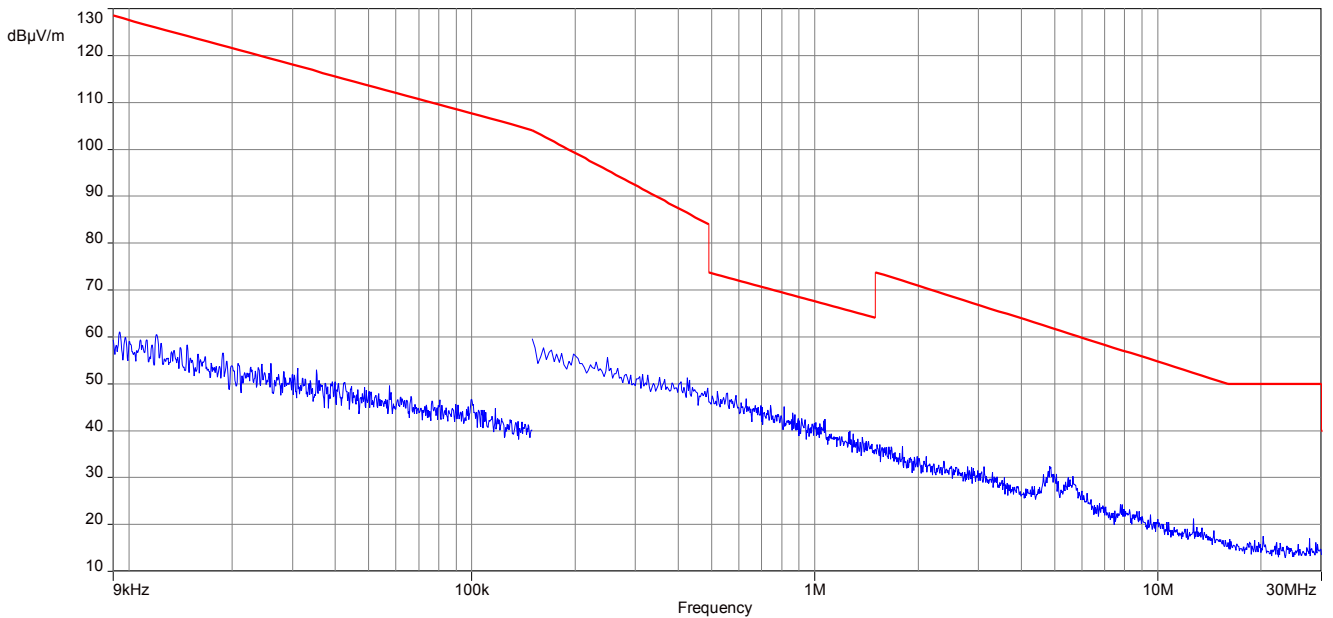

Plot 3: 9 kHz to 30 MHz, high channel

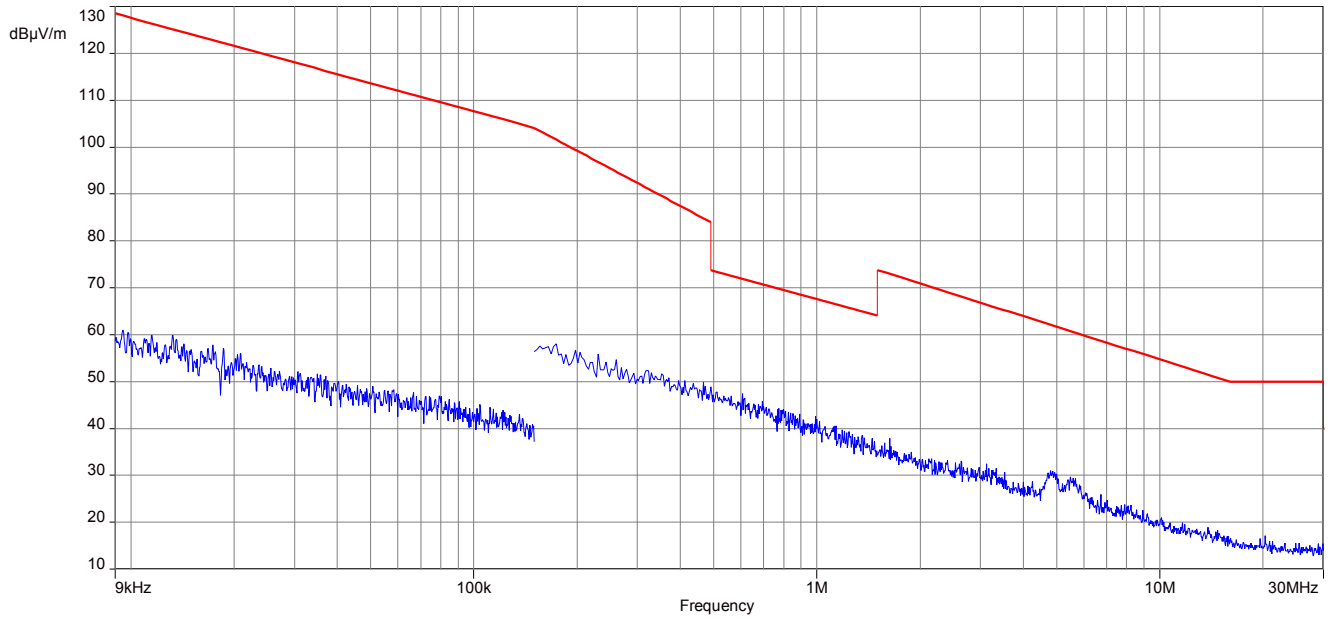

Plots: OFDM (20 MHz bandwidth)

Plot 1: 9 kHz to 30 MHz, low channel

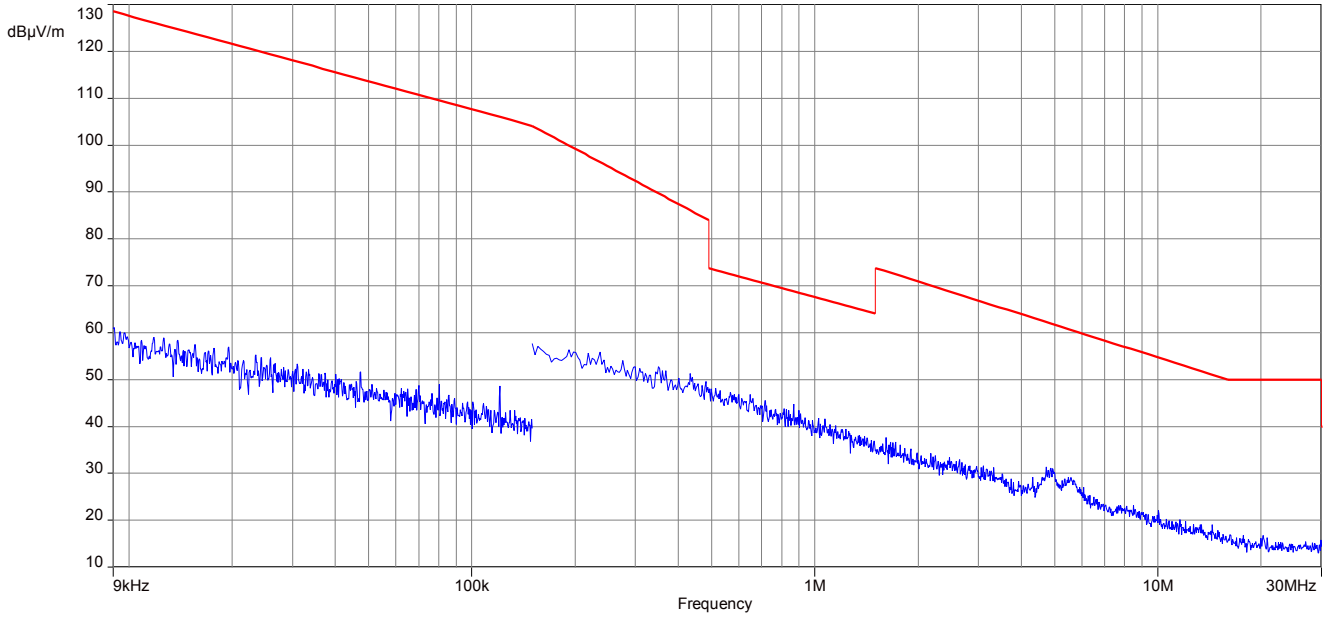

Plot 2: 9 kHz to 30 MHz, mid channel

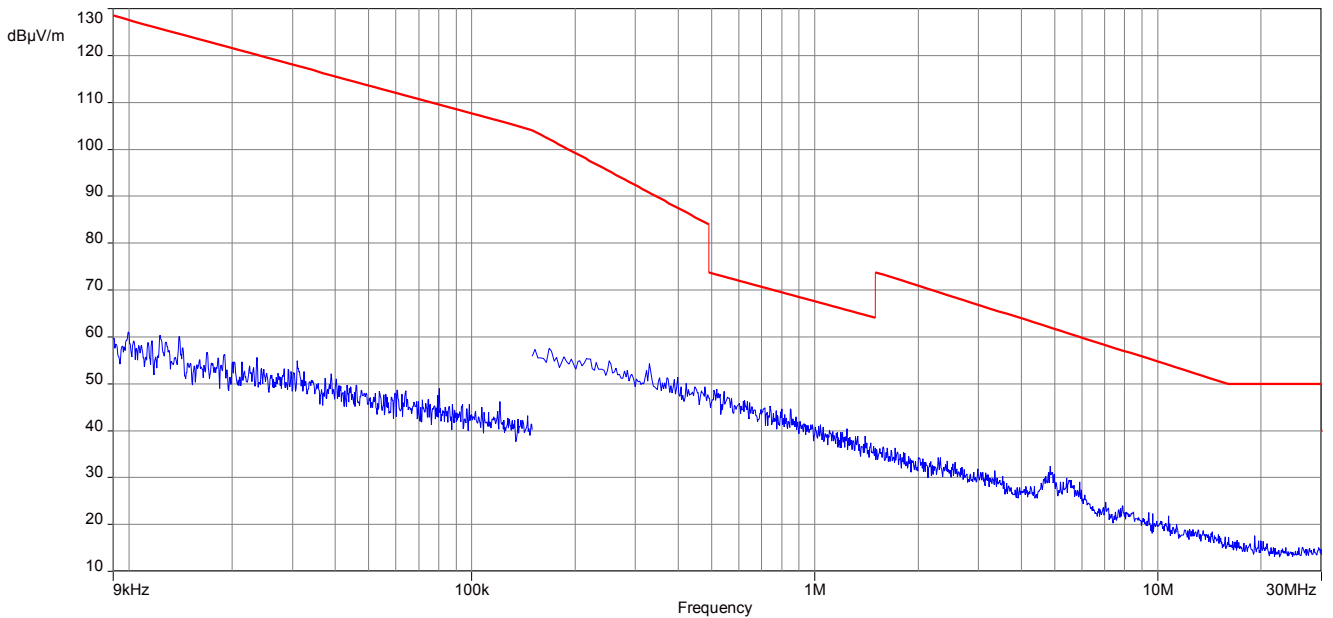

Plot 3: 9 kHz to 30 MHz, high channel

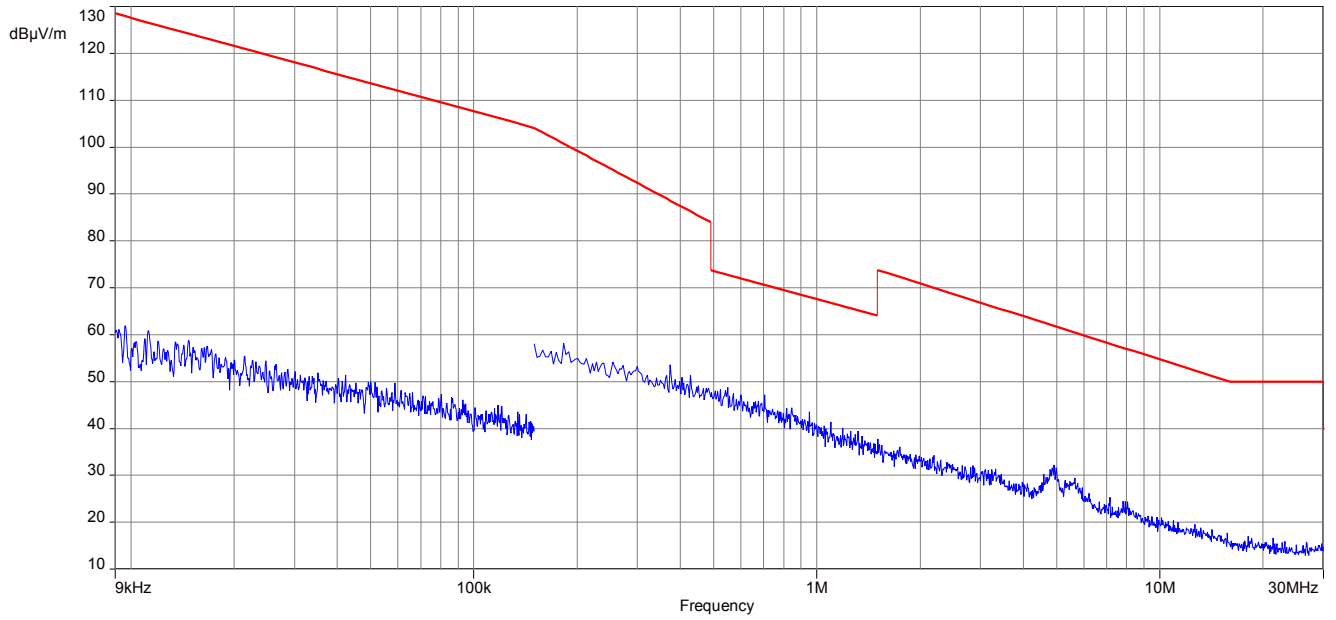

11.12 Spurious emissions radiated 30 MHz to 1 GHz

Description:

Measurement of the radiated spurious emissions and cabinet radiations below 1 GHz.

Measurement:

Measurement parameter	
Detector:	Peak / Quasi Peak
Sweep time:	Auto
Resolution bandwidth:	120 kHz
Video bandwidth:	3 x RBW
Span:	30 MHz to 1 GHz
Trace mode:	Max Hold
Measured modulation	<input checked="" type="checkbox"/> DSSS b – mode <input checked="" type="checkbox"/> OFDM g – mode <input type="checkbox"/> OFDM n HT20 – mode <input type="checkbox"/> OFDM n HT40 – mode <input checked="" type="checkbox"/> RX / Idle – mode
Test setup:	See sub clause 6.1 A
Measurement uncertainty	See sub clause 8

The modulation with the highest output power was used to perform the transmitter spurious emissions. If spurious were detected a re-measurement was performed on the detected frequency with each modulation.

Limits:

FCC		IC
In any 100 kHz bandwidth outside the frequency band in which the spread spectrum or digitally modulated intentional radiator is operating, the radio frequency power that is produced by the intentional radiator shall be at least 20 dB below that in the 100 kHz bandwidth within the band that contains the highest level of the desired power, based on either an RF conducted or a radiated measurement. Attenuation below the general limits specified in Section 15.209(a) is not required. In addition, radiated emissions which fall in the restricted bands, as defined in §15.205(a), must also comply with the radiated emission limits specified in §15.209(a) (see §15.205(c)).		
Frequency (MHz)	Field Strength (dBµV/m)	Measurement distance
30 - 88	30.0	10
88 – 216	33.5	10
216 – 960	36.0	10

Plot: DSSS

Plot 1: 30 MHz to 1 GHz, vertical & horizontal polarization, low channel

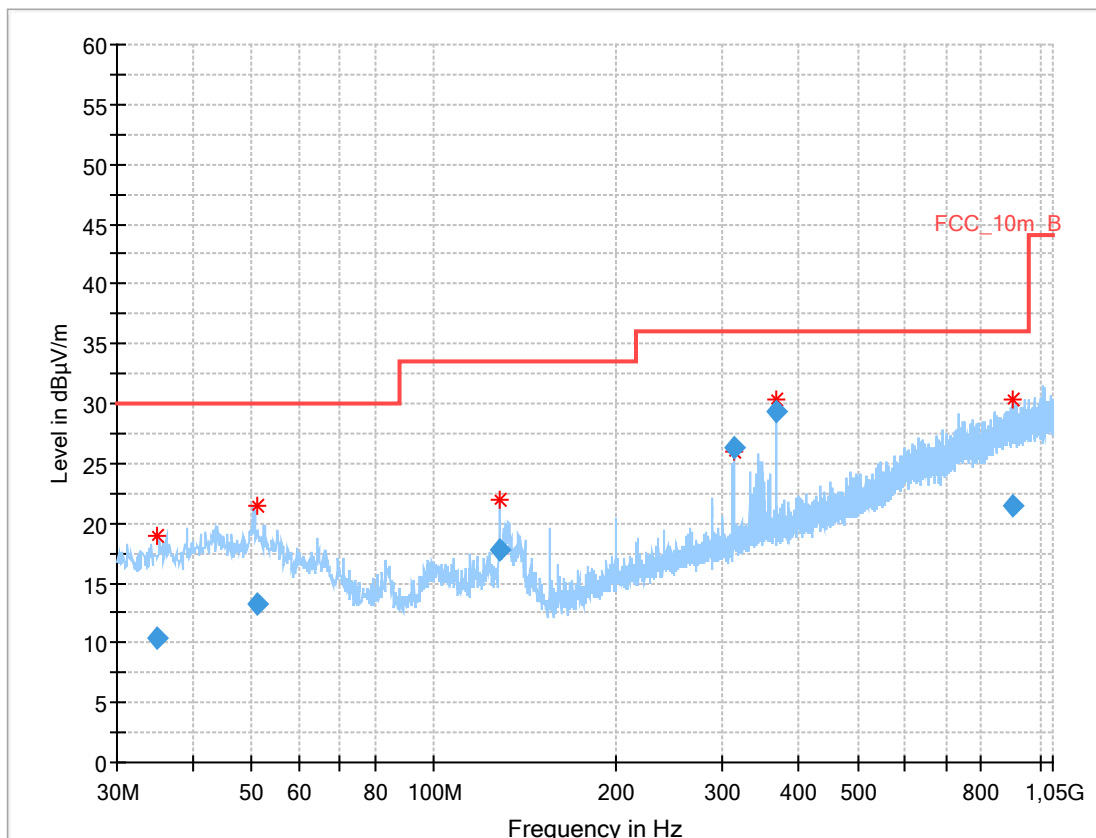

Final_Result:

Frequency (MHz)	QuasiPeak (dBµV/m)	Limit (dBµV/m)	Margin (dB)	Meas. Time (ms)	Bandwidth (kHz)	Height (cm)	Pol	Azimuth (deg)	Corr. (dB)
34.809750	10.34	30.00	19.66	1000.0	120.000	172.0	V	176.0	12.6
50.989200	13.22	30.00	16.78	1000.0	120.000	103.0	V	50.0	13.6
128.514600	17.74	33.50	15.76	1000.0	120.000	100.0	V	41.0	9.7
311.987250	26.34	36.00	9.66	1000.0	120.000	270.0	H	269.0	14.8
368.226150	29.36	36.00	6.64	1000.0	120.000	202.0	H	265.0	16.3
902.878050	21.40	36.00	14.60	1000.0	120.000	200.0	V	140.0	24.2

Plot 2: 30 MHz to 1 GHz, vertical & horizontal polarization, mid channel

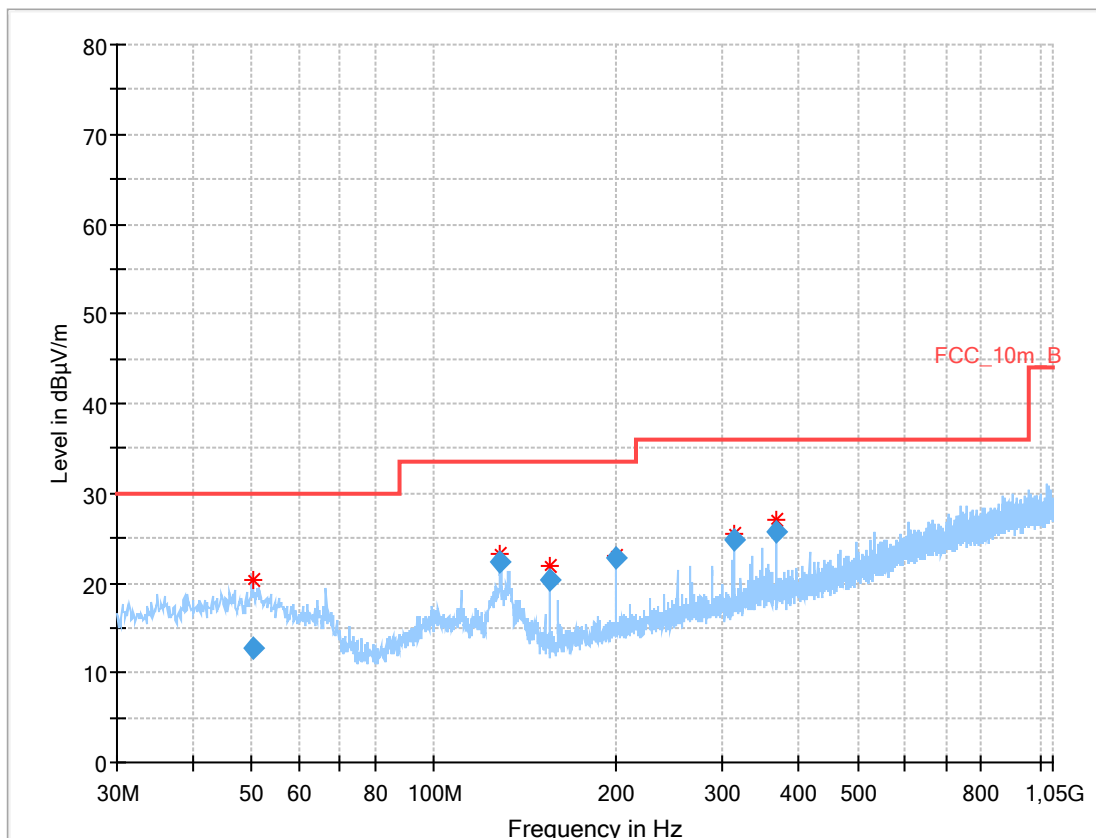

Final_Result:

Frequency (MHz)	QuasiPeak (dBµV/m)	Limit (dBµV/m)	Margin (dB)	Meas. Time (ms)	Bandwidth (kHz)	Height (cm)	Pol	Azimuth (deg)	Corr. (dB)
50.165850	12.65	30.00	17.35	1000.0	120.000	98.0	V	206.0	13.7
128.529150	22.24	33.50	11.26	1000.0	120.000	98.0	V	52.0	9.6
155.172750	20.25	33.50	13.25	1000.0	120.000	98.0	V	128.0	9.5
199.497300	22.87	33.50	10.63	1000.0	120.000	98.0	V	351.0	11.9
311.975550	24.81	36.00	11.19	1000.0	120.000	101.0	V	73.0	14.8
368.223000	25.75	36.00	10.25	1000.0	120.000	98.0	V	321.0	16.3

Plot 3: 30 MHz to 1 GHz, vertical & horizontal polarization, high channel

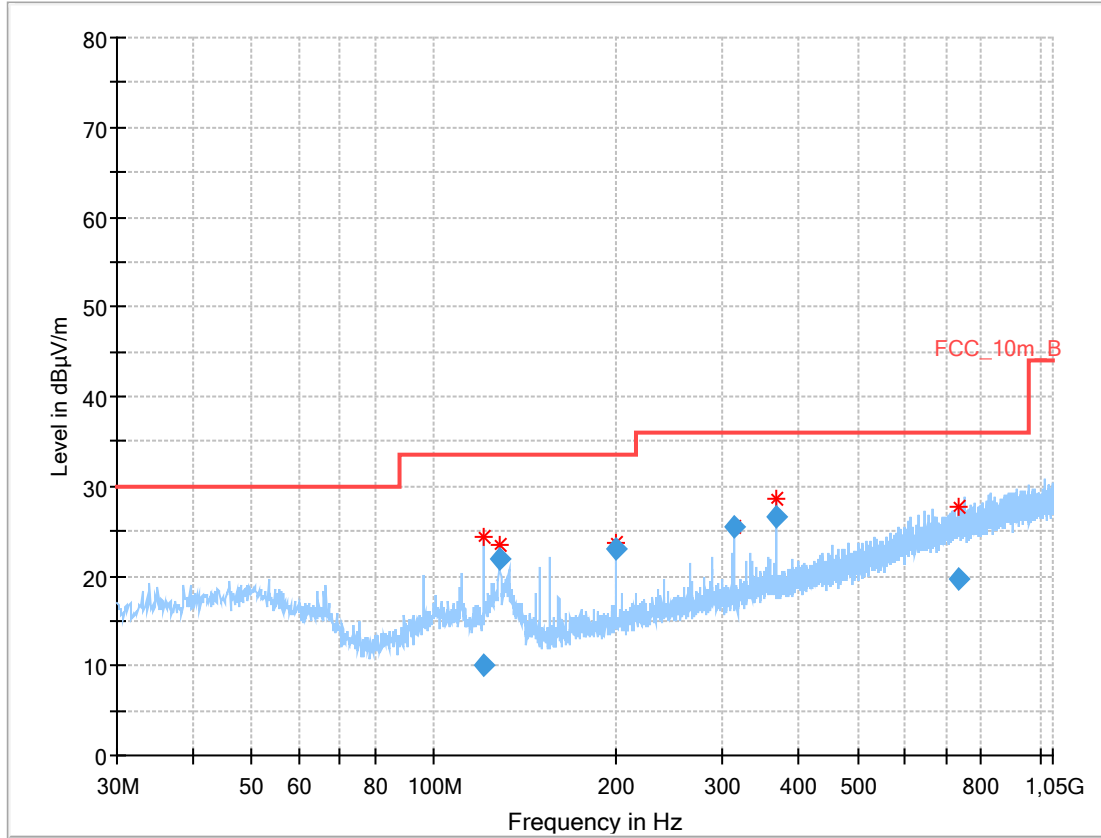

Final_Result:

Frequency (MHz)	QuasiPeak (dBµV/m)	Limit (dBµV/m)	Margin (dB)	Meas. Time (ms)	Bandwidth (kHz)	Height (cm)	Pol	Azimuth (deg)	Corr. (dB)
120.899550	10.02	33.50	23.48	1000.0	120.000	101.0	V	353.0	10.2
128.411550	22.01	33.50	11.49	1000.0	120.000	101.0	V	89.0	9.7
199.492800	22.96	33.50	10.54	1000.0	120.000	98.0	V	353.0	11.9
311.997900	25.50	36.00	10.50	1000.0	120.000	101.0	V	75.0	14.8
368.232000	26.58	36.00	9.42	1000.0	120.000	98.0	V	305.0	16.3
734.859300	19.69	36.00	16.31	1000.0	120.000	178.0	H	17.0	22.4

Plot: OFDM (20 MHz bandwidth)

Plot 1: 30 MHz to 1 GHz, vertical & horizontal polarization, low channel

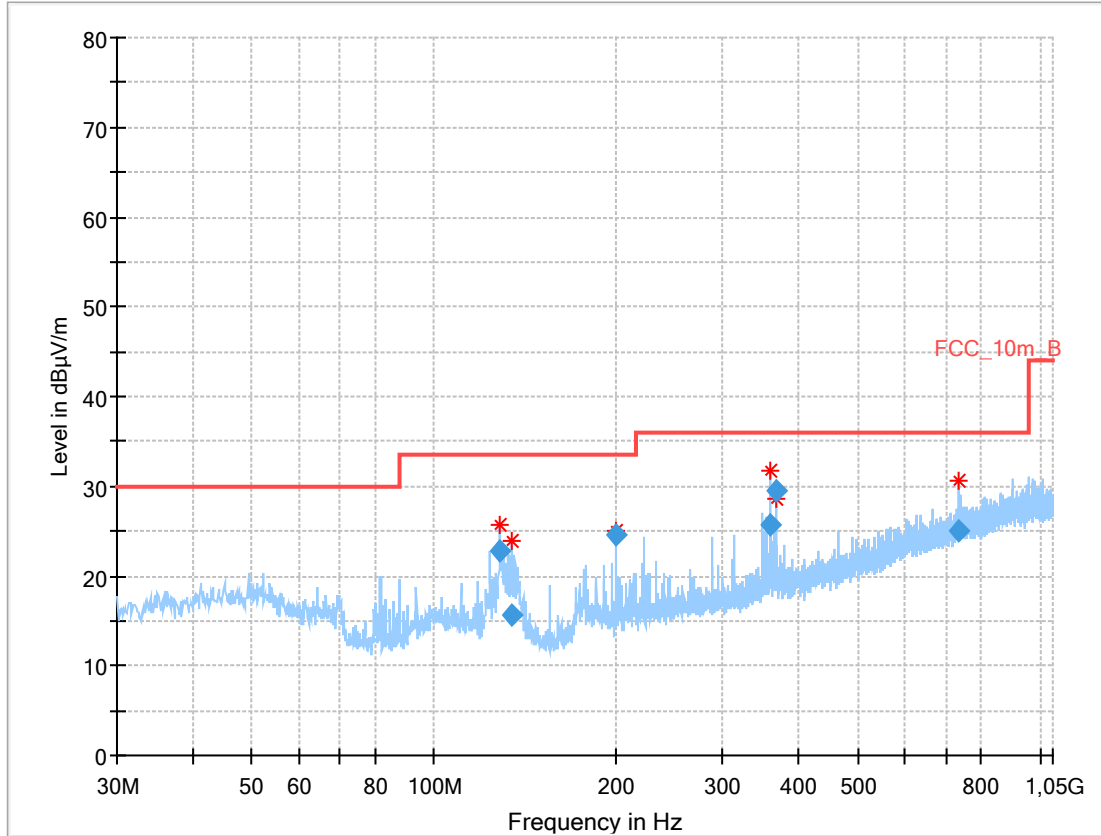

Final_Result:

Frequency (MHz)	QuasiPeak (dBµV/m)	Limit (dBµV/m)	Margin (dB)	Meas. Time (ms)	Bandwidth (kHz)	Height (cm)	Pol	Azimuth (deg)	Corr. (dB)
128.433750	22.80	33.50	10.70	1000.0	120.000	98.0	V	25.0	9.7
134.489850	15.57	33.50	17.93	1000.0	120.000	98.0	V	133.0	9.2
199.492500	24.59	33.50	8.91	1000.0	120.000	98.0	V	202.0	11.9
359.706300	25.61	36.00	10.39	1000.0	120.000	185.0	H	186.0	16.2
368.227500	29.52	36.00	6.48	1000.0	120.000	180.0	H	133.0	16.3
736.488000	25.10	36.00	10.90	1000.0	120.000	98.0	H	202.0	22.4

Plot 2: 30 MHz to 1 GHz, vertical & horizontal polarization, mid channel

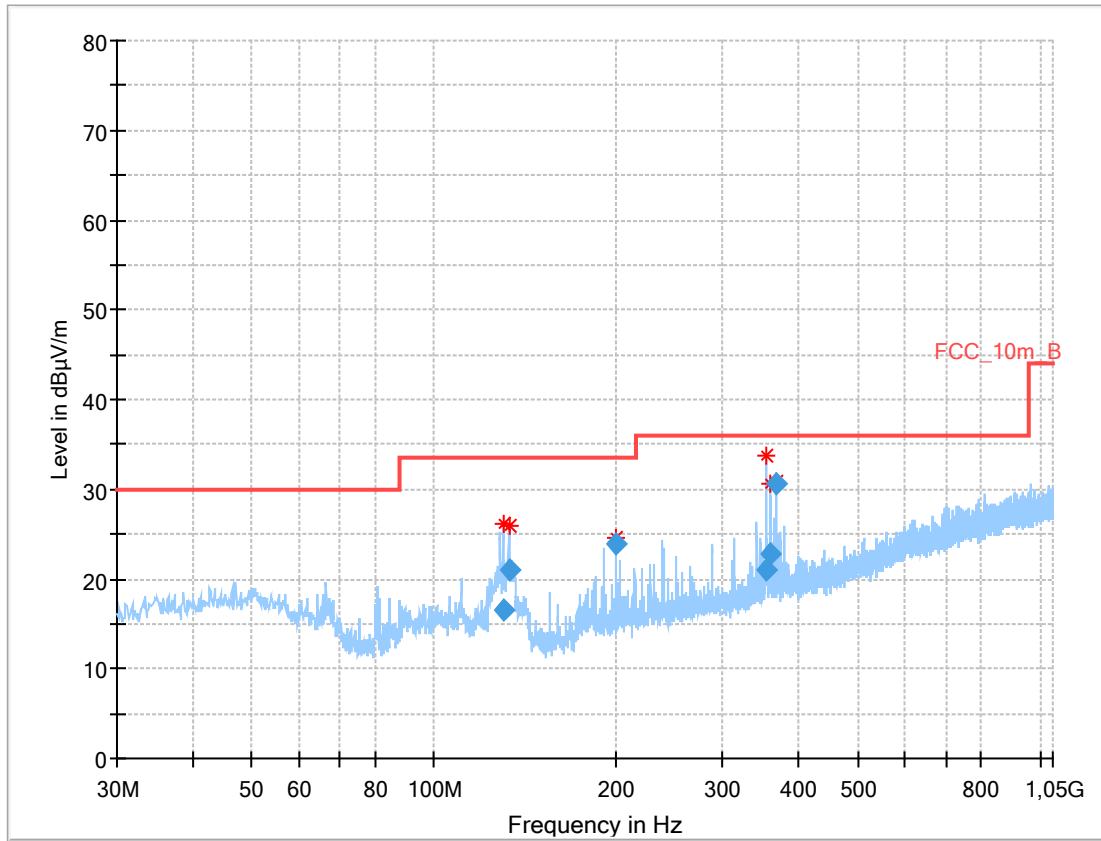

Final_Result:

Frequency (MHz)	QuasiPeak (dBµV/m)	Limit (dBµV/m)	Margin (dB)	Meas. Time (ms)	Bandwidth (kHz)	Height (cm)	Pol	Azimuth (deg)	Corr. (dB)
129.927450	16.58	33.50	16.92	1000.0	120.000	98.0	V	104.0	9.5
132.996300	21.06	33.50	12.44	1000.0	120.000	98.0	V	124.0	9.3
199.495500	23.87	33.50	9.63	1000.0	120.000	98.0	V	353.0	11.9
353.575650	20.91	36.00	15.09	1000.0	120.000	98.0	V	151.0	16.1
359.662200	22.78	36.00	13.22	1000.0	120.000	185.0	V	244.0	16.2
368.221950	30.60	36.00	5.40	1000.0	120.000	98.0	V	328.0	16.3

Plot 3: 30 MHz to 1 GHz, vertical & horizontal polarization, high channel

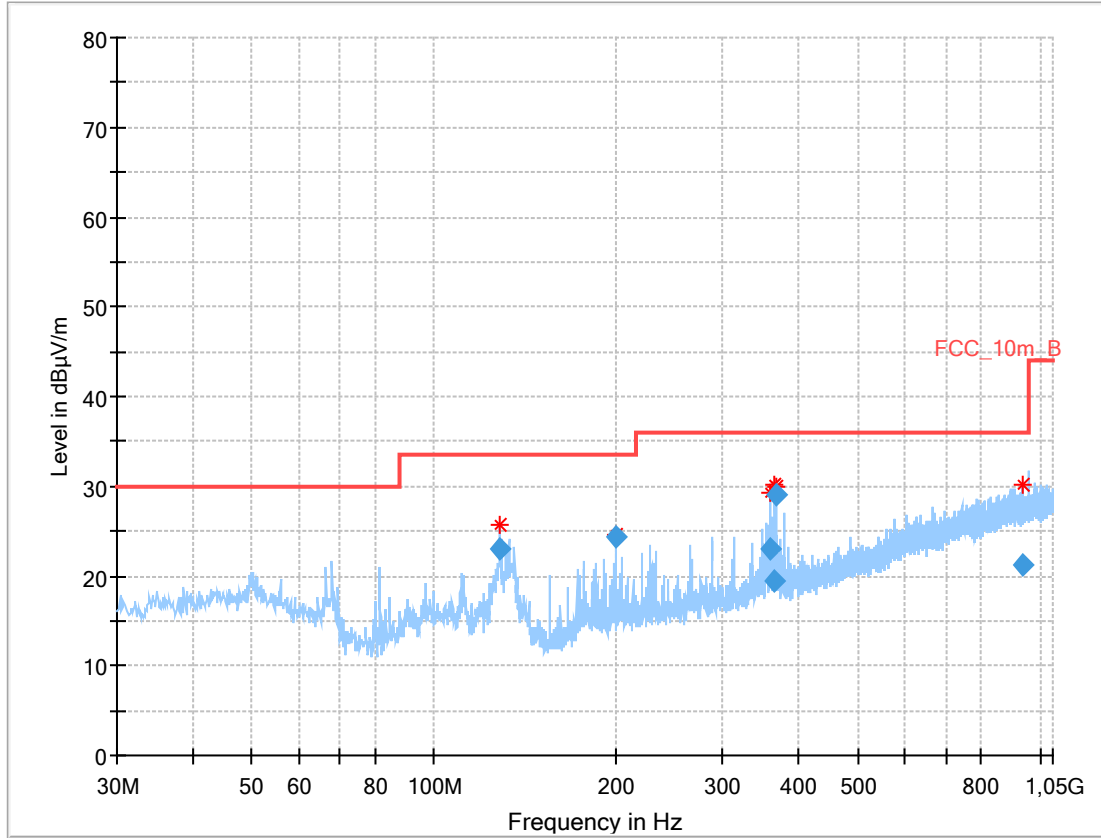

Final_Result:

Frequency (MHz)	QuasiPeak (dBµV/m)	Limit (dBµV/m)	Margin (dB)	Meas. Time (ms)	Bandwidth (kHz)	Height (cm)	Pol	Azimuth (deg)	Corr. (dB)
128.435400	22.96	33.50	10.54	1000.0	120.000	185.0	V	40.0	9.7
199.497600	24.28	33.50	9.22	1000.0	120.000	98.0	V	209.0	11.9
359.786850	23.01	36.00	12.99	1000.0	120.000	98.0	V	5.0	16.2
365.632800	19.45	36.00	16.55	1000.0	120.000	98.0	V	5.0	16.3
368.205450	28.97	36.00	7.03	1000.0	120.000	98.0	V	344.0	16.3
933.713700	21.27	36.00	14.73	1000.0	120.000	185.0	H	337.0	24.3

Plot: RX / Idle mode

Plot 1: 30 MHz to 1 GHz, vertical & horizontal polarization

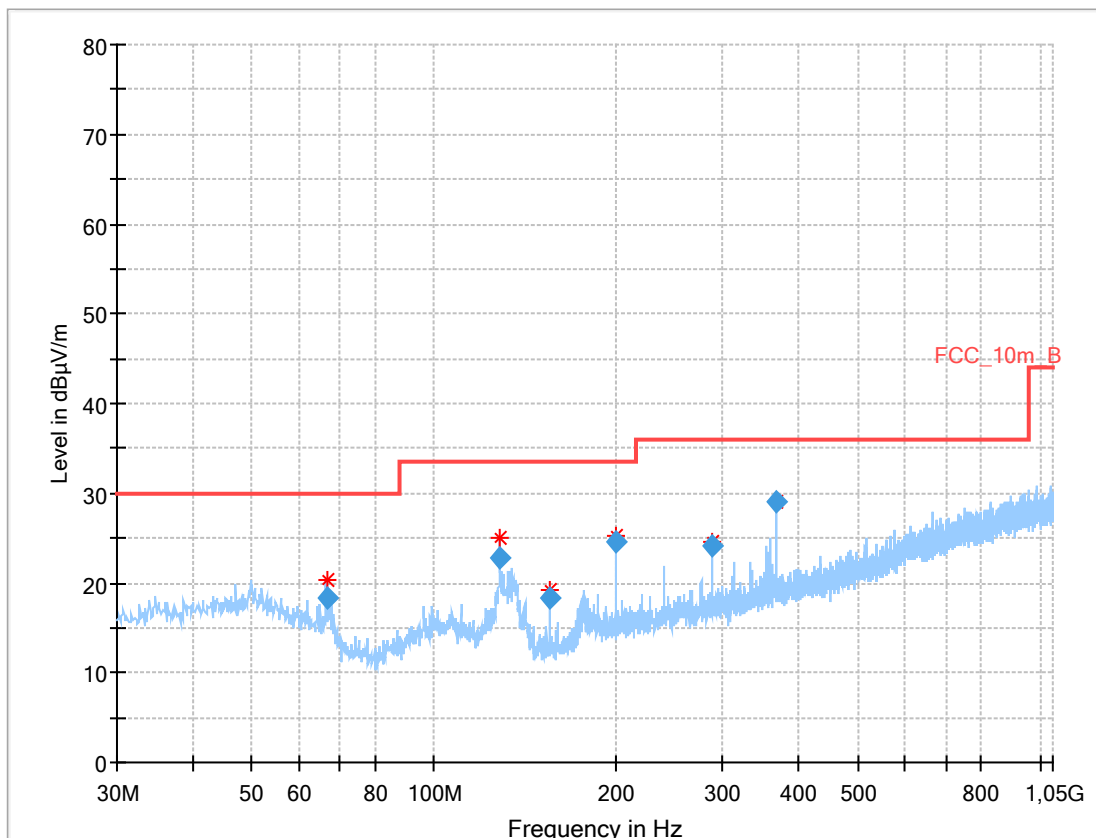

Final_Result:

Frequency (MHz)	QuasiPeak (dBµV/m)	Limit (dBµV/m)	Margin (dB)	Meas. Time (ms)	Bandwidth (kHz)	Height (cm)	Pol	Azimuth (deg)	Corr. (dB)
66.508050	18.30	30.00	11.70	1000.0	120.000	178.0	V	322.0	10.4
128.409750	22.88	33.50	10.62	1000.0	120.000	101.0	V	7.0	9.7
155.152500	18.37	33.50	15.13	1000.0	120.000	98.0	V	138.0	9.5
199.491300	24.64	33.50	8.86	1000.0	120.000	98.0	V	165.0	11.9
288.011550	24.05	36.00	11.95	1000.0	120.000	101.0	V	231.0	14.2
368.232600	29.07	36.00	6.93	1000.0	120.000	98.0	V	353.0	16.3

11.13 Spurious emissions radiated above 1 GHz

Description:

Measurement of the radiated spurious emissions above 1 GHz in transmit mode and receiver / idle mode.

Measurement:

Measurement parameter	
Detector:	Peak / RMS
Sweep time:	Auto
Resolution bandwidth:	1 MHz
Video bandwidth:	3 x RBW
Span:	1 GHz to 26 GHz
Trace mode:	Max Hold
Measured modulation	<input checked="" type="checkbox"/> DSSS b – mode <input checked="" type="checkbox"/> OFDM g – mode <input type="checkbox"/> OFDM n HT20 – mode <input type="checkbox"/> OFDM n HT40 – mode <input checked="" type="checkbox"/> RX / Idle – mode
Test setup:	See sub clause 6.2 B
Measurement uncertainty	See sub clause 8

Limits:

FCC	IC	
In any 100 kHz bandwidth outside the frequency band in which the spread spectrum or digitally modulated intentional radiator is operating, the radio frequency power that is produced by the intentional radiator shall be at least 30 dB below that in the 100 kHz bandwidth within the band that contains the highest level of the desired power, based on either an RF conducted or a radiated measurement. Attenuation below the general limits specified in Section 15.209(a) is not required. In addition, radiated emissions which fall in the restricted bands, as defined in §15.205(a), must also comply with the radiated emission limits specified in §15.209(a) (see §15.205(c)).		
Frequency (MHz)	Field Strength (dBµV/m)	Measurement distance (m)
Above 960	54.0	3

Results: DSSS

TX Spurious Emissions Radiated [dBµV/m]								
2412 MHz			2437 MHz			2462 MHz		
F [MHz]	Detector	Level [dBµV/m]	F [MHz]	Detector	Level [dBµV/m]	F [MHz]	Detector	Level [dBµV/m]
2324	Peak	47.2	4874	Peak	49.4	4924	Peak	50.0
	AVG	-/-		AVG	-/-		AVG	-/-
2368	Peak	47.6	-/-	Peak	-/-	-/-	Peak	-/-
	AVG	-/-		AVG	-/-		AVG	-/-
4824	Peak	49.2	-/-	Peak	-/-	-/-	Peak	-/-
	AVG	-/-		AVG	-/-		AVG	-/-

Results: OFDM (20 MHz bandwidth)

TX Spurious Emissions Radiated [dBµV/m]								
2412 MHz			2437 MHz			2462 MHz		
F [MHz]	Detector	Level [dBµV/m]	F [MHz]	Detector	Level [dBµV/m]	F [MHz]	Detector	Level [dBµV/m]
4824	Peak	51.2	4874	Peak	49.6	4924	Peak	48.8
	AVG	-/-		AVG	-/-		AVG	-/-
-/-	Peak	-/-	-/-	Peak	-/-	-/-	Peak	-/-
	AVG	-/-		AVG	-/-		AVG	-/-

Results: RX / idle – mode

TX Spurious Emissions Radiated [dBµV/m]		
F [MHz]	Detector	Level [dBµV/m]
All detected emissions are more than 20 dB below the limit.		
-/-	Peak	-/-
	AVG	-/-
-/-	Peak	-/-
	AVG	-/-

Plots: DSSS

Plot 1: Lowest channel, 1 GHz to 18 GHz, vertical & horizontal polarization

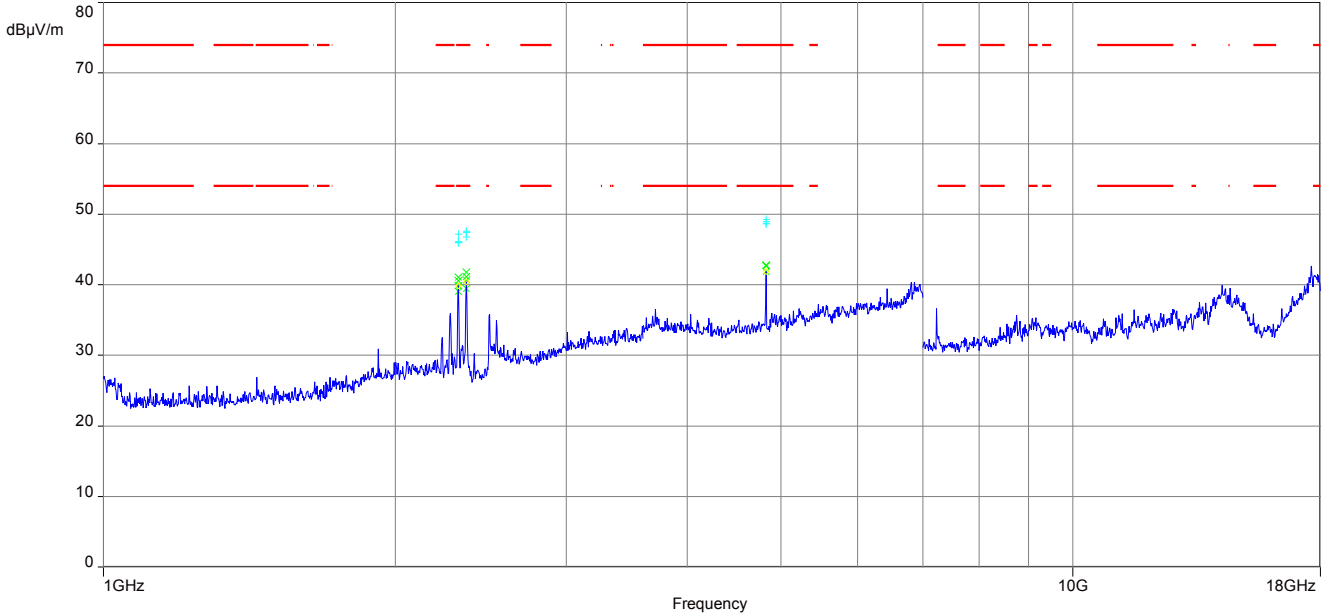

The carrier signal is notched with a 2.4 GHz band rejection filter.

Plot 2: Lowest channel, 18 GHz to 26 GHz, vertical & horizontal polarization

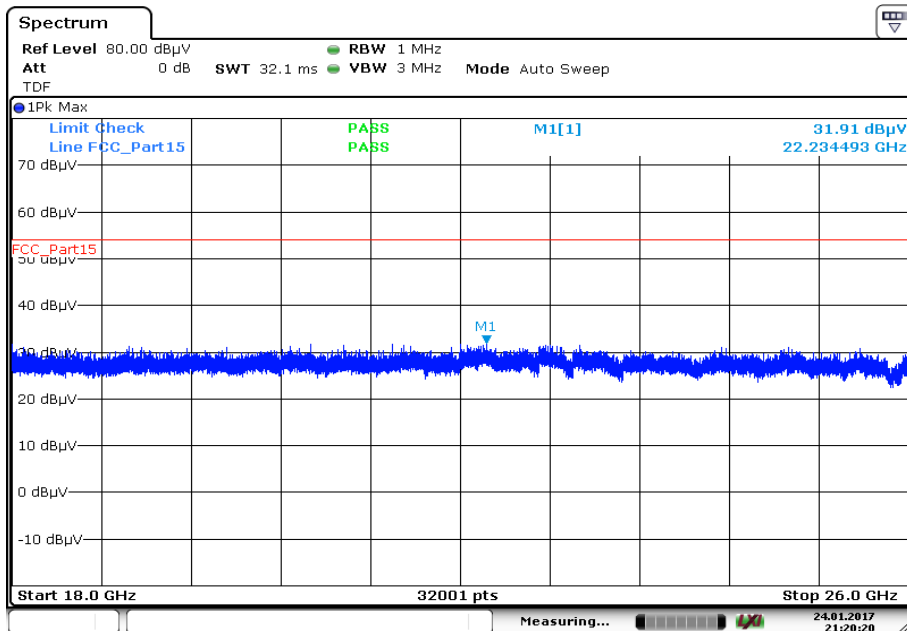

Date: 24.JAN.2017 21:20:19

Plot 3: Middle channel, 1 GHz to 18 GHz, vertical & horizontal polarization

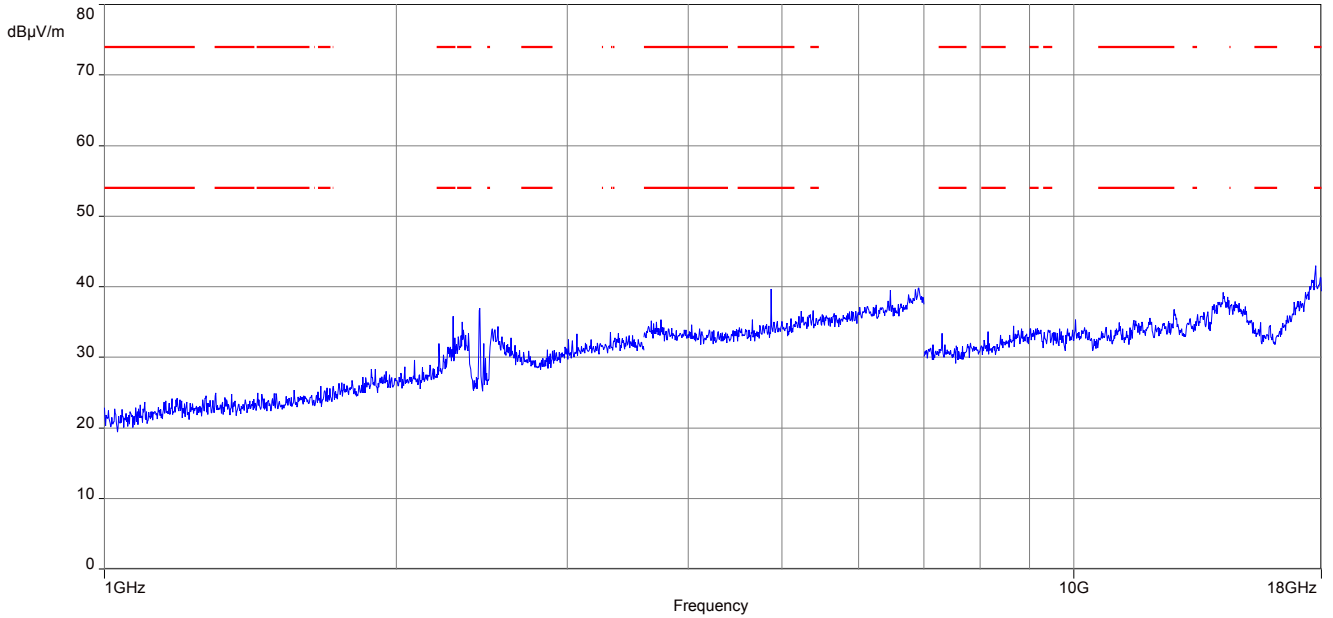

The carrier signal is notched with a 2.4 GHz band rejection filter.

Plot 4: Middle channel, 18 GHz to 26 GHz, vertical & horizontal polarization

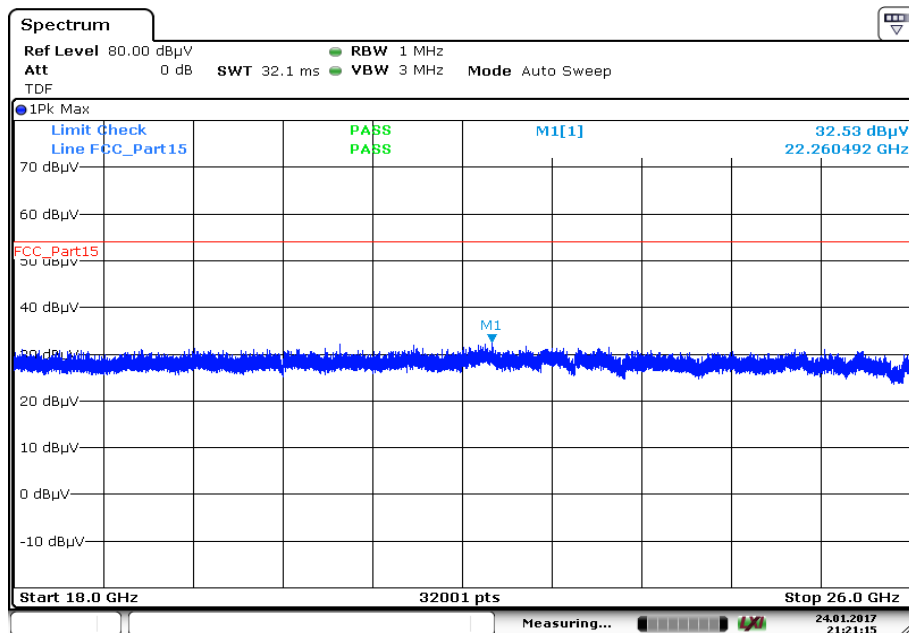

Date: 24.JAN.2017 21:21:16

Plot 5: Highest channel, 1 GHz to 18 GHz, vertical & horizontal polarization

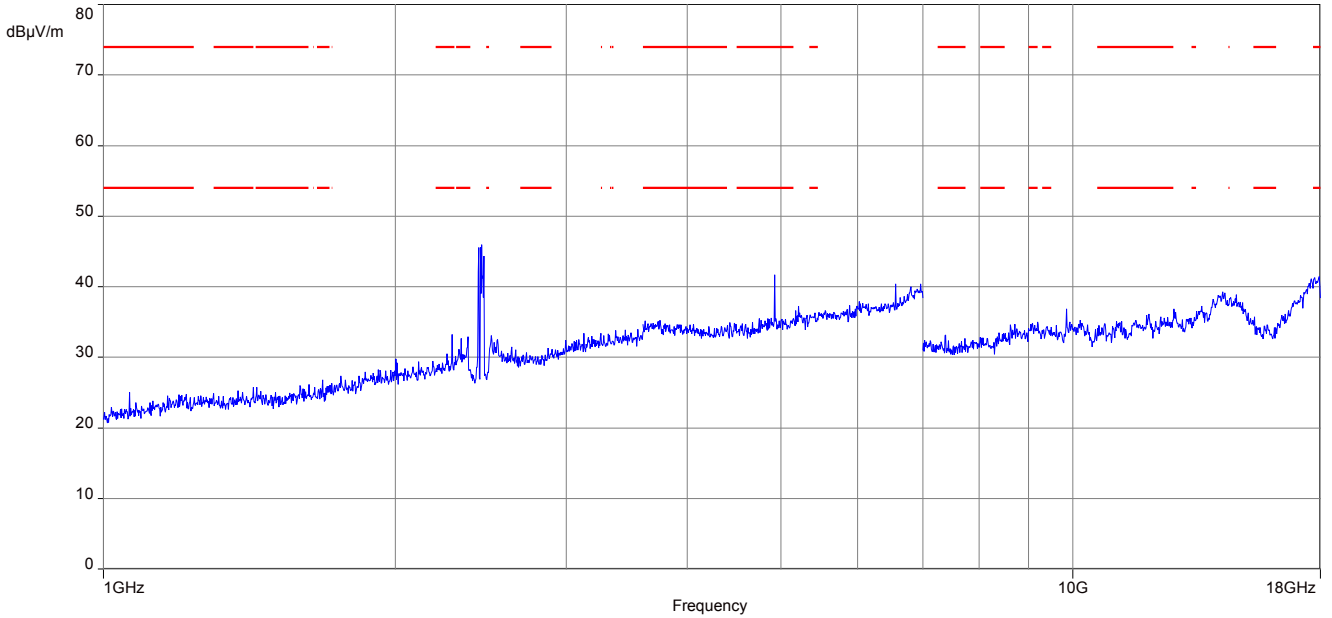

The carrier signal is notched with a 2.4 GHz band rejection filter.

Plot 6: Highest channel, 18 GHz to 26 GHz, vertical & horizontal polarization

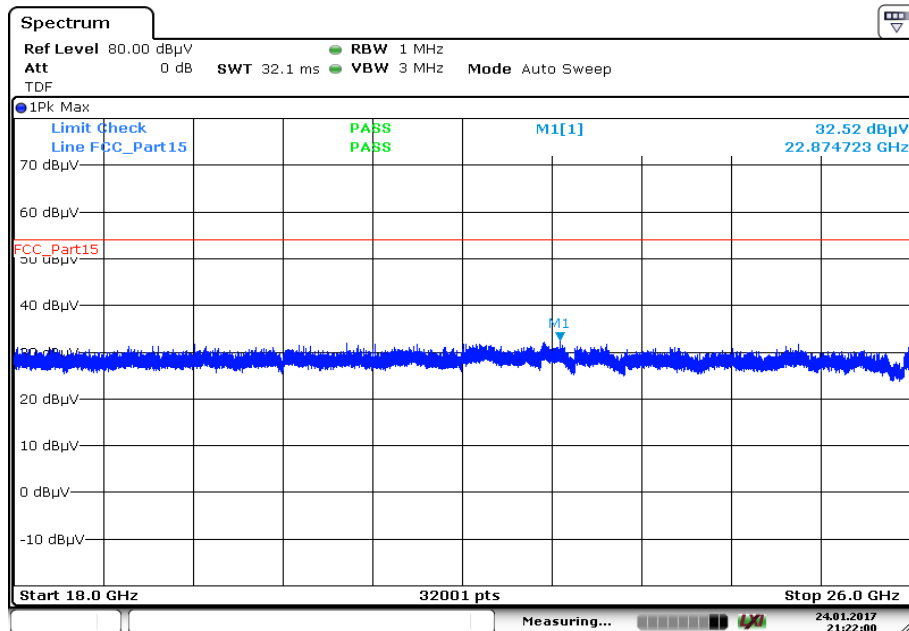

Plots: OFDM (20 MHz bandwidth)

Plot 1: Lowest channel, 1 GHz to 18 GHz, vertical & horizontal polarization

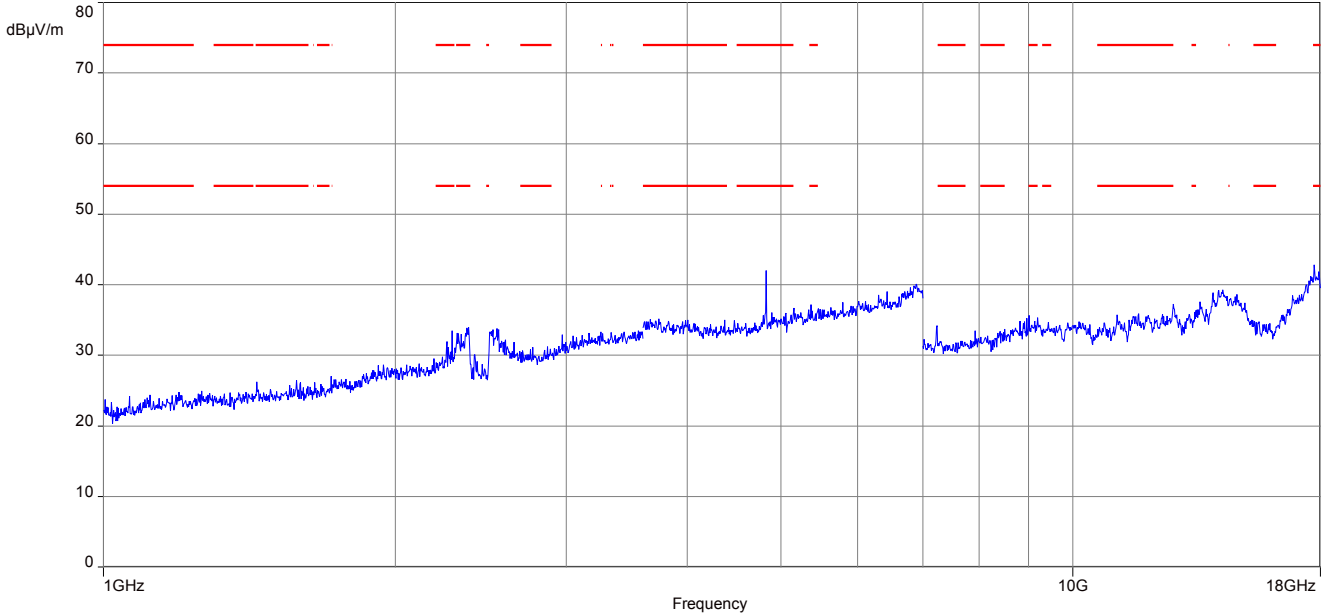

The carrier signal is notched with a 2.4 GHz band rejection filter.

Plot 2: Lowest channel, 18 GHz to 26 GHz, vertical & horizontal polarization

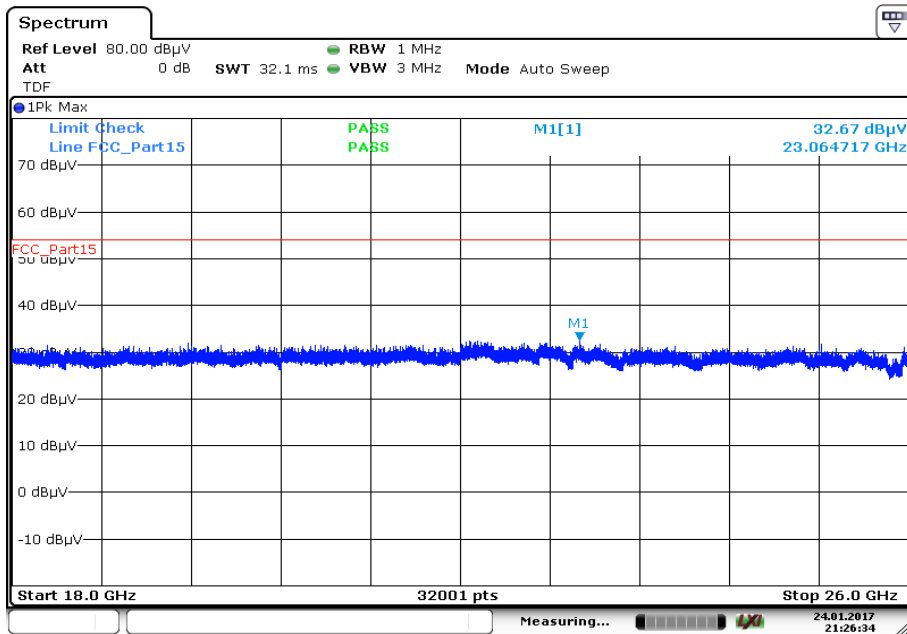

Date: 24.JAN.2017 21:26:34

Plot 3 Middle channel, 1 GHz to 18 GHz, vertical & horizontal polarization

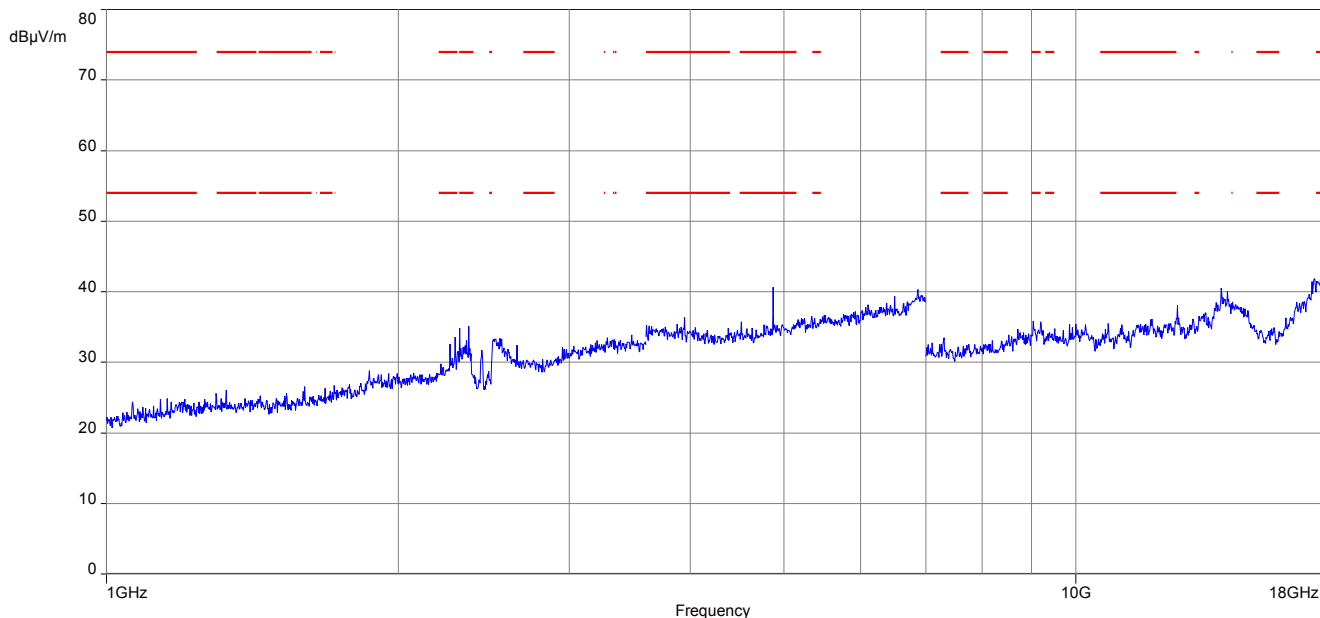

The carrier signal is notched with a 2.4 GHz band rejection filter.

Plot 4: Middle channel, 18 GHz to 26 GHz, vertical & horizontal polarization

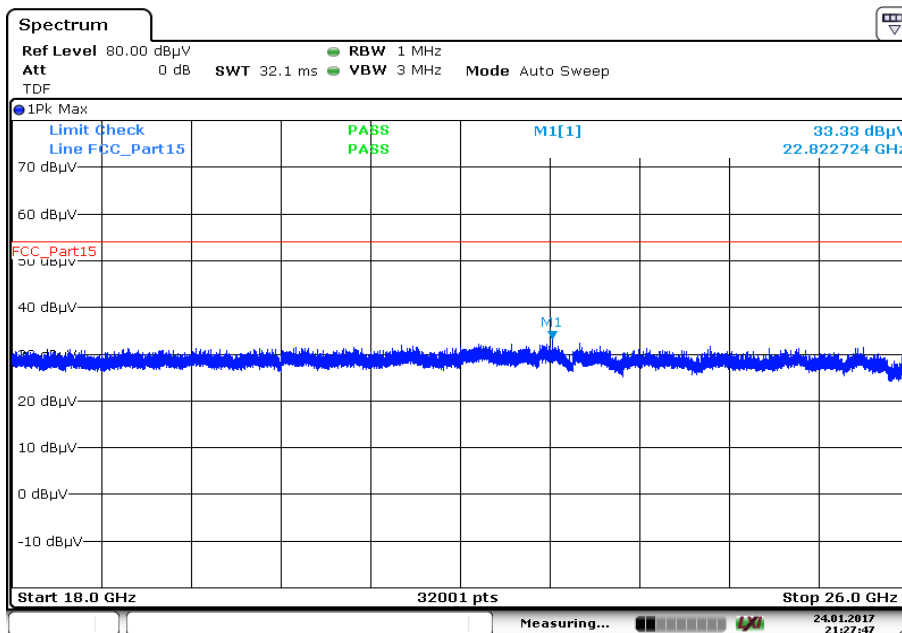

Date: 24.JAN.2017 21:27:47

Plot 5: Highest channel, 1 GHz to 18 GHz, vertical & horizontal polarization

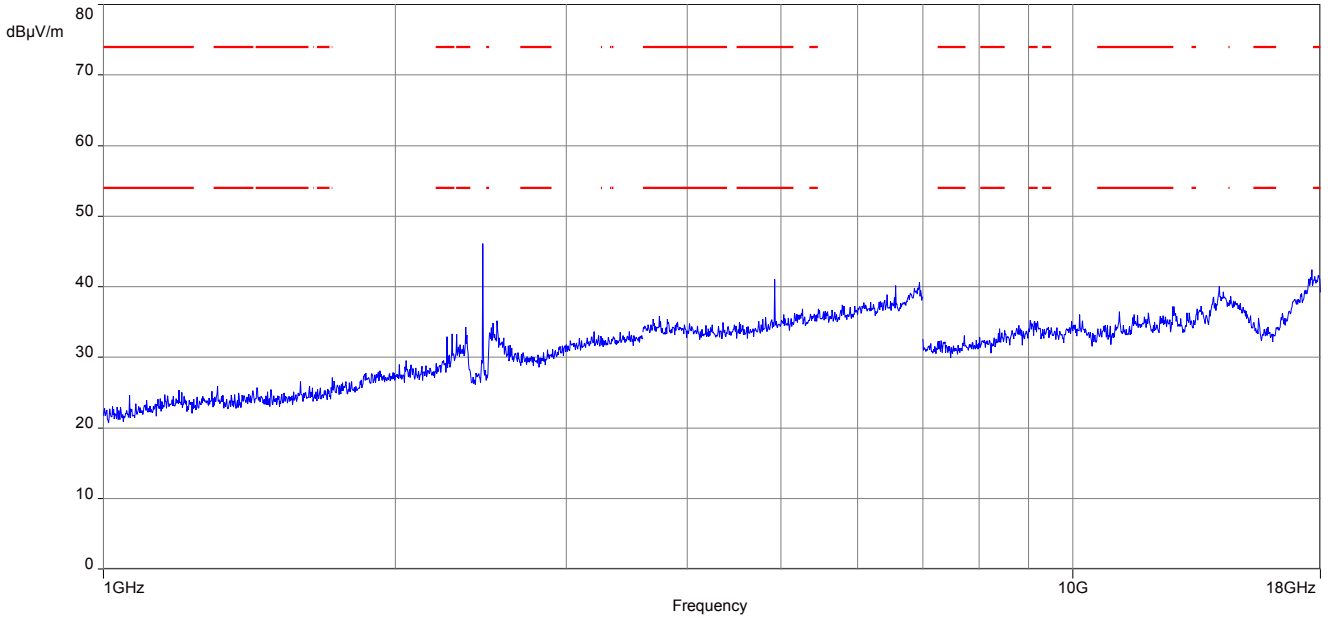

The carrier signal is notched with a 2.4 GHz band rejection filter.

Plot 6: Highest channel, 18 GHz to 26 GHz, vertical & horizontal polarization

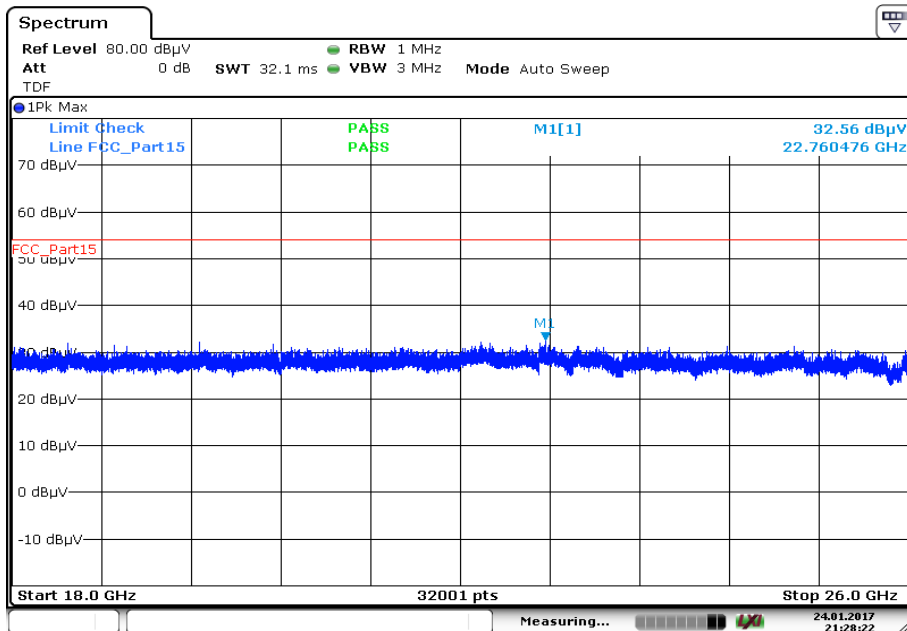

Plots: RX / idle mode

Plot 1: 1 GHz to 18 GHz, vertical & horizontal polarization

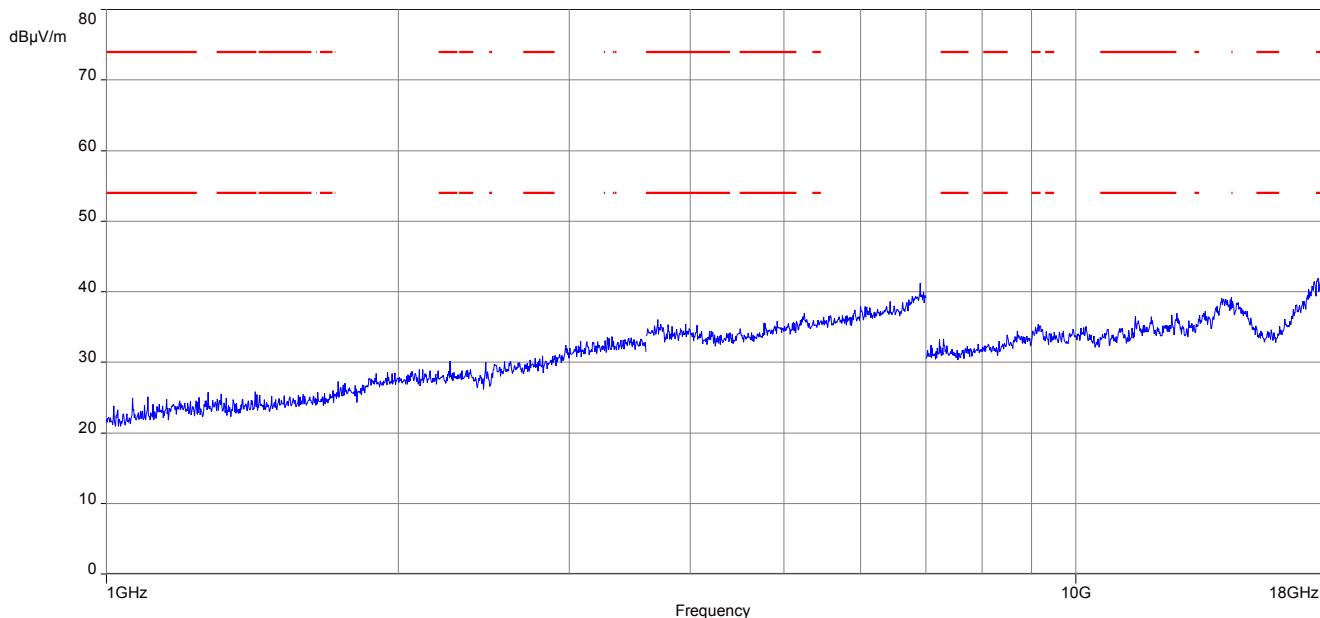

Plot 2: 18 GHz to 26 GHz, vertical & horizontal polarization

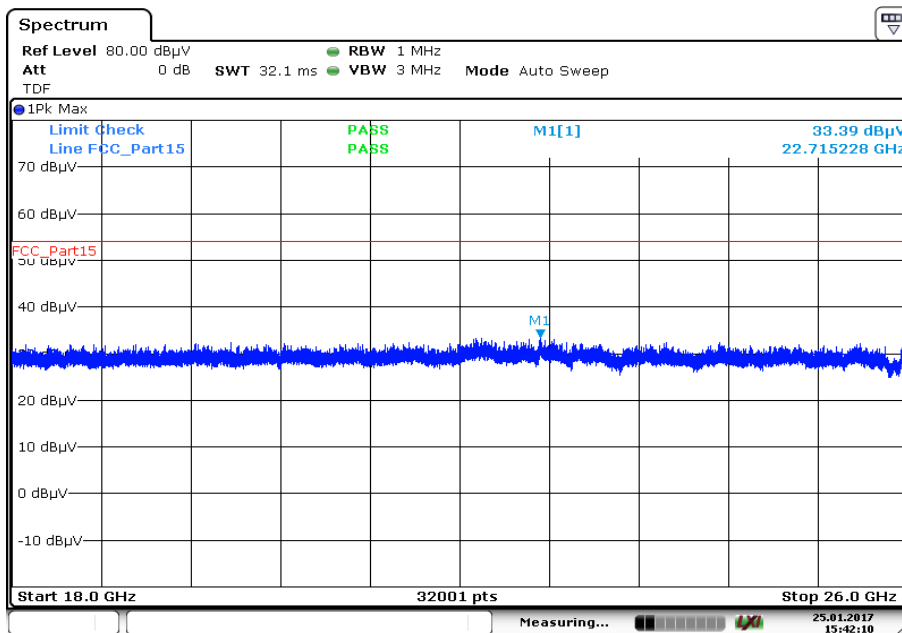

Date: 25.JAN.2017 15:42:10

11.14 Spurious emissions conducted below 30 MHz (AC conducted)

Description:

Measurement of the conducted spurious emissions in transmit mode below 30 MHz. The EUT is set to channel 6. This measurement is repeated for DSSS and OFDM modulation. If peaks are found channel 1 and channel 11 will be measured too. The measurement is performed with the data rate producing the highest output power. Both power lines, phase and neutral line, are measured. Found peaks are re-measured with average and quasi peak detection to show compliance to the limits.

Measurement:

Measurement parameter	
Detector:	Peak - Quasi Peak / Average
Sweep time:	Auto
Resolution bandwidth:	F < 150 kHz: 200 Hz F > 150 kHz: 9 kHz
Video bandwidth:	F < 150 kHz: 1 kHz F > 150 kHz: 100 kHz
Span:	9 kHz to 30 MHz
Trace mode:	Max Hold
Test setup:	See sub clause 6.4 A
Measurement uncertainty:	See sub clause 8

Limits:

FCC		IC
Frequency (MHz)	Quasi-Peak (dBµV/m)	Average (dBµV/m)
0.15 – 0.5	66 to 56*	56 to 46*
0.5 – 5	56	46
5 – 30.0	60	50

*Decreases with the logarithm of the frequency

Results:

TX Spurious Emissions Conducted < 30 MHz [dBµV/m]		
F [MHz]	Detector	Level [dBµV/m]
All detected peaks are more than 20 dB below the limit.		

Plots:

Plot 1: 150 kHz to 30 MHz, phase line

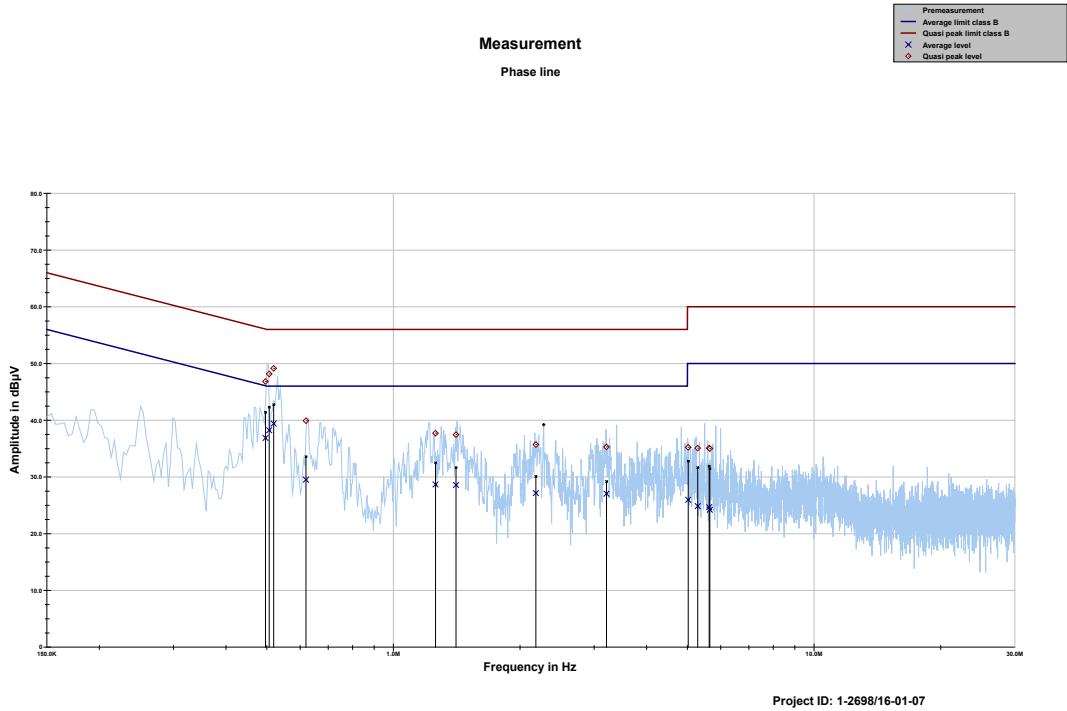

Frequency MHz	Quasi peak level dBµV	Margin quasi peak dB	Limit QP dBµV	Average level dBµV	Margin average dB	Limit AV dBµV
0.496600	46.83	9.23	56.057	36.86	9.23	46.097
0.506800	48.15	7.85	56.000	38.22	7.78	46.000
0.519145	49.15	6.85	56.000	39.41	6.59	46.000
0.619676	39.90	16.10	56.000	29.51	16.49	46.000
1.259152	37.70	18.30	56.000	28.68	17.32	46.000
1.409033	37.46	18.54	56.000	28.57	17.43	46.000
2.181163	35.70	20.30	56.000	27.15	18.85	46.000
3.211447	35.30	20.70	56.000	27.04	18.96	46.000
5.021331	35.21	24.79	60.000	25.97	24.03	50.000
5.288484	35.08	24.92	60.000	24.85	25.15	50.000
5.633079	35.07	24.93	60.000	24.66	25.34	50.000
5.653169	34.99	25.01	60.000	24.21	25.79	50.000

Plot 2: 150 kHz to 30 MHz, neutral line

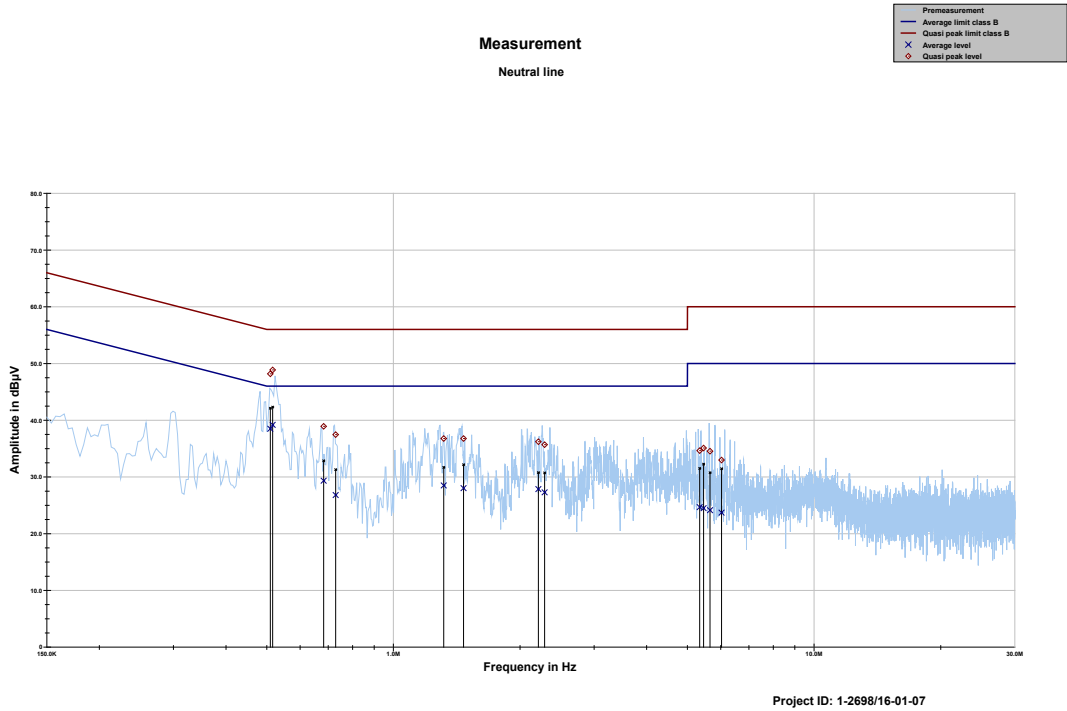

Frequency MHz	Quasi peak level dBµV	Margin quasi peak dB	Limit QP dBµV	Average level dBµV	Margin average dB	Limit AV dBµV
0.509885	48.17	7.83	56.000	38.49	7.51	46.000
0.516302	48.86	7.14	56.000	39.18	6.82	46.000
0.682556	38.92	17.08	56.000	29.33	16.67	46.000
0.729182	37.46	18.54	56.000	26.81	19.19	46.000
1.316882	36.77	19.23	56.000	28.49	17.51	46.000
1.468137	36.76	19.24	56.000	28.02	17.98	46.000
2.211775	36.21	19.79	56.000	27.85	18.15	46.000
2.288433	35.68	20.32	56.000	27.28	18.72	46.000
5.345631	34.64	25.36	60.000	24.67	25.33	50.000
5.462935	35.09	24.91	60.000	24.49	25.51	50.000
5.658933	34.53	25.47	60.000	24.13	25.87	50.000
6.026859	32.97	27.03	60.000	23.71	26.29	50.000

12 Observations

No observations except those reported with the single test cases have been made.

Annex A Document history

Version	Applied changes	Date of release
	Initial release	2017-02-09

Annex B Further information

Glossary

AVG	-	Average
DUT	-	Device under test
EMC	-	Electromagnetic Compatibility
EN	-	European Standard
EUT	-	Equipment under test
ETSI	-	European Telecommunications Standard Institute
FCC	-	Federal Communication Commission
FCC ID	-	Company Identifier at FCC
HW	-	Hardware
IC	-	Industry Canada
Inv. No.	-	Inventory number
N/A	-	Not applicable
PP	-	Positive peak
QP	-	Quasi peak
S/N	-	Serial number
SW	-	Software
PMN	-	Product marketing name
HMN	-	Host marketing name
HVIN	-	Hardware version identification number
FVIN	-	Firmware version identification number
OBW		Occupied Bandwidth
OC		Operating Channel
OCW		Operating Channel Bandwidth
OOB		Out Of Band

Annex C Accreditation Certificate

first page

last page



Deutsche Akkreditierungsstelle GmbH

Befehle gemäß § 8 Absatz 1 AkkStelleG i.V.m. § 1 Absatz 1 AkkStelleGBV
Unterzeichnerin der Multilateralen Abkommen
von EA, ILAC und IAF zur gegenseitigen Anerkennung

Akkreditierung



Die Deutsche Akkreditierungsstelle GmbH bestätigt hiermit, dass das Prüflaboratorium

CTC advanced GmbH
Untertürkheimer Straße 6-10, 66117 Saarbrücken

die Kompetenz nach DIN EN ISO/IEC 17025:2005 besitzt, Prüfungen in folgenden Bereichen durchzuführen:

Funk
Mobilfunk (GSM / DCS) + OTA
Elektromagnetische Verträglichkeit (EMV)
Produktsicherheit
SAR / EMF
Umwelt
Smart Card Technology
Bluetooth®
Automotive
Wi-Fi-Services
Kanadische Anforderungen
US-Anforderungen
Akustik
Near Field Communication (NFC)

Die Akkreditierungsurkunde gilt nur in Verbindung mit dem Bescheid vom 25.11.2016 mit der Akkreditierungsnummer D-PL-12076-01 und ist gültig bis 17.01.2018. Sie besteht aus diesem Deckblatt, der Rückseite des Deckblatts und der folgenden Anlage mit insgesamt 63 Seiten.

Registrierungsnummer der Urkunde: D-PL-12076-01-01

Frankfurt, 25.11.2016

Siehe Hinweis auf der Rückseite

Im Auftrag Dipl.-Ing. Ralf Eigner
Abteilungsleiter

Deutsche Akkreditierungsstelle GmbH

Standort Berlin
Spittelmarkt 10
10117 Berlin

Standort Frankfurt am Main
Europa-Allee 52
60327 Frankfurt am Main

Standort Braunschweig
Bundesallee 100
38116 Braunschweig

Die auszugsweise Veröffentlichung der Akkreditierungsurkunde bedarf der vorherigen schriftlichen Zustimmung der Deutsche Akkreditierungsstelle GmbH (DAkkS). Ausgenommen davon ist die separate Weiterverbreitung des Deckblattes durch die umseitig genannte Konformitätsbewertungsstelle in unveränderter Form.

Es darf nicht der Anschein erweckt werden, dass sich die Akkreditierung auch auf Bereiche erstreckt, die über den durch die DAkkS bestätigten Akkreditierungsbereich hinausgehen.

Die Akkreditierung erfolgte gemäß des Gesetzes über die Akkreditierungsstelle (AkkStelleG) vom 31. Juli 2009 (BGBl. I S. 2625) sowie der Verordnung (EG) Nr. 765/2008 des Europäischen Parlaments und des Rates vom 9. Juli 2008 über die Vorschriften für die Akkreditierung und Marktüberwachung im Zusammenhang mit der Vermarktung von Produkten (Abl. L 218 vom 9. Juli 2008, S. 30). Die DAkkS ist Unterzeichnerin der Multilateralen Abkommen zur gegenseitigen Anerkennung der European co-operation for Accreditation (EA), des International Accreditation Forum (IAF) und der International Laboratory Accreditation Cooperation (ILAC). Die Unterzeichner dieser Abkommen erkennen ihre Akkreditierungen gegenseitig an.

Der aktuelle Stand der Mitgliedschaft kann folgenden Webseiten entnommen werden:
EA: www.european-accrreditation.org
ILAC: www.ilac.org
IAF: www.iaf.nu

Note:
The current certificate including annex can be received on request.