



TEST REPORT

FCC PART 15 SUBPART C 15.247

Report Reference No.: CTL1903152011-WF01

Compiled by:
(position+printed name+signature)

Happy Guo
(File administrators)

Happy Guo

Tested by:
(position+printed name+signature)

Nice Nong
(Test Engineer)

NICE NONG

Approved by:
(position+printed name+signature)

Ivan Xie
(Manager)

Ivan Xie

Product Name.....: wireless module

Model/Type reference: AR1021X-NV5

List Model(s).....: N/A

Brand Name.....: N/A

FCC ID.....: ZLJ-AR1021X-NV5

Applicant's name: **TOPLINKST TECHNOLOGY COMPANY LIMITED**

Address of applicant: UNIT 04, 7F, BRIGHT WAY TOWER, NO,33 MONG KOK ROAD, KOWLOON, Hong Kong

Test Firm: **Shenzhen CTL Testing Technology Co., Ltd.**

Address of Test Firm: Floor 1-A, Baisha Technology Park, No.3011, Shahexi Road, Nanshan District, Shenzhen, China 518055

Test specification.....:

Standard.....: **47 CFR FCC Part 15 Subpart C 15.247**

TRF Originator: Shenzhen CTL Testing Technology Co., Ltd.

Master TRF: Dated 2011-01

Date of Receipt.....: Mar. 15, 2019

Date of sampling.....: Mar. 15, 2019

Date of Test Date.....: Mar. 15, 2019–Apr.15, 2019

Data of Issue.....: Apr.15, 2019

Result.....: **Pass**

Shenzhen CTL Testing Technology Co., Ltd. All rights reserved.

This publication may be reproduced in whole or in part for non-commercial purposes as long as the Shenzhen CTL Testing Technology Co., Ltd. is acknowledged as copyright owner and source of the material. Shenzhen CTL Testing Technology Co., Ltd. takes no responsibility for and will not assume liability for damages resulting from the reader's interpretation of the reproduced material due to its placement and context.

TEST REPORT

Test Report No. :	CTL1903152011-WF01	Apr. 15, 2019
		Date of issue

Equipment under Test : wireless module

Model /Type : AR1021X-NV5

Listed Models : N/A

Applicant : **TOPLINKST TECHNOLOGY COMPANY LIMITED**

Address : UNIT 04, 7F, BRIGHT WAY TOWER, NO,33 MONG KOK ROAD, KOWLOON, Hong Kong

Manufacturer : **TOPLINKST TECHNOLOGY COMPANY LIMITED**

Address : UNIT 04, 7F, BRIGHT WAY TOWER, NO,33 MONG KOK ROAD, KOWLOON, Hong Kong

Test result	Pass *
--------------------	---------------

* In the configuration tested, the EUT complied with the standards specified page 5.

The test results presented in this report relate only to the object tested.

This report shall not be reproduced, except in full, without the written approval of the issuing testing laboratory.

Table of Contents

Page

1.	SUMMARY.....	5
1.1.	TEST STANDARDS.....	5
1.2.	TEST DESCRIPTION.....	5
1.3.	TEST FACILITY.....	6
1.4.	STATEMENT OF THE MEASUREMENT UNCERTAINTY.....	6
1.5.	ENVIRONMENTAL CONDITIONS.....	8
1.6.	GENERAL DESCRIPTION OF EUT.....	8
2.	DESCRIPTION OF TEST MODES AND TEST FREQUENCY.....	8
2.1.	EQUIPMENTS USED DURING THE TEST.....	10
2.2.	SPECIAL ACCESSORIES.....	10
2.3.	RELATED SUBMITTAL(S) / GRANT (S).....	10
2.4.	MODIFICATIONS.....	10
3.	TEST CONDITIONS AND RESULTS.....	11
3.1.	CONDUCTED EMISSIONS TEST.....	11
3.2.	RADIATED EMISSIONS AND BAND EDGE.....	14
3.3.	MAXIMUM CONDUCTED OUTPUT POWER.....	21
3.4.	POWER SPECTRAL DENSITY.....	22
3.5.	6dB BANDWIDTH.....	27
3.6.	OUT-OF-BAND EMISSIONS.....	32
3.7.	ANTENNA REQUIREMENT.....	49
4.	TEST SETUP PHOTOS OF THE EUT.....	50
5.	EXTERNAL AND INTERNAL PHOTOS OF THE EUT.....	51

1. SUMMARY

1.1. TEST STANDARDS

The tests were performed according to following standards:

[FCC Rules Part 15.247](#): Frequency Hopping, Direct Spread Spectrum and Hybrid Systems that are in operation within the bands of 902-928 MHz, 2400-2483.5 MHz, and 5725-5850 MHz

[ANSI C63.10:2013](#) : American National Standard for Testing Unlicensed Wireless Devices

[KDB 558074 D01 15.247 Meas Guidance v05r02](#): GUIDANCE FOR COMPLIANCE MEASUREMENTS ON DIGITAL TRANSMISSION SYSTEM, FREQUENCY HOPPING SPREAD SPECTRUM SYSTEM, AND HYBRID SYSTEM DEVICES OPERATING UNDER SECTION 15.247 OF THE FCC RULES

[KDB 662911](#): D01Emissions Testing of Transmitters with Multiple Outputs in the Same Band

1.2. Test Description

FCC PART 15.247		
FCC Part 15.207	AC Power Conducted Emission	PASS
FCC Part 15.247(a)(2)	6dB Bandwidth	PASS
FCC Part 15.247(d)	Spurious RF Conducted Emission	PASS
FCC Part 15.247(b)	Maximum Conducted Output Power	PASS
FCC Part 15.247(e)	Power Spectral Density	PASS
FCC Part 15.205/ 15.209	Radiated Emissions	PASS
FCC Part 15.247(d)	Band Edge	PASS
FCC Part 15.203/15.247 (b)	Antenna Requirement	PASS

1.3. Test Facility

1.3.1 Address of the test laboratory

Shenzhen CTL Testing Technology Co., Ltd.

Floor 1-A, Baisha Technology Park, No. 3011, Shahexi Road, Nanshan, Shenzhen 518055 China

There is one 3m semi-anechoic chamber and two line conducted labs for final test. The Test Sites meet the requirements in documents ANSI C63.4 and CISPR 32/EN 55032 requirements.

1.3.2 Laboratory accreditation

The test facility is recognized, certified, or accredited by the following organizations:

CNAS-Lab Code: L7497

Shenzhen CTL Testing Technology Co., Ltd. has been assessed and proved to be in compliance with CNAS-CL01 Accreditation Criteria for Testing and Calibration Laboratories (identical to ISO/IEC 17025: 2005 General Requirements) for the Competence of Testing and Calibration Laboratories.

A2LA-Lab Cert. No. 4343.01

Shenzhen CTL Testing Technology Co., Ltd, EMC Laboratory has been accredited by A2LA for technical competence in the field of electrical testing, and proved to be in compliance with ISO/IEC 17025: 2005 General Requirements for the Competence of Testing and Calibration Laboratories and any additional program requirements in the identified field of testing.

IC Registration No.: 9518B

CAB identifier: CN0041

The 3m alternate test site of Shenzhen CTL Testing Technology Co., Ltd. EMC Laboratory has been registered by Innovation, Science and Economic Development Canada to test to Canadian radio equipment requirements with Registration No.: 9518B on Jan. 22, 2019.

FCC-Registration No.: 399832

Designation No.: CN1216

Shenzhen CTL Testing Technology Co., Ltd. EMC Laboratory has been registered and fully described in a report filed with the (FCC) Federal Communications Commission. The acceptance letter from the FCC is maintained in our files. Registration 399832, December 08, 2017.

1.4. Statement of the measurement uncertainty

The data and results referenced in this document are true and accurate. The reader is cautioned that there may be errors within the calibration limits of the equipment and facilities. The measurement uncertainty was calculated for all measurements listed in this test report acc. to CISPR 16 - 4 "Specification for radio disturbance and immunity measuring apparatus and methods – Part 4: Uncertainty in EMC Measurements" and is documented in the Shenzhen CTL Testing Technology Co., Ltd. quality system acc. to DIN EN ISO/IEC 17025. Furthermore, component and process variability of devices similar to that tested may result in additional deviation. The manufacturer has the sole responsibility of continued compliance of the device.

Hereafter the best measurement capability for CTL laboratory is reported:

Test	Measurement Uncertainty	Notes
Transmitter power conducted	±0.57 dB	(1)
Transmitter power Radiated	±2.20 dB	(1)
Conducted spurious emission 9KHz-40 GHz	±2.20 dB	(1)
Occupied Bandwidth	±0.01ppm	(1)
Radiated Emission 30~1000MHz	±3.53dB	(1)
Radiated Emission Above 1GHz	±4.32dB	(1)
Conducted Disturbance0.15~30MHz	±3.20dB	(1)

- (1) This uncertainty represents an expanded uncertainty expressed at approximately the 95% confidence level using a coverage factor of $k=2$.

1.5.Environmental conditions

During the measurement the environmental conditions were within the listed ranges:

Normal Temperature:	25°C
Relative Humidity:	55 %
Air Pressure:	101 kPa

1.6.General Description of EUT

Product Name:	wireless module
Model/Type reference:	AR1021X-NV5
Power supply:	DC 3.3V
WIFI	
Supported type:	802.11b/802.11g/802.11n(H20)/802.11n(H40)
Modulation:	802.11b: DSSS 802.11g/802.11n(H20)/802.11n(H40): OFDM
Operation frequency:	802.11b/802.11g/802.11n(H20): 2412MHz~2462MHz 802.11n(H40): 2422MHz~2452MHz
Channel number:	802.11b/802.11g/802.11n(H20): 11 802.11n(H40): 7
Channel separation:	5MHz
Antenna type:	Integral Antenna : 2*TX 2*RX
Antenna gain:	3dBi

Note: For more details, refer to the user's manual of the EUT.

2. Description of Test Modes and Test Frequency

The Applicant provides communication tools software to control the EUT for staying in continuous transmitting (Duty Cycle more than 98%) and receiving mode for testing.

There are 11 channels provided to the EUT and Channel 01/06/11 were selected for 802.11b/ 802.11g/ 802.11n(H20) test, Channel 03/06/09 were selected for 802.11n(H40) test.

Operation Frequency WIFI :

Channel	Frequency(MHz)	Channel	Frequency(MHz)
1	2412	8	2447
2	2417	9	2452
3	2422	10	2457
4	2427	11	2462
5	2432		
6	2437		
7	2442		

Note: The line display in grey were the channel selected for testing

Data Rate Used:

Preliminary tests were performed in different data rate to find the worst radiated emission. The data rate shown in the table below is the worst-case rate with respect to the specific test item. Investigation has been done on all the possible configurations for searching the worst cases. The following table is a list of the test modes shown in this test report.

Test Items	Mode	Data Rate	Channel
Maximum Conducted Output Power Power Spectral Density 6dB Bandwidth Spurious RF conducted emission Radiated Emission 9kHz~1GHz& Radiated Emission 1GHz~10th Harmonic	11b/DSSS	1 Mbps	1/6/11
	11g/OFDM	6 Mbps	1/6/11
	11n(20MHz)/OFDM	6.5Mbps	1/6/11
	11n(40MHz)/OFDM	13.5 Mbps	3/6/9
Band Edge	11b/DSSS	1 Mbps	1/11
	11g/OFDM	6 Mbps	1/11
	11n(20MHz)/OFDM	6.5Mbps	1/11
	11n(40MHz)/OFDM	13.5 Mbps	3//9

2.1. Equipments Used during the Test

Test Equipment	Manufacturer	Model No.	Serial No.	Calibration Date	Calibration Due Date
LISN	R&S	ENV216	3560.6550.1 2	2018/05/25	2019/05/24
LISN	R&S	ESH2-Z5	860014/010	2018/05/25	2019/05/24
Bilog Antenna	Sunol Sciences Corp.	JB1	A061713	2018/05/25	2019/05/24
EMI Test Receiver	R&S	ESCI	1166.5950.03	2018/05/25	2019/05/24
Power Sensor	Agilent	U2021XA	MY55130004	2018/05/25	2019/05/24
Power Meter	Agilent	U2021XA	MY55130006	2018/05/25	2019/05/24
Spectrum Analyzer	Agilent	E4407B	MY41440676	2019/01/19	2020/01/18
Spectrum Analyzer	Agilent	N9020	US46220290	2019/01/14	2020/01/13
Controller	EM Electronics	EM 1000	060859	2018/05/21	2019/05/20
Horn Antenna	Sunol Sciences Corp.	DRH-118	A062013	2018/05/25	2019/05/24
Active Loop Antenna	Da Ze	ZN30900A	/	2018/05/25	2019/05/24
Amplifier	Agilent	8449B	3008A02306	2018/05/25	2019/05/24
Amplifier	Agilent	8447D	2944A10176	2018/05/25	2019/05/24
Temperature/Humidity Meter	Gangxing	CTH-608	02	2018/05/17	2019/05/16
High-Pass Filter	micro-tranics	HPM50108	G174	2018/05/17	2019/05/16
High-Pass Filter	micro-tranics	HPM50111	G142	2018/05/17	2019/05/16
Coaxial Cables	HUBER+SUHNER	SUCOFLEX 104PEA-10M	10m	2018/05/17	2019/05/16
Coaxial Cables	HUBER+SUHNER	SUCOFLEX 104PEA-3M	3m	2018/05/17	2019/05/16
Coaxial Cables	HUBER+SUHNER	SUCOFLEX 104PEA-3M	3m	2018/05/17	2019/05/16
RF Cable	Megalon	RF-A303	N/A	2018/05/17	2019/05/16

The calibration interval was one year

2.2. Special Accessories

Manufacturer	Description	Model	Serial Number	Certificate
ASUS	Notebook PC	FL5900U	9014	FCC ID:PPD-QCNFA335

2.3. Related Submittal(s) / Grant (s)

This submittal(s) (test report) is intended for FCC ID: ZLJ-AR1021X-NV5 filing to comply with Section 15.247 of the FCC Part 15, Subpart C Rules.

2.4. Modifications

No modifications were implemented to meet testing criteria.

3. TEST CONDITIONS AND RESULTS

3.1. Conducted Emissions Test

LIMIT

FCC CFR Title 47 Part 15 Subpart C Section 15.207

Frequency range (MHz)	Limit (dBuV)	
	Quasi-peak	Average
0.15-0.5	66 to 56*	56 to 46*
0.5-5	56	46
5-30	60	50

* Decreases with the logarithm of the frequency.

TEST CONFIGURATION

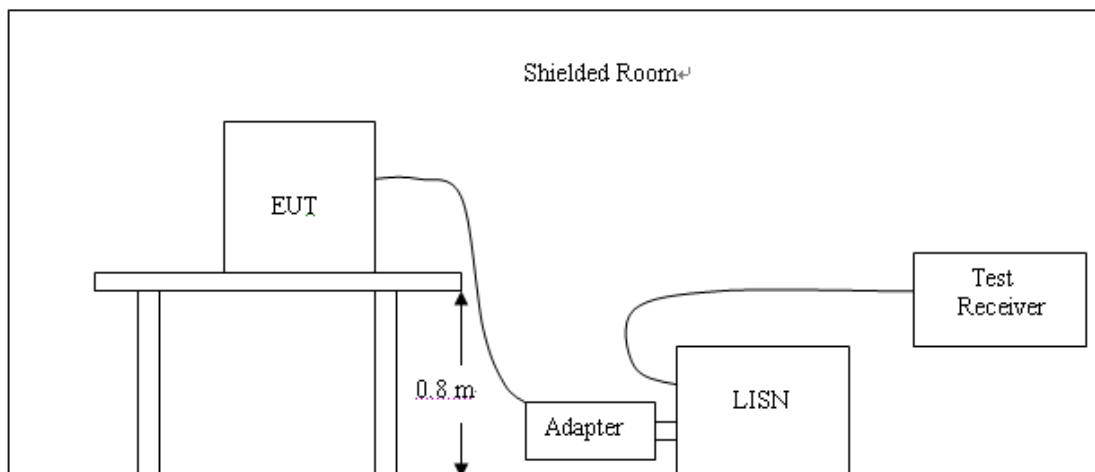

TEST PROCEDURE

1. The equipment was set up as per the test configuration to simulate typical actual usage per the user's manual. The EUT is a tabletop system; a wooden table with a height of 0.8 meters is used and is placed on the ground plane as per ANSI C63.10:2013.
2. Support equipment, if needed, was placed as per ANSI C63.10:2013.
3. All I/O cables were positioned to simulate typical actual usage as per ANSI C63.10:2013.
4. The adapter received AC120V/60Hz power through a Line Impedance Stabilization Network (LISN) which supplied power source and was grounded to the ground plane.
5. All support equipments received AC power from a second LISN, if any.
6. The EUT test program was started. Emissions were measured on each current carrying line of the EUT using a spectrum Analyzer / Receiver connected to the LISN powering the EUT. The LISN has two monitoring points: Line 1 (Hot Side) and Line 2 (Neutral Side). Two scans were taken: one with Line 1 connected to Analyzer / Receiver and Line 2 connected to a 50 ohm load; the second scan had Line 1 connected to a 50 ohm load and Line 2 connected to the Analyzer / Receiver.
7. Analyzer / Receiver scanned from 150 KHz to 30MHz for emissions in each of the test modes.
8. During the above scans, the emissions were maximized by cable manipulation.

TEST RESULTS

Test Mode	WIFI	Line:	L
-----------	------	-------	---

SCAN TABLE: "Voltage (9K-30M) FIN"

Short Description: 150K-30M Voltage

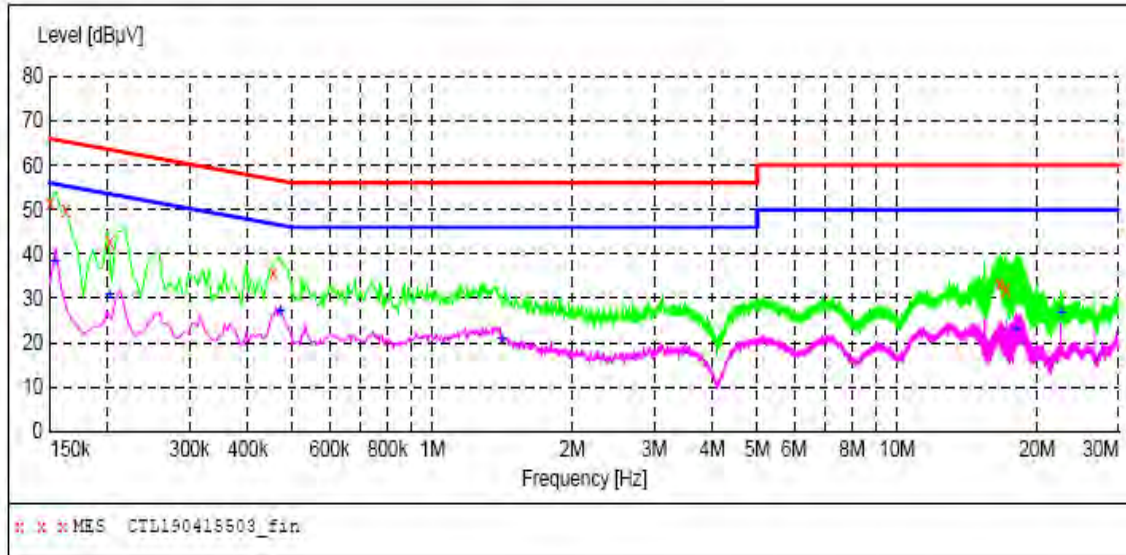

MEASUREMENT RESULT: "CTL190415503_fin"

2019-4-15 05:35??

Frequency MHz	Level dBuV	Transd dB	Limit dBuV	Margin dB	Detector	Line	FE
0.150000	51.50	11.2	66	14.5	QP	L1	GND
0.162000	49.70	11.2	65	15.7	QP	L1	GND
0.202000	42.60	11.2	64	20.9	QP	L1	GND
0.454000	35.80	11.2	57	21.0	QP	L1	GND
16.604000	33.40	11.3	60	26.6	QP	L1	GND
17.138000	32.10	11.3	60	27.9	QP	L1	GND

MEASUREMENT RESULT: "CTL190415503_fin2"

2019-4-15 05:35??

Frequency MHz	Level dBuV	Transd dB	Limit dBuV	Margin dB	Detector	Line	FE
0.154000	38.40	11.2	56	17.4	AV	L1	GND
0.202000	30.90	11.2	54	22.6	AV	L1	GND
0.470000	27.20	11.2	47	19.3	AV	L1	GND
1.412000	20.90	11.3	46	25.1	AV	L1	GND
17.996000	23.00	11.3	50	27.0	AV	L1	GND
22.526000	26.70	11.5	50	23.3	AV	L1	GND

Test Mode: WIFI Line: N

SCAN TABLE: "Voltage (9K-30M) FIN"

Short Description: 150K-30M Voltage

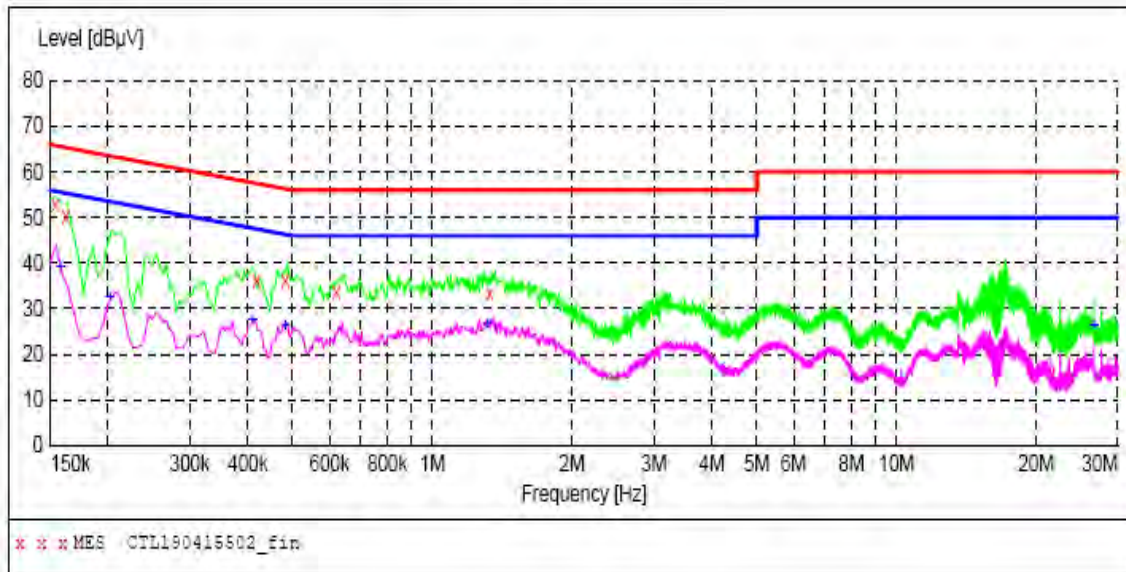

MEASUREMENT RESULT: "CTL190415502_fin"

2019-4-15 05:32??

Frequency MHz	Level dBuV	Transd dB	Limit dBuV	Margin dB	Detector	Line	PE
0.154000	52.60	11.2	66	13.2	QP	N	GND
0.162000	50.40	11.2	65	15.0	QP	N	GND
0.418000	36.20	11.2	58	21.3	QP	N	GND
0.482000	36.30	11.2	56	20.0	QP	N	GND
0.620000	33.60	11.2	56	22.4	QP	N	GND
1.328000	33.30	11.3	56	22.7	QP	N	GND

MEASUREMENT RESULT: "CTL190415502_fin2"

2019-4-15 05:32??

Frequency MHz	Level dBuV	Transd dB	Limit dBuV	Margin dB	Detector	Line	PE
0.158000	38.90	11.2	56	16.7	AV	N	GND
0.202000	32.50	11.2	54	21.0	AV	N	GND
0.410000	27.60	11.2	48	20.0	AV	N	GND
0.482000	26.10	11.2	46	20.2	AV	N	GND
1.316000	26.50	11.3	46	19.5	AV	N	GND
26.624000	26.10	11.7	50	23.9	AV	N	GND

3.2. Radiated Emissions and Band Edge

Limit

For intentional device, according to § 15.209(a), the general requirement of field strength of radiated emission out of authorized band shall not exceed the following table at a 3 meters measurement distance.

FCC PART 15.249(d) Emissions radiated outside of the specified frequency bands, except for harmonics, shall be attenuated by at least 50 dB below the level of the fundamental or to the general radiated emission limits in §15.209, whichever is the lesser attenuation.

In addition, radiated emissions which fall in the restricted bands, as defined in §15.205(a), must also comply with the radiated emission limits specified in §15.209(a)

Radiated emission limits

Frequency (MHz)	Distance (Meters)	Radiated (dB μ V/m)	Radiated (μ V/m)
0.009-0.49	3	$20\log(2400/F(\text{KHz}))+40\log(300/3)$	$2400/F(\text{KHz})$
0.49-1.705	3	$20\log(24000/F(\text{KHz}))+ 40\log(30/3)$	$24000/F(\text{KHz})$
1.705-30	3	$20\log(30)+ 40\log(30/3)$	30
30-88	3	40.0	100
88-216	3	43.5	150
216-960	3	46.0	200
Above 960	3	54.0	500

TEST CONFIGURATION

(A) Radiated Emission Test Set-Up, Frequency Below 30MHz

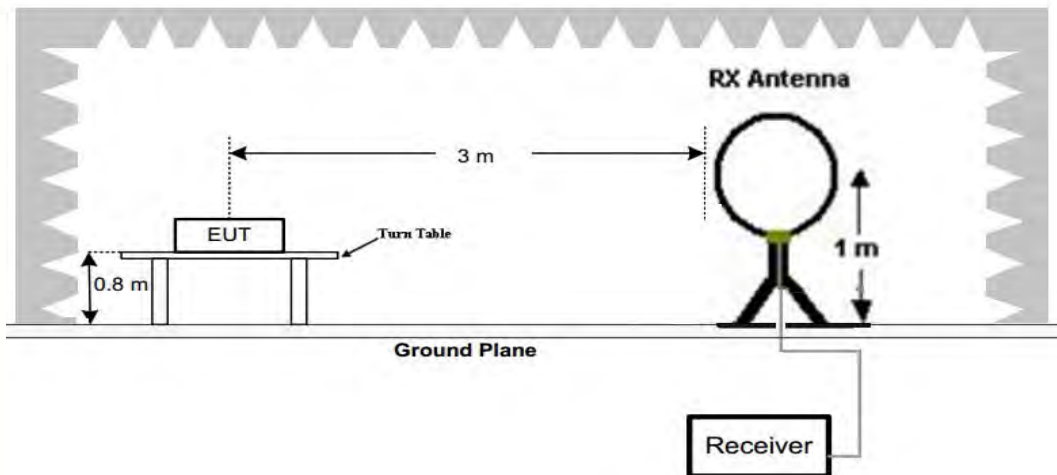

(B) Radiated Emission Test Set-Up, Frequency below 1000MHz

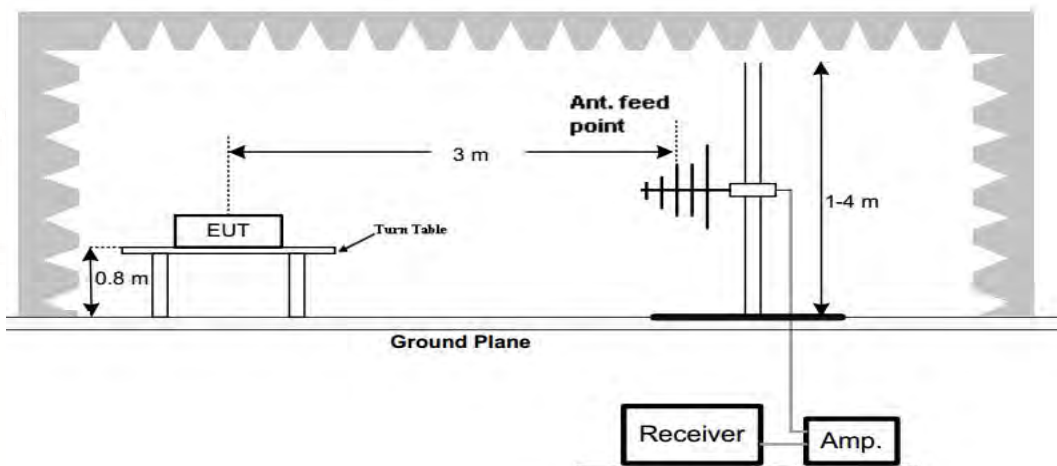

(C) Radiated Emission Test Set-Up, Frequency above 1000MHz

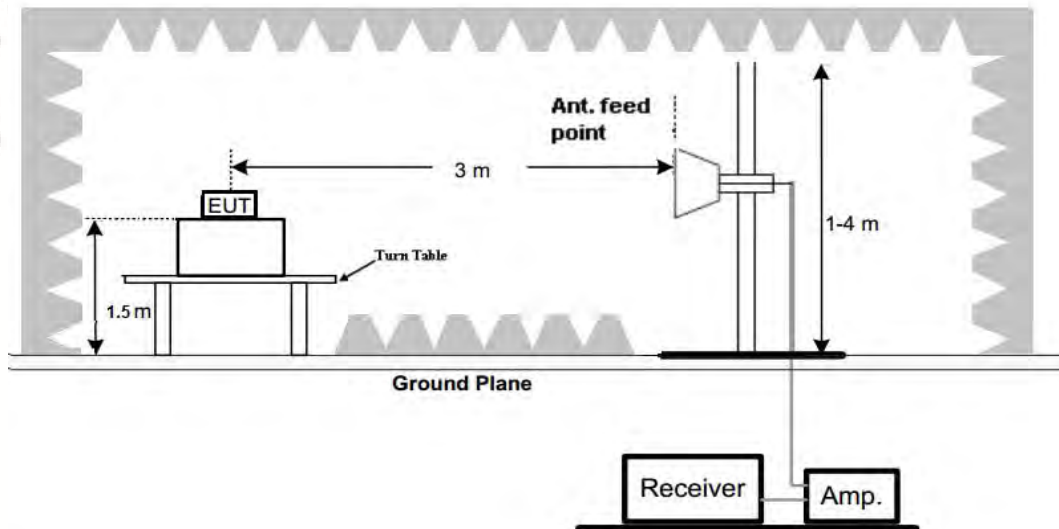

Test Procedure

1. Below 1GHz measurement the EUT is placed on a turntable which is 0.8m above ground plane, and above 1GHz measurement EUT was placed on a low permittivity and low loss tangent turn table which is 1.5m above ground plane.
2. Maximum procedure was performed by raising the receiving antenna from 1m to 4m and rotating the turn table from 0°C to 360°C to acquire the highest emissions from EUT
3. And also, each emission was to be maximized by changing the polarization of receiving antenna both horizontal and vertical.
4. Repeat above procedures until all frequency measurements have been completed.

TEST RESULTS

Remark:

1. We tested three channels (lowest/middle/highest) of each mode and recorded worst case at 802.11b mode low channel for measurement below 1GHz.
2. We tested three channels (lowest/middle/highest) of each mode and recorded worst case at 802.11b mode above 1GHz.

For 9 KHz-30MHz

Freq. (MHz)	Level (dBuV)	Over Limit (dB)	Limit Line (dBuV)	Remark
-	-	-	-	See Note

Note: The amplitude of spurious emissions that are attenuated by more than 20dB below the permissible value has no need to be reported.

Distance extrapolation factor= $40 \log (\text{specific distance} / \text{test distance})$ (dB);
 Limit line= specific limits (dBuV) + distance extrapolation factor.

For 30MHz-1GHz

Horizontal

SWEEP TABLE: "test (30M-1G)"

Short Description:		Field Strength			
Start	Stop	Detector	Meas. Time	IF Bandw.	Transducer
30.0 MHz	1.0 GHz	MaxPeak	300.0 ms	100 kHz	JB1

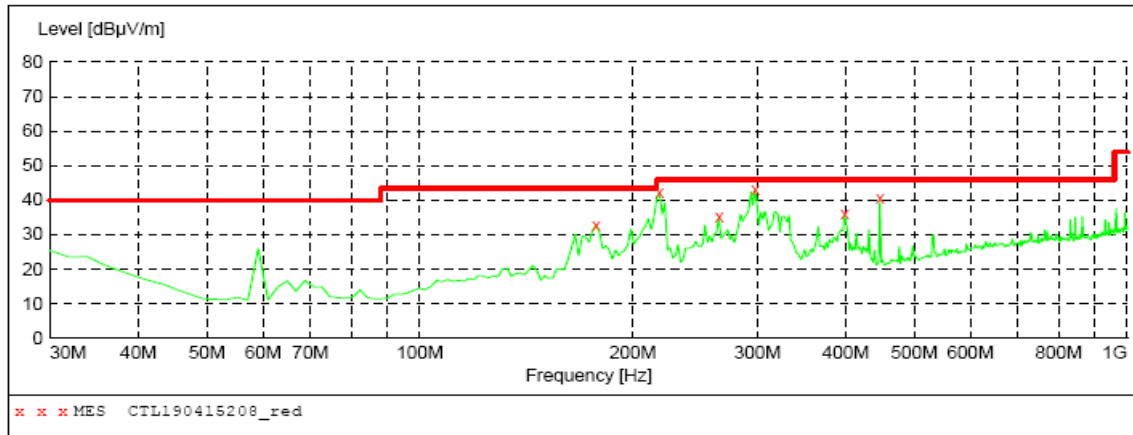

MEASUREMENT RESULT: "CTL190415208_red"

15/04/2019 12:08

Frequency MHz	Level dBuV/m	Transd dB	Limit dBuV/m	Margin dB	Det.	Height cm	Azimuth deg	Polarization
177.440000	32.90	14.6	43.5	10.6	---	0.0	0.00	HORIZONTAL
218.180000	42.20	14.4	46.0	3.8	---	0.0	0.00	HORIZONTAL
264.740000	35.30	14.9	46.0	10.7	---	0.0	0.00	HORIZONTAL
297.720000	43.00	16.0	46.0	3.0	---	0.0	0.00	HORIZONTAL
398.600000	36.00	18.2	46.0	10.0	---	0.0	0.00	HORIZONTAL
447.100000	40.50	19.4	46.0	5.5	---	0.0	0.00	HORIZONTAL

Vertical

SWEEP TABLE: "test (30M-1G)"

Short Description:		Field Strength			
Start	Stop	Detector	Meas. Time	IF Bandw.	Transducer
30.0 MHz	1.0 GHz	MaxPeak	300.0 ms	100 kHz	JB1

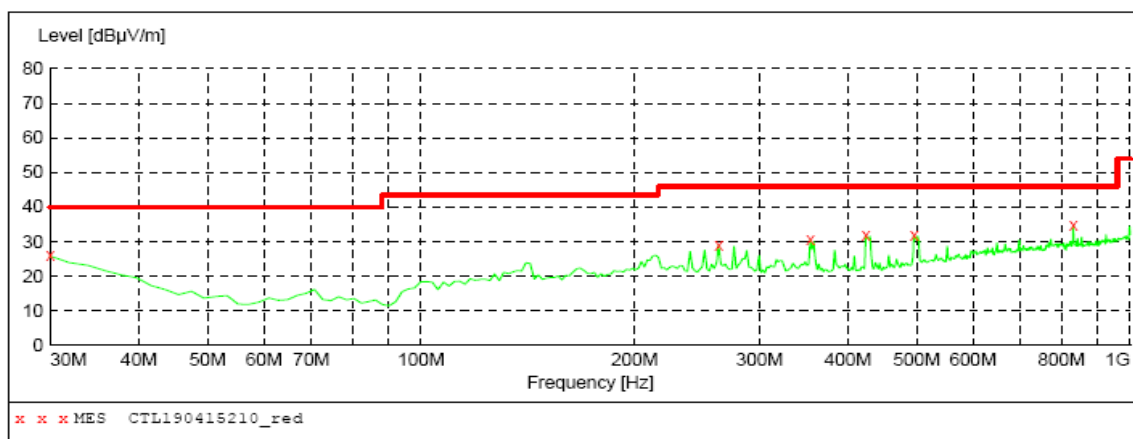

MEASUREMENT RESULT: "CTL190415210_red"

15/04/2019 12:48

Frequency MHz	Level dBuV/m	Transd dB	Limit dBuV/m	Margin dB	Det.	Height cm	Azimuth deg	Polarization
30.000000	25.90	22.1	40.0	14.1	---	0.0	0.00	VERTICAL
262.800000	28.90	14.9	46.0	17.1	---	0.0	0.00	VERTICAL
353.980000	30.50	17.3	46.0	15.5	---	0.0	0.00	VERTICAL
423.820000	31.70	18.8	46.0	14.3	---	0.0	0.00	VERTICAL
495.600000	31.80	20.4	46.0	14.2	---	0.0	0.00	VERTICAL
831.220000	34.70	25.8	46.0	11.3	---	0.0	0.00	VERTICAL

For 1GHz to 25GHz

Note: 802.11b/802.11g/802.11n (H20)/ 802.11n (H40) all have been tested, only worse case 802.11n (H20)

MIMO mode is reported

Frequency(MHz):			2412		Polarity:			HORIZONTAL	
Frequency (MHz)	Emission Level (dBuV/m)		Limit (dBuV/m)	Margin (dB)	Raw Value (dBuV)	Antenna Factor (dB/m)	Cable Factor (dB)	Pre-amplifier (dB)	Correction Factor (dB/m)
4824.00	56.34	PK	74.00	17.66	51.79	33.52	6.92	35.89	4.55
4824.00	51.61	AV	54.00	2.39	47.06	33.52	6.92	35.89	4.55
3217.00	47.10	PK	74.00	26.90	39.90	34.38	7.10	34.28	7.20
3217.00	--	AV	54.00	--	--	--	--	--	--
7236.00	51.52	PK	74.00	22.48	40.25	37.10	9.19	35.02	11.27
7236.00	--	AV	54.00	--	--	--	--	--	--

Frequency(MHz):			2412		Polarity:			VERTICAL	
Frequency (MHz)	Emission Level (dBuV/m)		Limit (dBuV/m)	Margin (dB)	Raw Value (dBuV)	Antenna Factor (dB/m)	Cable Factor (dB)	Pre-amplifier (dB)	Correction Factor (dB/m)
4824.00	55.26	PK	74.00	18.74	50.71	33.52	6.92	35.89	4.55
4824.00	50.17	AV	54.00	3.83	45.62	33.52	6.92	35.89	4.55
3283.00	45.93	PK	74.00	28.07	38.73	34.38	7.10	34.28	7.20
3283.00	--	AV	54.00	--	--	--	--	--	--
7236.00	50.53	PK	74.00	23.47	39.26	37.10	9.19	35.02	11.27
7236.00	--	AV	54.00	--	--	--	--	--	--

Frequency(MHz):			2437		Polarity:			HORIZONTAL	
Frequency (MHz)	Emission Level (dBuV/m)		Limit (dBuV/m)	Margin (dB)	Raw Value (dBuV)	Antenna Factor (dB/m)	Cable Factor (dB)	Pre-amplifier (dB)	Correction Factor (dB/m)
4874.00	55.81	PK	74.00	18.19	49.57	33.59	6.95	34.3	6.24
4874.00	49.45	AV	54.00	4.55	43.21	33.59	6.95	34.3	6.24
3255.00	46.58	PK	74.00	27.42	38.98	34.56	7.15	34.11	7.60
3255.00	--	AV	54.00	--	--	--	--	--	--
7311.00	51.42	PK	74.00	22.58	39.76	37.44	9.22	35	11.66
7311.00	--	AV	54.00	--	--	--	--	--	--

Frequency(MHz):			2437		Polarity:			VERTICAL	
Frequency (MHz)	Emission Level (dBuV/m)		Limit (dBuV/m)	Margin (dB)	Raw Value (dBuV)	Antenna Factor (dB/m)	Cable Factor (dB)	Pre-amplifier (dB)	Correction Factor (dB/m)
4874.00	56.33	PK	74.00	17.67	49.99	33.59	6.95	34.2	6.34
4874.00	50.28	AV	54.00	3.72	43.94	33.59	6.95	34.2	6.34
3269.00	48.09	PK	74.00	25.91	41.19	34.07	7.05	34.22	6.90
3269.00	--	AV	54.00	--	--	--	--	--	--
7311.00	50.60	PK	74.00	23.40	38.94	37.44	9.22	35	11.66
7311.00	--	AV	54.00	--	--	--	--	--	--

Frequency(MHz):			2462		Polarity:			HORIZONTAL	
Frequency (MHz)	Emission Level (dBuV/m)		Limit (dBuV/m)	Margin (dB)	Raw Value (dBuV)	Antenna Factor (dB/m)	Cable Factor (dB)	Pre-amplifier (dB)	Correction Factor (dB/m)
4924.00	54.98	PK	74.00	19.02	53.55	33.71	6.98	35.91	4.78
4924.00	48.76	AV	54.00	5.24	43.73	33.71	6.98	35.91	4.78
5913.00	47.95	PK	74.00	26.05	41.24	34.34	7.09	34.27	7.17
5913.00	--	AV	54.00	--	--	--	--	--	--
7386.00	46.73	PK	74.00	27.27	37.40	37.61	9.25	34.98	11.88
7386.00	--	AV	54.00	--	--	--	--	--	--

Frequency(MHz):			2462		Polarity:			VERTICAL	
Frequency (MHz)	Emission Level (dBuV/m)		Limit (dBuV/m)	Margin (dB)	Raw Value (dBuV)	Antenna Factor (dB/m)	Cable Factor (dB)	Pre-amplifier (dB)	Correction Factor (dB/m)
4924.00	55.86	PK	74.00	18.14	51.08	33.71	6.98	35.91	4.78
4924.00	49.70	AV	54.00	4.30	44.92	33.71	6.98	35.91	4.78
6080.00	48.29	PK	74.00	25.71	41.12	34.34	7.09	34.27	7.17
6080.00	--	AV	54.00	--	--	--	--	--	--
7386.00	49.34	PK	74.00	24.66	37.46	37.61	9.25	34.98	11.88
7386.00	--	AV	54.00	--	--	--	--	--	--

REMARKS:

1. Emission level (dBuV/m) =Raw Value (dBuV)+Correction Factor (dB/m)
2. Correction Factor (dB/m) = Antenna Factor (dB/m)+Cable Factor (dB)-Pre-amplifier Factor
3. Margin value = Limit value- Emission level.
4. -- Mean the PK detector measured value is below average limit.
5. The other emission levels were very low against the limit.
6. RBW1MHz VBW3MHz Peak detector is for PK value; RBW 1MHz VBW10Hz Peak detector is for AV value.

Results of Band Edges Test (Radiated)

Note: 802.11b/802.11g/802.11n (H20)/ 802.11n (H40)all have been tested, only worse case 802.11n (H20)

MIMO mode is reported

802.11n (H20) MIMO Mode (above 1GHz)

Frequency(MHz):			2412		Polarity:			HORIZONTAL	
Frequency (MHz)	Emission Level (dBuV/m)		Limit (dBuV/m)	Margin (dB)	Raw Value (dBuV)	Antenna Factor (dB/m)	Cable Factor (dB)	Pre-amplifier (dB)	Correction Factor (dB/m)
2412.00	108.60	PK	--	--	75.21	28.78	4.61	0	33.39
2412.00	102.15	AV	--	--	68.76	28.78	4.61	0	33.39
2346.00	44.81	PK	74.00	29.19	11.73	28.52	4.56	0	33.08
2346.00	--	AV	54.00	--	--	--	--	--	--
2390.00	46.86	PK	74.00	27.14	13.54	28.72	4.60	0	33.32
2390.00	--	AV	54.00	--	--	--	--	--	--
2400.00	57.81	PK	74.00	16.19	24.42	28.78	4.61	0	33.39
2400.00	52.43	AV	54.00	1.57	19.04	28.78	4.61	0	33.39

Frequency(MHz):			2412		Polarity:			VERTICAL	
Frequency (MHz)	Emission Level (dBuV/m)		Limit (dBuV/m)	Margin (dB)	Raw Value (dBuV)	Antenna Factor (dB/m)	Cable Factor (dB)	Pre-amplifier (dB)	Correction Factor (dB/m)
2412.00	109.73	PK	--	--	76.34	28.78	4.61	0	33.39
2412.00	103.24	AV	--	--	69.85	28.78	4.61	0	33.39
2352.00	44.25	PK	74.00	29.75	11.17	28.52	4.56	0	33.08
2352.00	--	AV	54.00	--	--	--	--	--	--
2390.00	47.69	PK	74.00	26.31	14.37	28.72	4.60	0	33.32
2390.00	--	AV	54.00	--	--	--	--	--	--
2400.00	57.41	PK	74.00	16.59	24.02	28.78	4.61	0	33.39
2400.00	50.56	AV	54.00	3.44	17.17	28.78	4.61	0	33.39

Frequency(MHz):			2462		Polarity:			HORIZONTAL	
Frequency (MHz)	Emission Level (dBuV/m)		Limit (dBuV/m)	Margin (dB)	Raw Value (dBuV)	Antenna Factor (dB/m)	Cable Factor (dB)	Pre-amplifier (dB)	Correction Factor (dB/m)
2462.00	108.84	PK	--	--	75.22	28.92	4.70	0	33.62
2462.00	102.10	AV	--	--	68.48	28.92	4.70	0	33.62
2483.50	46.23	PK	74.00	27.77	12.60	28.93	4.70	0	33.63
2483.50	--	AV	54.00	--	--	--	--	--	--
2495.00	44.36	PK	74.00	29.64	10.72	28.94	4.71	0	33.64
2495.00	--	AV	54.00	--	--	--	--	--	--
2500.00	42.65	PK	74.00	31.35	8.97	28.96	4.72	0	33.68
2500.00	--	AV	54.00	--	--	--	--	--	--

Frequency(MHz):			2462		Polarity:			VERTICAL	
Frequency (MHz)	Emission Level (dBuV/m)		Limit (dBuV/m)	Margin (dB)	Raw Value (dBuV)	Antenna Factor (dB/m)	Cable Factor (dB)	Pre-amplifier (dB)	Correction Factor (dB/m)
2462.00	107.45	PK	--	--	73.83	28.92	4.70	0.00	33.62
2462.00	101.78	AV	--	--	68.16	28.92	4.70	0.00	33.62
2483.50	47.20	PK	74.00	26.80	13.57	28.93	4.70	0.00	33.63
2483.50	--	AV	54.00	--	--	--	--	--	--
2492.00	44.46	PK	74.00	29.54	10.82	28.94	4.71	0.00	33.64
2492.00	--	AV	54.00	--	--	--	--	--	--
2500.00	42.82	PK	74.00	31.18	9.14	28.96	4.72	0.00	33.68
2500.00	--	AV	54.00	--	--	--	--	--	--

REMARKS:

1. Emission level (dBuV/m) =Raw Value (dBuV)+Correction Factor (dB/m)
2. Correction Factor (dB/m) = Antenna Factor (dB/m)+Cable Factor (dB)-Pre-amplifier Factor
3. Margin value = Limit value- Emission level.
4. -- Mean the PK detector measured value is below average limit.
5. The other emission levels were very low against the limit.
6. RBW1MHz VBW3MHz Peak detector is for PK value; RBW 1MHz VBW10Hz Peak detector is for AV value.

3.3. Maximum Conducted Output Power

Limit

The Maximum Peak Output Power Measurement is 30dBm.

Test Procedure

Remove the antenna from the EUT and then connect a low loss RF cable from the antenna port to the power sensor.

Test Configuration

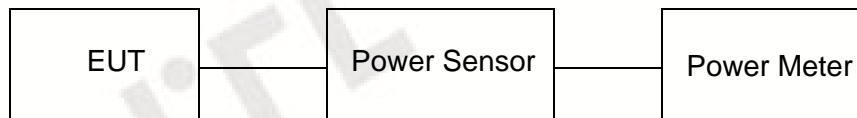

Test Results

WIFI

Type	Channel	Output power Ant1 (dBm)	Output power Ant2 (dBm)	Output power Total (dBm)	Limit (dBm)	Result
802.11b	01	14.72	13.41	/	30.00	Pass
	06	14.84	13.26	/		
	11	15.67	14.33	/		
802.11g	01	19.96	18.45	/	30.00	Pass
	06	20.27	18.43	/		
	11	20.67	19.51	/		
802.11n(HT20) MIMO	01	19.63	18.50	22.11	30.00	Pass
	06	20.24	18.52	22.47		
	11	20.81	19.61	23.26		
802.11n(HT40) MIMO	03	19.59	18.09	21.91	30.00	Pass
	06	20.48	18.63	22.66		
	09	20.19	19.08	22.68		

Note: 1.The test results including the cable lose.

3.4. Power Spectral Density

Limit

For digitally modulated systems, the power spectral density conducted from the intentional radiator to the antenna shall not be greater than 8 dBm in any 3 kHz band during any time interval of continuous transmission.

Test Procedure

1. Use this procedure when the maximum peak conducted output power in the fundamental emission is used to demonstrate compliance.
2. Set the RBW \geq 3 kHz.
3. Set the VBW \geq 3x RBW.
4. Set the span to 1.5 times the DTS channel bandwidth.
5. Detector = peak.
6. Sweep time = auto couple.
7. Trace mode = max hold.
8. Allow trace to fully stabilize.
9. Use the peak marker function to determine the maximum power level.
10. If measured value exceeds limit, reduce RBW (no less than 3 kHz) and repeat.
11. The resulting peak PSD level must be 8dBm.

Test Configuration

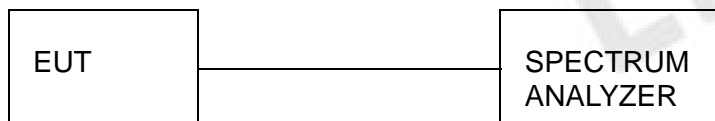

Test Results

WIFI						
Type	Channel	Power Spectral Density Ant1 (dBm/3KHz)	Power Spectral Density Ant2 (dBm/3KHz)	Power Spectral Density Total (dBm/3KHz)	Limit (dBm/3KHz)	Result
802.11b	01	-12.056	-13.684	/	8.00	Pass
	06	-12.327	-14.106	/		
	11	-11.384	-11.911	/		
802.11g	01	-13.824	-16.048	/	8.00	Pass
	06	-13.110	-14.773	/		
	11	-11.815	-13.189	/		
802.11n(HT20) MIMO	01	-14.406	-15.939	-12.09	8.00	Pass
	06	-13.434	-16.171	-11.58		
	11	-12.722	-13.770	-10.20		
802.11n(HT40) MIMO	03	-17.569	-19.397	-15.38	8.00	Pass
	06	-16.501	-18.529	-14.39		
	09	-16.785	-20.436	-15.23		

Test plot as follows:

Ant. 1

802.11b

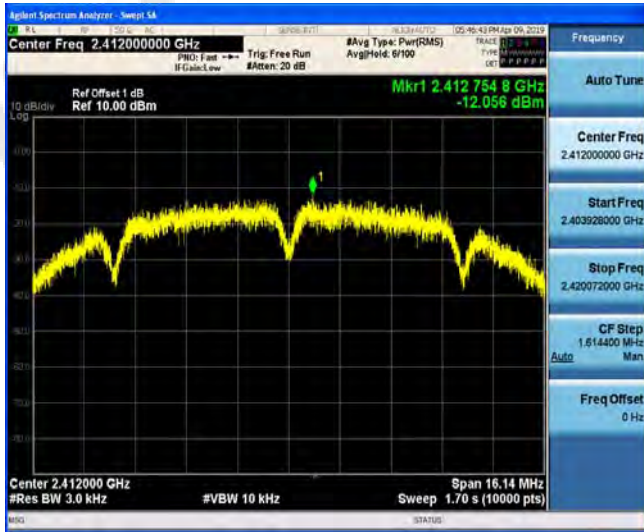

802.11g

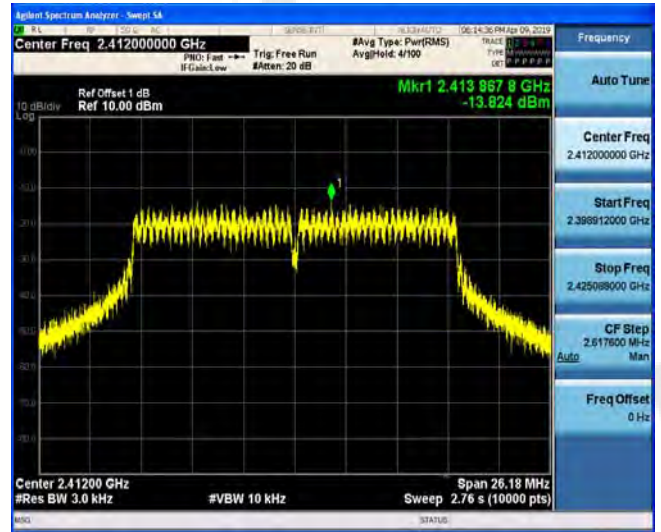

CH01

CH01

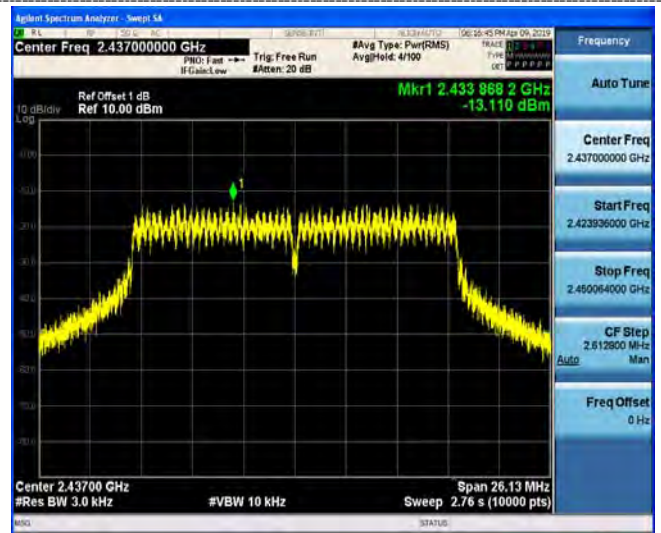

CH06

CH06

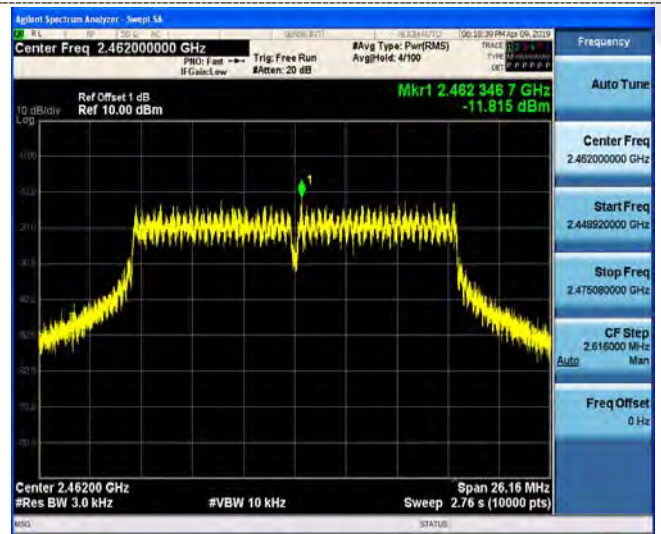
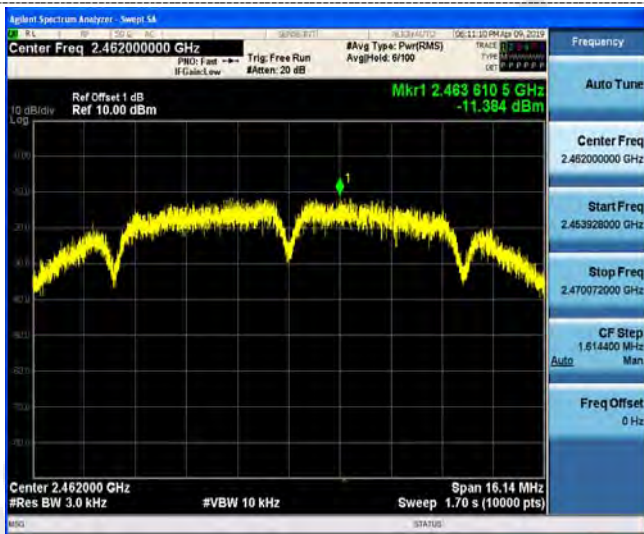

CH11

CH11

802.11n(HT20)

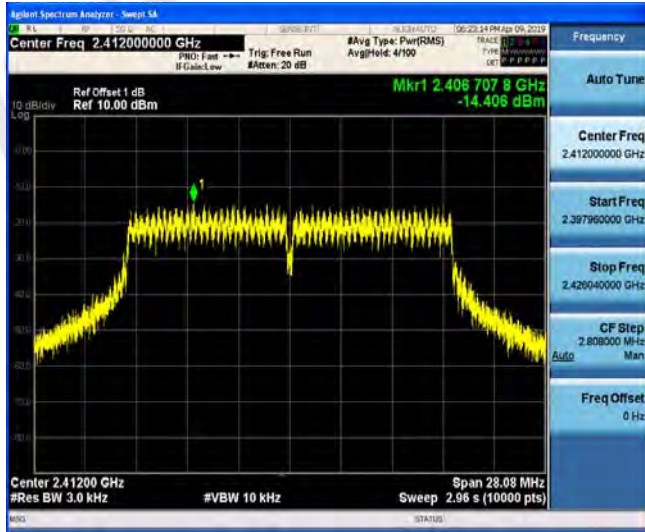

CH01

802.11n(HT40)

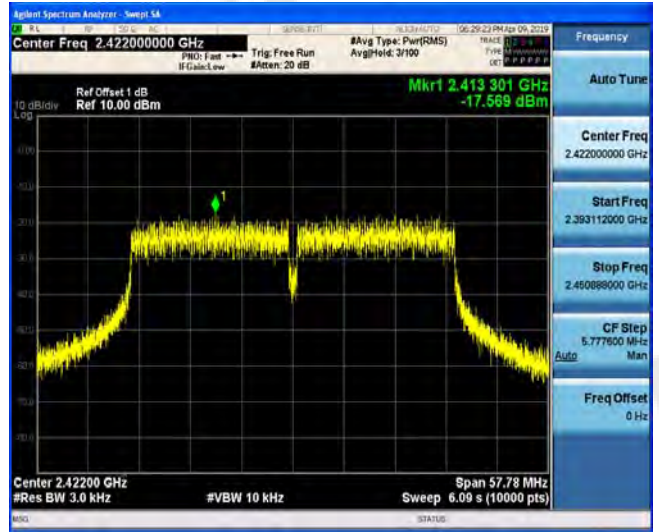

CH03

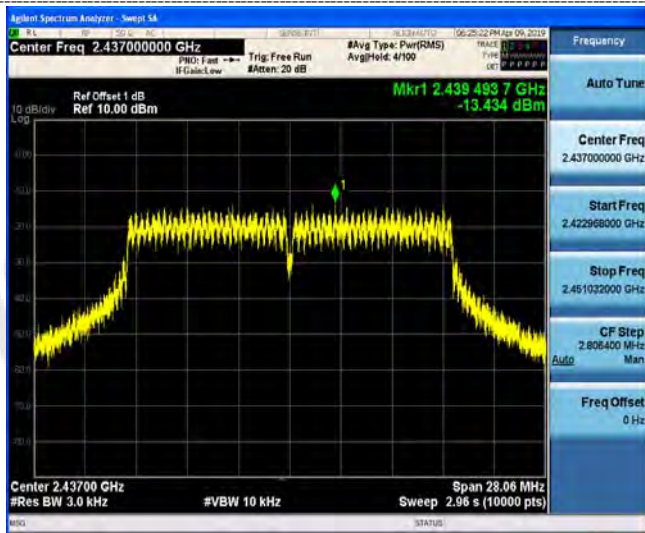

CH06

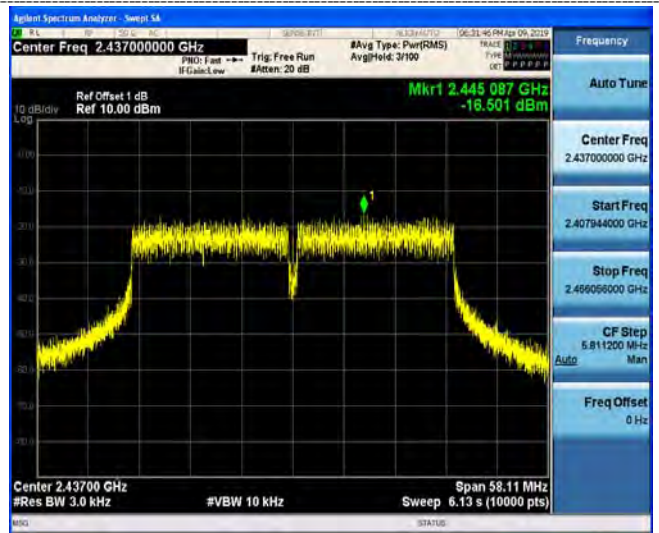

CH06

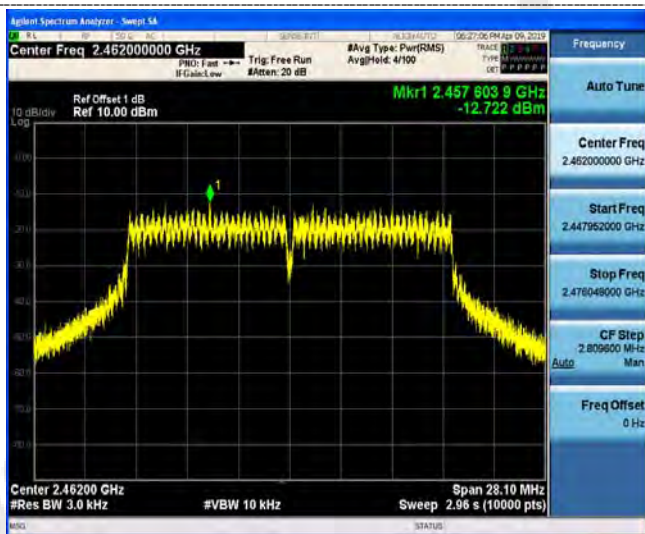

CH11

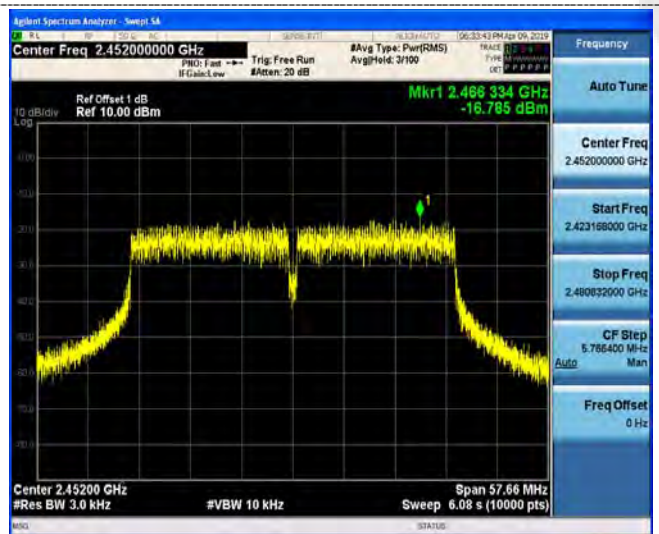

CH09

Ant. 2

802.11b



802.11g

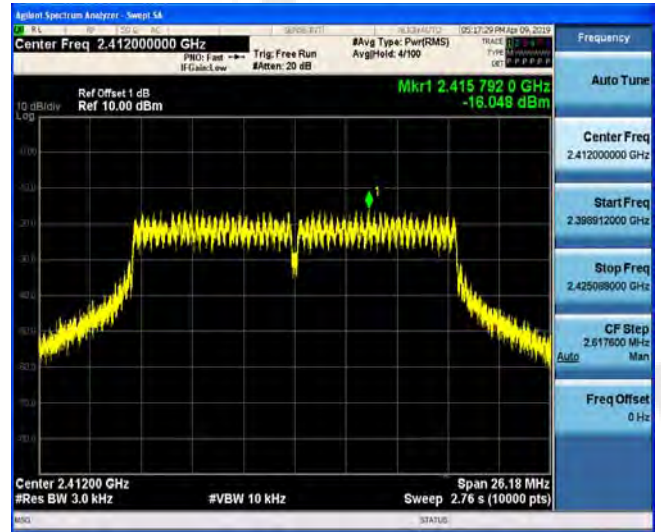

CH01

CH01

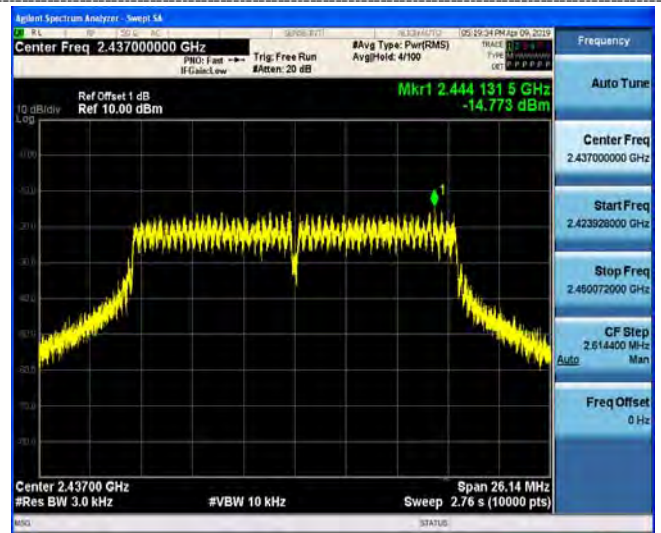

CH06

CH06

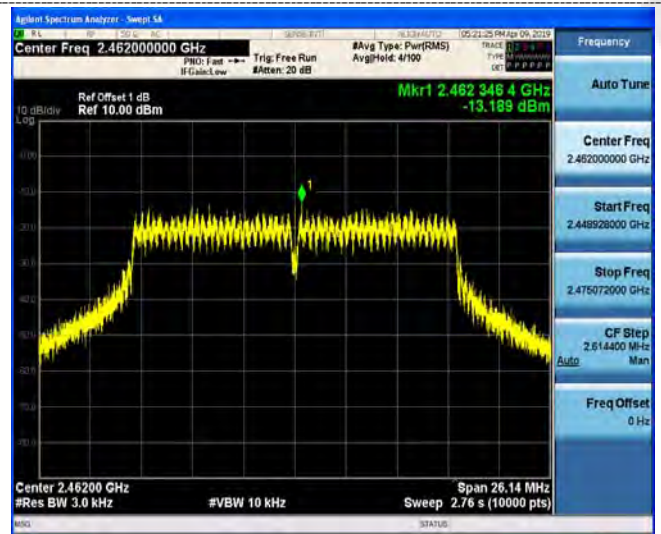

CH11

CH11

802.11n(HT20)

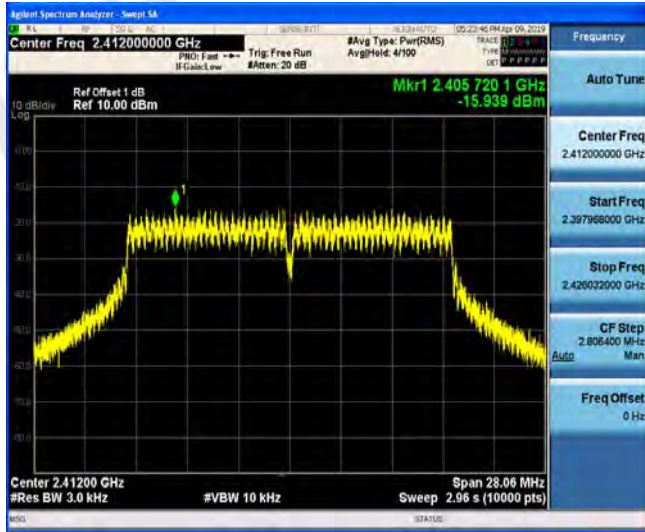

CH01

802.11n(HT40)

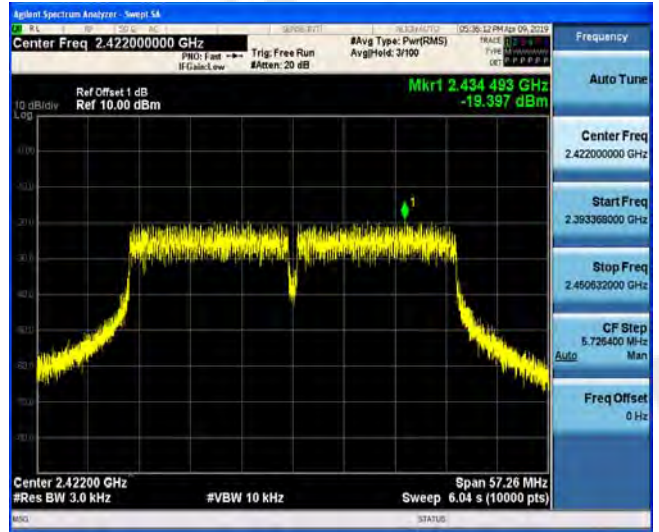

CH03

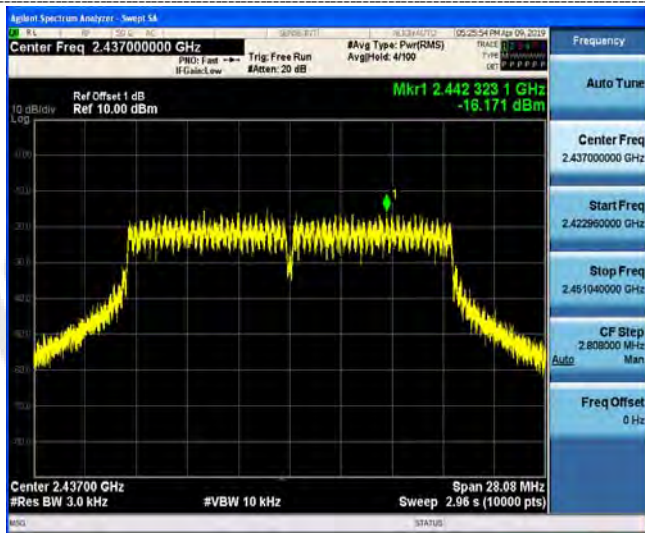

CH06

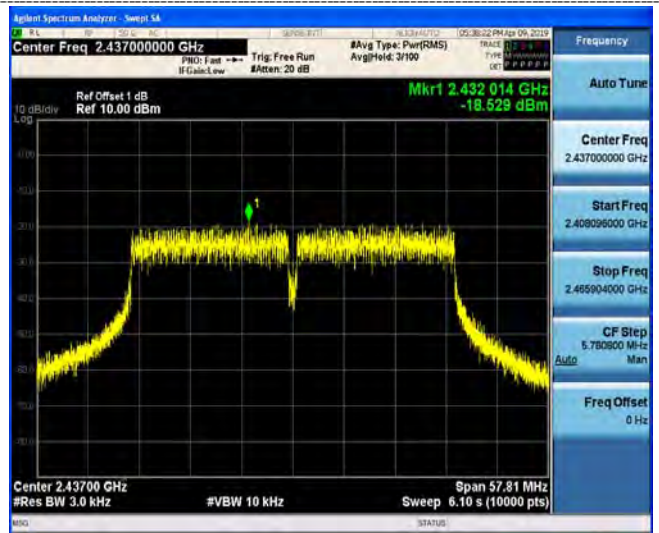

CH06

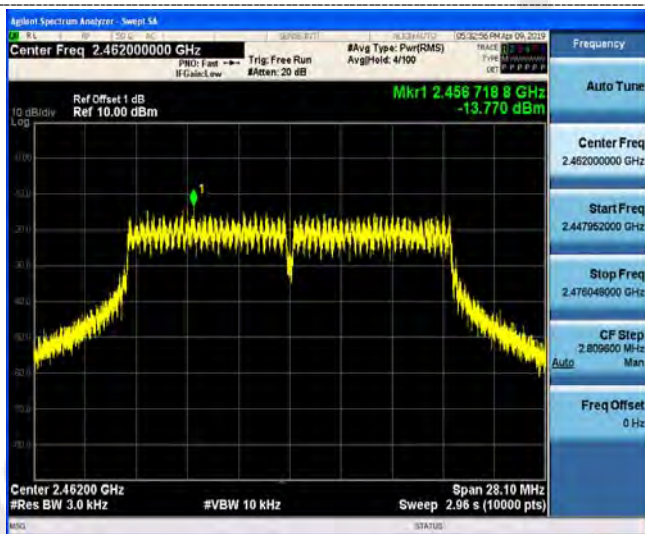

CH11

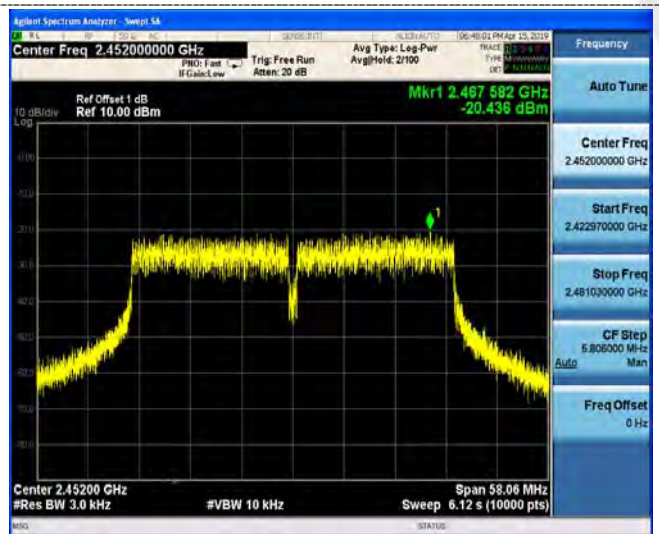

CH09

3.5. 6dB Bandwidth

Limit

For digital modulation systems, the minimum 6 dB bandwidth shall be at least 500 kHz

Test Procedure

The transmitter output was connected to the spectrum analyzer through an attenuator. The bandwidth of the fundamental frequency was measured by spectrum analyzer with 100 KHz RBW and 300 KHz VBW. The 6dB bandwidth is defined as the total spectrum the power of which is higher than peak power minus 6dB.

Test Configuration

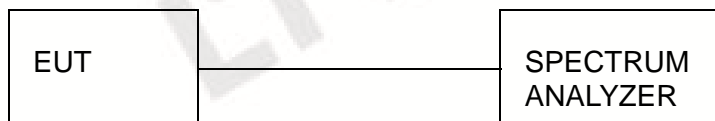

Test Results

WIFI

Type	Channel	6dB Bandwidth Ant1 (MHz)	6dB Bandwidth Ant2 (MHz)	Limit (KHz)	Result
802.11b	01	10.09	10.07	≥500	Pass
	06	10.03	10.05		
	11	10.09	10.07		
802.11g	01	16.36	16.36	≥500	Pass
	06	16.33	16.34		
	11	16.35	16.34		
802.11n(HT20)	01	17.55	17.54	≥500	Pass
	06	17.54	17.55		
	11	17.56	17.56		
802.11n(HT40)	03	36.11	35.79	≥500	Pass
	06	36.32	36.13		
	09	36.04	36.29		

Test plot as follows:

Ant.1

802.11b

802.11g

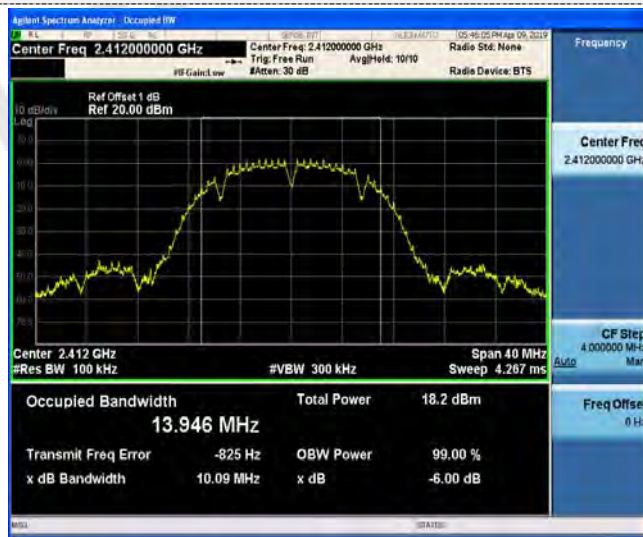

CH01

CH01



CH06

CH06



CH11

CH11

802.11n(HT20)



CH01

802.11n(HT40)

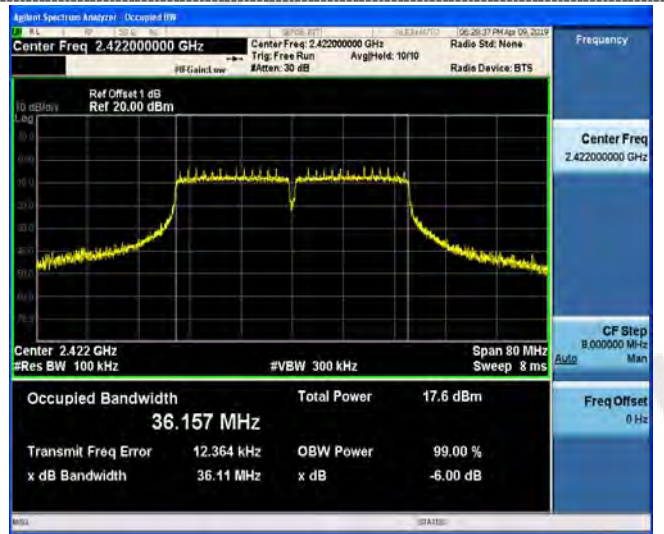

CH03

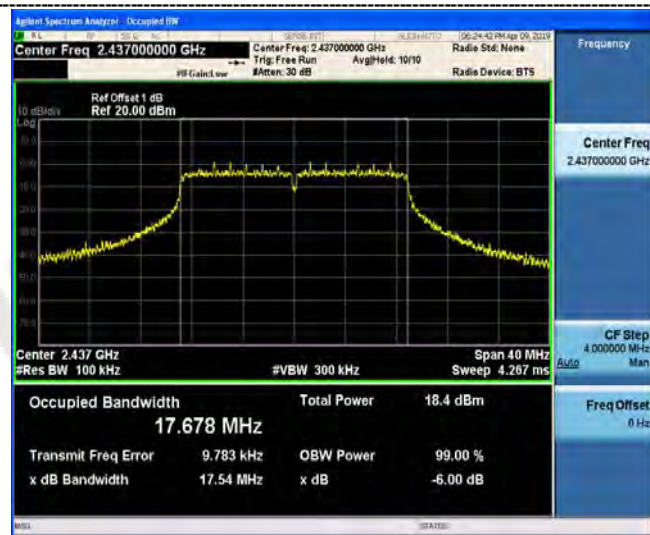

CH06

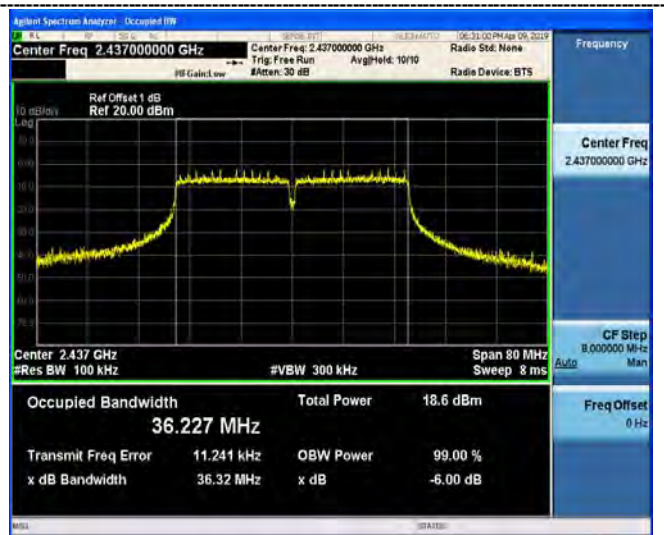

CH06



CH11

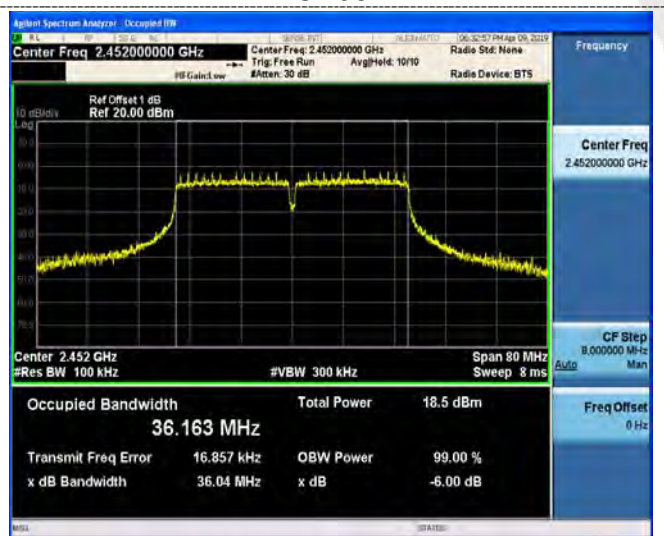

CH09

Ant.2

802.11b

802.11g

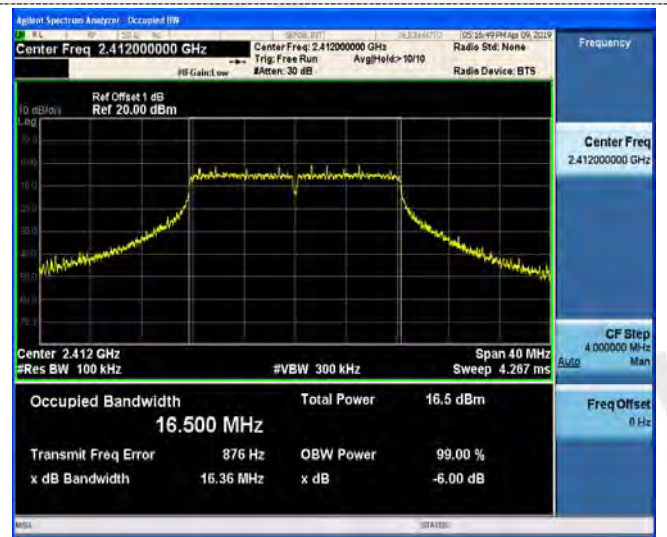
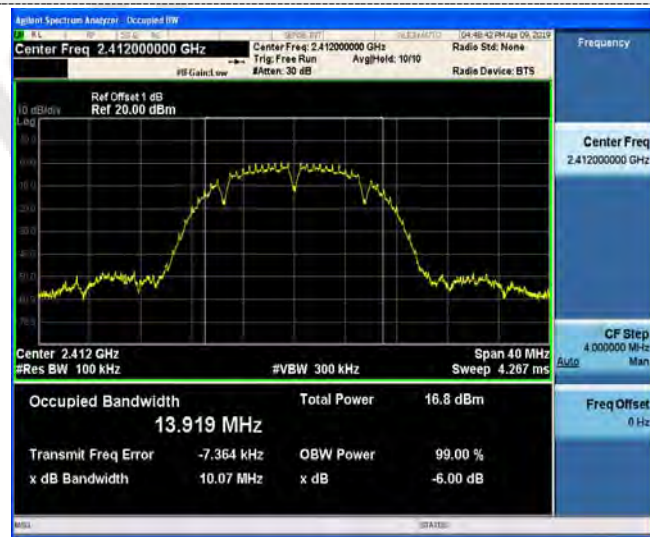

CH01

CH01

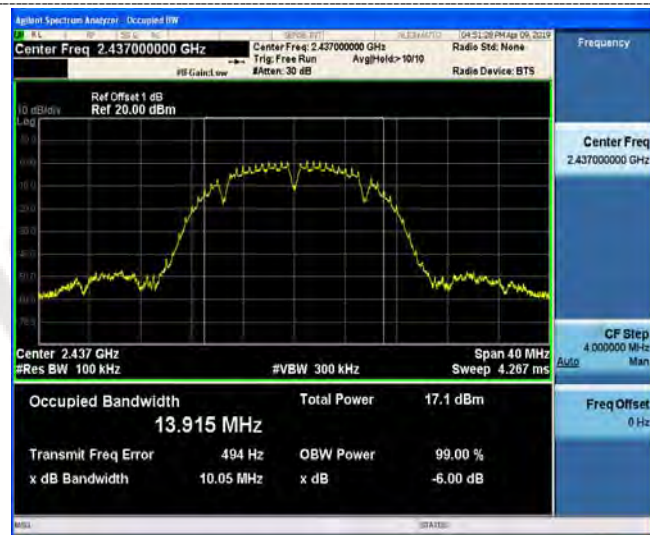

CH06

CH06

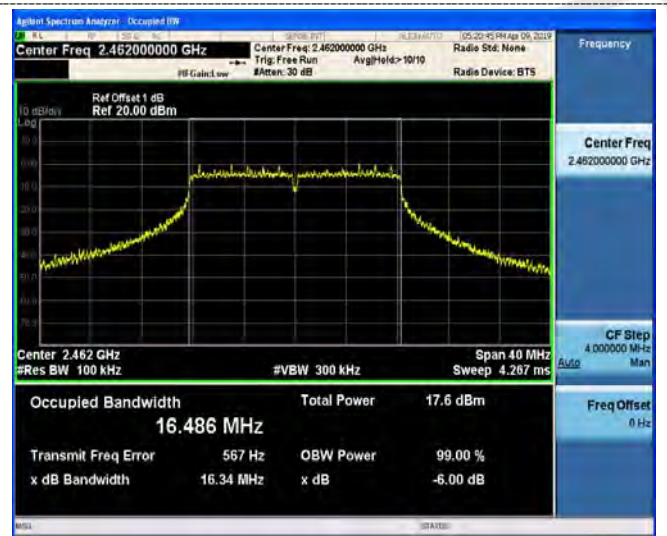
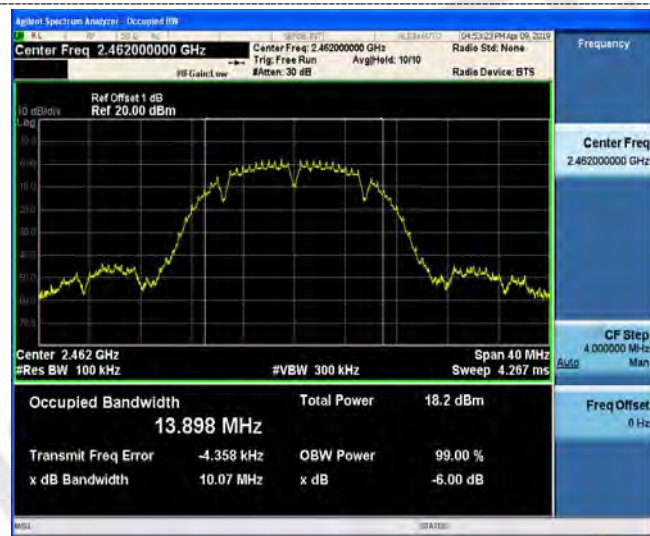

CH11

CH11

802.11n(HT20)

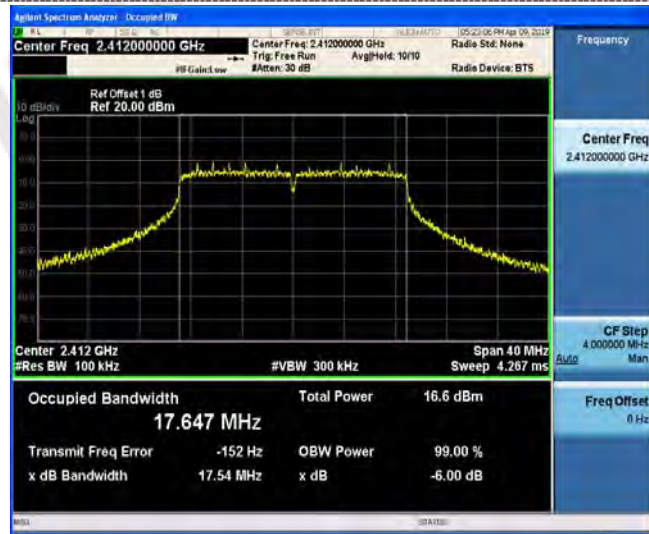

CH01

802.11n(HT40)



CH03

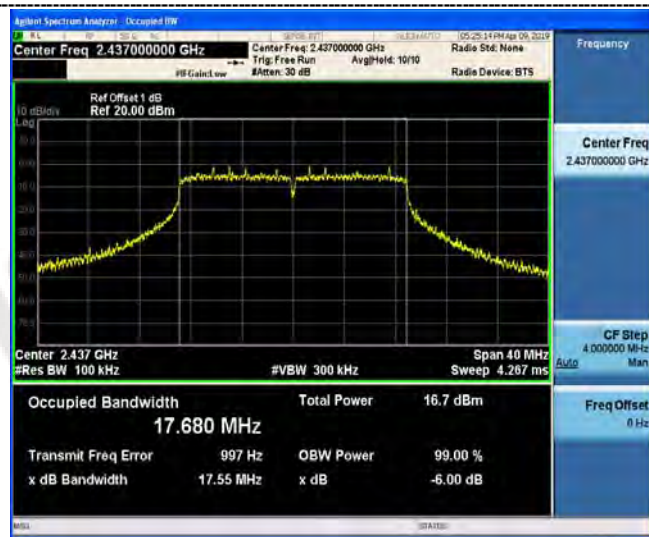

CH06



CH06

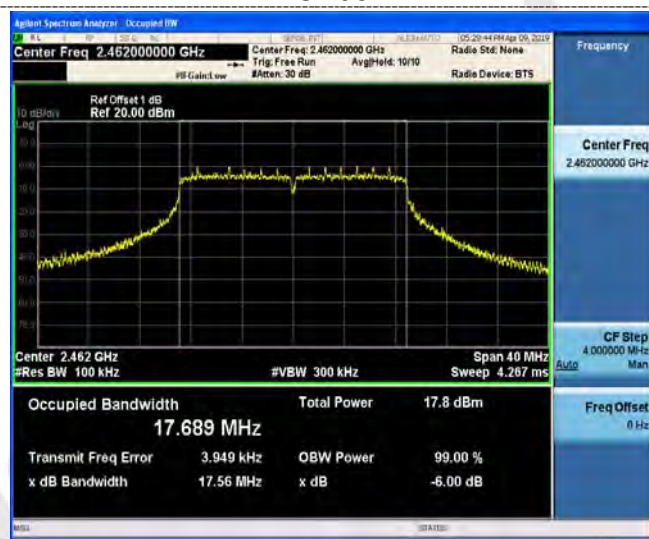

CH11



CH09

3.6. Out-of-band Emissions

Limit

In any 100 kHz bandwidth outside the frequency band in which the spread spectrum or digitally modulated intentional radiator is operating, the radio frequency power that is produced by the intentional radiator shall be at least 20 dB below that in the 100 kHz bandwidth within the band that contains the highest level of the desired power, based on either an RF conducted or a radiated measurement, provided the transmitter demonstrates compliance with the peak conducted power limits. If the transmitter complies with the conducted power limits based on the use of RMS averaging over a time interval, as permitted under paragraph (b)(3) of this section, the attenuation required under this paragraph shall be 30 dB instead of 20 dB. Attenuation below the general limits specified in §15.209(a) is not required.

Test Procedure

Connect the transmitter output to spectrum analyzer using a low loss RF cable, and set the spectrum analyzer to RBW=100 kHz, VBW= 300 kHz, peak detector , and max hold. Measurements utilizing these setting are made of the in-band reference level, bandedge and out-of-band emissions.

Test Configuration

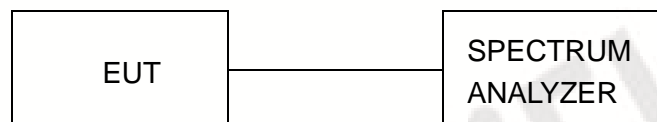

Test Results

Remark: The measurement frequency range is from 30MHz to the 10th harmonic of the fundamental frequency. The lowest, middle and highest channels are tested to verify the spurious emissions and bandage measurement data.

Test plot as follows:

Ant.1

802.11b CH01



802.11b CH06



Reference

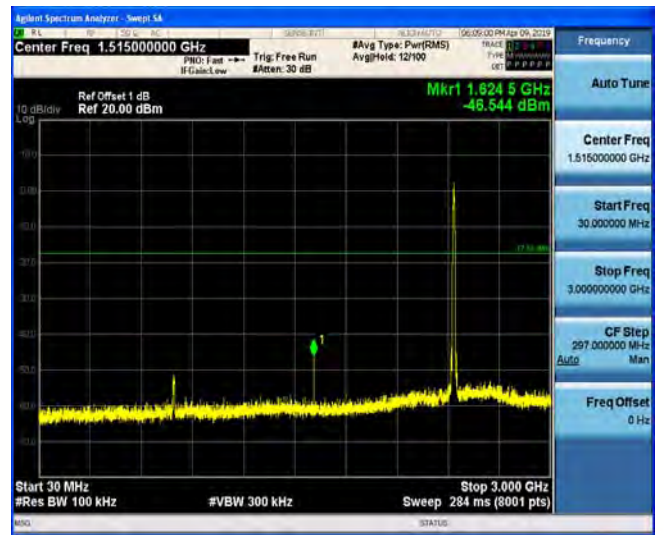
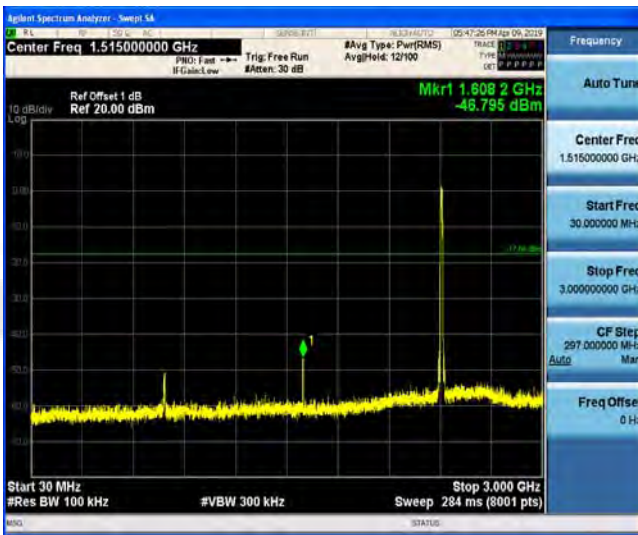

30MHz-3GHz

30MHz-3GHz



3GHz-25GHz

3GHz-25GHz

802.11b CH11



Reference

802.11g CH01



Reference

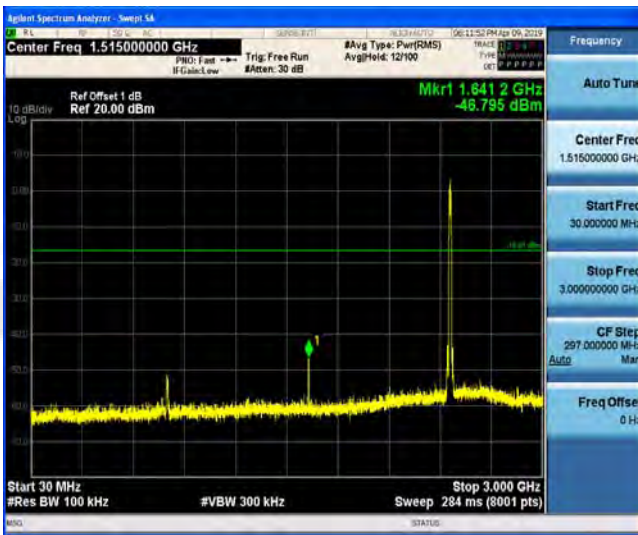

30MHz-3GHz

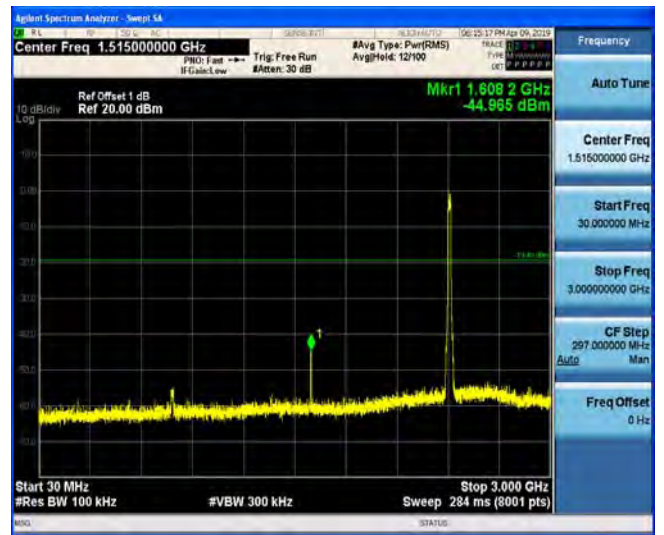

30MHz-3GHz

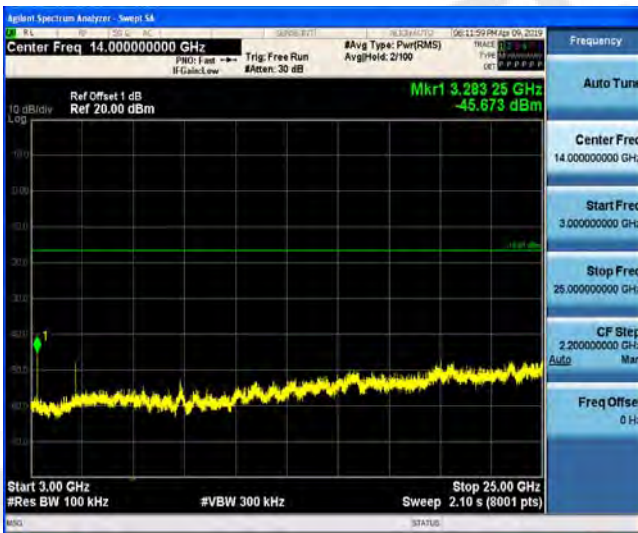

3GHz-25GHz



3GHz-25GHz

802.11g CH06



802.11g CH11

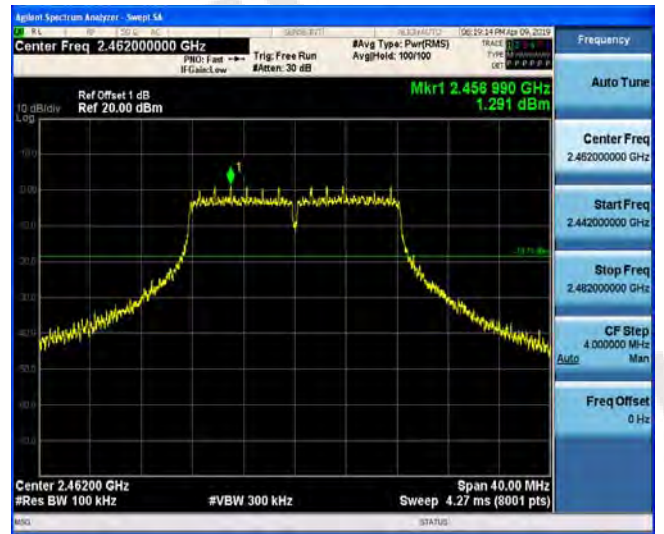

Reference

Reference

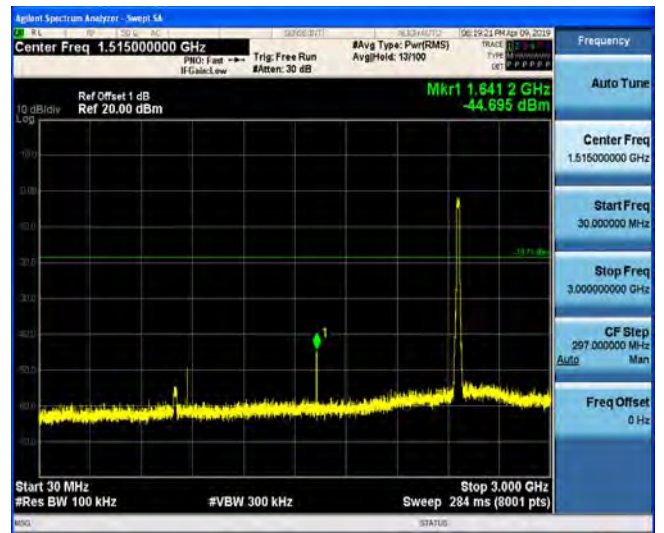
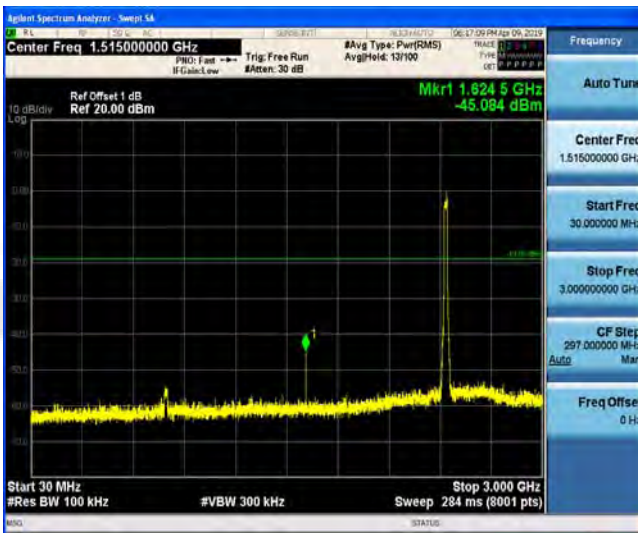

30MHz-3GHz

30MHz-3GHz

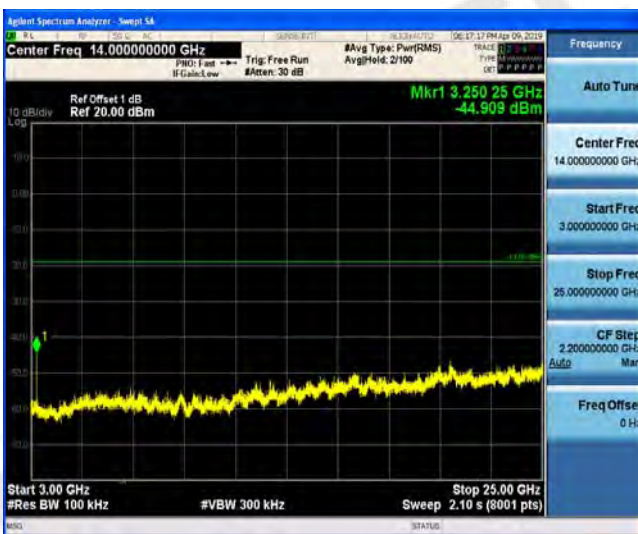

3GHz-25GHz

3GHz-25GHz

802.11n(HT20) CH01



802.11n(HT20) CH06



Reference

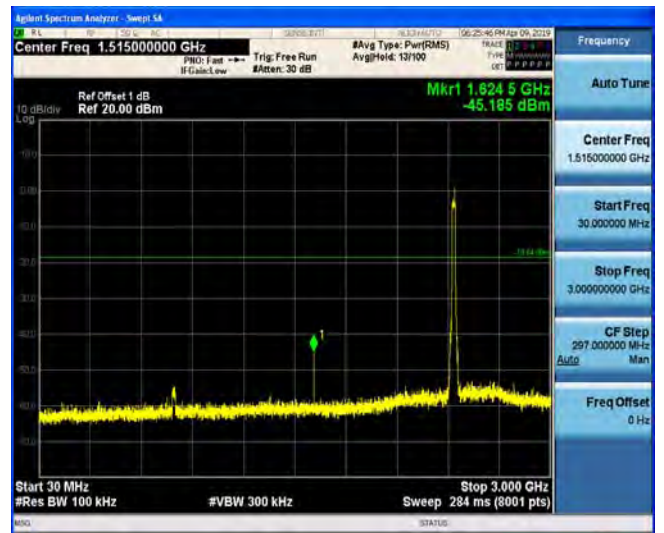
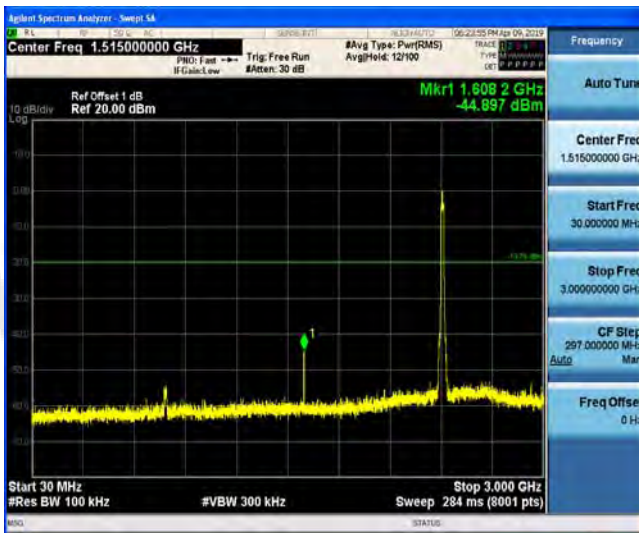

30MHz-3GHz

30MHz-3GHz



3GHz-25GHz

3GHz-25GHz

802.11n(HT20) CH11

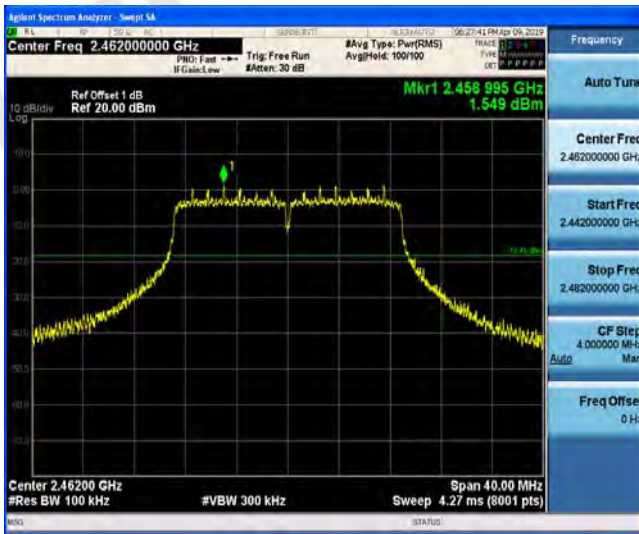

Reference

802.11n(HT40) CH03



Reference

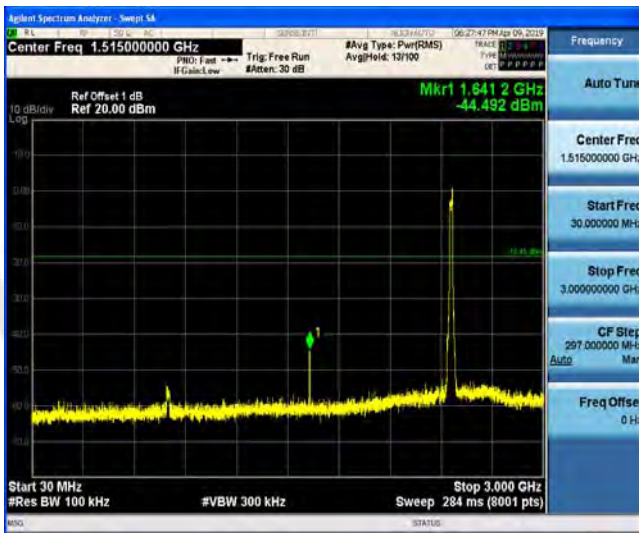

30MHz-3GHz

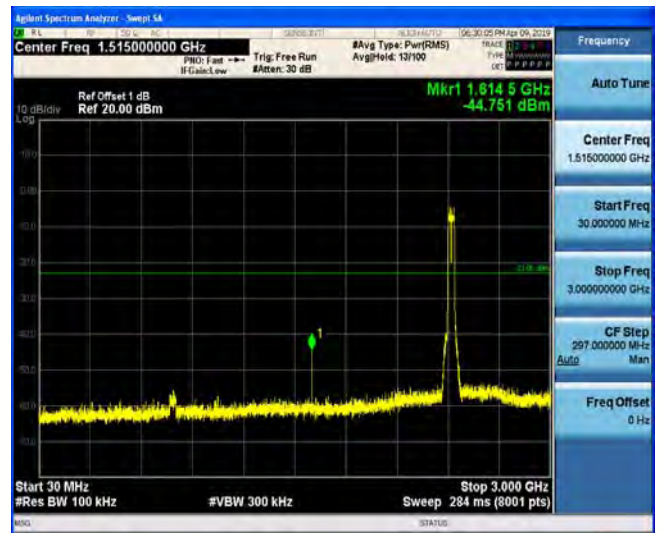

30MHz-3GHz



3GHz-25GHz



3GHz-25GHz

802.11n(HT40) CH06



Reference

802.11n(HT40) CH09



Reference

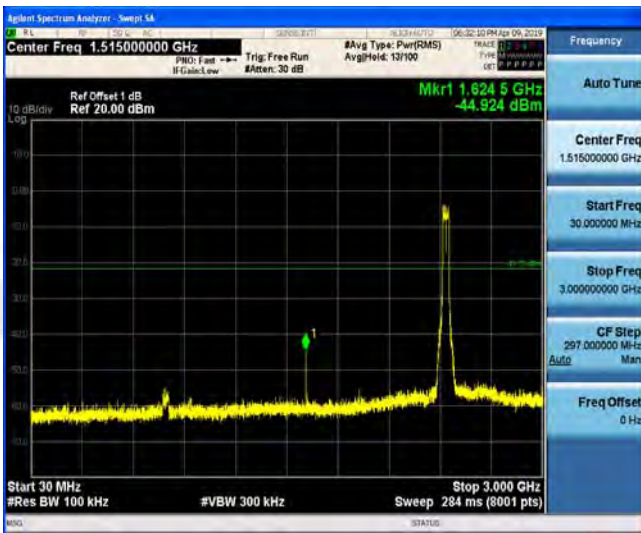

30MHz-3GHz

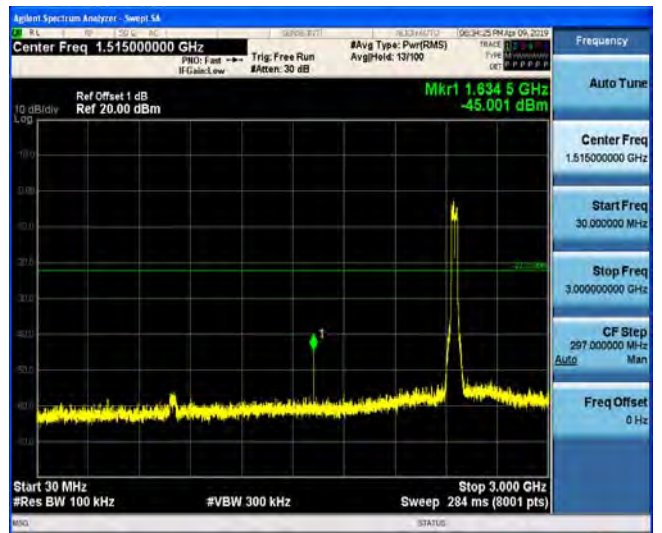

30MHz-3GHz



3GHz-25GHz



3GHz-25GHz

Band-edge Measurements for RF Conducted Emissions:

802.11b

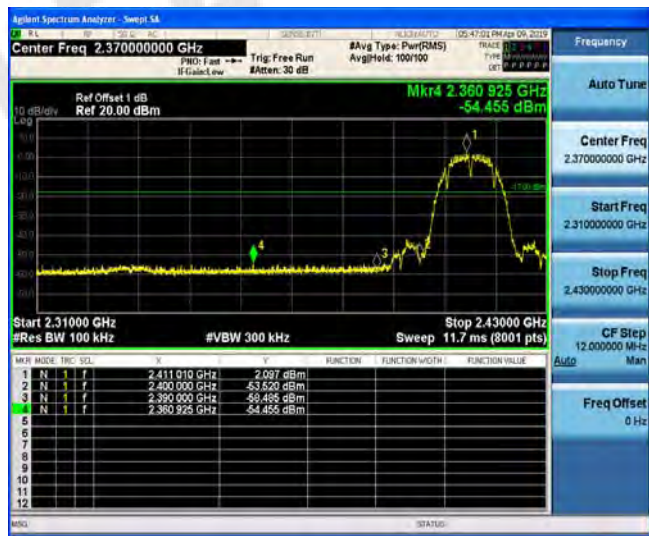

Left bandedge



Right bandedge

802.11g



Left bandedge

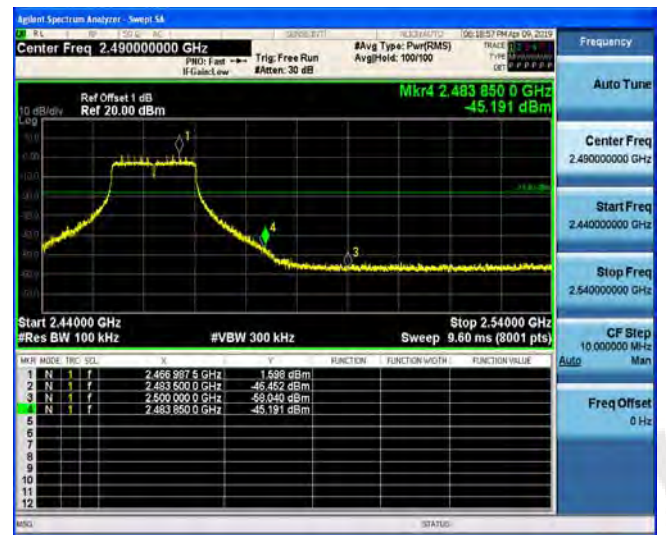

Right bandedge

802.11n(HT20)



Left bandedge



Right bandedge

802.11n(HT40)



Left bandedge



Right bandedge

Ant.2

802.11b CH01



802.11b CH06



Reference

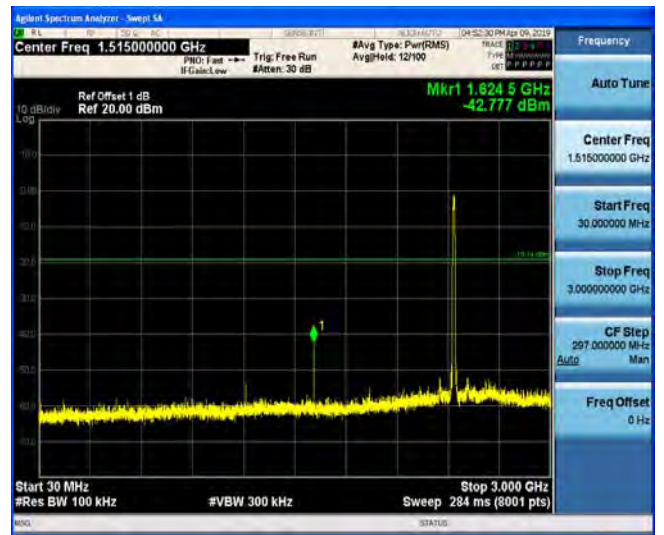
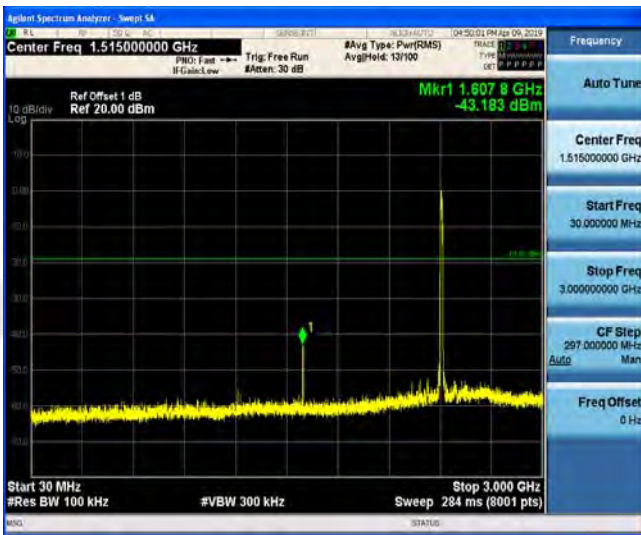

30MHz-3GHz

30MHz-3GHz



3GHz-25GHz

3GHz-25GHz

802.11b CH11



Reference

802.11g CH01



Reference

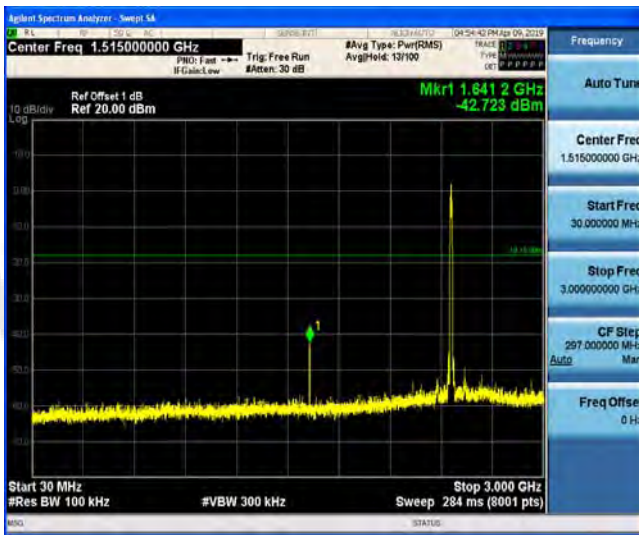

30MHz-3GHz

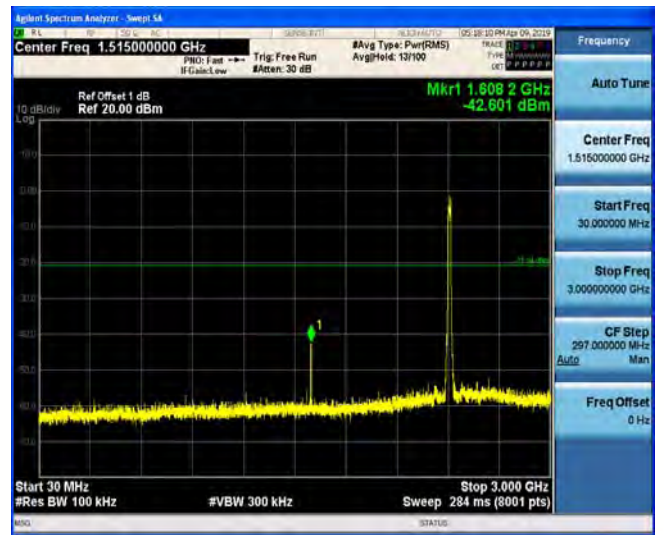

30MHz-3GHz



3GHz-25GHz



3GHz-25GHz

802.11g CH06



802.11g CH11



Reference

Reference

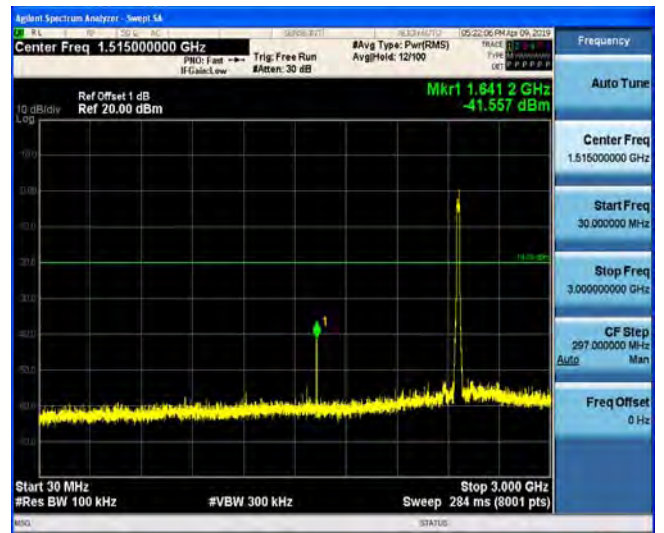
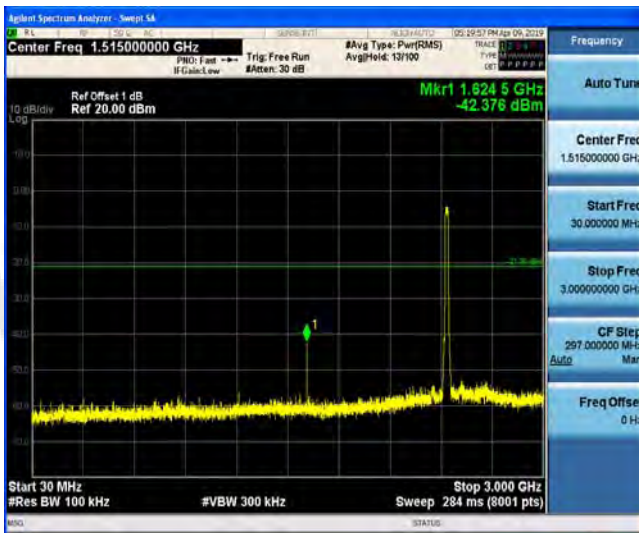

30MHz-3GHz

30MHz-3GHz



3GHz-25GHz

3GHz-25GHz

802.11n(HT20) CH01



802.11n(HT20) CH06



Reference

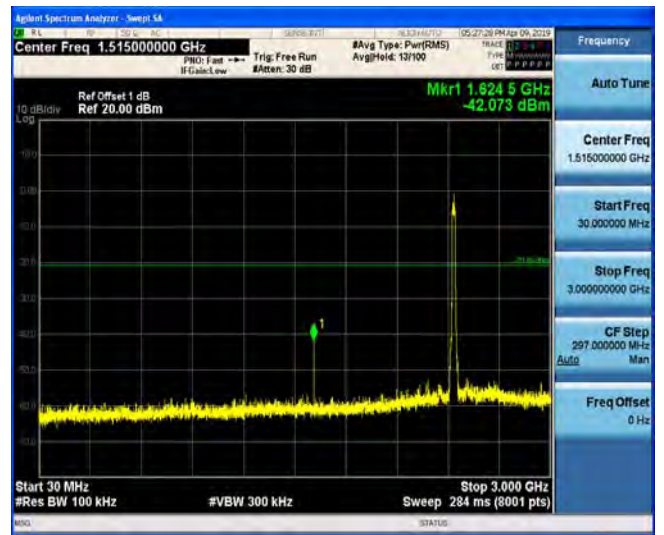
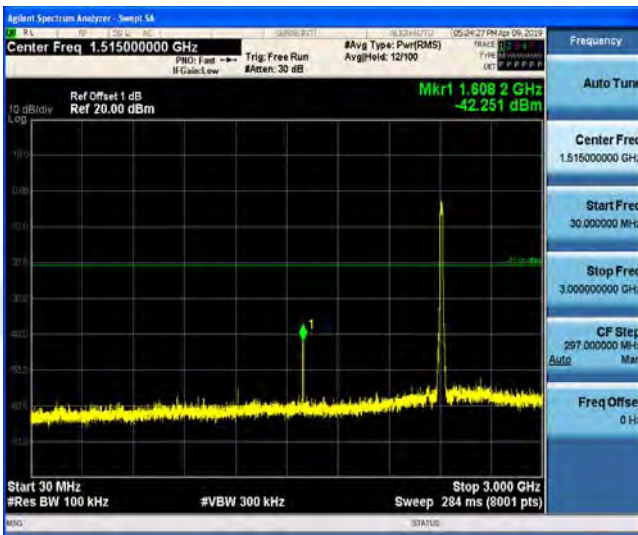

30MHz-3GHz

30MHz-3GHz



3GHz-25GHz

3GHz-25GHz

802.11n(HT20) CH11



Reference

802.11n(HT40) CH03



Reference

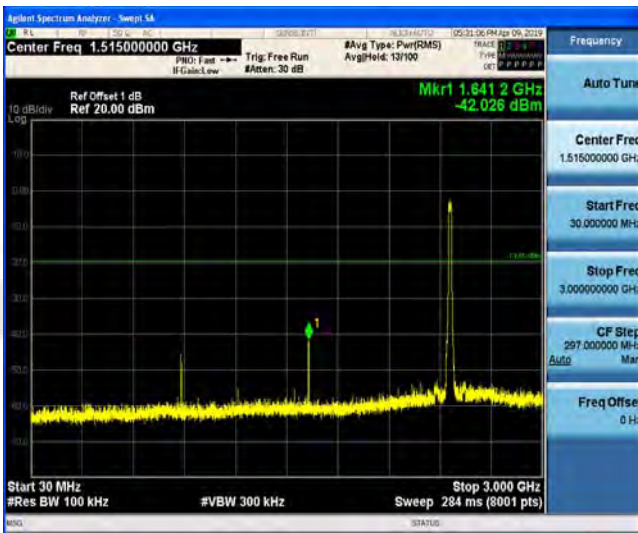

30MHz-3GHz

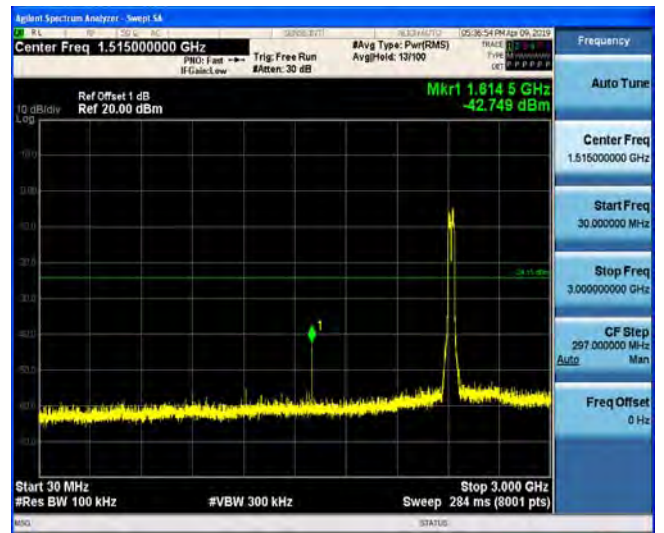

30MHz-3GHz



3GHz-25GHz



3GHz-25GHz

802.11n(HT40) CH06



Reference

802.11n(HT40) CH09

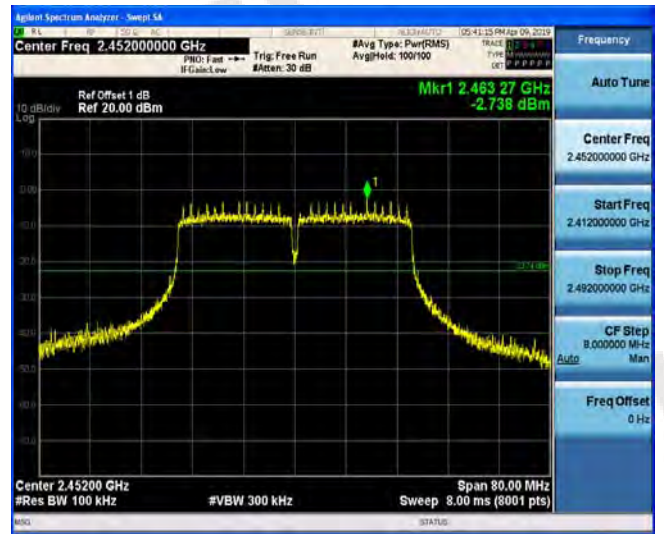

Reference

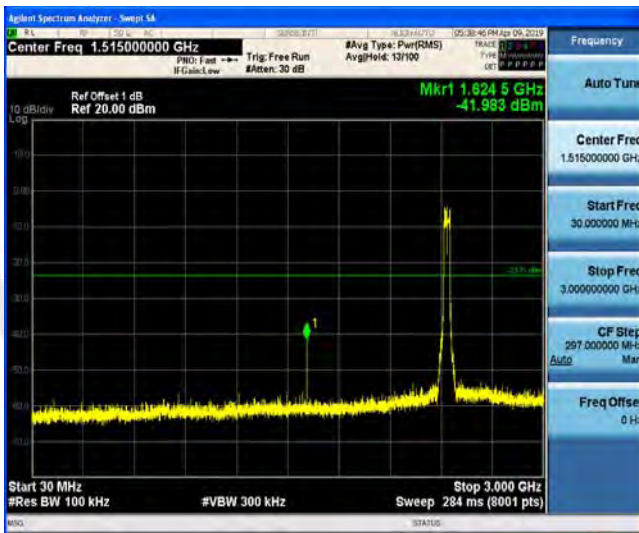

30MHz-3GHz

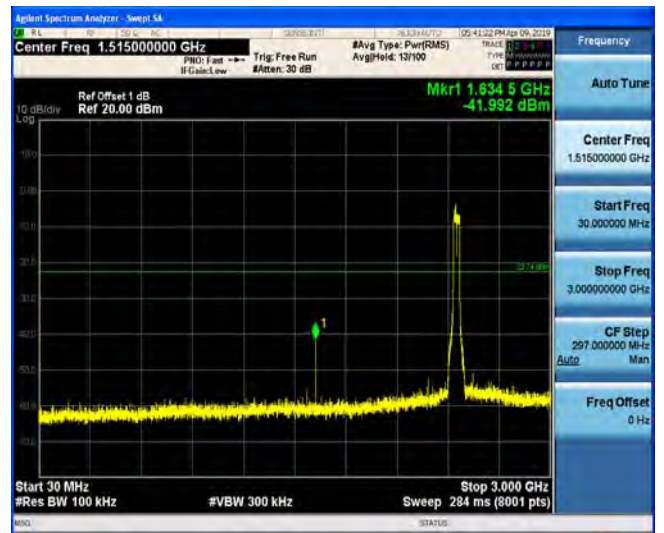

30MHz-3GHz



3GHz-25GHz



3GHz-25GHz

Band-edge Measurements for RF Conducted Emissions:

802.11b

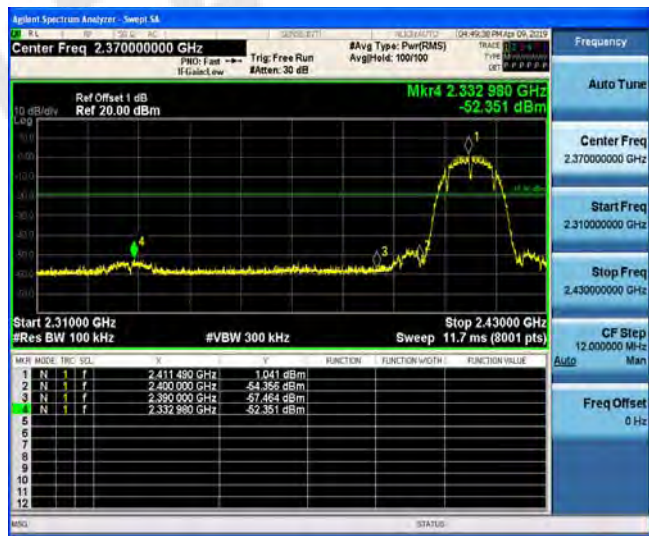

Left bandedge

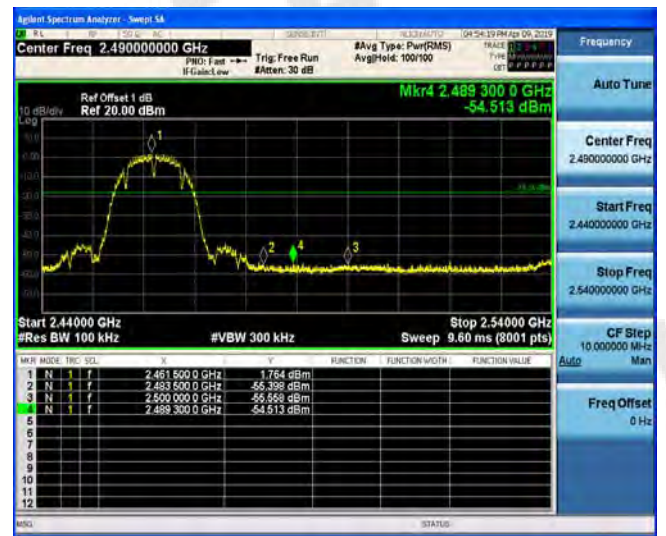

Right bandedge

802.11g



Left bandedge



Right bandedge

802.11n(HT20)



Left bandedge

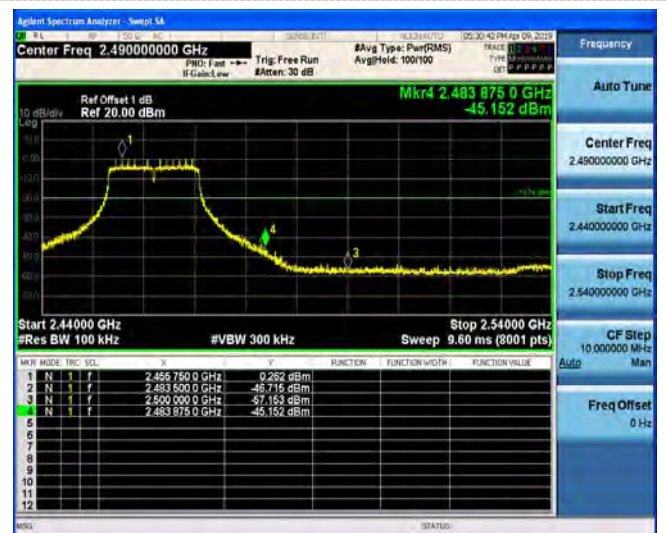

Right bandedge

802.11n(HT40)



Left bandedge



Right bandedge

3.7. Antenna Requirement

Standard Applicable

For intentional device, according to FCC 47 CFR Section 15.203:

An intentional radiator shall be designed to ensure that no antenna other than that furnished by the responsible party shall be used with the device. The use of a permanently attached antenna or of an antenna that uses a unique coupling to the intentional radiator, the manufacturer may design the unit so that a broken antenna can be replaced by the user, but the use of a standard antenna jack or electrical connector is prohibited

FCC CFR Title 47 Part 15 Subpart C Section 15.247(c) (1) (I):

(i) Systems operating in the 2400-2483.5 MHz band that is used exclusively for fixed. Point-to-point operations may employ transmitting antennas with directional gain greater than 6dBi provided the maximum conducted output power of the intentional radiator is reduced by 1 dB for every 3 dB that the directional gain of the antenna exceeds 6dBi.

Test Result:

The EUT used 2*TX 2*RX antenna, the maximum gain of WIFI antenna was 3dBi.

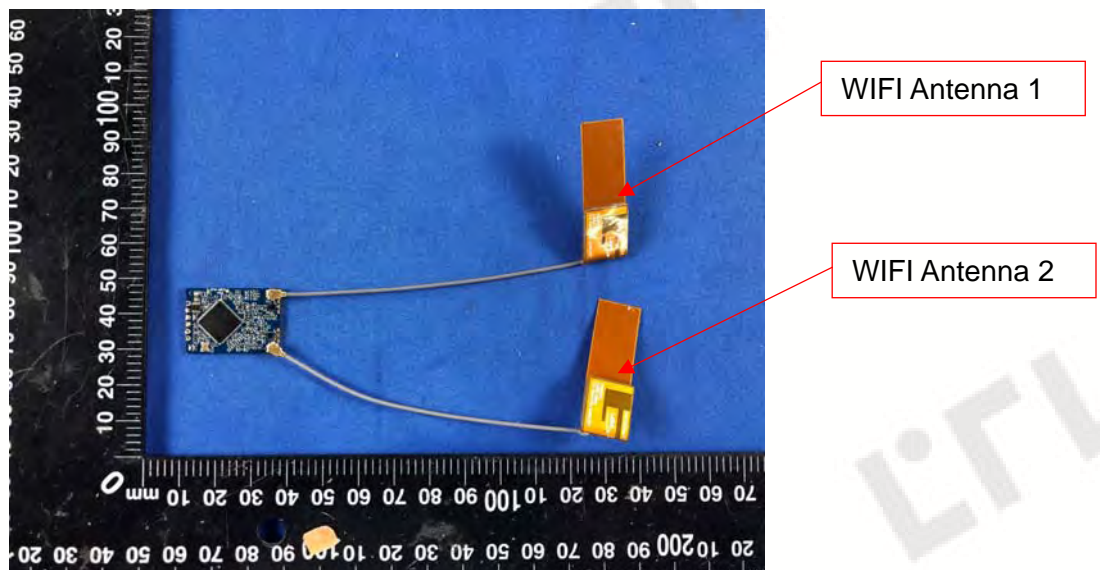

4. Test Setup Photos of the EUT



5. External and Internal Photos of the EUT

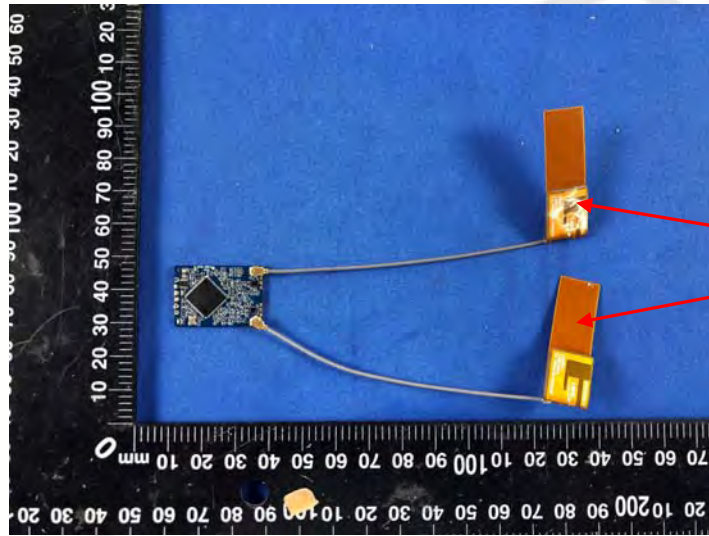

Antenna

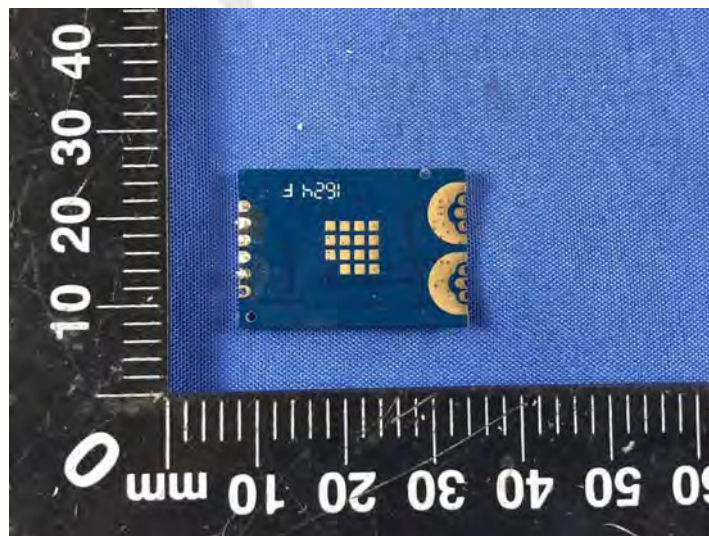
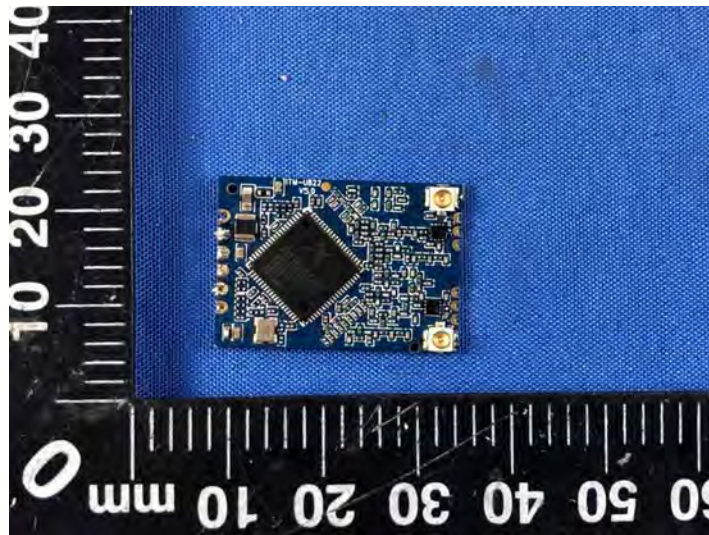

***** End of Report *****