

RADIO TEST REPORT

(FCC Part 15 Subpart E)



Applicant:	Power Idea Technology (Shenzhen) Co., Ltd.
Address:	4th Floor, A Section, Languang Science&technology Building, No.7 Xinxi RD, Hi-Tech Industrial Park North, Nanshan District, ShenZhen, P.R.C.

Manufacturer:	Power Idea Technology (Shenzhen) Co., Ltd.
Address:	4th Floor, A Section, Languang Science&technology Building, No.7 Xinxi RD, Hi-Tech Industrial Park North, Nanshan District, ShenZhen, P.R.C.
Product:	Smart Phone
Brand Name:	RugGear
Model Name:	PSM03G
Marketing name :	RG880
FCC ID:	ZLE-RG880
Date of tests:	Dec. 20, 2023 ~Mar. 20, 2024

The tests have been carried out according to the requirements of the following standard:

Part 15 Subpart E §15. 407

CONCLUSION: The submitted sample was found to COMPLY with the test requirement

Prepared by Hanwen Xu Engineer / Mobile Department	Approved by Peibo Sun Manager / Mobile Department
 Date: Mar. 20, 2024	 Date: Mar. 20, 2024

This report is governed by, and incorporates by reference, the Conditions of Testing as posted at the date of issuance of this report at <http://www.bureauveritas.com/home/about-us/our-business/cps/about-us/terms-conditions/> and is intended for your exclusive use. Any copying or replication of this report to or for any other person or entity, or use of our name or trademark, is permitted only with our prior written permission. This report sets forth our findings solely with respect to the test samples identified herein. The results set forth in this report are not indicative or representative of the quality or characteristics of the lot from which a test sample was taken or any similar or identical product unless specifically and expressly noted. Our report includes all of the tests requested by you and the results thereof based upon the information that you provided to us. Measurement uncertainty is only provided upon request for accredited tests. Statements of conformity are based on simple acceptance criteria without taking measurement uncertainty into account, unless otherwise requested in writing. You have 60 days from date of issuance of this report to notify us of any material error or omission caused by our negligence or if you require measurement uncertainty; provided, however, that such notice shall be in writing and shall specifically address the issue you wish to raise. A failure to raise such issue within the prescribed time shall constitute your unqualified acceptance of the completeness of this report, the tests conducted and the correctness of the report contents.



**BUREAU
VERITAS**

Test Report No.: PSU-QSU2312200110RF11

REPORT REVISE RECORD

ISSUE NO.	REASON FOR CHANGE	DATE ISSUED
PSU-QSU2312200110RF11	Original release	Mar. 20, 2024

TABLE OF CONTENTS

1	GENERAL DESCRIPTION.....	5
1.1	GENERAL DESCRIPTION OF EUT.....	5
1.2	MODIFICATION OF EUT	7
1.3	APPLICABLE STANDARDS	8
2	TEST CONFIGURATION OF EQUIPMENT UNDER TEST.....	9
2.1	CARRIER FREQUENCY AND CHANNEL	9
2.2	TEST MODE	10
2.3	SUPPORT EQUIPMENT	10
2.4	TEST SETUP.....	11
2.5	DFS DETECTION THRESHOLDS FOR MASTER DEVICES AND CLIENT DEVICES WITH RADAR DETECTION.....	12
3	REQUIREMENTS AND PARAMETERS FOR DFS TEST.....	13
3.1	APPLICABILITY OF DFS REQUIREMENTS	13
3.2	DFS RESPONSE REQUIREMENT VALUES	15
3.3	SHORT PULSE RADAR TEST WAVEFORMS.....	16
3.4	LONG PULSE RADAR TEST WAVEFORM.....	17
3.5	FREQUENCY HOPPING RADAR TEST WAVEFORM	17
4	CALIBRATION SETUP AND DFS TEST RESULTS.....	18
4.1	CALIBRATION OF RADAR WAVEFORM.....	18
4.2	IN-SERVICE MONITORING: CHANNEL MOVE TIME, CHANNEL CLOSING TRANSMISSION TIME AND NON-OCCUPANCY PERIOD.....	18
5	LIST OF MEASURING EQUIPMENT.....	21
6	APPENDIX.....	22
	CHANNEL MOVE TIME AND CHANNEL CLOSING TRANSMISSION TIME.....	22
	NON-OCCUPANCY PERIOD	25

SUMMARY OF DYNAMIC FREQUENCY SELECTION TEST

UNII	Bandwidth and Channel	Description	Measured	Limit	Result	Test Lab*
UNII Band 2-A 5250-5350MHz	80MHz (CH58) 5290MHz	Channel Move Time	0.000ms	10 sec	Pass	A
		Channel Closing Transmission time	<200ms + 24.7ms (aggregate)	200 ms + aggregate of 60 ms over remaining 10 s period	Pass	A
		Non-Occupancy Period and Client Beacon Test	No transmission or Beacons occurred	30 minutes	Pass	A
UNII Band 2-A 5250-5350MHz	80MHz (CH64) 5320MHz	Channel Move Time	0.000ms	10 sec	Pass	A
		Channel Closing Transmission time	<200ms + 22.1ms (aggregate)	200 ms + aggregate of 60 ms over remaining 10 s period	Pass	A
		Non-Occupancy Period and Client Beacon Test	No transmission or Beacons occurred	30 minutes	Pass	A

Note:

1. Since the product is client without radar detection function, only Channel Move Time, Channel Closing Transmission Time and Non-Occupancy Period Test are required to be performed.

***Test Lab Information Reference**

Lab A:

Huarui 7Layers High Technology (Suzhou) Co., Ltd.

Lab Address:

Tower N, Innovation Center, 88 Zhuyi Road, High-tech District, Suzhou City, Anhui Province

Accredited Test Lab Cert 6613.01

The FCC Site Registration No. is 434559; The Designation No. is CN1325.

1 GENERAL DESCRIPTION

1.1 GENERAL DESCRIPTION OF EUT

PRODUCT*	Smart Phone
BRAND NAME*	RugGear
MODEL NAME*	PSM03G
MARKETING NAME*	RG880
Power Supply*	5.0Vdc/ 9.0Vdc/ 12.0Vdc(Adapter) 3.85Vdc (Battery)
HW Version*	MP619_MB_V1.02_PCB
SW Version*	RG880_EEA_00.00_1_20240305
Modulation Technology	64QAM,16QAM, QPSK, BPSK for OFDM
Modulation Type	802.11a/n/ac : OFDM
Operating Frequency	U-NII-2A:5260~5320MHz
Antenna Type*	PIFA Antenna
Antenna Gain*	<5260 MHz ~ 5320 MHz> 0.8 dBi
I/O Ports*	Refer to user's manual

NOTE:

- *Since the above data and/or information is provided by the client relevant results or conclusions of this report are only made for these data and/or information, Test Lab is not responsible for the authenticity, integrity and results of the data and information and/or the validity of the conclusion.
- For a more detailed features description, please refer to the manufacturer's specifications or the user's manual.
- For the test results, the EUT had been tested with all conditions. But only the worst case was shown in the test report.
- Antenna gain and EUT conducted cable loss are provided by the customer, and the laboratory will record the results based on these items that involve these two parameters.

5. List of Accessory:

ACCESSORIES	BRAND	MANUFACTURER	MODEL	SPECIFICATION
CPU	QUALCOMM	N/A	SM6225	N/A
eMMC 1 (=ROM 1)	SAMSUNG	N/A	KM2L9001CM-B518	N/A



eMMC 2 (=ROM 2)	Hynix	N/A	H9QT0GECN6X145R	N/A
RAM 1	N/A	N/A	N/A	N/A
RAM 2	N/A	N/A	N/A	N/A
BT/WLAN Module	N/A	N/A	N/A	N/A
NFC chipset	NXP	N/A	N/A	N/A
Battery	N/A	N/A	BL450AGP	Power Rating: 4.4V 4500mAh
Adapter	N/A	SHENZHEN MERRYKING ELECTRONICS CO.. LTD	MK-Q181US	I/P: 100-240Vac, 50/60Hz, 0.5A, O/P:5.0V 3.0A or 9.0V 2.0A or 12.0V 1.5A
USB Cable	N/A	Huizhou Huating Technology Co., Ltd	USB1.0	Signal Line,1.0meter



Test Report No.: PSU-QSU2312200110RF11

1.2 MODIFICATION OF EUT

No modifications are made to the EUT during all test items.

1.3 APPLICABLE STANDARDS

According to the specifications of the manufacturer, the EUT must comply with the requirements of the following standards:

- ♦ FCC Part 15 Subpart E §15.407
- ♦ FCC KDB 905462 D02 UNII DFS Compliance Procedures New Rules v02
- ♦ FCC KDB 905462 D03 UNII Clients Without Radar Detection New Rules v01r02
- ♦ The FCC Site Registration No. is 434559; The Designation No. is CN1325.



2 TEST CONFIGURATION OF EQUIPMENT UNDER TEST

2.1 CARRIER FREQUENCY AND CHANNEL

U-NII-2A

CHANNEL	FREQUENCY	CHANNEL	FREQUENCY
52	5260 MHz	60	5300 MHz
54	5270 MHz	62	5310 MHz
56	5280 MHz	64	5320 MHz
58	5290 MHz		

2.2 TEST MODE

Additional requirements for devices with multiple bandwidth modes	Master Device or Client with Radar Detection	Client Without Radar Detection
U-NII Detection Bandwidth and Statistical Performance Check	All BW modes must be tested	Not required
Channel Move Time and Channel Closing Transmission Time	Test using widest BW mode available	Test using the widest BW mode available for the link
All other tests	Any single BW mode	Not required

Note: Frequencies selected for statistical performance check (Section 7.8.4) should include several frequencies within the radar detection bandwidth and frequencies near the edge of the radar detection bandwidth. For 802.11 devices it is suggested to select frequencies in each of the bonded 20 MHz channels and the channel center frequency.

2.3 SUPPORT EQUIPMENT

Item	Equipment	Trade Name	Model Name	FCC ID	Data Cable	Power Cord
1.	Wireless Router	ASUS	RT-AX88U	N/A	N/A	Unshielded, 1.8 m
2.	Notebook	Lenovo	PC-8	N/A	N/A	shielded cable DC O/P 1.8 m unshielded AC I/P cable 1.2 m

2.4 TEST SETUP

Master Modes

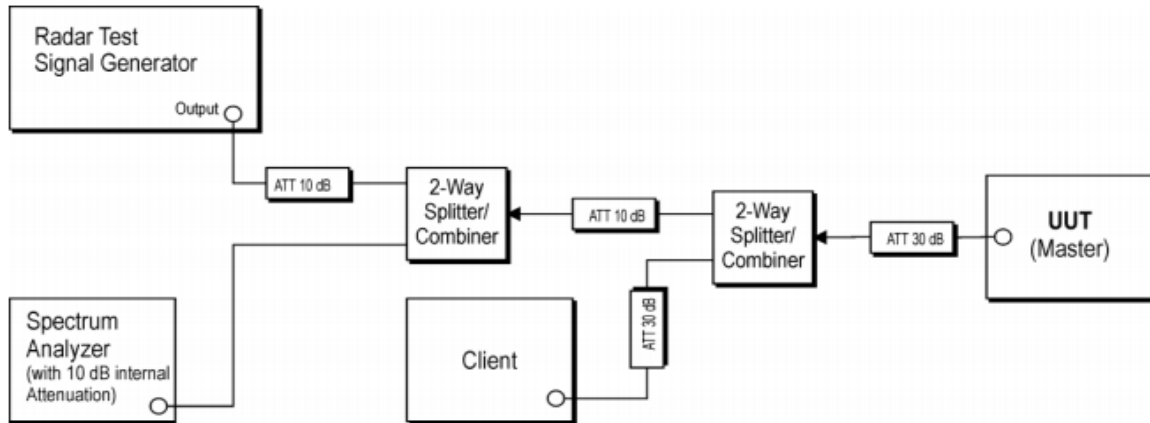

Client with injection at the Client Modes

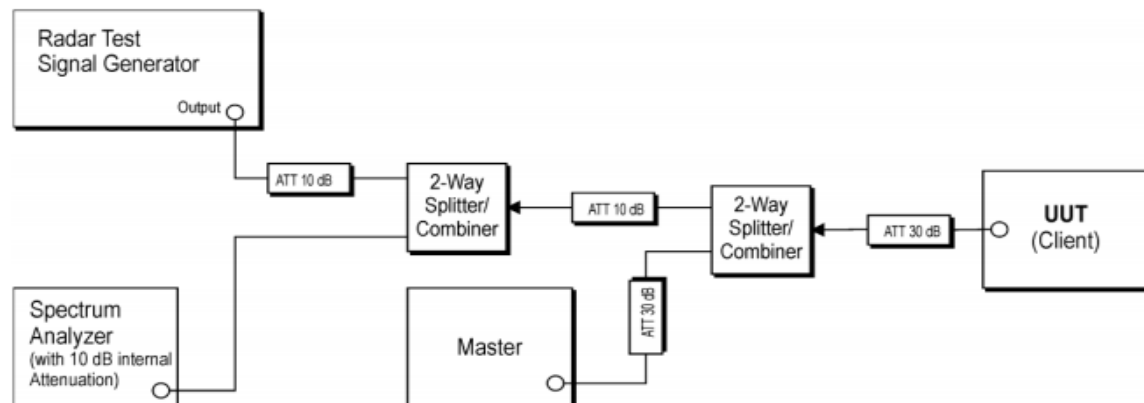

Client with injection at the Master Modes

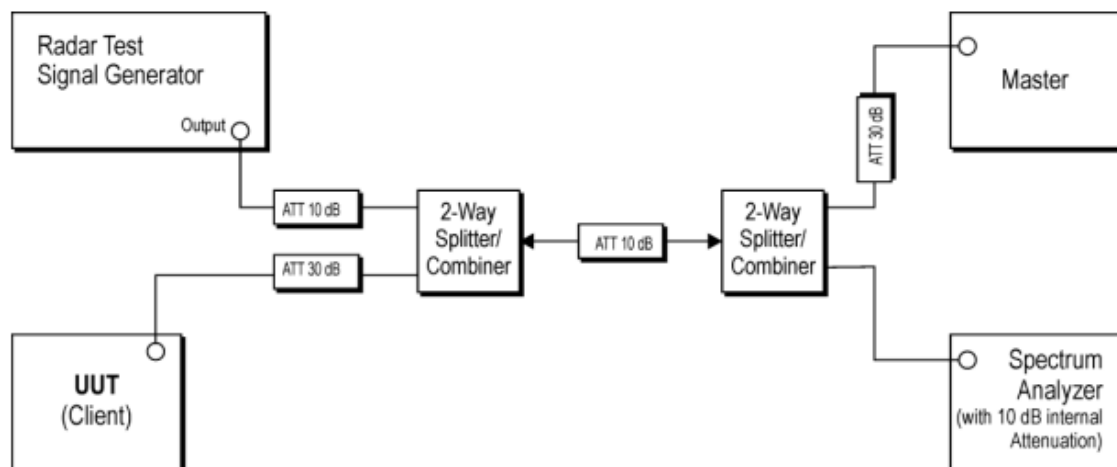

2.5 DFS DETECTION THRESHOLDS FOR MASTER DEVICES AND CLIENT DEVICES WITH RADAR DETECTION

Maximum Transmit Power	Value (See Notes 1, 2, and 3)
EIRP \geq 200 milliwatt	-64 dBm
EIRP < 200 milliwatt and power spectral density < 10 dBm/MHz	-62 dBm
EIRP < 200 milliwatt that do not meet the power spectral density requirement	-64 dBm

Note 1: This is the level at the input of the receiver assuming a 0 dBi receive antenna.

Note 2: Throughout these test procedures an additional 1 dB has been added to the amplitude of the test transmission waveforms to account for variations in measurement equipment. This will ensure that the test signal is at or above the detection threshold level to trigger a DFS response.

Note3: EIRP is based on the highest antenna gain.

The radar Detection Threshold, lowest antenna gain is the parameter of Interference radar DFS detection threshold, The Interference Detection Threshold is the (-62dBm) + (-1) [dBi]+ 1 dB= -62 dBm.

3 REQUIREMENTS AND PARAMETERS FOR DFS TEST

3.1 APPLICABILITY OF DFS REQUIREMENTS

EUT is client and operates as client without radar detection function.

Table 1: Applicability of DFS Requirements Prior to Use of a Channel

Requirement	Operational Mode		
	Master	Client Without Radar Detection	Client With Radar Detection
Non-Occupancy Period	Yes	Not required	Yes
DFS Detection Threshold	Yes	Not required	Yes
Channel Availability Check Time	Yes	Not required	Not required
U-NII Detection Bandwidth	Yes	Not required	Yes

Table 2: Applicability of DFS requirements during normal operation

Requirement	Operational Mode		
	Master	Client Without Radar Detection	Client With Radar Detection
DFS Detection Threshold	Yes	Not required	Yes
Channel Closing Transmission Time	Yes	Yes	Yes
Channel Move Time	Yes	Yes	Yes
U-NII Detection Bandwidth	Yes	Not required	Yes
Client Beacon Test	N/A	Yes	Yes



Additional requirements for devices with multiple bandwidth modes	Operational Mode	
	Master or Client With Radar Detection	Client Without Radar Detection
U-NII Detection Bandwidth and Statistical Performance Check	All BW modes must be tested	Not required
Channel Move Time and Channel Closing Transmission Time	Test using widest BW mode available	Test using the widest BW mode available for the link
All other tests	Any single BW mode	Not required

Note

Frequencies selected for statistical performance check should include several frequencies within the radar detection bandwidth and frequencies near the edge of the radar detection bandwidth. For 802.11 devices it is suggested to select frequencies in each of the bonded 20 MHz channels and the channel center frequency.

3.2 DFS RESPONSE REQUIREMENT VALUES

Parameter	Value
<i>Non-occupancy period</i>	Minimum 30 minutes
<i>Channel Availability Check Time</i>	60 seconds
<i>Channel Move Time</i>	10 seconds See Note 1.
<i>Channel Closing Transmission Time</i>	200 milliseconds + an aggregate of 60 milliseconds over remaining 10 second period. See Notes 1 and 2.
<i>U-NII Detection Bandwidth</i>	Minimum 100% of the 99% power bandwidth See Note 3.
<p>Note 1: The instant that the <i>Channel Move Time</i> and the <i>Channel Closing Transmission Time</i> begins is as follows:</p> <ul style="list-style-type: none"> • For the Short pulse radar Test Signals this instant is the end of the <i>Burst</i>. • For the Frequency Hopping radar Test Signal, this instant is the end of the last radar <i>Burst</i> generated. • For the Long Pulse radar Test Signal this instant is the end of the 12 second period defining the radar transmission. <p>Note 2: The <i>Channel Closing Transmission Time</i> is comprised of 200 milliseconds starting at the beginning of the <i>Channel Move Time</i> plus any additional intermittent control signals required to facilitate <i>Channel</i> changes (an aggregate of 60 milliseconds) during the remainder of the 10 second period. The aggregate duration of control signals will not count quiet periods in between transmissions.</p> <p>Note 3: During the <i>U-NII Detection Bandwidth</i> detection test, radar type 0 is used and for each frequency step the minimum percentage of detection is 90%. Measurements are performed with no data traffic.</p>	

3.3 SHORT PULSE RADAR TEST WAVEFORMS

As the EUT is a Client Device with no Radar Detection, only one type radar pulse is required for the testing. Radar Pulse type 0 was used in the evaluation of the Client device for the purpose of measuring the Channel Move Time and the Channel Closing Transmission Time.

Radar Type	Pulse Width (μsec)	PRI (μsec)	Number of Pulses	Minimum Percentage of Successful Detection	Minimum Trials
0	1	1428	18	60%	30
1	1	Test A Test B	Roundup $\left\{ \left(\frac{1}{360} \right) \cdot \left(\frac{19 \cdot 10^6}{\text{PRI}_{\mu\text{sec}}} \right) \right\}$	60%	30
2	1-5	150-230	23-29	60%	30
3	6-10	200-500	16-18	60%	30
4	11-20	200-500	12-16	60%	30
Aggregate (Radar Types 1-4)				80%	120
Note 1: Short Pulse Radar Type 0 should be used for the detection bandwidth test, channel move time, and channel closing time tests.					

Test A: 15 unique PRI values randomly selected from the list of 23 PRI values in Table 5a.

Test B: 15 unique PRI values randomly selected within the range of 518-3066 μsec, with a minimum increment of 1 μsec, excluding PRI values selected in Test A

A minimum of 30 unique waveforms are required for each of the short pulse radar types 2 through 4. For short pulse radar type 1, the same waveform is used a minimum of 30 times. If more than 30 waveforms are used for short pulse radar types 2 through 4, then each additional waveform must also be unique and not repeated from the previous waveforms.

If more than 30 waveforms are used for Short Pulse Radar Type 1, then each additional waveform is generated with Test B and must also be unique and not repeated from the previous waveforms in Tests A or B.

The aggregate is the average of the percentage of successful detections of short pulse radar types 1-4.

3.4 LONG PULSE RADAR TEST WAVEFORM

Radar Type	Pulse Width (μsec)	Chirp Width (MHz)	PRI (μsec)	Number of Pulses per Burst	Number of Bursts	Minimum Percentage of Successful Detection	Minimum Number of Trials
5	50-100	5-20	1000-2000	1-3	8-20	80%	30

The parameters for this waveform are randomly chosen. Thirty unique waveforms are required for the Long Pulse Radar Type waveforms. If more than 30 waveforms are used for the Long Pulse Radar Type waveforms, then each additional waveform must also be unique and not repeated from the previous waveforms.

3.5 FREQUENCY HOPPING RADAR TEST WAVEFORM

Radar Type	Pulse Width (μsec)	PRI (μsec)	Pulses per Hop	Hopping Rate (kHz)	Hopping Sequence Length (msec)	Minimum Percentage of Successful Detection	Minimum Number of Trials
6	1	333	9	0.333	300	70%	30

For the Frequency Hopping Radar Type, the same Burst parameters are used for each waveform. The hopping sequence is different for each waveform and a 100-length segment is selected from the hopping sequence defined by the following algorithm:

The first frequency in a hopping sequence is selected randomly from the group of 475 integer frequencies from 5250 – 5724 MHz Next, the frequency that was just chosen is removed from the group and a frequency is randomly selected from the remaining 474 frequencies in the group. This process continues until all 475 frequencies are chosen for the set. For selection of a random frequency, the frequencies remaining within the group are always treated as equally likely.

4 CALIBRATION SETUP AND DFS TEST RESULTS

4.1 CALIBRATION OF RADAR WAVEFORM

4.1.1 RADAR WAVEFORM CALIBRATION PROCEDURE

The Interference **Radar Detection Threshold Level** is $(-62\text{dBm}) + (-1) [\text{dBi}] + 1 \text{ dB} = -62\text{dBm}$ that had been taken into account the output power range and antenna gain. The following equipment setup was used to calibrate the radiated Radar Waveform. A vector signal generator was utilized to establish the test signal level for radar type 0. During this process there were no transmissions by either the Master or Client Device. The spectrum analyzer was switched to the zero span (Time Domain) at the frequency of the Radar Waveform generator. Peak detection was used. The spectrum analyzer resolution bandwidth (RBW) and video bandwidth (VBW) were set to 3 MHz to measure the type 0 radar waveform. Capture the spectrum analyzer plots on short pulse radar waveform.

4.1.2 RADAR WAVEFORM CALIBRATION RESULT

Please Refer to Appendix Of this test report.

4.2 IN-SERVICE MONITORING: CHANNEL MOVE TIME, CHANNEL CLOSING TRANSMISSION TIME AND NON-OCCUPANCY PERIOD

4.2.1 LIMIT OF IN-SERVICE MONITORING

The EUT has an In-Service Monitoring function to continuously monitor the radar signals, If radar is detected, it must leave the channel (Shutdown). The Channel Move Time to cease all transmissions on the current Channel upon detection of a Radar Waveform above the DFS Detection Threshold within 10 sec. The total duration of Channel Closing Transmission Time is comprised of 200 milliseconds starting at the beginning of the Channel Move Time plus any additional intermittent control signals required to facilitate Channel changes (an aggregate of 60 milliseconds) during the remainder of the 10 second period. The aggregate duration of control signals will not count quiet periods in between transmissions.

Non-Occupancy Period time is 30 minute during which a Channel will not be utilized after a Radar Waveform is detected on that Channel. The non-associated Client Beacon Test is during the 30 minutes observation time. The EUT should not make any transmissions in the DFS band after EUT powers up.

4.2.2 TEST PROCEDURES

1. The radar pulse generator is set up to provide a pulse at frequency that the Master and Client are operating. A type 0 radar pulse with a 1us pulse width and a 1428 us PRI is used for the testing.
2. The vector signal generator is adjusted to provide the radar burst (18 pulses) at a level of approximately -62dBm at the antenna of the Master device.
3. A trigger is provided from the pulse generator to the DFS monitoring system in order to capture the traffic and the occurrence of the radar pulse.
4. A U-NII device operating as a Client Device will associate with the Master at Channel. The MPEG file "TestFile.mpg" specified by the FCC is streamed from the "file computer" through the Master to the Client Device and played in full motion video using Media Player Classic Ver. 6.4.8.6 in order to properly load the network for the entire period of the test.
5. When a radar Burst with a level equal to the DFS Detection Threshold + 1dB is generated on the Operating Channel of the U-NII device. At time T0 the Radar Waveform generator sends a Burst of pulse of the radar waveform at Detection Threshold + 1dB.
6. Observe the transmissions of the EUT at the end of the radar Burst on the Operating Channel. Measure and record the transmissions from the EUT during the observation time (Channel Move Time). One 12 second plot is reported for the Short Pulse Radar Types 1. The plot for the Short Pulse Radar Types starts at the end of the radar burst. The Channel Move Time will be calculated based on the zoom in 600ms plot of the Short Pulse Radar Type.
7. Measurement of the aggregate duration of the Channel Closing Transmission Time method. With the spectrum analyzer set to zero span tuned to the center frequency of the EUT operating channel at the radar simulated frequency, peak detection, and max hold, the dwell time per bin is given by: **Dwell (1.3ms) = S (13000ms) / B (10000)**; where Dwell is the dwell time per spectrum analyzer sampling bin, S is the sweep time and B is the number of spectrum analyzer sampling bins. An upper bound of the aggregate duration of the intermittent control signals of Channel Closing Transmission Time is calculated by: **C (ms) = N X Dwell (1.3 ms)**; where C is the Closing Time, N is the number of spectrum analyzer sampling bins (intermittent control signals) showing a U-NII transmission and Dwell is the dwell time per bin.
8. Measure the EUT for more than 30 minutes following the channel move time to verify that no transmissions or beacons occur on this Channel.



Test Report No.: PSU-QSU2312200110RF11

4.2.3 RESULT OF CHANNEL MOVE TIME, CHANNEL CLOSING TRANSMISSION TIME AND NON-OCCUPANCY PERIOD FOR CLIENT BEACON TEST RESULT

Please Refer to Appendix Of this test report.

5 LIST OF MEASURING EQUIPMENT

Instrument	Manufacturer	Model No.	Serial No.	Calibration Date	Due Date	Remark
Open Switch and Control Unit	Rohde&Schwarz	OSP-B157W8	100836	N/A	N/A	Conducted
Vector Signal Source	Rohde&Schwarz	SMW200A	110963	Jun. 12,23	Jun. 11,25	Conducted
Signal &Spectrum Analyzer	Rohde&Schwarz	FSV3044	101340	Jun. 12,23	Jun. 11,25	Conducted
Signal Source	Rohde&Schwarz	SMB100A	183313	Oct. 08,23	Oct. 07,25	Conducted
Test Software	Rohde&Schwarz	EMC32	N/A	N/A	N/A	Conducted



6 APPENDIX

Channel Move Time and Channel Closing Transmission Time

Test Result

TestMode	Frequency[MHz]	CCTT[ms]	Limit[ms]	CMT[ms]	Limit[ms]	Verdict
11AC80SISO	5290	0.200	200+60	0.000	10000	PASS
11AC20SISO	5320	6.152	200+60	0.000	10000	PASS

Test Graphs

11AC80SISO_5290

Channel Move Time

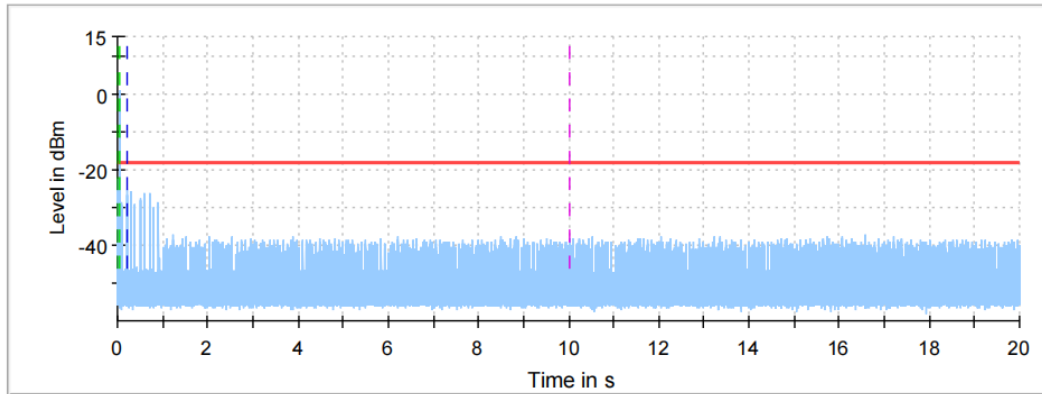

— Channel Move Time
- - - Start of Radar
- - - First 200ms of Channel Closing Tx Time
— Threshold
- - - Trigger at end of Radar
- - - 10sec Channel Move Time Limit

Channel Move Time first 200ms

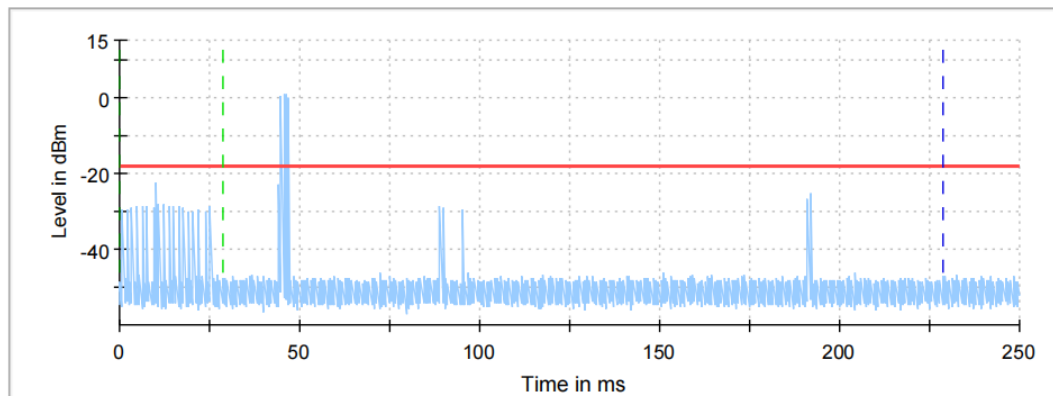

— Channel Move Time first 200ms
- - - Start of Radar
- - - First 200ms of Channel Closing Tx Time
— Threshold
- - - Trigger at end of Radar

11AC20SISO_5320

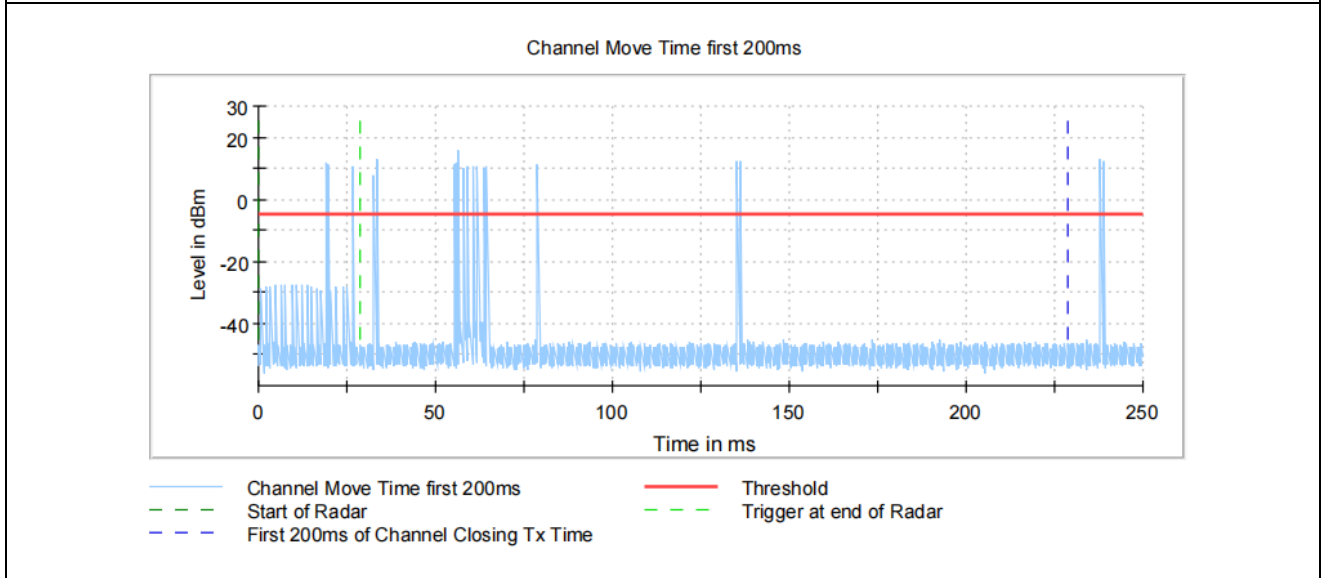
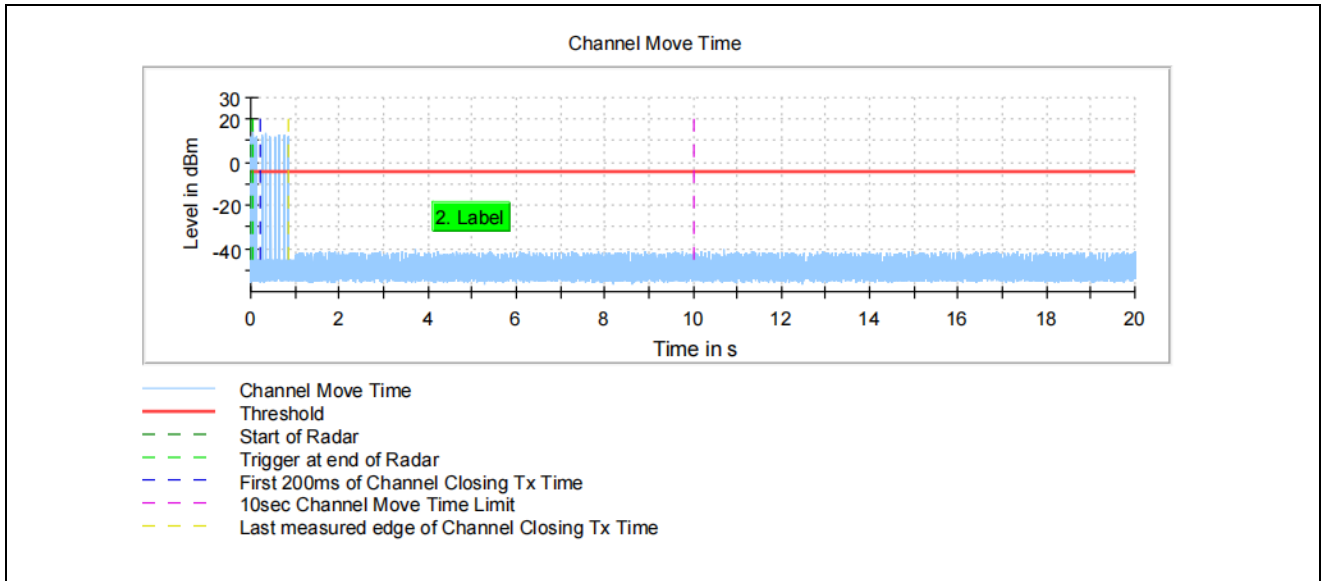



Non-Occupancy Period

Test Result

TestMode	Frequency[MHz]	Result	Limit[s]	Verdict
11AC80SISO	5290	see test graph	≥1800	PASS
11AC20SISO	5320	see test graph	≥1800	PASS

Test Graphs

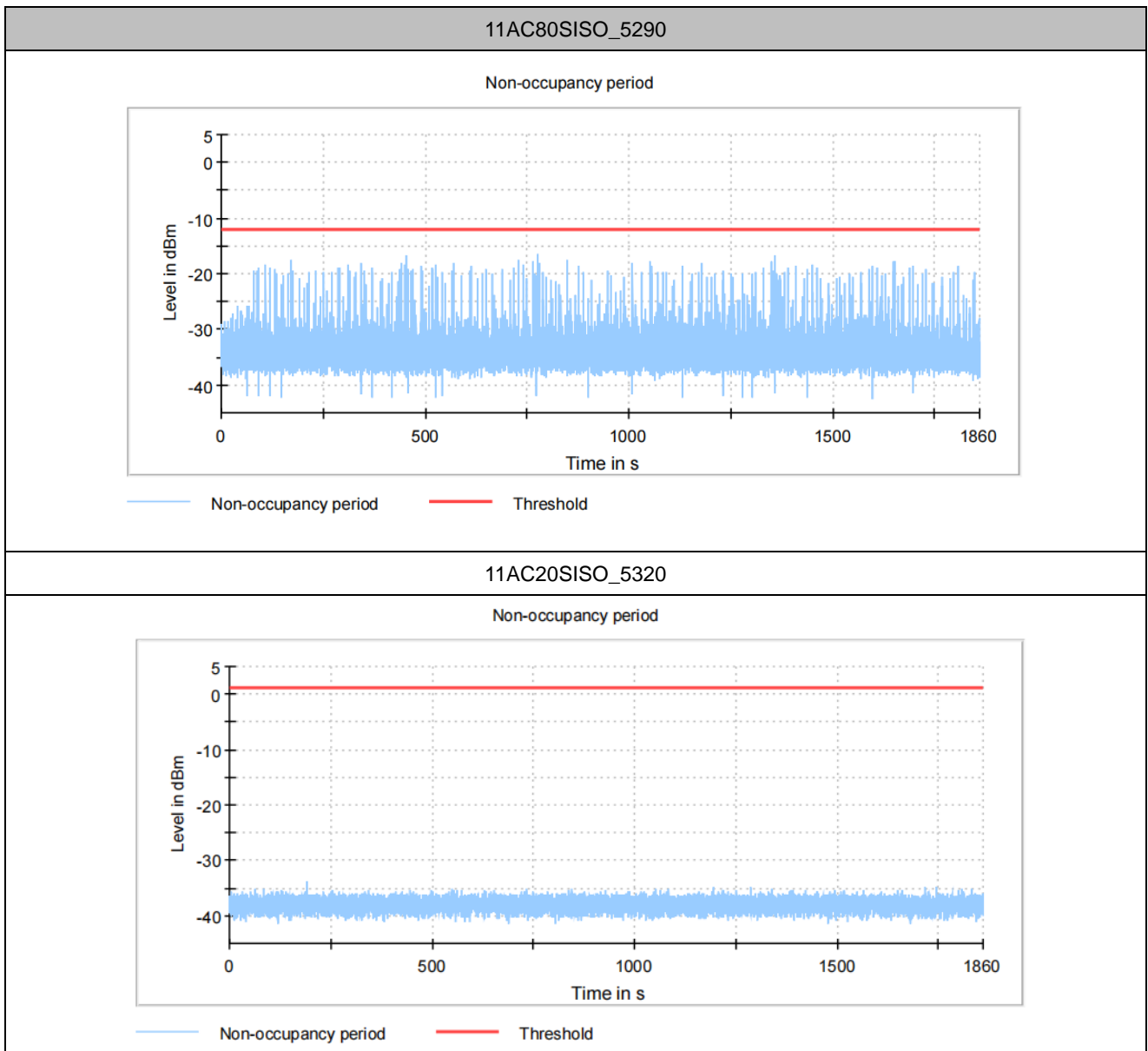

---END---