



Test Report No.: W7L-P22110001RF03



FCC TEST REPORT

(Part 15, Subpart E)



Applicant:	Power Idea Technology (Shenzhen) Co., Ltd.
Address:	4th Floor, A Section ,Languang Science&technology Building, No. 7 Xinxi RD,Hi-Tech Industrial Park North, Nanshan District Shenzhen, China.

Manufacturer or Supplier:	Power Idea Technology (Shenzhen) Co., Ltd.
Address:	4th Floor, A Section ,Languang Science&technology Building, No. 7 Xinxi RD,Hi-Tech Industrial Park North, Nanshan District Shenzhen, China.
Product:	Smart Phone
Brand Name:	RugGear
Model Name:	PSM02G
Marketing Name:	RG750
FCC ID:	ZLE-RG750
Date of tests:	Nov. 02, 2022 ~ Nov. 23, 2022

The tests have been carried out according to the requirements of the following standard:

FCC Part 15, Subpart E, Section 15.407

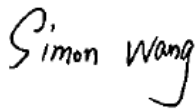
CONCLUSION: The submitted sample was found to COMPLY with the test requirement

Prepared by Simon Wang Engineer / Mobile Department	Approved by Luke Lu Manager / Mobile Department
	
Date: Nov. 23, 2022	Date: Nov. 23, 2022

This report is governed by, and incorporates by reference, the Conditions of Testing as posted at the date of issuance of this report at <http://www.bureauveritas.com/home/about-us/our-business/cps/about-us/terms-conditions/> and is intended for your exclusive use. Any copying or replication of this report to or for any other person or entity, or use of our name or trademark, is permitted only with our prior written permission. This report sets forth our findings solely with respect to the test samples identified herein. The results set forth in this report are not indicative or representative of the quality or characteristics of the lot from which a test sample was taken or any similar or identical product unless specifically and expressly noted. Our report includes all of the tests requested by you and the results thereof based upon the information that you provided to us. Measurement uncertainty is only provided upon request for accredited tests. Statements of conformity are based on simple acceptance criteria without taking measurement uncertainty into account, unless otherwise requested in writing. You have 60 days from date of issuance of this report to notify us of any material error or omission caused by our negligence or if you require measurement uncertainty; provided, however, that such notice shall be in writing and shall specifically address the issue you wish to raise. A failure to raise such issue within the prescribed time shall constitute your unqualified acceptance of the completeness of this report, the tests conducted and the correctness of the report contents.



TABLE OF CONTENTS

RELEASE CONTROL RECORD 4

1 SUMMARY OF TEST RESULTS 5

1.1 MEASUREMENT UNCERTAINTY 6

2 GENERAL INFORMATION..... 7

2.1 GENERAL DESCRIPTION OF EUT 7

2.2 DESCRIPTION OF TEST MODES 9

 2.2.1 TEST MODE APPLICABILITY AND TESTED CHANNEL DETAIL..... 12

2.3 DUTY CYCLE OF TEST SIGNAL 17

2.4 DESCRIPTION OF SUPPORT UNITS 17

 2.4.1 CONFIGURATION OF SYSTEM UNDER TEST 18

2.5 GENERAL DESCRIPTION OF APPLIED STANDARDS 19

3 TEST TYPES AND RESULTS..... 20

3.1 RADIATED EMISSION AND BANDEDGE MEASUREMENT 20

 3.1.1 LIMITS OF RADIATED EMISSION AND BANDEDGE MEASUREMENT..... 20

 3.1.2 LIMITS OF UNWANTED EMISSION 20

 3.1.3 TEST INSTRUMENTS 21

 3.1.4 TEST PROCEDURES 22

 3.1.5 DEVIATION FROM TEST STANDARD 22

 3.1.6 TEST SETUP 23

 3.1.7 EUT OPERATING CONDITION 24

 3.1.8 TEST RESULTS 25

3.2 CONDUCTED EMISSION MEASUREMENT 114

 3.2.1 LIMITS OF CONDUCTED EMISSION MEASUREMENT 114

 3.2.2 TEST INSTRUMENTS 114

 3.2.3 TEST PROCEDURES 114

 3.2.4 DEVIATION FROM TEST STANDARD 115

 3.2.5 TEST SETUP 115

 3.2.6 EUT OPERATING CONDITIONS 115

 3.2.7 TEST RESULTS 116

3.3 MAXIMUM CONDUCTED OUTPUT POWER MEASUREMENT 118

 3.3.1 LIMITS OF MAXIMUM CONDUCTED OUTPUT POWER MEASUREMENT 118

 3.3.2 TEST SETUP 119

 3.3.3 TEST INSTRUMENTS 119



3.3.4	TEST PROCEDURE	120
3.3.5	DEVIATION FROM TEST STANDARD	122
3.3.6	EUT OPERATING CONDITIONS	122
3.3.7	TEST RESULTS	123
3.4	MAXIMUM POWER SPECTRAL DENSITY MEASUREMENT	124
3.4.1	LIMITS OF MAXIMUM POWER SPECTRAL DENSITY MEASUREMENT	124
3.4.2	TEST SETUP	124
3.4.3	TEST INSTRUMENTS	124
3.4.4	TEST PROCEDURES	125
3.4.5	DEVIATION FROM TEST STANDARD	125
3.4.6	EUT OPERATING CONDITIONS	125
3.4.7	TEST RESULTS	126
3.5	AUTOMATICALLY DISCONTINUE TRANSMISSION	127
3.5.1	LIMIT OF AUTOMATICALLY DISCONTINUE TRANSMISSION	127
3.5.2	TEST INSTRUMENTS	127
3.5.3	TEST RESULT	127
4	PHOTOGRAPHS OF THE TEST CONFIGURATION	128
5	MODIFICATIONS RECORDERS FOR ENGINEERING CHANGES TO THE EUT BY THE LAB	129
6	APPENDIX A	130
7	APPENDIX B	269



BUREAU
VERITAS

Test Report No.: W7L-P22110001RF03

RELEASE CONTROL RECORD

ISSUE NO.	REASON FOR CHANGE	DATE ISSUED
W7L-P22110001RF03	Original release	Nov. 23, 2022



1 SUMMARY OF TEST RESULTS

The EUT has been tested according to the following specifications:

APPLIED STANDARD: FCC PART 15, SUBPART E		
STANDARD SECTION	TEST TYPE AND LIMIT	RESULT
15.407(b)(6)	AC Power Conducted Emission	Compliance
15.407(b) (1/2/3/4/5)	Radiated Emission & Band Edge Measurement	Compliance
15.407(a/1/2/3)	Maximum conducted output Power	Compliance
15.407(a/1/2/3)	Peak Power Spectral Density	Compliance
15.403(i)	26 dB Bandwidth	Compliance
15.407(e)	6 dB Bandwidth	Compliance
15.203	Antenna Requirement	Compliance

NOTE:

1. Except the data of RSE and Band Edge Measurement, other data of 802.11a & 802.11n/ac (20/40) & 802.11ac 80 please refer to the appendix.
2. Only the worse data were reported.

1.1 MEASUREMENT UNCERTAINTY

Where relevant, the following measurement uncertainty levels have been estimated for tests performed on the EUT as specified in CISPR 16-4-2:

MEASUREMENT	UNCERTAINTY
AC Power Conducted emissions	±2.70dB
Radiated emissions (9KHz~30MHz)	±2.68dB
Radiated emissions (30MHz~1GMHz)	±4.98dB
Radiated emissions (1GMHz ~6GMHz)	±4.70dB
Radiated emissions (6GMHz ~18GMHz)	±4.60dB
Radiated emissions (18GMHz ~40GMHz)	±4.12dB
Conducted emissions	±4.01dB
Occupied Channel Bandwidth	±43.58KHz
Conducted Output power	±2.06dB
Power Spectral Density	±0.85 dB

This uncertainty represents an expanded uncertainty expressed at approximately the 95% confidence level using a coverage factor of $k = 2$.

**2 GENERAL INFORMATION****2.1 GENERAL DESCRIPTION OF EUT**

PRODUCT	Smart Phone
BRAND NAME	RugGear
MODEL NAME	PSM02G
MARKETING NAME	RG750
NOMINAL VOLTAGE	5.0Vdc(adapter or host equipment) 3.8Vdc (Li-ion, battery)
MODULATION	OFDM
TRANSFER RATE	802.11a: 54.0/ 48.0/ 36.0/ 24.0/ 18.0/ 12.0/ 9.0/ 6.0Mbps 802.11n: up to 150.0Mbps 802.11ac: up to 433.3Mbps
OPERATING FREQUENCY	5180 ~ 5240MHz, 5260 ~ 5320MHz, 5500 ~ 5720MHz, 5745 ~ 5825MHz
NUMBER OF CHANNEL	5180 ~ 5240MHz: 4 for 802.11a, 802.11n/ac (20MHz) 2 for 802.11n/ac (40MHz) 1 for 802. 802.11ac(80MHz) 5260 ~ 5320MHz: 4 for 802.11a, 802.11n/ac (20MHz) 2 for 802.11n/ac (40MHz) 1 for 802.11ac (80MHz) 5500 ~ 5720MHz: 12 for 802.11a, 802.11n/ac (20MHz)/ 6 for 802.11n/ac (40MHz) 3 for 802.11ac (80MHz) 5745 ~ 5825MHz: 5 for 802.11a, 802.11n/ac (20MHz) 2 for 802.11n/ac (40MHz) 1 for 802.11ac (80MHz)
AVERAGE POWER	38.73mW for 5180 ~ 5240MHz 45.81mW for 5260 ~ 5320MHz 28.51mW for 5500 ~ 5720MHz 36.81mW for 5745 ~ 5825MHz
ANTENNA TYPE	PIFA Antenna
ANTENNA GAIN	-1.4dBi for 5180 ~ 5240MHz -1.4dBi for 5260 ~ 5320MHz -1.4dBi for 5500 ~ 5720MHz -1.4dBi for 5745 ~ 5825MHz
HW VERSION	LA5C25_MB_V1.00
SW VERSION	LA5C25(RG750)_RG750_EEA_00.00_0_20221103_MultiDownl



	oad_20221103131135
I/O PORTS	Refer to user's manual
CABLE SUPPLIED	USB cable: non-shielded cable, with w/o ferrite core, 1.0 meter Earphone: non-shielded cable, with w/o ferrite core, 1.0 meter

NOTE:

1. For a more detailed features description, please refer to the manufacturer's specifications or the user's manual.
2. The EUT incorporates a SISO function. Physically, the EUT provides one completed transmitter and one receiver.

MODULATION MODE	TX FUNCTION
802.11a	1TX /1RX
802.11n/802.11ac (20MHz)	1TX /1RX
802.11n/802.11ac (40MHz)	1TX /1RX
802.11ac (80MHz)	1TX /1RX

3. For the test results, the EUT had been tested with all conditions. But only the worst case was shown in test report.

List of Accessory:

ACCESSORIES	BRAND	MANUFACTURER	MODEL	SPECIFICATION
Battery	N/A	SHENZHEN YJC TECHNOLOGY CO. LTD.	BL500IP	Capacity: 3.8Vdc, 5000mAh
AC Adapter 1	Huntkey	Shenzhen Huntkey Electric Co., Ltd.	HKC0115021-2D	I/P: 100-240Vac, 0.5A, O/P: 5.0Vdc, 2A
AC Adapter 2	FULL POWER	Shenzhen Shi Ying Yuan Electronics Co., Ltd.	ICP12-050-2000B	I/P: 100-240Vac, 0.3A, O/P: 5.0Vdc, 2A
Earphone	N/A	CXD SCIENCE TECHNOLOGY	AC-4035-M6	Rated: 10mW, Max:20mW Signal Line,1.0meter
USB Cable	N/A	ShenZhen zhigaoda electronics Co., LTD	USB2.0	Signal Line,1.0meter



2.2 DESCRIPTION OF TEST MODES

FOR 5180 ~ 5240MHz

4 channels are provided for 802.11a, 802.11n, 802.11ac (20MHz):

CHANNEL	FREQUENCY	CHANNEL	FREQUENCY
36	5180 MHz	44	5220 MHz
40	5200 MHz	48	5240 MHz

2 channels are provided for 802.11n, 802.11ac (40MHz):

CHANNEL	FREQUENCY	CHANNEL	FREQUENCY
38	5190 MHz	46	5230 MHz

1 channel is provided for 802.11ac (80MHz):

CHANNEL	FREQUENCY	CHANNEL	FREQUENCY
42	5210 MHz		

FOR 5260 ~ 5320MHz

4 channels are provided for 802.11a, 802.11n, 802.11ac (20MHz):

CHANNEL	FREQUENCY	CHANNEL	FREQUENCY
52	5260 MHz	60	5300 MHz
56	5280 MHz	64	5320 MHz

2 channels are provided for 802.11n, 802.11ac (40MHz):

CHANNEL	FREQUENCY	CHANNEL	FREQUENCY
54	5270 MHz	62	5310 MHz

1 channel is provided for 802.11ac (80MHz):

CHANNEL	FREQUENCY	CHANNEL	FREQUENCY
58	5290 MHz		



FOR 5500 ~ 5720MHz

12 channels are provided for 802.11a, 802.11n, 802.11ac (20MHz):

CHANNEL	FREQUENCY	CHANNEL	FREQUENCY
100	5500 MHz	124	5620MHz
104	5520 MHz	128	5640MHz
108	5540 MHz	132	5660 MHz
112	5560 MHz	136	5680 MHz
116	5580 MHz	140	5700 MHz
120	5600 MHz	144	5720 MHz

6 channels are provided for 802.11n, 802.11ac (40MHz):

CHANNEL	FREQUENCY	CHANNEL	FREQUENCY
102	5510 MHz	126	5630MHz
110	5550 MHz	134	5670 MHz
118	5590 MHz	142	5710 MHz

3 channel is provided for 802.11ac (80MHz):

CHANNEL	FREQUENCY	CHANNEL	FREQUENCY
106	5530 MHz	138	5690 MHz
122	5610 MHz		



FOR 5745 ~ 5825MHz

5 channels are provided for 802.11a, 802.11n, 802.11ac (20MHz):

CHANNEL	FREQUENCY	CHANNEL	FREQUENCY
149	5745 MHz	161	5805 MHz
153	5765 MHz	165	5825 MHz
157	5785 MHz		

2 channels are provided for 802.11n, 802.11ac (40MHz):

CHANNEL	FREQUENCY	CHANNEL	FREQUENCY
151	5755 MHz	159	5795 MHz

1 channel is provided for 802.11ac (80MHz):

CHANNEL	FREQUENCY
155	5775 MHz



2.2.1 TEST MODE APPLICABILITY AND TESTED CHANNEL DETAIL

EUT CONFIGURE MODE	APPLICABLE TO				DESCRIPTION
	RE≥1G	RE<1G	PLC	APCM	
A	√	√	√	-	Powered by Adapter with wifi(5G) link
B	-	-	-	√	Powered by Battery with wifi(5G) link
C	-	-	-	-	Powered by USB with wifi(5G) link

Where **RE≥1G**: Radiated Emission above 1GHz **RE<1G**: Radiated Emission below 1GHz
PLC: Power Line Conducted Emission **APCM**: Antenna Port Conducted Measurement

NOTE:

The EUT had been pre-tested on the positioned of each 3 axis. The worst case was found when positioned on **X-plane**.

NOTE: "-" means no effect.

RADIATED EMISSION TEST (BELOW 1GHz):

- Pre-Scan has been conducted to determine the worst-case mode from all possible combinations between available modulations, data rates and antenna ports (if EUT with antenna diversity architecture).
- Following channel(s) was (were) selected for the final test as listed below.

EUT CONFIGURE MODE	MODE	FREQ. BAND (MHz)	AVAILABLE CHANNEL	TESTED CHANNEL	MODULATION	DATA RATE (Mbps)
A	802.11n (40MHz)	5745-5825	151 to 159	151	OFDM	MCS0



RADIATED EMISSION TEST (ABOVE 1GHz):

- Pre-Scan has been conducted to determine the worst-case mode from all possible combinations between available modulations, data rates and antenna ports (if EUT with antenna diversity architecture).
- Following channel(s) was (were) selected for the final test as listed below.

EUT CONFIGURE MODE	MODE	FREQ. BAND (MHz)	AVAILABLE CHANNEL	TESTED CHANNEL	MODULATION	DATA RATE (Mbps)
A	802.11a	5180-5240	36 to 48	36, 48	OFDM	6.0
A	802.11an/ac (20MHz)		36 to 48	36, 48	OFDM	MCS0
A	802.11an/ac (40MHz)		38 to 46	38, 46	OFDM	MCS0
A	802.11ac (80MHz)		42	42	OFDM	MCS0
A	802.11a	5260-5320	52 to 64	52, 60, 64	OFDM	6.0
A	802.11an/ac (20MHz)		52 to 64	52, 60, 64	OFDM	MCS0
A	802.11an/ac (40MHz)		54 to 62	54, 62	OFDM	MCS0
A	802.11ac (80MHz)		58	58	OFDM	MCS0
A	802.11a	5500-5720	100 to 144	100, 116, 140, 144	OFDM	6.0
A	802.11an/ac (20MHz)		100 to 144	100, 116, 140, 144	OFDM	MCS0
A	802.11an/ac (40MHz)		102 to 142	102, 110, 134, 142	OFDM	MCS0
A	802.11ac (80MHz)		106 to 138	106, 138	OFDM	MCS0
A	802.11a	5745-5825	144 to 165	144,149, 157,165	OFDM	6.0
A	802.11an/ac (20MHz)		149 to 165	144,149, 157,165	OFDM	MCS0
A	802.11an/ac (40MHz)		142 to 159	142,151, 159	OFDM	MCS0
A	802.11ac (80MHz)		138 to 155	138,155	OFDM	MCS0

POWER LINE CONDUCTED EMISSION TEST:

- Pre-Scan has been conducted to determine the worst-case mode from all possible combinations between available modulations, data rates and antenna ports (if EUT with antenna diversity architecture).
- Following channel(s) was (were) selected for the final test as listed below.

EUT CONFIGURE MODE	MODE	FREQ. BAND (MHz)	AVAILABLE CHANNEL	TESTED CHANNEL	MODULATION	DATA RATE (Mbps)
A	802.11n (40MHz)	5745-5825	151 to 159	151	OFDM	MCS0



BANDEDGE MEASUREMENT:

- Pre-Scan has been conducted to determine the worst-case mode from all possible combinations between available modulations, data rates and antenna ports (if EUT with antenna diversity architecture).
- Following channel(s) was (were) selected for the final test as listed below.

EUT CONFIGURE MODE	MODE	FREQ. BAND (MHz)	AVAILABLE CHANNEL	TESTED CHANNEL	MODULATION	DATA RATE (Mbps)
A	802.11a	5180-5240	36 to 48	36, 48	OFDM	6.0
A	802.11an/ac (20MHz)		36 to 48	36, 48	OFDM	MCS0
A	802.11an/ac (40MHz)		38 to 46	38, 46	OFDM	MCS0
A	802.11ac (80MHz)		42	42	OFDM	MCS0
A	802.11a	5260-5320	52 to 64	52, 60, 64	OFDM	6.0
A	802.11an/ac (20MHz)		52 to 64	52, 60, 64	OFDM	MCS0
A	802.11an/ac (40MHz)		54 to 62	54, 62	OFDM	MCS0
A	802.11ac (80MHz)		58	58	OFDM	MCS0
A	802.11a	5500-5720	100 to 144	100, 116, 140, 144	OFDM	6.0
A	802.11an/ac (20MHz)		100 to 144	100, 116, 140, 144	OFDM	MCS0
A	802.11an/ac (40MHz)		102 to 142	102, 110, 134, 142	OFDM	MCS0
A	802.11ac(80MHz))		106 to 138	106, 138	OFDM	MCS0
A	802.11a	5745-5825	144 to 165	144, 149, 157,165	OFDM	6.0
A	802.11an/ac (20MHz)		144 to 165	144, 149, 157,165	OFDM	MCS0
A	802.11an/ac (40MHz)		142 to 159	142, 151, 159	OFDM	MCS0
A	802.11ac (80MHz)		138,155	138, 155	OFDM	MCS0



ANTENNA PORT CONDUCTED MEASUREMENT:

- This item includes all test value of each mode, but only includes spectrum plot of worst value of each mode.
- Pre-Scan has been conducted to determine the worst-case mode from all possible combinations between available modulations, data rates and antenna ports (if EUT with antenna diversity architecture).
- Following channel(s) was (were) selected for the final test as listed below.

EUT CONFIGURE MODE	MODE	FREQ. BAND (MHz)	AVAILABLE CHANNEL	TESTED CHANNEL	MODULATION	DATA RATE (Mbps)
A	802.11a	5180-5240	36 to 48	36, 48	OFDM	6.0
A	802.11an/ac (20MHz)		36 to 48	36, 48	OFDM	MCS0
A	802.11an/ac (40MHz)		38 to 46	38, 46	OFDM	MCS0
A	802.11ac (80MHz)		42	42	OFDM	MCS0
A	802.11a	5260-5320	52 to 64	52, 60, 64	OFDM	6.0
A	802.11an/ac (20MHz)		52 to 64	52, 60, 64	OFDM	MCS0
A	802.11an/ac (40MHz)		54 to 62	54, 62	OFDM	MCS0
A	802.11ac (80MHz)		58	58	OFDM	MCS0
A	802.11a	5500-5720	100 to 144	100, 116, 140, 144	OFDM	6.0
A	802.11an/ac (20MHz)		100 to 144	100, 116, 140, 144	OFDM	MCS0
A	802.11an/ac (40MHz)		102 to 142	102, 110, 134, 142	OFDM	MCS0
A	802.11ac (80MHz)		106 to 138	106, 138	OFDM	MCS0
A	802.11a	5745-5825	144 to 165	144, 149, 157,165	OFDM	6.0
A	802.11an/ac (20MHz)		144 to 165	144, 149, 157,165	OFDM	MCS0
A	802.11an/ac (40MHz)		142 to 159	142, 151, 159	OFDM	MCS0
A	802.11ac (80MHz)		138,155	138, 155	OFDM	MCS0



TEST CONDITION:

APPLICABLE TO	ENVIRONMENTAL CONDITIONS	INPUT POWER	TESTED BY
RE<1G	23deg. C, 70%RH	DC 5V By Adapter	Jace Hu
RE≥1G	23deg. C, 70%RH	DC 5V By Adapter	Jace Hu
PLC	25deg. C, 52%RH	DC 5V By Adapter	James Fu
APCM	25deg. C, 60%RH	DC 3.6V/3.8V/4.35V By DC Supply	James Fu



2.3 DUTY CYCLE OF TEST SIGNAL

Please Refer to Appendix A/B Of this test report.

WORST-CASE DATA:

Measured Duty Cycle		
Mode		Duty Cycle [%]
		ANT1
5GHZ	11a	98.57
	11n20	98.47
	11n40	96.94
	11ac20	98.48
	11ac40	96.97
	11ac80	94.00

Note:

Duty cycle of test signal is < 98%, duty factor shall be considered.

2.4 DESCRIPTION OF SUPPORT UNITS

The EUT has been tested as an independent unit together with other necessary accessories or support units. The following support units or accessories were used to form a representative test configuration during the tests.

NO.	PRODUCT	BRAND	MODEL NO.	SERIAL NO.	FCC ID
1	Desktop	Lenovo	M73 SFF	PC04GRQV	N/A
2	Desktop	Lenovo	M73 SFF	PC06CS27	N/A
3	Laptop	Lenovo	Thnikpad L440	R90FTFKN	N/A
4	DC source	Kikusui/JP	PMX18-5A	0000001	N/A

NO.	SIGNAL CABLE DESCRIPTION OF THE ABOVE SUPPORT UNITS
1	AC Line: Unshielded, Detachable 1.5m
2	AC Line: Unshielded, Detachable 1.5m
3	AC Line: Unshielded, Detachable 1.5m
4	DC Line: Unshielded, Detachable 1.0m



2.4.1 CONFIGURATION OF SYSTEM UNDER TEST

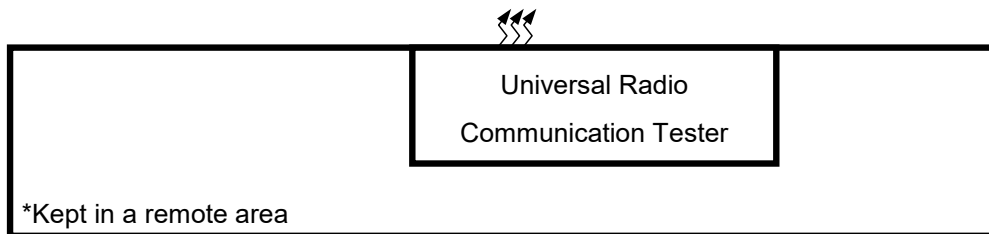
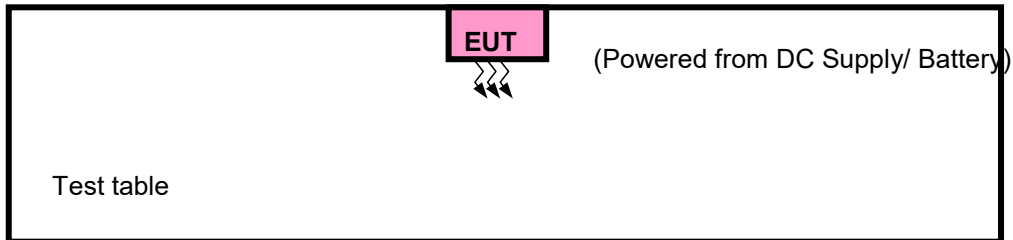
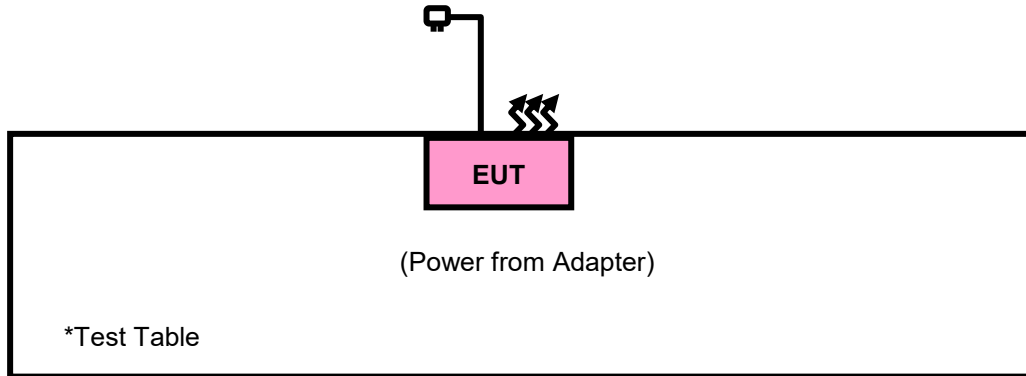



Test Report No.: W7L-P22110001RF03

2.5 GENERAL DESCRIPTION OF APPLIED STANDARDS

The EUT is a RF Product. According to the specifications of the manufacturer, it must comply with the requirements of the following standards:

FCC Part 15, Subpart E (15.407)

KDB 789033 D02 General U-NII Test Procedures New Rules v02r01

ANSI C63.10-2013

All test items have been performed and recorded as per the above standards.

NOTE: The EUT is also considered as a kind of computer peripheral, because the connection to computer is necessary for typical use. It has been verified to comply with the requirements of FCC Part 15, Subpart B, Class B (Certification). The test report has been issued separately.



3 TEST TYPES AND RESULTS

3.1 RADIATED EMISSION AND BANDEDGE MEASUREMENT

3.1.1 LIMITS OF RADIATED EMISSION AND BANDEDGE MEASUREMENT

Radiated emissions which fall in the restricted bands must comply with the radiated emission limits specified as below table:

FREQUENCIES (MHz)	FIELD STRENGTH (microvolts/meter)	MEASUREMENT DISTANCE (meters)
0.009 ~ 0.490	2400/F(kHz)	300
0.490 ~ 1.705	24000/F(kHz)	30
1.705 ~ 30.0	30	30
30 ~ 88	100	3
88 ~ 216	150	3
216 ~ 960	200	3
Above 960	500	3

NOTE:

1. The lower limit shall apply at the transition frequencies.
2. Emission level (dBuV/m) = 20 log Emission level (uV/m).
3. For frequencies above 1000MHz, the field strength limits are based on average detector, however, the peak field strength of any emission shall not exceed the maximum permitted average limits, specified above by more than 20dB under any condition of modulation.

3.1.2 LIMITS OF UNWANTED EMISSION

RESTRICTED BANDS	APPLICABLE TO	LIMIT	
	789033 D02 General UNII Test Procedures New Rules v02r01	FIELD STRENGTH AT 3m (dBµV/m)	
	PK : 74	AV : 54	
OUT OF THE RESTRICTED BANDS	APPLICABLE TO	EIRP LIMIT (dBm/MHz)	EQUIVALENT FIELD STRENGTH AT 3m (dBµV/m)
	15.407(b)(1)	PK : -27	PK : 68.2
	15.407(b)(2)		
	15.407(b)(3)		
	15.407(b)(4)	See note 2 (FCC 16-24)	



NOTE: The following formula is used to convert the equipment isotropic radiated power (eirp) to field strength:

$$E = \frac{1000000 \sqrt{30P}}{3} \quad \mu\text{V/m, where P is the eirp (Watts).$$

2. All emissions shall be limited to a level of -27 dBm/MHz at 75 MHz or more above or below the band edge increasing linearly to 10 dBm/MHz at 25 MHz above or below the band edge, and from 25 MHz above or below the band edge increasing linearly to a level of 15.6 dBm/MHz at 5 MHz above or below the band edge, and from 5 MHz above or below the band edge increasing linearly to a level of 27 dBm/MHz at the band edge.

3.1.3 TEST INSTRUMENTS

Equipment	Manufacturer	Model No.	Serial No.	Last Cal.	Next Cal.
3m Semi-anechoic Chamber	ETS-LINDGREN	9m*6m*6m	Euroshieldpn-CT0001143-1216	May. 19,20	May. 18,23
Bilog Antenna	ETS-LINDGREN	3143B	00161965	Mar. 06,22	Mar. 05,23
Horn Antenna	ETS-LINDGREN	3117	00168692	Mar. 06,22	Mar. 05,23
Horn Antenna (18GHz-40GHz)	N/A	QWH-SL-18-40-K-SG/QMS-00361	15433	Aug. 24, 22	Aug. 23, 23
Test Software	E3	V 9.160323	N/A	N/A	N/A
Test Software	JS1120-3	3.2.06	N/A	N/A	N/A
10dB Attenuator	JFW/USA	50HF-010-SMA	1505	Jun. 02,22	Jun. 01,23
MXE EMI Receiver	KEYSIGHT	N9038A-544	MY54450026	Feb. 21,22	Feb. 20,23
Signal Pre-Amplifier	EMSI	EMC 9135	980249	May.12,22	May.11,23
Signal Pre-Amplifier	EMSI	EMC 012645B	980257	May.12,22	May.11,23
Signal Pre-Amplifier	EMSI	EMC 184045B	980259	Feb. 21,22	Feb.20,23
DC Source	Kikusui/JP	PMX18-5A	0000001	Aug. 24,22	Aug. 23,23
Power Meter	Anritsu	ML2495A	1506002	Feb. 22,22	Feb. 21,23
Power Sensor	Anritsu	MA2411B	1339352	May. 06,22	May. 05,23
Loop Antenna	Schwarzbeck	FMZB 1519B	00173	Sep. 04,22	Sep. 03,23

- NOTE:**
1. The calibration interval of the above test instruments is 12 months or 36 months and the calibrations are traceable to CEPREI/CHINA, GRGT/CHINA and NIM/CHINA.
 2. The test was performed in 3m Chamber.
 3. The FCC Site Registration No. is 525120; The Designation No. is CN1171.



3.1.4 TEST PROCEDURES

- a. The EUT was placed on the top of a rotating table 0.8 meters (for below 1GHz) / 1.5 meters (for above 1GHz) above the ground at 3 meter chamber room for test. The table was rotated 360 degrees to determine the position of the highest radiation.
- b. The EUT was set 3 meters away from the interference-receiving antenna, which was mounted on the top of a variable-height antenna tower.
- c. The antenna is a broadband antenna, and its height is varied from one meter to four meters above the ground to determine the maximum value of the field strength. Both horizontal and vertical polarizations of the antenna are set to make the measurement.
- d. For each suspected emission, the EUT was arranged to its worst case and then the antenna was tuned to heights from 1 meter to 4 meters and the rotatable table was turned from 0 degrees to 360 degrees to find the maximum reading.
- e. The test-receiver system was set to Peak Detect Function and Specified Bandwidth with Maximum Hold Mode.
- f. If the emission level of the EUT in peak mode was 10dB lower than the limit specified, then testing could be stopped and the peak values of the EUT would be reported. Otherwise the emissions that did not have 10dB margin would be re-tested one by one using peak, quasi-peak or average method as specified and then reported in a data sheet.

NOTE:

1. The resolution bandwidth and video bandwidth of test receiver/spectrum analyzer is 120kHz for Peak detection (PK) and Quasi-peak detection (QP) at frequency below 1GHz.
2. The resolution bandwidth of test receiver/spectrum analyzer is 1MHz and video bandwidth is 3MHz for Peak detection at frequency above 1GHz.
3. The resolution bandwidth of test receiver/spectrum analyzer is 1MHz and the video bandwidth is 3MHz for RMS Average (Duty cycle < 98%) for Average detection (AV) at frequency above 1GHz, then the measurement results was added to a correction factor ($10 \log(1/\text{duty cycle})$).
4. The resolution bandwidth of test receiver/spectrum analyzer is 1MHz and the video bandwidth is 10Hz (Duty cycle \geq 98%) for Average detection (AV) at frequency above 1GHz.
5. All modes of operation were investigated and the worst-case emissions are reported.

3.1.5 DEVIATION FROM TEST STANDARD

No deviation.



3.1.6 TEST SETUP

<Frequency Range 9KHz~30MHz >

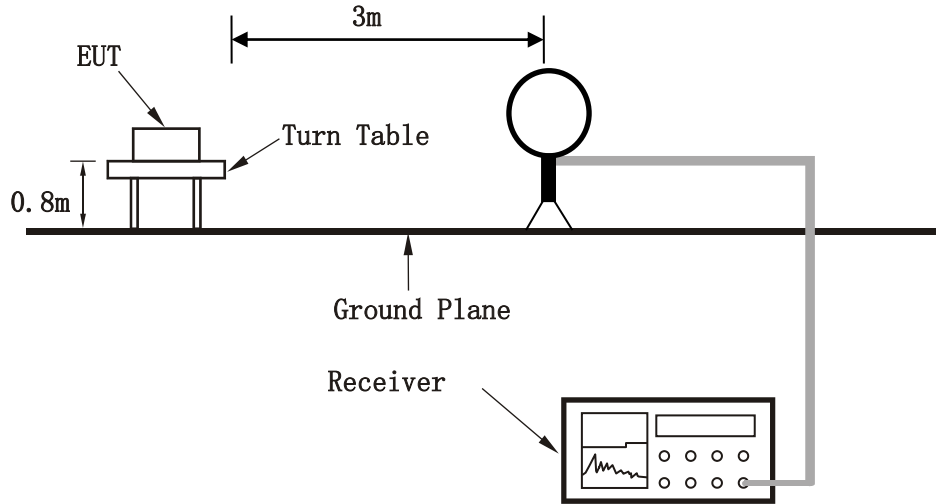

< Frequency Range 30MHz~1GHz >

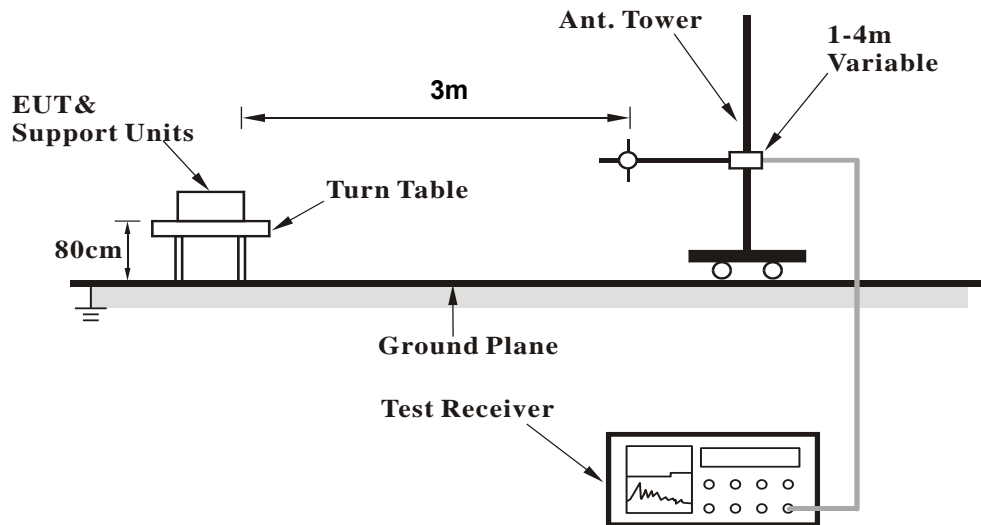



<Frequency Range above 1GHz>

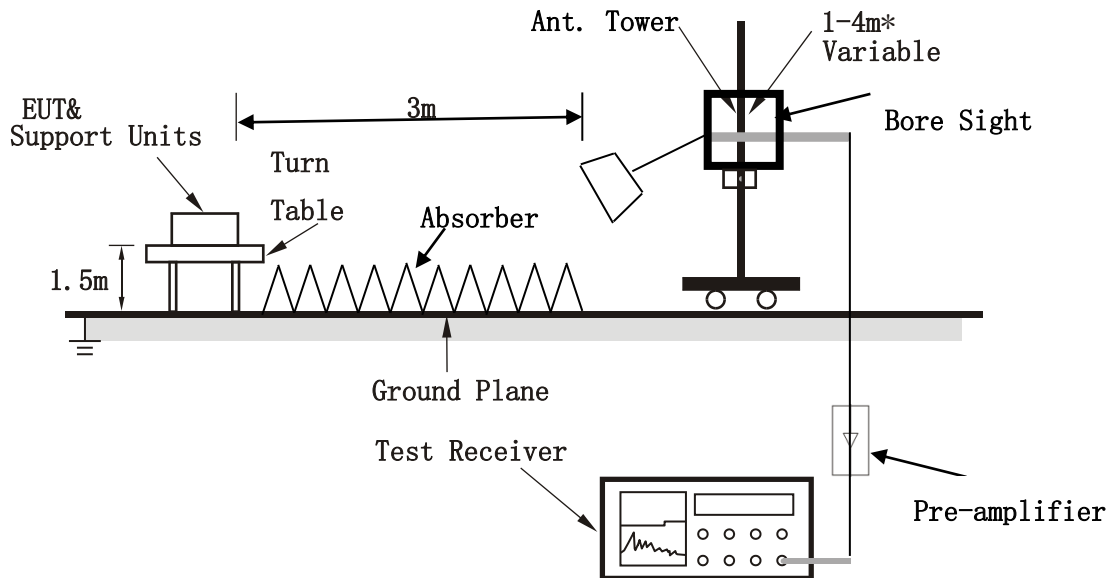

Note: Above 1G is a directional antenna

Depends on the EUT height and the antenna 3dB beamwidth both, refer to section 7.3 of CISPR 16-2-3.

For the actual test configuration, please refer to the attached file (Test Setup Photo).

3.1.7 EUT OPERATING CONDITION

- Set the EUT under full load condition and placed them on a testing table.
- Set the transmitter part of EUT under transmission condition continuously at specific channel frequency.
- The necessary accessories enable the EUT in full functions.



3.1.8 TEST RESULTS

NOTE : The 9K~30MHz amplitude of spurious emissions attenuated more than 20 dB below the permissible value is not required in the report.

30 MHz – 1GHz data:

Band 4

802.11n (40MHz)

CHANNEL	TX Channel 151	DETECTOR FUNCTION	Quasi-Peak (QP)
FREQUENCY RANGE	30MHz ~ 1GHz		

ANTENNA POLARITY & TEST DISTANCE: HORIZONTAL AT 3 M										
FREQ. (MHz)	EMISSION LEVEL (dBuV/m)	READ LEVEL (dBuV)	LIMIT (dBuV/m)	MARGIN (dB)	ANTENNA FACTOR (dB /m)	CABLE LOSS (dB)	PREAMP FACTOR (dB)	ANTENNA HEIGHT (cm)	TABLE ANGLE (Degree)	REMARK
62.01	36.17	63.76	40	-3.83	8.9	0.45	36.94	117	53	QP
155.13	27.51	53.05	43.5	-15.99	10.32	0.67	36.53	146	111	QP
232.73	30.67	53.41	46	-15.33	12.74	0.8	36.28	192	19	QP
266.68	30.6	52.34	46	-15.4	13.67	0.86	36.27	116	340	QP
398.6	28.26	47.44	46	-17.74	16.17	1.07	36.42	156	357	QP
597.45	33.47	49.29	46	-12.53	19.66	1.36	36.84	193	320	QP

REMARKS:

1. Emission level (dBuV/m) = Read level (dBuV) + Correction Factor (dB/m).
2. Correction Factor (dB/m) = Antenna Factor (dB/m) + Cable Factor (dB).
3. The other emission levels were very low against the limit.
4. Margin value = Emission level – Limit value.

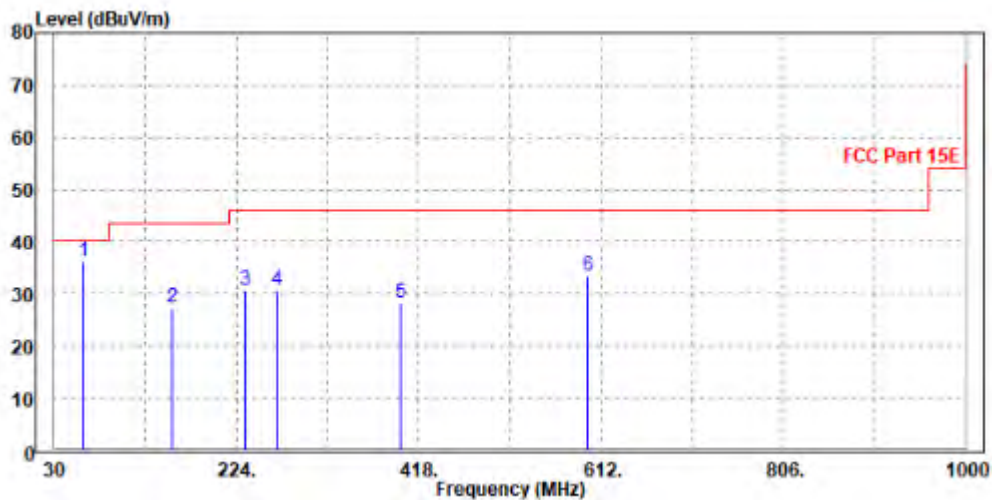



CHANNEL	Channel 151	DETECTOR FUNCTION	Quasi-Peak (QP)
FREQUENCY RANGE	30MHz ~ 1GHz		

ANTENNA POLARITY & TEST DISTANCE: VERTICAL AT 3 M										
FREQ. (MHz)	EMISSION LEVEL (dBuV/m)	READ LEVEL (dBuV)	LIMIT (dBuV/m)	MARGIN (dB)	ANTENNA FACTOR (dB /m)	CABLE LOSS (dB)	PREAMP FACTOR (dB)	ANTENNA HEIGHT (cm)	TABLE ANGLE (Degree)	REMARK
62.01	34.49	62.48	40	-5.51	8.5	0.45	36.94	140	265	QP
134.76	21.11	48.6	43.5	-22.39	8.53	0.62	36.64	174	320	QP
221.09	25.57	49.11	46	-20.43	11.96	0.78	36.28	115	83	QP
265.71	29.21	51.58	46	-16.79	13.04	0.86	36.27	124	95	QP
359.8	28.41	48.38	46	-17.59	15.38	1.01	36.36	179	89	QP
399.57	29.58	48.64	46	-16.42	16.29	1.07	36.42	106	106	QP

REMARKS:

1. Emission level (dBuV/m) = Read level (dBuV) + Correction Factor (dB/m).
2. Correction Factor (dB/m) = Antenna Factor (dB/m) + Cable Factor (dB).
3. The other emission levels were very low against the limit.
4. Margin value = Emission level – Limit value.

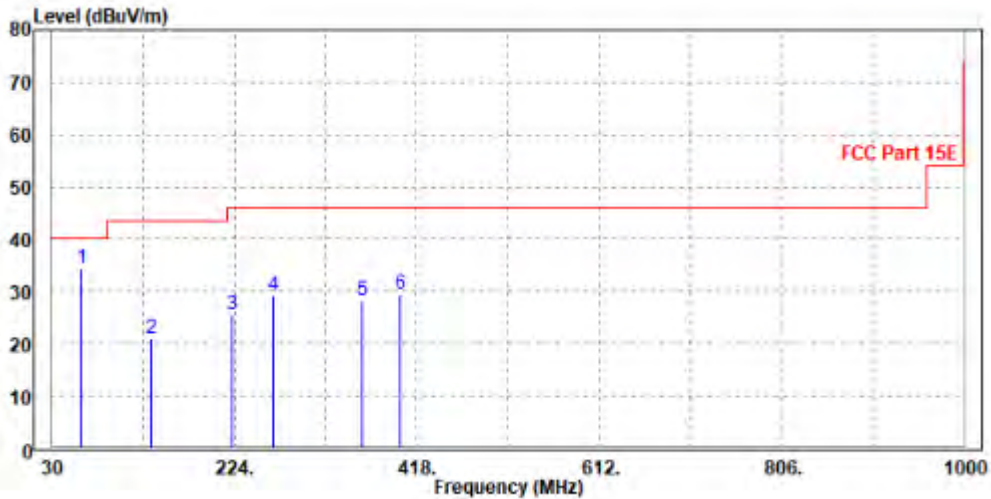



ABOVE 1GHz WORST-CASE DATA:

Note: For higher frequency, the emission is too low to be detected.

Band 1

802.11a

CHANNEL	TX Channel 36	DETECTOR FUNCTION	Peak (PK)
FREQUENCY RANGE	1GHz ~ 40GHz		Average (AV)

ANTENNA POLARITY & TEST DISTANCE: HORIZONTAL AT 3 M										
FREQ. (MHz)	EMISSION LEVEL (dBuV/m)	READ LEVEL (dBuV)	LIMIT (dBuV/m)	MARGIN (dB)	ANTENNA FACTOR (dB /m)	CABLE LOSS (dB)	PREAMP FACTOR (dB)	ANTENNA HEIGHT (cm)	TABLE ANGLE (Degree)	REMARK
5150	55.55	56.62	74	-18.45	34.52	9.92	45.51	145	50	Peak
5150	50.55	51.62	54	-3.45	34.52	9.92	45.51	145	50	Average
5180	104.08	105.14	/	/	34.54	9.91	45.51	145	50	Peak
5180	97.79	98.85	/	/	34.54	9.91	45.51	145	50	Average
5350	54.79	55.77	74	-19.21	34.68	9.85	45.51	145	50	Peak
5350	48.29	49.27	54	-5.71	34.68	9.85	45.51	145	50	Average
ANTENNA POLARITY & TEST DISTANCE: VERTICAL AT 3 M										
FREQ. (MHz)	EMISSION LEVEL (dBuV/m)	READ LEVEL (dBuV)	LIMIT (dBuV/m)	MARGIN (dB)	ANTENNA FACTOR (dB /m)	CABLE LOSS (dB)	PREAMP FACTOR (dB)	ANTENNA HEIGHT (cm)	TABLE ANGLE (Degree)	REMARK
5150	56.03	57.02	74	-17.97	34.6	9.92	45.51	100	40	Peak
5150	50.53	51.52	54	-3.47	34.6	9.92	45.51	100	40	Average
5180	99.34	100.34	/	/	34.6	9.91	45.51	100	40	Peak
5180	91.47	92.47	/	/	34.6	9.91	45.51	100	40	Average
5350	54.12	55.18	74	-19.88	34.6	9.85	45.51	100	40	Peak
5350	48.53	49.59	54	-5.47	34.6	9.85	45.51	100	40	Average

REMARKS:

- Emission Level = Read Level+ Antenna Factor + Cable Loss- Preamp Factor
Margin value = Emission level – Limit value.
- 5180MHz: Fundamental frequency.



CHANNEL	TX Channel 40	DETECTOR FUNCTION	Peak (PK)
FREQUENCY RANGE	1GHz ~ 40GHz		Average (AV)

ANTENNA POLARITY & TEST DISTANCE: HORIZONTAL AT 3 M										
FREQ. (MHz)	EMISSION LEVEL (dBuV/m)	READ LEVEL (dBuV)	LIMIT (dBuV/m)	MARGIN (dB)	ANTENNA FACTOR (dB /m)	CABLE LOSS (dB)	PREAMP FACTOR (dB)	ANTENNA HEIGHT (cm)	TABLE ANGLE (Degree)	REMARK
5150	55.91	56.98	74	-18.09	34.52	9.92	45.51	145	50	Peak
5150	50.21	51.28	54	-3.79	34.52	9.92	45.51	145	50	Average
5200	104.1	105.15	/	/	34.56	9.9	45.51	145	50	Peak
5200	97.17	98.22	/	/	34.56	9.9	45.51	145	50	Average
5350	56.61	57.59	74	-17.39	34.68	9.85	45.51	145	50	Peak
5350	47.88	48.86	54	-6.12	34.68	9.85	45.51	145	50	Average
ANTENNA POLARITY & TEST DISTANCE: VERTICAL AT 3 M										
FREQ. (MHz)	EMISSION LEVEL (dBuV/m)	READ LEVEL (dBuV)	LIMIT (dBuV/m)	MARGIN (dB)	ANTENNA FACTOR (dB /m)	CABLE LOSS (dB)	PREAMP FACTOR (dB)	ANTENNA HEIGHT (cm)	TABLE ANGLE (Degree)	REMARK
5150	54.55	55.54	74	-19.45	34.6	9.92	45.51	100	40	Peak
5150	50.51	51.5	54	-3.49	34.6	9.92	45.51	100	40	Average
5200	97.77	98.78	/	/	34.6	9.9	45.51	100	40	Peak
5200	90.82	91.83	/	/	34.6	9.9	45.51	100	40	Average
5350	54.5	55.56	74	-19.5	34.6	9.85	45.51	100	40	Peak
5350	47.68	48.74	54	-6.32	34.6	9.85	45.51	100	40	Average

REMARKS:

- Emission Level = Read Level+ Antenna Factor + Cable Loss- Preamp Factor
Margin value = Emission level – Limit value.
- 5200MHz: Fundamental frequency.



CHANNEL	TX Channel 48	DETECTOR FUNCTION	Peak (PK)
FREQUENCY RANGE	1GHz ~ 40GHz		Average (AV)

ANTENNA POLARITY & TEST DISTANCE: HORIZONTAL AT 3 M

FREQ. (MHz)	EMISSION LEVEL (dBuV/m)	READ LEVEL (dBuV)	LIMIT (dBuV/m)	MARGIN (dB)	ANTENNA FACTOR (dB /m)	CABLE LOSS (dB)	PREAMP FACTOR (dB)	ANTENNA HEIGHT (cm)	TABLE ANGLE (Degree)	REMARK
5150	55.31	56.38	74	-18.69	34.52	9.92	45.51	145	50	Peak
5150	49.91	50.98	54	-4.09	34.52	9.92	45.51	145	50	Average
5240	102.74	103.77	/	/	34.59	9.89	45.51	145	50	Peak
5240	96.12	97.15	/	/	34.59	9.89	45.51	145	50	Average
5350	53.98	54.96	74	-20.02	34.68	9.85	45.51	145	50	Peak
5350	47.9	48.88	54	-6.1	34.68	9.85	45.51	145	50	Average

ANTENNA POLARITY & TEST DISTANCE: VERTICAL AT 3 M

FREQ. (MHz)	EMISSION LEVEL (dBuV/m)	READ LEVEL (dBuV)	LIMIT (dBuV/m)	MARGIN (dB)	ANTENNA FACTOR (dB /m)	CABLE LOSS (dB)	PREAMP FACTOR (dB)	ANTENNA HEIGHT (cm)	TABLE ANGLE (Degree)	REMARK
5150	56.27	57.26	74	-17.73	34.6	9.92	45.51	100	40	Peak
5150	49.15	50.14	54	-4.85	34.6	9.92	45.51	100	40	Average
5240	99.41	100.43	/	/	34.6	9.89	45.51	100	40	Peak
5240	90.87	91.89	/	/	34.6	9.89	45.51	100	40	Average
5350	54.84	55.9	74	-19.16	34.6	9.85	45.51	100	40	Peak
5350	47.84	48.9	54	-6.16	34.6	9.85	45.51	100	40	Average

REMARKS:

- Emission Level = Read Level+ Antenna Factor + Cable Loss- Preamp Factor
Margin value = Emission level – Limit value.
- 5240MHz: Fundamental frequency.



802.11n (20MHz)

CHANNEL	TX Channel 36	DETECTOR FUNCTION	Peak (PK)
FREQUENCY RANGE	1GHz ~ 40GHz		Average (AV)

ANTENNA POLARITY & TEST DISTANCE: HORIZONTAL AT 3 M

FREQ. (MHz)	EMISSION LEVEL (dBuV/m)	READ LEVEL (dBuV)	LIMIT (dBuV/m)	MARGIN (dB)	ANTENNA FACTOR (dB /m)	CABLE LOSS (dB)	PREAMP FACTOR (dB)	ANTENNA HEIGHT (cm)	TABLE ANGLE (Degree)	REMARK
5150	55.63	56.7	74	-18.37	34.52	9.92	45.51	135	50	Peak
5150	50.29	51.36	54	-3.71	34.52	9.92	45.51	135	50	Average
5180	103.08	104.14	/	/	34.54	9.91	45.51	135	50	Peak
5180	95.66	96.72	/	/	34.54	9.91	45.51	135	50	Average
5350	53.09	54.07	74	-20.91	34.68	9.85	45.51	135	50	Peak
5350	48.23	49.21	54	-5.77	34.68	9.85	45.51	135	50	Average

ANTENNA POLARITY & TEST DISTANCE: VERTICAL AT 3 M

FREQ. (MHz)	EMISSION LEVEL (dBuV/m)	READ LEVEL (dBuV)	LIMIT (dBuV/m)	MARGIN (dB)	ANTENNA FACTOR (dB /m)	CABLE LOSS (dB)	PREAMP FACTOR (dB)	ANTENNA HEIGHT (cm)	TABLE ANGLE (Degree)	REMARK
5150	54.58	55.57	74	-19.42	34.6	9.92	45.51	145	45	Peak
5150	49.66	50.65	54	-4.34	34.6	9.92	45.51	145	45	Average
5180	99.53	100.53	/	/	34.6	9.91	45.51	145	45	Peak
5180	92.3	93.3	/	/	34.6	9.91	45.51	145	45	Average
5350	53.17	54.23	74	-20.83	34.6	9.85	45.51	145	45	Peak
5350	48.48	49.54	54	-5.52	34.6	9.85	45.51	145	45	Average

REMARKS:

- Emission Level = Read Level+ Antenna Factor + Cable Loss- Preamp Factor
Margin value = Emission level – Limit value.
- 5180MHz: Fundamental frequency.



CHANNEL	TX Channel 40	DETECTOR FUNCTION	Peak (PK)
FREQUENCY RANGE	1GHz ~ 40GHz		Average (AV)

ANTENNA POLARITY & TEST DISTANCE: HORIZONTAL AT 3 M

FREQ. (MHz)	EMISSION LEVEL (dBuV/m)	READ LEVEL (dBuV)	LIMIT (dBuV/m)	MARGIN (dB)	ANTENNA FACTOR (dB /m)	CABLE LOSS (dB)	PREAMP FACTOR (dB)	ANTENNA HEIGHT (cm)	TABLE ANGLE (Degree)	REMARK
5150	55.24	56.31	74	-18.76	34.52	9.92	45.51	135	50	Peak
5150	49.81	50.88	54	-4.19	34.52	9.92	45.51	135	50	Average
5200	102.54	103.59	/	/	34.56	9.9	45.51	135	50	Peak
5200	96.32	97.37	/	/	34.56	9.9	45.51	135	50	Average
5350	54.09	55.07	74	-19.91	34.68	9.85	45.51	135	50	Peak
5350	48.07	49.05	54	-5.93	34.68	9.85	45.51	135	50	Average

ANTENNA POLARITY & TEST DISTANCE: VERTICAL AT 3 M

FREQ. (MHz)	EMISSION LEVEL (dBuV/m)	READ LEVEL (dBuV)	LIMIT (dBuV/m)	MARGIN (dB)	ANTENNA FACTOR (dB /m)	CABLE LOSS (dB)	PREAMP FACTOR (dB)	ANTENNA HEIGHT (cm)	TABLE ANGLE (Degree)	REMARK
5150	55.1	56.09	74	-18.9	34.6	9.92	45.51	135	45	Peak
5150	49.71	50.7	54	-4.29	34.6	9.92	45.51	135	45	Average
5200	100.14	101.15	/	/	34.6	9.9	45.51	135	45	Peak
5200	93.77	94.78	/	/	34.6	9.9	45.51	135	45	Average
5350	53.76	54.82	74	-20.24	34.6	9.85	45.51	135	45	Peak
5350	47.76	48.82	54	-6.24	34.6	9.85	45.51	135	45	Average

REMARKS:

- Emission Level = Read Level+ Antenna Factor + Cable Loss- Preamp Factor
Margin value = Emission level – Limit value.
- 5200MHz: Fundamental frequency.



CHANNEL	TX Channel 48	DETECTOR FUNCTION	Peak (PK)
FREQUENCY RANGE	1GHz ~ 40GHz		Average (AV)

ANTENNA POLARITY & TEST DISTANCE: HORIZONTAL AT 3 M

FREQ. (MHz)	EMISSION LEVEL (dBuV/m)	READ LEVEL (dBuV)	LIMIT (dBuV/m)	MARGIN (dB)	ANTENNA FACTOR (dB /m)	CABLE LOSS (dB)	PREAMP FACTOR (dB)	ANTENNA HEIGHT (cm)	TABLE ANGLE (Degree)	REMARK
5150	56.36	57.43	74	-17.64	34.52	9.92	45.51	140	15	Peak
5150	49.87	50.94	54	-4.13	34.52	9.92	45.51	140	15	Average
5240	101.06	102.09	/	/	34.59	9.89	45.51	140	15	Peak
5240	93.75	94.78	/	/	34.59	9.89	45.51	140	15	Average
5350	53.69	54.67	74	-20.31	34.68	9.85	45.51	140	15	Peak
5350	47.12	48.1	54	-6.88	34.68	9.85	45.51	140	15	Average

ANTENNA POLARITY & TEST DISTANCE: VERTICAL AT 3 M

FREQ. (MHz)	EMISSION LEVEL (dBuV/m)	READ LEVEL (dBuV)	LIMIT (dBuV/m)	MARGIN (dB)	ANTENNA FACTOR (dB /m)	CABLE LOSS (dB)	PREAMP FACTOR (dB)	ANTENNA HEIGHT (cm)	TABLE ANGLE (Degree)	REMARK
5150	56.62	57.61	74	-17.38	34.6	9.92	45.51	135	45	Peak
5150	49.7	50.69	54	-4.3	34.6	9.92	45.51	135	45	Average
5240	98.87	99.89	/	/	34.6	9.89	45.51	135	45	Peak
5240	92.04	93.06	/	/	34.6	9.89	45.51	135	45	Average
5350	54.58	55.64	74	-19.42	34.6	9.85	45.51	135	45	Peak
5350	48.56	49.62	54	-5.44	34.6	9.85	45.51	135	45	Average

REMARKS:

- Emission Level = Read Level+ Antenna Factor + Cable Loss- Preamp Factor
Margin value = Emission level – Limit value.
- 5240MHz: Fundamental frequency.



802.11n (40MHz)

CHANNEL	TX Channel 38	DETECTOR FUNCTION	Peak (PK)
FREQUENCY RANGE	1GHz ~ 40GHz		Average (AV)

ANTENNA POLARITY & TEST DISTANCE: HORIZONTAL AT 3 M

FREQ. (MHz)	EMISSION LEVEL (dBuV/m)	READ LEVEL (dBuV)	LIMIT (dBuV/m)	MARGIN (dB)	ANTENNA FACTOR (dB /m)	CABLE LOSS (dB)	PREAMP FACTOR (dB)	ANTENNA HEIGHT (cm)	TABLE ANGLE (Degree)	REMARK
5150	58.35	59.42	74	-15.65	34.52	9.92	45.51	135	45	Peak
5150	50.89	51.96	54	-3.11	34.52	9.92	45.51	135	45	Average
5190	96.36	97.41	/	/	34.55	9.91	45.51	135	45	Peak
5190	89.9	90.95	/	/	34.55	9.91	45.51	135	45	Average
5350	55.51	56.49	74	-18.49	34.68	9.85	45.51	135	45	Peak
5350	48.65	49.63	54	-5.35	34.68	9.85	45.51	135	45	Average

ANTENNA POLARITY & TEST DISTANCE: VERTICAL AT 3 M

FREQ. (MHz)	EMISSION LEVEL (dBuV/m)	READ LEVEL (dBuV)	LIMIT (dBuV/m)	MARGIN (dB)	ANTENNA FACTOR (dB /m)	CABLE LOSS (dB)	PREAMP FACTOR (dB)	ANTENNA HEIGHT (cm)	TABLE ANGLE (Degree)	REMARK
5150	57.48	58.47	74	-16.52	34.6	9.92	45.51	135	45	Peak
5150	50.5	51.49	54	-3.5	34.6	9.92	45.51	135	45	Average
5190	94.22	95.22	/	/	34.6	9.91	45.51	135	45	Peak
5190	87.88	88.88	/	/	34.6	9.91	45.51	135	45	Average
5350	53.73	54.79	74	-20.27	34.6	9.85	45.51	135	45	Peak
5350	47.8	48.86	54	-6.2	34.6	9.85	45.51	135	45	Average

REMARKS:

- Emission Level = Read Level+ Antenna Factor + Cable Loss- Preamp Factor
Margin value = Emission level – Limit value.
- 5190MHz: Fundamental frequency.



CHANNEL	TX Channel 46	DETECTOR FUNCTION	Peak (PK)
FREQUENCY RANGE	1GHz ~ 40GHz		Average (AV)

ANTENNA POLARITY & TEST DISTANCE: HORIZONTAL AT 3 M

FREQ. (MHz)	EMISSION LEVEL (dBuV/m)	READ LEVEL (dBuV)	LIMIT (dBuV/m)	MARGIN (dB)	ANTENNA FACTOR (dB /m)	CABLE LOSS (dB)	PREAMP FACTOR (dB)	ANTENNA HEIGHT (cm)	TABLE ANGLE (Degree)	REMARK
5150	55.03	56.1	74	-18.97	34.52	9.92	45.51	135	10	Peak
5150	49.39	50.46	54	-4.61	34.52	9.92	45.51	135	10	Average
5230	97.97	99.01	/	/	34.58	9.89	45.51	135	10	Peak
5230	92.11	93.15	/	/	34.58	9.89	45.51	135	10	Average
5350	54.13	55.11	74	-19.87	34.68	9.85	45.51	135	10	Peak
5350	47.5	48.48	54	-6.5	34.68	9.85	45.51	135	10	Average

ANTENNA POLARITY & TEST DISTANCE: VERTICAL AT 3 M

FREQ. (MHz)	EMISSION LEVEL (dBuV/m)	READ LEVEL (dBuV)	LIMIT (dBuV/m)	MARGIN (dB)	ANTENNA FACTOR (dB /m)	CABLE LOSS (dB)	PREAMP FACTOR (dB)	ANTENNA HEIGHT (cm)	TABLE ANGLE (Degree)	REMARK
5150	53.55	54.54	74	-20.45	34.6	9.92	45.51	135	45	Peak
5150	49.43	50.42	54	-4.57	34.6	9.92	45.51	135	45	Average
5230	95.39	96.41	/	/	34.6	9.89	45.51	135	45	Peak
5230	89.48	90.5	/	/	34.6	9.89	45.51	135	45	Average
5350	54.28	55.34	74	-19.72	34.6	9.85	45.51	135	45	Peak
5350	47.8	48.86	54	-6.2	34.6	9.85	45.51	135	45	Average

REMARKS:

- Emission Level = Read Level+ Antenna Factor + Cable Loss- Preamp Factor
Margin value = Emission level – Limit value.
- 5230MHz: Fundamental frequency.



802.11ac (20MHz)

CHANNEL	TX Channel 36	DETECTOR FUNCTION	Peak (PK)
FREQUENCY RANGE	1GHz ~ 40GHz		Average (AV)

ANTENNA POLARITY & TEST DISTANCE: HORIZONTAL AT 3 M

FREQ. (MHz)	EMISSION LEVEL (dBuV/m)	READ LEVEL (dBuV)	LIMIT (dBuV/m)	MARGIN (dB)	ANTENNA FACTOR (dB /m)	CABLE LOSS (dB)	PREAMP FACTOR (dB)	ANTENNA HEIGHT (cm)	TABLE ANGLE (Degree)	REMARK
5150	55.34	56.41	74	-18.66	34.52	9.92	45.51	135	10	Peak
5150	49.42	50.49	54	-4.58	34.52	9.92	45.51	135	10	Average
5180	101.03	102.09	/	/	34.54	9.91	45.51	135	10	Peak
5180	93.59	94.65	/	/	34.54	9.91	45.51	135	10	Average
5350	54.19	55.17	74	-19.81	34.68	9.85	45.51	135	10	Peak
5350	48.53	49.51	54	-5.47	34.68	9.85	45.51	135	10	Average

ANTENNA POLARITY & TEST DISTANCE: VERTICAL AT 3 M

FREQ. (MHz)	EMISSION LEVEL (dBuV/m)	READ LEVEL (dBuV)	LIMIT (dBuV/m)	MARGIN (dB)	ANTENNA FACTOR (dB /m)	CABLE LOSS (dB)	PREAMP FACTOR (dB)	ANTENNA HEIGHT (cm)	TABLE ANGLE (Degree)	REMARK
5150	53.85	54.84	74	-20.15	34.6	9.92	45.51	135	45	Peak
5150	49.31	50.3	54	-4.69	34.6	9.92	45.51	135	45	Average
5180	97.9	98.9	/	/	34.6	9.91	45.51	135	45	Peak
5180	90.96	91.96	/	/	34.6	9.91	45.51	135	45	Average
5350	54.02	55.08	74	-19.98	34.6	9.85	45.51	135	45	Peak
5350	47.98	49.04	54	-6.02	34.6	9.85	45.51	135	45	Average

REMARKS:

- Emission Level = Read Level+ Antenna Factor + Cable Loss- Preamp Factor
Margin value = Emission level – Limit value.
- 5180MHz: Fundamental frequency.



CHANNEL	TX Channel 40	DETECTOR FUNCTION	Peak (PK)
FREQUENCY RANGE	1GHz ~ 40GHz		Average (AV)

ANTENNA POLARITY & TEST DISTANCE: HORIZONTAL AT 3 M

FREQ. (MHz)	EMISSION LEVEL (dBuV/m)	READ LEVEL (dBuV)	LIMIT (dBuV/m)	MARGIN (dB)	ANTENNA FACTOR (dB /m)	CABLE LOSS (dB)	PREAMP FACTOR (dB)	ANTENNA HEIGHT (cm)	TABLE ANGLE (Degree)	REMARK
5150	55.3	56.37	74	-18.7	34.52	9.92	45.51	135	15	Peak
5150	48.81	49.88	54	-5.19	34.52	9.92	45.51	135	15	Average
5200	101.15	102.2	/	/	34.56	9.9	45.51	135	15	Peak
5200	93.56	94.61	/	/	34.56	9.9	45.51	135	15	Average
5350	54.36	55.34	74	-19.64	34.68	9.85	45.51	135	15	Peak
5350	47.77	48.75	54	-6.23	34.68	9.85	45.51	135	15	Average

ANTENNA POLARITY & TEST DISTANCE: VERTICAL AT 3 M

FREQ. (MHz)	EMISSION LEVEL (dBuV/m)	READ LEVEL (dBuV)	LIMIT (dBuV/m)	MARGIN (dB)	ANTENNA FACTOR (dB /m)	CABLE LOSS (dB)	PREAMP FACTOR (dB)	ANTENNA HEIGHT (cm)	TABLE ANGLE (Degree)	REMARK
5150	55.31	56.3	74	-18.69	34.6	9.92	45.51	135	45	Peak
5150	49.33	50.32	54	-4.67	34.6	9.92	45.51	135	45	Average
5200	98.83	99.84	/	/	34.6	9.9	45.51	135	45	Peak
5200	91.9	92.91	/	/	34.6	9.9	45.51	135	45	Average
5350	53.23	54.29	74	-20.77	34.6	9.85	45.51	135	45	Peak
5350	47.75	48.81	54	-6.25	34.6	9.85	45.51	135	45	Average

REMARKS:

- Emission Level = Read Level+ Antenna Factor + Cable Loss- Preamp Factor
Margin value = Emission level – Limit value.
- 5200MHz: Fundamental frequency.



CHANNEL	TX Channel 48	DETECTOR FUNCTION	Peak (PK)
FREQUENCY RANGE	1GHz ~ 40GHz		Average (AV)

ANTENNA POLARITY & TEST DISTANCE: HORIZONTAL AT 3 M

FREQ. (MHz)	EMISSION LEVEL (dBuV/m)	READ LEVEL (dBuV)	LIMIT (dBuV/m)	MARGIN (dB)	ANTENNA FACTOR (dB /m)	CABLE LOSS (dB)	PREAMP FACTOR (dB)	ANTENNA HEIGHT (cm)	TABLE ANGLE (Degree)	REMARK
5150	55.93	57	74	-18.07	34.52	9.92	45.51	135	15	Peak
5150	49.9	50.97	54	-4.1	34.52	9.92	45.51	135	15	Average
5240	100.11	101.14	/	/	34.59	9.89	45.51	135	15	Peak
5240	93.17	94.2	/	/	34.59	9.89	45.51	135	15	Average
5350	54.02	55	74	-19.98	34.68	9.85	45.51	135	15	Peak
5350	47.45	48.43	54	-6.55	34.68	9.85	45.51	135	15	Average

ANTENNA POLARITY & TEST DISTANCE: VERTICAL AT 3 M

FREQ. (MHz)	EMISSION LEVEL (dBuV/m)	READ LEVEL (dBuV)	LIMIT (dBuV/m)	MARGIN (dB)	ANTENNA FACTOR (dB /m)	CABLE LOSS (dB)	PREAMP FACTOR (dB)	ANTENNA HEIGHT (cm)	TABLE ANGLE (Degree)	REMARK
5150	55.47	56.46	74	-18.53	34.6	9.92	45.51	135	45	Peak
5150	49.74	50.73	54	-4.26	34.6	9.92	45.51	135	45	Average
5240	98.16	99.18	/	/	34.6	9.89	45.51	135	45	Peak
5240	91.31	92.33	/	/	34.6	9.89	45.51	135	45	Average
5350	54.82	55.88	74	-19.18	34.6	9.85	45.51	135	45	Peak
5350	47.4	48.46	54	-6.6	34.6	9.85	45.51	135	45	Average

REMARKS:

- Emission Level = Read Level+ Antenna Factor + Cable Loss- Preamp Factor
Margin value = Emission level – Limit value.
- 5240MHz: Fundamental frequency.



802.11ac (40MHz)

CHANNEL	TX Channel 38	DETECTOR FUNCTION	Peak (PK)
FREQUENCY RANGE	1GHz ~ 40GHz		Average (AV)

ANTENNA POLARITY & TEST DISTANCE: HORIZONTAL AT 3 M

FREQ. (MHz)	EMISSION LEVEL (dBuV/m)	READ LEVEL (dBuV)	LIMIT (dBuV/m)	MARGIN (dB)	ANTENNA FACTOR (dB /m)	CABLE LOSS (dB)	PREAMP FACTOR (dB)	ANTENNA HEIGHT (cm)	TABLE ANGLE (Degree)	REMARK
5150	55.11	56.18	74	-18.89	34.52	9.92	45.51	135	50	Peak
5150	50.96	52.03	54	-3.04	34.52	9.92	45.51	135	50	Average
5190	95.41	96.46	/	/	34.55	9.91	45.51	135	50	Peak
5190	89.48	90.53	/	/	34.55	9.91	45.51	135	50	Average
5350	52.71	53.69	74	-21.29	34.68	9.85	45.51	135	50	Peak
5350	47.56	48.54	54	-6.44	34.68	9.85	45.51	135	50	Average

ANTENNA POLARITY & TEST DISTANCE: VERTICAL AT 3 M

FREQ. (MHz)	EMISSION LEVEL (dBuV/m)	READ LEVEL (dBuV)	LIMIT (dBuV/m)	MARGIN (dB)	ANTENNA FACTOR (dB /m)	CABLE LOSS (dB)	PREAMP FACTOR (dB)	ANTENNA HEIGHT (cm)	TABLE ANGLE (Degree)	REMARK
5150	55.72	56.71	74	-18.28	34.6	9.92	45.51	135	45	Peak
5150	49.89	50.88	54	-4.11	34.6	9.92	45.51	135	45	Average
5190	92.89	93.89	/	/	34.6	9.91	45.51	135	45	Peak
5190	86.57	87.57	/	/	34.6	9.91	45.51	135	45	Average
5350	54.31	55.37	74	-19.69	34.6	9.85	45.51	135	45	Peak
5350	47.42	48.48	54	-6.58	34.6	9.85	45.51	135	45	Average

REMARKS:

- Emission Level = Read Level+ Antenna Factor + Cable Loss- Preamp Factor
Margin value = Emission level – Limit value.
- 5190MHz: Fundamental frequency.



CHANNEL	TX Channel 46	DETECTOR FUNCTION	Peak (PK)
FREQUENCY RANGE	1GHz ~ 40GHz		Average (AV)

ANTENNA POLARITY & TEST DISTANCE: HORIZONTAL AT 3 M

FREQ. (MHz)	EMISSION LEVEL (dBuV/m)	READ LEVEL (dBuV)	LIMIT (dBuV/m)	MARGIN (dB)	ANTENNA FACTOR (dB /m)	CABLE LOSS (dB)	PREAMP FACTOR (dB)	ANTENNA HEIGHT (cm)	TABLE ANGLE (Degree)	REMARK
5150	54.36	55.43	74	-19.64	34.52	9.92	45.51	135	18	Peak
5150	49.64	50.71	54	-4.36	34.52	9.92	45.51	135	18	Average
5230	97.19	98.23	/	/	34.58	9.89	45.51	135	18	Peak
5230	92.02	93.06	/	/	34.58	9.89	45.51	135	18	Average
5350	53.67	54.65	74	-20.33	34.68	9.85	45.51	135	18	Peak
5350	47.95	48.93	54	-6.05	34.68	9.85	45.51	135	18	Average

ANTENNA POLARITY & TEST DISTANCE: VERTICAL AT 3 M

FREQ. (MHz)	EMISSION LEVEL (dBuV/m)	READ LEVEL (dBuV)	LIMIT (dBuV/m)	MARGIN (dB)	ANTENNA FACTOR (dB /m)	CABLE LOSS (dB)	PREAMP FACTOR (dB)	ANTENNA HEIGHT (cm)	TABLE ANGLE (Degree)	REMARK
5150	55.43	56.42	74	-18.57	34.6	9.92	45.51	135	45	Peak
5150	50.35	51.34	54	-3.65	34.6	9.92	45.51	135	45	Average
5230	94.7	95.72	/	/	34.6	9.89	45.51	135	45	Peak
5230	89.14	90.16	/	/	34.6	9.89	45.51	135	45	Average
5350	52.92	53.98	74	-21.08	34.6	9.85	45.51	135	45	Peak
5350	48.06	49.12	54	-5.94	34.6	9.85	45.51	135	45	Average

REMARKS:

- Emission Level = Read Level+ Antenna Factor + Cable Loss- Preamp Factor
Margin value = Emission level – Limit value.
- 5230MHz: Fundamental frequency.



802.11ac (80MHz)

CHANNEL	TX Channel 42	DETECTOR FUNCTION	Peak (PK)
FREQUENCY RANGE	1GHz ~ 40GHz		Average (AV)

ANTENNA POLARITY & TEST DISTANCE: HORIZONTAL AT 3 M										
FREQ. (MHz)	EMISSION LEVEL (dBuV/m)	READ LEVEL (dBuV)	LIMIT (dBuV/m)	MARGIN (dB)	ANTENNA FACTOR (dB /m)	CABLE LOSS (dB)	PREAMP FACTOR (dB)	ANTENNA HEIGHT (cm)	TABLE ANGLE (Degree)	REMARK
5150	56.6	57.67	74	-17.4	34.52	9.92	45.51	135	18	Peak
5150	50.98	52.05	54	-3.02	34.52	9.92	45.51	135	18	Average
5210	92.29	93.33	/	/	34.57	9.9	45.51	135	18	Peak
5210	85.9	86.94	/	/	34.57	9.9	45.51	135	18	Average
5350	54.07	55.05	74	-19.93	34.68	9.85	45.51	135	18	Peak
5350	48.54	49.52	54	-5.46	34.68	9.85	45.51	135	18	Average
ANTENNA POLARITY & TEST DISTANCE: VERTICAL AT 3 M										
FREQ. (MHz)	EMISSION LEVEL (dBuV/m)	READ LEVEL (dBuV)	LIMIT (dBuV/m)	MARGIN (dB)	ANTENNA FACTOR (dB /m)	CABLE LOSS (dB)	PREAMP FACTOR (dB)	ANTENNA HEIGHT (cm)	TABLE ANGLE (Degree)	REMARK
5150	54.84	55.83	74	-19.16	34.6	9.92	45.51	145	45	Peak
5150	50.46	51.45	54	-3.54	34.6	9.92	45.51	145	45	Average
5210	89.5	90.51	/	/	34.6	9.9	45.51	145	45	Peak
5210	83.82	84.83	/	/	34.6	9.9	45.51	145	45	Average
5350	54.34	55.4	74	-19.66	34.6	9.85	45.51	145	45	Peak
5350	47.83	48.89	54	-6.17	34.6	9.85	45.51	145	45	Average

REMARKS:

- Emission Level = Read Level+ Antenna Factor + Cable Loss- Preamp Factor
Margin value = Emission level – Limit value.
- 5210MHz: Fundamental frequency.



**Worst case harmonic:
802.11ac (80MHz)**

CHANNEL	TX Channel 42	DETECTOR FUNCTION	Peak (PK)
FREQUENCY RANGE	1GHz ~ 40GHz		Average (AV)

ANTENNA POLARITY & TEST DISTANCE: HORIZONTAL AT 3 M

	Freq	Level	Read Level	Limit Line	Over Limit	Factor	Remark	Pol/Phase
	MHz	dBuV/m	dBuV	dBuV/m	dB	dB/m		
1	10418.000	53.33	43.30	74.00	-20.67	10.03	Peak	Horizontal
2	10418.000	41.92	31.89	54.00	-12.08	10.03	Average	Horizontal
3	PK15630.000	55.52	39.97	74.00	-18.48	15.55	Peak	Horizontal
4	PP15630.000	47.37	31.82	54.00	-6.63	15.55	Average	Horizontal

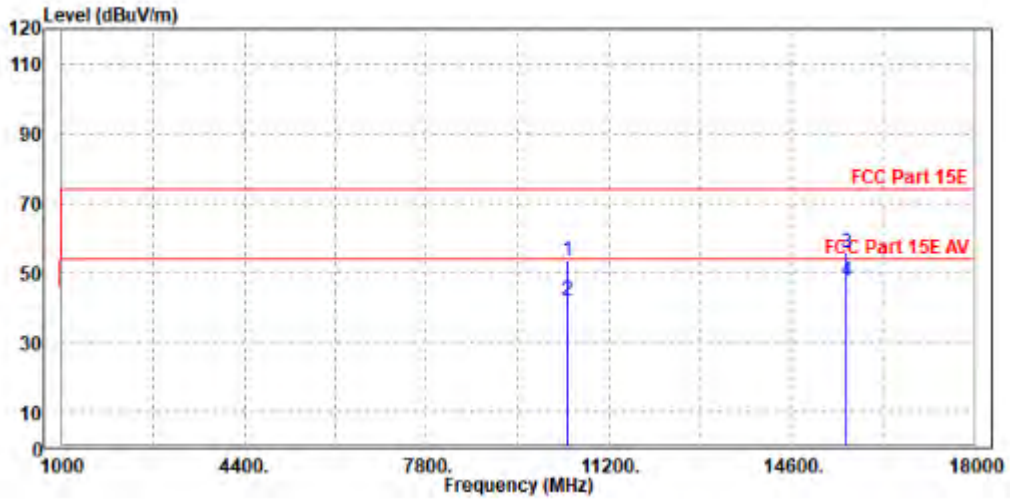



ANTENNA POLARITY & TEST DISTANCE: VERTICAL AT 3 M

	Freq	Level	Read Level	Limit Line	Over Limit	Factor	Remark	Pol/Phase
	MHz	dBuV/m	dBuV	dBuV/m	dB	dB/m		
1	10420.000	50.48	42.36	74.00	-23.52	8.12	Peak	Vertical
2	10420.000	42.35	34.23	54.00	-11.65	8.12	Average	Vertical
3	PK15637.000	52.32	40.28	74.00	-21.68	12.04	Peak	Vertical
4	PP15637.000	43.56	31.52	54.00	-10.44	12.04	Average	Vertical

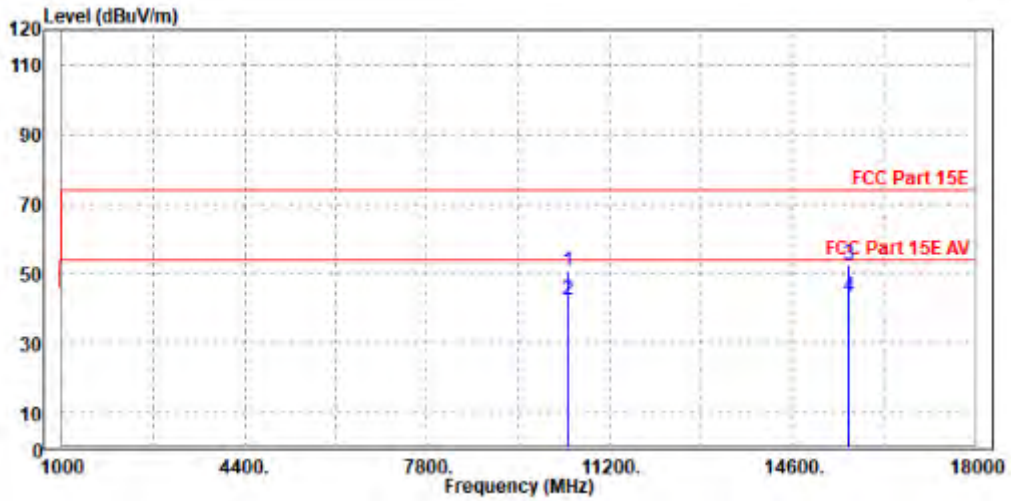

REMARKS:

- Emission Level = Read Level+ Antenna Factor + Cable Loss- Preamp Factor
Margin value = Emission level – Limit value.
- 5210MHz: Fundamental frequency.
- For frequency above 18GHz, the emission was tested 20db below the limit so the data not recorded in the sheet.



Band 2
802.11a

CHANNEL	TX Channel 52	DETECTOR FUNCTION	Peak (PK)
FREQUENCY RANGE	1GHz ~ 40GHz		Average (AV)

ANTENNA POLARITY & TEST DISTANCE: HORIZONTAL AT 3 M

FREQ. (MHz)	EMISSION LEVEL (dBuV/m)	READ LEVEL (dBuV)	LIMIT (dBuV/m)	MARGIN (dB)	ANTENNA FACTOR (dB /m)	CABLE LOSS (dB)	PREAMP FACTOR (dB)	ANTENNA HEIGHT (cm)	TABLE ANGLE (Degree)	REMARK
5150	55.18	56.25	74	-18.82	34.52	9.92	45.51	200	18	Peak
5150	49.89	50.96	54	-4.11	34.52	9.92	45.51	200	18	Average
5260	103.01	104.03	/	/	34.61	9.88	45.51	200	18	Peak
5260	96.43	97.45	/	/	34.61	9.88	45.51	200	18	Average
5350	53.2	54.18	74	-20.8	34.68	9.85	45.51	200	18	Peak
5350	47.75	48.73	54	-6.25	34.68	9.85	45.51	200	18	Average

ANTENNA POLARITY & TEST DISTANCE: VERTICAL AT 3 M

FREQ. (MHz)	EMISSION LEVEL (dBuV/m)	READ LEVEL (dBuV)	LIMIT (dBuV/m)	MARGIN (dB)	ANTENNA FACTOR (dB /m)	CABLE LOSS (dB)	PREAMP FACTOR (dB)	ANTENNA HEIGHT (cm)	TABLE ANGLE (Degree)	REMARK
5150	54.45	55.44	74	-19.55	34.6	9.92	45.51	100	45	Peak
5150	49.57	50.56	54	-4.43	34.6	9.92	45.51	100	45	Average
5260	99.69	100.72	/	/	34.6	9.88	45.51	100	45	Peak
5260	93.35	94.38	/	/	34.6	9.88	45.51	100	45	Average
5350	54.24	55.3	74	-19.76	34.6	9.85	45.51	100	45	Peak
5350	47.63	48.69	54	-6.37	34.6	9.85	45.51	100	45	Average

REMARKS:

- Emission Level = Read Level+ Antenna Factor + Cable Loss- Preamp Factor
Margin value = Emission level – Limit value.
- 5260MHz: Fundamental frequency.



CHANNEL	TX Channel 60	DETECTOR FUNCTION	Peak (PK)
FREQUENCY RANGE	1GHz ~ 40GHz		Average (AV)

ANTENNA POLARITY & TEST DISTANCE: HORIZONTAL AT 3 M

FREQ. (MHz)	EMISSION LEVEL (dBuV/m)	READ LEVEL (dBuV)	LIMIT (dBuV/m)	MARGIN (dB)	ANTENNA FACTOR (dB /m)	CABLE LOSS (dB)	PREAMP FACTOR (dB)	ANTENNA HEIGHT (cm)	TABLE ANGLE (Degree)	REMARK
5150	54.97	56.04	74	-19.03	34.52	9.92	45.51	200	18	Peak
5150	49.31	50.38	54	-4.69	34.52	9.92	45.51	200	18	Average
5300	100.7	101.7	/	/	34.64	9.87	45.51	200	18	Peak
5300	94.25	95.25	/	/	34.64	9.87	45.51	200	18	Average
5350	53.78	54.76	74	-20.22	34.68	9.85	45.51	200	18	Peak
5350	47.36	48.34	54	-6.64	34.68	9.85	45.51	200	18	Average

ANTENNA POLARITY & TEST DISTANCE: VERTICAL AT 3 M

FREQ. (MHz)	EMISSION LEVEL (dBuV/m)	READ LEVEL (dBuV)	LIMIT (dBuV/m)	MARGIN (dB)	ANTENNA FACTOR (dB /m)	CABLE LOSS (dB)	PREAMP FACTOR (dB)	ANTENNA HEIGHT (cm)	TABLE ANGLE (Degree)	REMARK
5150	56.58	57.57	74	-17.42	34.6	9.92	45.51	150	45	Peak
5150	49.43	50.42	54	-4.57	34.6	9.92	45.51	150	45	Average
5300	99.45	100.49	/	/	34.6	9.87	45.51	150	45	Peak
5300	92.96	94	/	/	34.6	9.87	45.51	150	45	Average
5350	53	54.06	74	-21	34.6	9.85	45.51	150	45	Peak
5350	47.63	48.69	54	-6.37	34.6	9.85	45.51	150	45	Average

REMARKS:

- Emission Level = Read Level+ Antenna Factor + Cable Loss- Preamp Factor
Margin value = Emission level – Limit value.
- 5300MHz: Fundamental frequency.



CHANNEL	TX Channel 64	DETECTOR FUNCTION	Peak (PK)
FREQUENCY RANGE	1GHz ~ 40GHz		Average (AV)

ANTENNA POLARITY & TEST DISTANCE: HORIZONTAL AT 3 M

FREQ. (MHz)	EMISSION LEVEL (dBuV/m)	READ LEVEL (dBuV)	LIMIT (dBuV/m)	MARGIN (dB)	ANTENNA FACTOR (dB /m)	CABLE LOSS (dB)	PREAMP FACTOR (dB)	ANTENNA HEIGHT (cm)	TABLE ANGLE (Degree)	REMARK
5150	54.49	55.56	74	-19.51	34.52	9.92	45.51	200	18	Peak
5150	49.23	50.3	54	-4.77	34.52	9.92	45.51	200	18	Average
5320	101.07	102.06	/	/	34.66	9.86	45.51	200	18	Peak
5320	94.83	95.82	/	/	34.66	9.86	45.51	200	18	Average
5350	54.96	55.94	74	-19.04	34.68	9.85	45.51	200	18	Peak
5350	48.62	49.6	54	-5.38	34.68	9.85	45.51	200	18	Average

ANTENNA POLARITY & TEST DISTANCE: VERTICAL AT 3 M

FREQ. (MHz)	EMISSION LEVEL (dBuV/m)	READ LEVEL (dBuV)	LIMIT (dBuV/m)	MARGIN (dB)	ANTENNA FACTOR (dB /m)	CABLE LOSS (dB)	PREAMP FACTOR (dB)	ANTENNA HEIGHT (cm)	TABLE ANGLE (Degree)	REMARK
5150	54.74	55.73	74	-19.26	34.6	9.92	45.51	150	45	Peak
5150	49.26	50.25	54	-4.74	34.6	9.92	45.51	150	45	Average
5320	99.82	100.87	/	/	34.6	9.86	45.51	150	45	Peak
5320	93.52	94.57	/	/	34.6	9.86	45.51	150	45	Average
5350	53.82	54.88	74	-20.18	34.6	9.85	45.51	150	45	Peak
5350	47.69	48.75	54	-6.31	34.6	9.85	45.51	150	45	Average

REMARKS:

- Emission Level = Read Level+ Antenna Factor + Cable Loss- Preamp Factor
Margin value = Emission level – Limit value.
- 5320MHz: Fundamental frequency.



802.11n (20MHz)

CHANNEL	TX Channel 52	DETECTOR FUNCTION	Peak (PK)
FREQUENCY RANGE	1GHz ~ 40GHz		Average (AV)

ANTENNA POLARITY & TEST DISTANCE: HORIZONTAL AT 3 M

FREQ. (MHz)	EMISSION LEVEL (dBuV/m)	READ LEVEL (dBuV)	LIMIT (dBuV/m)	MARGIN (dB)	ANTENNA FACTOR (dB /m)	CABLE LOSS (dB)	PREAMP FACTOR (dB)	ANTENNA HEIGHT (cm)	TABLE ANGLE (Degree)	REMARK
5150	55.16	56.23	74	-18.84	34.52	9.92	45.51	200	18	Peak
5150	49.2	50.27	54	-4.8	34.52	9.92	45.51	200	18	Average
5260	101.77	102.79	/	/	34.61	9.88	45.51	200	18	Peak
5260	95.11	96.13	/	/	34.61	9.88	45.51	200	18	Average
5350	54.3	55.28	74	-19.7	34.68	9.85	45.51	200	18	Peak
5350	49.04	50.02	54	-4.96	34.68	9.85	45.51	200	18	Average

ANTENNA POLARITY & TEST DISTANCE: VERTICAL AT 3 M

FREQ. (MHz)	EMISSION LEVEL (dBuV/m)	READ LEVEL (dBuV)	LIMIT (dBuV/m)	MARGIN (dB)	ANTENNA FACTOR (dB /m)	CABLE LOSS (dB)	PREAMP FACTOR (dB)	ANTENNA HEIGHT (cm)	TABLE ANGLE (Degree)	REMARK
5150	54.64	55.63	74	-19.36	34.6	9.92	45.51	150	45	Peak
5150	49.31	50.3	54	-4.69	34.6	9.92	45.51	150	45	Average
5260	99.21	100.24	/	/	34.6	9.88	45.51	150	45	Peak
5260	92.83	93.86	/	/	34.6	9.88	45.51	150	45	Average
5350	53.95	55.01	74	-20.05	34.6	9.85	45.51	150	45	Peak
5350	47.55	48.61	54	-6.45	34.6	9.85	45.51	150	45	Average

REMARKS:

- Emission Level = Read Level+ Antenna Factor + Cable Loss- Preamp Factor
Margin value = Emission level – Limit value.
- 5260MHz: Fundamental frequency.



CHANNEL	TX Channel 60	DETECTOR FUNCTION	Peak (PK)
FREQUENCY RANGE	1GHz ~ 40GHz		Average (AV)

ANTENNA POLARITY & TEST DISTANCE: HORIZONTAL AT 3 M

FREQ. (MHz)	EMISSION LEVEL (dBuV/m)	READ LEVEL (dBuV)	LIMIT (dBuV/m)	MARGIN (dB)	ANTENNA FACTOR (dB /m)	CABLE LOSS (dB)	PREAMP FACTOR (dB)	ANTENNA HEIGHT (cm)	TABLE ANGLE (Degree)	REMARK
5150	57.05	58.12	74	-16.95	34.52	9.92	45.51	200	18	Peak
5150	49.36	50.43	54	-4.64	34.52	9.92	45.51	200	18	Average
5300	99.81	100.81	/	/	34.64	9.87	45.51	200	18	Peak
5300	93.44	94.44	/	/	34.64	9.87	45.51	200	18	Average
5350	54.01	54.99	74	-19.99	34.68	9.85	45.51	200	18	Peak
5350	48.06	49.04	54	-5.94	34.68	9.85	45.51	200	18	Average

ANTENNA POLARITY & TEST DISTANCE: VERTICAL AT 3 M

FREQ. (MHz)	EMISSION LEVEL (dBuV/m)	READ LEVEL (dBuV)	LIMIT (dBuV/m)	MARGIN (dB)	ANTENNA FACTOR (dB /m)	CABLE LOSS (dB)	PREAMP FACTOR (dB)	ANTENNA HEIGHT (cm)	TABLE ANGLE (Degree)	REMARK
5150	55.6	56.59	74	-18.4	34.6	9.92	45.51	150	45	Peak
5150	49.39	50.38	54	-4.61	34.6	9.92	45.51	150	45	Average
5300	98.34	99.38	/	/	34.6	9.87	45.51	150	45	Peak
5300	92	93.04	/	/	34.6	9.87	45.51	150	45	Average
5350	53.75	54.81	74	-20.25	34.6	9.85	45.51	150	45	Peak
5350	47.77	48.83	54	-6.23	34.6	9.85	45.51	150	45	Average

REMARKS:

- Emission Level = Read Level+ Antenna Factor + Cable Loss- Preamp Factor
Margin value = Emission level – Limit value.
- 5300MHz: Fundamental frequency.



CHANNEL	TX Channel 64	DETECTOR FUNCTION	Peak (PK)
FREQUENCY RANGE	1GHz ~ 40GHz		Average (AV)

ANTENNA POLARITY & TEST DISTANCE: HORIZONTAL AT 3 M

FREQ. (MHz)	EMISSION LEVEL (dBuV/m)	READ LEVEL (dBuV)	LIMIT (dBuV/m)	MARGIN (dB)	ANTENNA FACTOR (dB /m)	CABLE LOSS (dB)	PREAMP FACTOR (dB)	ANTENNA HEIGHT (cm)	TABLE ANGLE (Degree)	REMARK
5150	55.16	56.23	74	-18.84	34.52	9.92	45.51	200	18	Peak
5150	48.99	50.06	54	-5.01	34.52	9.92	45.51	200	18	Average
5320	98.72	99.71	/	/	34.66	9.86	45.51	200	18	Peak
5320	92	92.99	/	/	34.66	9.86	45.51	200	18	Average
5350	54.36	55.34	74	-19.64	34.68	9.85	45.51	200	18	Peak
5350	47.8	48.78	54	-6.2	34.68	9.85	45.51	200	18	Average

ANTENNA POLARITY & TEST DISTANCE: VERTICAL AT 3 M

FREQ. (MHz)	EMISSION LEVEL (dBuV/m)	READ LEVEL (dBuV)	LIMIT (dBuV/m)	MARGIN (dB)	ANTENNA FACTOR (dB /m)	CABLE LOSS (dB)	PREAMP FACTOR (dB)	ANTENNA HEIGHT (cm)	TABLE ANGLE (Degree)	REMARK
5150	55.67	56.66	74	-18.33	34.6	9.92	45.51	150	45	Peak
5150	49.41	50.4	54	-4.59	34.6	9.92	45.51	150	45	Average
5320	97.45	98.5	/	/	34.6	9.86	45.51	150	45	Peak
5320	91.05	92.1	/	/	34.6	9.86	45.51	150	45	Average
5350	55.35	56.41	74	-18.65	34.6	9.85	45.51	150	45	Peak
5350	47.6	48.66	54	-6.4	34.6	9.85	45.51	150	45	Average

REMARKS:

- Emission Level = Read Level+ Antenna Factor + Cable Loss- Preamp Factor
Margin value = Emission level – Limit value.
- 5320MHz: Fundamental frequency.



802.11n (40MHz)

CHANNEL	TX Channel 54	DETECTOR FUNCTION	Peak (PK)
FREQUENCY RANGE	1GHz ~ 40GHz		Average (AV)

ANTENNA POLARITY & TEST DISTANCE: HORIZONTAL AT 3 M

FREQ. (MHz)	EMISSION LEVEL (dBuV/m)	READ LEVEL (dBuV)	LIMIT (dBuV/m)	MARGIN (dB)	ANTENNA FACTOR (dB /m)	CABLE LOSS (dB)	PREAMP FACTOR (dB)	ANTENNA HEIGHT (cm)	TABLE ANGLE (Degree)	REMARK
5150	55.36	56.43	74	-18.64	34.52	9.92	45.51	200	15	Peak
5150	49.31	50.38	54	-4.69	34.52	9.92	45.51	200	15	Average
5270	96.31	97.32	/	/	34.62	9.88	45.51	200	15	Peak
5270	91.06	92.07	/	/	34.62	9.88	45.51	200	15	Average
5350	53.22	54.2	74	-20.78	34.68	9.85	45.51	200	15	Peak
5350	48.41	49.39	54	-5.59	34.68	9.85	45.51	200	15	Average

ANTENNA POLARITY & TEST DISTANCE: VERTICAL AT 3 M

FREQ. (MHz)	EMISSION LEVEL (dBuV/m)	READ LEVEL (dBuV)	LIMIT (dBuV/m)	MARGIN (dB)	ANTENNA FACTOR (dB /m)	CABLE LOSS (dB)	PREAMP FACTOR (dB)	ANTENNA HEIGHT (cm)	TABLE ANGLE (Degree)	REMARK
5150	54.52	55.51	74	-19.48	34.6	9.92	45.51	150	45	Peak
5150	48.89	49.88	54	-5.11	34.6	9.92	45.51	150	45	Average
5270	94.84	95.87	/	/	34.6	9.88	45.51	150	45	Peak
5270	89.45	90.48	/	/	34.6	9.88	45.51	150	45	Average
5350	53.78	54.84	74	-20.22	34.6	9.85	45.51	150	45	Peak
5350	47.56	48.62	54	-6.44	34.6	9.85	45.51	150	45	Average

REMARKS:

- Emission Level = Read Level+ Antenna Factor + Cable Loss- Preamp Factor
Margin value = Emission level – Limit value.
- 5270MHz: Fundamental frequency.



CHANNEL	TX Channel 62	DETECTOR FUNCTION	Peak (PK)
FREQUENCY RANGE	1GHz ~ 40GHz		Average (AV)

ANTENNA POLARITY & TEST DISTANCE: HORIZONTAL AT 3 M

FREQ. (MHz)	EMISSION LEVEL (dBuV/m)	READ LEVEL (dBuV)	LIMIT (dBuV/m)	MARGIN (dB)	ANTENNA FACTOR (dB /m)	CABLE LOSS (dB)	PREAMP FACTOR (dB)	ANTENNA HEIGHT (cm)	TABLE ANGLE (Degree)	REMARK
5150	53.45	54.52	74	-20.55	34.52	9.92	45.51	200	15	Peak
5150	49.55	50.62	54	-4.45	34.52	9.92	45.51	200	15	Average
5310	96.39	97.39	/	/	34.65	9.86	45.51	200	15	Peak
5310	90.27	91.27	/	/	34.65	9.86	45.51	200	15	Average
5350	53.67	54.65	74	-20.33	34.68	9.85	45.51	200	15	Peak
5350	48.81	49.79	54	-5.19	34.68	9.85	45.51	200	15	Average

ANTENNA POLARITY & TEST DISTANCE: VERTICAL AT 3 M

FREQ. (MHz)	EMISSION LEVEL (dBuV/m)	READ LEVEL (dBuV)	LIMIT (dBuV/m)	MARGIN (dB)	ANTENNA FACTOR (dB /m)	CABLE LOSS (dB)	PREAMP FACTOR (dB)	ANTENNA HEIGHT (cm)	TABLE ANGLE (Degree)	REMARK
5150	54.08	55.07	74	-19.92	34.6	9.92	45.51	100	45	Peak
5150	49.4	50.39	54	-4.6	34.6	9.92	45.51	100	45	Average
5310	92.13	93.18	/	/	34.6	9.86	45.51	100	45	Peak
5310	87.16	88.21	/	/	34.6	9.86	45.51	100	45	Average
5350	56.66	57.72	74	-17.34	34.6	9.85	45.51	100	45	Peak
5350	48.37	49.43	54	-5.63	34.6	9.85	45.51	100	45	Average

REMARKS:

- Emission Level = Read Level+ Antenna Factor + Cable Loss- Preamp Factor
Margin value = Emission level – Limit value.
- 5310MHz: Fundamental frequency.



802.11ac (20MHz)

CHANNEL	TX Channel 52	DETECTOR FUNCTION	Peak (PK)
FREQUENCY RANGE	1GHz ~ 40GHz		Average (AV)

ANTENNA POLARITY & TEST DISTANCE: HORIZONTAL AT 3 M

FREQ. (MHz)	EMISSION LEVEL (dBuV/m)	READ LEVEL (dBuV)	LIMIT (dBuV/m)	MARGIN (dB)	ANTENNA FACTOR (dB /m)	CABLE LOSS (dB)	PREAMP FACTOR (dB)	ANTENNA HEIGHT (cm)	TABLE ANGLE (Degree)	REMARK
5150	56.28	57.35	74	-17.72	34.52	9.92	45.51	200	18	Peak
5150	49.83	50.9	54	-4.17	34.52	9.92	45.51	200	18	Average
5260	100.95	101.97	/	/	34.61	9.88	45.51	200	18	Peak
5260	94.37	95.39	/	/	34.61	9.88	45.51	200	18	Average
5350	54.09	55.07	74	-19.91	34.68	9.85	45.51	200	18	Peak
5350	48.7	49.68	54	-5.3	34.68	9.85	45.51	200	18	Average

ANTENNA POLARITY & TEST DISTANCE: VERTICAL AT 3 M

FREQ. (MHz)	EMISSION LEVEL (dBuV/m)	READ LEVEL (dBuV)	LIMIT (dBuV/m)	MARGIN (dB)	ANTENNA FACTOR (dB /m)	CABLE LOSS (dB)	PREAMP FACTOR (dB)	ANTENNA HEIGHT (cm)	TABLE ANGLE (Degree)	REMARK
5150	55.27	56.26	74	-18.73	34.6	9.92	45.51	150	45	Peak
5150	49.71	50.7	54	-4.29	34.6	9.92	45.51	150	45	Average
5260	98.6	99.63	/	/	34.6	9.88	45.51	150	45	Peak
5260	92.22	93.25	/	/	34.6	9.88	45.51	150	45	Average
5350	53.07	54.13	74	-20.93	34.6	9.85	45.51	150	45	Peak
5350	47.41	48.47	54	-6.59	34.6	9.85	45.51	150	45	Average

REMARKS:

- Emission Level = Read Level+ Antenna Factor + Cable Loss- Preamp Factor
Margin value = Emission level – Limit value.
- 5260MHz: Fundamental frequency.



CHANNEL	TX Channel 60	DETECTOR FUNCTION	Peak (PK)
FREQUENCY RANGE	1GHz ~ 40GHz		Average (AV)

ANTENNA POLARITY & TEST DISTANCE: HORIZONTAL AT 3 M

FREQ. (MHz)	EMISSION LEVEL (dBuV/m)	READ LEVEL (dBuV)	LIMIT (dBuV/m)	MARGIN (dB)	ANTENNA FACTOR (dB /m)	CABLE LOSS (dB)	PREAMP FACTOR (dB)	ANTENNA HEIGHT (cm)	TABLE ANGLE (Degree)	REMARK
5150	54.86	55.93	74	-19.14	34.52	9.92	45.51	200	18	Peak
5150	49.78	50.85	54	-4.22	34.52	9.92	45.51	200	18	Average
5300	98.94	99.94	/	/	34.64	9.87	45.51	200	18	Peak
5300	92.52	93.52	/	/	34.64	9.87	45.51	200	18	Average
5350	53.74	54.72	74	-20.26	34.68	9.85	45.51	200	18	Peak
5350	48.13	49.11	54	-5.87	34.68	9.85	45.51	200	18	Average

ANTENNA POLARITY & TEST DISTANCE: VERTICAL AT 3 M

FREQ. (MHz)	EMISSION LEVEL (dBuV/m)	READ LEVEL (dBuV)	LIMIT (dBuV/m)	MARGIN (dB)	ANTENNA FACTOR (dB /m)	CABLE LOSS (dB)	PREAMP FACTOR (dB)	ANTENNA HEIGHT (cm)	TABLE ANGLE (Degree)	REMARK
5150	57.67	58.66	74	-16.33	34.6	9.92	45.51	150	45	Peak
5150	49.26	50.25	54	-4.74	34.6	9.92	45.51	150	45	Average
5300	97.66	98.7	/	/	34.6	9.87	45.51	150	45	Peak
5300	91.28	92.32	/	/	34.6	9.87	45.51	150	45	Average
5350	54.21	55.27	74	-19.79	34.6	9.85	45.51	150	45	Peak
5350	47.98	49.04	54	-6.02	34.6	9.85	45.51	150	45	Average

REMARKS:

- Emission Level = Read Level+ Antenna Factor + Cable Loss- Preamp Factor
Margin value = Emission level – Limit value.
- 5300MHz: Fundamental frequency.



CHANNEL	TX Channel 64	DETECTOR FUNCTION	Peak (PK)
FREQUENCY RANGE	1GHz ~ 40GHz		Average (AV)

ANTENNA POLARITY & TEST DISTANCE: HORIZONTAL AT 3 M

FREQ. (MHz)	EMISSION LEVEL (dBuV/m)	READ LEVEL (dBuV)	LIMIT (dBuV/m)	MARGIN (dB)	ANTENNA FACTOR (dB /m)	CABLE LOSS (dB)	PREAMP FACTOR (dB)	ANTENNA HEIGHT (cm)	TABLE ANGLE (Degree)	REMARK
5150	56.58	57.65	74	-17.42	34.52	9.92	45.51	200	18	Peak
5150	49.51	50.58	54	-4.49	34.52	9.92	45.51	200	18	Average
5320	97.58	98.57	/	/	34.66	9.86	45.51	200	18	Peak
5320	91.32	92.31	/	/	34.66	9.86	45.51	200	18	Average
5350	53.4	54.38	74	-20.6	34.68	9.85	45.51	200	18	Peak
5350	48.93	49.91	54	-5.07	34.68	9.85	45.51	200	18	Average

ANTENNA POLARITY & TEST DISTANCE: VERTICAL AT 3 M

FREQ. (MHz)	EMISSION LEVEL (dBuV/m)	READ LEVEL (dBuV)	LIMIT (dBuV/m)	MARGIN (dB)	ANTENNA FACTOR (dB /m)	CABLE LOSS (dB)	PREAMP FACTOR (dB)	ANTENNA HEIGHT (cm)	TABLE ANGLE (Degree)	REMARK
5150	55.12	56.11	74	-18.88	34.6	9.92	45.51	150	45	Peak
5150	49.85	50.84	54	-4.15	34.6	9.92	45.51	150	45	Average
5320	96.55	97.6	/	/	34.6	9.86	45.51	150	45	Peak
5320	90.59	91.64	/	/	34.6	9.86	45.51	150	45	Average
5350	56	57.06	74	-18	34.6	9.85	45.51	150	45	Peak
5350	47.91	48.97	54	-6.09	34.6	9.85	45.51	150	45	Average

REMARKS:

- Emission Level = Read Level+ Antenna Factor + Cable Loss- Preamp Factor
Margin value = Emission level – Limit value.
- 5320MHz: Fundamental frequency.



802.11ac (40MHz)

CHANNEL	TX Channel 54	DETECTOR FUNCTION	Peak (PK)
FREQUENCY RANGE	1GHz ~ 40GHz		Average (AV)

ANTENNA POLARITY & TEST DISTANCE: HORIZONTAL AT 3 M

FREQ. (MHz)	EMISSION LEVEL (dBuV/m)	READ LEVEL (dBuV)	LIMIT (dBuV/m)	MARGIN (dB)	ANTENNA FACTOR (dB /m)	CABLE LOSS (dB)	PREAMP FACTOR (dB)	ANTENNA HEIGHT (cm)	TABLE ANGLE (Degree)	REMARK
5150	55.43	56.5	74	-18.57	34.52	9.92	45.51	200	18	Peak
5150	49.49	50.56	54	-4.51	34.52	9.92	45.51	200	18	Average
5270	96.21	97.22	/	/	34.62	9.88	45.51	200	18	Peak
5270	91.46	92.47	/	/	34.62	9.88	45.51	200	18	Average
5350	54.7	55.68	74	-19.3	34.68	9.85	45.51	200	18	Peak
5350	48.48	49.46	54	-5.52	34.68	9.85	45.51	200	18	Average

ANTENNA POLARITY & TEST DISTANCE: VERTICAL AT 3 M

FREQ. (MHz)	EMISSION LEVEL (dBuV/m)	READ LEVEL (dBuV)	LIMIT (dBuV/m)	MARGIN (dB)	ANTENNA FACTOR (dB /m)	CABLE LOSS (dB)	PREAMP FACTOR (dB)	ANTENNA HEIGHT (cm)	TABLE ANGLE (Degree)	REMARK
5150	54.85	55.84	74	-19.15	34.6	9.92	45.51	150	45	Peak
5150	49.76	50.75	54	-4.24	34.6	9.92	45.51	150	45	Average
5270	93.53	94.56	/	/	34.6	9.88	45.51	150	45	Peak
5270	88.48	89.51	/	/	34.6	9.88	45.51	150	45	Average
5350	53.46	54.52	74	-20.54	34.6	9.85	45.51	150	45	Peak
5350	48.56	49.62	54	-5.44	34.6	9.85	45.51	150	45	Average

REMARKS:

- Emission Level = Read Level+ Antenna Factor + Cable Loss- Preamp Factor
Margin value = Emission level – Limit value.
- 5270MHz: Fundamental frequency.



CHANNEL	TX Channel 62	DETECTOR FUNCTION	Peak (PK)
FREQUENCY RANGE	1GHz ~ 40GHz		Average (AV)

ANTENNA POLARITY & TEST DISTANCE: HORIZONTAL AT 3 M

FREQ. (MHz)	EMISSION LEVEL (dBuV/m)	READ LEVEL (dBuV)	LIMIT (dBuV/m)	MARGIN (dB)	ANTENNA FACTOR (dB /m)	CABLE LOSS (dB)	PREAMP FACTOR (dB)	ANTENNA HEIGHT (cm)	TABLE ANGLE (Degree)	REMARK
5150	54.22	55.29	74	-19.78	34.52	9.92	45.51	200	18	Peak
5150	49.54	50.61	54	-4.46	34.52	9.92	45.51	200	18	Average
5310	94.6	95.6	/	/	34.65	9.86	45.51	200	18	Peak
5310	89.87	90.87	/	/	34.65	9.86	45.51	200	18	Average
5350	53.67	54.65	74	-20.33	34.68	9.85	45.51	200	18	Peak
5350	48.71	49.69	54	-5.29	34.68	9.85	45.51	200	18	Average

ANTENNA POLARITY & TEST DISTANCE: VERTICAL AT 3 M

FREQ. (MHz)	EMISSION LEVEL (dBuV/m)	READ LEVEL (dBuV)	LIMIT (dBuV/m)	MARGIN (dB)	ANTENNA FACTOR (dB /m)	CABLE LOSS (dB)	PREAMP FACTOR (dB)	ANTENNA HEIGHT (cm)	TABLE ANGLE (Degree)	REMARK
5150	54.95	55.94	74	-19.05	34.6	9.92	45.51	150	45	Peak
5150	50.06	51.05	54	-3.94	34.6	9.92	45.51	150	45	Average
5310	94.02	95.07	/	/	34.6	9.86	45.51	150	45	Peak
5310	88.52	89.57	/	/	34.6	9.86	45.51	150	45	Average
5350	53.33	54.39	74	-20.67	34.6	9.85	45.51	150	45	Peak
5350	49.29	50.35	54	-4.71	34.6	9.85	45.51	150	45	Average

REMARKS:

- Emission Level = Read Level+ Antenna Factor + Cable Loss- Preamp Factor
Margin value = Emission level – Limit value.
- 5310MHz: Fundamental frequency.



802.11ac (80MHz)

CHANNEL	TX Channel 58	DETECTOR FUNCTION	Peak (PK)
FREQUENCY RANGE	1GHz ~ 40GHz		Average (AV)

ANTENNA POLARITY & TEST DISTANCE: HORIZONTAL AT 3 M

FREQ. (MHz)	EMISSION LEVEL (dBuV/m)	READ LEVEL (dBuV)	LIMIT (dBuV/m)	MARGIN (dB)	ANTENNA FACTOR (dB /m)	CABLE LOSS (dB)	PREAMP FACTOR (dB)	ANTENNA HEIGHT (cm)	TABLE ANGLE (Degree)	REMARK
5150	55.29	56.36	74	-18.71	34.52	9.92	45.51	200	18	Peak
5150	49.68	50.75	54	-4.32	34.52	9.92	45.51	200	18	Average
5290	93.31	94.32	/	/	34.63	9.87	45.51	200	18	Peak
5290	88.52	89.53	/	/	34.63	9.87	45.51	200	18	Average
5350	55.08	56.06	74	-18.92	34.68	9.85	45.51	200	18	Peak
5350	49.16	50.14	54	-4.84	34.68	9.85	45.51	200	18	Average

ANTENNA POLARITY & TEST DISTANCE: VERTICAL AT 3 M

FREQ. (MHz)	EMISSION LEVEL (dBuV/m)	READ LEVEL (dBuV)	LIMIT (dBuV/m)	MARGIN (dB)	ANTENNA FACTOR (dB /m)	CABLE LOSS (dB)	PREAMP FACTOR (dB)	ANTENNA HEIGHT (cm)	TABLE ANGLE (Degree)	REMARK
5150	56.41	57.4	74	-17.59	34.6	9.92	45.51	150	45	Peak
5150	49.63	50.62	54	-4.37	34.6	9.92	45.51	150	45	Average
5290	91.61	92.65	/	/	34.6	9.87	45.51	150	45	Peak
5290	86.2	87.24	/	/	34.6	9.87	45.51	150	45	Average
5350	53.28	54.34	74	-20.72	34.6	9.85	45.51	150	45	Peak
5350	49.51	50.57	54	-4.49	34.6	9.85	45.51	150	45	Average

REMARKS:

- Emission Level = Read Level+ Antenna Factor + Cable Loss- Preamp Factor
Margin value = Emission level – Limit value.
- 5290MHz: Fundamental frequency.



802.11ac (40MHz)

Worst case harmonic:

CHANNEL	TX Channel 62	DETECTOR FUNCTION	Peak (PK)
FREQUENCY RANGE	1GHz ~ 40GHz		Average (AV)

ANTENNA POLARITY & TEST DISTANCE: HORIZONTAL AT 3 M

	Freq	Level	Read Level	Limit Line	Over Limit	Factor	Remark	Pol/Phase
	MHz	dBuV/m	dBuV	dBuV/m	dB	dB/m		
1	10620.000	51.64	41.65	74.00	-22.36	9.99	Peak	Horizontal
2	10620.000	43.20	33.21	54.00	-10.80	9.99	Average	Horizontal
3	PK15926.000	55.37	38.53	74.00	-18.63	16.84	Peak	Horizontal
4	PP15926.000	47.39	30.55	54.00	-6.61	16.84	Average	Horizontal

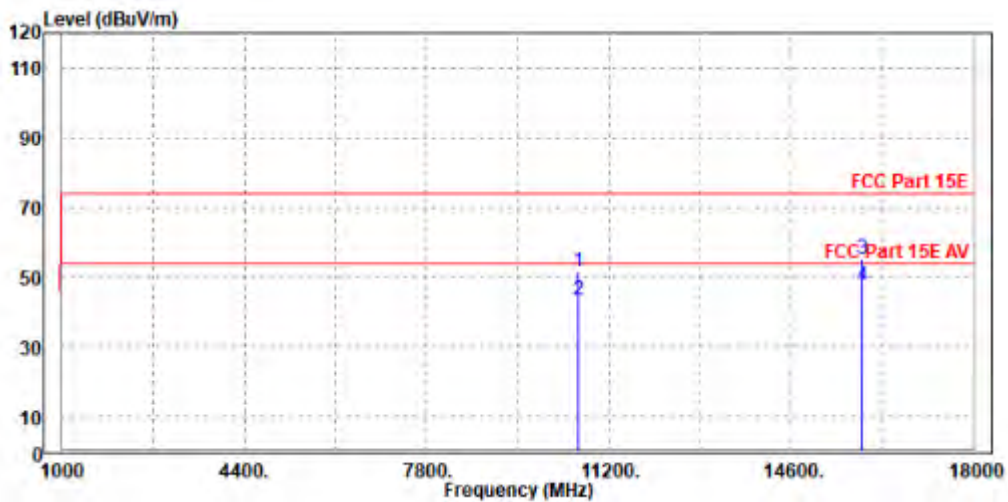



ANTENNA POLARITY & TEST DISTANCE: VERTICAL AT 3 M

	Freq	Level	Read Level	Limit Line	Over Limit	Factor	Remark	Pol/Phase
	MHz	dBuV/m	dBuV	dBuV/m	dB	dB/m		
1	10622.000	51.09	42.13	74.00	-22.91	8.96	Peak	Vertical
2	10622.000	43.17	34.21	54.00	-10.83	8.96	Average	Vertical
3	PK15930.000	55.12	39.30	74.00	-18.88	15.82	Peak	Vertical
4	PP15930.000	47.37	31.55	54.00	-6.63	15.82	Average	Vertical

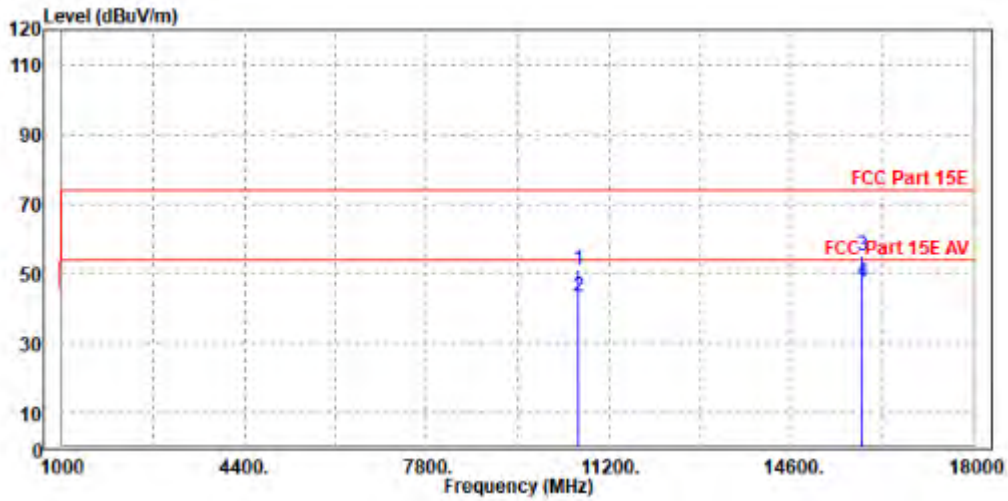

REMARKS:

1. Emission Level = Read Level+ Antenna Factor + Cable Loss- Preamp Factor
Margin value = Emission level – Limit value.
2. 5310MHz: Fundamental frequency.
3. For frequency above 18GHz, the emission was tested 20db below the limit so the data not recorded in the sheet.