

# FCC Radio Test Report

## FCC ID: ZLE-RG650U

This report concerns: **Original Grant**

**Project No.** : 1810C073  
**Equipment** : LTE SMARTPHONE  
**Test Model** : RG650U  
**Series Model** : N/A  
**Applicant** : Power Idea Technology (Shenzhen) Co., Ltd.  
**Address** : 4th Floor, A Section ,Languang Science&technology  
Xinxi RD, Hi-Tech Industrial Park North, Nanshan,  
ShenZhen, China

**Date of Receipt** : Oct. 18, 2018  
**Date of Test** : Dec. 10, 2018 ~ Dec. 27, 2018  
**Issued Date** : Jan. 28, 2019  
**Tested by** : BTL Inc.

**Technical Manager** : David Mao  
(David Mao)

**Authorized Signatory** : Steven Lu  
(Steven Lu)

# **B T L I N C .**

No.3,Jinshagang 1st Road, Shixia,Dalang Town, Dongguan,  
Guangdong, China.

TEL: +86-769-8318-3000 FAX: +86-769-8319-6000



Certificate #5123.02

## Declaration

**BTL** represents to the client that testing is done in accordance with standard procedures as applicable and that test instruments used has been calibrated with standards traceable to international standard(s) and/or national standard(s).

**BTL's** reports apply only to the specific samples tested under conditions. It is manufacture's responsibility to ensure that additional production units of this model are manufactured with the identical electrical and mechanical components. **BTL** shall have no liability for any declarations, inferences or generalizations drawn by the client or others from **BTL** issued reports.

The report must not be used by the client to claim product certification, approval, or endorsement by NVLAP, NIST, A2LA, or any agency of the U.S. Government.

This report is the confidential property of the client. As a mutual protection to the clients, the public and ourselves, the test report shall not be reproduced, except in full, without our written approval.

**BTL's** laboratory quality assurance procedures are in compliance with the **ISO/IEC 17025** requirements, and accredited by the conformity assessment authorities listed in this test report.

**BTL** is not responsible for the sampling stage, so the results only apply to the sample as received.

The information, data and test plan are provided by manufacturer which may affect the validity of results, so it is manufacturer's responsibility to ensure that the apparatus meets the essential requirements of applied standards and in all the possible configurations as representative of its intended use.

## Limitation

For the use of the authority's logo is limited unless the Test Standard(s)/Scope(s)/Item(s) mentioned in this test report is (are) included in the conformity assessment authorities acceptance respective.

Table of Contents	Page
<b>REPORT ISSUED HISTORY</b>	<b>5</b>
<b>1 . GENERAL SUMMARY</b>	<b>6</b>
<b>2 . SUMMARY OF TEST RESULTS</b>	<b>7</b>
2.1 TEST FACILITY	8
2.2 MEASUREMENT UNCERTAINTY	8
<b>3 . GENERAL INFORMATION</b>	<b>9</b>
3.1 GENERAL DESCRIPTION OF EUT	9
3.2 DESCRIPTION OF TEST MODES AND TEST CONDITION	10
3.3 BLOCKDIAGRAMSHOWINGTHECONFIGURATIONOFSYSTEMTESTED FOR RADIATED	12
3.4 DESCRIPTION OF SUPPORT UNITS	12
<b>4 . TEST RESULT</b>	<b>13</b>
4.1 OUTPUT POWER MEASUREMENT	13
4.1.1 LIMIT	13
4.1.2 TEST PROCEDURE	13
4.1.3 TESTSETUP LAYOUT	13
4.1.4 TEST DEVIATION	13
4.1.5 TEST RESULTS	13
4.2 OCCUPIED BANDWIDTH MEASUREMENT	14
4.2.1 TEST PROCEDURE	14
4.2.2 TEST SETUP LAYOUT	14
4.2.3 TEST DEVIATION	14
4.2.4 TEST RESULTS	14
4.3 CONDUCTED EMISSIONS MEASUREMENT	15
4.3.1 LIMIT	15
4.3.2 TEST PROCEDURES	15
4.3.3 TESTSETUP LAYOUT	15
4.3.4 TESTDEVIATION	15
4.3.5 TEST RESULTS	15
4.4 RADIATED EMISSIONS MEASUREMENT	16
4.4.1 LIMIT	16
4.4.2 TEST PROCEDURES	16
4.4.3 TESTSETUP LAYOUT	17
4.4.4 TESTDEVIATION	18
4.4.5 TEST RESULTS (9KHZ TO 30MHZ)	18
4.4.6 TEST RESULTS (30MHZ TO 1000MHZ)	18
4.4.7 TEST RESULTS (ABOVE 1000MHZ)	18

<b>Table of Contents</b>	<b>Page</b>
<b>4.5 BAND EDGE MEASUREMENT</b>	<b>19</b>
4.5.1 LIMIT	19
4.5.2 TEST PROCEDURES	19
4.5.3 TESTSETUP LAYOUT	19
4.5.4 TESTDEVIATION	19
4.5.5 TEST RESULTS	19
<b>4.6 PEAK TO AVERAGE RATIO MEASUREMENT</b>	<b>20</b>
4.6.1 LIMIT	20
4.6.2 TEST PROCEDURES	20
4.6.3 TESTSETUP LAYOUT	20
4.6.4 TESTDEVIATION	20
4.6.5 TEST RESULTS	20
<b>4.7 FREQUENCY STABILITY MEASUREMENT</b>	<b>21</b>
4.7.1 LIMIT	21
4.7.2 TEST PROCEDURES	21
4.7.3 TESTSETUP LAYOUT	21
4.7.4 TESTDEVIATION	21
4.7.5 TEST RESULTS	21
<b>5. LIST OF MEASUREMENT EQUIPMENTS</b>	<b>22</b>
<b>6. EUT TEST PHOTO</b>	<b>24</b>
<b>APPENDIX A - MAXIMUM OUTPUT POWER</b>	<b>27</b>
<b>APPENDIX B - OCCUPIED BANDWIDTH</b>	<b>30</b>
<b>APPENDIX C - CONDUCTED EMISSIONS</b>	<b>36</b>
<b>APPENDIX D - RADIATED EMISSION (9KHZ TO 30MHZ)</b>	<b>41</b>
<b>APPENDIX E - RADIATED EMISSION (30MHZ TO 1GHZ)</b>	<b>46</b>
<b>APPENDIX F - RADIATED EMISSION (ABOVE 1GHZ)</b>	<b>53</b>
<b>APPENDIX G - BAND EDGE</b>	<b>60</b>
<b>APPENDIX H - PEAK TO AVERAGE RATIO</b>	<b>63</b>
<b>APPENDIX G - FREQUENCY STABILITY</b>	<b>68</b>

### REPORT ISSUED HISTORY

Report Version	Description	Issued Date
R00	Original Issue.	Jan. 07, 2019
R01	Changed the FCC ID and applicant information.	Jan. 28, 2019

## 1. GENERAL SUMMARY

Equipment : LTE SMARTPHONE  
Brand Name : RugGear  
Test Model : RG650U  
Series Model : N/A  
Applicant : Power Idea Technology (Shenzhen) Co., Ltd.  
Manufacturer : RUGGEAR LIMITED  
Address : RM1301,13/F WING TUCK COMM CTR 177-183 WING LOK ST SHEUNG  
WAN HONG KONG  
Date of Test : Dec. 10, 2018 ~ Dec. 27, 2018  
Test Sample : Engineering Sample No.: D181211334 for conducted, D181211444 for radiated.  
Standard(s) : 47 CFR FCC Part 22 Subpart H  
47 CFR FCC Part 2  
ANSI/TIA/EIA-603-E-2016  
FCC KDB 971168 D01 Power Meas License Digital Systems v03r01

The above equipment has been tested and found compliance with the requirement of the relative standards by BTL Inc.

The test data, data evaluation, and equipment configuration contained in our test report (Ref No. BTL-FCCP-6-1810C073) were obtained utilizing the test procedures, test instruments, test sites that has been accredited by the Authority of A2LA according to the ISO/IEC 17025 quality assessment standard and technical standard(s).

**Test results included in this report are only for the GSM850, WCDMA Band V part.**

## 2. SUMMARY OF TEST RESULTS

Test procedures according to the technical standard(s):

FCC Part 22 Subpart H & Part 2			
Standard(s) Section	Test Item	Judgment	Tested By
2.1046 22.913(a)	Radiated power	PASS	Paul Li
2.1046 22.913(a)	Maximum Output Power	PASS	Paul Li
2.1049(h) 22.917(a)	Occupied Bandwidth	PASS	Paul Li
2.1051 22.917(a)	Conducted Spurious Emissions	PASS	Paul Li
2.1053 22.917(a)	Radiated Spurious Emissions	PASS	Paul Li
22.917(a)	Band Edge Measurements	PASS	Paul Li
-	Peak To Average Ratio	PASS	Paul Li
2.1055 22.355	Frequency Stability	PASS	Paul Li

## 2.1 TEST FACILITY

The test facilities used to collect the test data in this report is at the location of No.3, Jinshagang 1st Road, Shixia, Dalang Town, Dongguan, Guangdong, China.

BTL's Test Firm Registration Number for FCC: 357015

BTL's Designation Number for FCC: CN1240

## 2.2 MEASUREMENT UNCERTAINTY

The measurement uncertainty figures shall be calculated according the methods described in the ETSI TR 100 028 and shall correspond to an expansion factor (coverage factor)  $k=1.96$  or  $k=2$ (which provide confidence levels of respectively 90% and 95.45% in the case where the distributions characterizing the actual measurement uncertainties are normal (Gaussian)).

Measurement Uncertainty for a Level of Confidence of 95 %,  $U=2xUc(y)$ .

The BTL measurement uncertainty as below table:

### A. Radiated Measurement :

Test Site	Method	Measurement Frequency Range	Ant. H / V	U,(dB)
DG-CB03	CISPR	9KHz ~ 30MHz	V	3.79
		9KHz ~ 30MHz	H	3.57
		30MHz ~ 200MHz	V	3.82
		30MHz ~ 200MHz	H	3.78
		200MHz ~ 1,000MHz	V	4.10
		200MHz ~ 1,000MHz	H	4.06

Test Site	Method	Measurement Frequency Range	Ant. H / V	U,(dB)
DG-CB03	CISPR	1GHz ~ 18GHz	V	3.12
		1GHz ~ 18GHz	H	3.68

Note: Unless specifically mentioned, the uncertainty of measurement has not been taken into account to declare the compliance or non-compliance to the specification.



### 3. GENERAL INFORMATION

#### 3.1 GENERAL DESCRIPTION OF EUT

Equipment	LTE SMARTPHONE			
Brand Name	RugGear			
Test Model	RG650U			
Series Model	N/A			
Model Difference(s)	N/A			
Hardware Version	V1.0			
Software Version	RG650_US_1.0.0.0.0_1			
Antenna Type	Internal Antenna			
Antenna Gain	GSM850	-1.5 dBi		
	WCDMA V	-1.5 dBi		
IMEI No.	Conducted	860624040000503		
	Radiated	860624040000529		
Modulation Type	GSM/GPRS		GMSK	
	EDGE		GMSK, 8PSK	
	WCDMA		UL: BPSK DL: QPSK	
	WCDMA(HSDPA/HSUPA)		16QAM	
Operation Frequency	GSM /EDGE/GPRS		824.2MHz ~ 848.8MHz	
	WCDMA Band V		826.4MHz ~ 846.6MHz	
Max. ERP Power	GSM/GPRS	GMSK	28.29	dBm
	EDGE	8PSK	23.50	dBm
	WCDMA	BPSK	18.69	dBm
	WCDMA_HSDPA	16QAM	17.77	dBm
	WCDMA_HSUPA	16QAM	16.88	dBm
Power Source	1# DC voltage supplied from AC/DC adapter. Manufacturer / Model: Shenzhen Huntkey Electric co.,Ltd / HKC0055010-2D 2# Supplied from Li-Polymer battery. Manufacturer / Model: SHENZHEN JIAYUANTONGDA TECHNOLOGY CO.,LTD. / BL420KP 3# Supplied from USB port.			
Power Rating	1# I/P: 100-240V~ 50-60Hz 0.2A O/P: 5V --- 1.0A 2# DC 3.80V/4200mAh (15.96Wh) 3# DC 5V			

**Note:**

1. For a more detailed features description, please refer to the manufacturer's specifications or the user's manual.

### 3.2 DESCRIPTION OF TEST MODES AND TEST CONDITION

Pre-Scan has been conducted to determine the worst-case mode from all possible combinations between available modulations, data rates, XYZ axis and antenna ports  
 The worst case was found when positioned on X-plane for EIRP and X-axis for radiated emission.  
 Following channel(s) was (were) selected for the final test as listed below:

GSM MODE			
Test Item	Available Channel	Tested Channel	Mode
ERP	128 to 251	128, 190, 251	GSM, EDGE
Maximum Output Power	128 to 251	128, 190, 251	GSM, EDGE
Occupied Bandwidth	128 to 251	128, 190, 251	GSM, EDGE
Conducuted Emission	128 to 251	190	GSM, EDGE
Radiated Emission	128 to 251	190	GSM, EDGE
Band Edge	128 to 251	128, 251	GSM, EDGE
Peak to Average Ratio	128 to 251	128, 190, 251	GSM, EDGE
Frequency Stability	128 to 251	190	GSM

WCDMA MODE			
Test Item	Available Channel	Tested Channel	Mode
ERP	4132 to 4233	4132, 4182, 4233	WCDMA, HSDPA, HSUPA
Maximum Output Power	4132 to 4233	4132, 4182, 4233	WCDMA, HSDPA, HSUPA
Conducted Emission	4132 to 4233	4182	WCDMA, HSDPA, HSUPA
Radiated Emission	4132 to 4233	4182	WCDMA
Band Edge	4132 to 4233	4132, 4233	WCDMA, HSDPA, HSUPA
Peak to Average Ratio	4132 to 4233	4132, 4182, 4233	WCDMA, HSDPA, HSUPA
Frequency Stability	4132 to 4233	4182	WCDMA

**EUT TEST CONDITIONS:**

Test Item	Environmental Conditions	Test Voltage
ERP	21°C, 50%RH	DC 3.80V
Maximum Output Power	21°C, 50%RH	DC 3.80V
Occupied Bandwidth	21°C, 50%RH	DC 3.80V
Conducted Emission	21°C, 50%RH	DC 3.80V
Radiated Emission	23°C, 49%RH	AC 120V/60Hz
Band Edge	21°C, 50%RH	DC 3.80V
Peak to Average Ratio	21°C, 50%RH	DC 3.80V
Frequency Stability	Normal and Extreme	Normal and Extreme

**3.3 BLOCKDIGRAMSHOWINGTHECONFIGURATIONOFSYSTEMTESTED FOR RADIATED**

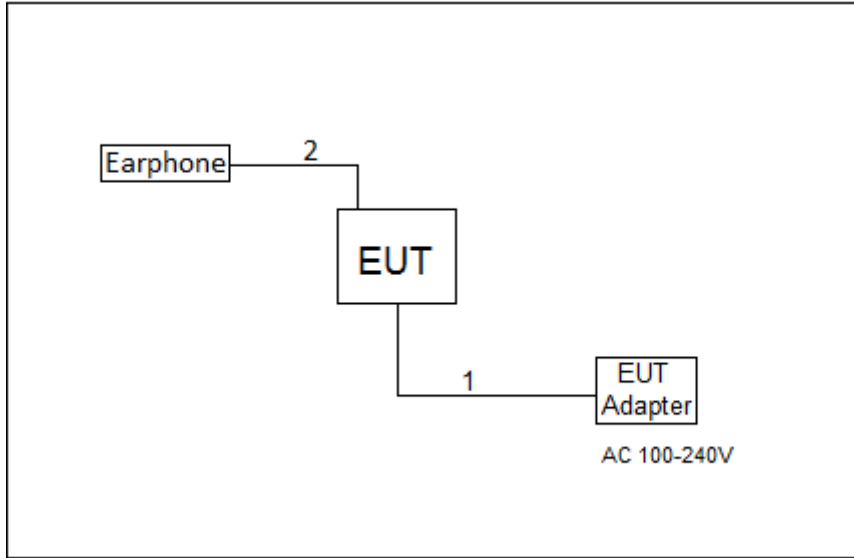

**3.4 DESCRIPTION OF SUPPORT UNITS**

The EUT has been tested as an independent unit together with other necessary accessories or support units. The following support units or accessories were used to form a representative test configuration during the tests.

Item	Equipment	Mfr/Brand	Model/Type No.	FCC ID	Series No.
-	-	-	-	-	-

Item	Shielded Type	Ferrite Core	Length	Note
1	NO	NO	1.2m	DC Cable
2	NO	NO	1.0m	Audio Cable

## 4. TEST RESULT

### 4.1 OUTPUT POWER MEASUREMENT

#### 4.1.1 LIMIT

Mobile / Portable station are limited to 7 watts e.r.p.

#### 4.1.2 TEST PROCEDURE

##### EIRP/ ERP:

1. EIRP= Output Power +Antenan gain  
ERP power= EIPR power-2.15dBi.

##### Maximum Output Power:

The EUT was set up for the maximum power with GSM, GPRS, EDGE and WCDMA link data modulation and link up with simulator. Set the EUT to transmit under low, middle and high channel and record the power level shown on simulator.

#### 4.1.3 TESTSETUP LAYOUT

##### Output Power Measurement

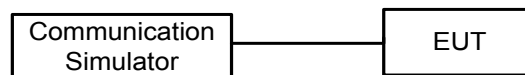

#### 4.1.4 TEST DEVIATION

No deviation

#### 4.1.5 TEST RESULTS

Please refer to the Appendix A.

## 4.2 OCCUPIED BANDWIDTH MEASUREMENT

### 4.2.1 TEST PROCEDURE

The EUT makes a call to the communication simulator. All measurements were done at low, middle and high operational frequency range. The communication simulator station system controlled a EUT to export maximum output power under transmission mode and specific channel frequency. Use OBW measurement function of Spectrum analyzer to measure 99 % occupied bandwidth and 26dB bandwidth.

### 4.2.2 TEST SETUP LAYOUT

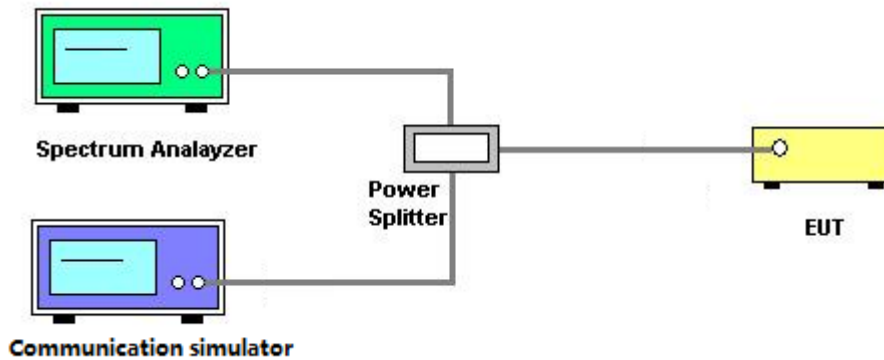

### 4.2.3 TEST DEVIATION

No deviation

### 4.2.4 TEST RESULTS

Please refer to the Appendix B.

### 4.3 CONDUCTED EMISSIONS MEASUREMENT

#### 4.3.1 LIMIT

The power of any emission outside of the authorized operating frequency ranges must be attenuated below the transmitting power (P) by a factor of at least  $43 + 10 \log(P)$  dB. The emission limit equal to  $-13\text{dBm}$ .

#### 4.3.2 TEST PROCEDURES

1. The testing follows FCC KDB 971168 v03r01 Section 6.0.
2. The EUT was connected to spectrum analyzer and system simulator via a power divider.
3. The band edges of low and high channels for the highest RF powers were measured. Set  $\text{RBW} \geq 1\%$  EBW in the 1MHz band immediately outside and adjacent to the band edge.
4. Set spectrum analyzer with RMS detector.
5. The RF fundamental frequency should be excluded against the limit line in the operating frequency band.
6. The limit line is derived from  $43+10\log(P)\text{dB}$  below the transmitter power P(Watts)
 
$$= P(\text{W}) - [43 + 10\log(P)](\text{dB})$$

$$= [30 + 10\log(P)](\text{dBm}) - [43 + 10\log(P)](\text{dB})$$

$$= -13\text{dBm}$$

#### 4.3.3 TESTSETUP LAYOUT

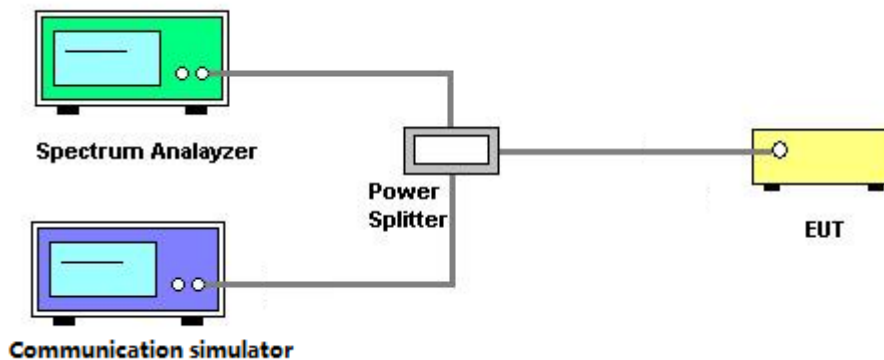

#### 4.3.4 TESTDEVIATION

No deviation

#### 4.3.5 TEST RESULTS

Please refer to the Appendix C.

## 4.4 RADIATED EMISSIONS MEASUREMENT

### 4.4.1 LIMIT

The power of any emission outside of the authorized operating frequency ranges must be attenuated below the transmitting power (P) by a factor of at least  $43 + 10 \log(P)$  dB. The emission limit equal to -13dBm.

### 4.4.2 TEST PROCEDURES

1. Substitution method is used for E.I.R.P measurement. In the semi-anechoic chamber, EUT placed on the 0.8m height of Turn Table, rotated the table around 360 degrees to search the maximum radiation power and receiver antenna shall be rotated vertical and horizontal polarization and moved height from 1m to 4m to find the maximum polar radiated power. The "Read Value" is the spectrum reading the maximum power value.
2. The substitution horn antenna is substituted for EUT at the same position and signals generator export the CW signal to the substitution antenna via a TX cable. Rotated the Turn Table and moved receiving antenna to find the maximum radiation power. Adjust output power level of S.G to get a Value of spectrum reading equal to "Read Value " of step a. Record the power level of S.G
3. EIRP = Output power level of S.G – TX cable loss + Antenna gain of substitution horn.
4. E.R.P power can be calculated form E.I.R.P power by subtracting the gain of dipole, E.R.P power = E.I.P.R power - 2.15dBi.
5. The resolution bandwidth and video bandwidth of test receiver/spectrum analyzer is 1MHz/3MHz.



**4.4.3 TESTSETUP LAYOUT**

**Below 30MHz**

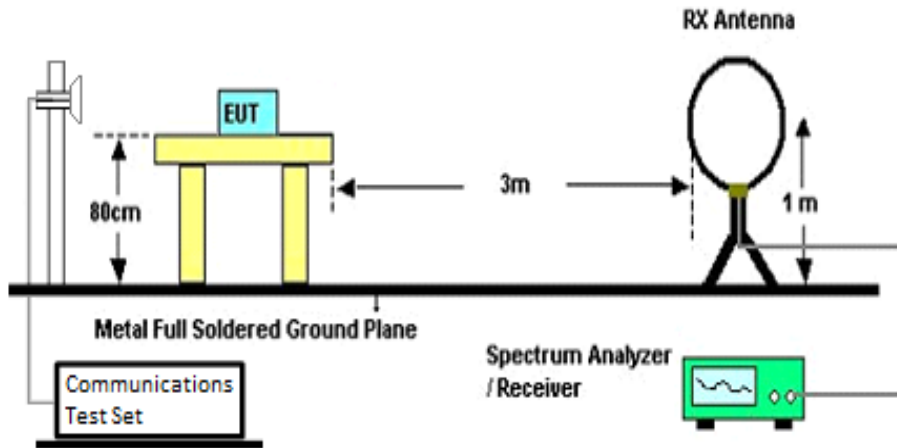

**30MHz to 1GHz**

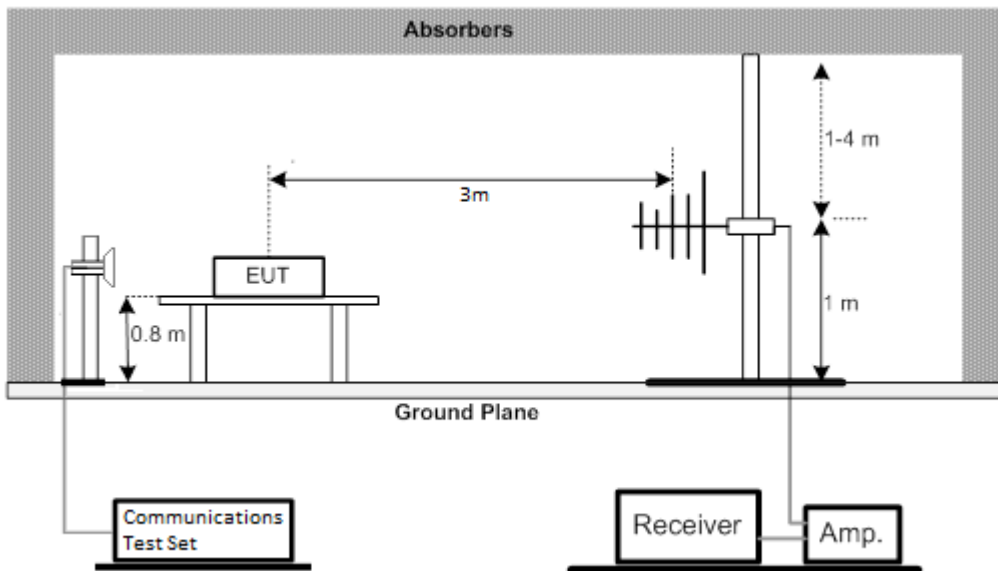

### Above 1GHz

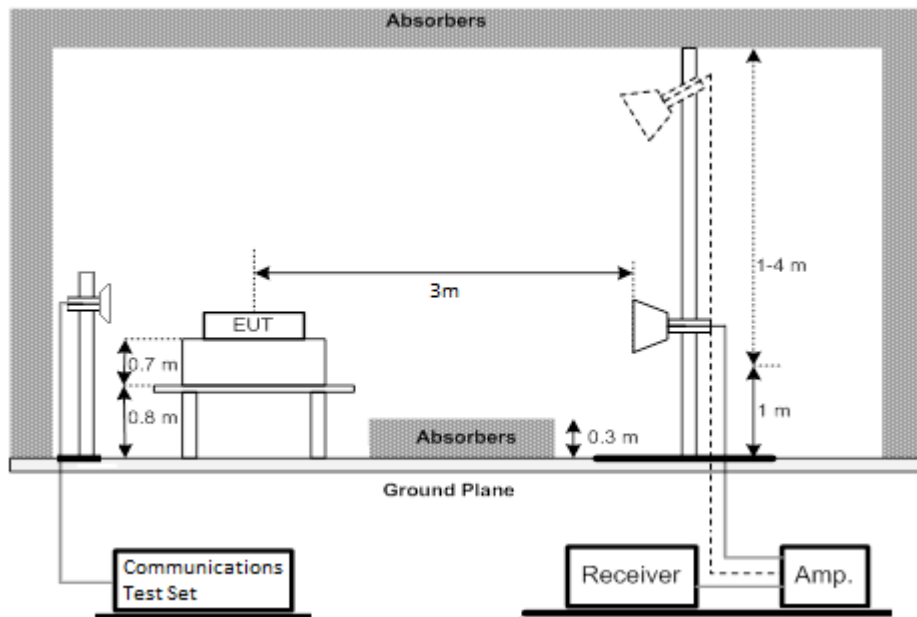

#### 4.4.4 TEST DEVIATION

No deviation

#### 4.4.5 TEST RESULTS (9KHZ TO 30MHZ)

Please refer to the Appendix D.

#### 4.4.6 TEST RESULTS (30MHZ TO 1000MHZ)

Please refer to the Appendix E.

#### 4.4.7 TEST RESULTS (ABOVE 1000MHZ)

Please refer to the Appendix F.

## 4.5 BAND EDGE MEASUREMENT

### 4.5.1 LIMIT

A Power of any emission outside of the authorized operating frequency ranges must be attenuated below the transmitting power (P) by a factor of at least  $43 + 10 \log(P)$  dB. In the 1 MHz bands immediately outside and adjacent to the frequency block a resolution bandwidth of at least one percent of the emission bandwidth of the fundamental emission of the transmitter may be employed.

### 4.5.2 TEST PROCEDURES

1. All measurements were done at low and high operational frequency range.
2. The center frequency of spectrum is the band edge frequency and span is 1.5MHz. RB of the spectrum is 3kHz and VB of the spectrum is 10kHz (GSM/GPRS/EDGE).
3. The center frequency of spectrum is the band edge frequency and span is 10MHz. RB of the spectrum is 100kHz and VB of the spectrum is 300kHz (WCDMA).
4. Record the max trace plot into the test report.

### 4.5.3 TESTSETUP LAYOUT

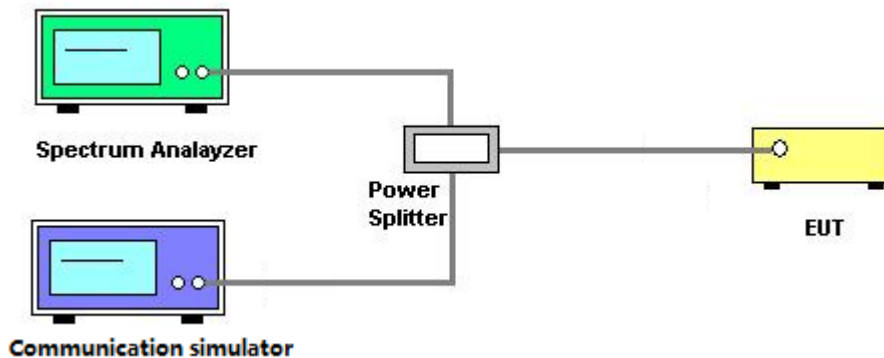

### 4.5.4 TESTDEVIATION

No deviation

### 4.5.5 TEST RESULTS

Please refer to the Appendix G.

## 4.6 PEAK TO AVERAGE RATIO MEASUREMENT

### 4.6.1 LIMIT

In measuring transmissions in this band using an average power technique, the peak to-average ratio (PAR) of the transmission may not exceed 13 dB.

### 4.6.2 TEST PROCEDURES

1. Set resolution/measurement bandwidth  $\geq$  signal's occupied bandwidth;
2. Set the number of counts to a value that stabilizes the measured CCDF curve;
3. Record the maximum PAPR level associated with a probability of 0.1%.

### 4.6.3 TESTSETUP LAYOUT

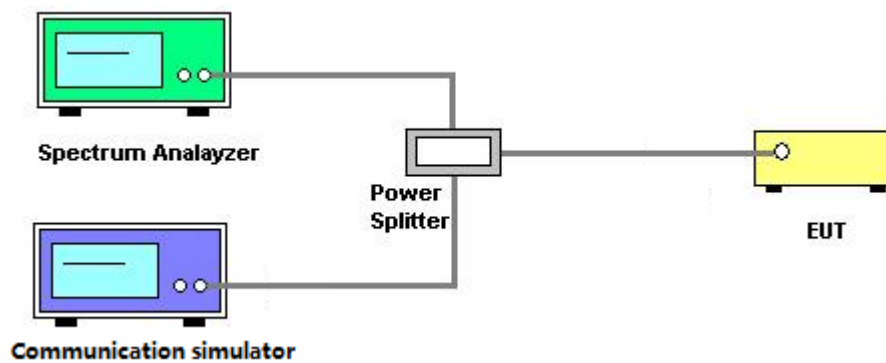

### 4.6.4 TESTDEVIATION

No deviation

### 4.6.5 TEST RESULTS

Please refer to the Appendix H.

## 4.7 FREQUENCY STABILITY MEASUREMENT

### 4.7.1 LIMIT

1.5 ppm is for base and fixed station. 2.5 ppm is for mobile station.

### 4.7.2 TEST PROCEDURES

1. Device is placed at the oven room. The oven room could control the temperatures and humidity. Power warm up is at least 15 min and power applied should perform before recording frequency error.
2. EUT is connected the external power supply to control the DC input power. The test voltage range is from minimum to maximum working voltage. Each step shall be record the frequency error rate.
3. The temperature range step is 10 degrees in this test items. All temperature levels shall be hold the  $\pm 0.5^{\circ}\text{C}$  during the measurement testing. The each temperature step shall be at least 0.5 hours, consider the EUT could be test under the stability condition.
4. The frequency error was recorded frequency error from the communication simulator.

### 4.7.3 TESTSETUP LAYOUT

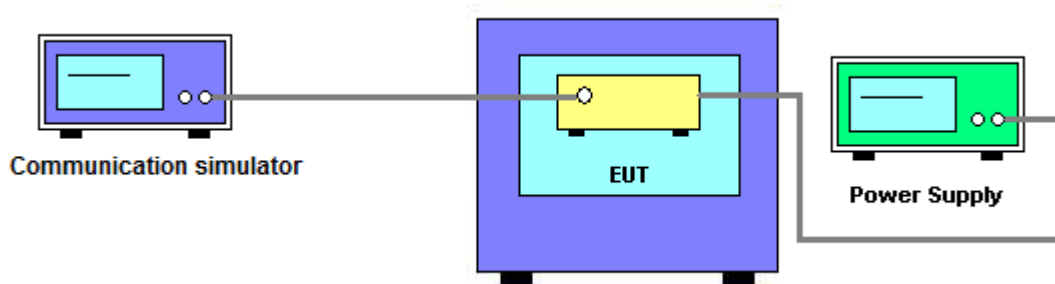

### 4.7.4 TESTDEVIATION

No deviation

### 4.7.5 TEST RESULTS

Please refer to the Appendix I.

## 5. LIST OF MEASUREMENT EQUIPMENTS

Radiated Emission Measurement					
Item	Kind of Equipment	Manufacturer	Type No.	Serial No.	Calibrated until
1	Antenna	Schwarbeck	VULB9160	9160-3232	Mar. 11, 2019
2	Amplifier	Agilent	8449B	3008A02274	Mar. 11, 2019
3	Amplifier	HP	8447D	2944A09673	Aug. 11, 2019
4	HighPass Filter	Wairwright Instruments Gmbh	WHK 1.5/15G-10ST	11	Mar. 11, 2019
5	Band Reject Filter	Wairwright Instruments Gmbh	WRCG 1710/1785-1690/180 5-60/12SS	38	Mar. 11, 2019
6	Band Reject Filter	Wairwright Instruments Gmbh	WRCG 824/849-810/863-60/ 9SS	7	Mar. 11, 2019
7	Band Reject Filter	Wairwright Instruments Gmbh	WRCG 880/915-860/935-60/ 9SS	14	Mar. 11, 2019
8	Band Reject Filter	Wairwright Instruments Gmbh	WRCG 1850/1910-1830/193 0-60/10SS	17	Mar. 11, 2019
9	HighPass Filter	Wairwright Instruments Gmbh	WHK3.1/18G-10SS	24	Mar. 11, 2019
10	Wireless Communication Test SET	Agilent	E5515C	MY48364183	Mar. 11, 2019
11	Microwave Preamplifier With Adaptor	EMC INSTRUMENT	EMC2654045	980039 & HA01	Mar. 11, 2019
12	Receiver	Agilent	N9038A	MY52130039	Aug. 11, 2019
13	wideband radio communication tester	R&S	CMW500	152372	Mar. 11, 2019
14	Cable	emci	LMR-400(30MHz-1G Hz)(8m+5m)	N/A	May 25, 2019
15	Cable	mitron	B10-01-01-12M	18072744	Jul. 30, 2019
16	Controller	ETS-Lindgren	2090	N/A	N/A
17	Measurement Software	Farad	EZ-EMC Ver.NB-03A1-01	N/A	N/A
18	Loop Antenna	EM	EM-6876-1	230	Feb. 07, 2019
19	Double Ridged Guide Antenna	ETS	3115	75789	Mar. 11, 2019
20	Broad-Band Horn Antenna	Schwarzbeck	BBHA 9170	9170319	Jun. 30, 2019

Conducted Emission & Band Edge & Occupied Bandwidth Measurement					
Item	Kind of Equipment	Manufacturer	Type No.	Serial No.	Calibrated until
1	Wireless Communication Test SET	Agilent	E5515C	MY48364183	Mar. 11, 2019
2	EXA Spectrum Analyzer	Agilent	N9010A	MY50520044	Mar. 11, 2019
3	POWER SPLITTER	Mini-Circuits	ZFRSC-123-S+	331000910-1	Mar. 11, 2019
4	wideband radio communication tester	R&S	CMW500	152372	Mar. 11, 2019
5	Spectrum Analyzer	R&S	FSP40	100185	Aug. 11, 2019

Frequency Stability Measurement					
Item	Kind of Equipment	Manufacturer	Type No.	Serial No.	Calibrated until
1	Wireless Communication Test SET	Agilent	E5515C	MY48364183	Mar. 11, 2019
2*	Multi-output DC Power Supply	GW Instek	GPC-3030DN	EK880675	Sep. 26, 2020
3	POWER SPLITTER	Mini-Circuits	ZFRSC-123-S+	331000910-1	Mar. 11, 2019
4	wideband radio communication tester	R&S	CMW500	152372	Mar. 11, 2019

Remark: "N/A" denotes no model name, serial no. or calibration specified.

All calibration period of equipment list is one year.

\*All calibration period of equipment list is three year.

## APPENDIX A - MAXIMUM OUTPUT POWER



**Maximum Output Power (dBm):**

GSM850		Burst Output Power		
		128CH	190CH	251CH
		824.2MHz	836.6MHz	848.8MHz
GSM (CS)		31.82	31.80	31.80
GPRS/EDGE (GMSK)	1 Tx Slot	31.94	31.93	31.92
	2 Tx Slot	31.12	31.13	31.14
	3 Tx Slot	29.38	29.36	29.35
	4 Tx Slot	28.18	28.21	28.22
EDGE (8PSK)	1 Tx Slot	27.15	26.89	26.84
	2 Tx Slot	26.16	25.91	26.04
	3 Tx Slot	24.38	24.14	24.01
	4 Tx Slot	22.50	22.53	22.74

Modulation	Band	WCDMA V		
	Tx Channel	4132CH	4182CH	4233CH
	Frequency	826.4MHz	836.4MHz	846.6MHz
BPSK	RMC 12.2K	22.14	22.13	22.34
	RMC 64K	22.11	22.21	22.31
	RMC 144K	22.20	22.17	22.32
	RMC 384K	22.19	22.25	22.32
16QAM	HSDPA Subtest-1	21.32	21.35	21.42
	HSDPA Subtest-2	21.25	21.21	21.39
	HSDPA Subtest-3	20.72	20.78	20.94
	HSDPA Subtest-4	20.89	20.81	20.94
16QAM	HSUPA Subtest-1	19.67	19.84	19.74
	HSUPA Subtest-2	19.38	19.42	19.36
	HSUPA Subtest-3	20.51	20.47	20.48
	HSUPA Subtest-4	19.97	19.89	19.94
	HSUPA Subtest-5	20.31	20.41	20.53

**ERP Power (dBm):**

GSM850		ERP Power		
		128CH	190CH	251CH
		824.2MHz	836.6MHz	848.8MHz
GSM (CS)		28.17	28.15	28.15
GPRS/EDGE (GMSK)	1 Tx Slot	28.29	28.28	28.27
	2 Tx Slot	27.47	27.48	27.49
	3 Tx Slot	25.73	25.71	25.70
	4 Tx Slot	24.53	24.56	24.57
EDGE (8PSK)	1 Tx Slot	23.50	23.24	23.19
	2 Tx Slot	22.51	22.26	22.39
	3 Tx Slot	20.73	20.49	20.36
	4 Tx Slot	18.85	18.88	19.09

Modulation	Band	WCDMA V		
	Tx Channel	4132CH	4182CH	4233CH
	Frequency	826.4MHz	836.4MHz	846.6MHz
BPSK	RMC 12.2K	18.49	18.48	18.69
	RMC 64K	18.46	18.56	18.66
	RMC 144K	18.55	18.52	18.67
	RMC 384K	18.54	18.60	18.67
16QAM	HSDPA Subtest-1	17.67	17.70	17.77
	HSDPA Subtest-2	17.60	17.56	17.74
	HSDPA Subtest-3	17.07	17.13	17.29
	HSDPA Subtest-4	17.24	17.16	17.29
16QAM	HSUPA Subtest-1	16.02	16.19	16.09
	HSUPA Subtest-2	15.73	15.77	15.71
	HSUPA Subtest-3	16.86	16.82	16.83
	HSUPA Subtest-4	16.32	16.24	16.29
	HSUPA Subtest-5	16.66	16.76	16.88

## APPENDIX B - OCCUPIED BANDWIDTH

GSM850					
GSM			EDGE		
CS			8PSK		
Channel	Frequency (MHz)	99% Occupied Bandwidth (MHz)	Channel	Frequency (MHz)	99% Occupied Bandwidth (MHz)
128	824.2	0.245	128	824.2	0.255
190	836.6	0.246	190	836.6	0.251
251	848.8	0.246	251	848.8	0.252
Channel	Frequency (MHz)	26dB Bandwidth (MHz)	Channel	Frequency (MHz)	26dB Bandwidth (MHz)
128	824.2	0.313	128	824.2	0.328
190	836.6	0.311	190	836.6	0.323
251	848.8	0.318	251	848.8	0.324

### Spectrum Plot

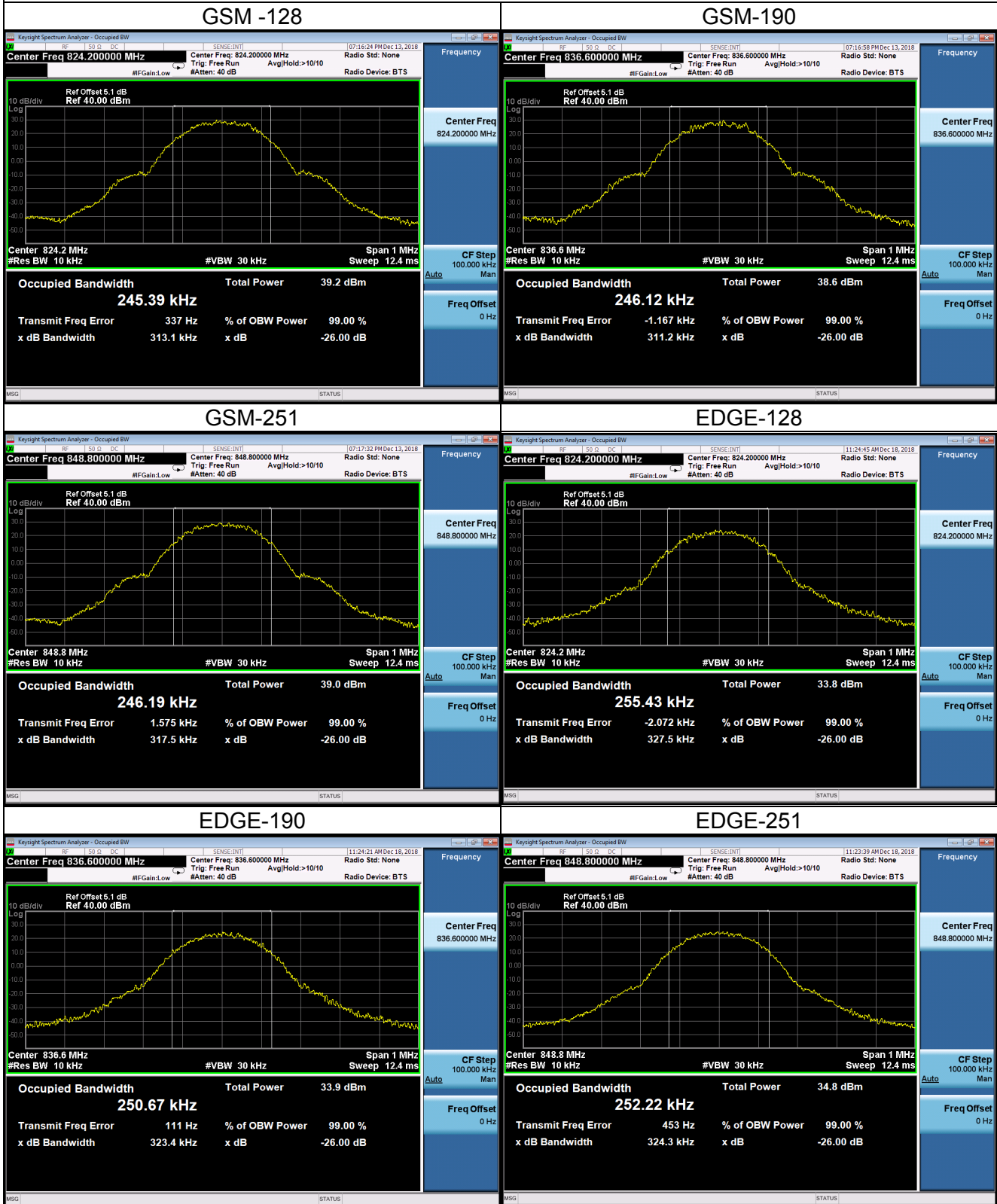

WCDMA Band V					
BPSK					
Channel	Frequency (MHz)	99% Occupied Bandwidth (MHz)	Channel	Frequency (MHz)	26dB Bandwidth (MHz)
4132	826.4	4.185	4132	826.4	4.714
4182	836.4	4.175	4182	836.4	4.702
4233	846.6	4.177	4233	846.6	4.726



WCDMA\_HSDPA Band V

16QAM

Channel	Frequency (MHz)	99% Occupied Bandwidth (MHz)	Channel	Frequency (MHz)	26dB Bandwidth (MHz)
4132	826.4	4.171	4132	826.4	4.706
4182	836.4	4.168	4182	836.4	4.717
4233	846.6	4.175	4233	846.6	4.714

Spectrum Plot

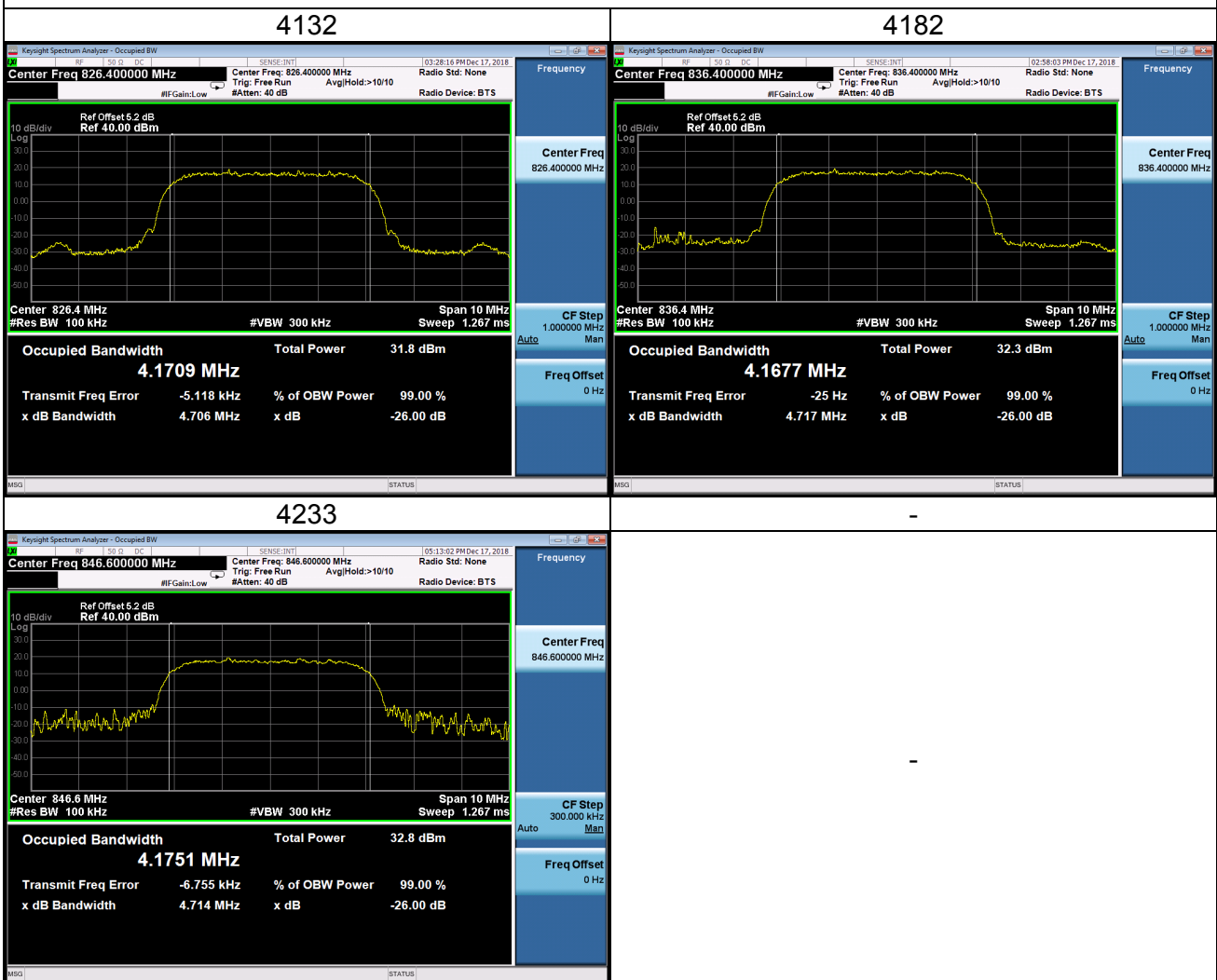

WCDMA\_HSUPA Band V

16QAM

Channel	Frequency (MHz)	99% Occupied Bandwidth (MHz)	Channel	Frequency (MHz)	26dB Bandwidth (MHz)
4132	826.4	4.171	4132	826.4	4.724
4182	836.4	4.173	4182	836.4	4.722
4233	846.6	4.172	4233	846.6	4.720

Spectrum Plot





## APPENDIX C - CONDUCTED EMISSIONS

GSM850			
GSM		GSM	
Channel	Frequency(MHz)	Channel	Frequency(MHz)
190	836.6	190	836.6
GSM		EDGE	
Channel	Frequency(MHz)	Channel	Frequency(MHz)
190	836.6	190	836.6
EDGE		EDGE	
Channel	Frequency(MHz)	Channel	Frequency(MHz)
190	836.6	190	836.6

WCDMA Band V

Channel	Frequency(MHz)	Channel	Frequency(MHz)
4182	836.4	4182	836.4
Channel	Frequency(MHz)	-	-
4182	836.4	-	-
		-	

WCDMA\_HSDPA Band V

Channel	Frequency(MHz)	Channel	Frequency(MHz)
4182	836.4	4182	836.4
Channel	Frequency(MHz)	-	-
4182	836.4	-	-
		-	

WCDMA\_HSUPA Band V

Channel	Frequency(MHz)	Channel	Frequency(MHz)
4182	836.4	4182	836.4
Channel	Frequency(MHz)	-	-
4182	836.4	-	-

## APPENDIX D - RADIATED EMISSION (9KHZ TO 30MHZ)

Test Mode: TX Mode

Ant 0°

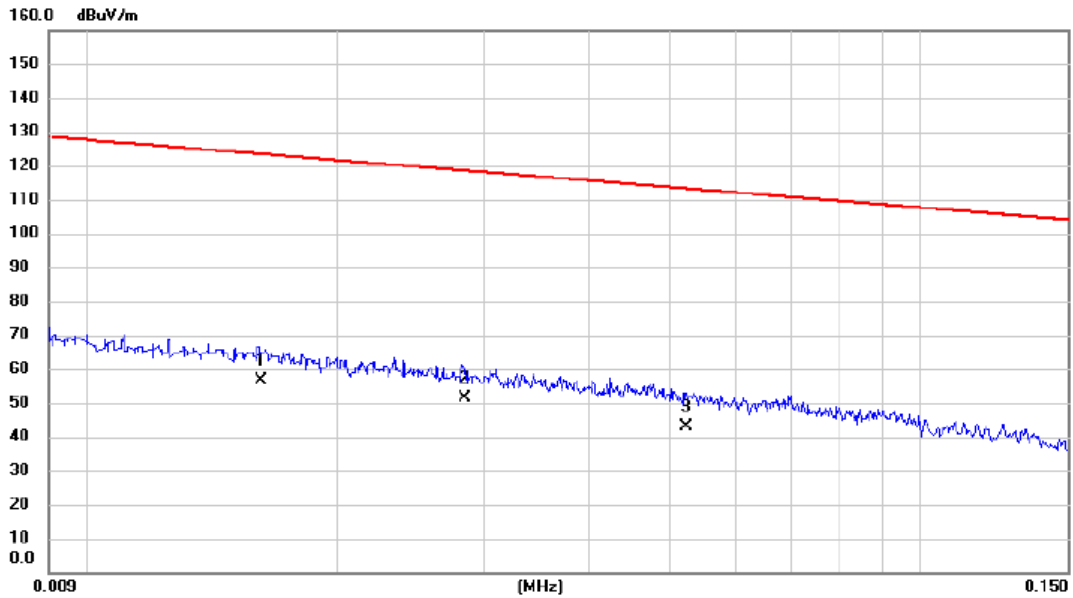

No.	Mk.	Freq. MHz	Reading Level dBuV	Correct Factor dB	Measure- ment dBuV/m	Limit dBuV/m	Margin dB	Detector	Comment
1	*	0.0162	36.20	20.55	56.75	123.41	-66.66	AVG	
2		0.0284	31.60	19.88	51.48	118.54	-67.06	AVG	
3		0.0524	23.70	19.48	43.18	113.22	-70.04	AVG	

Test Mode: TX Mode

Ant 0°

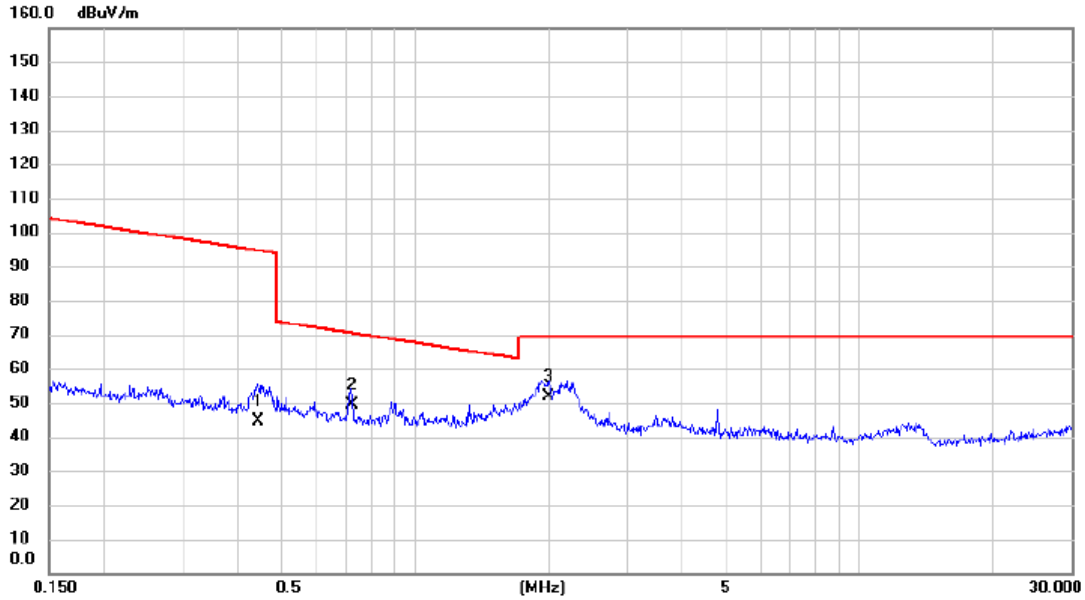

No.	Mk.	Freq. MHz	Reading Level dBuV	Correct Factor dB	Measure- ment dBuV/m	Limit dBuV/m	Margin dB	Detector	Comment
1		0.4421	27.50	16.98	44.48	94.69	-50.21	AVG	
2		0.7198	32.40	16.89	49.29	70.46	-21.17	QP	
3	*	2.0011	34.50	17.12	51.62	69.54	-17.92	QP	



Test Mode: TX Mode

Ant 90°

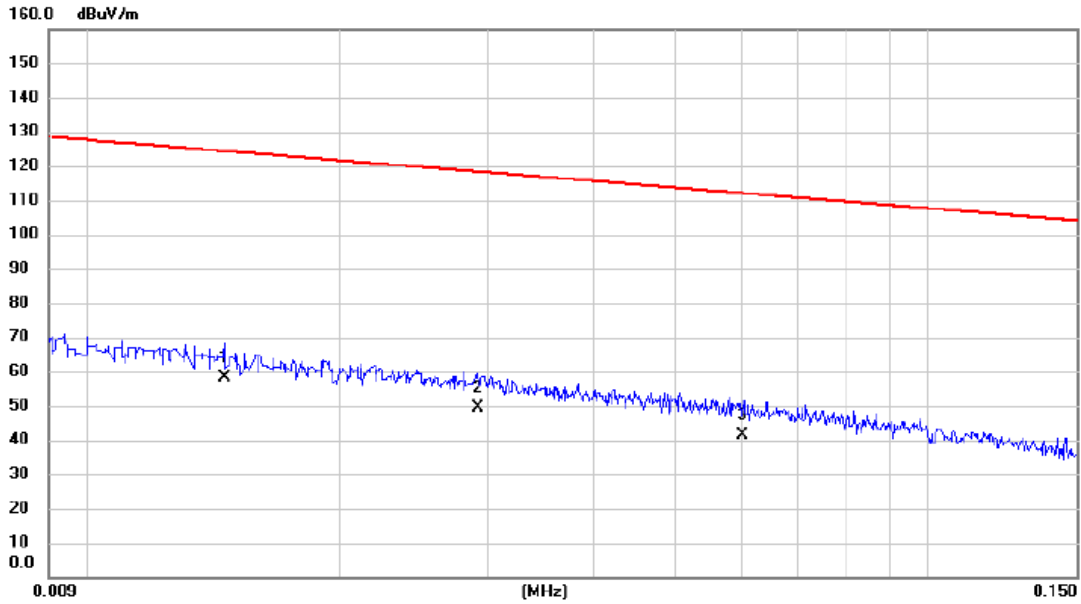

No.	Mk.	Freq. MHz	Reading Level dBuV	Correct Factor dB	Measure- ment dBuV/m	Limit dBuV/m	Margin dB	Detector	Comment
1	*	0.0146	37.60	20.78	58.38	124.32	-65.94	AVG	
2		0.0292	29.40	19.87	49.27	118.30	-69.03	AVG	
3		0.0601	22.20	19.33	41.53	112.03	-70.50	AVG	

Test Mode: TX Mode

Ant 90°

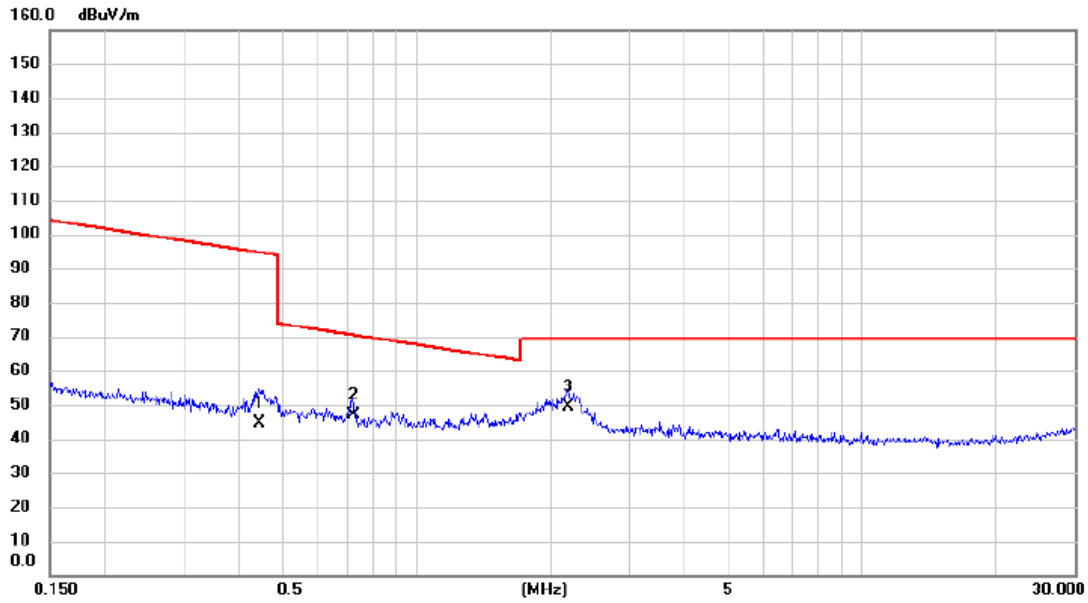

No.	Mk.	Freq. MHz	Reading Level dBuV	Correct Factor dB	Measure- ment dBuV/m	Limit dBuV/m	Margin dB	Detector	Comment
1		0.4421	27.60	16.98	44.58	94.69	-50.11	AVG	
2		0.7198	30.20	16.89	47.09	70.46	-23.37	QP	
3	*	2.1898	32.40	17.01	49.41	69.54	-20.13	QP	

## APPENDIX E - RADIATED EMISSION (30MHZ TO 1GHZ)

Test Mode: GSM850\_TX CH190\_GSM

Vertical

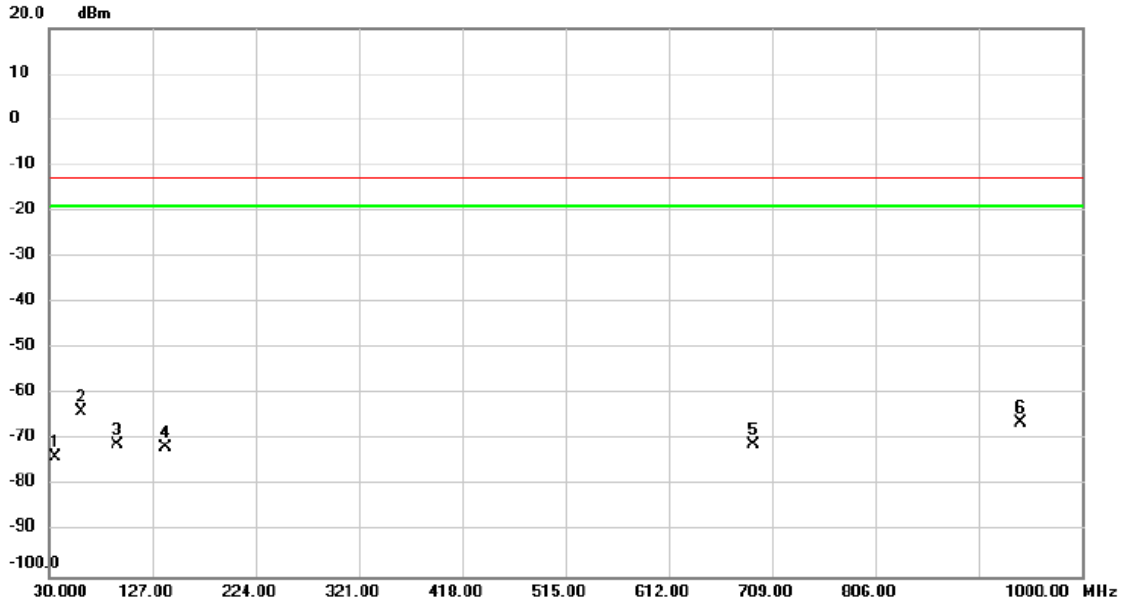

No.	Mk.	Freq. MHz	Reading Level dBm	Correct Factor dB	Measure- ment dBm	Limit dBm	Margin dB	Detector	Comment
1		36.305	-58.93	-14.93	-73.86	-13.00	-60.86	peak	
2	*	60.555	-48.21	-15.78	-63.99	-13.00	-50.99	peak	
3		94.020	-51.95	-19.11	-71.06	-13.00	-58.06	peak	
4		139.125	-59.49	-12.21	-71.70	-13.00	-58.70	peak	
5		691.540	-67.80	-3.16	-70.96	-13.00	-57.96	peak	
6		941.800	-67.19	1.07	-66.12	-13.00	-53.12	peak	

Test Mode: GSM850\_TX CH190\_GSM

### Horizontal

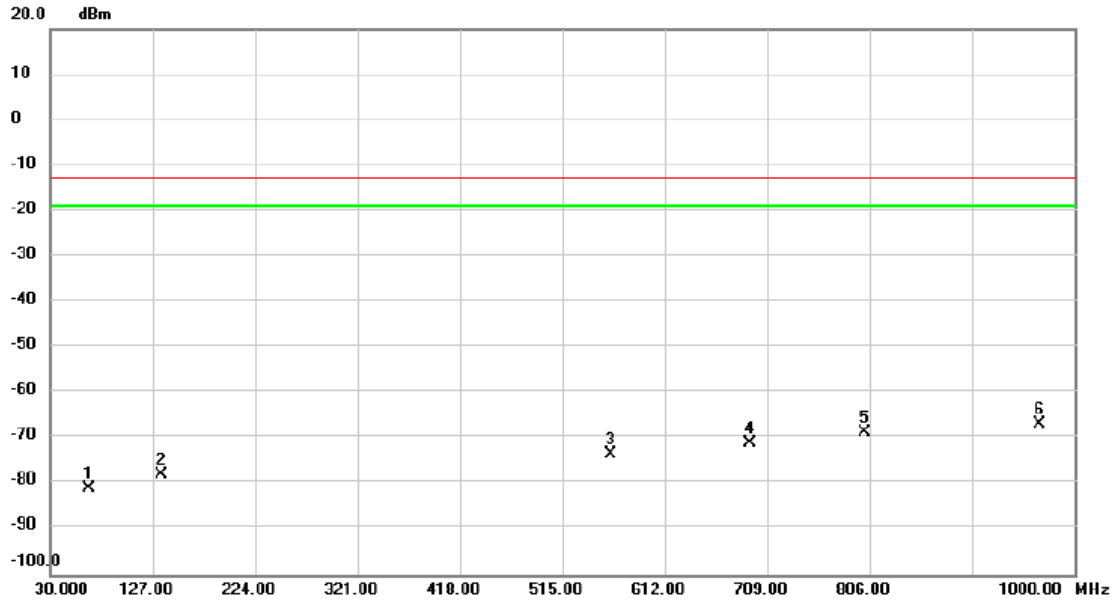

No.	Mk.	Freq. MHz	Reading Level dBm	Correct Factor dB	Measure- ment dBm	Limit dBm	Margin dB	Detector	Comment
1		66.375	-64.14	-16.76	-80.90	-13.00	-67.90	peak	
2		134.760	-65.27	-12.78	-78.05	-13.00	-65.05	peak	
3		560.590	-67.71	-5.65	-73.36	-13.00	-60.36	peak	
4		692.995	-68.02	-3.09	-71.11	-13.00	-58.11	peak	
5		801.150	-67.72	-1.07	-68.79	-13.00	-55.79	peak	
6 *		966.535	-67.89	1.02	-66.87	-13.00	-53.87	peak	

Test Mode: GSM850\_TX CH190\_EDGE

Vertical

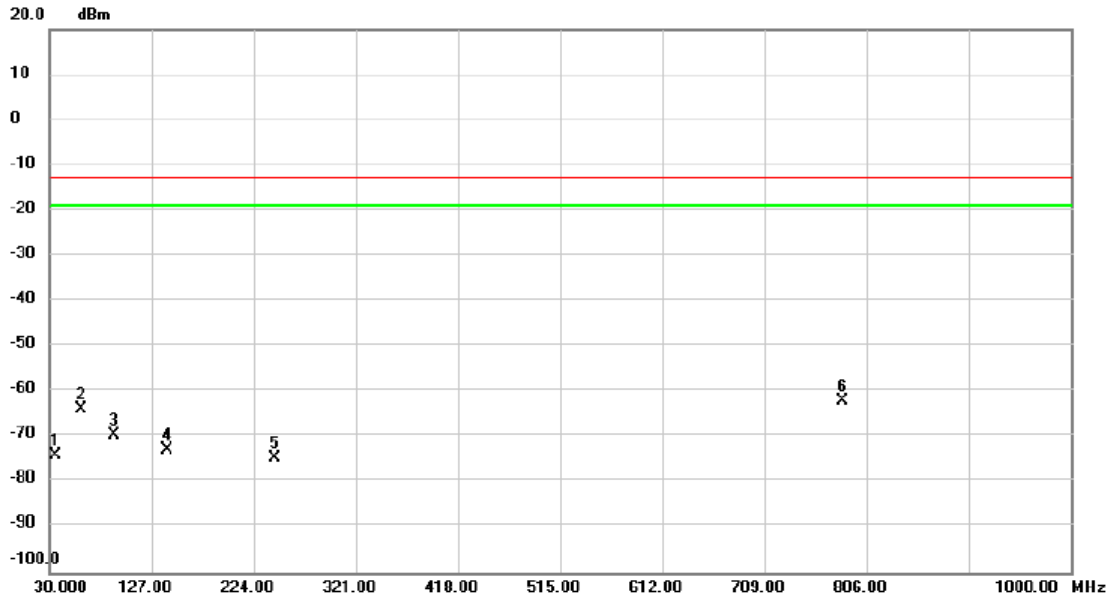

No.	Mk.	Freq. MHz	Reading Level dBm	Correct Factor dB	Measure- ment dBm	Limit dBm	Margin dB	Detector	Comment
1		36.305	-59.15	-14.93	-74.08	-13.00	-61.08	peak	
2		60.070	-48.19	-15.69	-63.88	-13.00	-50.88	peak	
3		91.595	-50.36	-19.32	-69.68	-13.00	-56.68	peak	
4		141.550	-60.74	-12.00	-72.74	-13.00	-59.74	peak	
5		244.370	-60.23	-14.51	-74.74	-13.00	-61.74	peak	
6	*	783.205	-60.11	-2.05	-62.16	-13.00	-49.16	peak	

Test Mode: GSM850\_TX CH190\_EDGE

### Horizontal

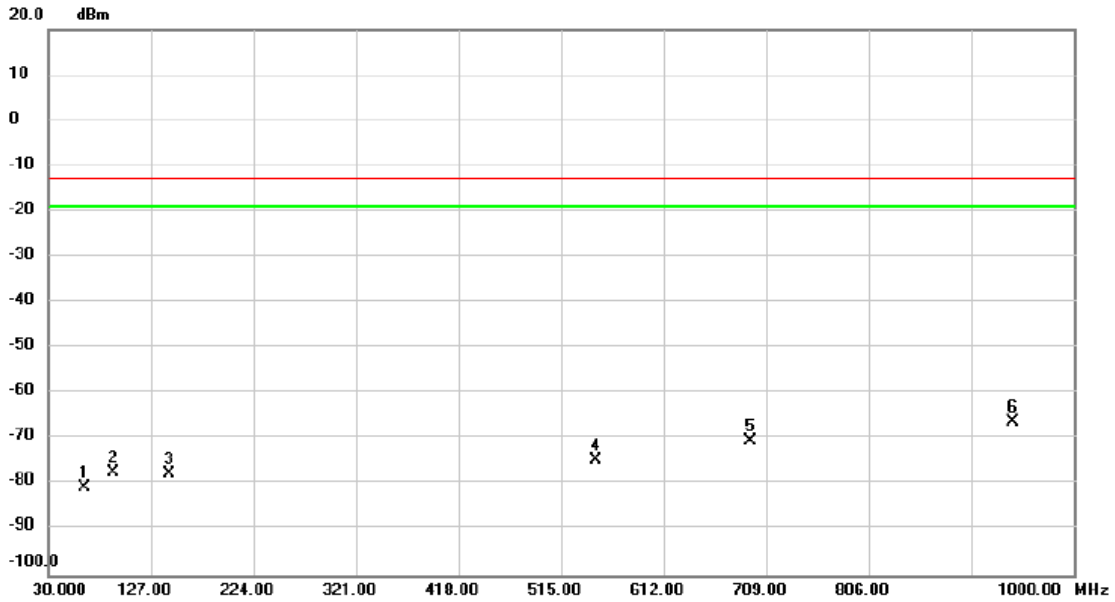

No.	Mk.	Freq. MHz	Reading Level dBm	Correct Factor dB	Measure- ment dBm	Limit dBm	Margin dB	Detector	Comment
1		64.435	-64.19	-16.44	-80.63	-13.00	-67.63	peak	
2		91.595	-57.93	-19.32	-77.25	-13.00	-64.25	peak	
3		143.975	-65.89	-11.86	-77.75	-13.00	-64.75	peak	
4		547.495	-69.01	-5.62	-74.63	-13.00	-61.63	peak	
5		693.965	-67.39	-3.05	-70.44	-13.00	-57.44	peak	
6	*	941.800	-67.34	1.07	-66.27	-13.00	-53.27	peak	

Test Mode: WCDMA Band V\_TX CH4182

Vertical

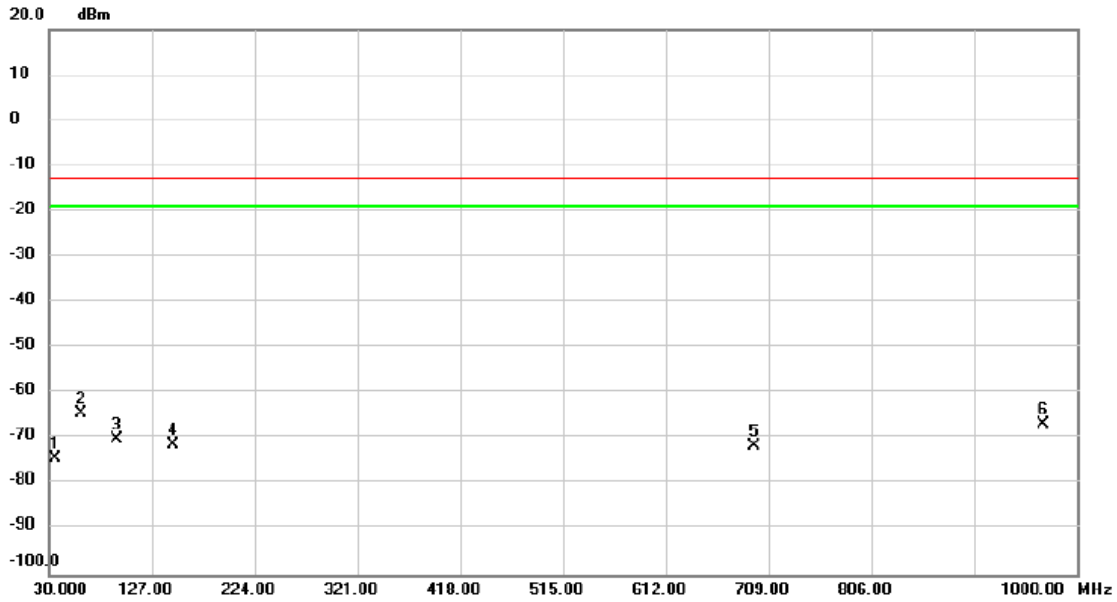

No.	Mk.	Freq. MHz	Reading Level dBm	Correct Factor dB	Measure- ment dBm	Limit dBm	Margin dB	Detector	Comment
1		36.305	-59.37	-14.93	-74.30	-13.00	-61.30	peak	
2	*	60.070	-48.78	-15.69	-64.47	-13.00	-51.47	peak	
3		94.020	-50.94	-19.11	-70.05	-13.00	-57.05	peak	
4		146.885	-59.71	-11.69	-71.40	-13.00	-58.40	peak	
5		695.905	-68.69	-2.95	-71.64	-13.00	-58.64	peak	
6		968.475	-67.93	0.97	-66.96	-13.00	-53.96	peak	



Test Mode: WCDMA Band V\_TX CH4182

Horizontal

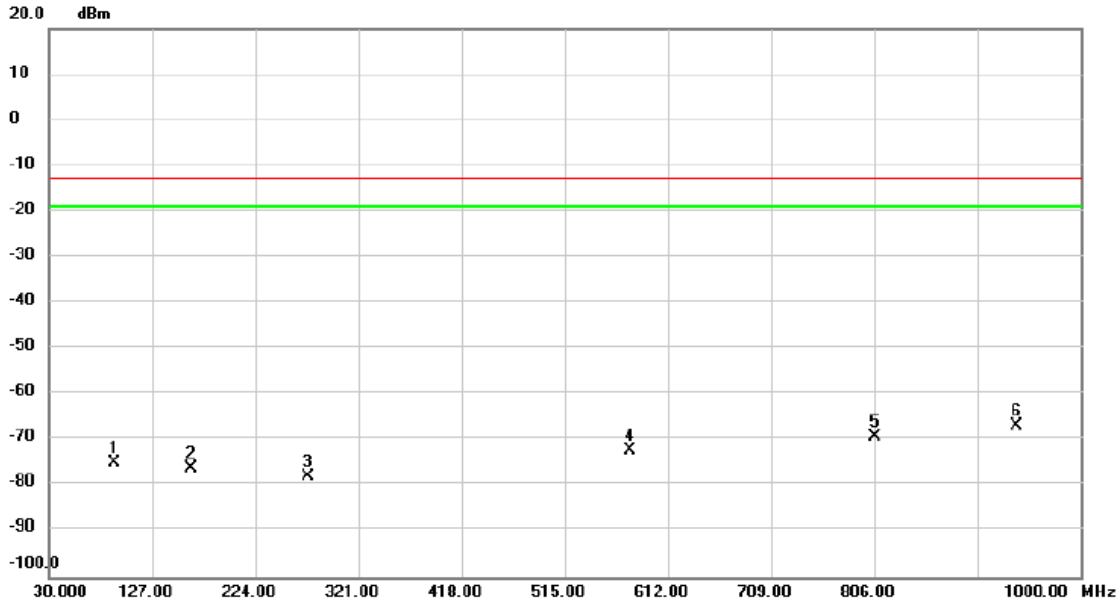

No.	Mk.	Freq. MHz	Reading Level dBm	Correct Factor dB	Measure- ment dBm	Limit dBm	Margin dB	Detector	Comment
1		91.110	-55.62	-19.37	-74.99	-13.00	-61.99	peak	
2		163.375	-65.33	-10.81	-76.14	-13.00	-63.14	peak	
3		273.955	-65.88	-12.05	-77.93	-13.00	-64.93	peak	
4		576.110	-66.22	-5.90	-72.12	-13.00	-59.12	peak	
5		806.970	-68.12	-1.14	-69.26	-13.00	-56.26	peak	
6	*	940.345	-67.75	1.02	-66.73	-13.00	-53.73	peak	

## APPENDIX F - RADIATED EMISSION (ABOVE 1GHZ)

Test Mode: GSM850\_TX CH190\_GSM

**Vertical**

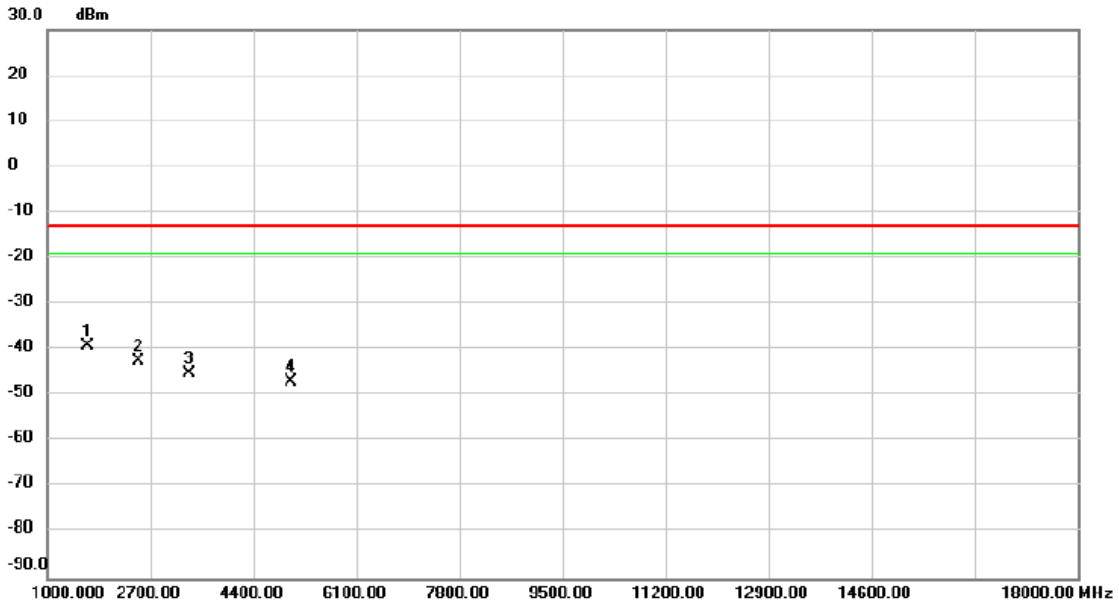

No.	Mk.	Freq. MHz	Reading Level dBm	Correct Factor dB	Measure- ment dBm	Limit dBm	Margin dB	Detector	Comment
1	*	1671.500	-35.00	-4.22	-39.22	-13.00	-26.22	peak	
2		2513.000	-39.63	-2.87	-42.50	-13.00	-29.50	peak	
3		3346.000	-45.97	0.84	-45.13	-13.00	-32.13	peak	
4		5020.500	-51.55	4.64	-46.91	-13.00	-33.91	peak	

Test Mode: GSM850\_TX CH190\_GSM

**Horizontal**

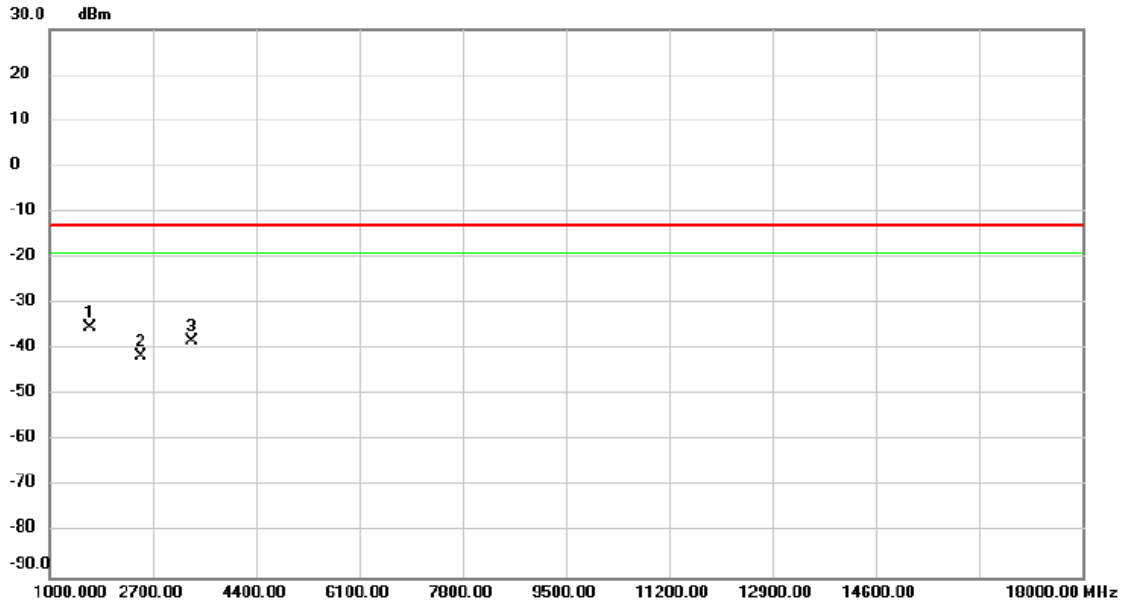

No.	Mk.	Freq. MHz	Reading Level dBm	Correct Factor dB	Measure- ment dBm	Limit dBm	Margin dB	Detector	Comment
1	*	1671.500	-30.96	-4.22	-35.18	-13.00	-22.18	peak	
2		2513.000	-38.55	-2.87	-41.42	-13.00	-28.42	peak	
3		3346.000	-38.98	0.84	-38.14	-13.00	-25.14	peak	

Test Mode: GSM850\_TX CH190\_EDGE

**Vertical**

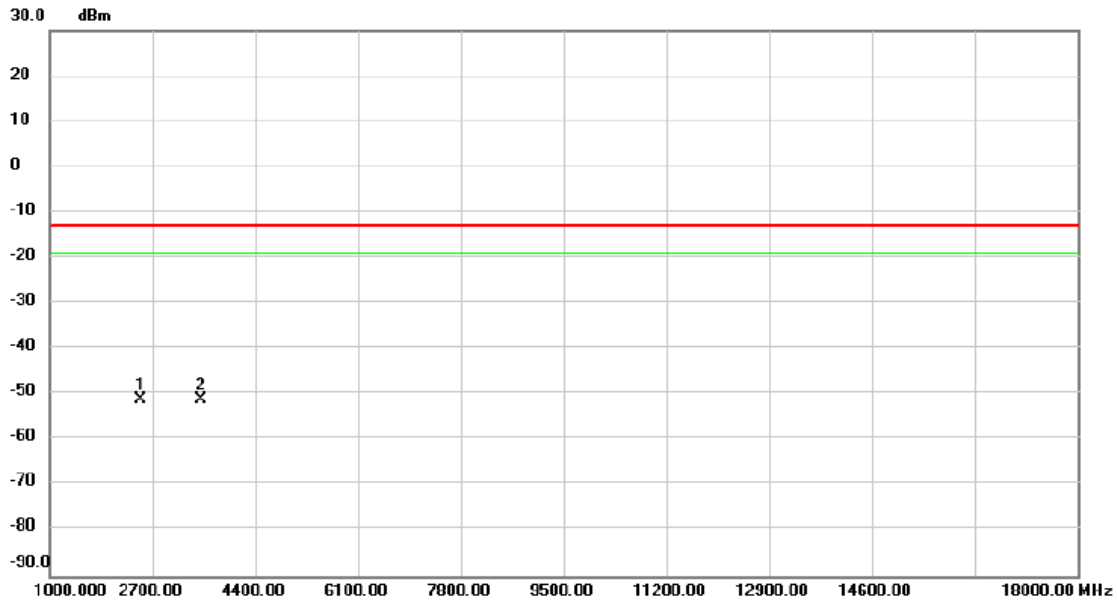

No.	Mk.	Freq. MHz	Reading Level dBm	Correct Factor dB	Measure- ment dBm	Limit dBm	Margin dB	Detector	Comment
1	*	2496.000	-48.31	-2.96	-51.27	-13.00	-38.27	peak	
2		3499.000	-52.21	0.92	-51.29	-13.00	-38.29	peak	

Test Mode: GSM850\_TX CH190\_EDGE

**Horizontal**

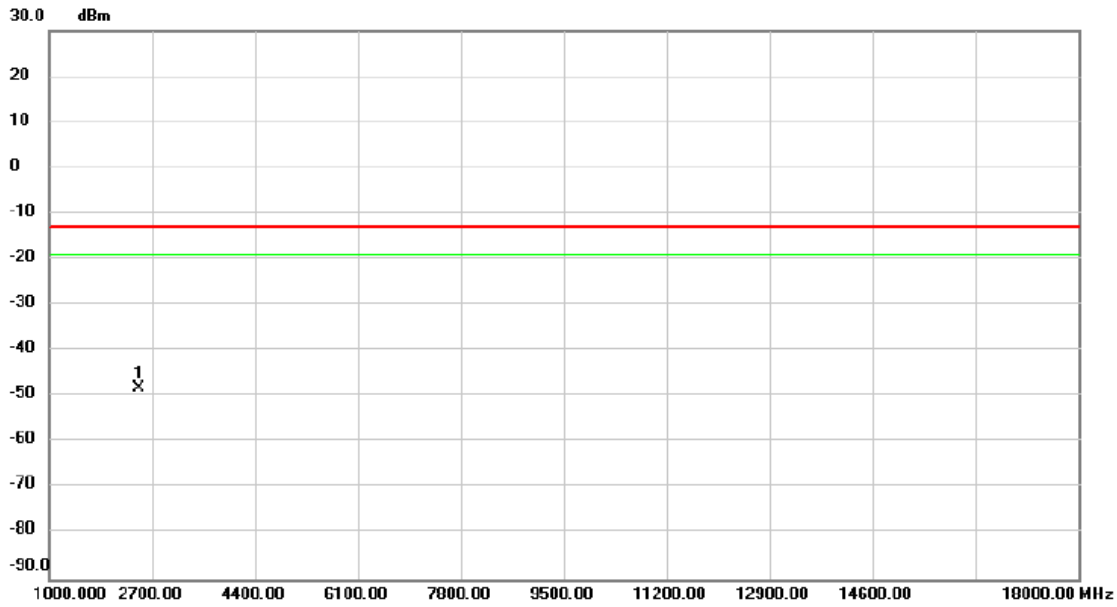

No.	Mk.	Freq. MHz	Reading Level dBm	Correct Factor dB	Measure- ment dBm	Limit dBm	Margin dB	Detector	Comment
1	*	2487.500	-45.19	-2.96	-48.15	-13.00	-35.15	peak	

Test Mode: WCDMA Band V\_TX CH4182

Vertical

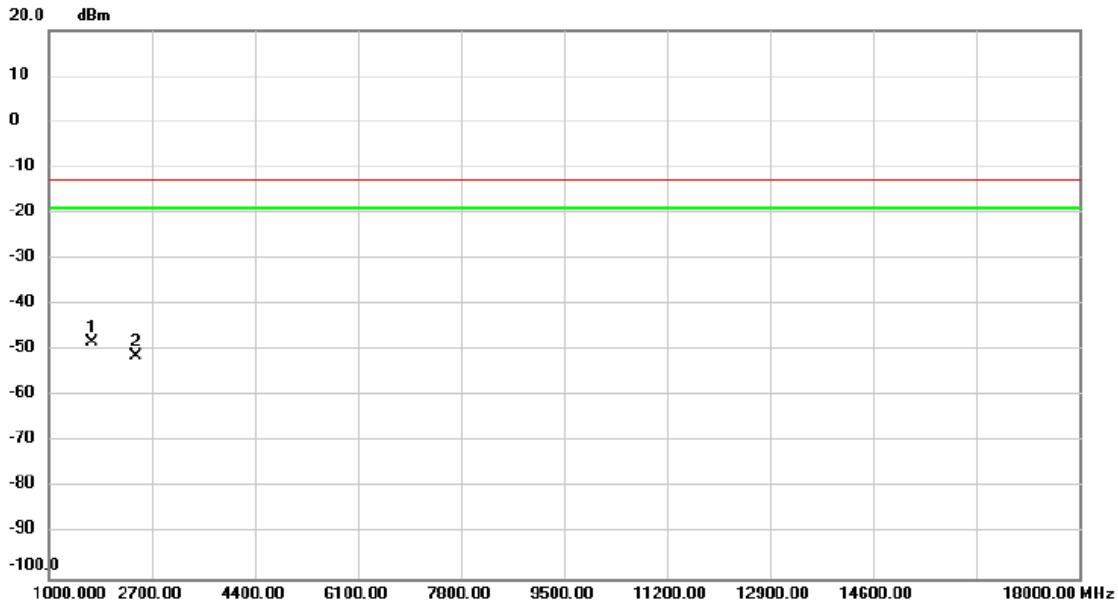

No.	Mk.	Freq. MHz	Reading Level dBm	Correct Factor dB	Measure- ment dBm	Limit dBm	Margin dB	Detector	Comment
1	*	1714.000	-44.13	-4.07	-48.20	-13.00	-35.20	peak	
2		2445.000	-48.16	-2.97	-51.13	-13.00	-38.13	peak	

Test Mode: WCDMA Band V\_TX CH4182

**Horizontal**

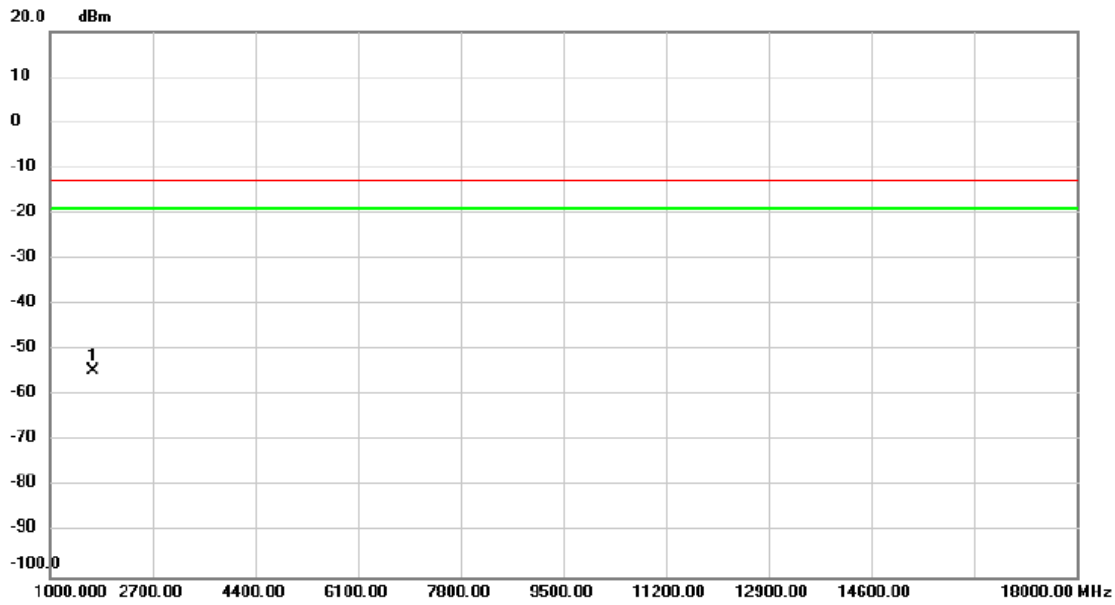

No.	Mk.	Freq. MHz	Reading Level dBm	Correct Factor dB	Measure- ment dBm	Limit dBm	Margin dB	Detector	Comment
1	*	1714.000	-50.36	-4.07	-54.43	-13.00	-41.43	peak	



## APPENDIX G - BAND EDGE

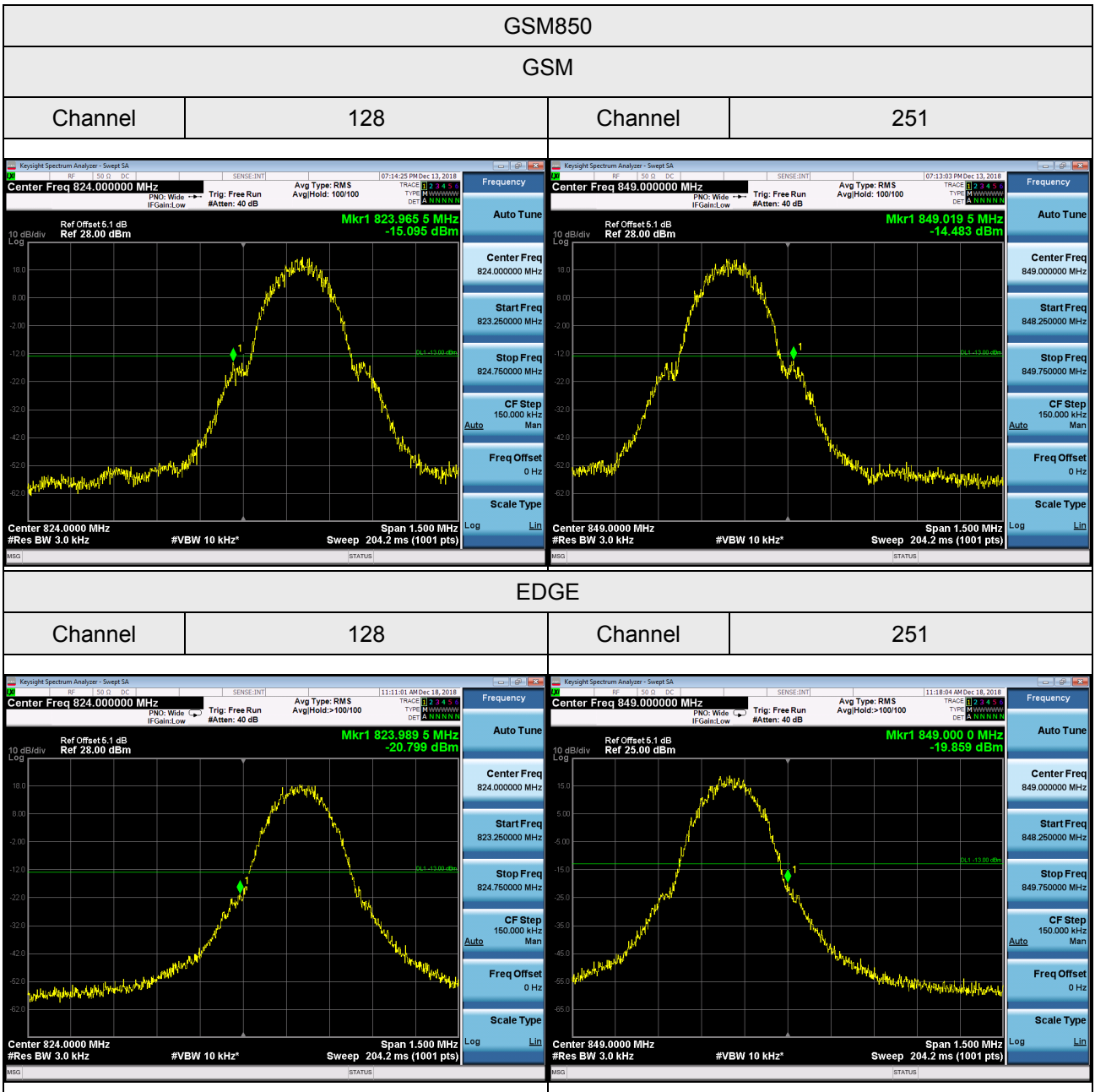

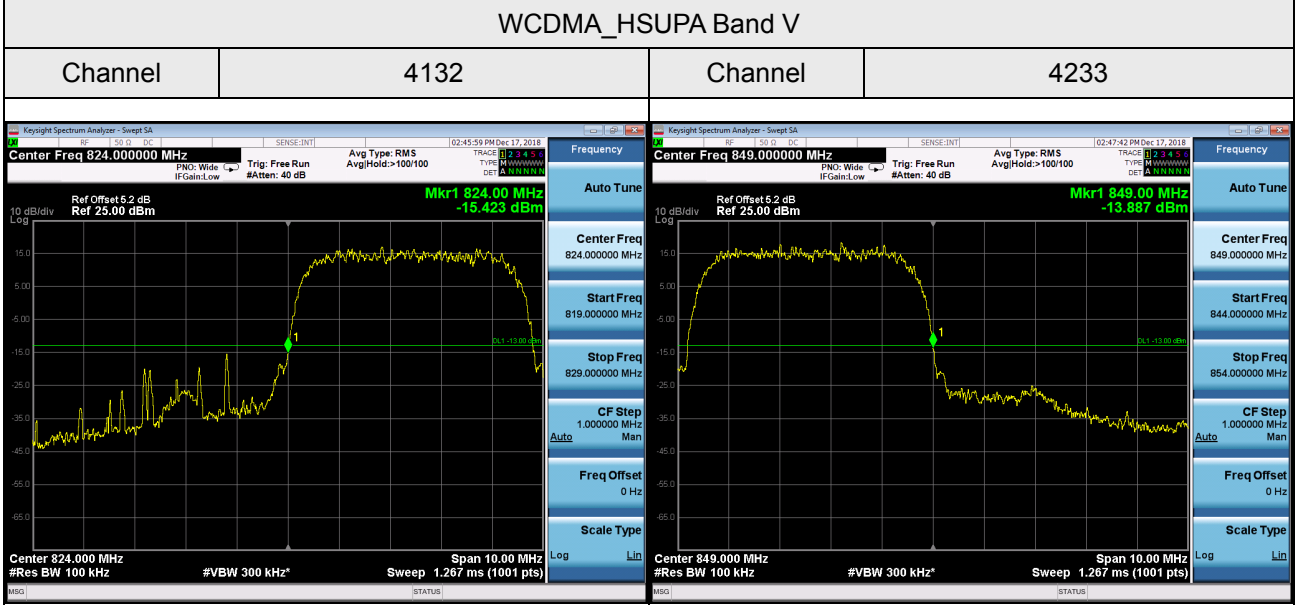
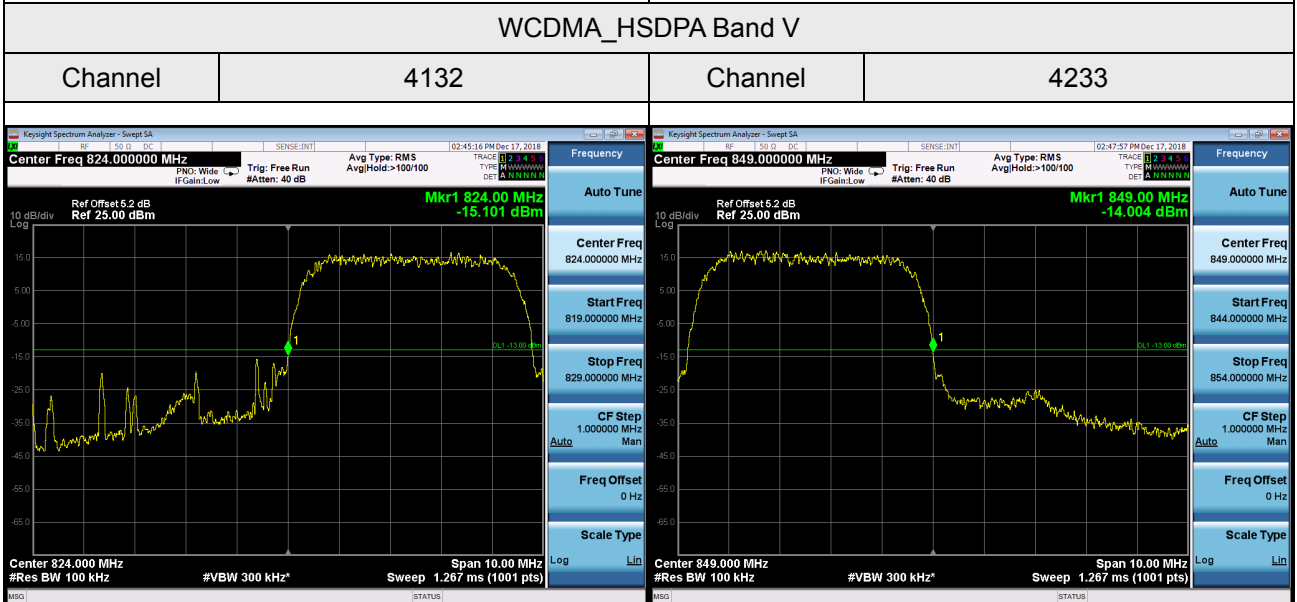
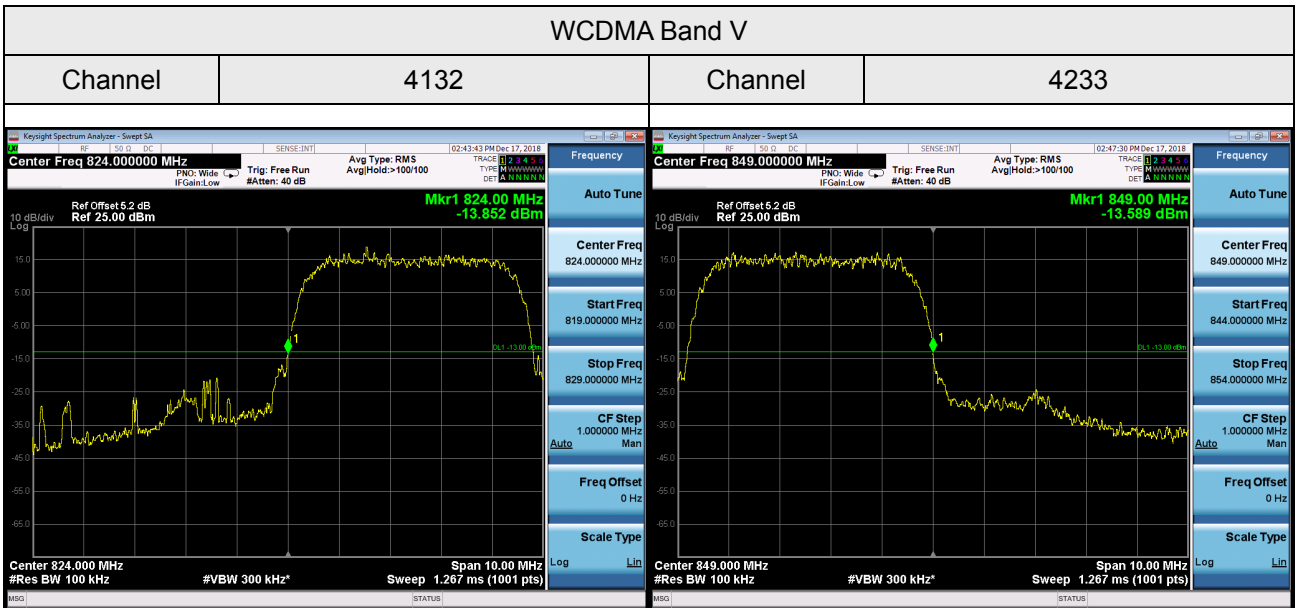

## APPENDIX H - PEAK TO AVERAGE RATIO

GSM850							
GSM				EDGE			
CS				8PSK			
Channel	Frequency (MHz)	PAPR (dB)	Limit (dB)	Channel	Frequency (MHz)	PAPR (dB)	Limit (dB)
128	824.2	0.81	13	128	824.2	3.19	13
190	836.6	0.81	13	190	836.6	3.15	13
251	848.8	0.81	13	251	848.8	3.17	13

### WCDMA Band V Spectrum Plot

4132

4182

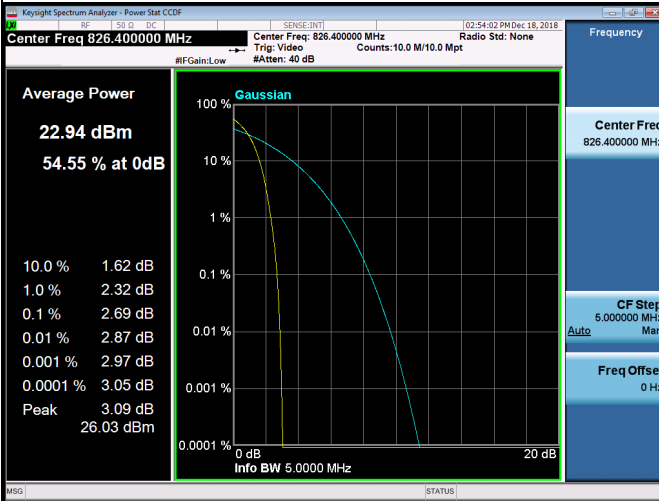

4233

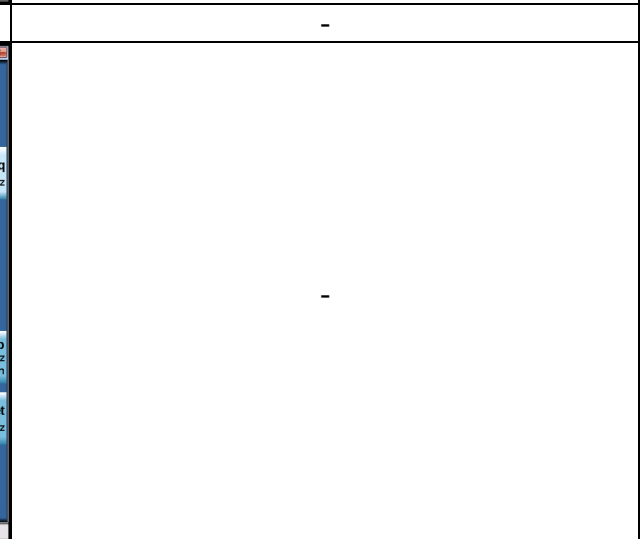
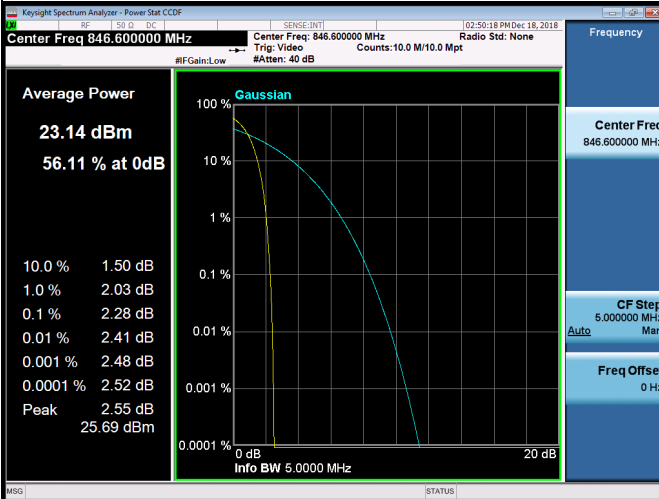

### WCDMA\_HSDPA Band V Spectrum Plot

4132

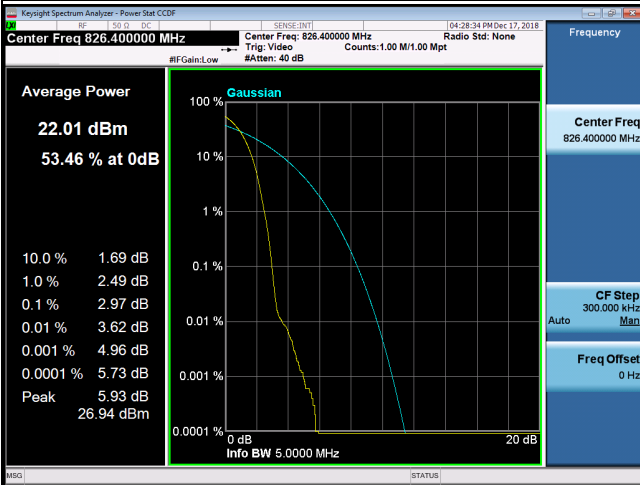

4182

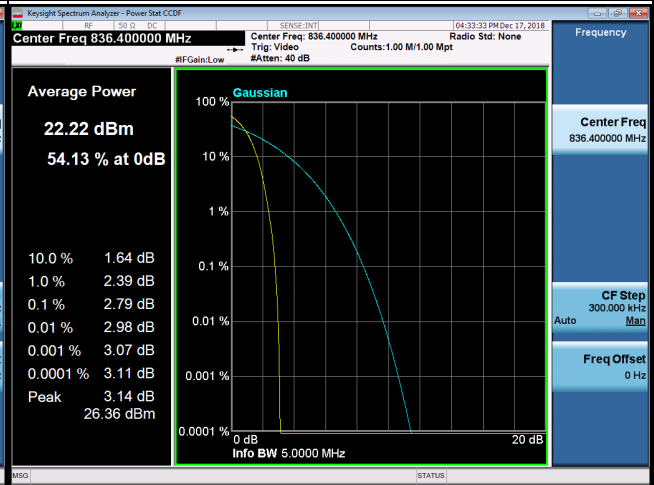

4233

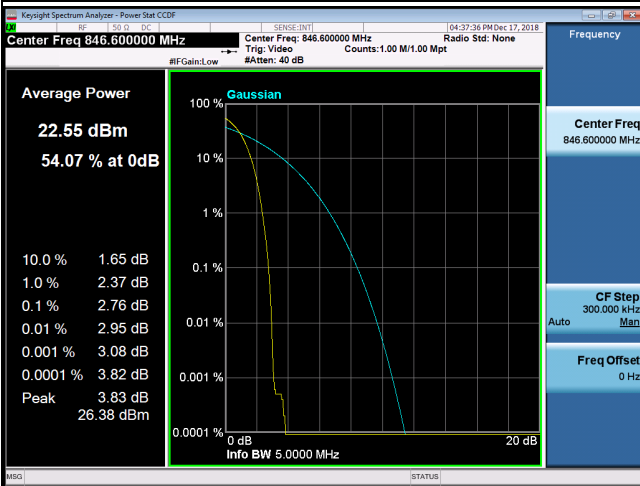

-

-

### WCDMA\_HSUPA Band V Spectrum Plot

**4132**

**4182**

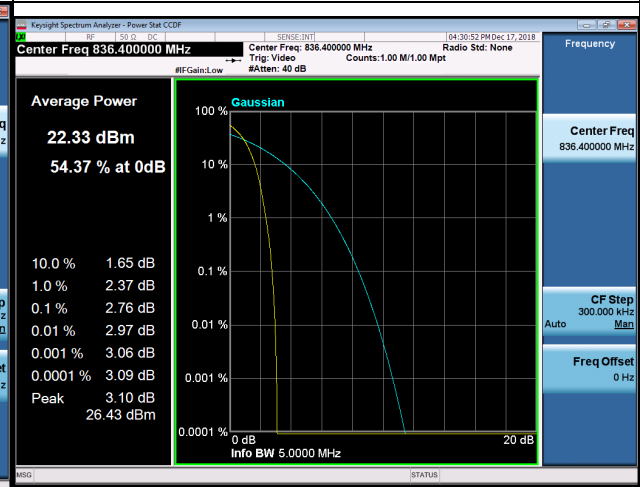
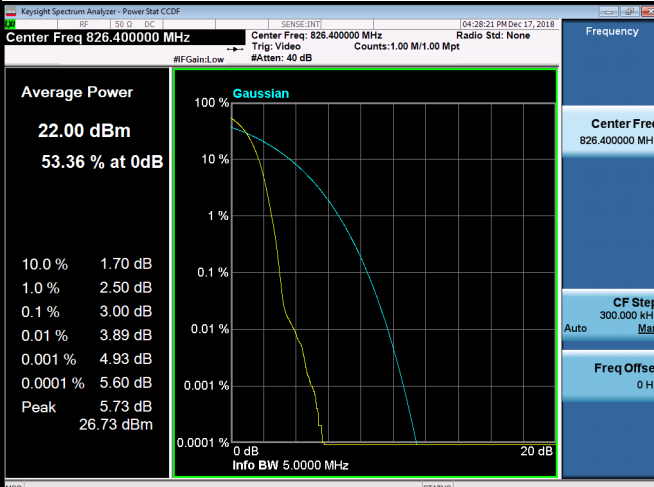

**4233**

-

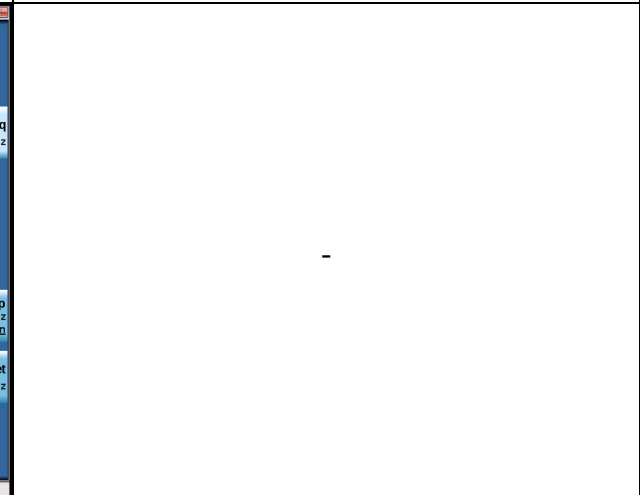
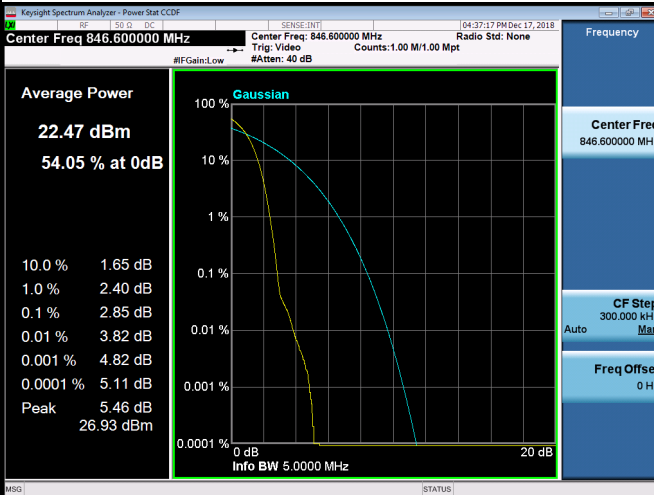



## APPENDIX G - FREQUENCY STABILITY

Test Mode:	GSM850_CH190
------------	--------------

**Temperature vs. Frequency Stability**

Temperature(°C)	Frequency Error (Hz)	Frequency Error (ppm)	Limit(ppm)
-10	5.33	0.006371026	±2.5
0	5.60	0.00714798	
10	6.52	0.005594071	
20	4.95	0.008044466	
30	7.00	0.006562276	
40	5.76	0.007817356	
50	6.81	0.00821181	
60	7.14	0.007554387	
Max. Deviation (ppm)	7.14	0.00821181	

**Voltage vs. Frequency Stability**

Voltage(Volts)	Frequency Error (Hz)	Frequency Error (ppm)	Limit(ppm)
4.35	3.45	0.0038011	±2.5
3.80	4.21	0.004709539	
3.50	3.85	0.004279225	
Max. Deviation (ppm)	4.21	0.004709539	

Test Mode:	WCDMA Band V_CH4182
------------	---------------------

**Temperature vs. Frequency Stability**

Temperature(°C)	Frequency Error (Hz)	Frequency Error (ppm)	Limit(ppm)
-10	4.60	0.006371026	± 2.5
0	3.59	0.00714798	
10	7.53	0.005594071	
20	4.14	0.008044466	
30	8.77	0.006562276	
40	8.21	0.007817356	
50	2.71	0.00821181	
60	6.61	0.007554387	
Max. Deviation (ppm)	8.77	0.00821181	

**Voltage vs. Frequency Stability**

Voltage(Volts)	Frequency Error (Hz)	Frequency Error (ppm)	Limit(ppm)
4.35	3.65	0.0038011	± 2.5
3.80	1.58	0.004709539	
3.50	4.23	0.004279225	
Max. Deviation (ppm)	4.23	0.004709539	

**End of Test Report**