

# FCC Radio Test Report

## FCC ID: ZLE-RG650U

This report concerns: **Original Grant**

**Project No.** : 1810C073  
**Equipment** : LTE SMARTPHONE  
**Test Model** : RG650U  
**Series Model** : N/A  
**Applicant** : Power Idea Technology (Shenzhen) Co., Ltd.  
**Address** : 4th Floor, A Section ,Languang Science&technology  
Xinxi RD, Hi-Tech Industrial Park North, Nanshan,  
ShenZhen, China

**Date of Receipt** : Oct. 18, 2018  
**Date of Test** : Dec. 10, 2018 ~ Jan. 02, 2019  
**Issued Date** : Jan. 28, 2019  
**Tested by** : BTL Inc.

**Testing Engineer** :

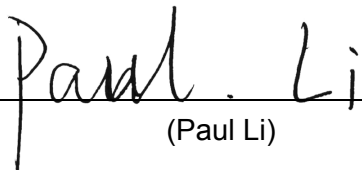
  
(Paul Li)

**Technical Manager** :

  
(David Mao)

**Authorized Signatory** :

  
(Steven Lu)

# **B T L I N C .**

No.3, Jinshagang 1st Road, Shixia, Dalang Town, Dongguan,  
Guangdong, China.

TEL: +86-769-8318-3000 FAX: +86-769-8319-6000



Certificate #5123.02

### **Declaration**

**BTL** represents to the client that testing is done in accordance with standard procedures as applicable and that test instruments used has been calibrated with standards traceable to international standard(s) and/or national standard(s).

**BTL's** reports apply only to the specific samples tested under conditions. It is manufacture's responsibility to ensure that additional production units of this model are manufactured with the identical electrical and mechanical components. **BTL** shall have no liability for any declarations, inferences or generalizations drawn by the client or others from **BTL** issued reports.

The report must not be used by the client to claim product certification, approval, or endorsement by NVLAP, NIST, A2LA, or any agency of the U.S. Government.

This report is the confidential property of the client. As a mutual protection to the clients, the public and ourselves, the test report shall not be reproduced, except in full, without our written approval.

**BTL's** laboratory quality assurance procedures are in compliance with the **ISO/IEC 17025** requirements, and accredited by the conformity assessment authorities listed in this test report.

**BTL** is not responsible for the sampling stage, so the results only apply to the sample as received.

The information, data and test plan are provided by manufacturer which may affect the validity of results, so it is manufacturer's responsibility to ensure that the apparatus meets the essential requirements of applied standards and in all the possible configurations as representative of its intended use.

### **Limitation**

For the use of the authority's logo is limited unless the Test Standard(s)/Scope(s)/Item(s) mentioned in this test report is (are) included in the conformity assessment authorities acceptance respective.

Table of Contents	Page
<b>REPORT ISSUED HISTORY</b>	<b>6</b>
<b>1 . GENERAL SUMMARY</b>	<b>7</b>
<b>2 . SUMMARY OF TEST RESULTS</b>	<b>8</b>
2.1 TEST FACILITY	9
2.2 MEASUREMENT UNCERTAINTY	9
<b>3 . GENERAL INFORMATION</b>	<b>10</b>
3.1 GENERAL DESCRIPTION OF EUT	10
3.2 TEST MODES	13
3.3 PARAMETERS OF TEST SOFTWARE	16
3.4 DUTY CYCLE	17
3.5 BLOCK DIAGRAM SHOWING THE CONFIGURATION OF SYSTEM TESTED	18
3.6 SUPPORT UNITS	18
<b>4 . AC POWER LINE CONDUCTED EMISSIONS TEST</b>	<b>19</b>
4.1 LIMIT	19
4.2 TEST PROCEDURE	19
4.3 DEVIATION FROM TEST STANDARD	19
4.4 TEST SETUP	20
4.5 EUT OPERATION CONDITIONS	20
4.6 EUT TEST CONDITIONS	20
4.7 TEST RESULTS	20
<b>5 . RADIATED EMISSION TEST</b>	<b>21</b>
5.1 LIMIT	21
5.2 TEST PROCEDURE	22
5.3 DEVIATION FROM TEST STANDARD	22
5.4 TEST SETUP	22
5.5 EUT OPERATION CONDITIONS	24
5.6 EUT TEST CONDITIONS	24
5.7 TEST RESULTS - 9 kHz to 30 MHz	24
5.8 TEST RESULTS - 30 MHz TO 1000 MHz	24
5.9 TEST RESULTS - ABOVE 1000 MHz	24
<b>6 . BANDWIDTH</b>	<b>25</b>
6.1 LIMIT	25
6.2 TEST PROCEDURE	25

<b>Table of Contents</b>	<b>Page</b>
<b>6.3 TEST PROCEDURE</b>	<b>25</b>
<b>6.4 TEST SETUP</b>	<b>26</b>
<b>6.5 EUT OPERATION CONDITIONS</b>	<b>26</b>
<b>6.6 EUT TEST CONDITIONS</b>	<b>26</b>
<b>6.7 TEST RESULTS</b>	<b>26</b>
<b>7 . MAXIMUM OUTPUT POWER</b>	<b>27</b>
<b>7.1 LIMIT</b>	<b>27</b>
<b>7.2 TEST PROCEDURE</b>	<b>27</b>
<b>7.3 DEVIATION FROM STANDARD</b>	<b>27</b>
<b>7.4 TEST SETUP</b>	<b>28</b>
<b>7.5 EUT OPERATION CONDITIONS</b>	<b>28</b>
<b>7.6 EUT TEST CONDITIONS</b>	<b>28</b>
<b>7.7 TEST RESULTS</b>	<b>28</b>
<b>8 . POWER SPECTRAL DENSITY TEST</b>	<b>29</b>
<b>8.1 LIMIT</b>	<b>29</b>
<b>8.2 TEST PROCEDURE</b>	<b>29</b>
<b>8.3 DEVIATION FROM STANDARD</b>	<b>29</b>
<b>8.4 TEST SETUP</b>	<b>30</b>
<b>8.5 EUT OPERATION CONDITIONS</b>	<b>30</b>
<b>8.6 EUT TEST CONDITIONS</b>	<b>30</b>
<b>8.7 TEST RESULTS</b>	<b>30</b>
<b>9 . FREQUENCY STABILITY MEASUREMENT</b>	<b>31</b>
<b>9.1 LIMIT</b>	<b>31</b>
<b>9.2 TEST PROCEDURE</b>	<b>31</b>
<b>9.3 DEVIATION FROM STANDARD</b>	<b>31</b>
<b>9.4 TEST SETUP</b>	<b>32</b>
<b>9.5 EUT OPERATION CONDITIONS</b>	<b>32</b>
<b>9.6 EUT TEST CONDITIONS</b>	<b>32</b>
<b>9.7 TEST RESULTS</b>	<b>32</b>
<b>10 . MEASUREMENT INSTRUMENTS LIST</b>	<b>33</b>
<b>11 . EUT TEST PHOTOS</b>	<b>35</b>
<b>APPENDIX A - AC POWER LINE CONDUCTED EMISSIONS</b>	<b>39</b>
<b>APPENDIX B - RADIATED EMISSION - 9 KHZ TO 30 MHZ</b>	<b>44</b>

**Table of Contents**

**Page**

<b>APPENDIX C - RADIATED EMISSION - 30 MHZ TO 1 GHZ</b>	<b>49</b>
<b>APPENDIX D - RADIATED EMISSION - ABOVE 1000 MHZ</b>	<b>52</b>
<b>APPENDIX E - BANDWIDTH</b>	<b>185</b>
<b>APPENDIX F - CONDUCTED OUTPUT POWER</b>	<b>194</b>
<b>APPENDIX G - POWER SPECTRAL DENSITY</b>	<b>199</b>
<b>APPENDIX H - FREQUENCY STABILITY</b>	<b>208</b>

### REPORT ISSUED HISTORY

Report Version	Description	Issued Date
R00	Original Issue.	Jan. 07, 2019
R01	Changed the FCC ID and applicant information.	Jan. 28, 2019

## 1. GENERAL SUMMARY

Equipment : LTE SMARTPHONE  
Brand Name : RugGear  
Test Model : RG650U  
Series Model : N/A  
Applicant : Power Idea Technology (Shenzhen) Co., Ltd.  
Manufacturer : RUGGEAR LIMITED  
Address : RM1301,13/F WING TUCK COMM CTR 177-183 WING LOK ST SHEUNG  
WAN HONG KONG  
Date of Test : Dec. 10, 2018 ~ Jan. 02, 2019  
Test Sample : Engineering Sample No.: D181211335 for conducted, D181211444 for  
radiated.  
Standard(s) : FCC Part15, Subpart E(15.407)  
ANSI C63.10-2013

The above equipment has been tested and found compliance with the requirement of the relative standards by BTL Inc..

The test data, data evaluation, and equipment configuration contained in our test report (Ref No. BTL-FCCP-4-1810C073) were obtained utilizing the test procedures, test instruments, test sites that has been accredited by the Authority of A2LA according to the ISO/IEC 17025 quality assessment standard and technical standard(s).

**Test results included in this report are only for the RLAN 5GHz UNII-1, UNII-2A, UNII-2C and UNII-3 part.**

## 2. SUMMARY OF TEST RESULTS

Test procedures according to the technical standard(s):

FCC Part15, Subpart E(15.407)				
Standard(s) Section	Test Item	Test Result	Judgement	Remark
15.207 15.407(b)	AC Power Line Conducted Emissions	APPENDIX A	PASS	-----
15.205 15.407(b)	Radiated Emissions	APPENDIX B APPENDIX C APPENDIX D	PASS	-----
15.407(a) 15.407(e)	Spectrum Bandwidth	APPENDIX E	PASS	-----
15.407(a)	Maximum Output Power	APPENDIX F	PASS	-----
15.407(a)	Power Spectral Density	APPENDIX G	PASS	-----
15.407(g)	Frequency Stability	APPENDIX H	PASS	-----
15.203	Antenna Requirements	-----	PASS	-----
15.407(c)	Automatically Discontinue Transmission	-----	PASS	<b>NOTE (2)</b>

Note:

- (1) "N/A" denotes test is not applicable in this test report.
- (2) During no any information transmission, the EUT can automatically discontinue transmission and become standby mode for power saving. the EUT can detect the controlling signal of ACK message transmitting from remote device and verify whether it shall resend or discontinue transmission.
- (3) For UNII-1 this device was functioned as a  
 Access point device     Client device



**2.1 TEST FACILITY**

The test facilities used to collect the test data in this report is at the location of No.3,Jinshagang 1st Road, Shixia, Dalang Town, Dongguan, Guangdong, China.  
 BTL's Test Firm Registration Number for FCC: 357015  
 BTL's Designation Number for FCC: CN1240

**2.2 MEASUREMENT UNCERTAINTY**

The measurement uncertainty figures shall be calculated according the methods described in the ETSI TR 100 028 and shall correspond to an expansion factor (coverage factor)  $k=1.96$  or  $k=2$ (which provide confidence levels of respectively 90% and 95.45% in the case where the distributions characterizing the actual measurement uncertainties are normal (Gaussian)).  
 Measurement Uncertainty for a Level of Confidence of 95 %,  $U=2 \times U_c(y)$ .

The BTL measurement uncertainty as below table:

A. AC power line conducted emissions Measurement:

Test Site	Method	Measurement Frequency Range	U, (dB)
DG-C02	CISPR	150 KHz ~ 30 MHz	2.32

B. Radiated emissions Measurement:

Test Site	Method	Measurement Frequency Range	Ant. H / V	U, (dB)
DG-CB03	CISPR	9 kHz~30 MHz	V	3.79
		9 kHz~30 MHz	H	3.57
		30 MHz~200 MHz	V	3.82
		30 MHz~200 MHz	H	3.60
		200 MHz~1,000 MHz	V	3.86
		200 MHz~1,000 MHz	H	3.94
		1 GHz~18 GHz	V	3.12
		1 GHz~18 GHz	H	3.68
		18 GHz~40 GHz	V	4.15
		18 GHz~40 GHz	H	4.14

Note: Unless specifically mentioned, the uncertainty of measurement has not been taken into account to declare the compliance or non-compliance to the specification.

### 3. GENERAL INFORMATION

#### 3.1 GENERAL DESCRIPTION OF EUT

Equipment	LTE SMARTPHONE
Brand Name	RugGear
Test Model	RG650U
Series Model	N/A
Model Difference(s)	N/A
Hardware Version	V1.0
Software Version	RG650_US_1.0.0.0.0_1
Operation Frequency	UNII-1: 5150 MHz to 5250 MHz UNII-2A: 5250 MHz to 5350 MHz UNII-2C: 5470 MHz to 5600 MHz & 5650 MHz to 5725 MHz UNII-3: 5725 MHz to 5850 MHz
Modulation Type	OFDM
Bit Rate of Transmitter	Up to 433.3 Mbps
Maximum Conducted Output Power for UNII-1	IEEE 802.11a: 11.77 dBm (0.0150 W) IEEE 802.11n (HT20): 11.70 dBm (0.0148 W) IEEE 802.11n (HT40): 10.98 dBm (0.0125 W)
Maximum Conducted Output Power for UNII-2A	IEEE 802.11a: 11.35 dBm (0.0136 W) IEEE 802.11n (HT20): 11.27 dBm (0.0134 W) IEEE 802.11n (HT40): 10.41 dBm (0.0110 W)
Maximum Conducted Output Power for UNII-2C	IEEE 802.11a: 10.06 dBm (0.0101 W) IEEE 802.11n (HT20): 10.11 dBm (0.0103 W) IEEE 802.11n (HT40): 9.59 dBm (0.0091 W)
Maximum Conducted Output Power for UNII-3	IEEE 802.11a: 10.80 dBm (0.0120 W) IEEE 802.11n (HT20): 10.37 dBm (0.0109 W) IEEE 802.11n (HT40): 10.59 dBm (0.0115 W)
Power Source	1# DC voltage supplied from AC/DC adapter. Manufacturer / Model: Shenzhen Huntkey Electric co.,Ltd / HKC0055010-2D 2# Supplied from Li-Polymer battery. Manufacturer / Model: SHENZHEN JIAYUANTONGDA TECHNOLOGY CO.,LTD. / BL420KP 3# Supplied from USB port.
Power Rating	1# I/P: 100-240V~ 50-60Hz 0.2A O/P: 5V --- 1.0A 2# DC 3.80V/4200mAh (15.96Wh) 3# DC 5V

Note:

- For a more detailed features description, please refer to the manufacturer's specifications or the user's manual.

2. Channel List:

IEEE 802.11a IEEE 802.11n (HT20)		IEEE 802.11n (HT40)	
UNII-1		UNII-1	
Channel	Frequency (MHz)	Channel	Frequency (MHz)
36	5180	38	5190
40	5200	46	5230
44	5220		
48	5240		

IEEE 802.11a IEEE 802.11n (HT20)		IEEE 802.11n (HT40)	
UNII-2A		UNII-2A	
Channel	Frequency (MHz)	Channel	Frequency (MHz)
52	5260	54	5270
56	5280	62	5310
60	5300		
64	5320		

IEEE 802.11a IEEE 802.11n (HT20)		IEEE 802.11n (HT40)	
UNII-2C		UNII-2C	
Channel	Frequency (MHz)	Channel	Frequency (MHz)
100	5500	102	5510
104	5520	110	5550
108	5540	118	5590
112	5560	134	5670
116	5580		
132	5660		
136	5680		
140	5700		

IEEE 802.11a IEEE 802.11n (HT20)		IEEE 802.11n (HT40)	
UNII-3		UNII-3	
Channel	Frequency (MHz)	Channel	Frequency (MHz)
149	5745	151	5755
153	5765	159	5795
157	5785		
161	5805		
165	5825		

3. Antenna Specification:

Ant.	Brand	Model Name	Antenna Type	Connector	Gain (dBi)
1	N/A	N/A	Internal	N/A	0.8

### 3.2 TEST MODES

The test system was pre-tested based on the consideration of all possible combinations of EUT operation mode.

Pretest Mode	Description
Mode 1	TX A Mode / CH36, CH40, CH48 (UNII-1)
Mode 2	TX N (HT20) Mode / CH36, CH40, CH48 (UNII-1)
Mode 3	TX N (HT40) Mode / CH38, CH46 (UNII-1)
Mode 4	TX A Mode / CH52, CH60, CH64 (UNII-2A)
Mode 5	TX N (HT20) Mode / CH52, CH60, CH64 (UNII-2A)
Mode 6	TX N (HT40) Mode / CH54, CH62 (UNII-2A)
Mode 7	TX A Mode / CH100, CH116, CH140 (UNII-2C)
Mode 8	TX N (HT20) Mode / CH100, CH116, CH140 (UNII-2C)
Mode 9	TX N (HT40) Mode / CH102, CH110, CH134 (UNII-2C)
Mode 10	TX A Mode / CH149,CH157,CH165 (UNII-3)
Mode 11	TX N (HT20) Mode / CH149,CH157,CH165 (UNII-3)
Mode 12	TX N (HT40) Mode / CH151,CH159 (UNII-3)
Mode 13	TX A Mode / CH40 (UNII-1)

Following mode(s) as (were) found to be the worst case(s) and selected for the final test.

AC power line conducted emissions test	
Final Test Mode	Description
Mode 13	TX A Mode / CH40 (UNII-1)

Radiated emissions test	
Final Test Mode	Description
Mode 1	TX A Mode / CH36, CH40, CH48 (UNII-1)
Mode 2	TX N (HT20) Mode / CH36, CH40, CH48 (UNII-1)
Mode 3	TX N (HT40) Mode / CH38, CH46 (UNII-1)
Mode 4	TX A Mode / CH52, CH60, CH64 (UNII-2A)
Mode 5	TX N (HT20) Mode / CH52, CH60, CH64 (UNII-2A)
Mode 6	TX N (HT40) Mode / CH54, CH62 (UNII-2A)
Mode 7	TX A Mode / CH100, CH116, CH140 (UNII-2C)
Mode 8	TX N (HT20) Mode / CH100, CH116, CH140 (UNII-2C)
Mode 9	TX N (HT40) Mode / CH102, CH110, CH134 (UNII-2C)
Mode 10	TX A Mode / CH149,CH157,CH165 (UNII-3)
Mode 11	TX N (HT20) Mode / CH149,CH157,CH165 (UNII-3)
Mode 12	TX N (HT40) Mode / CH151,CH159 (UNII-3)

Conducted test	
Test Mode	Description
Mode 1	TX A Mode / CH36, CH40, CH48 (UNII-1)
Mode 2	TX N (HT20) Mode / CH36, CH40, CH48 (UNII-1)
Mode 3	TX N (HT40) Mode / CH38, CH46 (UNII-1)
Mode 4	TX A Mode / CH52, CH60, CH64 (UNII-2A)
Mode 5	TX N (HT20) Mode / CH52, CH60, CH64 (UNII-2A)
Mode 6	TX N (HT40) Mode / CH54, CH62 (UNII-2A)
Mode 7	TX A Mode / CH100, CH116, CH140 (UNII-2C)
Mode 8	TX N (HT20) Mode / CH100, CH116, CH140 (UNII-2C)
Mode 9	TX N (HT40) Mode / CH102, CH110, CH134 (UNII-2C)
Mode 10	TX A Mode / CH149,CH157,CH165 (UNII-3)
Mode 11	TX N (HT20) Mode / CH149,CH157,CH165 (UNII-3)
Mode 12	TX N (HT40) Mode / CH151,CH159 (UNII-3)

Note: For radiated emission below 1 GHz test, the IEEE 802.11n(HT20) is found to be the worst case and recorded.

### 3.3 PARAMETERS OF TEST SOFTWARE

UNII-1			
Test Software	CMD		
Test Frequency (MHz)	5180	5200	5240
IEEE 802.11a	18	20	20
IEEE 802.11n (HT20)	18	20	20
Test Frequency (MHz)	5190	5230	
IEEE 802.11n (HT40)	12.5	20.5	

UNII-2A			
Test Software	CMD		
Test Frequency (MHz)	5260	5300	5320
IEEE 802.11a	20	20	18
IEEE 802.11n (HT20)	20	20	18
Test Frequency (MHz)	5270	5310	
IEEE 802.11n (HT40)	20	12	

UNII-2C			
Test Software	CMD		
Test Frequency (MHz)	5500	5580	5700
IEEE 802.11a	18	18	18
IEEE 802.11n (HT20)	18	18	18
Test Frequency (MHz)	5510	5550	5670
IEEE 802.11n (HT40)	14	19.5	20

UNII-3			
Test Software	CMD		
Test Frequency (MHz)	5745	5785	5825
IEEE 802.11a	22.5	20	20.5
IEEE 802.11n (HT20)	22	22.5	22.5
Test Frequency (MHz)	5755	5795	
IEEE 802.11n (HT40)	22	22	



### 3.4 DUTY CYCLE

If duty cycle is  $\geq 98\%$ , duty factor is not required.  
 If duty cycle is  $< 98\%$ , duty factor shall be considered.

**IEEE 802.11a**

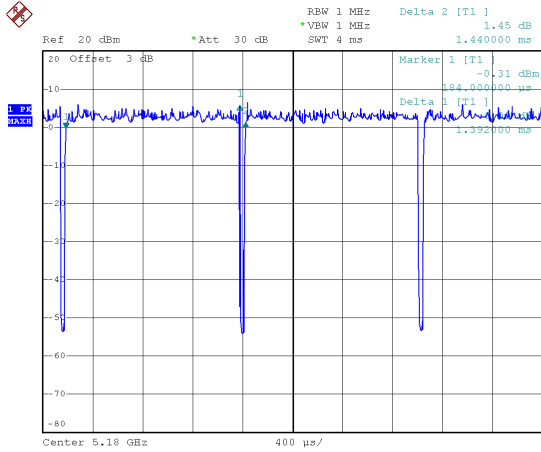

Date: 12.DEC.2018 08:16:52

Duty cycle =  $1.392 \text{ ms} / 1.440 \text{ ms} = 96.67\%$   
 Duty Factor =  $10 * \log(1 / 96.67\%) = 0.15 \text{ dB}$

**IEEE 802.11n (HT20)**

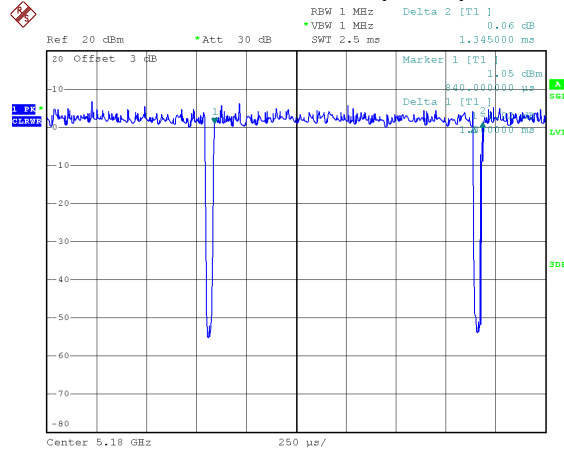

Date: 12.DEC.2018 08:17:22

Duty cycle =  $1.300 \text{ ms} / 1.345 \text{ ms} = 96.65\%$   
 Duty Factor =  $10 * \log(1 / 96.65\%) = 0.15 \text{ dB}$

**IEEE 802.11n (HT40)**

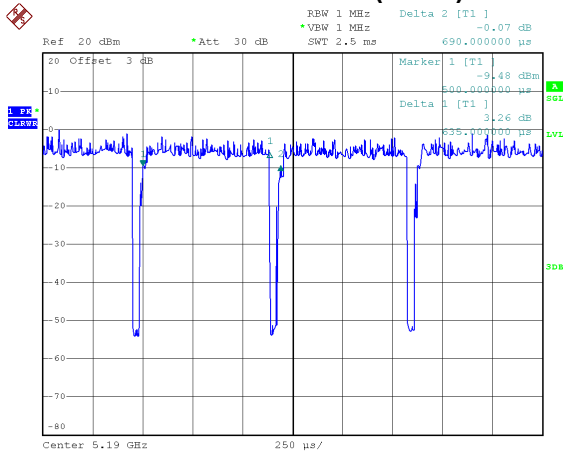

Date: 12.DEC.2018 08:17:39

Duty cycle =  $0.635 \text{ ms} / 0.690 \text{ ms} = 92.03\%$   
 Duty Factor =  $10 * \log(1 / 92.03\%) = 0.36 \text{ dB}$

**NOTE:**

For IEEE 802.11a, IEEE 802.11n (HT20):

For radiated emissions frequency above 1 GHz, the resolution bandwidth of test receiver/spectrum analyzer is 1 MHz and the video bandwidth is 1 kHz (Duty cycle  $< 98\%$ ).

For IEEE 802.11n (HT40):

For radiated emissions frequency above 1 GHz, the resolution bandwidth of test receiver/spectrum analyzer is 1 MHz and the video bandwidth is 2 kHz (Duty cycle  $< 98\%$ ).

**3.5 BLOCK DIAGRAM SHOWING THE CONFIGURATION OF SYSTEM TESTED**

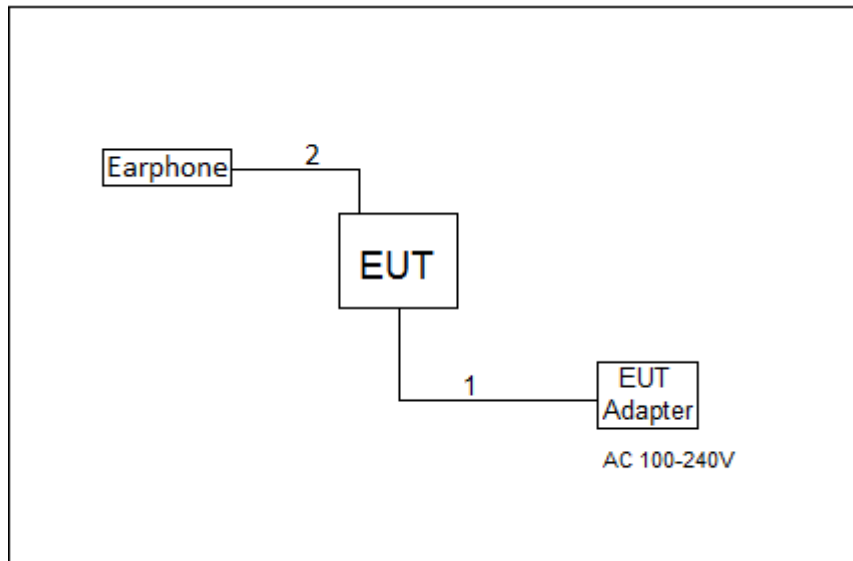

**3.6 SUPPORT UNITS**

Item	Equipment	Mfr/Brand	Model/Type No.	Series No.
-	-	-	-	-

Item	Shielded Type	Ferrite Core	Length	Note
1	NO	NO	1.2m	DC Cable
2	NO	NO	1.0m	Audio Cable

## 4. AC POWER LINE CONDUCTED EMISSIONS TEST

### 4.1 LIMIT

Frequency (MHz)	Limit (dBμV)	
	Quasi-peak	Average
0.15 - 0.5	66 – 56*	56 - 46*
0.50 - 5.0	56	46
5.0 - 30.0	60	50

NOTE:

- (1) The tighter limit applies at the band edges.
- (2) The limit of " \* " marked band means the limitation decreases linearly with the logarithm of the frequency in the range.

- (3) The test result calculated as following:

Measurement Value = Reading Level + Correct Factor

Correct Factor = Insertion Loss + Cable Loss + Attenuator Factor (if use)

Margin Level = Measurement Value – Limit Value

Sample calculations: (Refer to page 40, test result No.X.)

Reading Level		Correct Factor		Measurement Value
28.61	+	9.80	=	38.41

Measurement Value		Limit Value		Margin Level
38.41	-	57.10	=	-18.69

The following table is the setting of the receiver

Receiver Parameter	Setting
Attenuation	10 dB
Start Frequency	0.15 MHz
Stop Frequency	30 MHz
IF Bandwidth	9 KHz

### 4.2 TEST PROCEDURE

- a. The EUT was placed 0.8 meters from the horizontal ground plane with EUT being connected to the power mains through a line impedance stabilization network (LISN). All other support equipment powered from additional LISN(s). The LISN provide 50 Ohm/ 50uH of coupling impedance for the measuring instrument.
- b. Interconnecting cables that hang closer than 40 cm to the ground plane shall be folded back and forth in the center forming a bundle 30 to 40 cm long.
- c. I/O cables that are not connected to a peripheral shall be bundled in the center. The end of the cable may be terminated, if required, using the correct terminating impedance. The overall length shall not exceed 1 m.
- d. LISN at least 80 cm from nearest part of EUT chassis.
- e. For the actual test configuration, please refer to the related Item -EUT Test Photos.

### 4.3 DEVIATION FROM TEST STANDARD

No deviation

#### 4.4 TEST SETUP

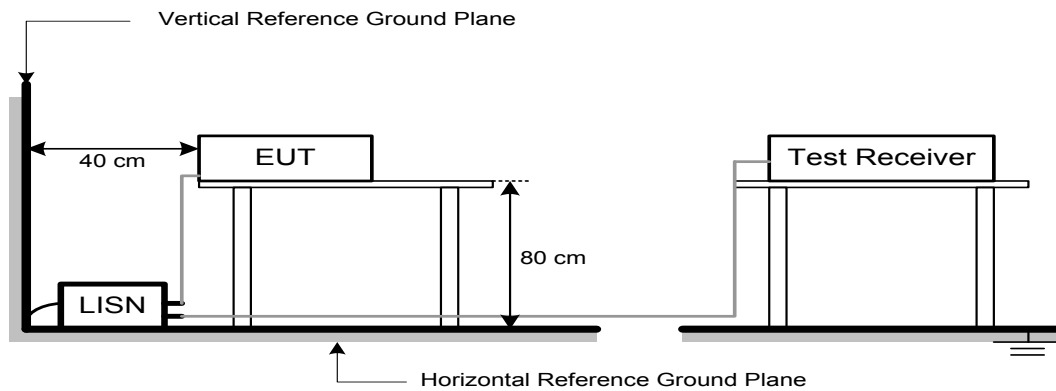

#### 4.5 EUT OPERATION CONDITIONS

The EUT was configured for testing in a typical fashion (as a customer would normally use it). The EUT has been programmed to continuously transmit during test. This operating condition was tested and used to collect the included data.

The EUT was programmed to be in continuously transmitting/TX Mode mode.

#### 4.6 EUT TEST CONDITIONS

Temperature: 25°C    Relative Humidity: 53%    Test Voltage: AC 120V/60Hz

#### 4.7 TEST RESULTS

Please refer to the APPENDIX A.

## 5. RADIATED EMISSION TEST

### 5.1 LIMIT

In case the emission fall within the restricted band specified on 15.205(a), then the 15.209(a) limit in the table below has to be followed.

#### LIMITS OF RADIATED EMISSIONS MEASUREMENT (9 kHz to 1000 MHz)

Frequency (MHz)	Field Strength (microvolts/meter)	Measurement Distance (meters)
0.009-0.490	2400/F(kHz)	300
0.490-1.705	24000/F(kHz)	30
1.705-30.0	30	30
30-88	100	3
88-216	150	3
216-960	200	3
Above 960	500	3

#### LIMITS OF UNWANTED EMISSION OUT OF THE RESTRICTED BANDS

Frequency (MHz)	EIRP Limit (dBm/MHz)	Equivalent Field Strength at 3m (dBμV/m)
5150-5250	-27	68.3
5250-5350	-27	68.3
5470-5600 5650-5725	-27	68.3
5725-5850	-27 NOTE (2)	68.3
	10 NOTE (2)	105.3
	15.6 NOTE (2)	110.9
	27 NOTE (2)	122.3

#### NOTE:

(1) The following formula is used to convert the equipment isotropic radiated power (eirp) to field

strength:  $E = \frac{1000000\sqrt{30P}}{3}$  μV/m, where P is the eirp (Watts)

(2) According to FCC 16-24, all emissions shall be limited to a level of -27 dBm/MHz at 75 MHz or more above or below the band edge increasing linearly to 10 dBm/MHz at 25 MHz above or below the band edge, and from 25 MHz above or below the band edge increasing linearly to a level of 15.6 dBm/MHz at 5 MHz above or below the band edge, and from 5 MHz above or below the band edge increasing linearly to a level of 27 dBm/MHz at the band edge.

(3) The test result calculated as following:

Measurement Value = Reading Level + Correct Factor

Correct Factor = Antenna Factor + Cable Loss - Amplifier Gain(if use)

Margin Level = Measurement Value - Limit Value

Sample calculations: (Refer to page 45, test result No.1.)

Reading Level		Correct Factor		Measurement Value
36.20	+	20.55	=	56.75

Measurement Value		Limit Value		Margin Level
56.75	-	123.41	=	-66.66

**5.2 TEST PROCEDURE**

- a. The measuring distance of 3 m shall be used for measurements. The EUT was placed on the top of a rotating table 0.8 meter above the ground at a 3 meter semi-anechoic chamber. The table was rotated 360 degrees to determine the position of the highest radiation.(below 1GHz)
- b. The measuring distance of 3 m shall be used for measurements. The EUT was placed on the top of a rotating table 1.5 meter above the ground at a 3 meter semi-anechoic chamber. The table was rotated 360 degrees to determine the position of the highest radiation.(above 1GHz)
- c. The height of the equipment or of the substitution antenna shall be 0.8m or 1.5m; the height of the test antenna shall vary between 1 m to 4 m. Both horizontal and vertical polarizations of the antenna are set to make the measurement.
- d. For each suspected emission, the EUT was arranged to its worst case and then the antenna was tuned to heights find the maximum reading (used Bore sight function).
- e. The receiver system was set to peak and average detect function and specified bandwidth with maximum hold mode when the test frequency is above 1 GHz.
- f. The initial step in collecting radiated emission data is a receiver peak detector mode pre-scanning the measurement frequency range. Significant peaks are then marked and then Quasi Peak detector mode re-measured.
- g. All readings are Peak unless otherwise stated QP in column of Note. Peak denotes that the Peak reading compliance with the QP Limits and then QP Mode measurement didn't perform. (below 1 GHz)
- h. All readings are Peak Mode value unless otherwise stated AVG in column of Note. If the Peak Mode Measured value compliance with the Peak Limits and lower than AVG Limits, the EUT shall be deemed to meet both Peak & AVG Limits and then only Peak Mode was measured, but AVG Mode didn't perform. (above 1 GHz)
- i. For the actual test configuration, please refer to the related Item –EUT Test Photos.

**5.3 DEVIATION FROM TEST STANDARD**

No deviation

**5.4 TEST SETUP**

9 kHz to 30 MHz

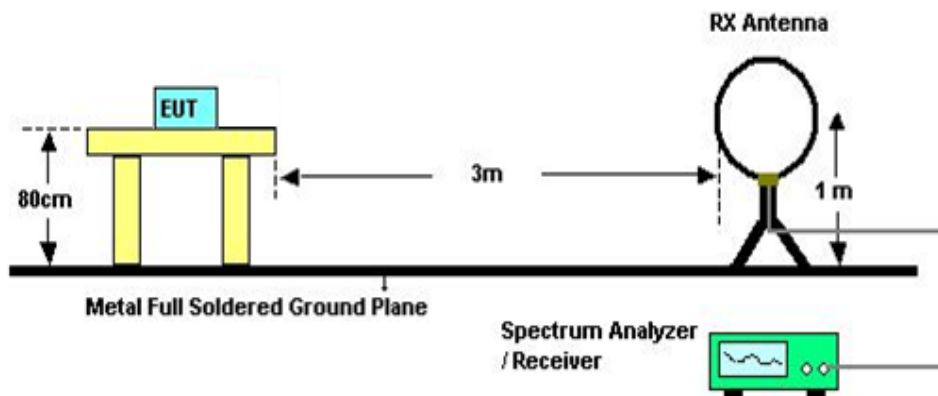

### 30 MHz to 1 GHz

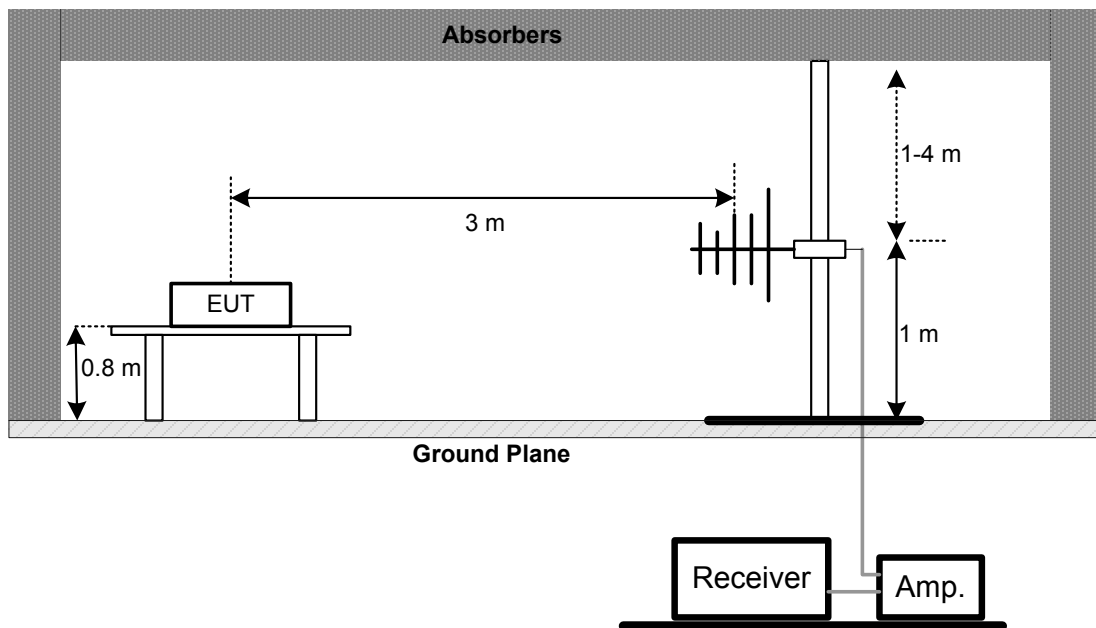

### Above 1 GHz

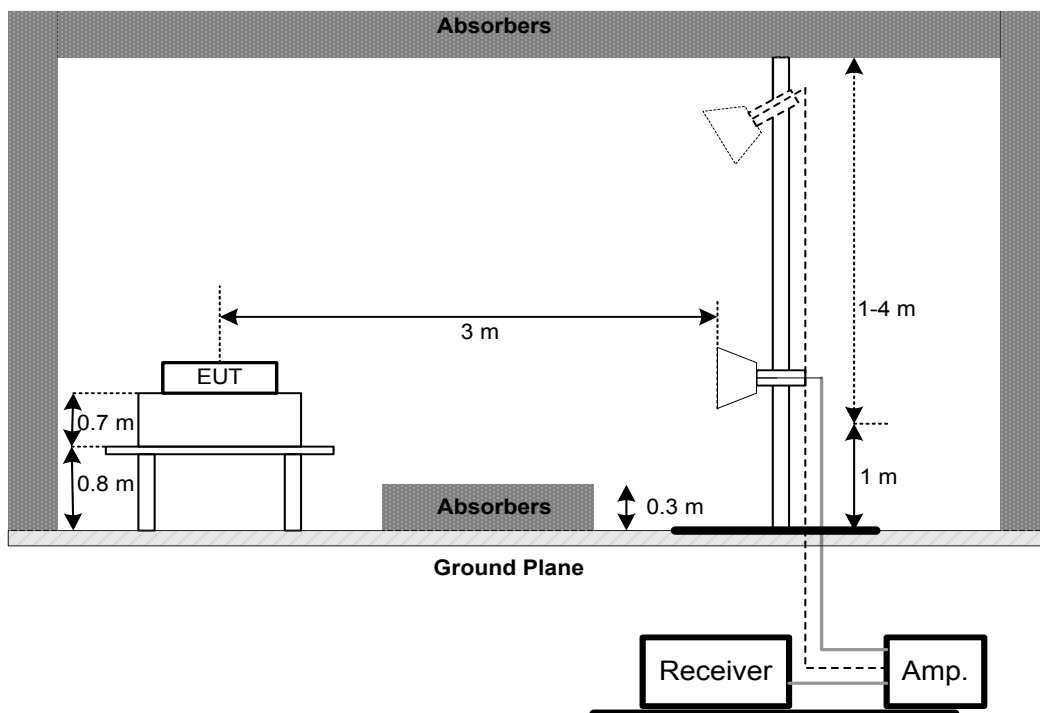

## 5.5 EUT OPERATION CONDITIONS

The EUT tested system was configured as the statements of 4.5 unless otherwise a special operating condition is specified in the follows during the testing.

## 5.6 EUT TEST CONDITIONS

Temperature: 25°C    Relative Humidity: 60%    Test Voltage: AC 120V/60Hz

## 5.7 TEST RESULTS - 9 kHz to 30 MHz

Please refer to the APPENDIX B

Remark:

- (1) The amplitude of spurious emissions which are attenuated by more than 20 dB below the permissible value has no need to be reported.
- (2) Distance extrapolation factor =  $40 \log$  (specific distance / test distance) (dB).
- (3) Limit line = specific limits (dBuV) + distance extrapolation factor.

## 5.8 TEST RESULTS - 30 MHz TO 1000 MHz

Please refer to the APPENDIX C.

## 5.9 TEST RESULTS - ABOVE 1000 MHz

Please refer to the APPENDIX D.

Remark:

- (1) No limit: This is fundamental signal, the judgment is not applicable.  
For fundamental signal judgment was referred to Peak output test.



## 6. BANDWIDTH

### 6.1 LIMIT

FCC Part15, Subpart E (15.407)			
Section	Test Item	Limit	Frequency Range (MHz)
15.407(a) 15.407(e)	26 dB Bandwidth	-	5150-5250
	26 dB Bandwidth	-	5250-5350
	26 dB Bandwidth	-	5470-5600 5650-5725
	6 dB Bandwidth	Minimum 500 kHz	5725-5850

### 6.2 TEST PROCEDURE

- a. The EUT was directly connected to the spectrum analyzer and antenna output port as show in the block diagram below
- b. a. Spectrum Setting:

Spectrum Parameter	Setting
Attenuation	Auto
Span Frequency	> 26 dB Bandwidth
RBW	300 kHz (Bandwidth 20 MHz) 1 MHz (Bandwidth 40 MHz and 80 MHz)
VBW	1 MHz (Bandwidth 20 MHz) 3 MHz (Bandwidth 40 MHz and 80 MHz)
Detector	Peak
Trace	Max Hold
Sweep Time	Auto

Spectrum Parameter	Setting
Attenuation	Auto
Span Frequency	6 dB Bandwidth
RBW	100 kHz
VBW	300 kHz
Detector	Peak
Trace	Max Hold
Sweep Time	Auto

- c. Measured the spectrum width with power higher than 26 dB below carrier

### 6.3 TEST PROCEDURE

No deviation.

#### 6.4 TEST SETUP

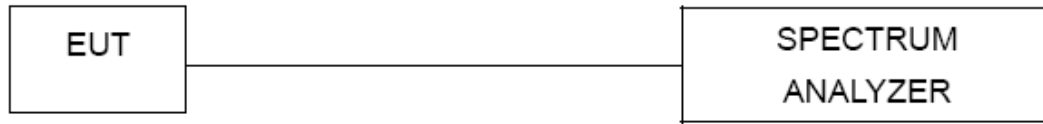

#### 6.5 EUT OPERATION CONDITIONS

The EUT was programmed to be in continuously transmitting mode.

#### 6.6 EUT TEST CONDITIONS

Temperature: 22°C    Relative Humidity: 47%    Test Voltage: AC 120V/60Hz

#### 6.7 TEST RESULTS

Please refer to the APPENDIX E.

## 7. MAXIMUM OUTPUT POWER

### 7.1 LIMIT

FCC Part15, Subpart E (15.407)			
Section	Test Item	Limit	Frequency Range (MHz)
15.407(a)	Conducted Output Power	AP device: 1 Watt (30 dBm) Client device: 250 mW (24 dBm)	5150-5250
		250 mW (24 dBm)	5250-5350
		250 mW (24 dBm)	5470-5600 5650-5725
		1 Watt (30dBm)	5725-5850

Note:

- a. For an outdoor access point operating in the band 5.15-5.25 GHz, the maximum conducted output power over the frequency band of operation shall not exceed 1 W provided the maximum antenna gain does not exceed 6 dBi. In addition, the maximum power spectral density shall not exceed 17 dBm in any 1 megahertz band. If transmitting antennas of directional gain greater than 6 dBi are used, both the maximum conducted output power and the maximum power spectral density shall be reduced by the amount in dB that the directional gain of the antenna exceeds 6 dBi. The maximum e.i.r.p. at any elevation angle above 30 degrees as measured from the horizon must not exceed 125 mW (21 dBm).
- b. For the 5.25-5.35 GHz and 5.47-5.725 GHz bands, the maximum conducted output power over the frequency bands of operation shall not exceed the lesser of 250 mW or 11 dBm + 10log B, where B is the 26dB Bandwidth in megahertz.

### 7.2 TEST PROCEDURE

- a. The EUT was directly connected to the spectrum analyzer and antenna output port as show in the block diagram below.
- b. Used spectrum analyzer band power measurement function.
- c. Spectrum Setting

Spectrum Parameter	Setting
Attenuation	Auto
Span Frequency	Encompass the entire emissions bandwidth (EBW) of the signal
RBW	= 1 MHz.
VBW	≥ 3 MHz.
Sweep points	≥ 2 x span / RBW
Detector	RMS
Trace	Trace average at least 100 traces in power averaging(rms) mode.
Sweep Time	auto

- c. Test test was performed in accordance with method of FCC KDB 789033 D02 General UNII Test Procedures New Rules v02r01.

### 7.3 DEVIATION FROM STANDARD

No deviation.

#### 7.4 TEST SETUP



#### 7.5 EUT OPERATION CONDITIONS

The EUT was programmed to be in continuously transmitting mode.

#### 7.6 EUT TEST CONDITIONS

Temperature: 22°C    Relative Humidity: 47%    Test Voltage: AC 120V/60Hz

#### 7.7 TEST RESULTS

Please refer to the APPENDIX F.

## 8. POWER SPECTRAL DENSITY TEST

### 8.1 LIMIT

FCC Part15, Subpart E (15.407)			
Section	Test Item	Limit	Frequency Range (MHz)
15.407(a)	Power Spectral Density	AP device: 17 dBm/MHz Client device: 11 dBm/MHz	5150-5250
		11 dBm/MHz	5250-5350
		11 dBm/MHz	5470-5600 5650-5725
		30 dBm/500 kHz	5725-5850

### 8.2 TEST PROCEDURE

- a. The EUT was directly connected to the spectrum analyzer and antenna output port as show in the block diagram below.
- b. Spectrum Setting

Spectrum Parameter	Setting
Attenuation	Auto
Span Frequency	Encompass the entire emissions bandwidth (EBW) of the signal
RBW	= 1 MHz.
VBW	≥ 3 MHz.
Detector	RMS
Trace average	100 trace
Sweep Time	Auto

Note:

- For UNII-3, according to KDB publication 789033 D02 General UNII Test Procedures New Rules v02r01, section II.F.5., it is acceptable to set RBW at 1 MHz and VBW at 3 MHz if the spectrum analyzer does not have 500 kHz RBW.
- The value measured with RBW=1 MHz is to be added with  $10\log(500\text{ kHz}/1\text{ MHz})$  which is -3 dB. For example, if the measured value is +10dBm using RBW=1 MHz (that is +10 dBm/MHz), then the converted value will be +7dBm/500kHz.

### 8.3 DEVIATION FROM STANDARD

No deviation.

#### 8.4 TEST SETUP

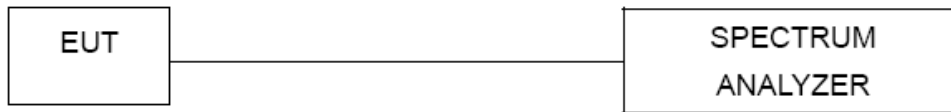

#### 8.5 EUT OPERATION CONDITIONS

The EUT was programmed to be in continuously transmitting mode.

#### 8.6 EUT TEST CONDITIONS

Temperature: 22°C    Relative Humidity: 47%    Test Voltage: AC 120V/60Hz

#### 8.7 TEST RESULTS

Please refer to the APPENDIX H.

## 9. FREQUENCY STABILITY MEASUREMENT

### 9.1 LIMIT

FCC Part15, Subpart E (15.407)			
Section	Test Item	Limit	Frequency Range (MHz)
15.407(g)	Frequency Stability	Specified in the user's manual	5150-5250
			5250-5350
			5470-5600
			5650-5725
			5725-5850

### 9.2 TEST PROCEDURE

- a. The EUT was directly connected to the spectrum analyzer and antenna output port as show in the block diagram below.
- b. Spectrum Setting:

Spectrum Parameter	Setting
Attenuation	Auto
Span Frequency	Entire absence of modulation emissions bandwidth
RBW	10 kHz
VBW	10 kHz
Sweep Time	Auto

- c. The test extreme voltage is to change the primary supply voltage from 85 to 115 percent of the nominal value.
- d. User manual temperature is -10°C~60°C.

### 9.3 DEVIATION FROM STANDARD

No deviation.

**9.4 TEST SETUP**

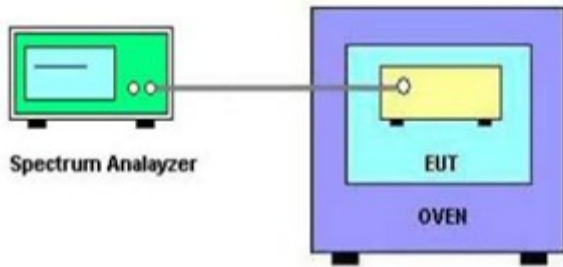

**9.5 EUT OPERATION CONDITIONS**

The EUT was programmed to be in continuously transmitting mode.

**9.6 EUT TEST CONDITIONS**

Temperature: 22°C    Relative Humidity: 47%    Test Voltage: AC 120V/60Hz

**9.7 TEST RESULTS**

Please refer to the APPENDIX I.



## 10. MEASUREMENT INSTRUMENTS LIST

### AC Power Line Conducted Emissions

Item	Kind of Equipment	Manufacturer	Type No.	Serial No.	Calibrated until
1	EMI Test Receiver	R&S	ESCI	100382	Mar. 11, 2019
2	LISN	EMCO	3816/2	52765	Mar. 11, 2019
3	50Ω Terminator	SHX	TF2-3G-A	8122901	Mar. 11, 2019
4	TWO-LINE V-NETWORK	R&S	ENV216	101447	Mar. 11, 2019
5	Measurement Software	Farad	EZ-EMC Ver.NB-03A1-01	N/A	N/A
6	Cable	N/A	RG223	12m	Mar. 23, 2019

### Radiated Emissions - 9 kHz to 30 MHz

Item	Kind of Equipment	Manufacturer	Type No.	Serial No.	Calibrated until
1	Loop Antenna	EM	EM-6876-1	230	Feb. 07, 2019
2	Cable	N/A	RG 213/U	C-102	Jun. 01, 2019
3	EMI Test Receiver	R&S	ESCI	100382	Mar. 11, 2019
4	Measurement Software	Farad	EZ-EMC Ver.NB-03A1-01	N/A	N/A

### Radiated Emissions - 30 MHz to 1 GHz

Item	Kind of Equipment	Manufacturer	Type No.	Serial No.	Calibrated until
1	Antenna	Schwarbeck	VULB9160	9160-3232	Mar. 11, 2019
2	Amplifier	HP	8447D	2944A09673	Aug. 11, 2019
3	Receiver	Agilent	N9038A	MY52130039	Aug. 11, 2019
4	Cable	emci	LMR-400(30MHz- 1GHz)(8m+5m)	N/A	May 25, 2019
5	Controller	CT	SC100	N/A	N/A
6	Controller	MF	MF-7802	MF780208416	N/A
7	Measurement Software	Farad	EZ-EMC Ver.NB-03A1-01	N/A	N/A

### Radiated Emissions - Above 1 GHz

Item	Kind of Equipment	Manufacturer	Type No.	Serial No.	Calibrated until
1	Double Ridged Guide Antenna	ETS	3115	75789	Mar. 11, 2019
2	Broad-Band Horn Antenna	Schwarzbeck	BBHA 9170	9170319	Jun. 30, 2019
3	Amplifier	Agilent	8449B	3008A02274	Mar. 11, 2019
4	Microwave Preamplifier With Adaptor	EMC INSTRUMENT	EMC2654045	980039 & HA01	Mar. 11, 2019
5	Receiver	Agilent	N9038A	MY52130039	Aug. 11, 2019
6	Controller	CT	SC100	N/A	N/A
7	Controller	MF	MF-7802	MF780208416	N/A
8	Cable	mitron	B10-01-01-12M	18072744	Jul. 30, 2019
9	Measurement Software	Farad	EZ-EMC Ver.NB-03A1-01	N/A	N/A
10	Microwave Preamplifier With Adaptor	EMC INSTRUMENT	EMC2654045	980039 & HA01	Mar. 11, 2019

Bandwidth					
Item	Kind of Equipment	Manufacturer	Type No.	Serial No.	Calibrated until
1	Spectrum Analyzer	R&S	FSP40	100185	Aug. 11, 2019

Conducted Output Power					
Item	Kind of Equipment	Manufacturer	Type No.	Serial No.	Calibrated until
1	Spectrum Analyzer	R&S	FSP40	100185	Aug. 11, 2019

Power Spectral Density					
Item	Kind of Equipment	Manufacturer	Type No.	Serial No.	Calibrated until
1	Spectrum Analyzer	R&S	FSP40	100185	Aug. 11, 2019

Frequency Stability					
Item	Kind of Equipment	Manufacturer	Type No.	Serial No.	Calibrated until
1	Spectrum Analyzer	R&S	FSP40	100185	Aug. 11, 2019
2	Precision Oven Tester	Bell	BTH-50C	20170306001	Mar. 11, 2019

REMARK: "N/A" denotes no model name, no serial no. or no calibration specified.  
 All calibration period of equipment list is one year.

**11. EUT TEST PHOTOS****AC Power Line Conducted Emissions Test Photos**

**Radiated Emissions Test Photos****9 kHz to 30 MHz**

**Radiated Emissions Test Photos**

**30 MHz to 1 GHz**

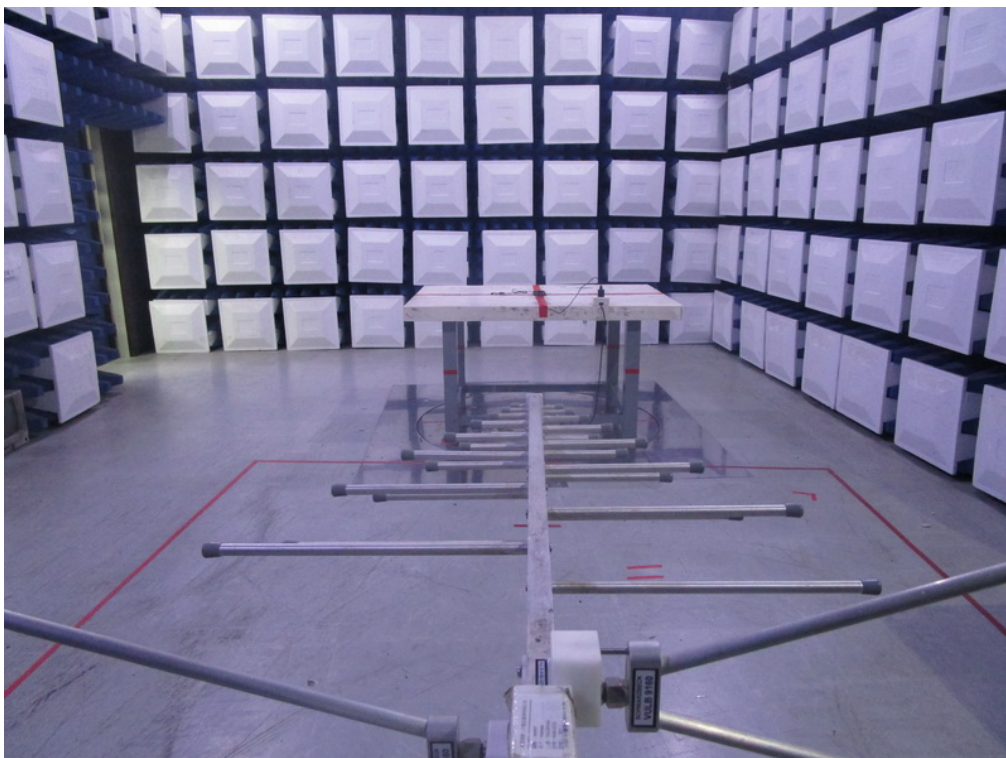
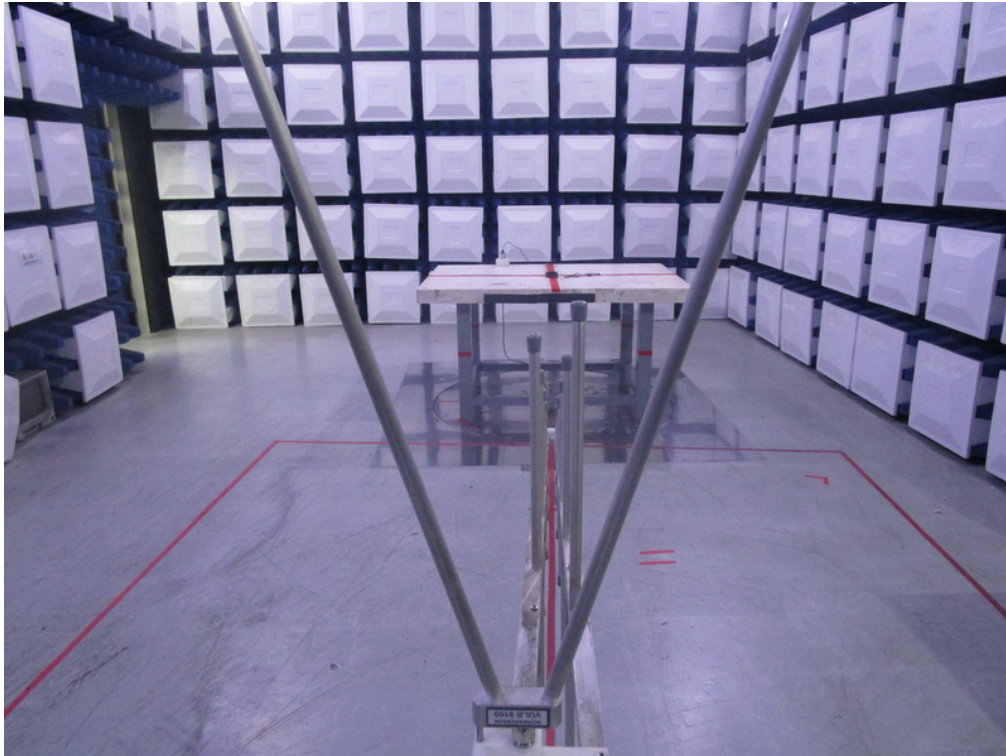

**Radiated Emissions Test Photos**  
**Above 1 GHz**

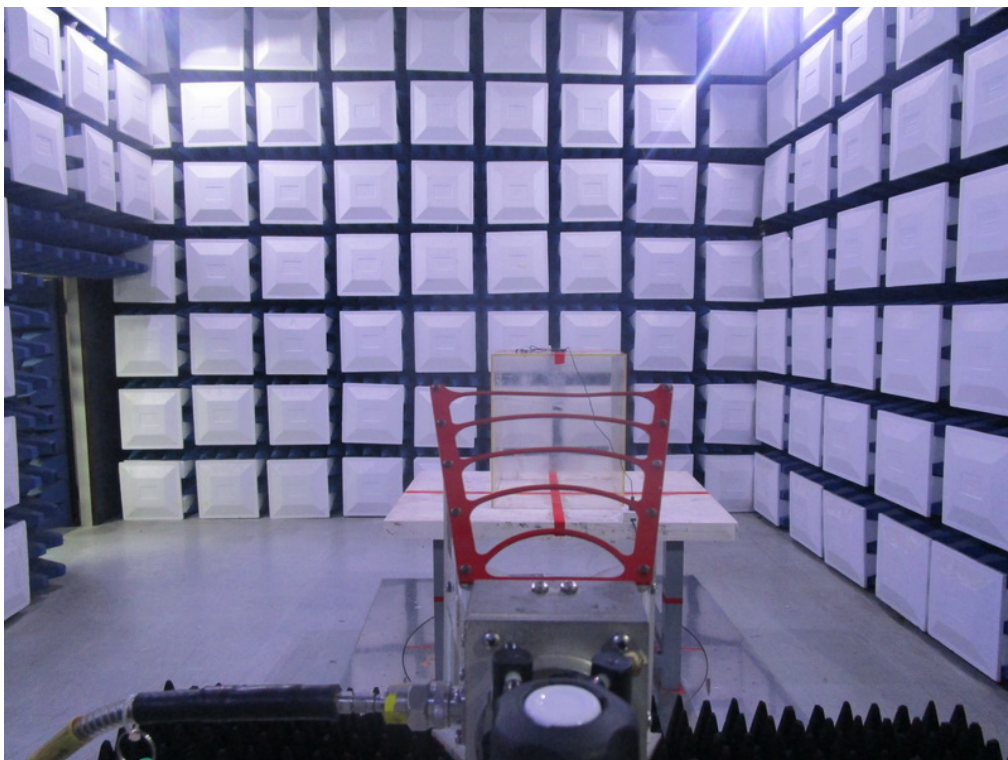
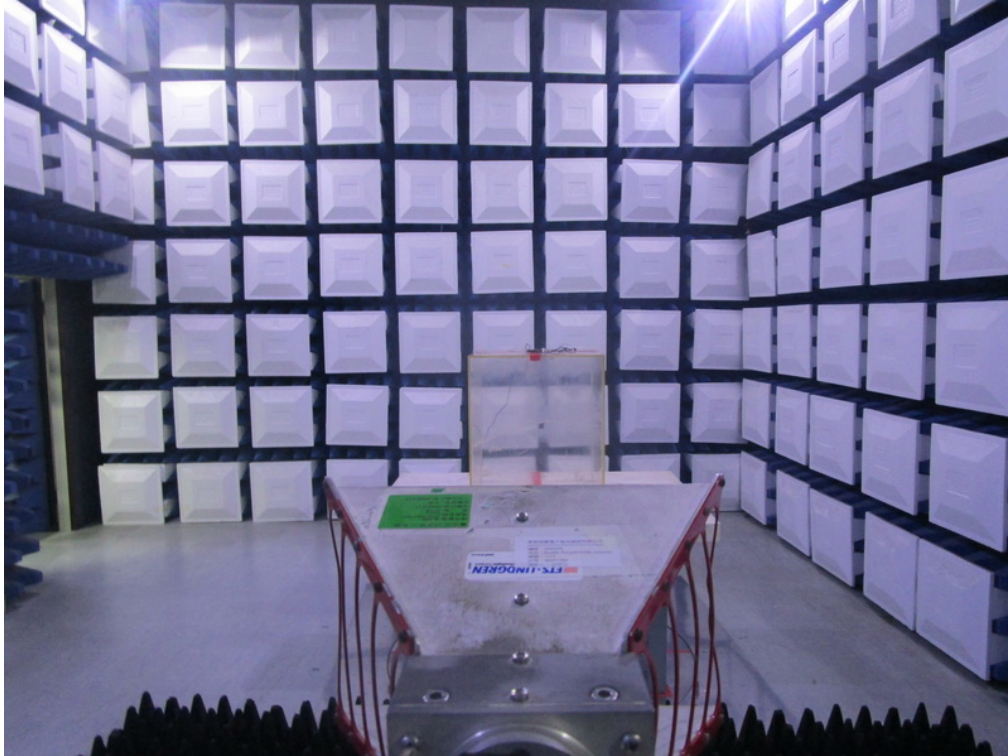

## APPENDIX A - AC POWER LINE CONDUCTED EMISSIONS

Test Mode: TX A MODE CHANNEL 40 (Supplied from USB port.)

Line

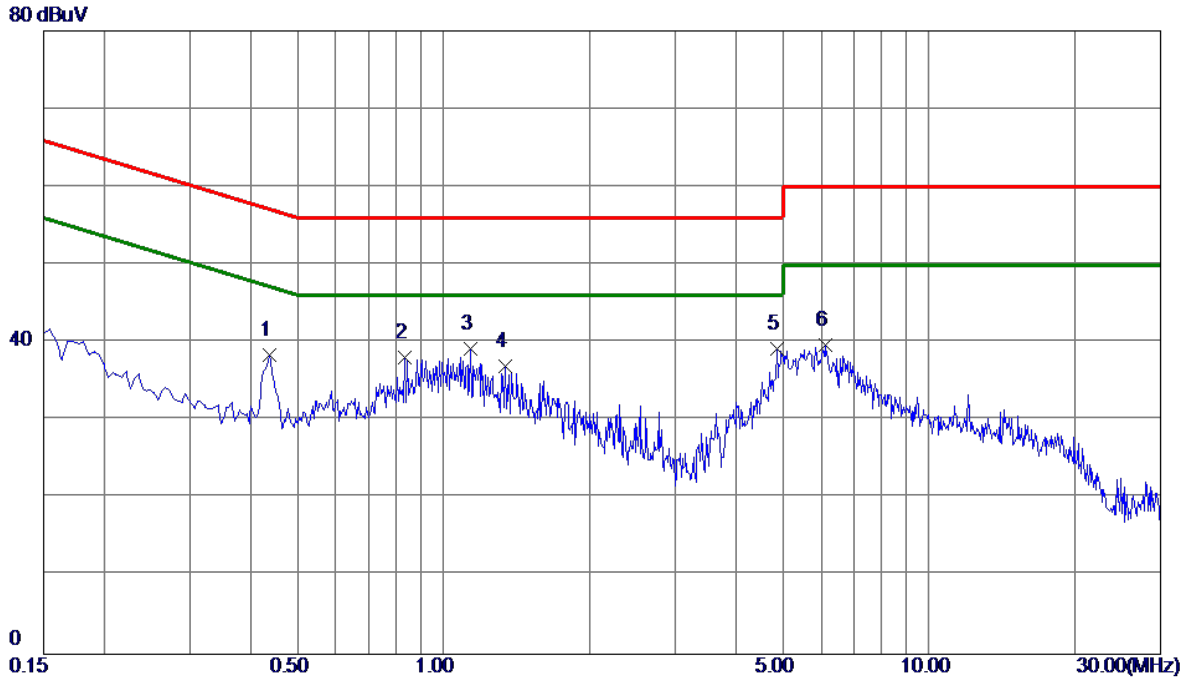

No.	Freq. MHz	Reading Level dBuV	Correct Factor dB	Measure ment dBuV	Limit dBuV	Margin dB	Detector	Comment
1	0.4380	28.61	9.80	38.41	57.10	-18.69	Peak	
2	0.8340	28.18	9.91	38.09	56.00	-17.91	Peak	
3 *	1.1355	29.32	9.93	39.25	56.00	-16.75	Peak	
4	1.3380	27.08	9.94	37.02	56.00	-18.98	Peak	
5	4.8705	29.04	10.18	39.22	56.00	-16.78	Peak	
6	6.1035	29.38	10.27	39.65	60.00	-20.35	Peak	

Note: The test result has included the cable loss.

REMARKS:

- (1) Measurement Value = Reading Level + Correct Factor.
- (2) Margin Level = Measurement Value - Limit Value.



Test Mode: TX A MODE CHANNEL 40 (Supplied from USB port.)

Neutral

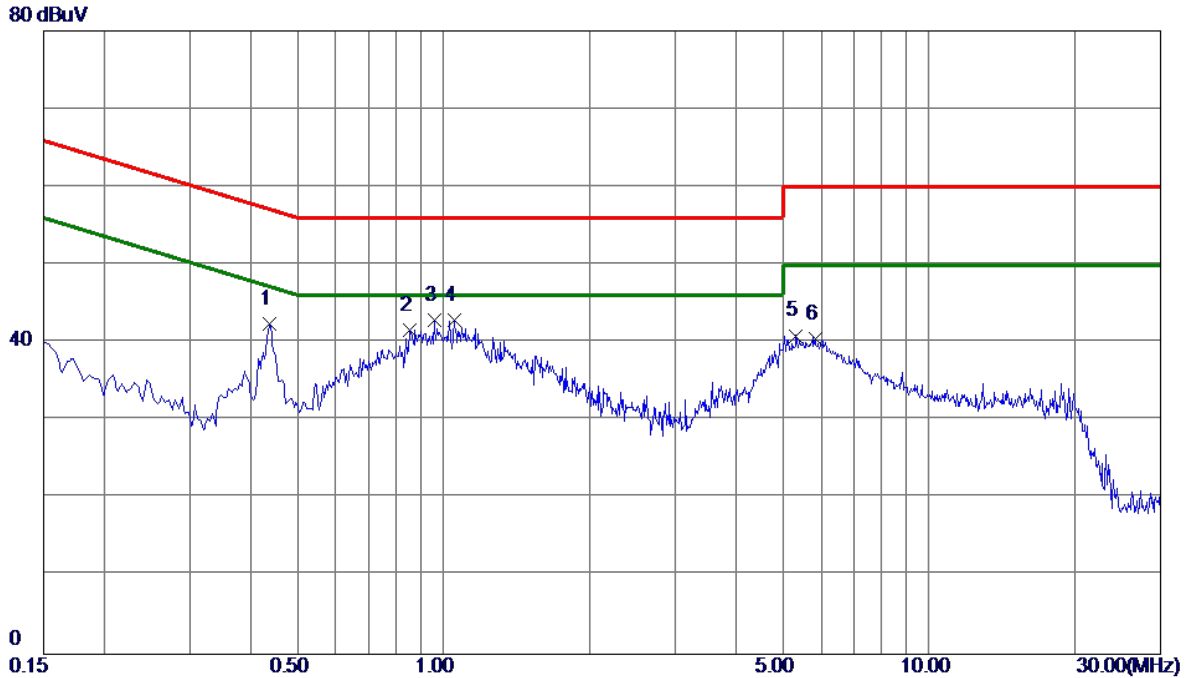

No.	Freq. MHz	Reading Level dBuV	Correct Factor dB	Measure ment dBuV	Limit dBuV	Margin dB	Detector	Comment
1	0.4380	32.52	9.95	42.47	57.10	-14.63	Peak	
2	0.8520	31.56	10.09	41.65	56.00	-14.35	Peak	
3	0.9555	32.72	10.11	42.83	56.00	-13.17	Peak	
4 *	1.0500	32.77	10.12	42.89	56.00	-13.11	Peak	
5	5.3205	30.45	10.43	40.88	60.00	-19.12	Peak	
6	5.8335	30.02	10.48	40.50	60.00	-19.50	Peak	

Note: The test result has included the cable loss.

REMARKS:

- (1) Measurement Value = Reading Level + Correct Factor.
- (2) Margin Level = Measurement Value - Limit Value.

Test Mode: TX A MODE CHANNEL 40 (Supplied from adapter.)

Line

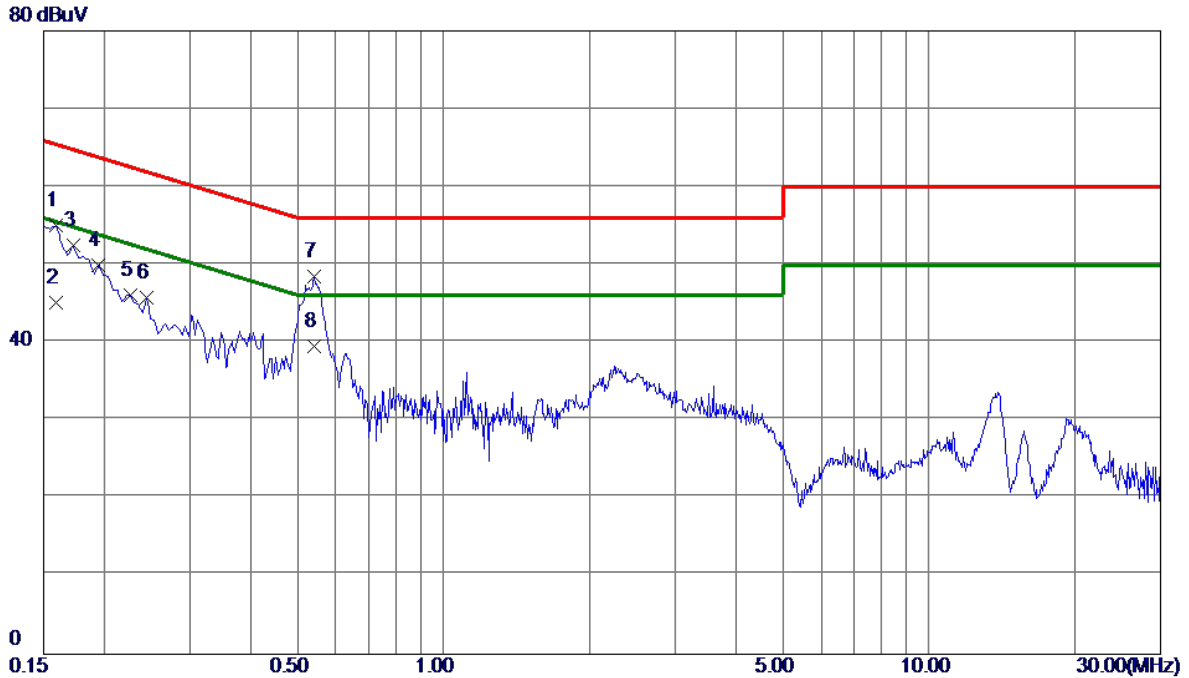

No.	Freq. MHz	Reading Level dBuV	Correct Factor dB	Measurement dBuV	Limit dBuV	Margin dB	Detector	Comment
1	0.1590	45.28	9.82	55.10	65.52	-10.42	Peak	
2	0.1590	35.30	9.82	45.12	55.52	-10.40	AVG	
3	0.1725	42.60	9.82	52.42	64.84	-12.42	Peak	
4	0.1949	40.02	9.82	49.84	63.83	-13.99	Peak	
5	0.2268	36.23	9.82	46.05	62.57	-16.52	Peak	
6	0.2445	35.92	9.82	45.74	61.94	-16.20	Peak	
7	0.5415	38.71	9.81	48.52	56.00	-7.48	Peak	
8 *	0.5415	29.70	9.81	39.51	46.00	-6.49	AVG	

Note: The test result has included the cable loss.

REMARKS:

- (1) Measurement Value = Reading Level + Correct Factor.
- (2) Margin Level = Measurement Value - Limit Value.

Test Mode: TX A MODE CHANNEL 40 (Supplied from adapter.)

### Neutral

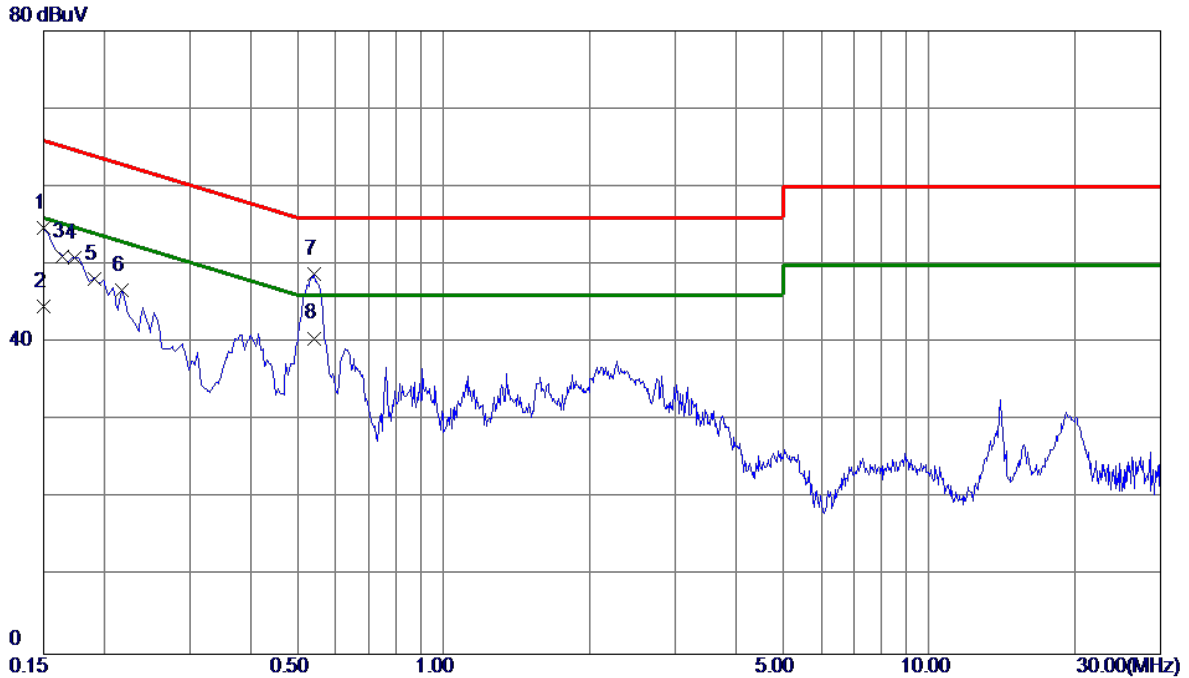

No.	Freq. MHz	Reading Level dBuV	Correct Factor dB	Measure ment dBuV	Limit dBuV	Margin dB	Detector	Comment
1	0.1500	44.76	9.91	54.67	66.00	-11.33	Peak	
2	0.1500	34.80	9.91	44.71	56.00	-11.29	AVG	
3	0.1641	41.14	9.91	51.05	65.25	-14.20	Peak	
4	0.1740	41.02	9.91	50.93	64.77	-13.84	Peak	
5	0.1914	38.25	9.91	48.16	63.98	-15.82	Peak	
6	0.2175	36.86	9.91	46.77	62.91	-16.14	Peak	
7	0.5415	38.91	9.96	48.87	56.00	-7.13	Peak	
8 *	0.5415	30.60	9.96	40.56	46.00	-5.44	AVG	

Note: The test result has included the cable loss.

**REMARKS:**

- (1) Measurement Value = Reading Level + Correct Factor.
- (2) Margin Level = Measurement Value - Limit Value.

## APPENDIX B - RADIATED EMISSION - 9 KHZ TO 30 MHZ

Test Mode: TX n(HT20) MODE CHANNEL

Ant 0°

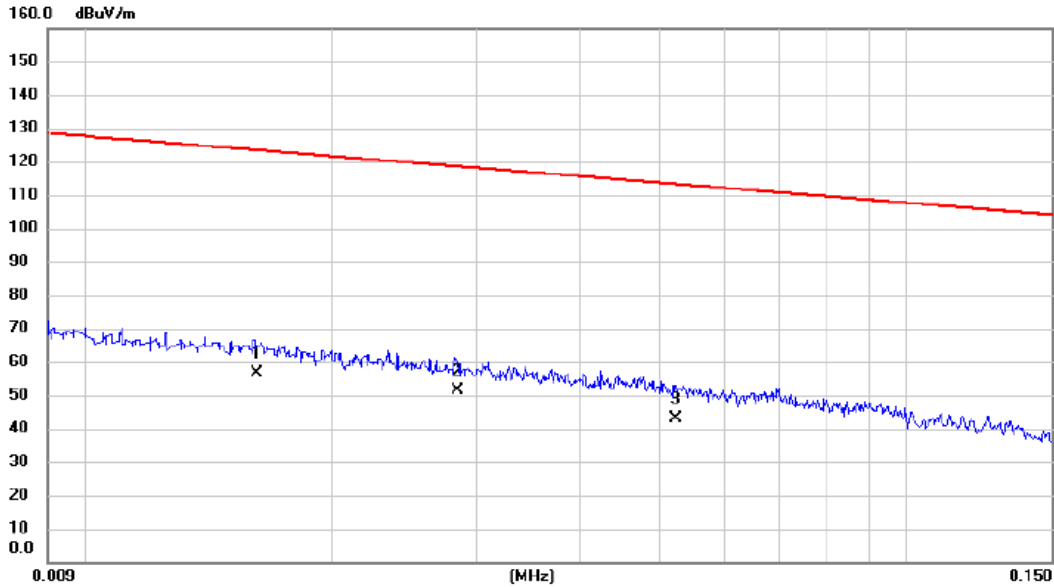

No.	Mk.	Freq.	Reading Level	Correct Factor	Measurement	Limit	Margin	Detector	Comment
		MHz	dBuV	dB	dBuV/m	dBuV/m	dB		
1	*	0.012	36.20	20.55	56.75	123.41	-66.66	AVG	
2		0.025	31.60	19.88	51.48	118.54	-67.06	AVG	
3		0.050	23.70	19.48	43.18	113.22	-70.04	AVG	

REMARKS:

- (1) Measurement Value = Reading Level + Correct Factor.
- (2) Margin Level = Measurement Value - Limit Value.

Test Mode: TX n(HT20) MODE CHANNEL

Ant 0°

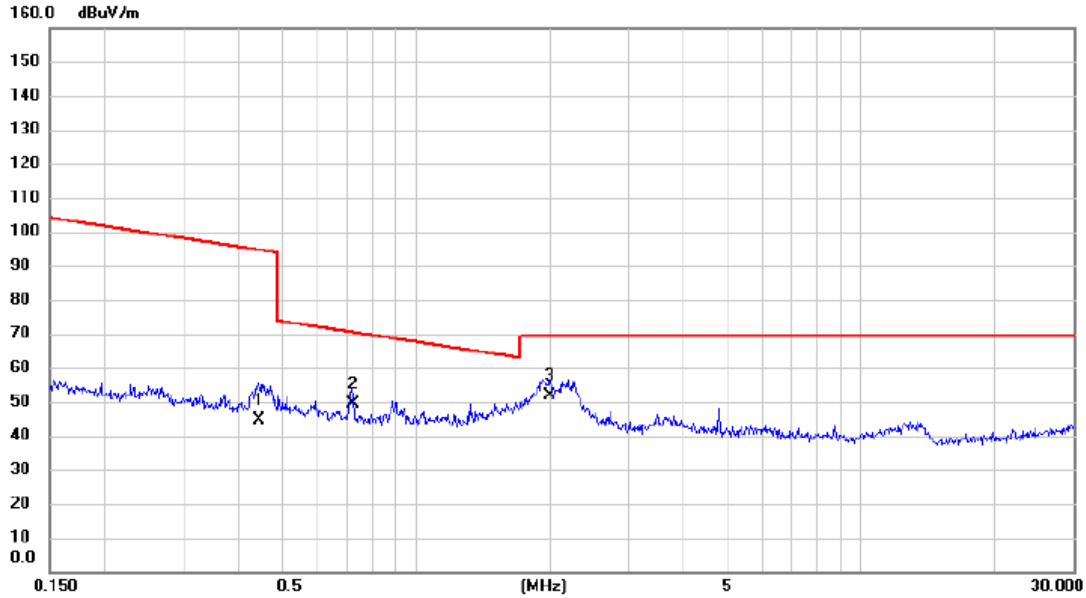

No.	Mk.	Freq.	Reading Level	Correct Factor	Measurement	Limit	Margin	Detector	Comment
		MHz	dBuV	dB	dBuV/m	dBuV/m	dB		
1		0.4421	27.50	16.98	44.48	94.69	-50.21	AVG	
2		0.7198	32.40	16.89	49.29	70.46	-21.17	QP	
3	*	2.0011	34.50	17.12	51.62	69.54	-17.92	QP	

REMARKS:

- (1) Measurement Value = Reading Level + Correct Factor.
- (2) Margin Level = Measurement Value - Limit Value.

Test Mode: TX n(HT20) MODE CHANNEL

Ant 90°

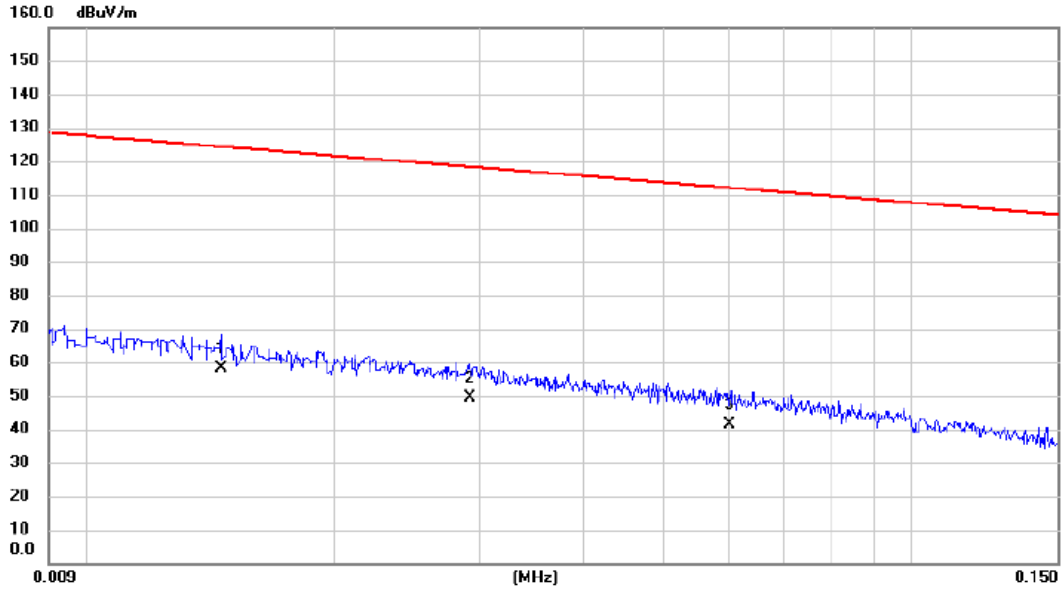

No.	Mk.	Freq.	Reading Level	Correct Factor	Measurement	Limit	Margin	Detector	Comment
		MHz	dBuV	dB	dBuV/m	dBuV/m	dB		
1	*	0.0146	37.60	20.78	58.38	124.32	-65.94	AVG	
2		0.0292	29.40	19.87	49.27	118.30	-69.03	AVG	
3		0.0601	22.20	19.33	41.53	112.03	-70.50	AVG	

REMARKS:

- (1) Measurement Value = Reading Level + Correct Factor.
- (2) Margin Level = Measurement Value - Limit Value.

Test Mode: TX n(HT20) MODE CHANNEL

Ant 90°

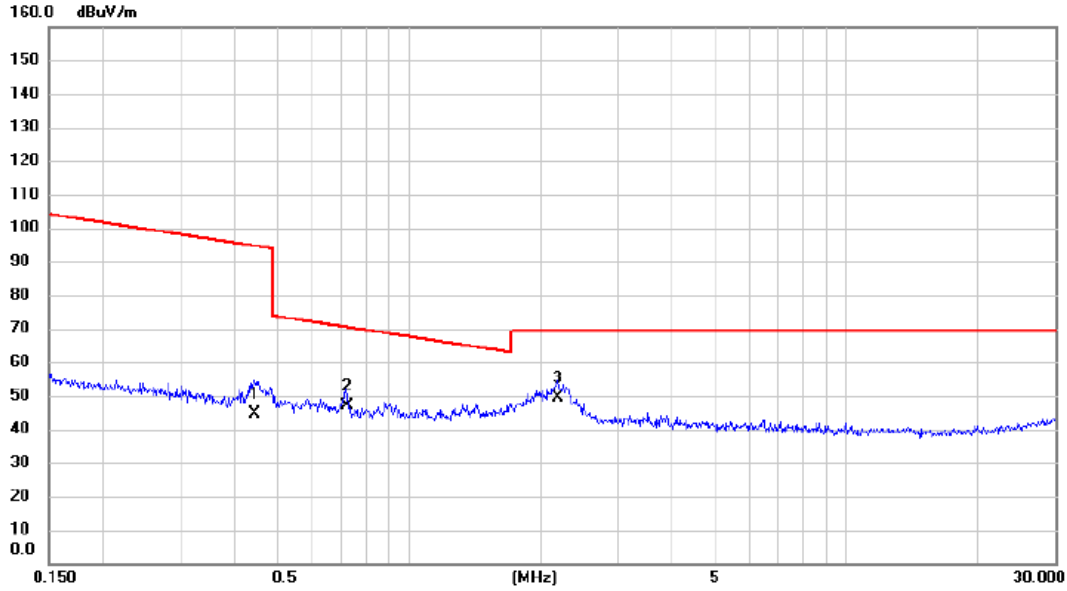

No.	Mk.	Freq. MHz	Reading Level dBuV	Correct Factor dB	Measure- ment dBuV/m	Limit dBuV/m	Margin dB	Detector	Comment
1		0.4421	27.60	16.98	44.58	94.69	-50.11	AVG	
2		0.7198	30.20	16.89	47.09	70.46	-23.37	QP	
3	*	2.1898	32.40	17.01	49.41	69.54	-20.13	QP	

REMARKS:

- (1) Measurement Value = Reading Level + Correct Factor.
- (2) Margin Level = Measurement Value - Limit Value.



## APPENDIX C - RADIATED EMISSION - 30 MHZ TO 1 GHZ

Test Mode: TX n(HT20) MODE CHANNEL

Vertical

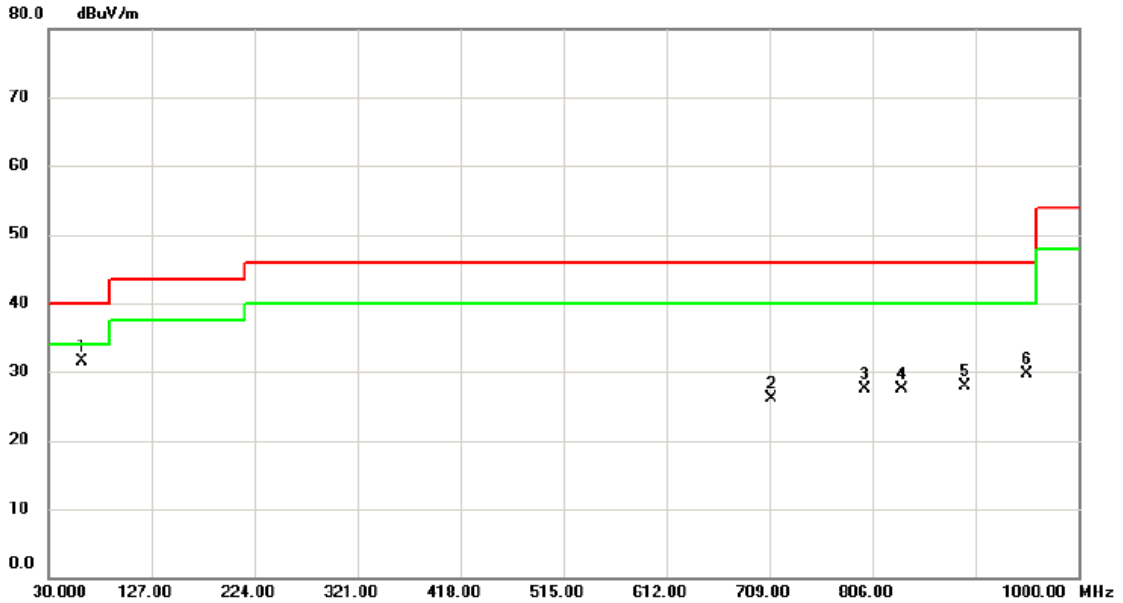

No. Mk.	Freq. MHz	Reading Level dBuV	Correct Factor dB	Measurement dBuV/m	Limit dBuV/m	Margin dB	Detector	Antenna Height cm	Table Degree	Comment
1 *	62.010	47.62	-16.02	31.60	40.00	-8.40	peak			
2	710.455	29.11	-3.01	26.10	46.00	-19.90	peak			
3	799.210	28.65	-1.08	27.57	46.00	-18.43	peak			
4	833.160	29.13	-1.56	27.57	46.00	-18.43	peak			
5	893.785	28.62	-0.75	27.87	46.00	-18.13	peak			
6	951.015	28.27	1.39	29.66	46.00	-16.34	peak			

REMARKS:

- (1) Measurement Value = Reading Level + Correct Factor.
- (2) Margin Level = Measurement Value - Limit Value.

Test Mode: TX n(HT20) MODE CHANNEL

Horizontal

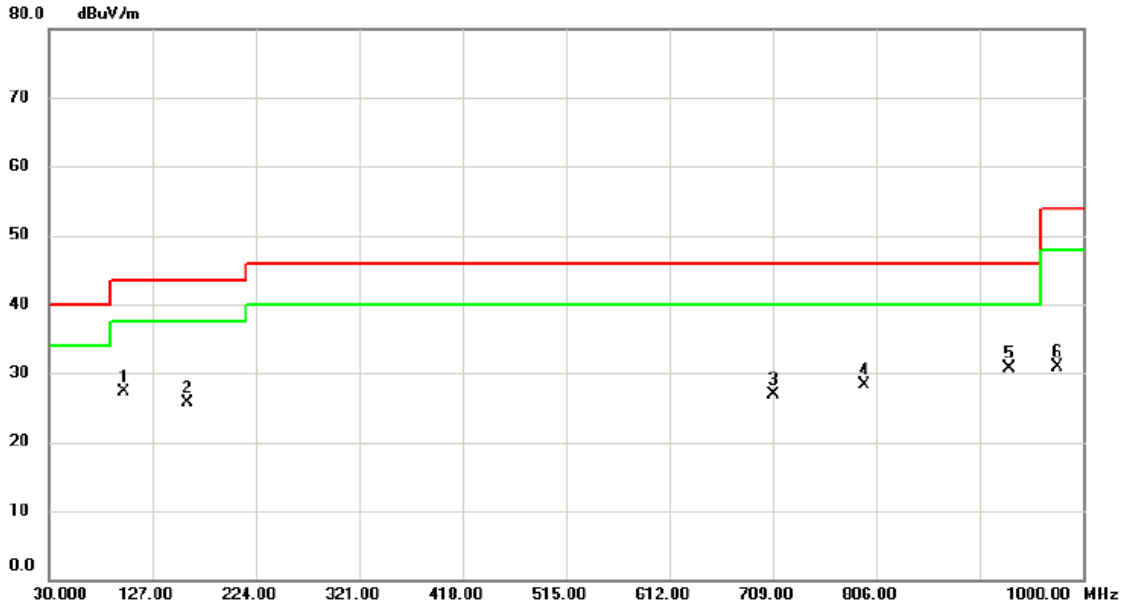

No.	Mk.	Freq. MHz	Reading Level dBuV	Correct Factor dB	Measure- ment dBuV/m	Limit dBuV/m	Margin dB	Antenna Height cm	Table Degree degree	Comment
1		100.325	45.59	-18.22	27.37	43.50	-16.13			peak
2		159.980	36.37	-10.60	25.77	43.50	-17.73			peak
3		709.000	29.98	-2.98	27.00	46.00	-19.00			peak
4		795.330	29.66	-1.32	28.34	46.00	-17.66			peak
5*		931.130	30.13	0.66	30.79	46.00	-15.21			peak
6		975.750	30.07	0.80	30.87	54.00	-23.13			peak

REMARKS:

- (1) Measurement Value = Reading Level + Correct Factor.
- (2) Margin Level = Measurement Value - Limit Value.

## APPENDIX D - RADIATED EMISSION - ABOVE 1000 MHZ

Orthogonal Axis	X
Test Mode	UNII-1_TX A Mode 5180 MHz

**Vertical**

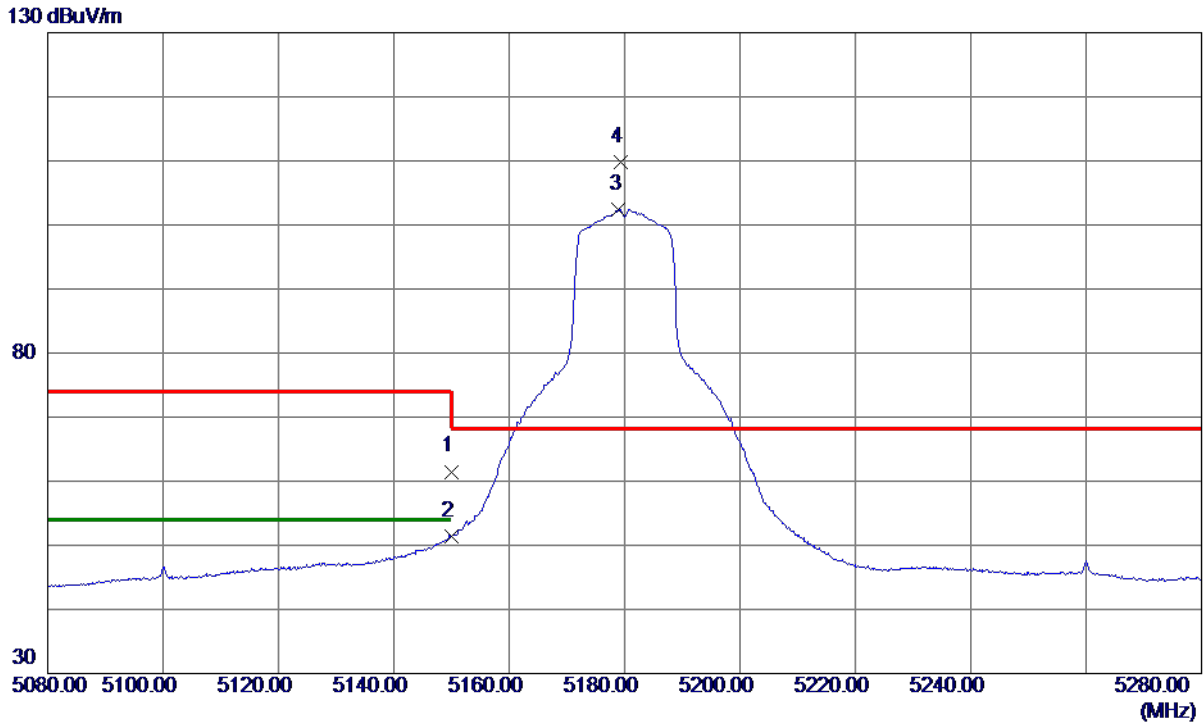

No.	Freq. MHz	Reading Level dBuV/m	Correct Factor dB	Measure ment dBuV/m	Limit dBuV/m	Margin dB	Detector	Comment
1	5150.0000	46.59	14.91	61.50	74.00	-12.50	Peak	
2	5150.0000	36.54	14.91	51.45	54.00	-2.55	AVG	
3	5179.0000	87.42	14.97	102.39	999.00	-896.61	AVG	No Limit
4 *	5179.3000	94.86	14.97	109.83	68.30	41.53	Peak	No Limit

**REMARKS:**

- (1) Measurement Value = Reading Level + Correct Factor.
- (2) Margin Level = Measurement Value - Limit Value.

Orthogonal Axis	X
Test Mode	UNII-1_TX A Mode 5180 MHz

**Vertical**

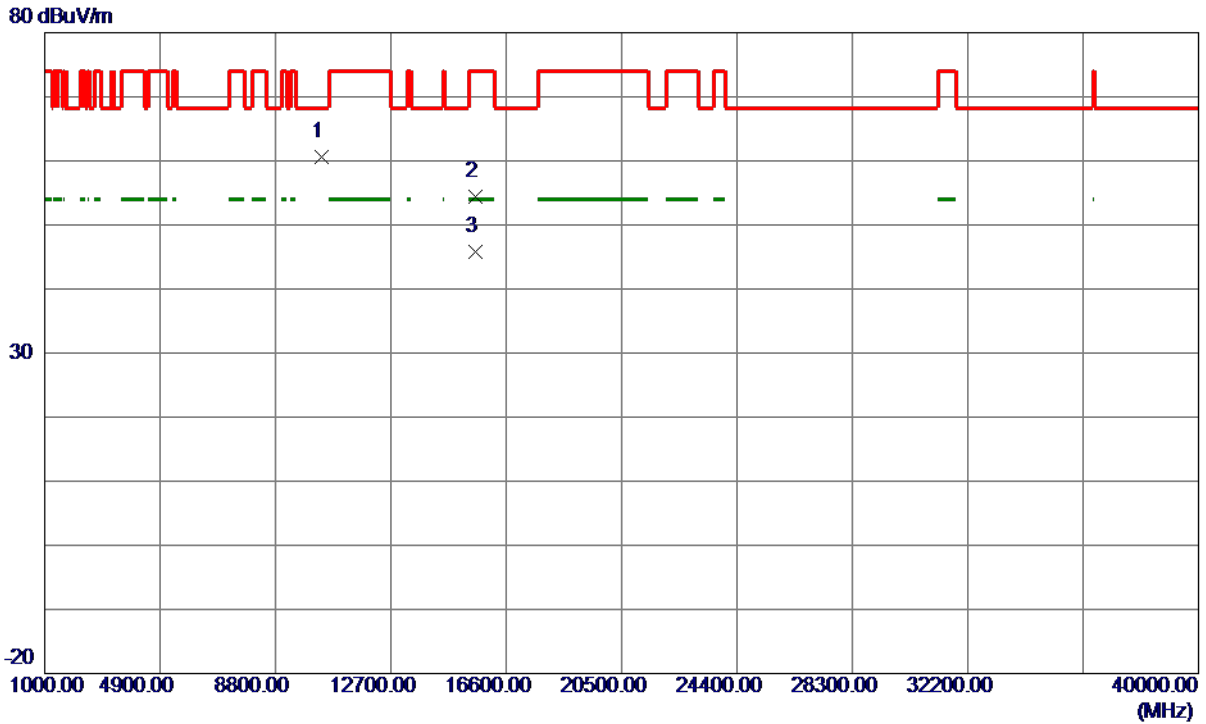

No.	Freq. MHz	Reading Level dBuV/m	Correct Factor dB	Measure ment dBuV/m	Limit dBuV/m	Margin dB	Detector	Comment
1 *	10360.3000	47.65	12.89	60.54	68.30	-7.76	Peak	
2	15539.2200	37.80	16.57	54.37	74.00	-19.63	Peak	
3	15541.9100	29.17	16.57	45.74	54.00	-8.26	AVG	

**REMARKS:**

- (1) Measurement Value = Reading Level + Correct Factor.
- (2) Margin Level = Measurement Value - Limit Value.

Orthogonal Axis	X
Test Mode	UNII-1_TX A Mode 5180 MHz

### Horizontal

130 dBuV/m

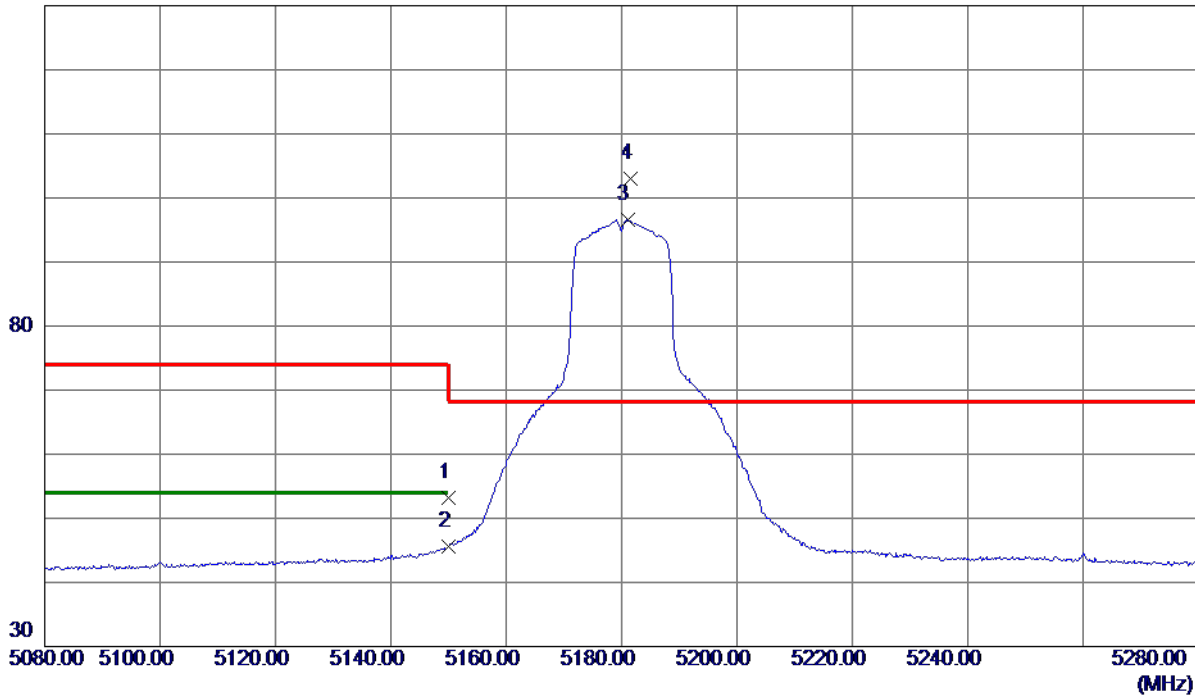

No.	Freq. MHz	Reading Level dBuV/m	Correct Factor dB	Measure ment dBuV/m	Limit dBuV/m	Margin dB	Detector	Comment
1	5150.0000	38.38	14.91	53.29	74.00	-20.71	Peak	
2	5150.0000	30.64	14.91	45.55	54.00	-8.45	AVG	
3	5181.0000	81.69	14.97	96.66	999.00	-902.34	AVG	No Limit
4 *	5181.5000	88.01	14.98	102.99	68.30	34.69	Peak	No Limit

**REMARKS:**

- (1) Measurement Value = Reading Level + Correct Factor.
- (2) Margin Level = Measurement Value - Limit Value.

Orthogonal Axis	X
Test Mode	UNII-1_TX A Mode 5180 MHz

### Horizontal

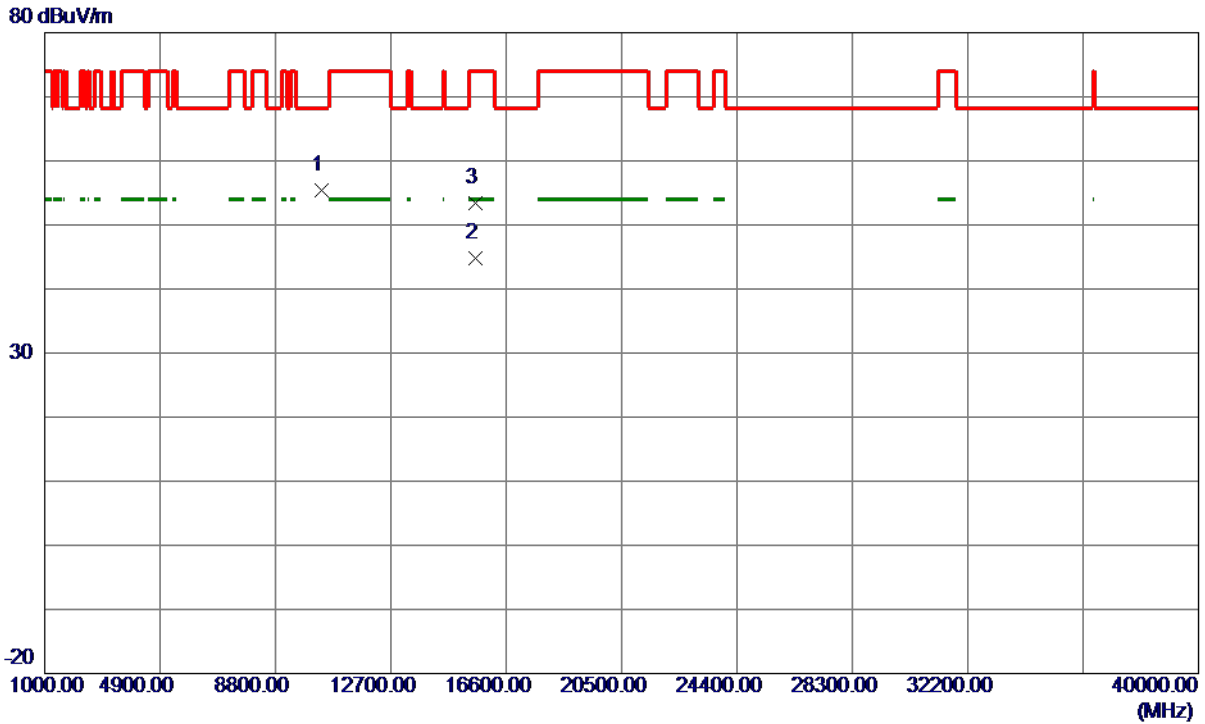

No.	Freq. MHz	Reading Level dBuV/m	Correct Factor dB	Measure ment dBuV/m	Limit dBuV/m	Margin dB	Detector	Comment
1	10363.5100	42.56	12.90	55.46	68.30	-12.84	Peak	
2 *	15539.7000	28.26	16.57	44.83	54.00	-9.17	AVG	
3	15540.5700	36.92	16.57	53.49	74.00	-20.51	Peak	

**REMARKS:**

- (1) Measurement Value = Reading Level + Correct Factor.
- (2) Margin Level = Measurement Value - Limit Value.



Orthogonal Axis	X
Test Mode	UNII-1_TX A Mode 5200 MHz

**Vertical**

130 dBuV/m

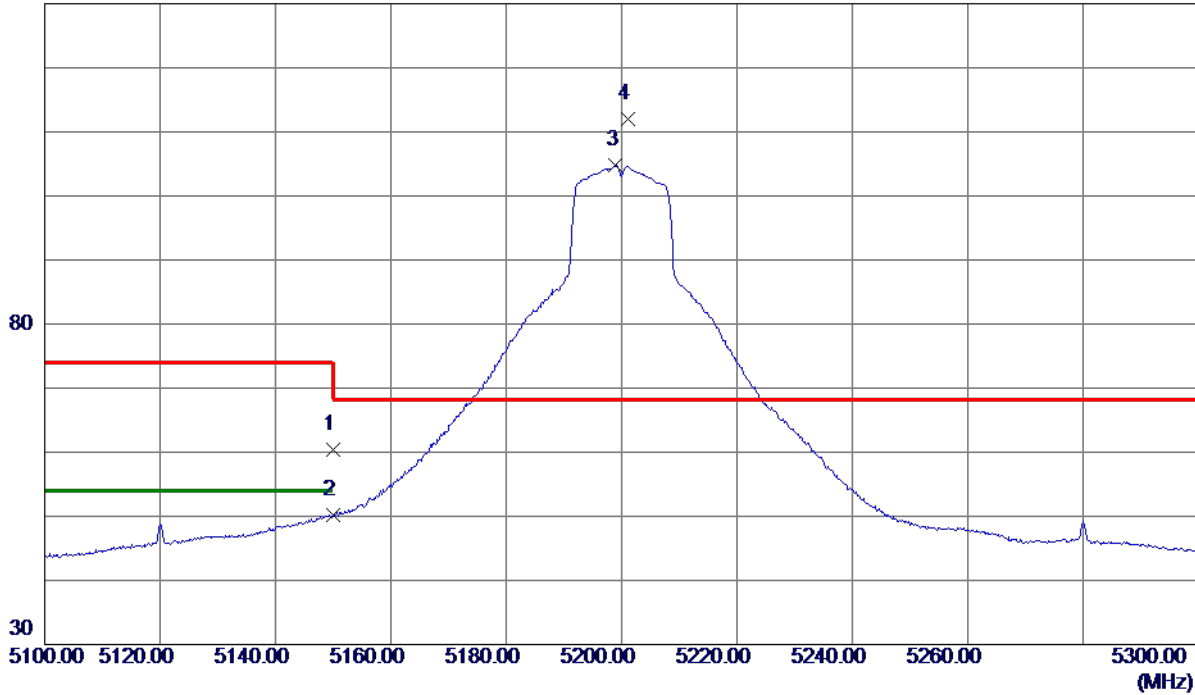

No.	Freq. MHz	Reading Level dBuV/m	Correct Factor dB	Measure ment dBuV/m	Limit dBuV/m	Margin dB	Detector	Comment
1	5150.0000	45.41	14.91	60.32	74.00	-13.68	Peak	
2	5150.0000	35.21	14.91	50.12	54.00	-3.88	AVG	
3	5199.0000	89.71	15.01	104.72	999.00	-894.28	AVG	No Limit
4 *	5201.2000	96.96	15.02	111.98	68.30	43.68	Peak	No Limit

**REMARKS:**

- (1) Measurement Value = Reading Level + Correct Factor.
- (2) Margin Level = Measurement Value - Limit Value.

Orthogonal Axis	X
Test Mode	UNII-1_TX A Mode 5200 MHz

**Vertical**

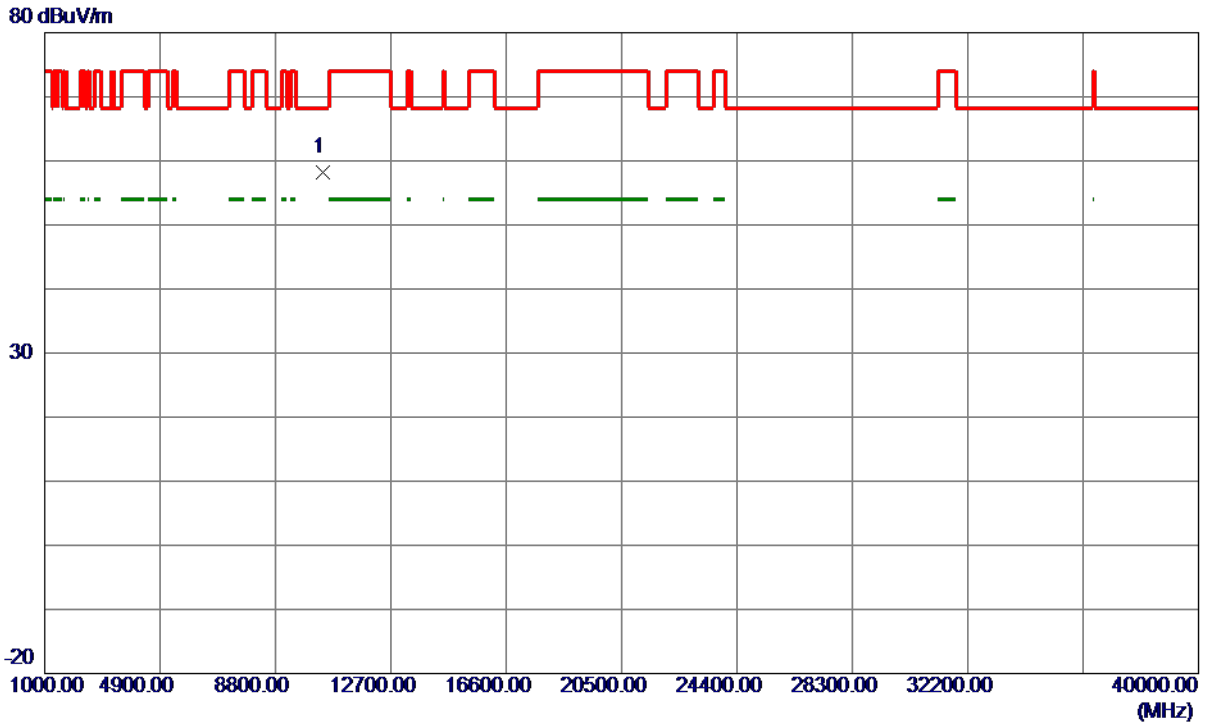

No.	Freq. MHz	Reading Level dBuV/m	Correct Factor dB	Measure ment dBuV/m	Limit dBuV/m	Margin dB	Detector	Comment
1 *	10399.7699	45.20	12.97	58.17	68.30	-10.13	Peak	

**REMARKS:**

- (1) Measurement Value = Reading Level + Correct Factor.
- (2) Margin Level = Measurement Value - Limit Value.

Orthogonal Axis	X
Test Mode	UNII-1_TX A Mode 5200 MHz

Horizontal

130 dBuV/m

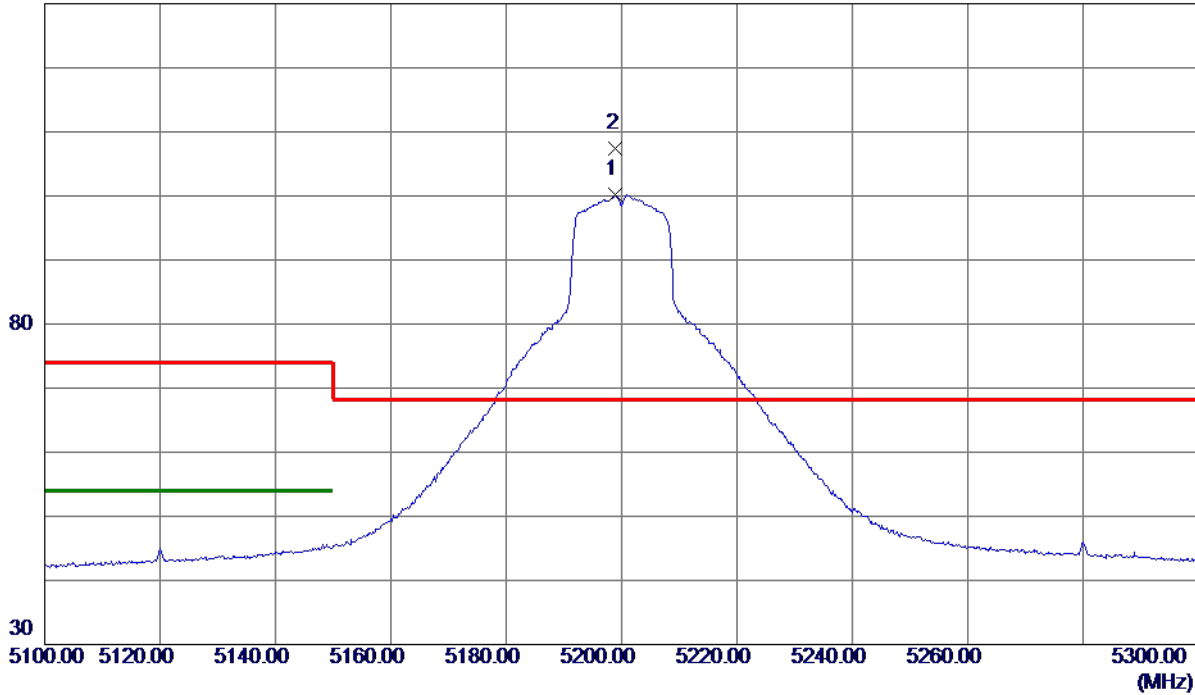

No.	Freq. MHz	Reading Level dBuV/m	Correct Factor dB	Measure ment dBuV/m	Limit dBuV/m	Margin dB	Detector	Comment
1	5198.9000	85.14	15.01	100.15	999.00	-898.85	AVG	No Limit
2 *	5199.0000	92.32	15.01	107.33	68.30	39.03	Peak	No Limit

REMARKS:

- (1) Measurement Value = Reading Level + Correct Factor.
- (2) Margin Level = Measurement Value - Limit Value.

Orthogonal Axis	X
Test Mode	UNII-1_TX A Mode 5200 MHz

**Horizontal**

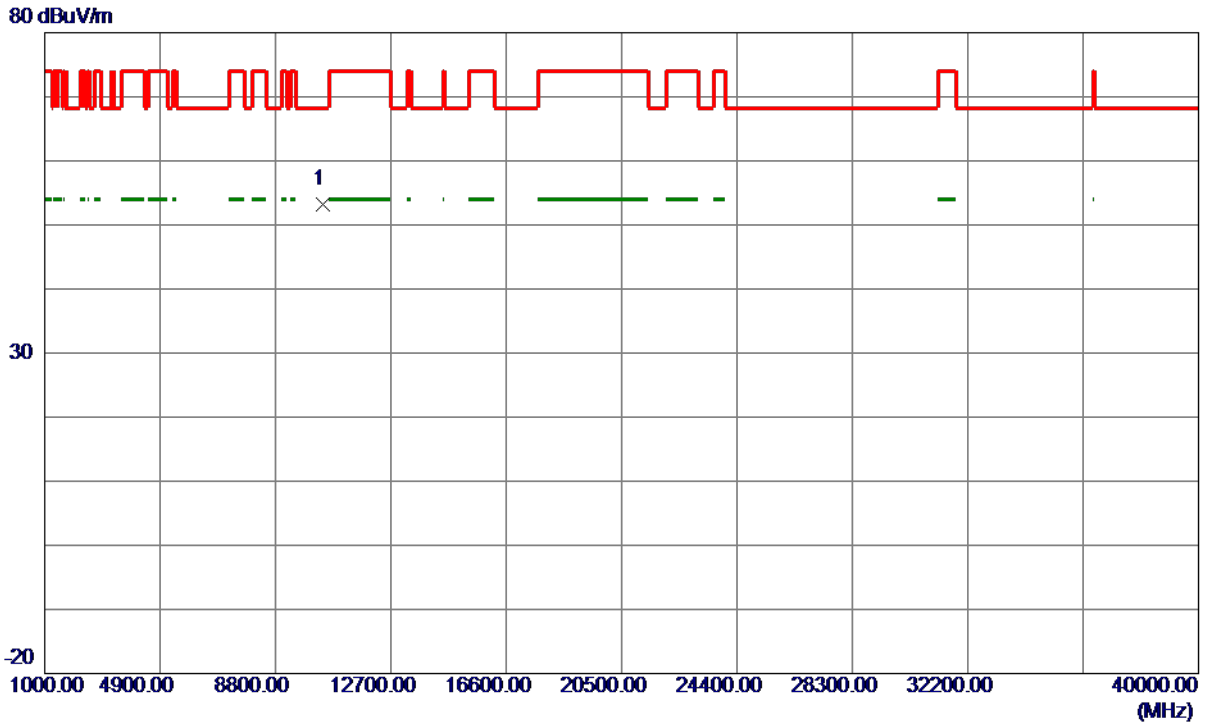

No.	Freq. MHz	Reading Level dBuV/m	Correct Factor dB	Measure ment dBuV/m	Limit dBuV/m	Margin dB	Detector	Comment
1 *	10397.1200	40.25	12.97	53.22	68.30	-15.08	Peak	

**REMARKS:**

- (1) Measurement Value = Reading Level + Correct Factor.
- (2) Margin Level = Measurement Value - Limit Value.

Orthogonal Axis	X
Test Mode	UNII-1_TX A Mode 5240 MHz

**Vertical**

130 dBuV/m

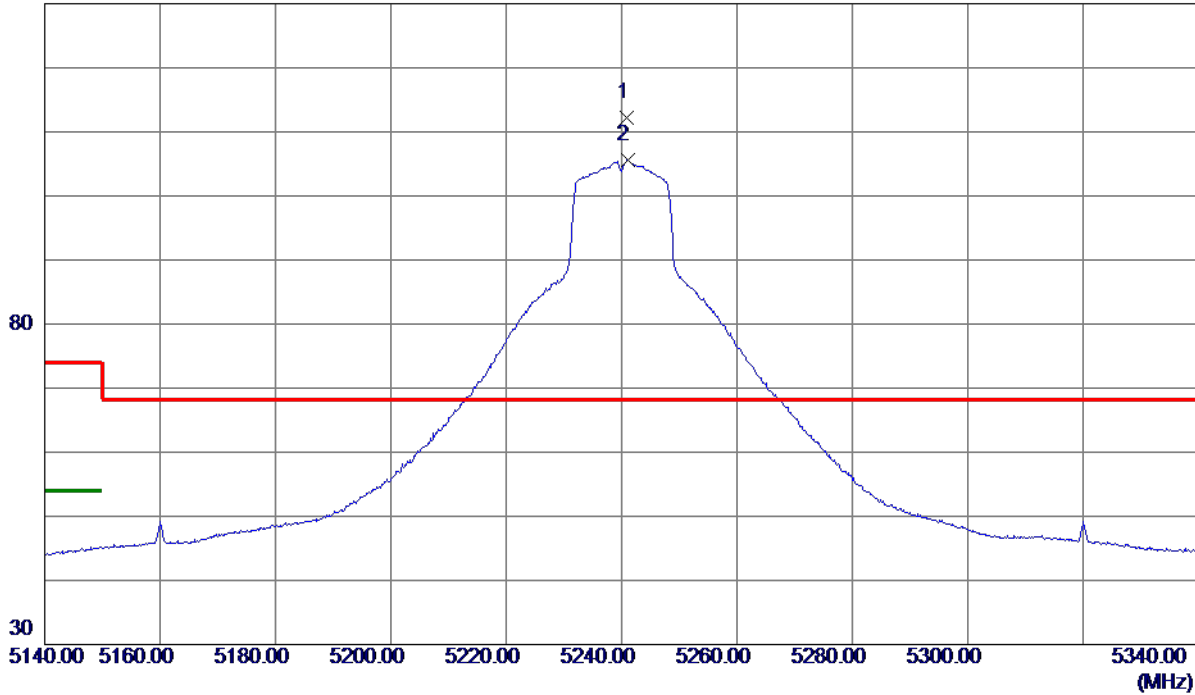

No.	Freq. MHz	Reading Level dBuV/m	Correct Factor dB	Measure ment dBuV/m	Limit dBuV/m	Margin dB	Detector	Comment
1 *	5240.8000	97.11	15.10	112.21	68.30	43.91	Peak	No Limit
2	5241.0000	90.41	15.10	105.51	999.00	-893.49	AVG	No Limit

**REMARKS:**

- (1) Measurement Value = Reading Level + Correct Factor.
- (2) Margin Level = Measurement Value - Limit Value.

Orthogonal Axis	X
Test Mode	UNII-1_TX A Mode 5240 MHz

**Vertical**

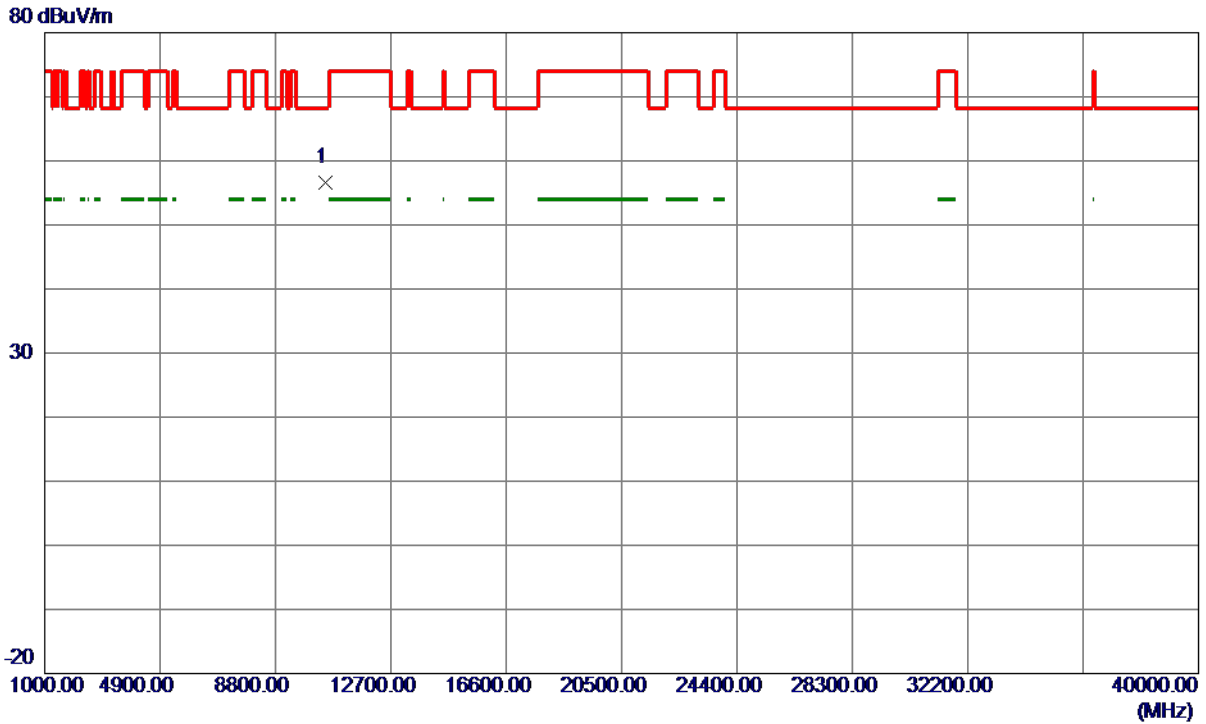

No.	Freq. MHz	Reading Level dBuV/m	Correct Factor dB	Measure ment dBuV/m	Limit dBuV/m	Margin dB	Detector	Comment
1 *	10483.3500	43.49	13.14	56.63	68.30	-11.67	Peak	

**REMARKS:**

- (1) Measurement Value = Reading Level + Correct Factor.
- (2) Margin Level = Measurement Value - Limit Value.

Orthogonal Axis	X
Test Mode	UNII-1_TX A Mode 5240 MHz

**Horizontal**

130 dBuV/m

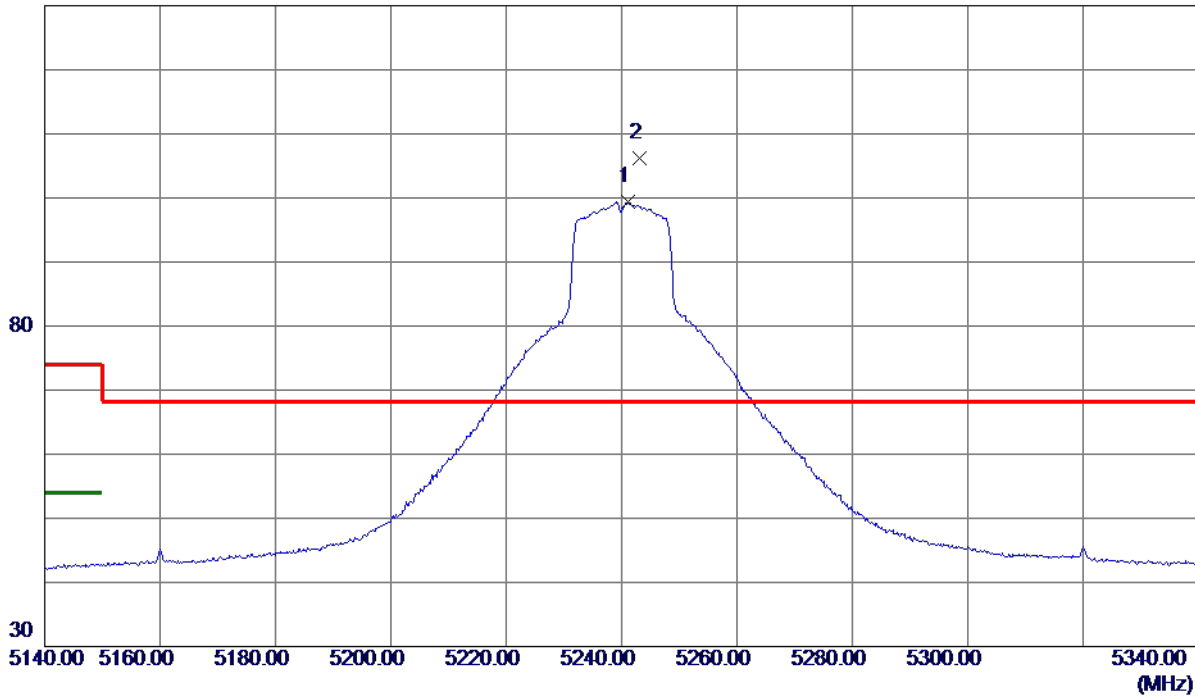

No.	Freq. MHz	Reading Level dBuV/m	Correct Factor dB	Measure ment dBuV/m	Limit dBuV/m	Margin dB	Detector	Comment
1	5241.2000	84.32	15.10	99.42	999.00	-899.58	AVG	No Limit
2 *	5243.1000	91.19	15.10	106.29	68.30	37.99	Peak	No Limit

**REMARKS:**

- (1) Measurement Value = Reading Level + Correct Factor.
- (2) Margin Level = Measurement Value - Limit Value.

Orthogonal Axis	X
Test Mode	UNII-1_TX A Mode 5240 MHz

**Horizontal**



No.	Freq. MHz	Reading Level dBuV/m	Correct Factor dB	Measure ment dBuV/m	Limit dBuV/m	Margin dB	Detector	Comment
1 *	10481.5800	39.01	13.14	52.15	68.30	-16.15	Peak	

**REMARKS:**

- (1) Measurement Value = Reading Level + Correct Factor.
- (2) Margin Level = Measurement Value - Limit Value.



Orthogonal Axis	X
Test Mode	UNII-1_TX N (HT20) Mode 5180 MHz

Vertical

130 dBuV/m

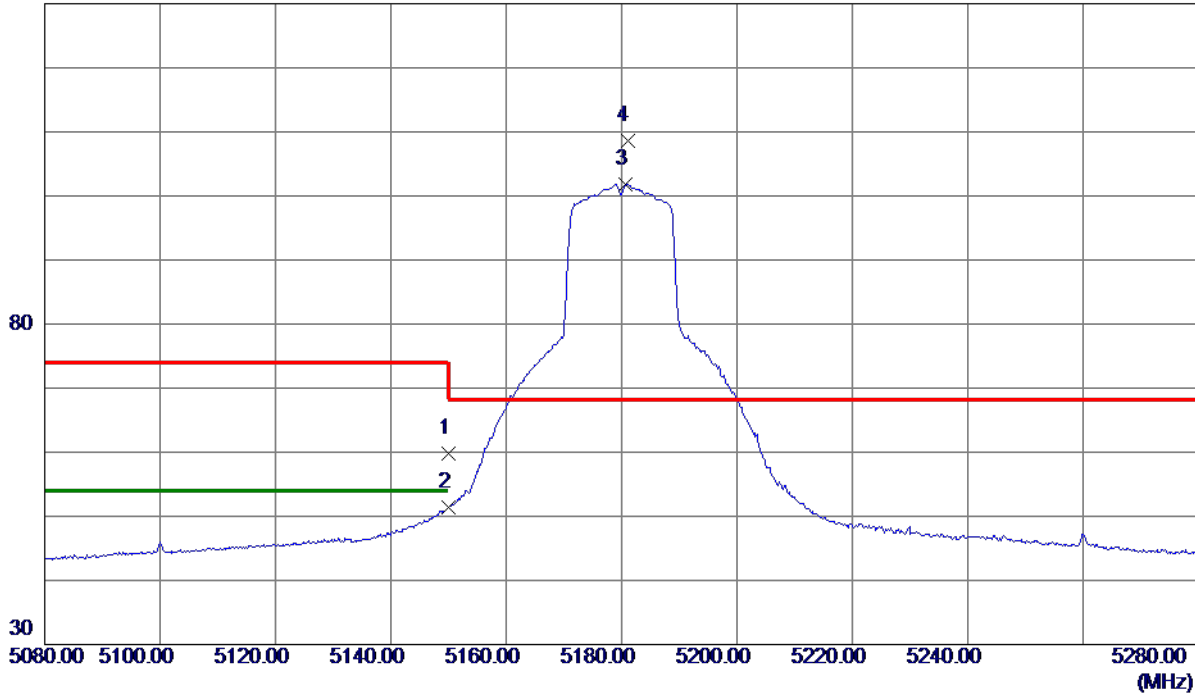

No.	Freq. MHz	Reading Level dBuV/m	Correct Factor dB	Measure ment dBuV/m	Limit dBuV/m	Margin dB	Detector	Comment
1	5150.0000	44.87	14.91	59.78	74.00	-14.22	Peak	
2	5150.0000	36.44	14.91	51.35	54.00	-2.65	AVG	
3	5180.7000	86.90	14.97	101.87	999.00	-897.13	AVG	No Limit
4 *	5181.0000	93.71	14.97	108.68	68.30	40.38	Peak	No Limit

REMARKS:

- (1) Measurement Value = Reading Level + Correct Factor.
- (2) Margin Level = Measurement Value - Limit Value.

Orthogonal Axis	X
Test Mode	UNII-1_TX N (HT20) Mode 5180 MHz

**Vertical**



No.	Freq. MHz	Reading Level dBuV/m	Correct Factor dB	Measure ment dBuV/m	Limit dBuV/m	Margin dB	Detector	Comment
1 *	10356.7500	42.91	12.88	55.79	68.30	-12.51	Peak	

**REMARKS:**

- (1) Measurement Value = Reading Level + Correct Factor.
- (2) Margin Level = Measurement Value - Limit Value.

Orthogonal Axis	X
Test Mode	UNII-1_TX N (HT20) Mode 5180 MHz

### Horizontal

130 dBuV/m

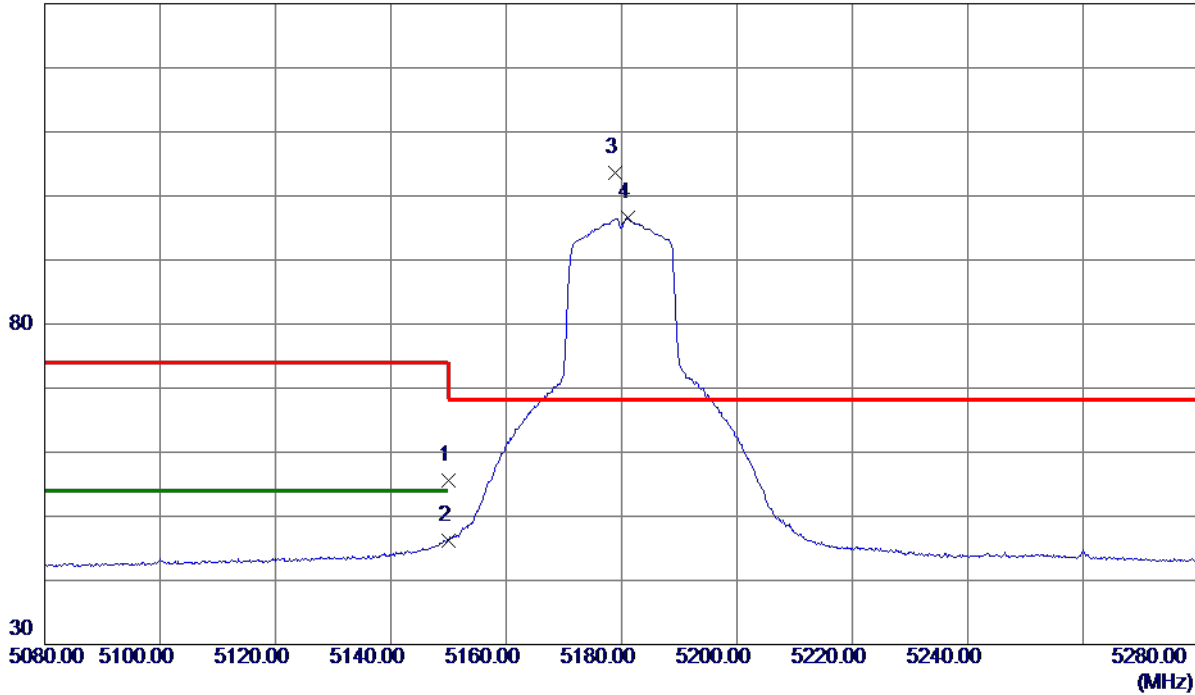

No.	Freq. MHz	Reading Level dBuV/m	Correct Factor dB	Measure ment dBuV/m	Limit dBuV/m	Margin dB	Detector	Comment
1	5150.0000	40.70	14.91	55.61	74.00	-18.39	Peak	
2	5150.0000	31.32	14.91	46.23	54.00	-7.77	AVG	
3 *	5178.8000	88.61	14.97	103.58	68.30	35.28	Peak	No Limit
4	5181.1000	81.69	14.97	96.66	999.00	-902.34	AVG	No Limit

**REMARKS:**

- (1) Measurement Value = Reading Level + Correct Factor.
- (2) Margin Level = Measurement Value - Limit Value.

Orthogonal Axis	X
Test Mode	UNII-1_TX N (HT20) Mode 5180 MHz

**Horizontal**

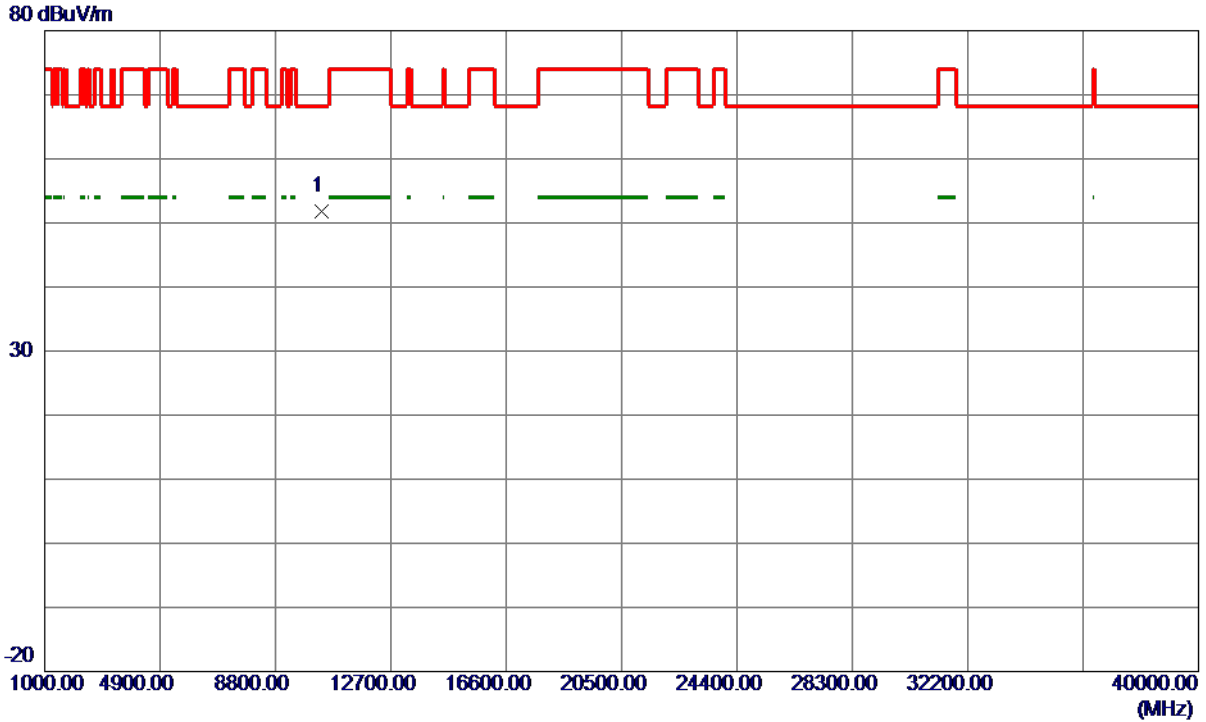

No.	Freq. MHz	Reading Level dBuV/m	Correct Factor dB	Measure ment dBuV/m	Limit dBuV/m	Margin dB	Detector	Comment
1 *	10362.8400	38.89	12.90	51.79	68.30	-16.51	Peak	

**REMARKS:**

- (1) Measurement Value = Reading Level + Correct Factor.
- (2) Margin Level = Measurement Value - Limit Value.

Orthogonal Axis	X
Test Mode	UNII-1_TX N (HT20) Mode 5200 MHz

Vertical

130 dBuV/m

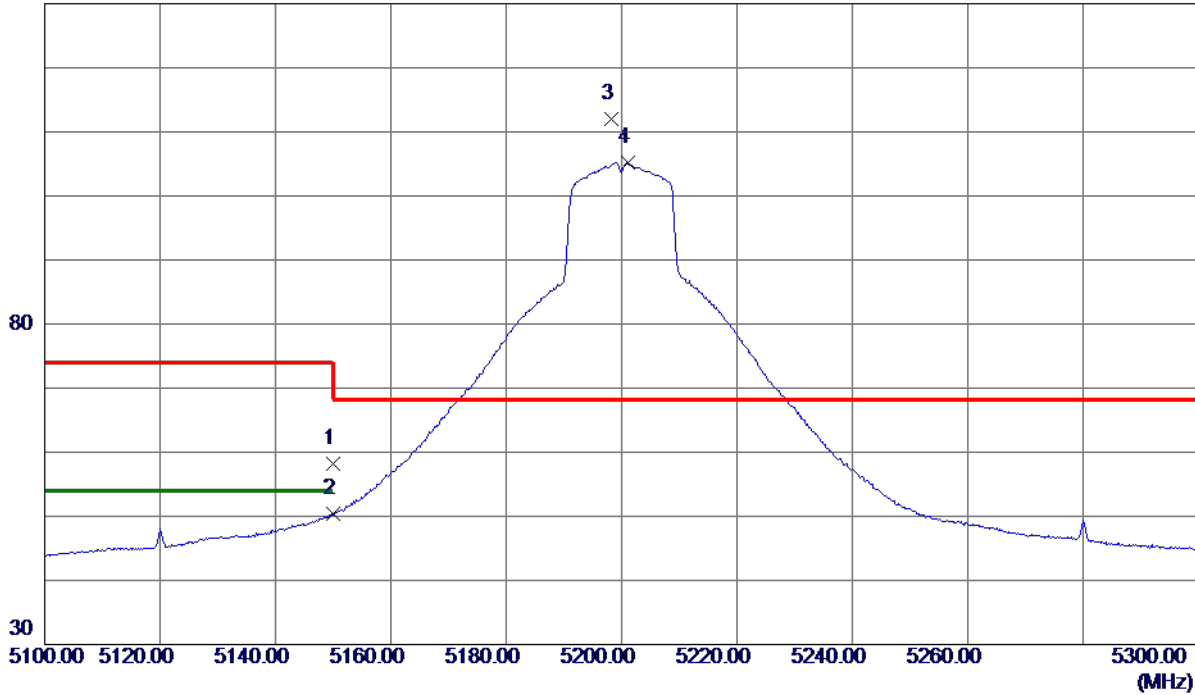

No.	Freq. MHz	Reading Level dBuV/m	Correct Factor dB	Measure ment dBuV/m	Limit dBuV/m	Margin dB	Detector	Comment
1	5150.0000	43.20	14.91	58.11	74.00	-15.89	Peak	
2	5150.0000	35.58	14.91	50.49	54.00	-3.51	AVG	
3 *	5198.3000	96.99	15.01	112.00	68.30	43.70	Peak	
4	5201.1000	90.20	15.02	105.22	999.00	-893.78	AVG	

REMARKS:

- (1) Measurement Value = Reading Level + Correct Factor.
- (2) Margin Level = Measurement Value - Limit Value.

Orthogonal Axis	X
Test Mode	UNII-1_TX N (HT20) Mode 5200 MHz

**Vertical**

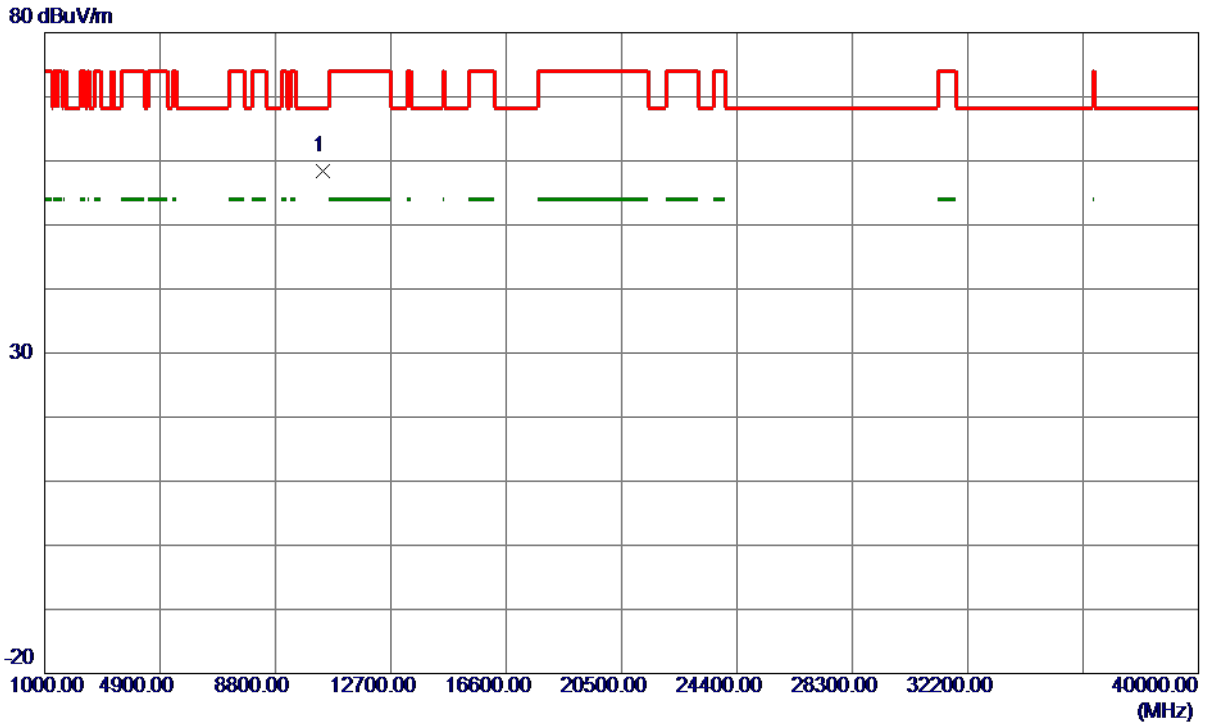

No.	Freq. MHz	Reading Level dBuV/m	Correct Factor dB	Measure ment dBuV/m	Limit dBuV/m	Margin dB	Detector	Comment
1 *	10401.8400	45.41	12.98	58.39	68.30	-9.91	Peak	

**REMARKS:**

- (1) Measurement Value = Reading Level + Correct Factor.
- (2) Margin Level = Measurement Value - Limit Value.

Orthogonal Axis	X
Test Mode	UNII-1_TX N (HT20) Mode 5200 MHz

**Horizontal**

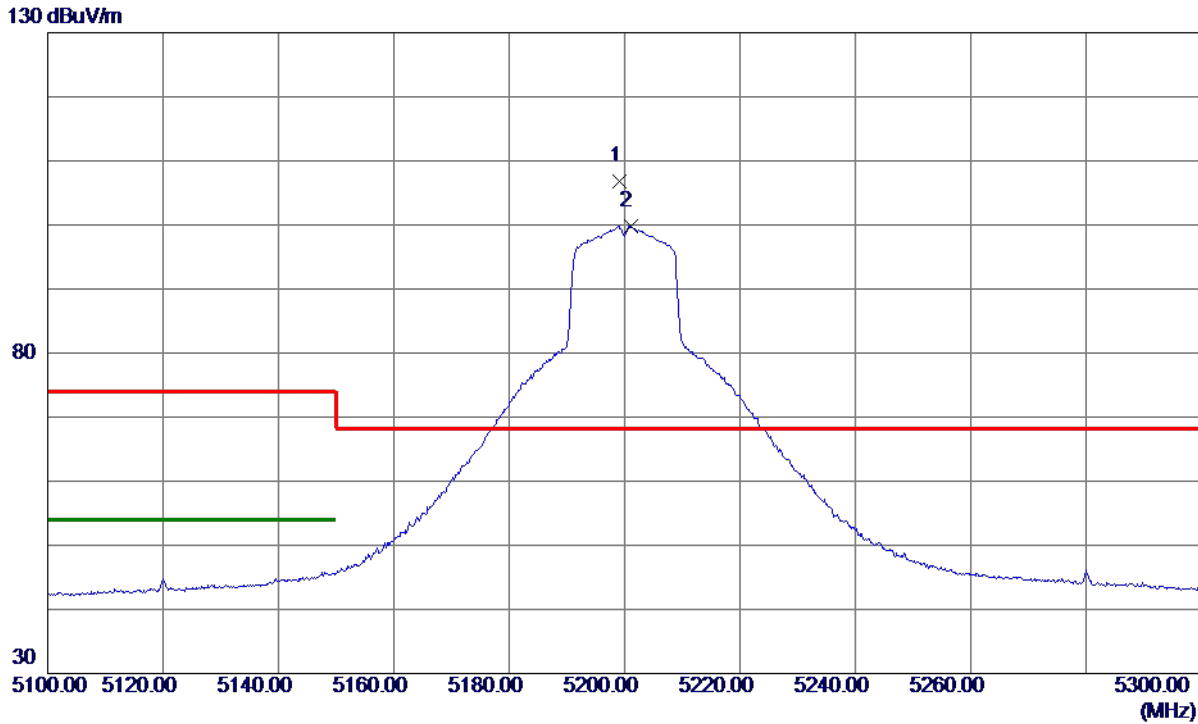

No.	Freq. MHz	Reading Level dBuV/m	Correct Factor dB	Measure ment dBuV/m	Limit dBuV/m	Margin dB	Detector	Comment
1 *	5199.2000	91.77	15.01	106.78	68.30	38.48	Peak	No Limit
2	5201.0000	84.82	15.02	99.84	999.00	-899.16	AVG	No Limit

**REMARKS:**

- (1) Measurement Value = Reading Level + Correct Factor.
- (2) Margin Level = Measurement Value - Limit Value.

Orthogonal Axis	X
Test Mode	UNII-1_TX N (HT20) Mode 5200 MHz

**Horizontal**

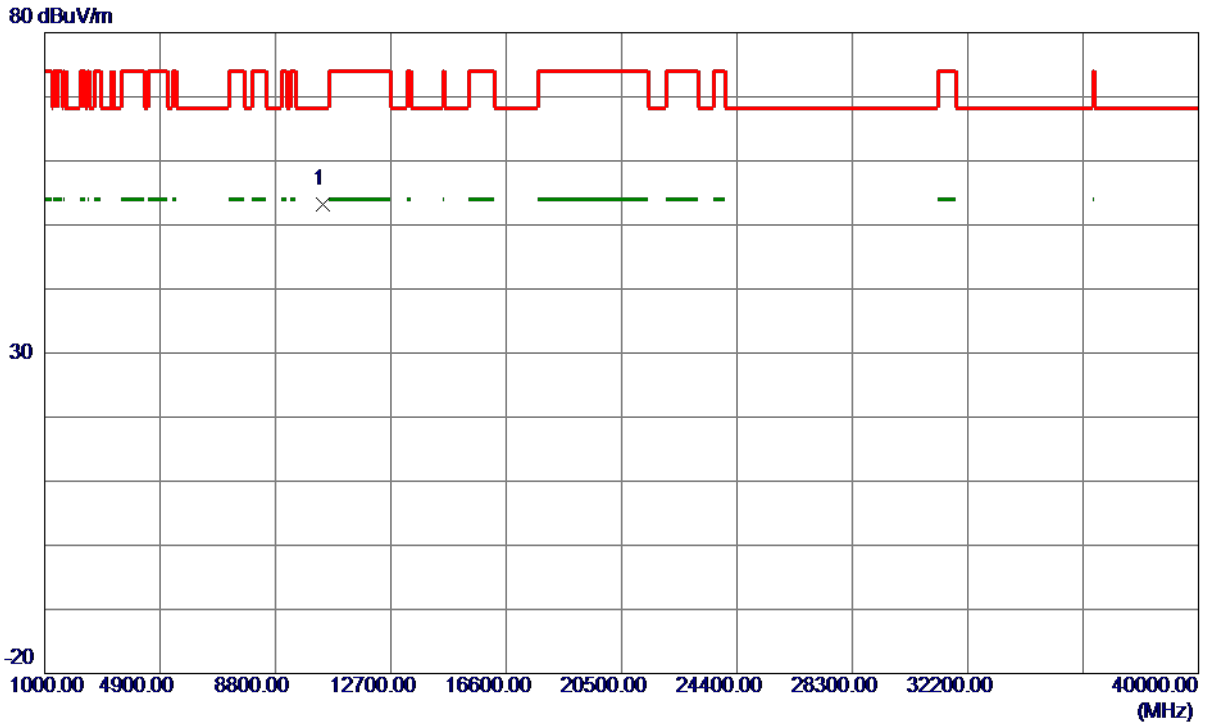

No.	Freq. MHz	Reading Level dBuV/m	Correct Factor dB	Measure ment dBuV/m	Limit dBuV/m	Margin dB	Detector	Comment
1 *	10401.4100	40.14	12.97	53.11	68.30	-15.19	Peak	

**REMARKS:**

- (1) Measurement Value = Reading Level + Correct Factor.
- (2) Margin Level = Measurement Value - Limit Value.



Orthogonal Axis	X
Test Mode	UNII-1_TX N (HT20) Mode 5240 MHz

**Vertical**

130 dBuV/m

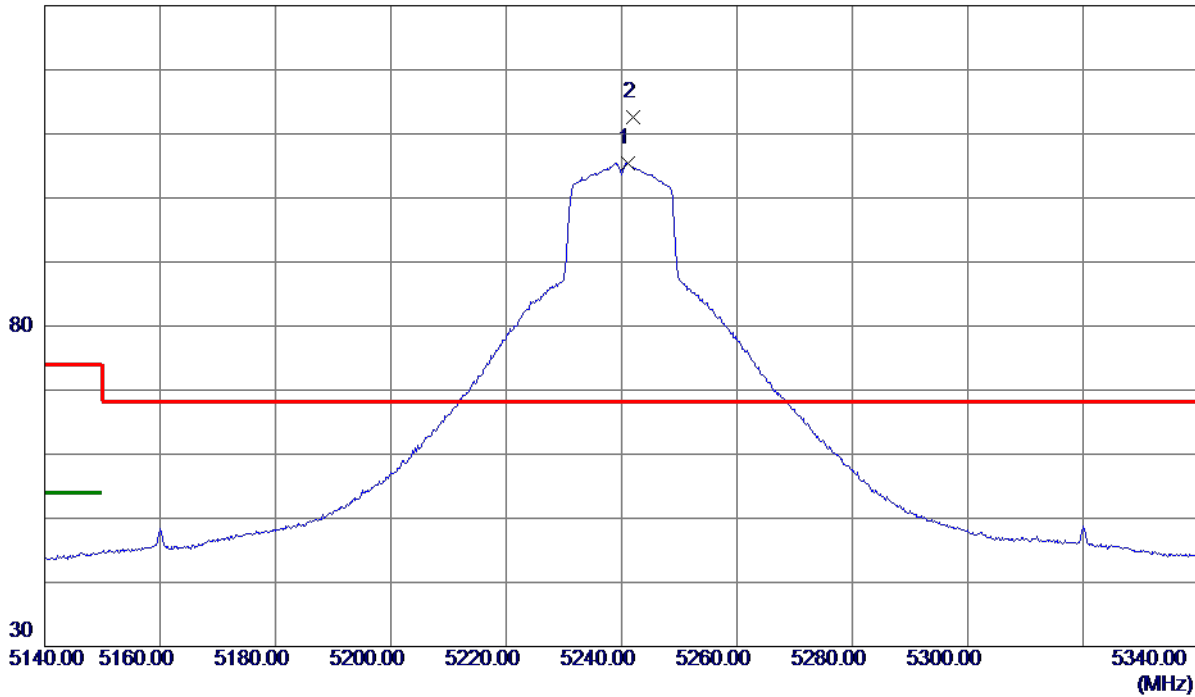

No.	Freq. MHz	Reading Level dBuV/m	Correct Factor dB	Measure ment dBuV/m	Limit dBuV/m	Margin dB	Detector	Comment
1	5241.2000	90.35	15.10	105.45	999.00	-893.55	AVG	No Limit
2 *	5241.9000	97.52	15.10	112.62	68.30	44.32	Peak	No Limit

**REMARKS:**

- (1) Measurement Value = Reading Level + Correct Factor.
- (2) Margin Level = Measurement Value - Limit Value.

Orthogonal Axis	X
Test Mode	UNII-1_TX N (HT20) Mode 5240 MHz

**Vertical**

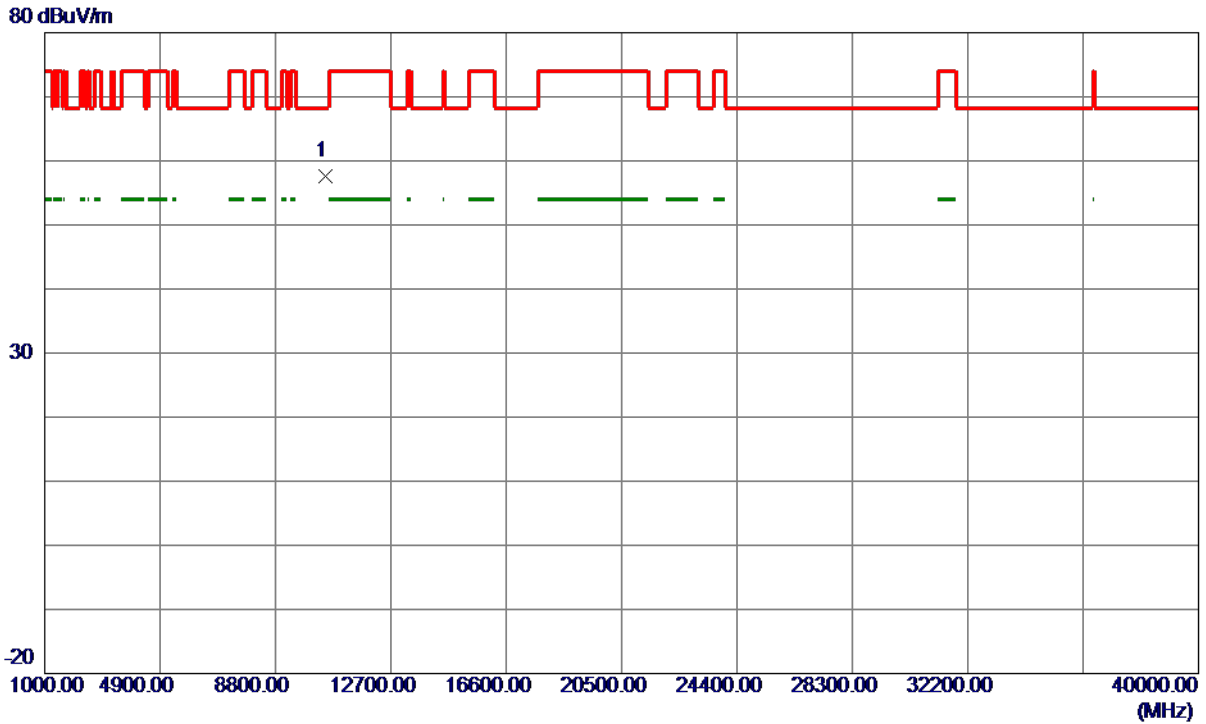

No.	Freq. MHz	Reading Level dBuV/m	Correct Factor dB	Measure ment dBuV/m	Limit dBuV/m	Margin dB	Detector	Comment
1 *	10475.1900	44.43	13.12	57.55	68.30	-10.75	Peak	

**REMARKS:**

- (1) Measurement Value = Reading Level + Correct Factor.
- (2) Margin Level = Measurement Value - Limit Value.

Orthogonal Axis	X
Test Mode	UNII-1_TX N (HT20) Mode 5240 MHz

**Horizontal**

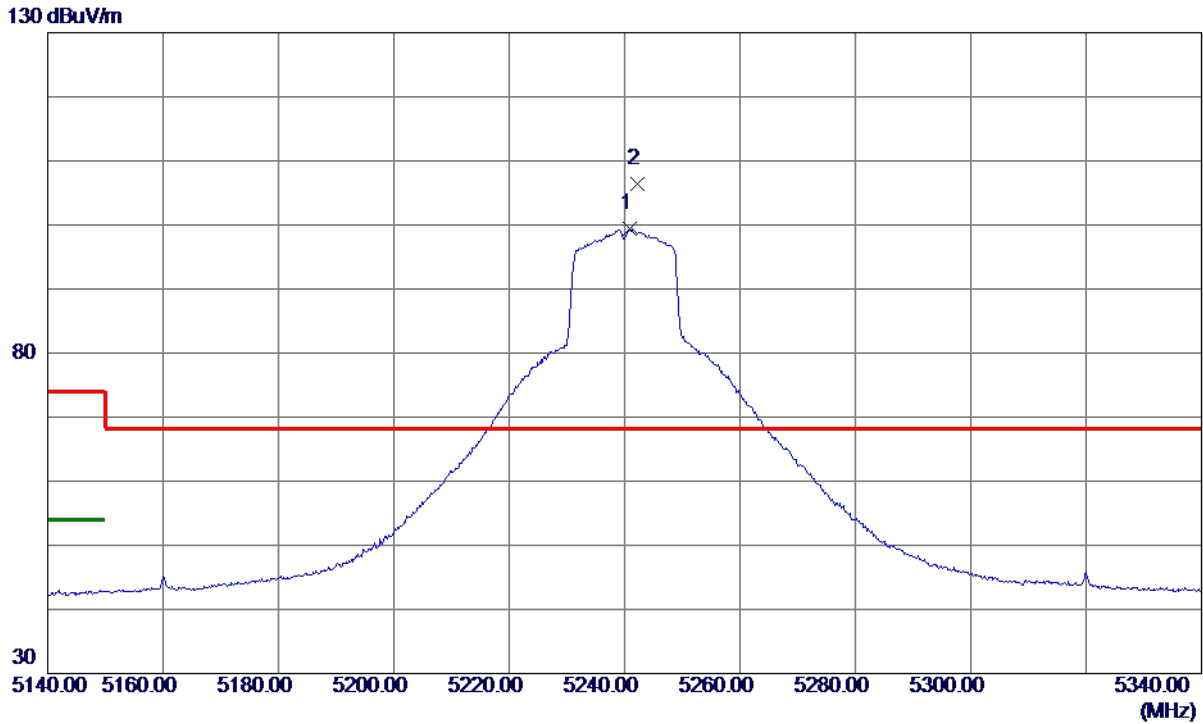

No.	Freq. MHz	Reading Level dBuV/m	Correct Factor dB	Measure ment dBuV/m	Limit dBuV/m	Margin dB	Detector	Comment
1	5240.9000	84.37	15.10	99.47	999.00	-899.53	AVG	No Limit
2 *	5242.3000	91.37	15.10	106.47	68.30	38.17	Peak	No Limit

**REMARKS:**

- (1) Measurement Value = Reading Level + Correct Factor.
- (2) Margin Level = Measurement Value - Limit Value.

Orthogonal Axis	X
Test Mode	UNII-1_TX N (HT20) Mode 5240 MHz

**Horizontal**

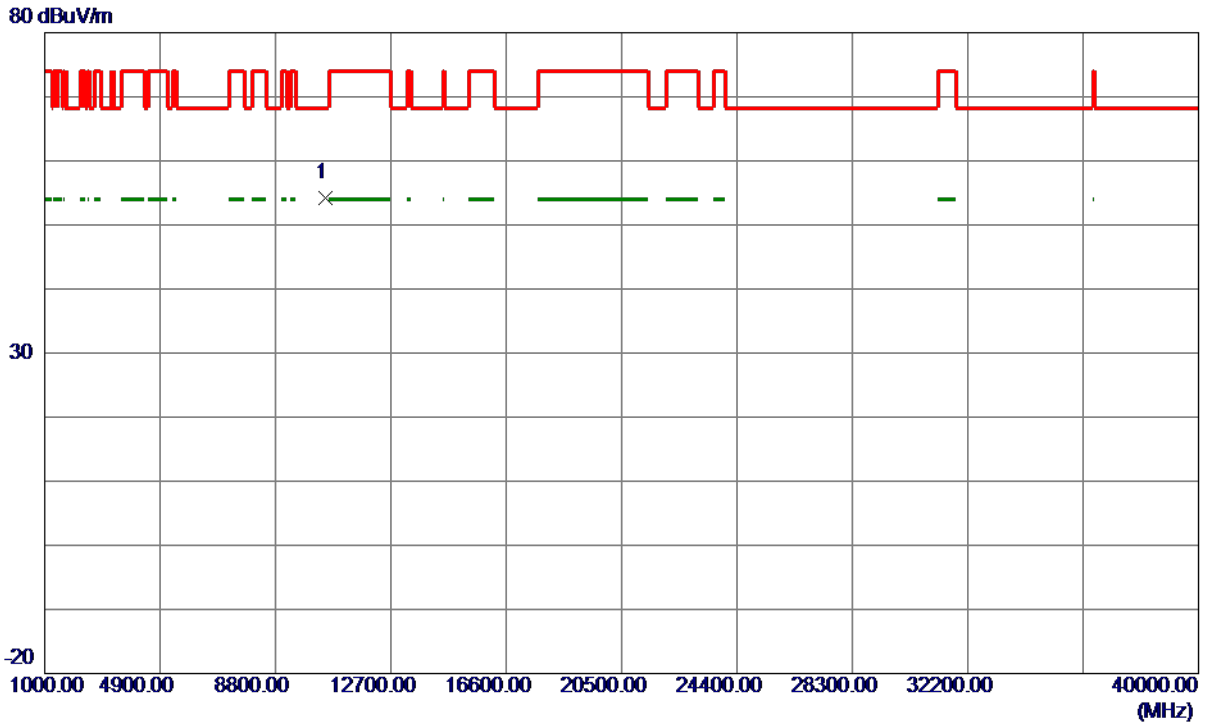

No.	Freq. MHz	Reading Level dBuV/m	Correct Factor dB	Measure ment dBuV/m	Limit dBuV/m	Margin dB	Detector	Comment
1 *	10474.7500	41.04	13.12	54.16	68.30	-14.14	Peak	

**REMARKS:**

- (1) Measurement Value = Reading Level + Correct Factor.
- (2) Margin Level = Measurement Value - Limit Value.

Orthogonal Axis	X
Test Mode	UNII-1_TX N (HT40) Mode 5190 MHz

**Vertical**

130 dBuV/m

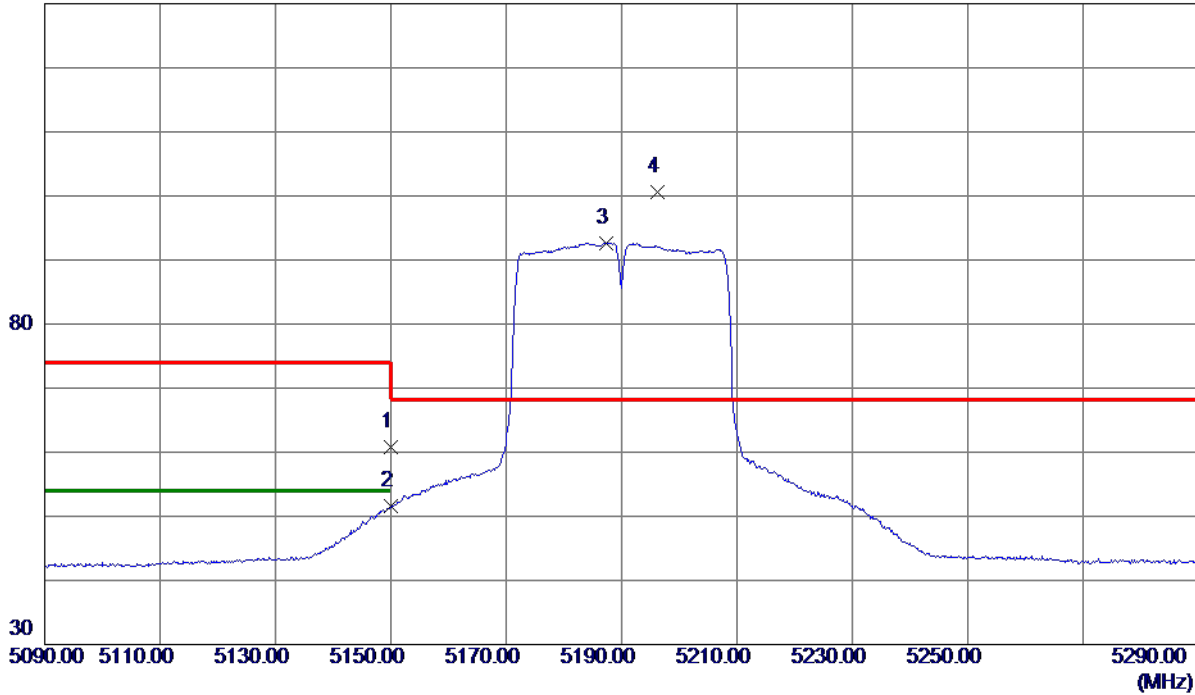

No.	Freq. MHz	Reading Level dBuV/m	Correct Factor dB	Measure ment dBuV/m	Limit dBuV/m	Margin dB	Detector	Comment
1	5150.0000	45.85	14.91	60.76	74.00	-13.24	Peak	
2	5150.0000	36.60	14.91	51.51	54.00	-2.49	AVG	
3	5187.3000	77.70	14.99	92.69	999.00	-906.31	AVG	No Limit
4 *	5196.3000	85.61	15.01	100.62	68.30	32.32	Peak	No Limit

**REMARKS:**

- (1) Measurement Value = Reading Level + Correct Factor.
- (2) Margin Level = Measurement Value - Limit Value.

Orthogonal Axis	X
Test Mode	UNII-1_TX N (HT40) Mode 5190 MHz

**Vertical**

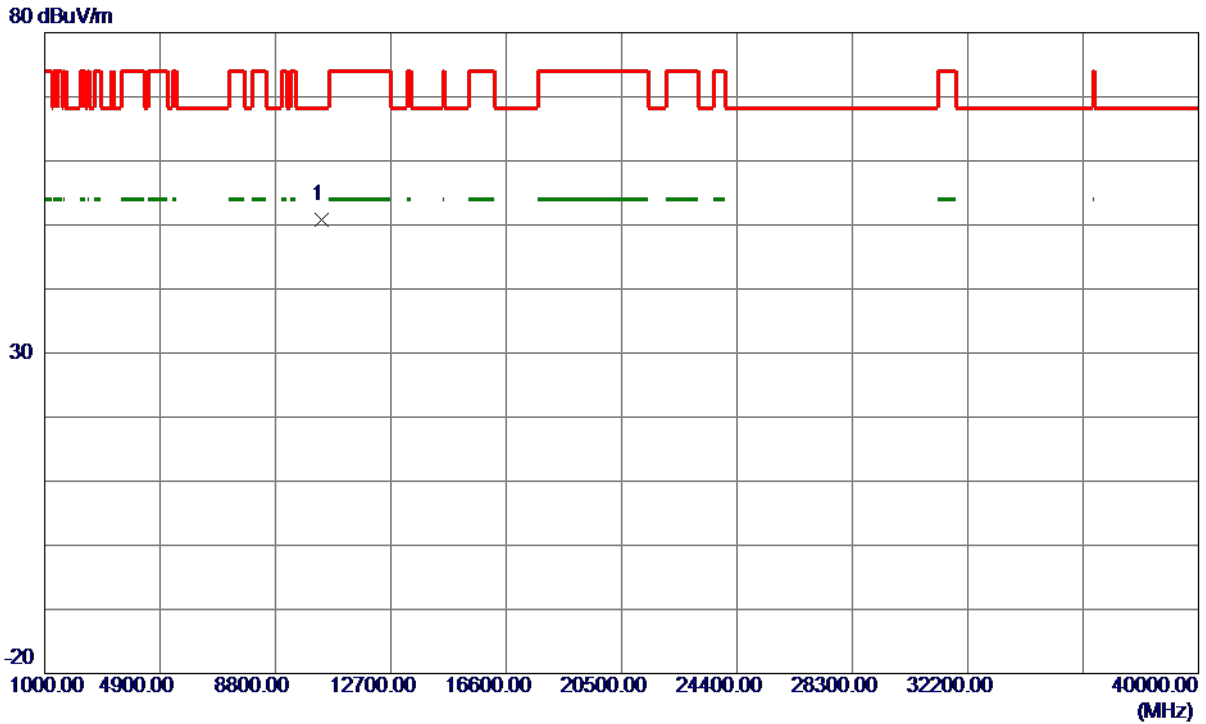

No.	Freq. MHz	Reading Level dBuV/m	Correct Factor dB	Measure ment dBuV/m	Limit dBuV/m	Margin dB	Detector	Comment
1 *	10372.8400	37.92	12.92	50.84	68.30	-17.46	Peak	

**REMARKS:**

- (1) Measurement Value = Reading Level + Correct Factor.
- (2) Margin Level = Measurement Value - Limit Value.

Orthogonal Axis	X
Test Mode	UNII-1_TX N (HT40) Mode 5190 MHz

### Horizontal

130 dBuV/m

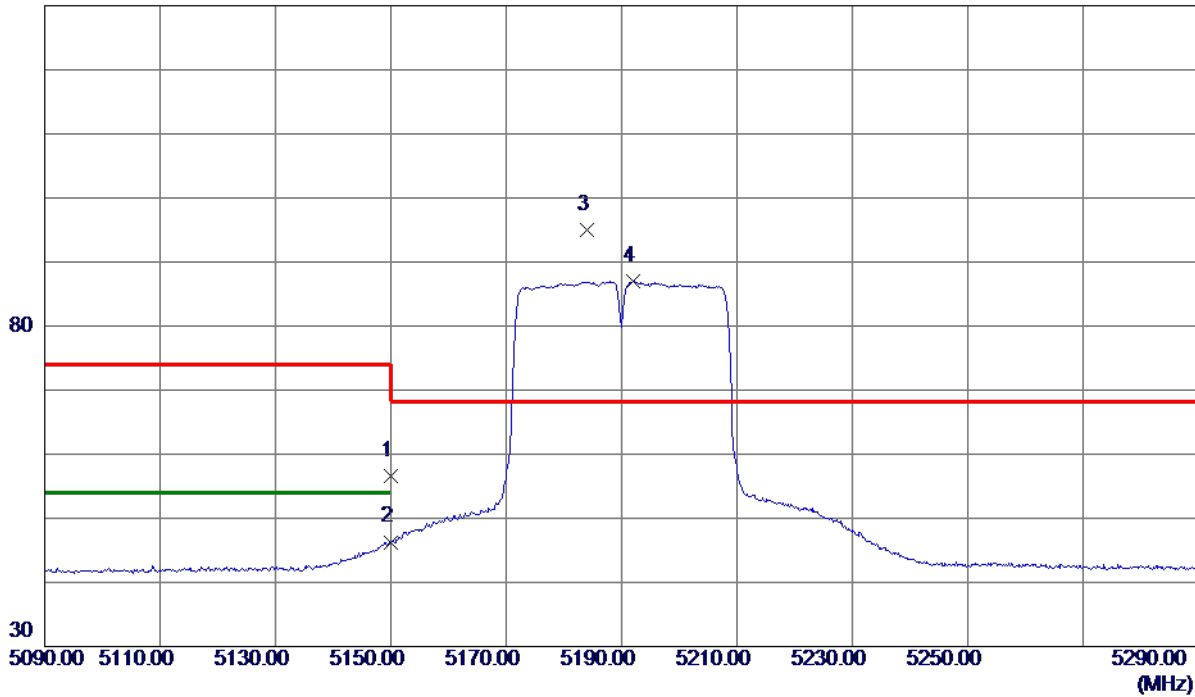

No.	Freq. MHz	Reading Level dBuV/m	Correct Factor dB	Measure ment dBuV/m	Limit dBuV/m	Margin dB	Detector	Comment
1	5150.0000	41.65	14.91	56.56	74.00	-17.44	Peak	
2	5150.0000	31.39	14.91	46.30	54.00	-7.70	AVG	
3 *	5183.9000	79.92	14.98	94.90	68.30	26.60	Peak	No Limit
4	5192.1000	71.95	15.00	86.95	999.00	-912.05	AVG	No Limit

**REMARKS:**

- (1) Measurement Value = Reading Level + Correct Factor.
- (2) Margin Level = Measurement Value - Limit Value.

Orthogonal Axis	X
Test Mode	UNII-1_TX N (HT40) Mode 5190 MHz

**Horizontal**

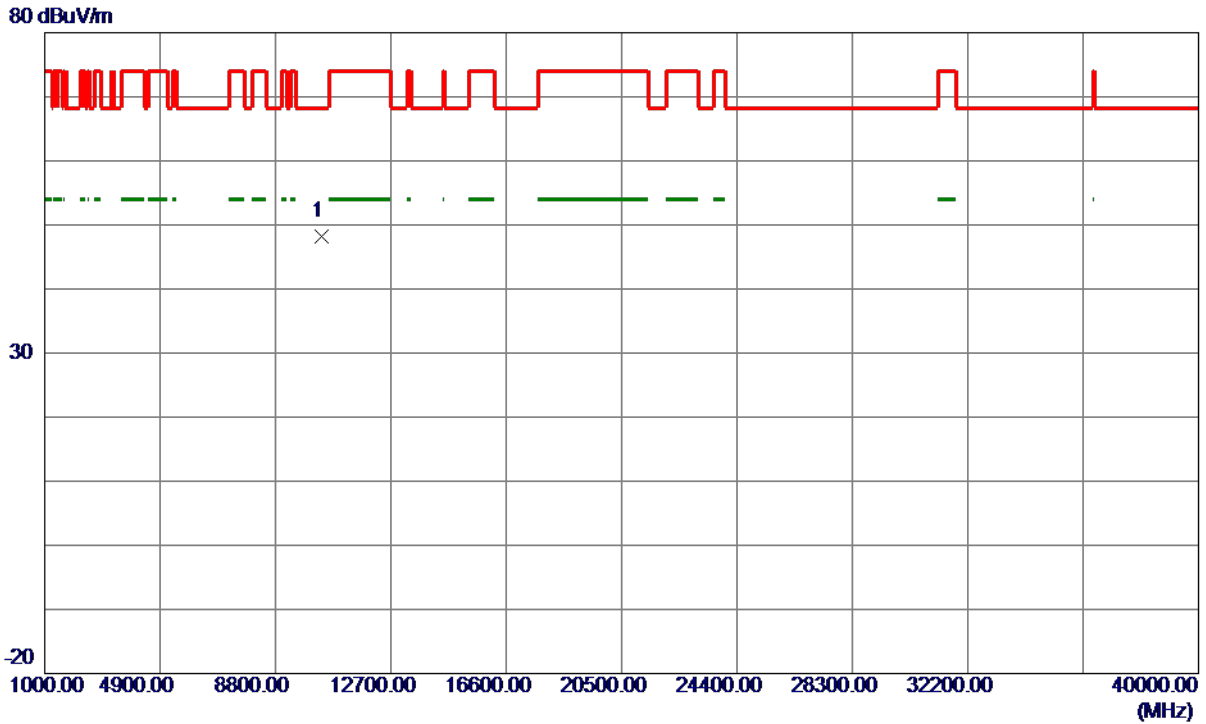

No.	Freq. MHz	Reading Level dBuV/m	Correct Factor dB	Measure ment dBuV/m	Limit dBuV/m	Margin dB	Detector	Comment
1 *	10375.8500	35.23	12.92	48.15	68.30	-20.15	Peak	

**REMARKS:**

- (1) Measurement Value = Reading Level + Correct Factor.
- (2) Margin Level = Measurement Value - Limit Value.



Orthogonal Axis	X
Test Mode	UNII-1_TX N (HT40) Mode 5230 MHz

**Vertical**

130 dBuV/m

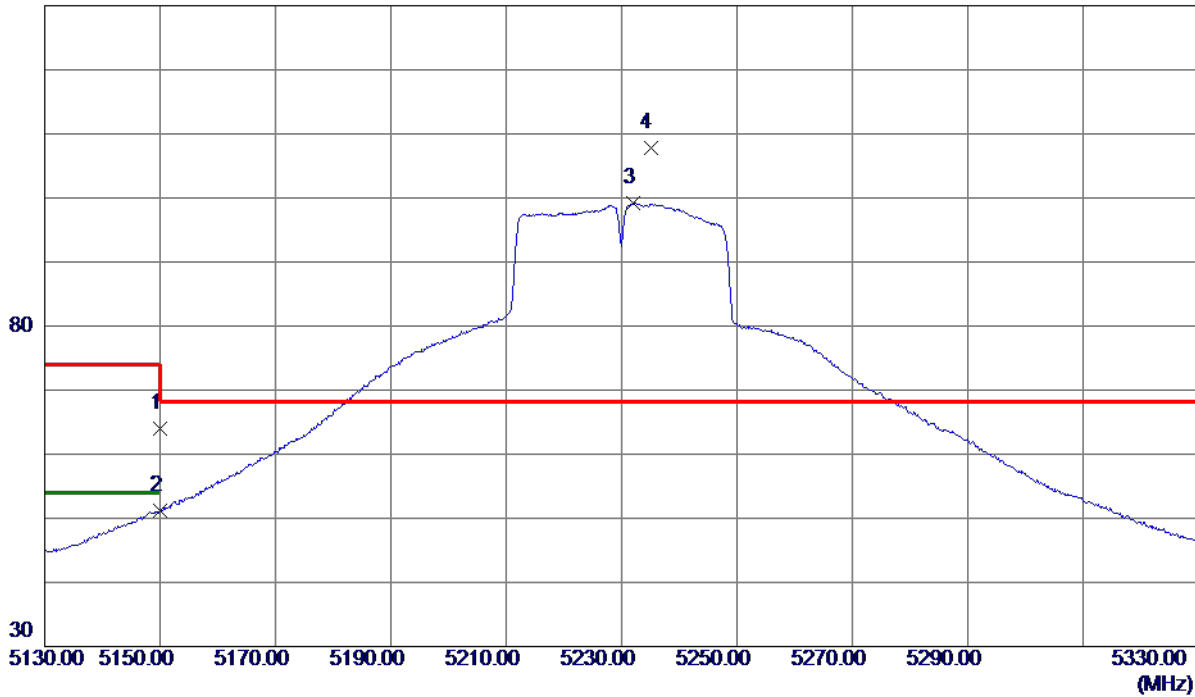

No.	Freq. MHz	Reading Level dBuV/m	Correct Factor dB	Measure ment dBuV/m	Limit dBuV/m	Margin dB	Detector	Comment
1	5150.0000	49.18	14.91	64.09	74.00	-9.91	Peak	
2	5150.0000	36.28	14.91	51.19	54.00	-2.81	AVG	
3	5231.9000	84.08	15.08	99.16	999.00	-899.84	AVG	No Limit
4 *	5235.0000	92.63	15.09	107.72	68.30	39.42	Peak	No Limit

**REMARKS:**

- (1) Measurement Value = Reading Level + Correct Factor.
- (2) Margin Level = Measurement Value - Limit Value.

Orthogonal Axis	X
Test Mode	UNII-1_TX N (HT40) Mode 5230 MHz

**Vertical**

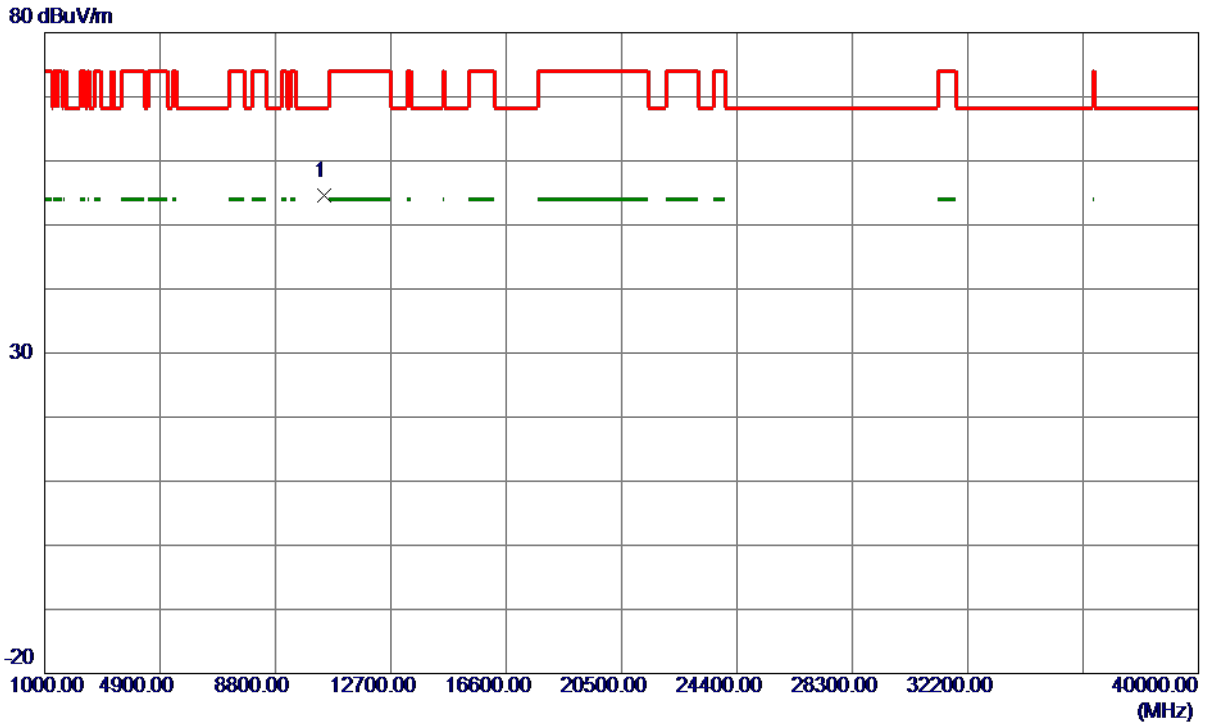

No.	Freq. MHz	Reading Level dBuV/m	Correct Factor dB	Measure ment dBuV/m	Limit dBuV/m	Margin dB	Detector	Comment
1 *	10456.2100	41.41	13.09	54.50	68.30	-13.80	Peak	

**REMARKS:**

- (1) Measurement Value = Reading Level + Correct Factor.
- (2) Margin Level = Measurement Value - Limit Value.

Orthogonal Axis	X
Test Mode	UNII-1_TX N (HT40) Mode 5230 MHz

Horizontal

130 dBuV/m

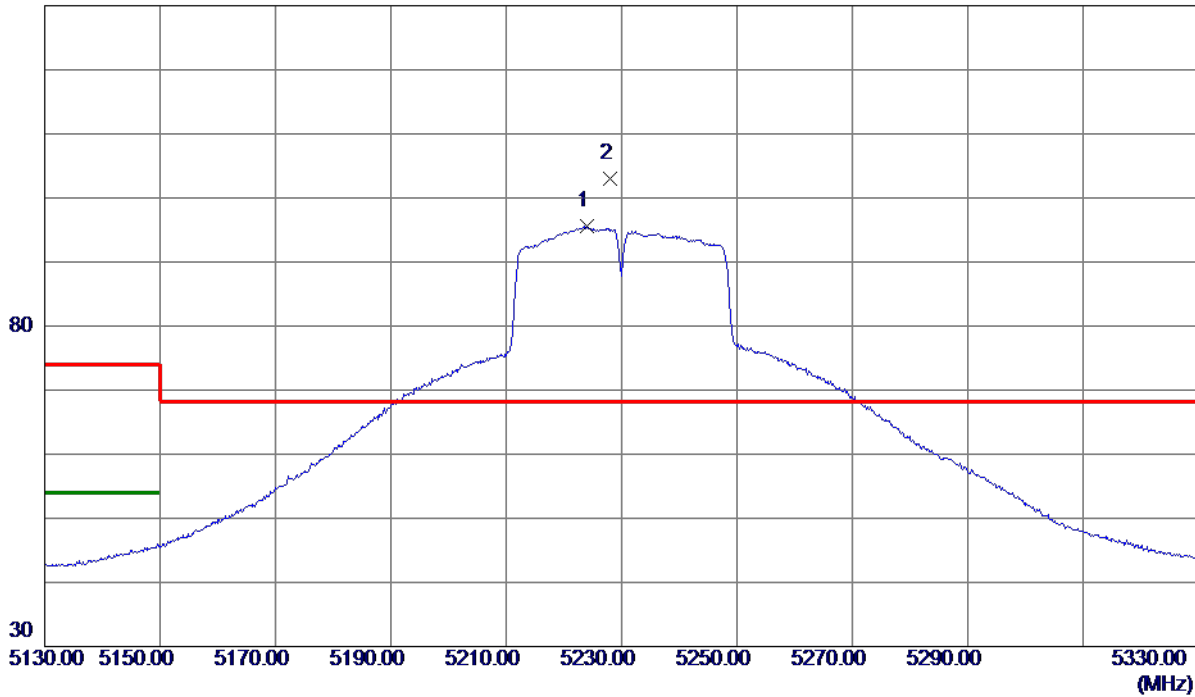

No.	Freq. MHz	Reading Level dBuV/m	Correct Factor dB	Measure ment dBuV/m	Limit dBuV/m	Margin dB	Detector	Comment
1	5224.0000	80.49	15.06	95.55	999.00	-903.45	AVG	No Limit
2 *	5227.9000	87.99	15.07	103.06	68.30	34.76	Peak	No Limit

REMARKS:

- (1) Measurement Value = Reading Level + Correct Factor.
- (2) Margin Level = Measurement Value - Limit Value.

Orthogonal Axis	X
Test Mode	UNII-1_TX N (HT40) Mode 5230 MHz

**Horizontal**

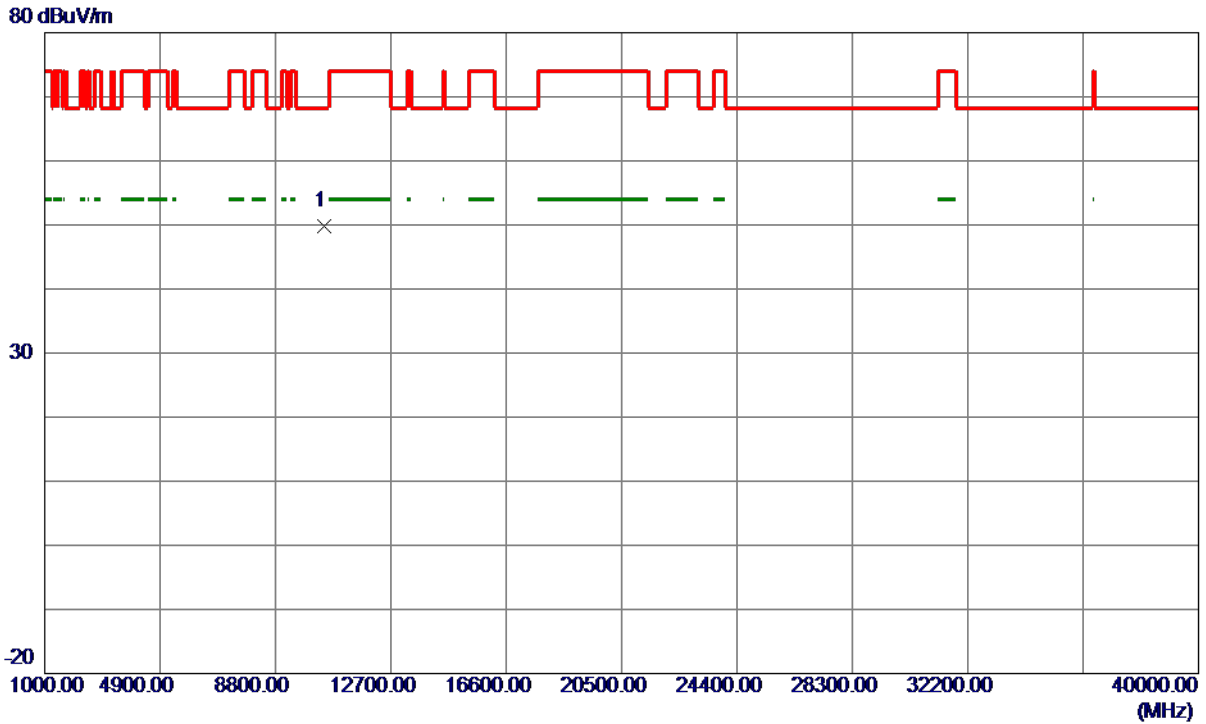

No.	Freq. MHz	Reading Level dBuV/m	Correct Factor dB	Measure ment dBuV/m	Limit dBuV/m	Margin dB	Detector	Comment
1 *	10463.6300	36.62	13.10	49.72	68.30	-18.58	Peak	

**REMARKS:**

- (1) Measurement Value = Reading Level + Correct Factor.
- (2) Margin Level = Measurement Value - Limit Value.

Orthogonal Axis	X
Test Mode	UNII-2A_TX A Mode 5260 MHz

Vertical

130 dBuV/m

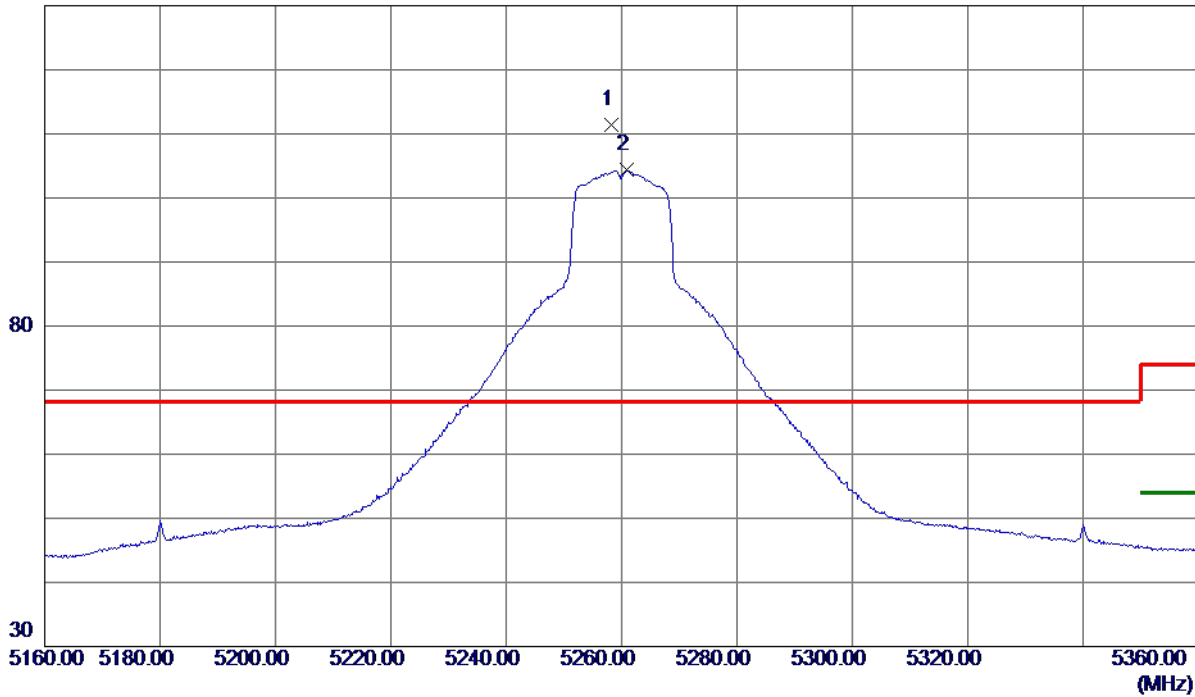

No.	Freq. MHz	Reading Level dBuV/m	Correct Factor dB	Measure ment dBuV/m	Limit dBuV/m	Margin dB	Detector	Comment
1 *	5258.3000	96.34	15.13	111.47	68.30	43.17	Peak	No Limit
2	5260.8000	89.17	15.14	104.31	999.00	-894.69	AVG	No Limit

REMARKS:

- (1) Measurement Value = Reading Level + Correct Factor.
- (2) Margin Level = Measurement Value - Limit Value.

Orthogonal Axis	X
Test Mode	UNII-2A_TX A Mode 5260 MHz

**Vertical**



No.	Freq. MHz	Reading Level dBuV/m	Correct Factor dB	Measure ment dBuV/m	Limit dBuV/m	Margin dB	Detector	Comment
1 *	10519.3000	41.23	13.19	54.42	68.30	-13.88	Peak	

**REMARKS:**

- (1) Measurement Value = Reading Level + Correct Factor.
- (2) Margin Level = Measurement Value - Limit Value.

Orthogonal Axis	X
Test Mode	UNII-2A_TX A Mode 5260 MHz

Horizontal

130 dBuV/m

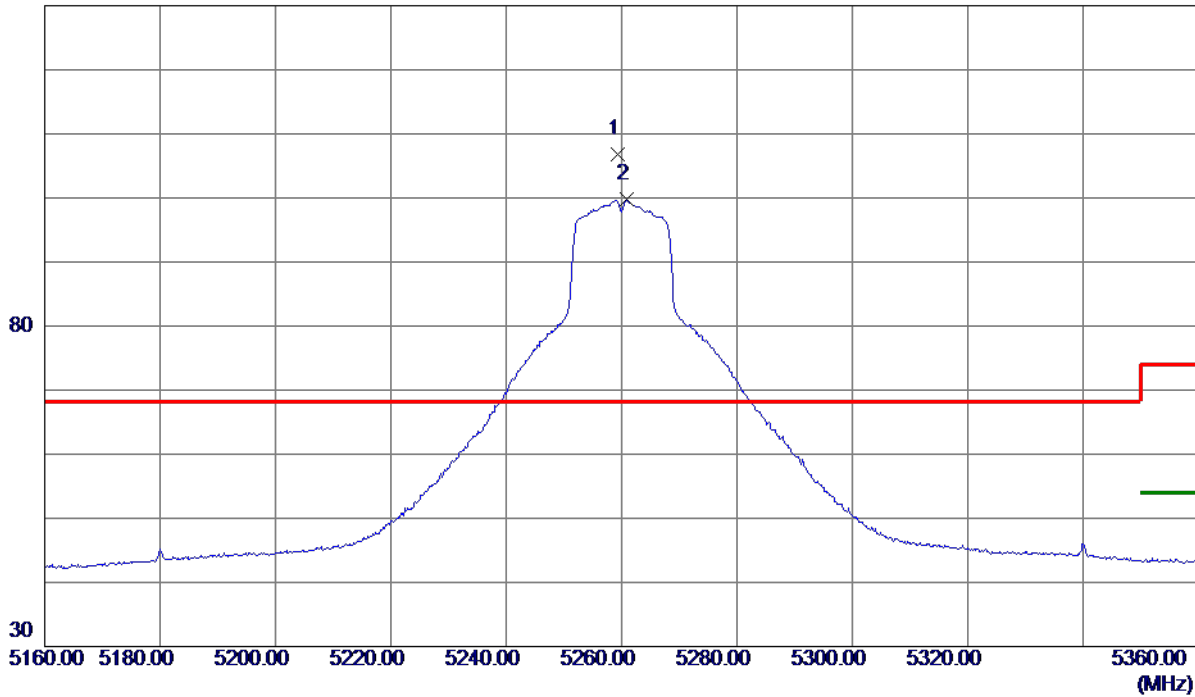

No.	Freq. MHz	Reading Level dBuV/m	Correct Factor dB	Measure ment dBuV/m	Limit dBuV/m	Margin dB	Detector	Comment
1 *	5259.4000	91.63	15.14	106.77	68.30	38.47	Peak	No Limit
2	5260.9000	84.59	15.14	99.73	999.00	-899.27	AVG	No Limit

REMARKS:

- (1) Measurement Value = Reading Level + Correct Factor.
- (2) Margin Level = Measurement Value - Limit Value.

Orthogonal Axis	X
Test Mode	UNII-2A_TX A Mode 5260 MHz

**Horizontal**

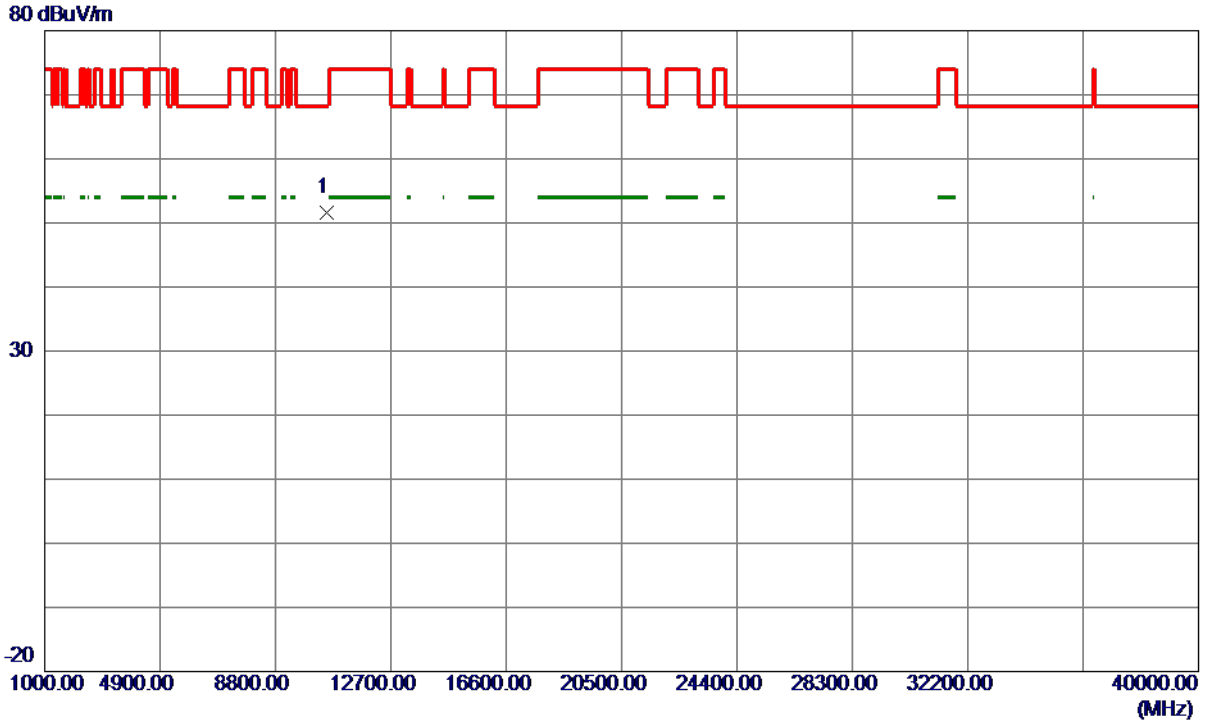

No.	Freq. MHz	Reading Level dBuV/m	Correct Factor dB	Measure ment dBuV/m	Limit dBuV/m	Margin dB	Detector	Comment
1 *	10513.4800	38.40	13.18	51.58	68.30	-16.72	Peak	

**REMARKS:**

- (1) Measurement Value = Reading Level + Correct Factor.
- (2) Margin Level = Measurement Value - Limit Value.



Orthogonal Axis	X
Test Mode	UNII-2A_TX A Mode 5300 MHz

**Vertical**

130 dBuV/m

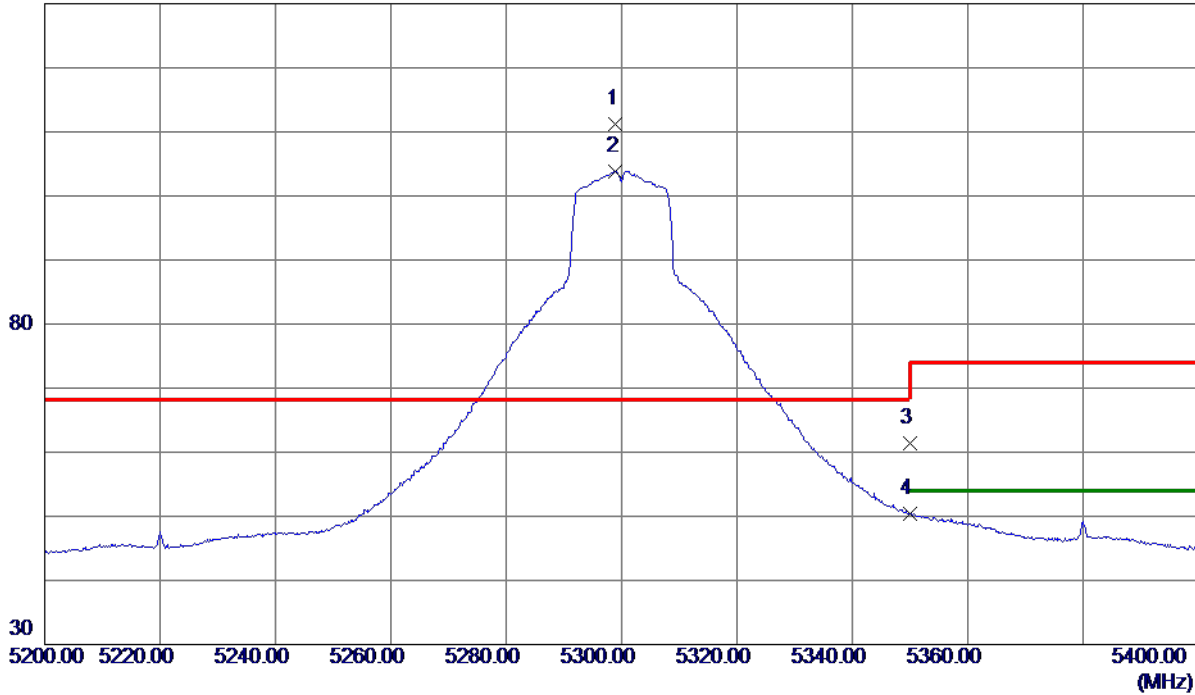

No.	Freq. MHz	Reading Level dBuV/m	Correct Factor dB	Measure ment dBuV/m	Limit dBuV/m	Margin dB	Detector	Comment
1 *	5299.0000	95.91	15.22	111.13	68.30	42.83	Peak	No Limit
2	5299.0000	88.66	15.22	103.88	999.00	-895.12	AVG	No Limit
3	5350.0000	46.16	15.32	61.48	74.00	-12.52	Peak	
4	5350.0000	35.00	15.32	50.32	999.00	-948.68	AVG	

**REMARKS:**

- (1) Measurement Value = Reading Level + Correct Factor.
- (2) Margin Level = Measurement Value - Limit Value.

Orthogonal Axis	X
Test Mode	UNII-2A_TX A Mode 5300 MHz

**Vertical**



No.	Freq. MHz	Reading Level dBuV/m	Correct Factor dB	Measure ment dBuV/m	Limit dBuV/m	Margin dB	Detector	Comment
1 *	10598.2600	38.85	13.24	52.09	68.30	-16.21	Peak	

**REMARKS:**

- (1) Measurement Value = Reading Level + Correct Factor.
- (2) Margin Level = Measurement Value - Limit Value.

Orthogonal Axis	X
Test Mode	UNII-2A_TX A Mode 5300 MHz

**Horizontal**

130 dBuV/m

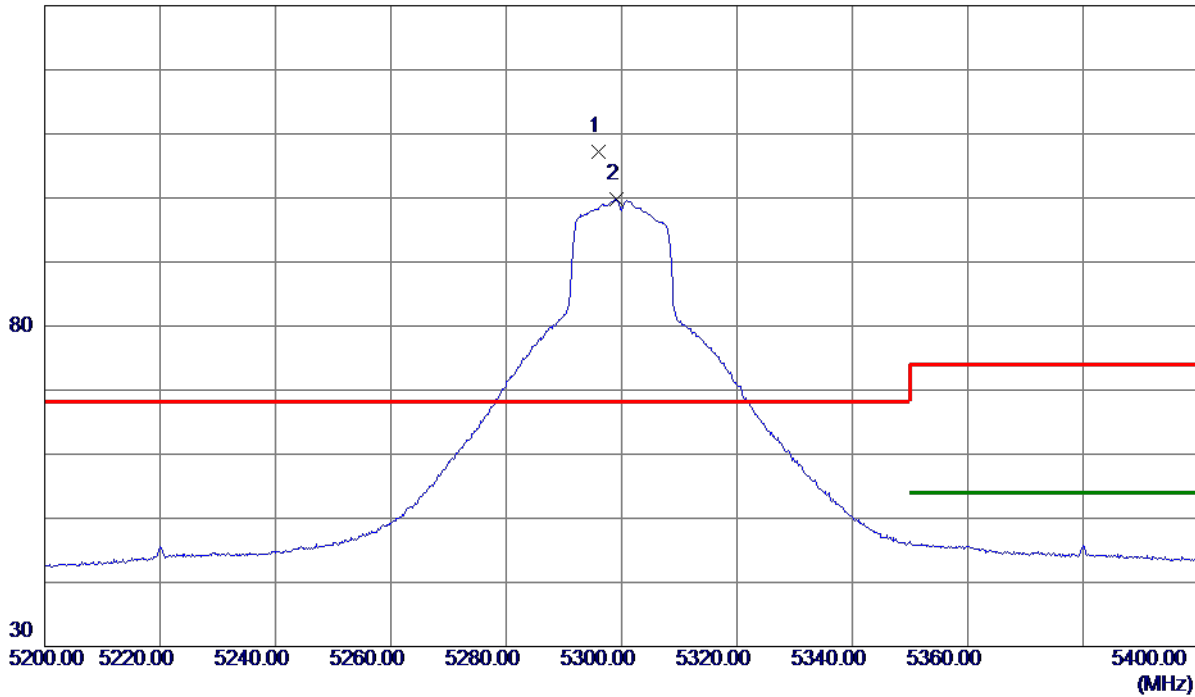

No.	Freq. MHz	Reading Level dBuV/m	Correct Factor dB	Measure ment dBuV/m	Limit dBuV/m	Margin dB	Detector	Comment
1 *	5296.1000	92.00	15.21	107.21	68.30	38.91	Peak	No Limit
2	5299.1000	84.56	15.22	99.78	999.00	-899.22	AVG	No Limit

**REMARKS:**

- (1) Measurement Value = Reading Level + Correct Factor.
- (2) Margin Level = Measurement Value - Limit Value.

Orthogonal Axis	X
Test Mode	UNII-2A_TX A Mode 5300 MHz

**Horizontal**

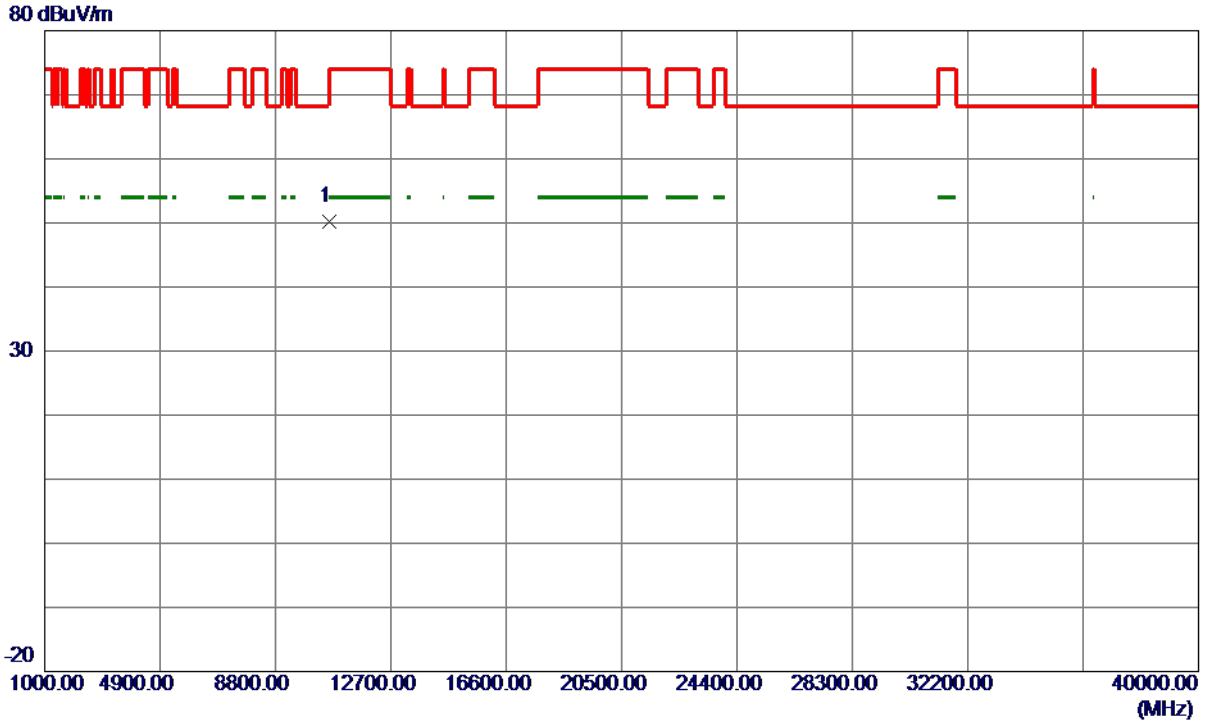

No.	Freq. MHz	Reading Level dBuV/m	Correct Factor dB	Measure ment dBuV/m	Limit dBuV/m	Margin dB	Detector	Comment
1 *	10599.4600	36.98	13.24	50.22	68.30	-18.08	Peak	

**REMARKS:**

- (1) Measurement Value = Reading Level + Correct Factor.
- (2) Margin Level = Measurement Value - Limit Value.

Orthogonal Axis	X
Test Mode	UNII-2A_TX A Mode 5320 MHz

Vertical

130 dBuV/m

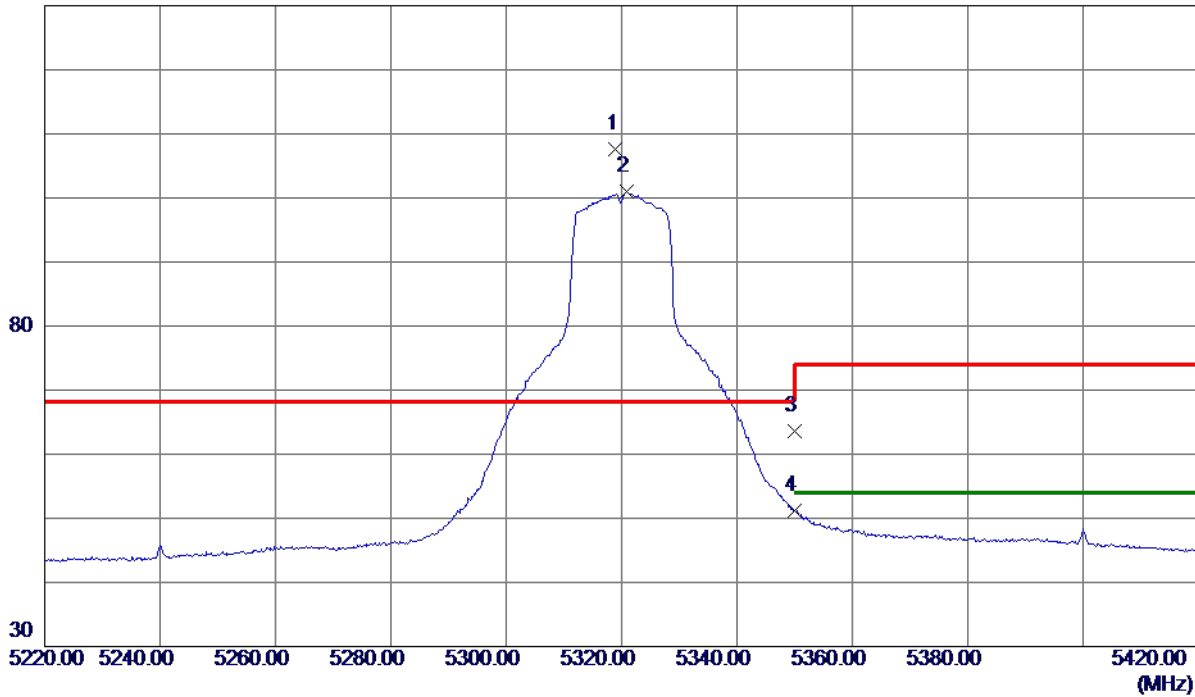

No.	Freq. MHz	Reading Level dBuV/m	Correct Factor dB	Measure ment dBuV/m	Limit dBuV/m	Margin dB	Detector	Comment
1 *	5319.0000	92.37	15.26	107.63	68.30	39.33	Peak	No Limit
2	5320.8000	85.68	15.26	100.94	999.00	-898.06	AVG	No Limit
3	5350.0000	48.19	15.32	63.51	74.00	-10.49	Peak	
4	5350.0000	35.91	15.32	51.23	999.00	-947.77	AVG	

REMARKS:

- (1) Measurement Value = Reading Level + Correct Factor.
- (2) Margin Level = Measurement Value - Limit Value.

Orthogonal Axis	X
Test Mode	UNII-2A_TX A Mode 5320 MHz

**Vertical**

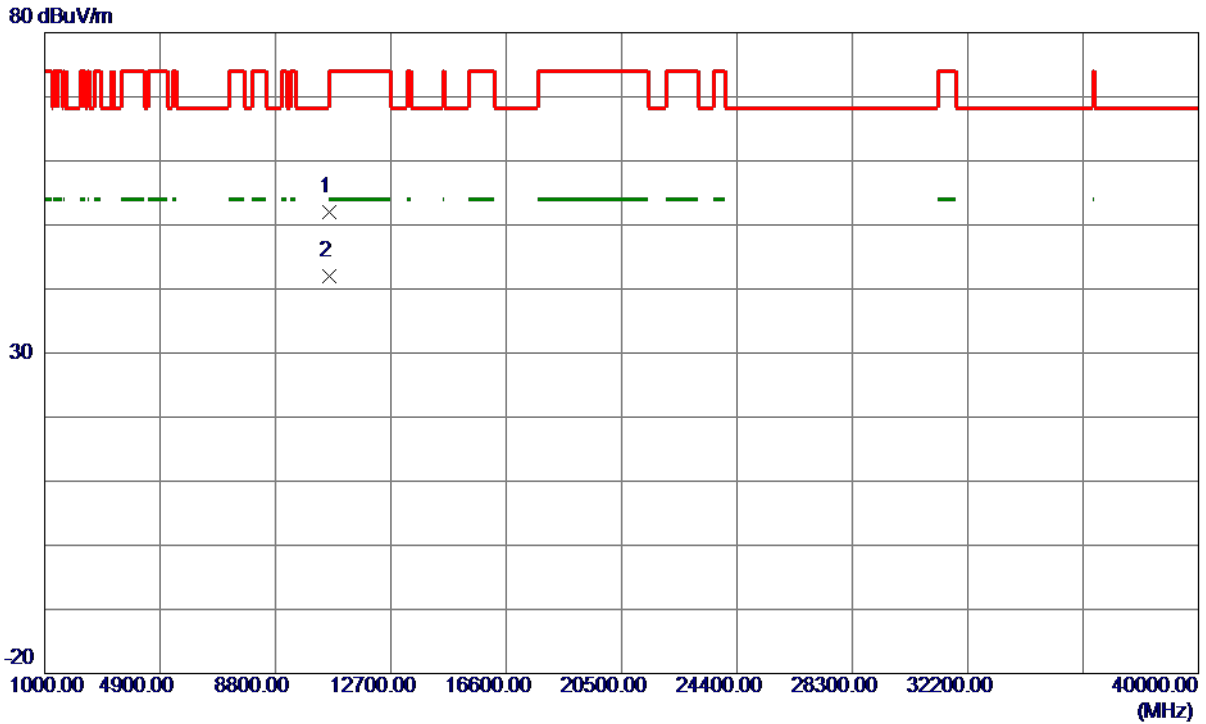

No.	Freq. MHz	Reading Level dBuV/m	Correct Factor dB	Measure ment dBuV/m	Limit dBuV/m	Margin dB	Detector	Comment
1	10637.6900	38.66	13.26	51.92	74.00	-22.08	Peak	
2 *	10638.8900	28.66	13.26	41.92	54.00	-12.08	AVG	

**REMARKS:**

- (1) Measurement Value = Reading Level + Correct Factor.
- (2) Margin Level = Measurement Value - Limit Value.

Orthogonal Axis	X
Test Mode	UNII-2A_TX A Mode 5320 MHz

**Horizontal**

130 dBuV/m

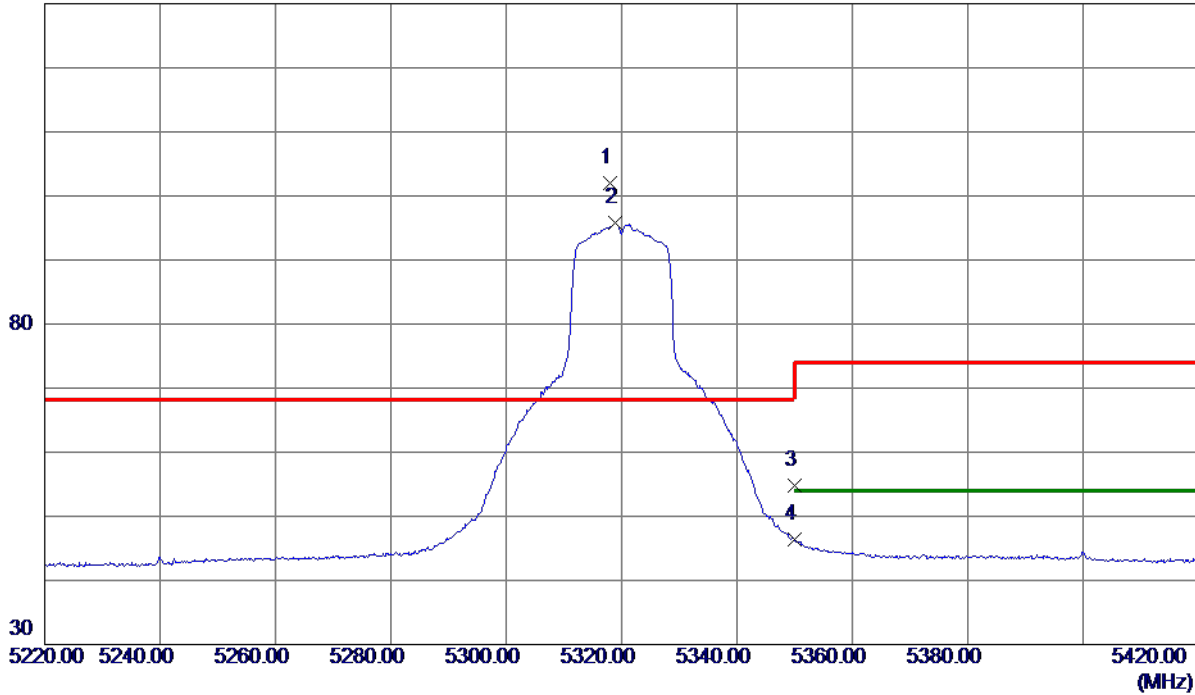

No.	Freq. MHz	Reading Level dBuV/m	Correct Factor dB	Measure ment dBuV/m	Limit dBuV/m	Margin dB	Detector	Comment
1 *	5317.9000	86.79	15.26	102.05	68.30	33.75	Peak	No Limit
2	5318.8000	80.45	15.26	95.71	999.00	-903.29	AVG	No Limit
3	5350.0000	39.55	15.32	54.87	74.00	-19.13	Peak	
4	5350.0000	31.04	15.32	46.36	999.00	-952.64	AVG	

**REMARKS:**

- (1) Measurement Value = Reading Level + Correct Factor.
- (2) Margin Level = Measurement Value - Limit Value.

Orthogonal Axis	X
Test Mode	UNII-2A_TX A Mode 5320 MHz

**Horizontal**

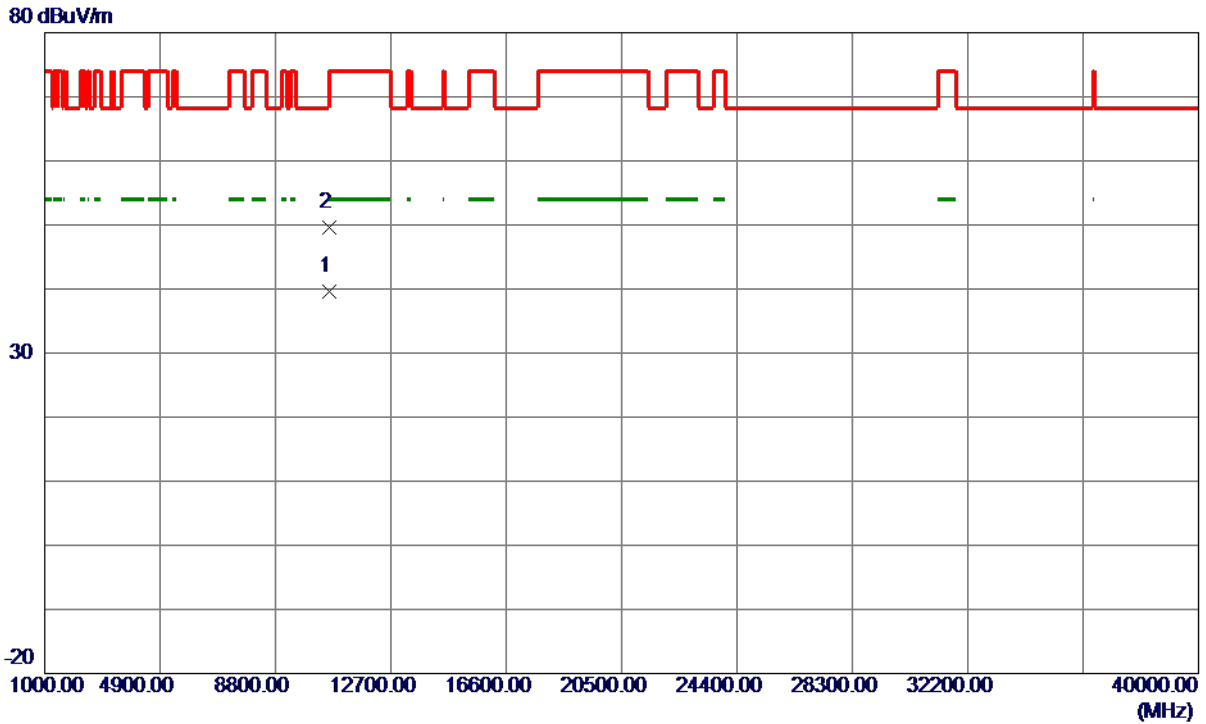

No.	Freq. MHz	Reading Level dBuV/m	Correct Factor dB	Measure ment dBuV/m	Limit dBuV/m	Margin dB	Detector	Comment
1 *	10634.5700	26.30	13.26	39.56	54.00	-14.44	AVG	
2	10638.8700	36.34	13.26	49.60	74.00	-24.40	Peak	

**REMARKS:**

- (1) Measurement Value = Reading Level + Correct Factor.
- (2) Margin Level = Measurement Value - Limit Value.



Orthogonal Axis	X
Test Mode	UNII-2A_TX N (HT20) Mode 5260 MHz

**Vertical**

130 dBuV/m

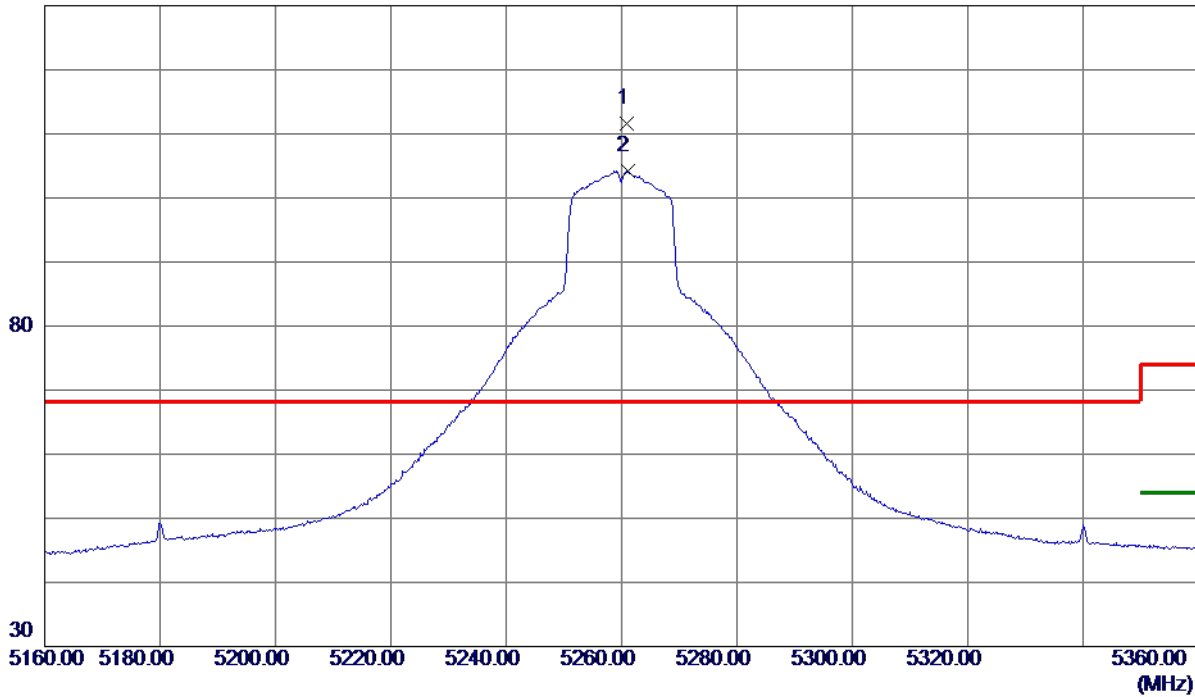

No.	Freq. MHz	Reading Level dBuV/m	Correct Factor dB	Measure ment dBuV/m	Limit dBuV/m	Margin dB	Detector	Comment
1 *	5260.9000	96.46	15.14	111.60	68.30	43.30	Peak	No Limit
2	5261.0000	89.04	15.14	104.18	999.00	-894.82	AVG	No Limit

**REMARKS:**

- (1) Measurement Value = Reading Level + Correct Factor.
- (2) Margin Level = Measurement Value - Limit Value.

Orthogonal Axis	X
Test Mode	UNII-2A_TX N (HT20) Mode 5260 MHz

**Vertical**

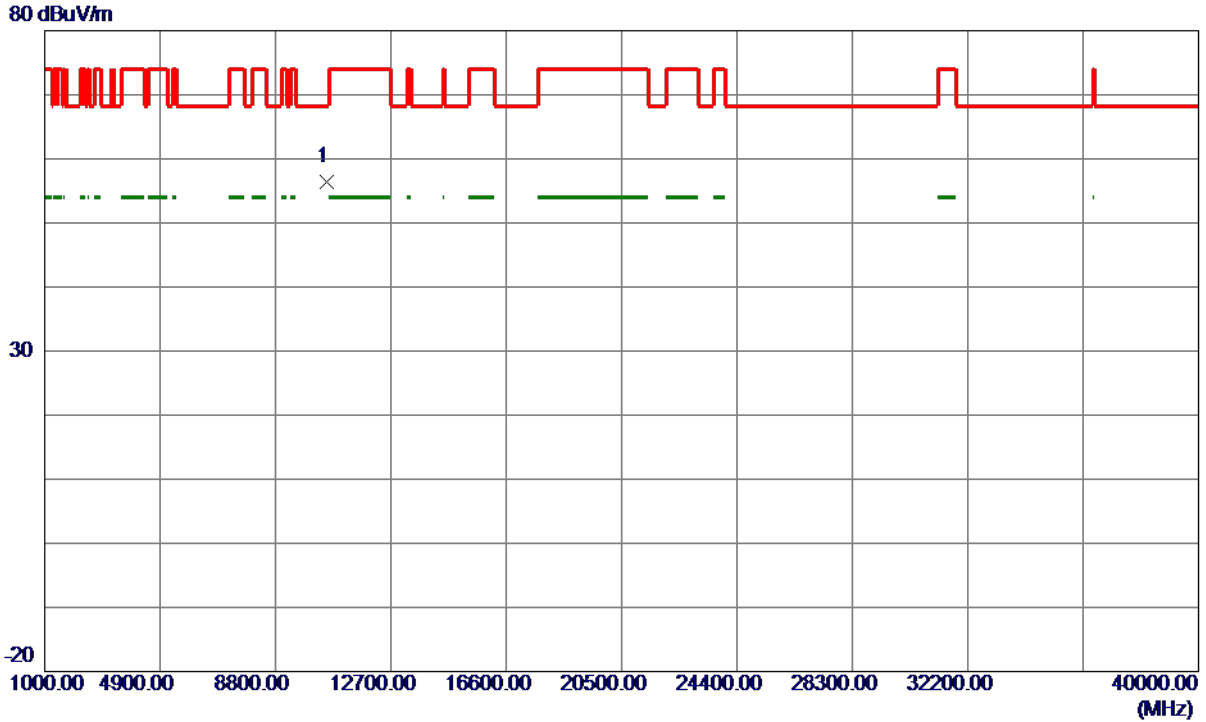

No.	Freq. MHz	Reading Level dBuV/m	Correct Factor dB	Measure ment dBuV/m	Limit dBuV/m	Margin dB	Detector	Comment
1 *	10522.4200	43.15	13.19	56.34	68.30	-11.96	Peak	

**REMARKS:**

- (1) Measurement Value = Reading Level + Correct Factor.
- (2) Margin Level = Measurement Value - Limit Value.

Orthogonal Axis	X
Test Mode	UNII-2A_TX N (HT20) Mode 5260 MHz

**Horizontal**

130 dBuV/m

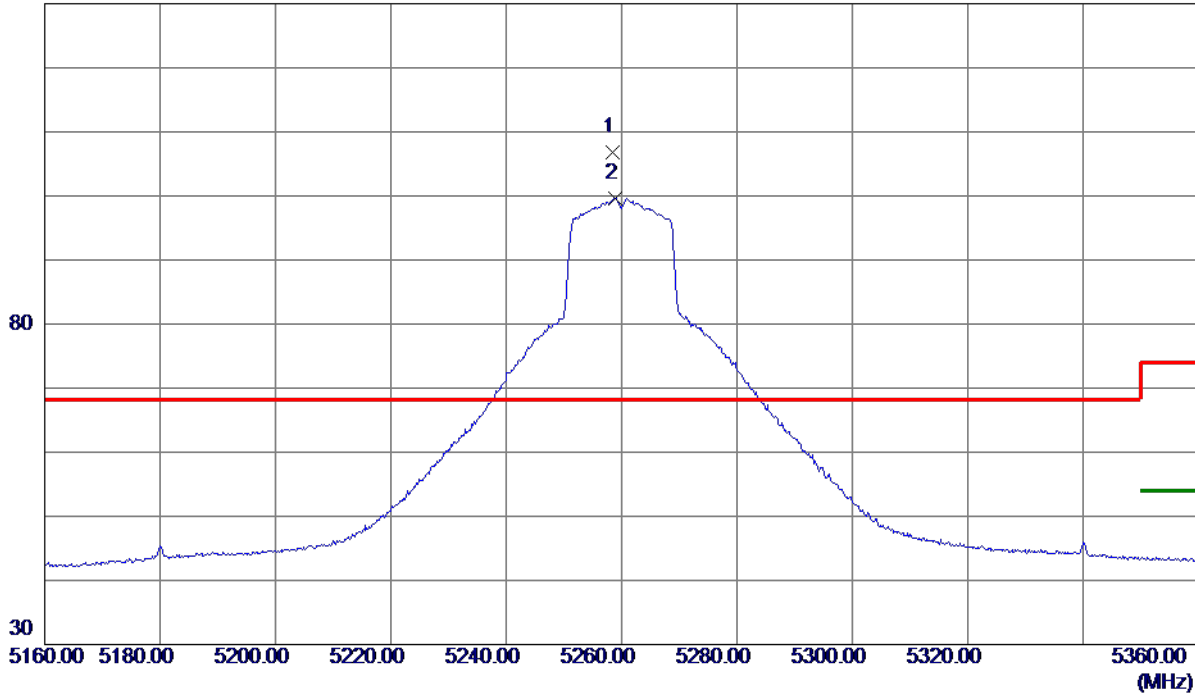

No.	Freq. MHz	Reading Level dBuV/m	Correct Factor dB	Measure ment dBuV/m	Limit dBuV/m	Margin dB	Detector	Comment
1 *	5258.5000	91.71	15.14	106.85	68.30	38.55	Peak	No Limit
2	5258.9000	84.50	15.14	99.64	999.00	-899.36	AVG	No Limit

**REMARKS:**

- (1) Measurement Value = Reading Level + Correct Factor.
- (2) Margin Level = Measurement Value - Limit Value.

Orthogonal Axis	X
Test Mode	UNII-2A_TX N (HT20) Mode 5260 MHz

**Horizontal**

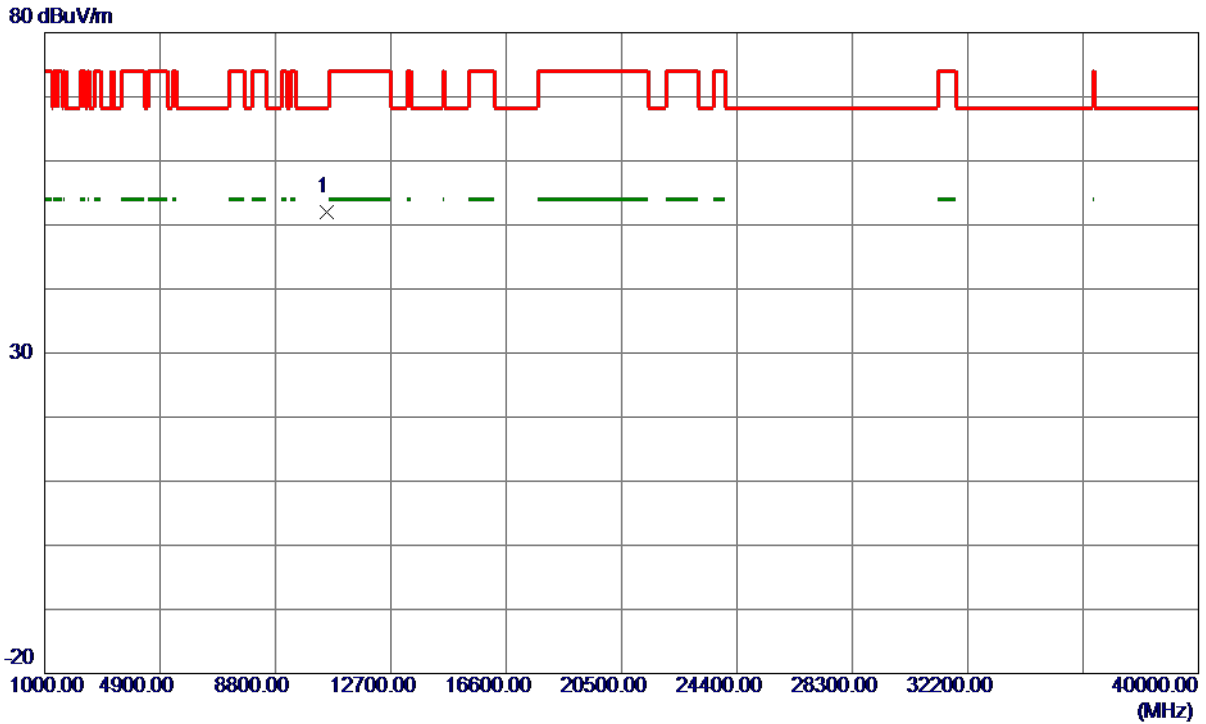

No.	Freq. MHz	Reading Level dBuV/m	Correct Factor dB	Measure ment dBuV/m	Limit dBuV/m	Margin dB	Detector	Comment
1 *	10513.9000	38.83	13.18	52.01	68.30	-16.29	Peak	

**REMARKS:**

- (1) Measurement Value = Reading Level + Correct Factor.
- (2) Margin Level = Measurement Value - Limit Value.

Orthogonal Axis	X
Test Mode	UNII-2A_TX N (HT20) Mode 5300 MHz

**Vertical**

130 dBuV/m

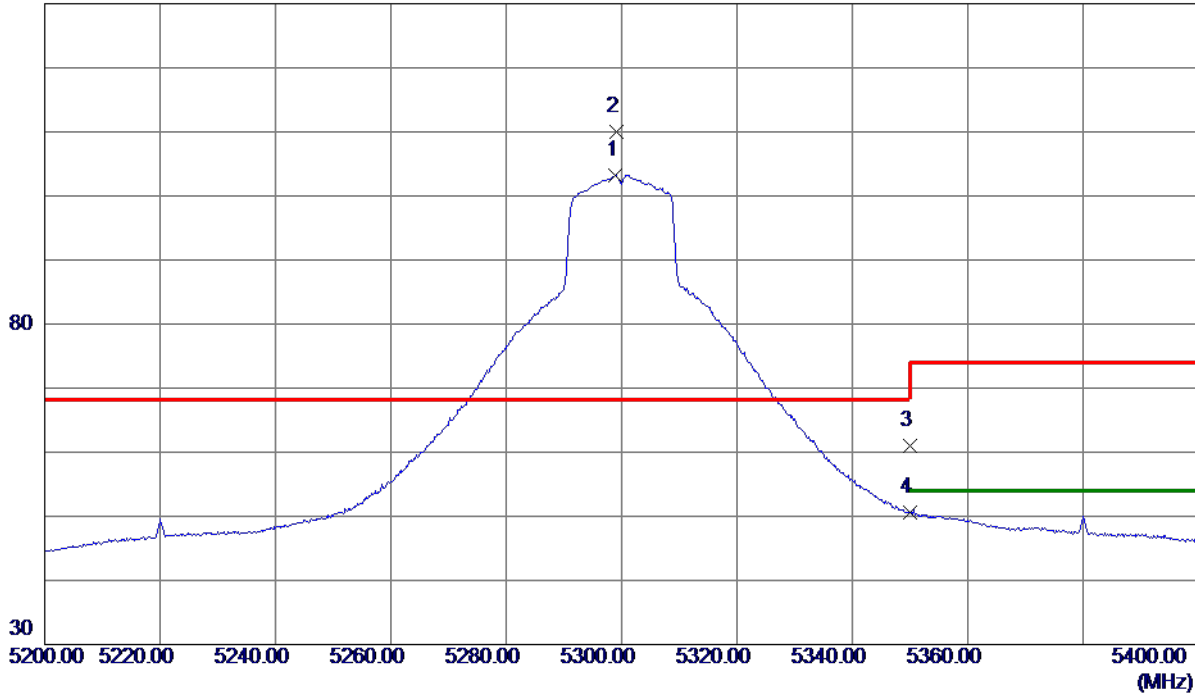

No.	Freq. MHz	Reading Level dBuV/m	Correct Factor dB	Measure ment dBuV/m	Limit dBuV/m	Margin dB	Detector	Comment
1	5299.0000	88.00	15.22	103.22	999.00	-895.78	AVG	No Limit
2 *	5299.2000	94.86	15.22	110.08	68.30	41.78	Peak	No Limit
3	5350.0000	45.72	15.32	61.04	74.00	-12.96	Peak	
4	5350.0000	35.21	15.32	50.53	999.00	-948.47	AVG	

**REMARKS:**

- (1) Measurement Value = Reading Level + Correct Factor.
- (2) Margin Level = Measurement Value - Limit Value.

Orthogonal Axis	X
Test Mode	UNII-2A_TX N (HT20) Mode 5300 MHz

**Vertical**

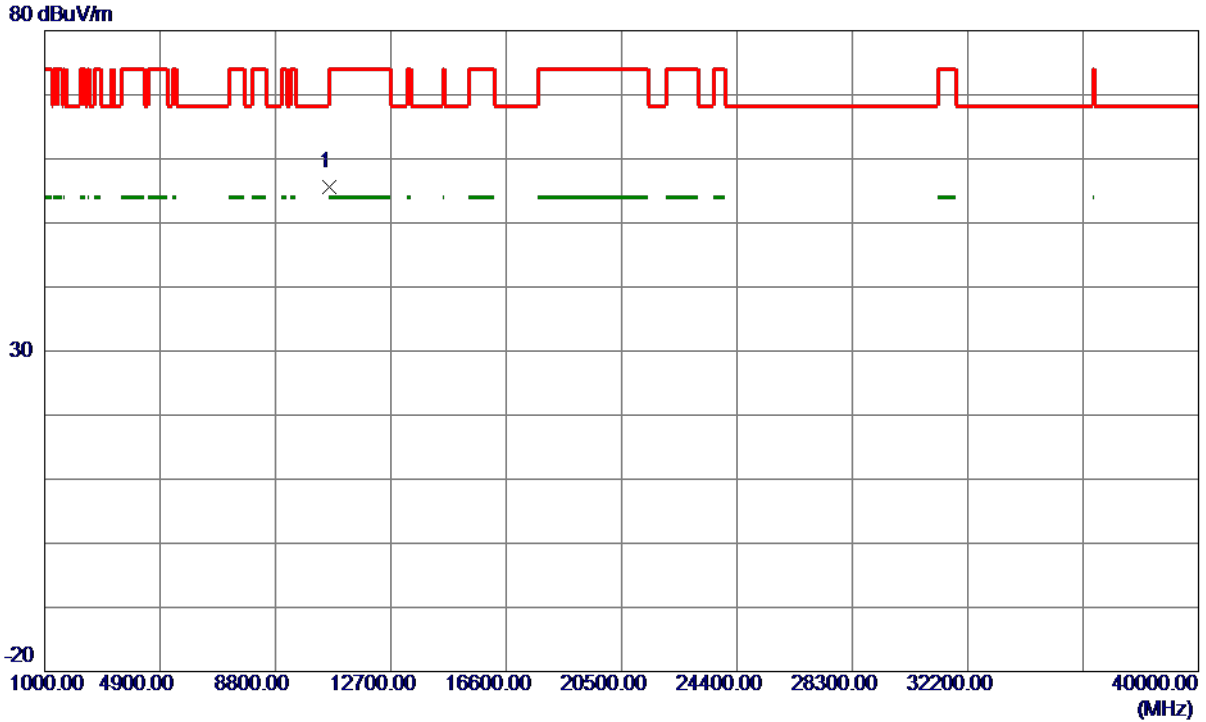

No.	Freq. MHz	Reading Level dBuV/m	Correct Factor dB	Measure ment dBuV/m	Limit dBuV/m	Margin dB	Detector	Comment
1 *	10598.6520	42.37	13.24	55.61	68.30	-12.69	Peak	

**REMARKS:**

- (1) Measurement Value = Reading Level + Correct Factor.
- (2) Margin Level = Measurement Value - Limit Value.

Orthogonal Axis	X
Test Mode	UNII-2A_TX N (HT20) Mode 5300 MHz

Horizontal

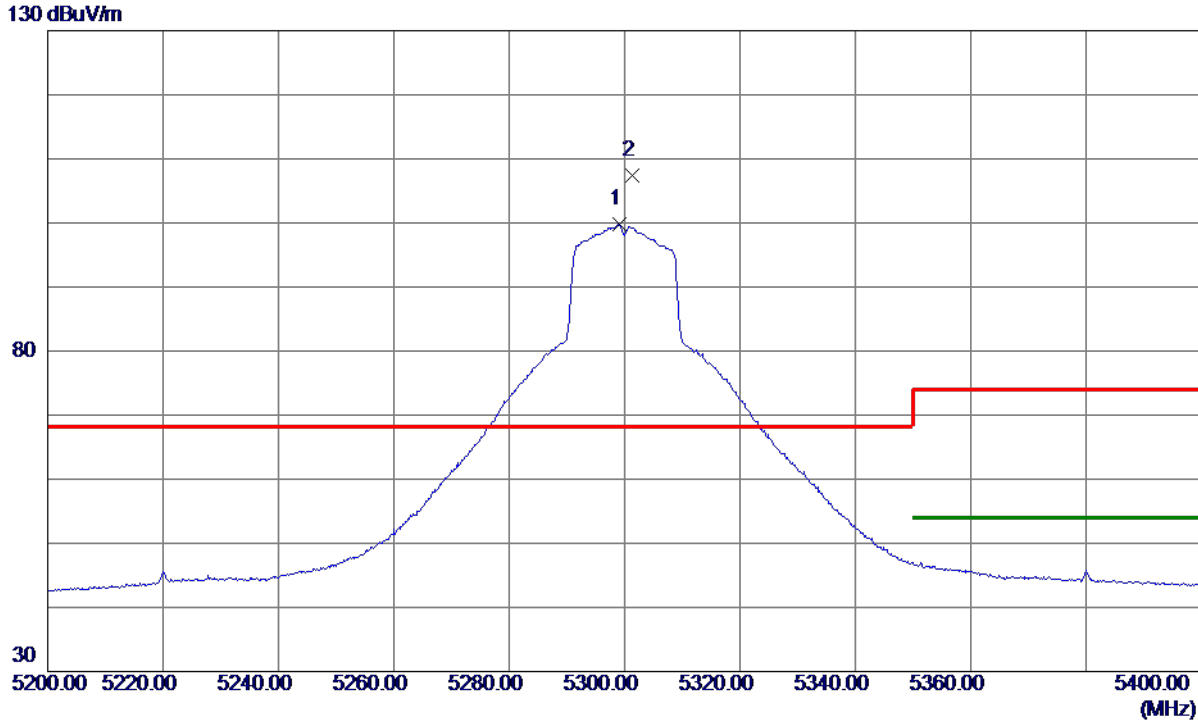

No.	Freq. MHz	Reading Level dBuV/m	Correct Factor dB	Measure ment dBuV/m	Limit dBuV/m	Margin dB	Detector	Comment
1	5299.1000	84.51	15.22	99.73	999.00	-899.27	AVG	No Limit
2 *	5301.4000	92.17	15.22	107.39	68.30	39.09	Peak	No Limit

REMARKS:

- (1) Measurement Value = Reading Level + Correct Factor.
- (2) Margin Level = Measurement Value - Limit Value.

Orthogonal Axis	X
Test Mode	UNII-2A_TX N (HT20) Mode 5300 MHz

**Horizontal**

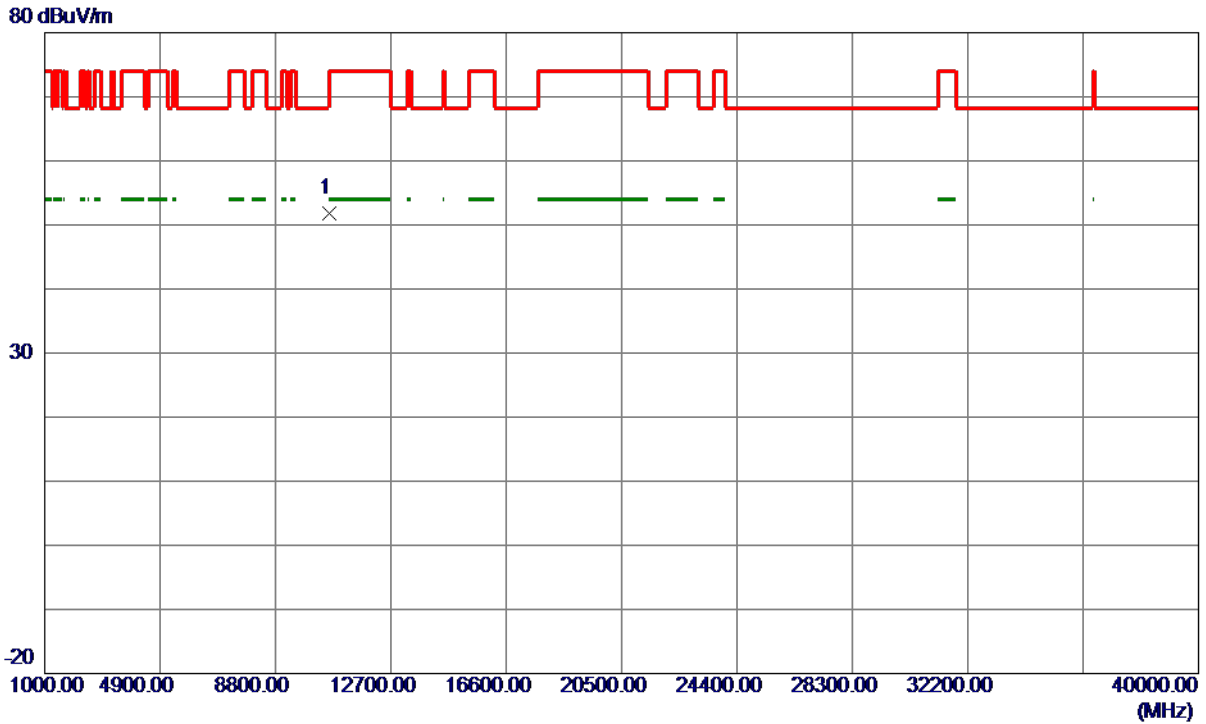

No.	Freq. MHz	Reading Level dBuV/m	Correct Factor dB	Measure ment dBuV/m	Limit dBuV/m	Margin dB	Detector	Comment
1 *	10599.8500	38.54	13.24	51.78	68.30	-16.52	Peak	

**REMARKS:**

- (1) Measurement Value = Reading Level + Correct Factor.
- (2) Margin Level = Measurement Value - Limit Value.



Orthogonal Axis	X
Test Mode	UNII-2A_TX N (HT20) Mode 5320 MHz

**Vertical**

130 dBuV/m

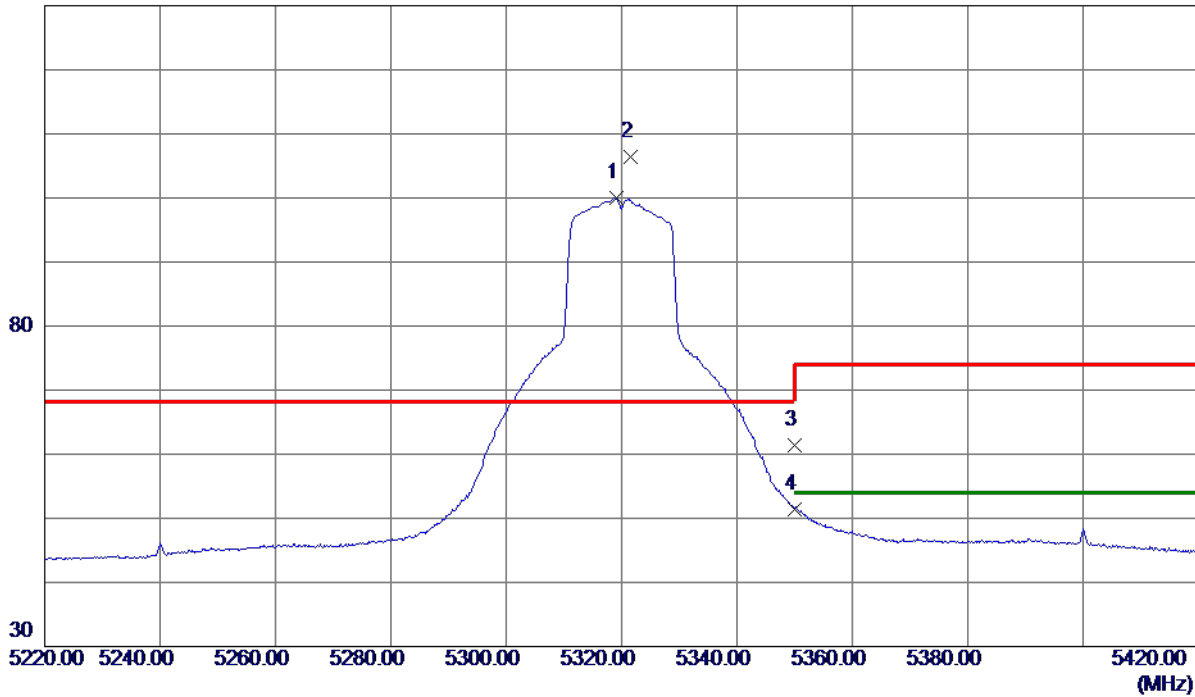

No.	Freq. MHz	Reading Level dBuV/m	Correct Factor dB	Measure ment dBuV/m	Limit dBuV/m	Margin dB	Detector	Comment
1	5319.1000	84.74	15.26	100.00	999.00	-899.00	AVG	No Limit
2 *	5321.5000	91.10	15.27	106.37	68.30	38.07	Peak	No Limit
3	5350.0000	46.05	15.32	61.37	74.00	-12.63	Peak	
4	5350.0000	36.17	15.32	51.49	999.00	-947.51	AVG	

**REMARKS:**

- (1) Measurement Value = Reading Level + Correct Factor.
- (2) Margin Level = Measurement Value - Limit Value.

Orthogonal Axis	X
Test Mode	UNII-2A_TX N (HT20) Mode 5320 MHz

**Vertical**

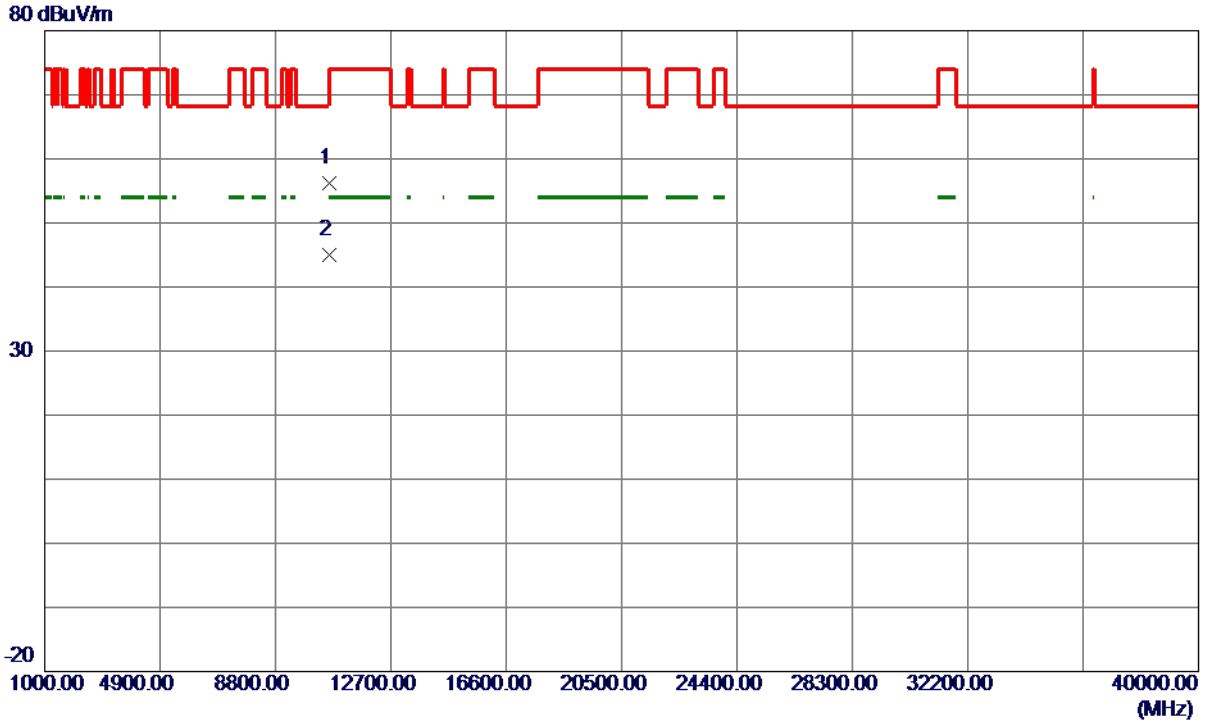

No.	Freq. MHz	Reading Level dBuV/m	Correct Factor dB	Measure ment dBuV/m	Limit dBuV/m	Margin dB	Detector	Comment
1	10637.9800	42.88	13.26	56.14	74.00	-17.86	Peak	
2 *	10639.9200	31.77	13.26	45.03	54.00	-8.97	AVG	

**REMARKS:**

- (1) Measurement Value = Reading Level + Correct Factor.
- (2) Margin Level = Measurement Value - Limit Value.

Orthogonal Axis	X
Test Mode	UNII-2A_TX N (HT20) Mode 5320 MHz

**Horizontal**

130 dBuV/m

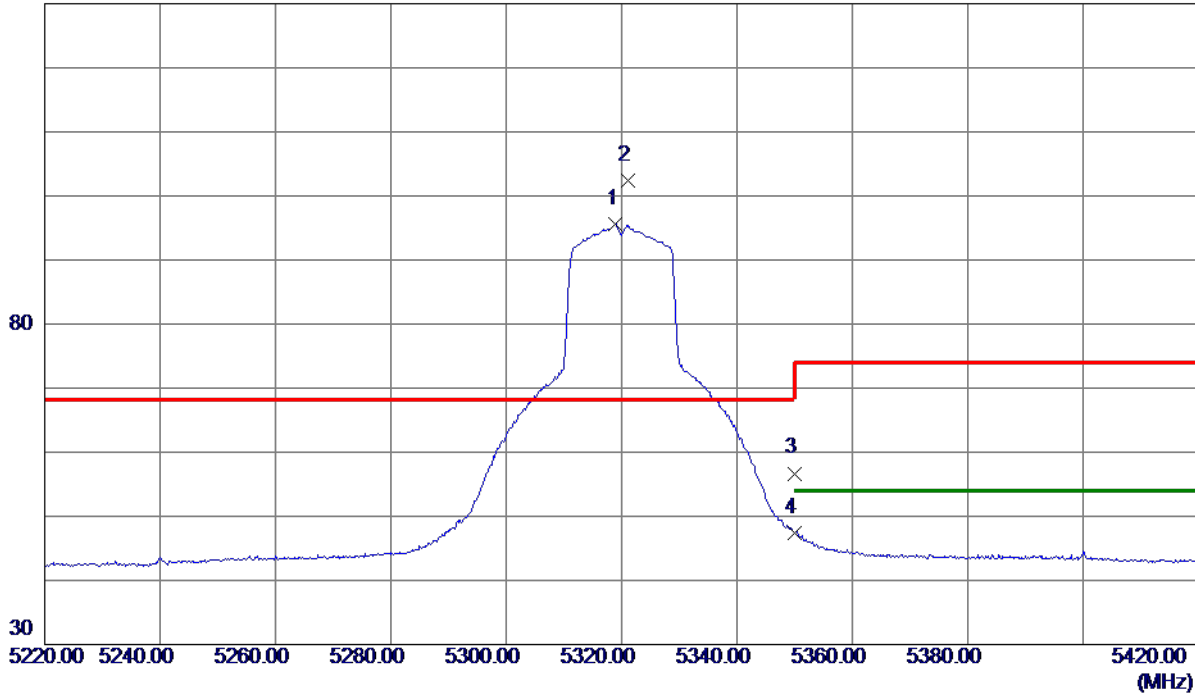

No.	Freq. MHz	Reading Level dBuV/m	Correct Factor dB	Measure ment dBuV/m	Limit dBuV/m	Margin dB	Detector	Comment
1	5319.0000	80.36	15.26	95.62	999.00	-903.38	AVG	No Limit
2 *	5321.2000	87.07	15.26	102.33	68.30	34.03	Peak	No Limit
3	5350.0000	41.38	15.32	56.70	74.00	-17.30	Peak	
4	5350.0000	32.02	15.32	47.34	999.00	-951.66	AVG	

**REMARKS:**

- (1) Measurement Value = Reading Level + Correct Factor.
- (2) Margin Level = Measurement Value - Limit Value.

Orthogonal Axis	X
Test Mode	UNII-2A_TX N (HT20) Mode 5320 MHz

**Horizontal**

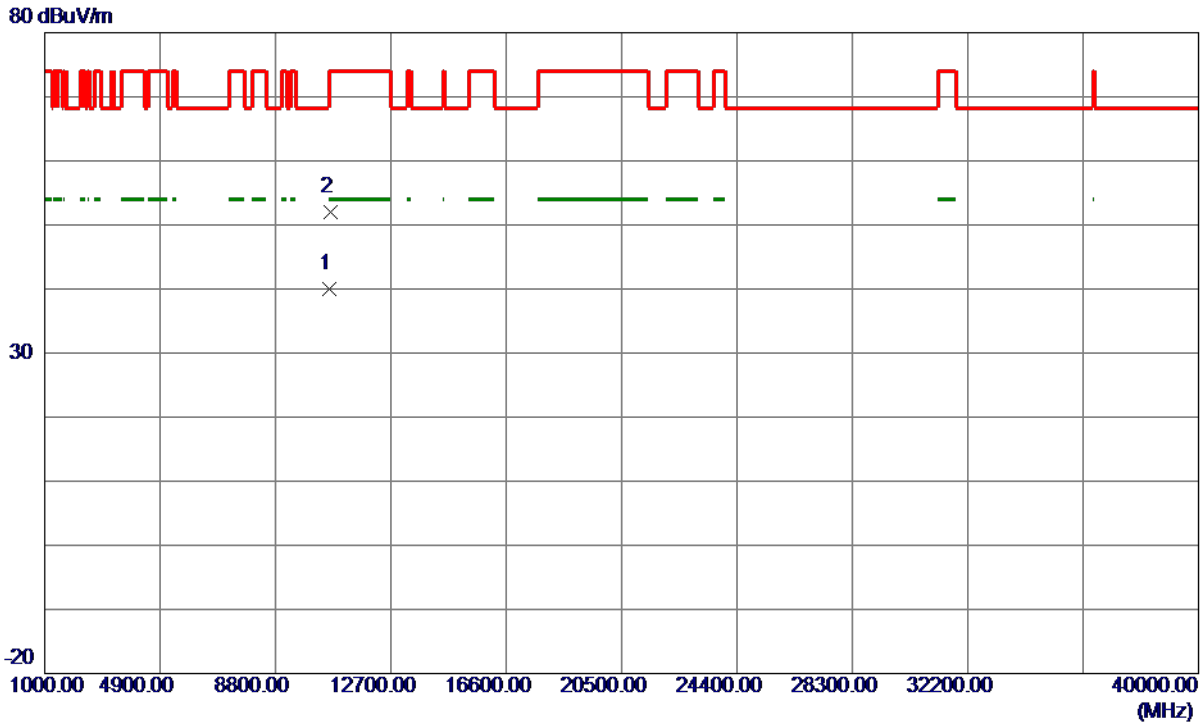

No.	Freq. MHz	Reading Level dBuV/m	Correct Factor dB	Measure ment dBuV/m	Limit dBuV/m	Margin dB	Detector	Comment
1 *	10638.3400	26.82	13.26	40.08	54.00	-13.92	AVG	
2	10643.8900	38.68	13.27	51.95	74.00	-22.05	Peak	

**REMARKS:**

- (1) Measurement Value = Reading Level + Correct Factor.
- (2) Margin Level = Measurement Value - Limit Value.

Orthogonal Axis	X
Test Mode	UNII-2A_TX N (HT40) Mode 5270 MHz

**Vertical**

130 dBuV/m

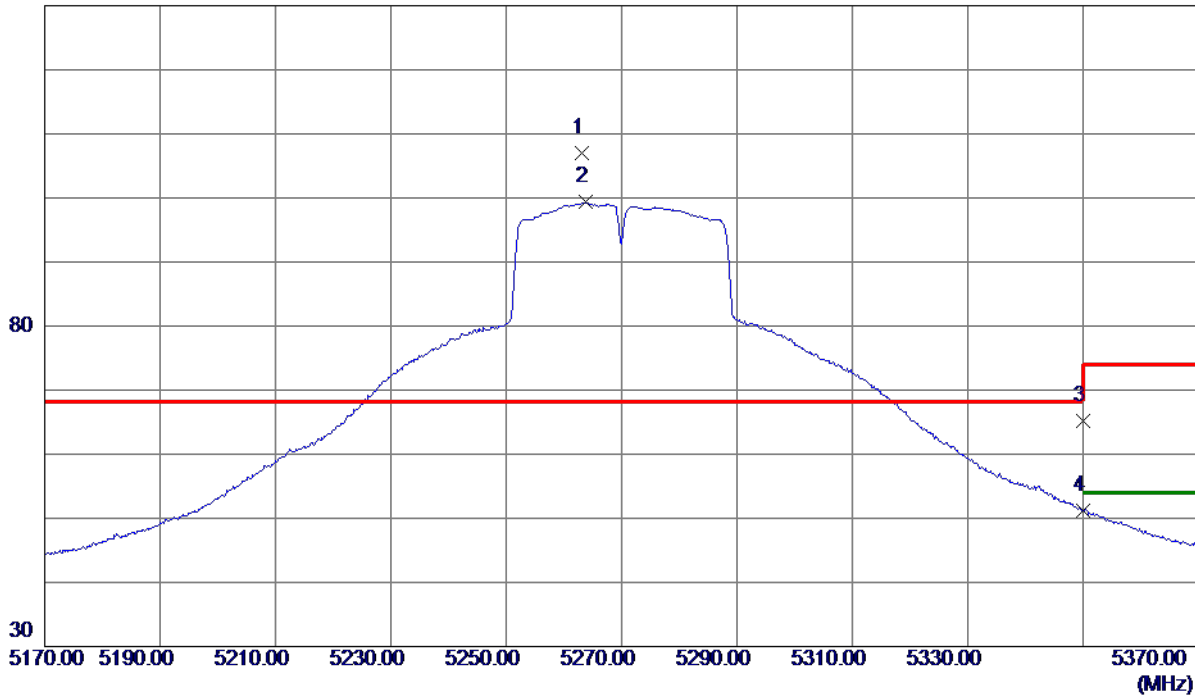

No.	Freq. MHz	Reading Level dBuV/m	Correct Factor dB	Measure ment dBuV/m	Limit dBuV/m	Margin dB	Detector	Comment
1 *	5263.2000	91.88	15.14	107.02	68.30	38.72	Peak	No Limit
2	5263.8000	84.24	15.15	99.39	999.00	-899.61	AVG	No Limit
3	5350.0000	49.88	15.32	65.20	74.00	-8.80	Peak	
4	5350.0000	35.86	15.32	51.18	999.00	-947.82	AVG	

**REMARKS:**

- (1) Measurement Value = Reading Level + Correct Factor.
- (2) Margin Level = Measurement Value - Limit Value.

Orthogonal Axis	X
Test Mode	UNII-2A_TX N (HT40) Mode 5270 MHz

Vertical

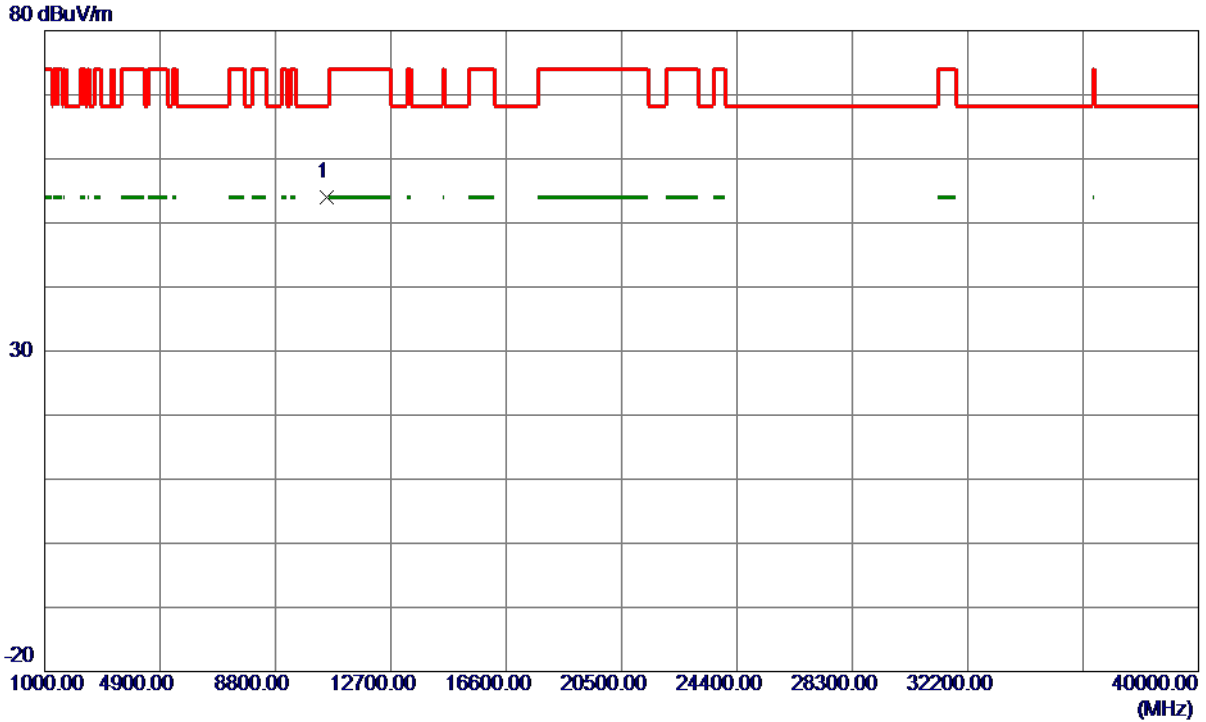

No.	Freq. MHz	Reading Level dBuV/m	Correct Factor dB	Measure ment dBuV/m	Limit dBuV/m	Margin dB	Detector	Comment
1 *	10539.7900	40.80	13.20	54.00	68.30	-14.30	Peak	

REMARKS:

- (1) Measurement Value = Reading Level + Correct Factor.
- (2) Margin Level = Measurement Value - Limit Value.

Orthogonal Axis	X
Test Mode	UNII-2A_TX N (HT40) Mode 5270 MHz

### Horizontal

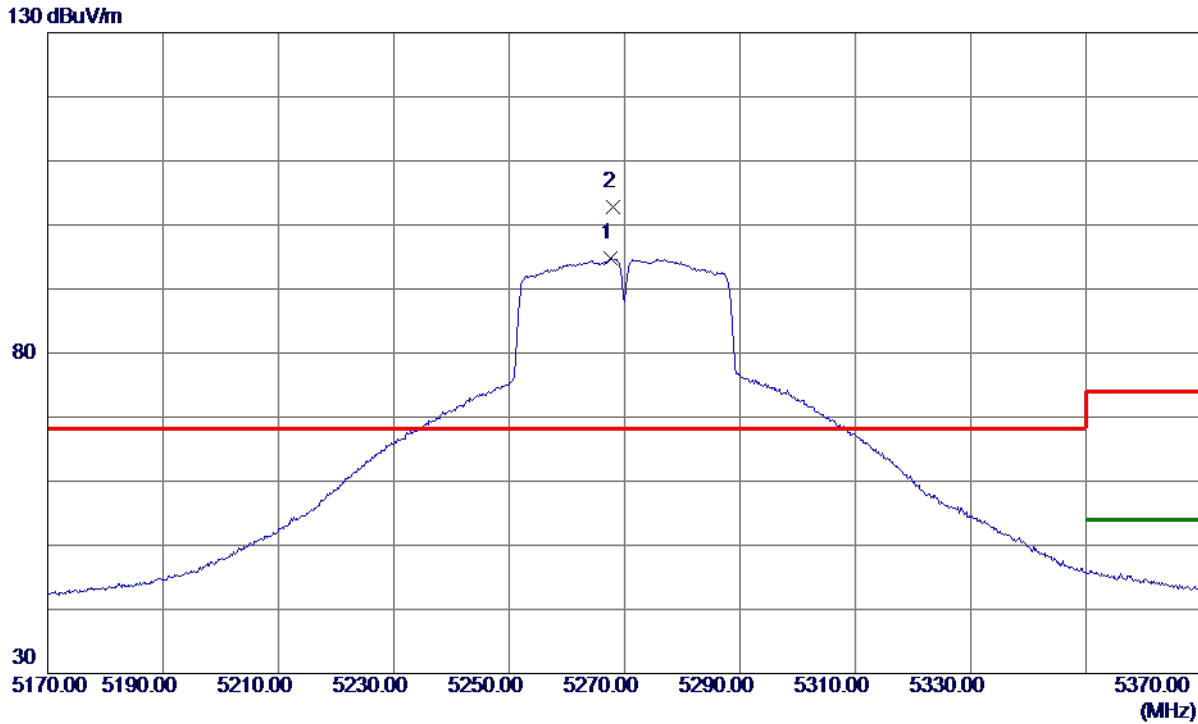

No.	Freq. MHz	Reading Level dBuV/m	Correct Factor dB	Measure ment dBuV/m	Limit dBuV/m	Margin dB	Detector	Comment
1	5267.5000	79.61	15.15	94.76	999.00	-904.24	AVG	No Limit
2 *	5268.0000	87.69	15.15	102.84	68.30	34.54	Peak	No Limit

**REMARKS:**

- (1) Measurement Value = Reading Level + Correct Factor.
- (2) Margin Level = Measurement Value - Limit Value.

Orthogonal Axis	X
Test Mode	UNII-2A_TX N (HT40) Mode 5270 MHz

**Horizontal**

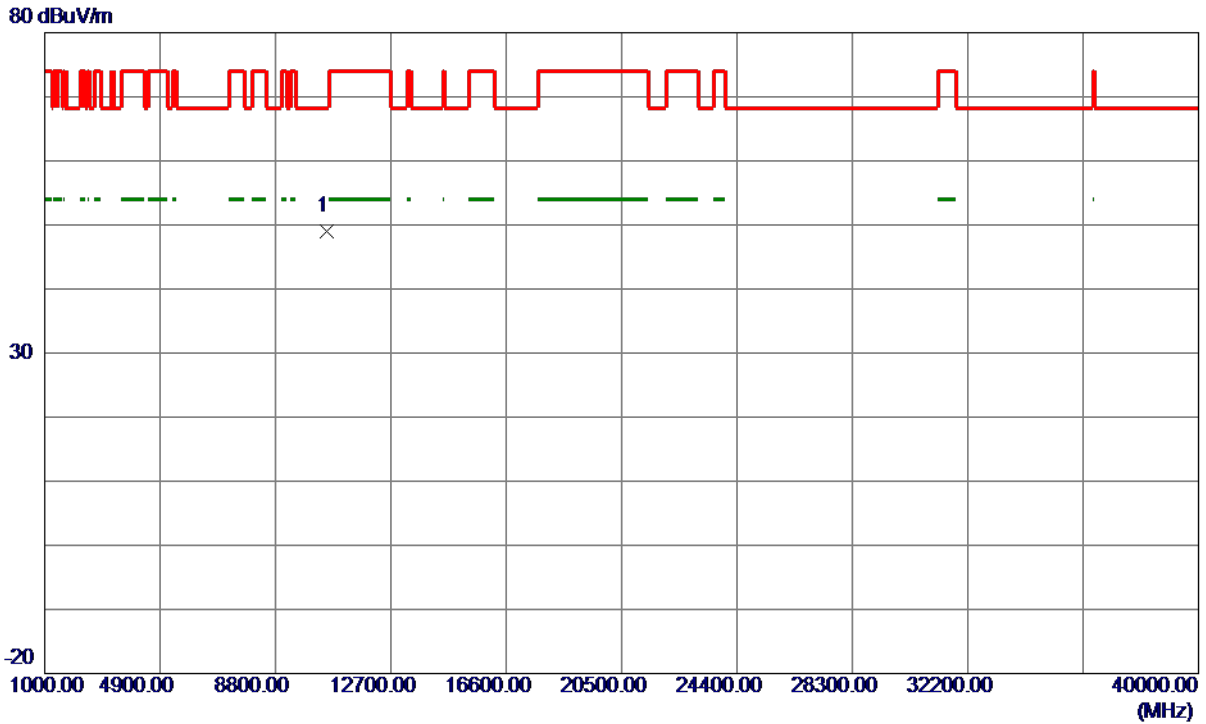

No.	Freq. MHz	Reading Level dBuV/m	Correct Factor dB	Measure ment dBuV/m	Limit dBuV/m	Margin dB	Detector	Comment
1 *	10546.0000	35.85	13.20	49.05	68.30	-19.25	Peak	

**REMARKS:**

- (1) Measurement Value = Reading Level + Correct Factor.
- (2) Margin Level = Measurement Value - Limit Value.



Orthogonal Axis	X
Test Mode	UNII-2A_TX N (HT40) Mode 5310 MHz

**Vertical**

130 dBuV/m

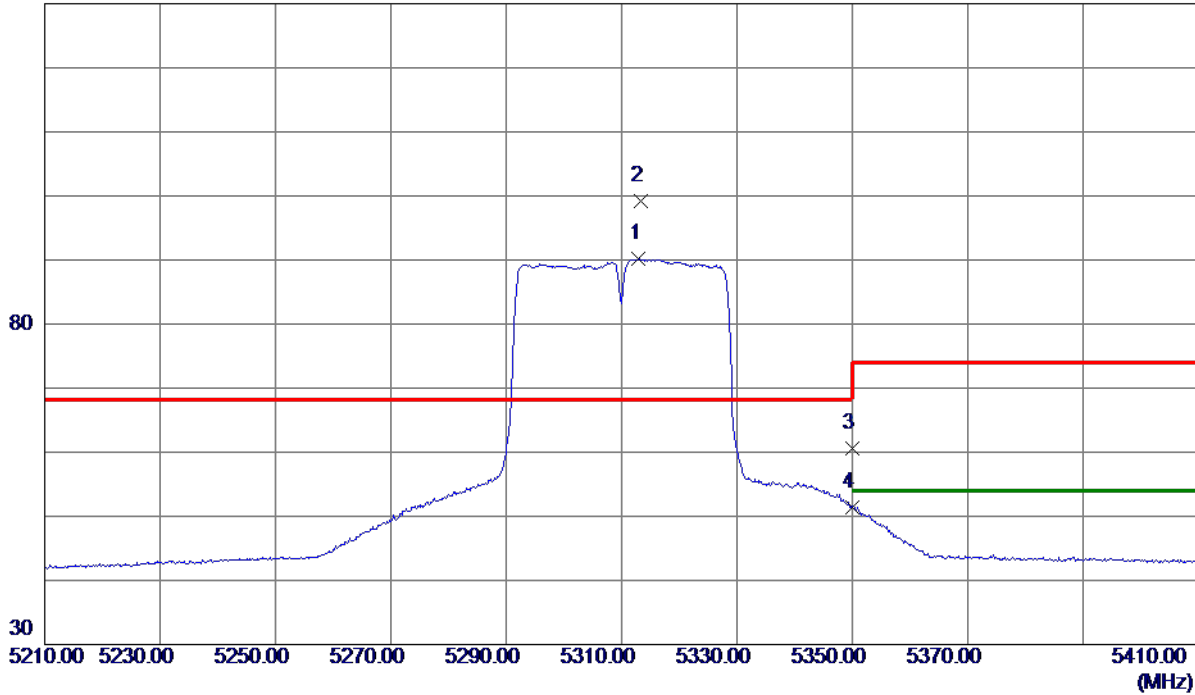

No.	Freq. MHz	Reading Level dBuV/m	Correct Factor dB	Measure ment dBuV/m	Limit dBuV/m	Margin dB	Detector	Comment
1	5313.0000	74.93	15.25	90.18	999.00	-908.82	AVG	No Limit
2 *	5313.3000	83.97	15.25	99.22	68.30	30.92	Peak	No Limit
3	5350.0000	45.36	15.32	60.68	74.00	-13.32	Peak	
4	5350.0000	36.15	15.32	51.47	999.00	-947.53	AVG	

**REMARKS:**

- (1) Measurement Value = Reading Level + Correct Factor.
- (2) Margin Level = Measurement Value - Limit Value.

Orthogonal Axis	X
Test Mode	UNII-2A_TX N (HT40) Mode 5310 MHz

**Vertical**

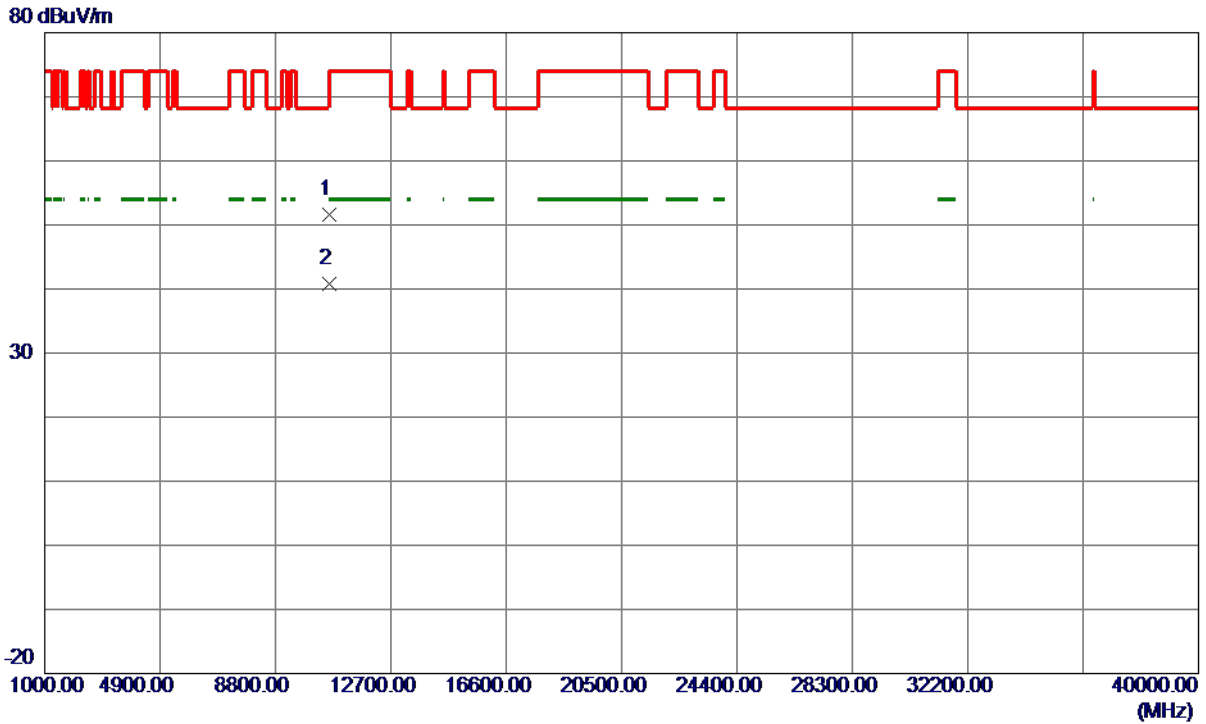

No.	Freq. MHz	Reading Level dBuV/m	Correct Factor dB	Measure ment dBuV/m	Limit dBuV/m	Margin dB	Detector	Comment
1	10618.0900	38.41	13.25	51.66	74.00	-22.34	Peak	
2 *	10621.0199	27.52	13.25	40.77	54.00	-13.23	AVG	

**REMARKS:**

- (1) Measurement Value = Reading Level + Correct Factor.
- (2) Margin Level = Measurement Value - Limit Value.

Orthogonal Axis	X
Test Mode	UNII-2A_TX N (HT40) Mode 5310 MHz

### Horizontal

130 dBuV/m

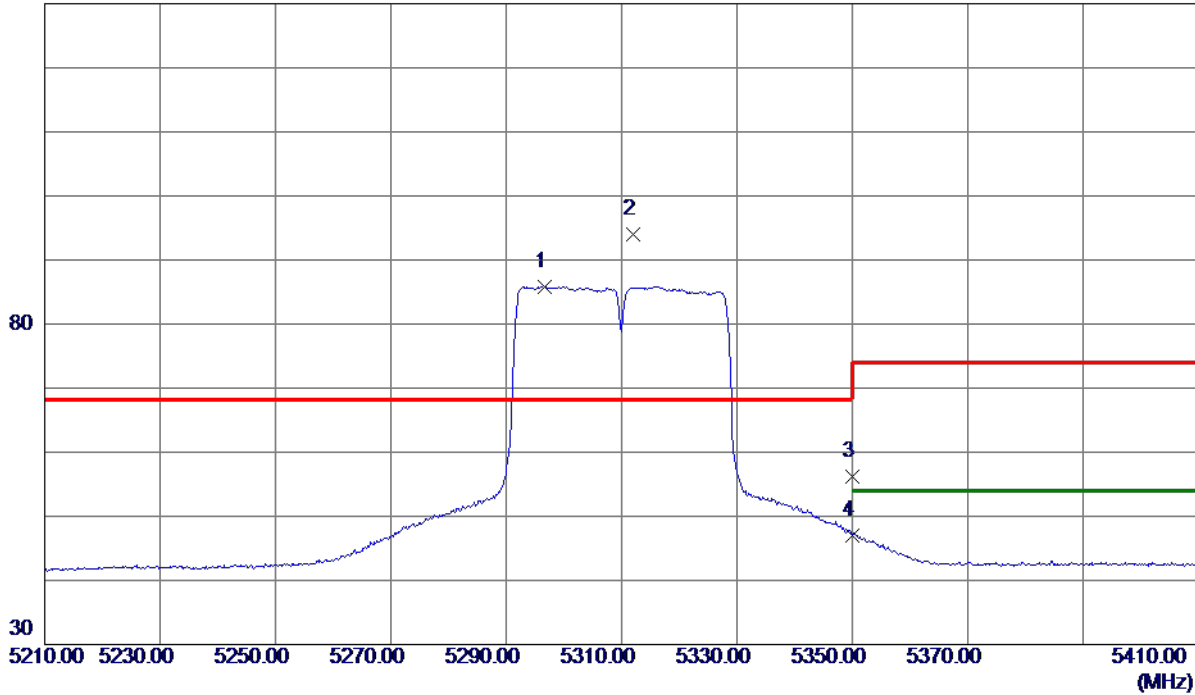

No.	Freq. MHz	Reading Level dBuV/m	Correct Factor dB	Measure ment dBuV/m	Limit dBuV/m	Margin dB	Detector	Comment
1	5296.7000	70.66	15.21	85.87	999.00	-913.13	AVG	No Limit
2 *	5312.0000	78.81	15.25	94.06	68.30	25.76	Peak	No Limit
3	5350.0000	40.88	15.32	56.20	74.00	-17.80	Peak	
4	5350.0000	31.66	15.32	46.98	999.00	-952.02	AVG	

**REMARKS:**

- (1) Measurement Value = Reading Level + Correct Factor.
- (2) Margin Level = Measurement Value - Limit Value.

Orthogonal Axis	X
Test Mode	UNII-2A_TX N (HT40) Mode 5310 MHz

**Horizontal**

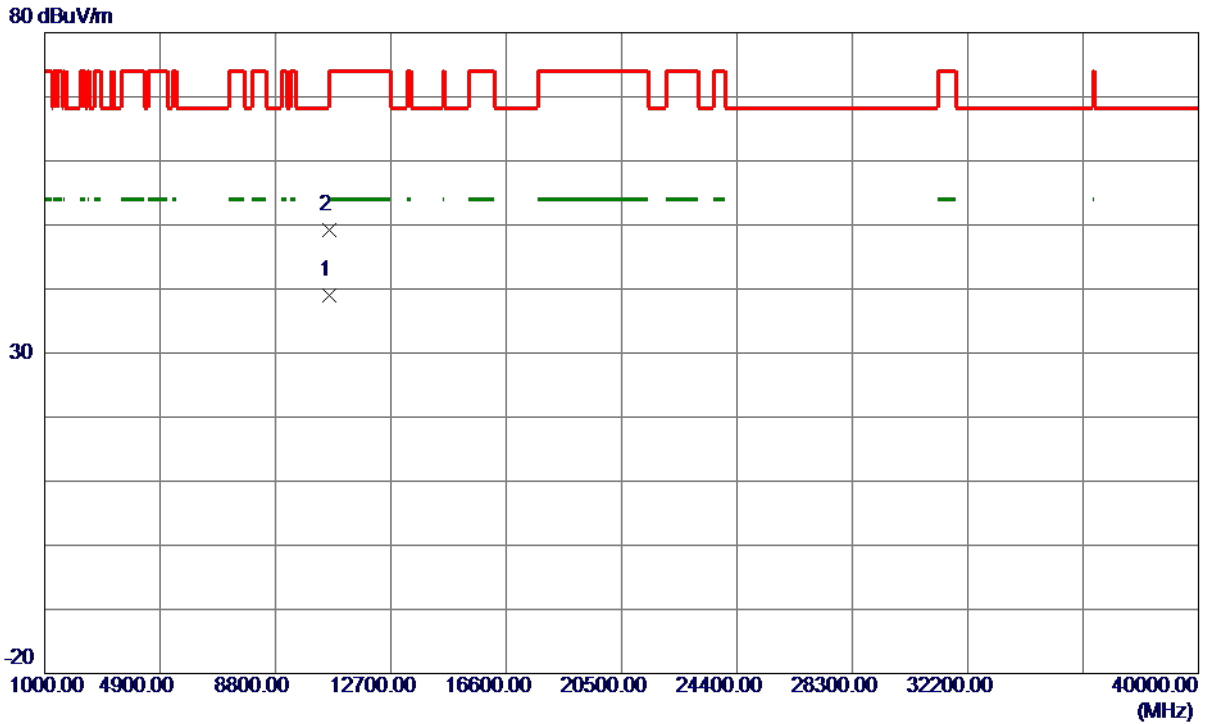

No.	Freq. MHz	Reading Level dBuV/m	Correct Factor dB	Measure ment dBuV/m	Limit dBuV/m	Margin dB	Detector	Comment
1 *	10618.9400	25.67	13.25	38.92	54.00	-15.08	AVG	
2	10628.1100	35.91	13.26	49.17	74.00	-24.83	Peak	

**REMARKS:**

- (1) Measurement Value = Reading Level + Correct Factor.
- (2) Margin Level = Measurement Value - Limit Value.

Orthogonal Axis	X
Test Mode	UNII-2C_TX A Mode 5500 MHz

Vertical

130 dBuV/m

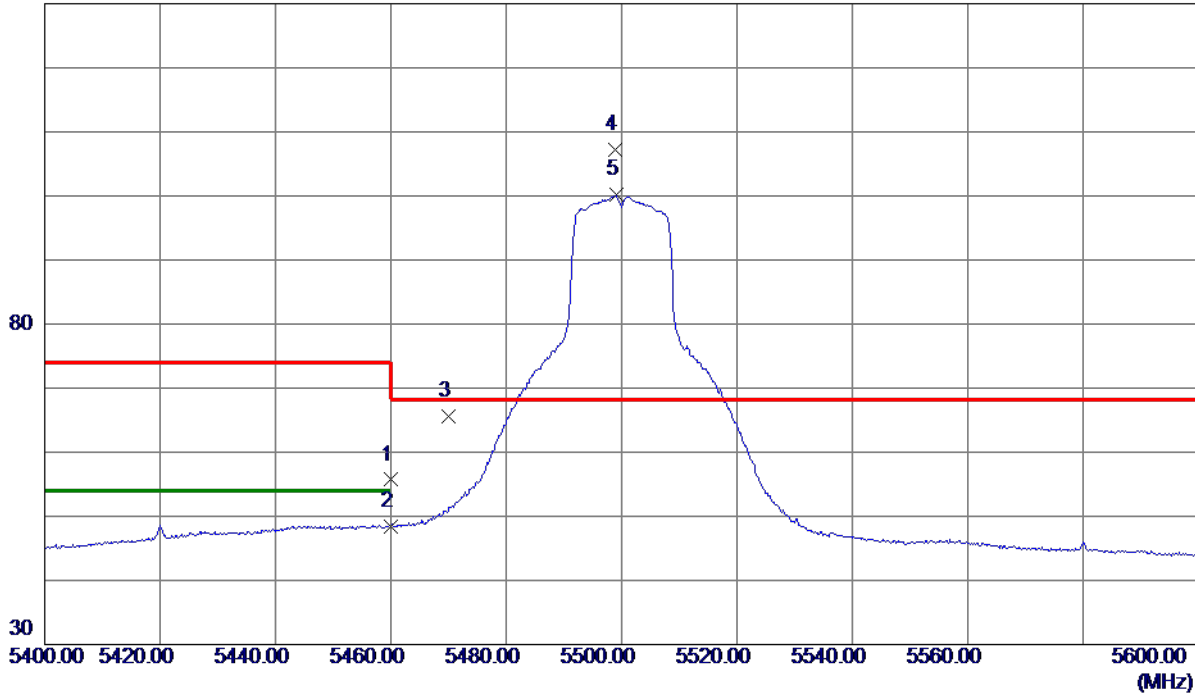

No.	Freq. MHz	Reading Level dBuV/m	Correct Factor dB	Measurement dBuV/m	Limit dBuV/m	Margin dB	Detector	Comment
1	5460.0000	40.15	15.55	55.70	74.00	-18.30	Peak	
2	5460.0000	32.84	15.55	48.39	54.00	-5.61	AVG	
3	5470.0000	49.99	15.57	65.56	68.30	-2.74	Peak	
4 *	5498.8000	91.50	15.63	107.13	68.30	38.83	Peak	No Limit
5	5499.1000	84.50	15.63	100.13	999.00	-898.87	AVG	No Limit

REMARKS:

- (1) Measurement Value = Reading Level + Correct Factor.
- (2) Margin Level = Measurement Value - Limit Value.

Orthogonal Axis	X
Test Mode	UNII-2C_TX A Mode 5500 MHz

**Vertical**

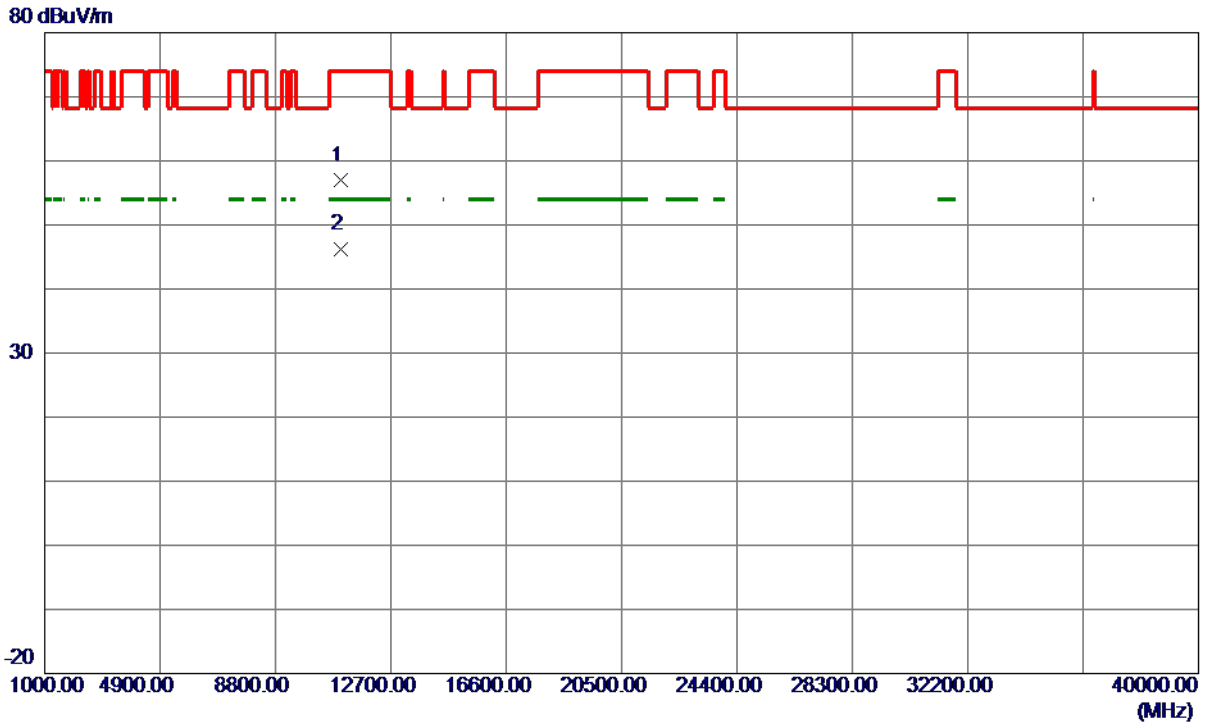

No.	Freq. MHz	Reading Level dBuV/m	Correct Factor dB	Measure ment dBuV/m	Limit dBuV/m	Margin dB	Detector	Comment
1	10997.7000	43.41	13.49	56.90	74.00	-17.10	Peak	
2 *	10999.3000	32.75	13.49	46.24	54.00	-7.76	AVG	

**REMARKS:**

- (1) Measurement Value = Reading Level + Correct Factor.
- (2) Margin Level = Measurement Value - Limit Value.

Orthogonal Axis	X
Test Mode	UNII-2C_TX A Mode 5500 MHz

Horizontal

130 dBuV/m

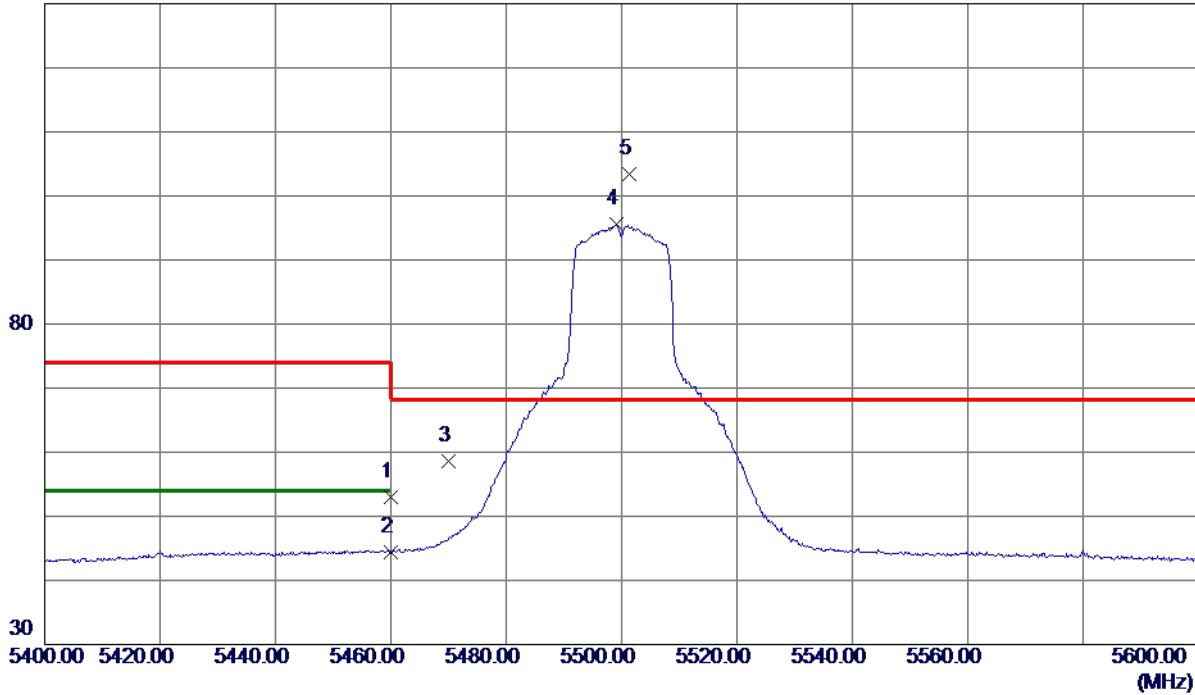

No.	Freq. MHz	Reading Level dBuV/m	Correct Factor dB	Measure ment dBuV/m	Limit dBuV/m	Margin dB	Detector	Comment
1	5460.0000	37.46	15.55	53.01	74.00	-20.99	Peak	
2	5460.0000	28.91	15.55	44.46	54.00	-9.54	AVG	
3	5470.0000	43.04	15.57	58.61	68.30	-9.69	Peak	
4	5499.2000	79.95	15.63	95.58	999.00	-903.42	AVG	No Limit
5 *	5501.4000	87.78	15.64	103.42	68.30	35.12	Peak	No Limit

REMARKS:

- (1) Measurement Value = Reading Level + Correct Factor.
- (2) Margin Level = Measurement Value - Limit Value.

Orthogonal Axis	X
Test Mode	UNII-2C_TX A Mode 5500 MHz

**Horizontal**

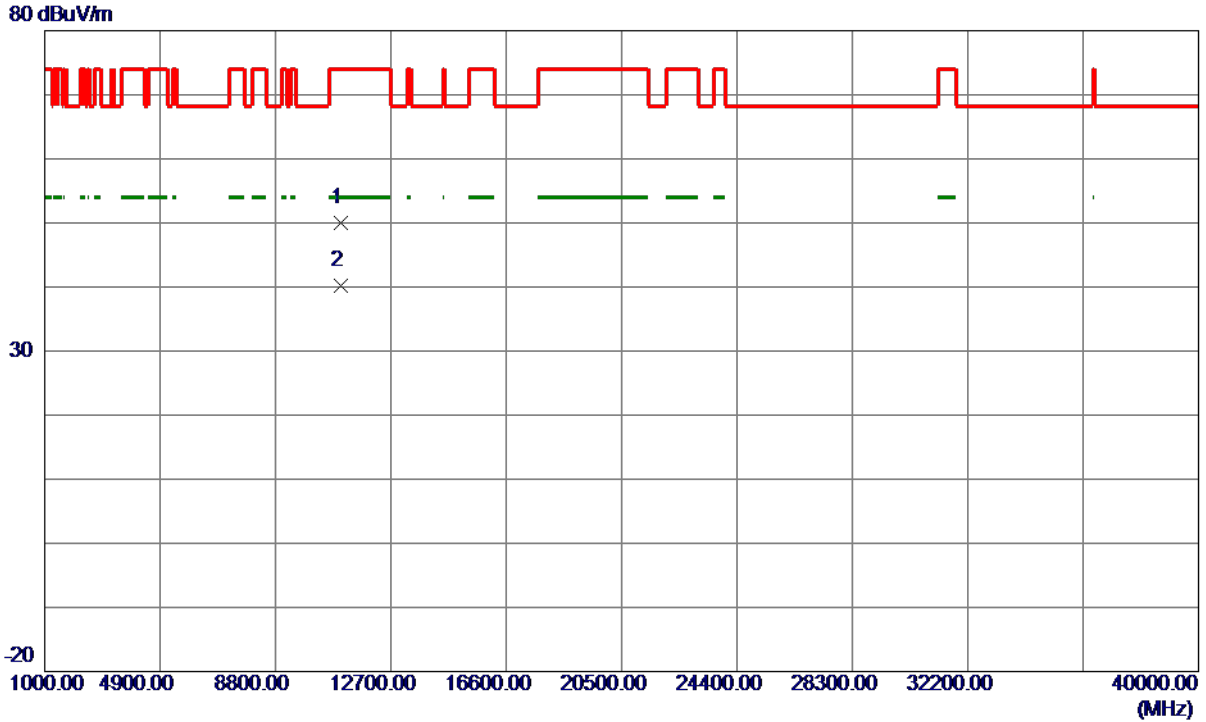

No.	Freq. MHz	Reading Level dBuV/m	Correct Factor dB	Measure ment dBuV/m	Limit dBuV/m	Margin dB	Detector	Comment
1	10996.6000	36.60	13.49	50.09	74.00	-23.91	Peak	
2 *	11002.2000	26.76	13.49	40.25	54.00	-13.75	AVG	

**REMARKS:**

- (1) Measurement Value = Reading Level + Correct Factor.
- (2) Margin Level = Measurement Value - Limit Value.



Orthogonal Axis	X
Test Mode	UNII-2C_TX A Mode 5580 MHz

Vertical

130 dBuV/m

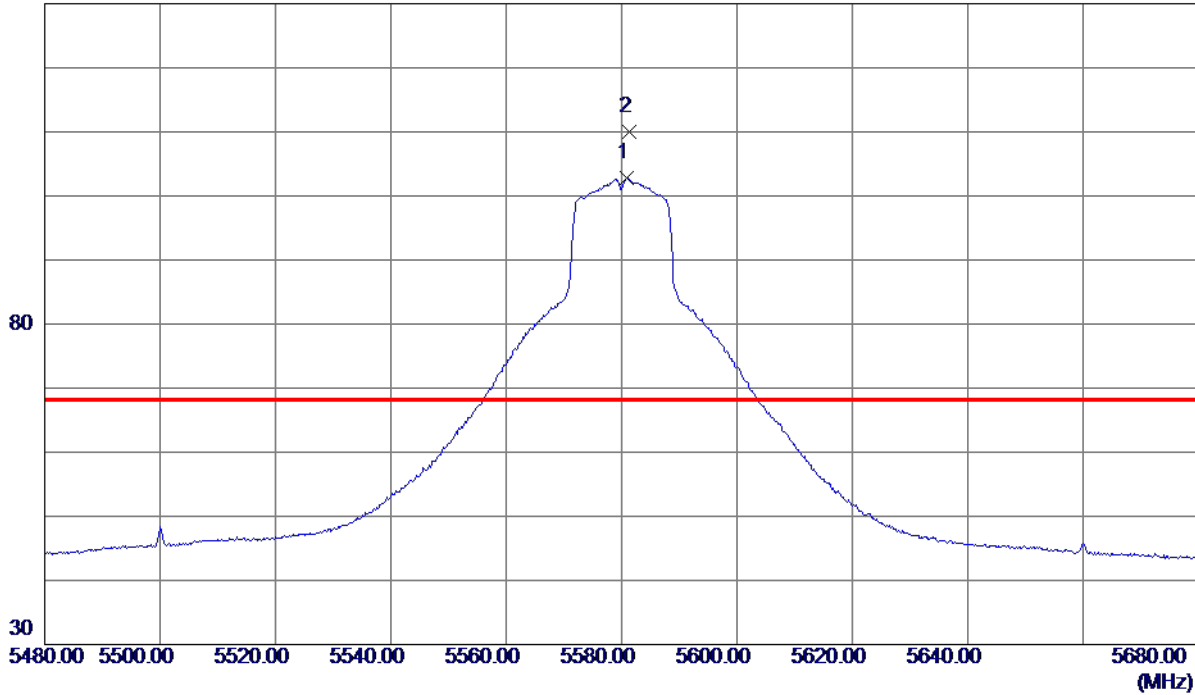

No.	Freq. MHz	Reading Level dBuV/m	Correct Factor dB	Measure ment dBuV/m	Limit dBuV/m	Margin dB	Detector	Comment
1	5580.9000	86.78	15.95	102.73	999.00	-896.27	AVG	No Limit
2 *	5581.3000	94.06	15.96	110.02	68.30	41.72	Peak	No Limit

REMARKS:

- (1) Measurement Value = Reading Level + Correct Factor.
- (2) Margin Level = Measurement Value - Limit Value.

Orthogonal Axis	X
Test Mode	UNII-2C_TX A Mode 5580 MHz

**Vertical**

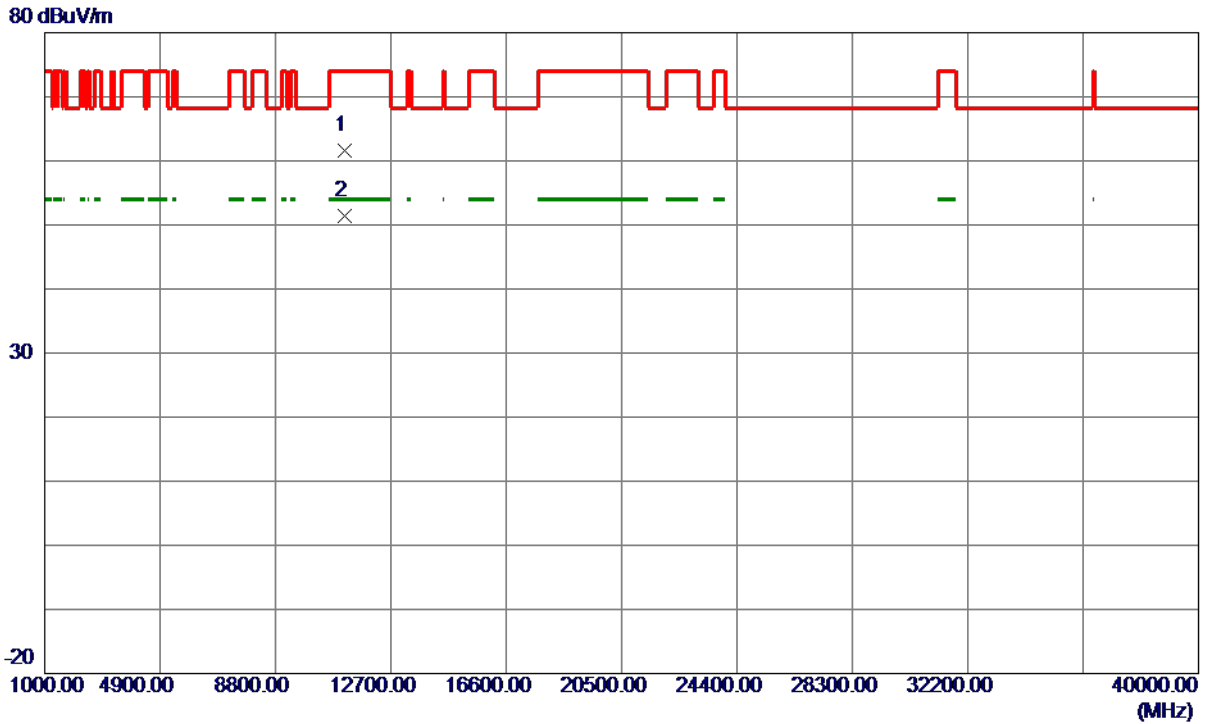

No.	Freq. MHz	Reading Level dBuV/m	Correct Factor dB	Measure ment dBuV/m	Limit dBuV/m	Margin dB	Detector	Comment
1	11155.5000	47.90	13.68	61.58	74.00	-12.42	Peak	
2 *	11157.2000	37.67	13.68	51.35	54.00	-2.65	AVG	

**REMARKS:**

- (1) Measurement Value = Reading Level + Correct Factor.
- (2) Margin Level = Measurement Value - Limit Value.

Orthogonal Axis	X
Test Mode	UNII-2C_TX A Mode 5580 MHz

**Horizontal**

130 dBuV/m

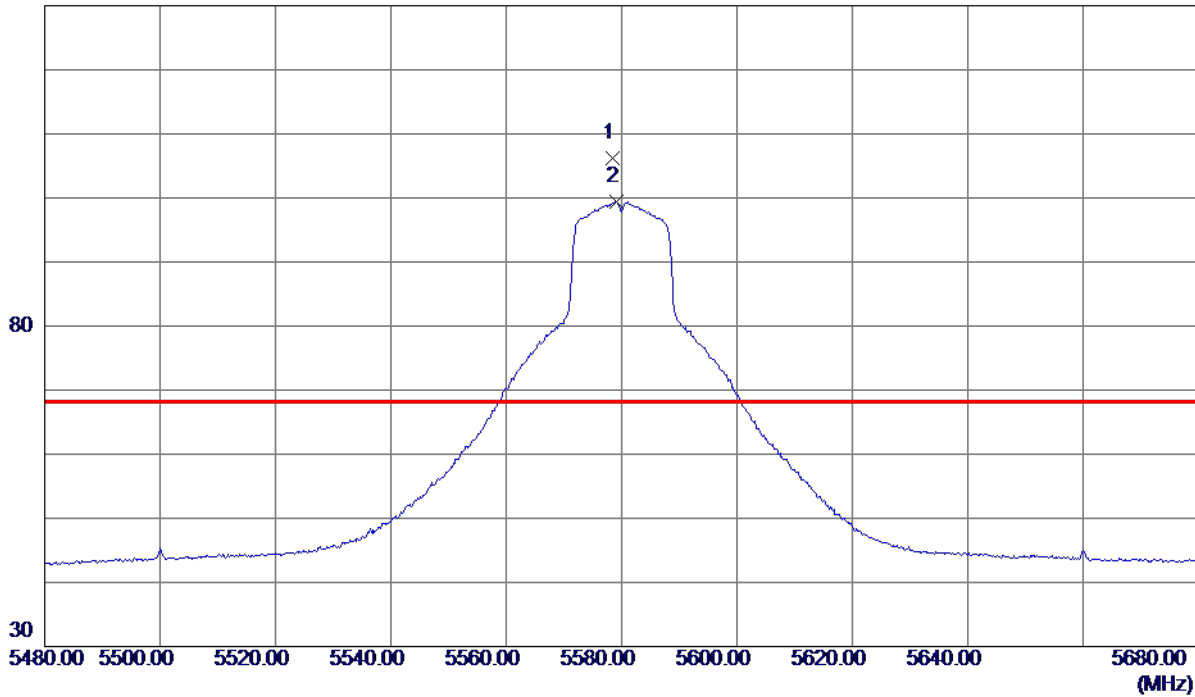

No.	Freq. MHz	Reading Level dBuV/m	Correct Factor dB	Measure ment dBuV/m	Limit dBuV/m	Margin dB	Detector	Comment
1 *	5578.4000	90.28	15.94	106.22	68.30	37.92	Peak	No Limit
2	5579.2000	83.51	15.95	99.46	999.00	-899.54	AVG	No Limit

**REMARKS:**

- (1) Measurement Value = Reading Level + Correct Factor.
- (2) Margin Level = Measurement Value - Limit Value.

Orthogonal Axis	X
Test Mode	UNII-2C_TX A Mode 5580 MHz

**Horizontal**

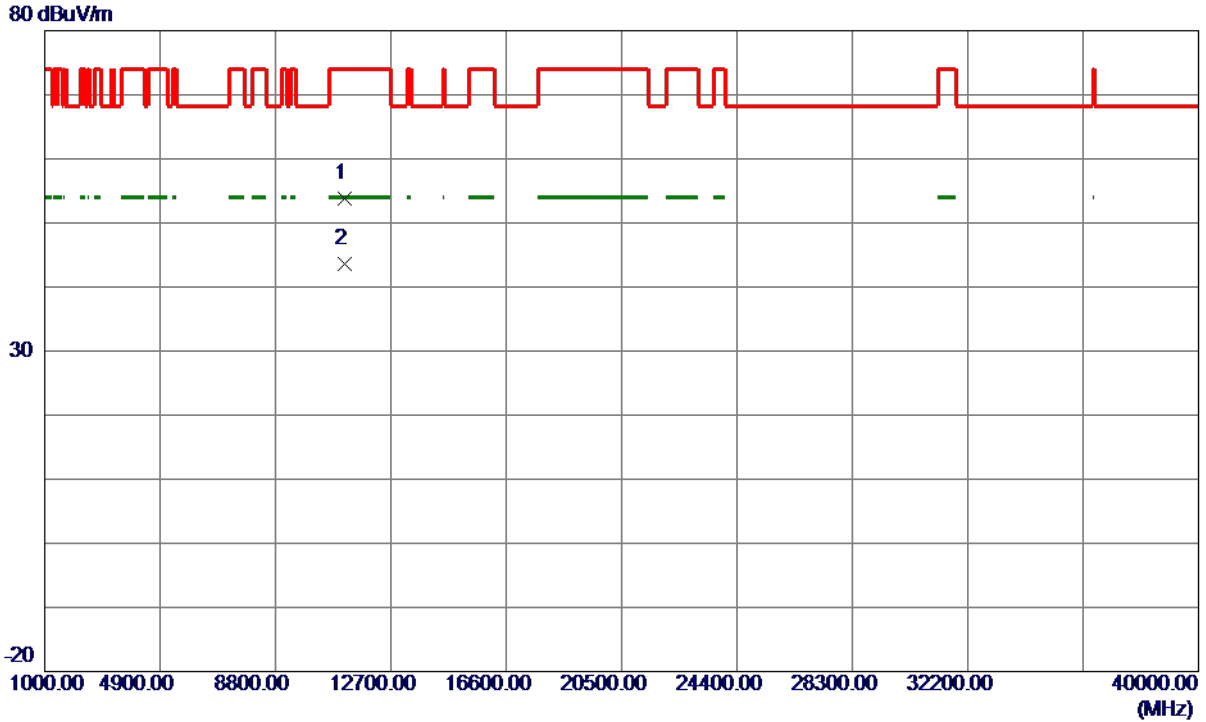

No.	Freq. MHz	Reading Level dBuV/m	Correct Factor dB	Measure ment dBuV/m	Limit dBuV/m	Margin dB	Detector	Comment
1	11158.4000	40.18	13.68	53.86	74.00	-20.14	Peak	
2 *	11158.6000	29.95	13.68	43.63	54.00	-10.37	AVG	

**REMARKS:**

- (1) Measurement Value = Reading Level + Correct Factor.
- (2) Margin Level = Measurement Value - Limit Value.

Orthogonal Axis	X
Test Mode	UNII-2C_TX A Mode 5700 MHz

**Vertical**

130 dBuV/m

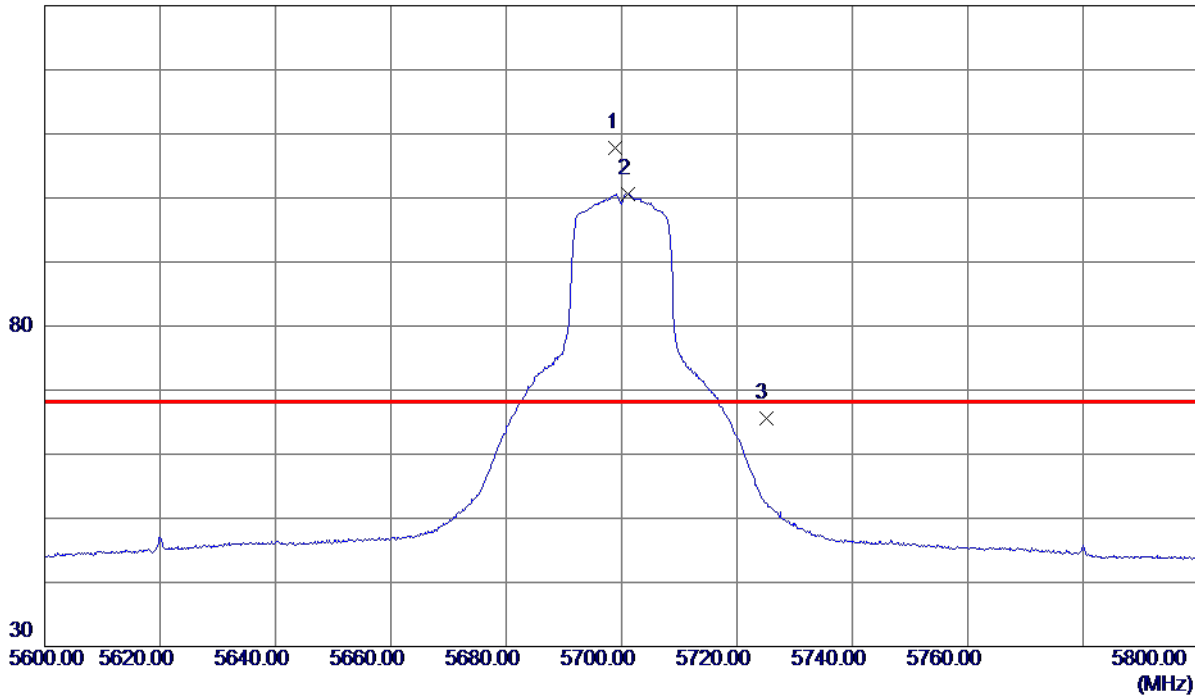

No.	Freq. MHz	Reading Level dBuV/m	Correct Factor dB	Measure ment dBuV/m	Limit dBuV/m	Margin dB	Detector	Comment
1 *	5699.0000	91.43	16.42	107.85	68.30	39.55	Peak	No Limit
2	5701.1000	84.20	16.43	100.63	999.00	-898.37	AVG	No Limit
3	5725.0000	49.02	16.52	65.54	68.30	-2.76	Peak	

**REMARKS:**

- (1) Measurement Value = Reading Level + Correct Factor.
- (2) Margin Level = Measurement Value - Limit Value.

Orthogonal Axis	X
Test Mode	UNII-2C_TX A Mode 5700 MHz

**Vertical**

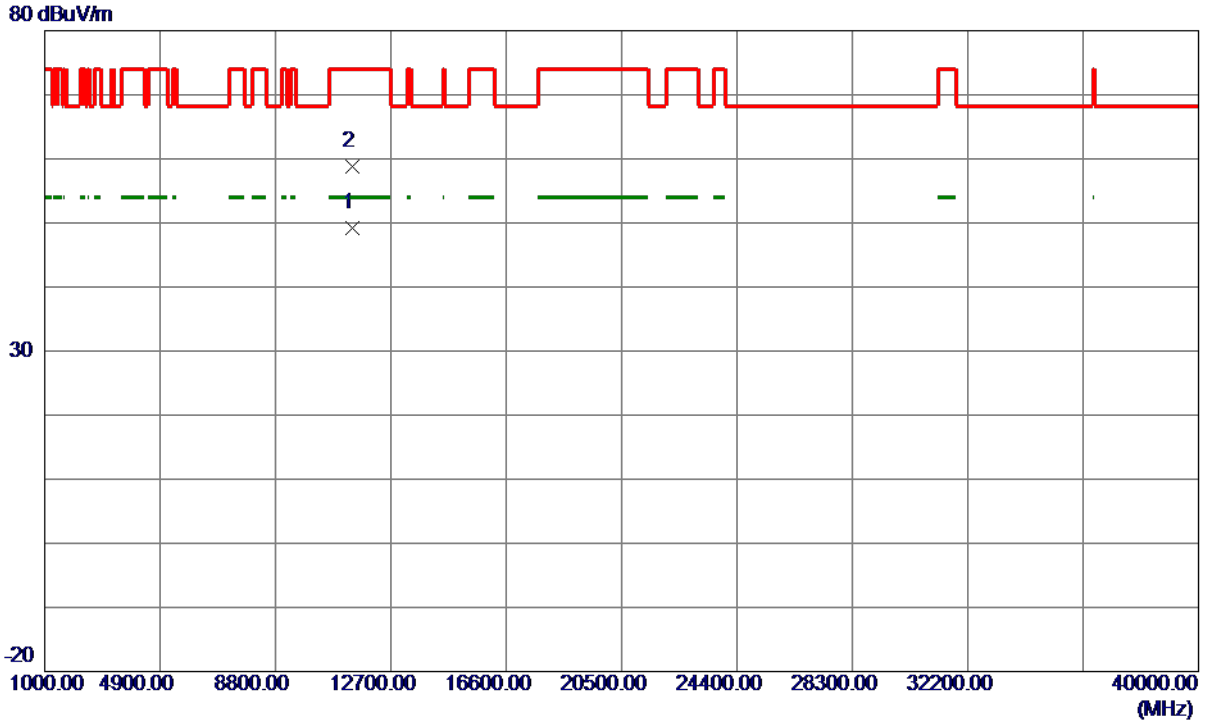

No.	Freq. MHz	Reading Level dBuV/m	Correct Factor dB	Measure ment dBuV/m	Limit dBuV/m	Margin dB	Detector	Comment
1 *	11399.5000	35.24	13.97	49.21	54.00	-4.79	AVG	
2	11400.5000	44.80	13.97	58.77	74.00	-15.23	Peak	

**REMARKS:**

- (1) Measurement Value = Reading Level + Correct Factor.
- (2) Margin Level = Measurement Value - Limit Value.

Orthogonal Axis	X
Test Mode	UNII-2C_TX A Mode 5700 MHz

**Horizontal**

130 dBuV/m

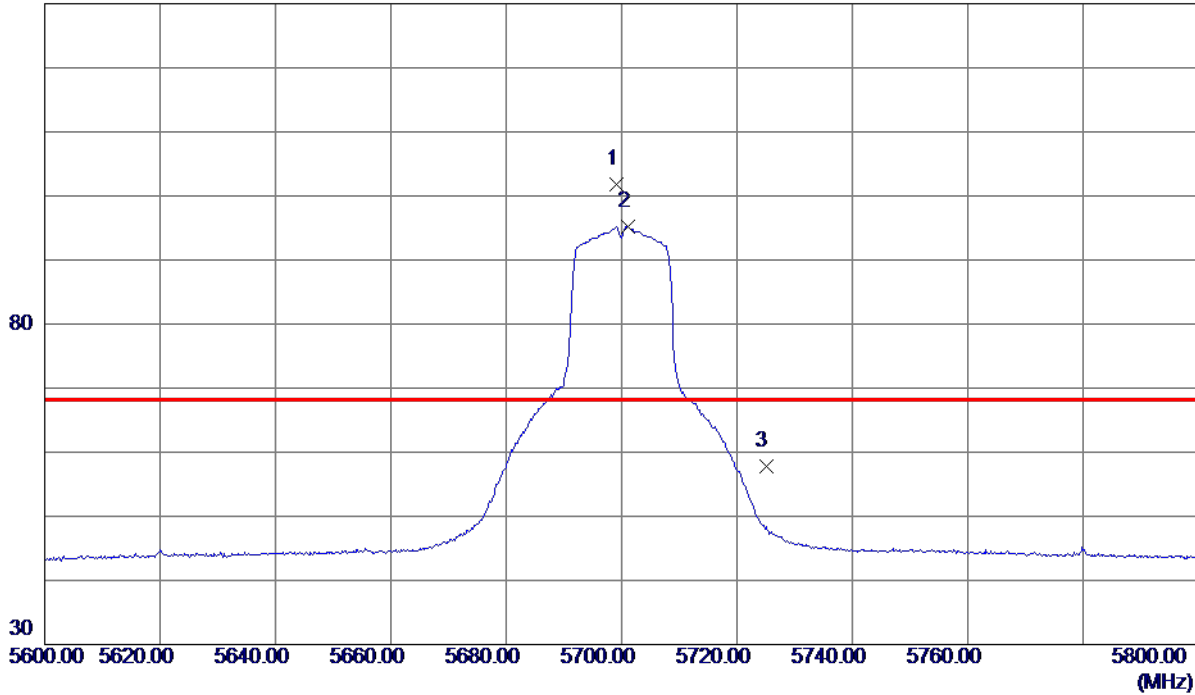

No.	Freq. MHz	Reading Level dBuV/m	Correct Factor dB	Measure ment dBuV/m	Limit dBuV/m	Margin dB	Detector	Comment
1 *	5699.1000	85.46	16.42	101.88	68.30	33.58	Peak	No Limit
2	5701.2000	78.77	16.43	95.20	999.00	-903.80	AVG	No Limit
3	5725.0000	41.20	16.52	57.72	68.30	-10.58	Peak	

**REMARKS:**

- (1) Measurement Value = Reading Level + Correct Factor.
- (2) Margin Level = Measurement Value - Limit Value.

Orthogonal Axis	X
Test Mode	UNII-2C_TX A Mode 5700 MHz

**Horizontal**

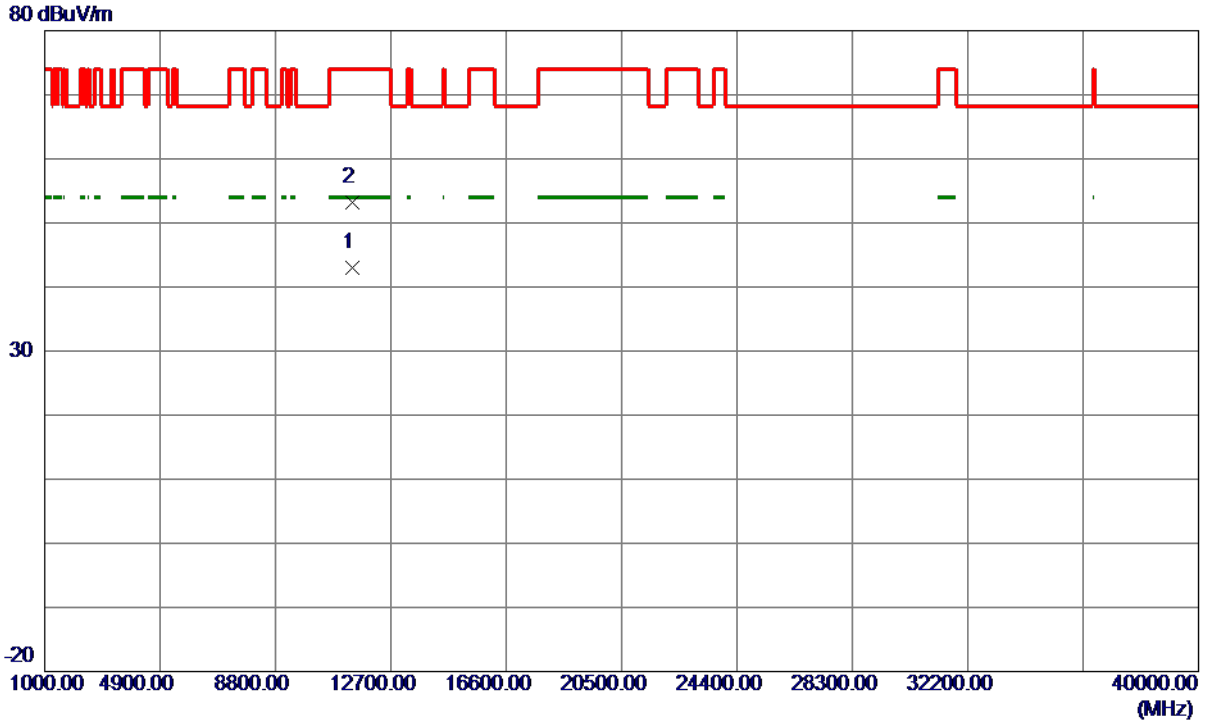

No.	Freq. MHz	Reading Level dBuV/m	Correct Factor dB	Measure ment dBuV/m	Limit dBuV/m	Margin dB	Detector	Comment
1 *	11398.2000	29.11	13.97	43.08	54.00	-10.92	AVG	
2	11402.8000	39.22	13.98	53.20	74.00	-20.80	Peak	

**REMARKS:**

- (1) Measurement Value = Reading Level + Correct Factor.
- (2) Margin Level = Measurement Value - Limit Value.



Orthogonal Axis	X
Test Mode	UNII-2C_TX N (HT20) Mode 5500 MHz

**Vertical**

130 dBuV/m

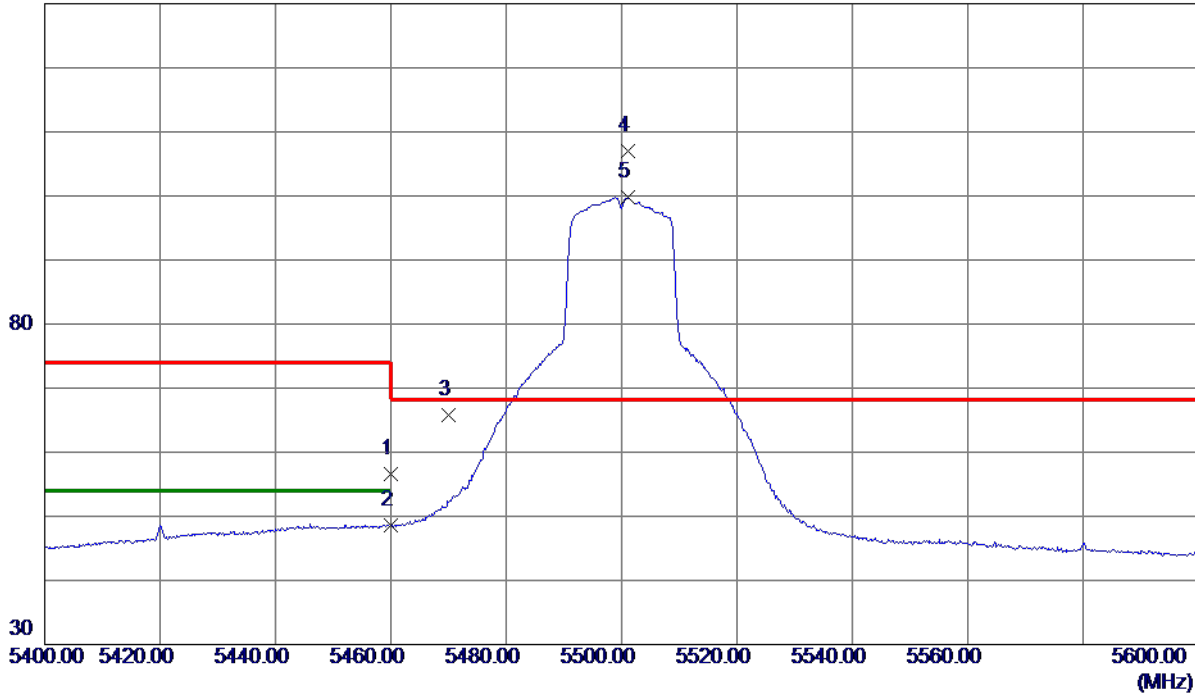

No.	Freq. MHz	Reading Level dBuV/m	Correct Factor dB	Measure ment dBuV/m	Limit dBuV/m	Margin dB	Detector	Comment
1	5460.0000	41.01	15.55	56.56	74.00	-17.44	Peak	
2	5460.0000	32.96	15.55	48.51	54.00	-5.49	AVG	
3	5470.0000	50.16	15.57	65.73	68.30	-2.57	Peak	
4 *	5501.1000	91.40	15.64	107.04	68.30	38.74	Peak	No Limit
5	5501.1000	84.09	15.64	99.73	999.00	-899.27	AVG	No Limit

**REMARKS:**

- (1) Measurement Value = Reading Level + Correct Factor.
- (2) Margin Level = Measurement Value - Limit Value.

Orthogonal Axis	X
Test Mode	UNII-2C_TX N (HT20) Mode 5500 MHz

**Vertical**

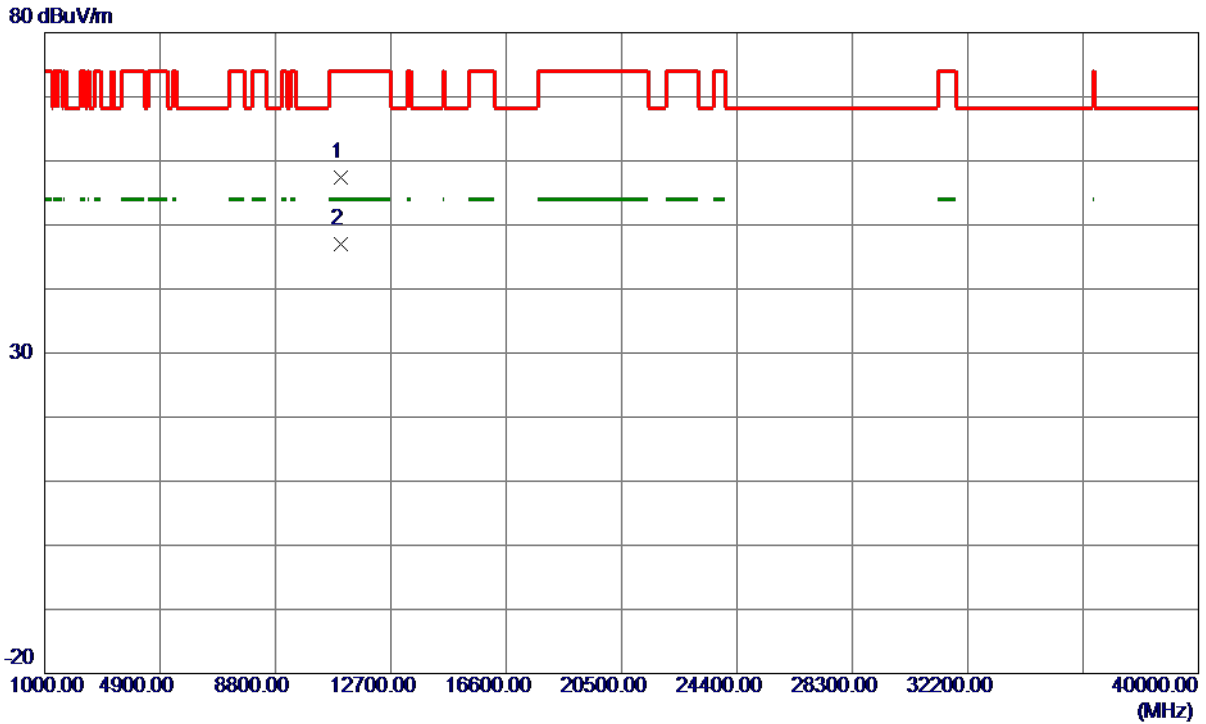

No.	Freq. MHz	Reading Level dBuV/m	Correct Factor dB	Measure ment dBuV/m	Limit dBuV/m	Margin dB	Detector	Comment
1	10999.3000	43.89	13.49	57.38	74.00	-16.62	Peak	
2 *	11000.0000	33.50	13.49	46.99	54.00	-7.01	AVG	

**REMARKS:**

- (1) Measurement Value = Reading Level + Correct Factor.
- (2) Margin Level = Measurement Value - Limit Value.

Orthogonal Axis	X
Test Mode	UNII-2C_TX N (HT20) Mode 5500 MHz

### Horizontal

130 dBuV/m

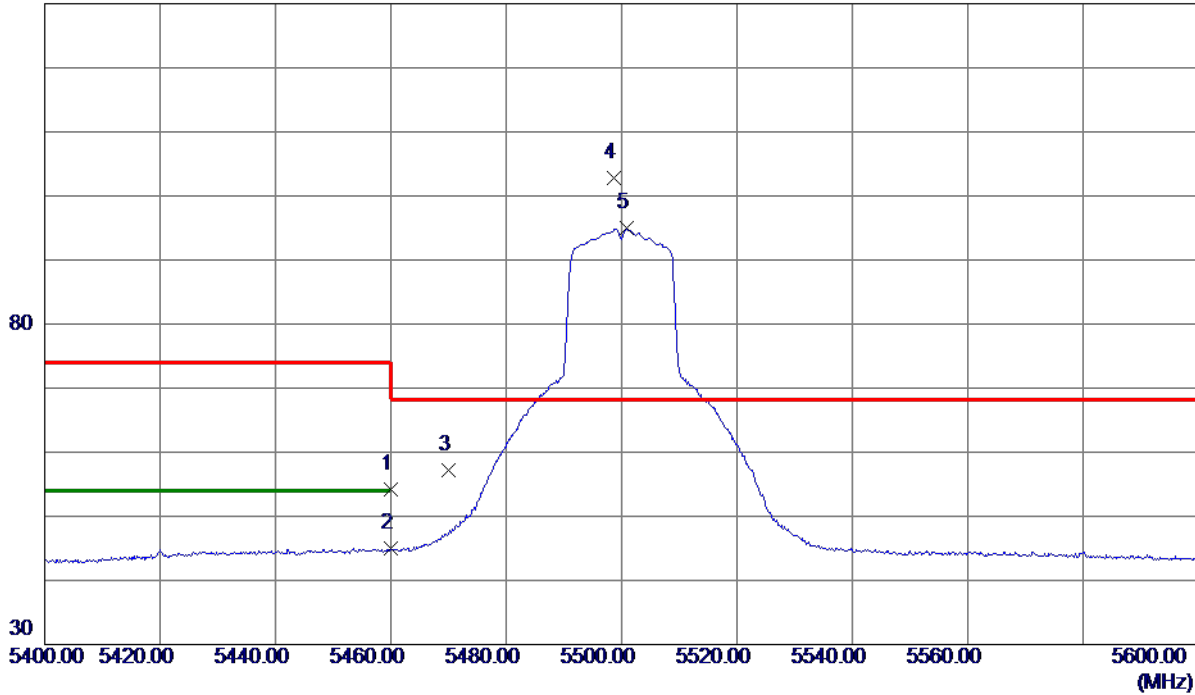

No.	Freq. MHz	Reading Level dBuV/m	Correct Factor dB	Measure ment dBuV/m	Limit dBuV/m	Margin dB	Detector	Comment
1	5460.0000	38.58	15.55	54.13	74.00	-19.87	Peak	
2	5460.0000	29.43	15.55	44.98	54.00	-9.02	AVG	
3	5470.0000	41.60	15.57	57.17	68.30	-11.13	Peak	
4 *	5498.7000	87.16	15.63	102.79	68.30	34.49	Peak	No Limit
5	5500.9000	79.28	15.64	94.92	999.00	-904.08	AVG	No Limit

**REMARKS:**

- (1) Measurement Value = Reading Level + Correct Factor.
- (2) Margin Level = Measurement Value - Limit Value.

Orthogonal Axis	X
Test Mode	UNII-2C_TX N (HT20) Mode 5500 MHz

**Horizontal**

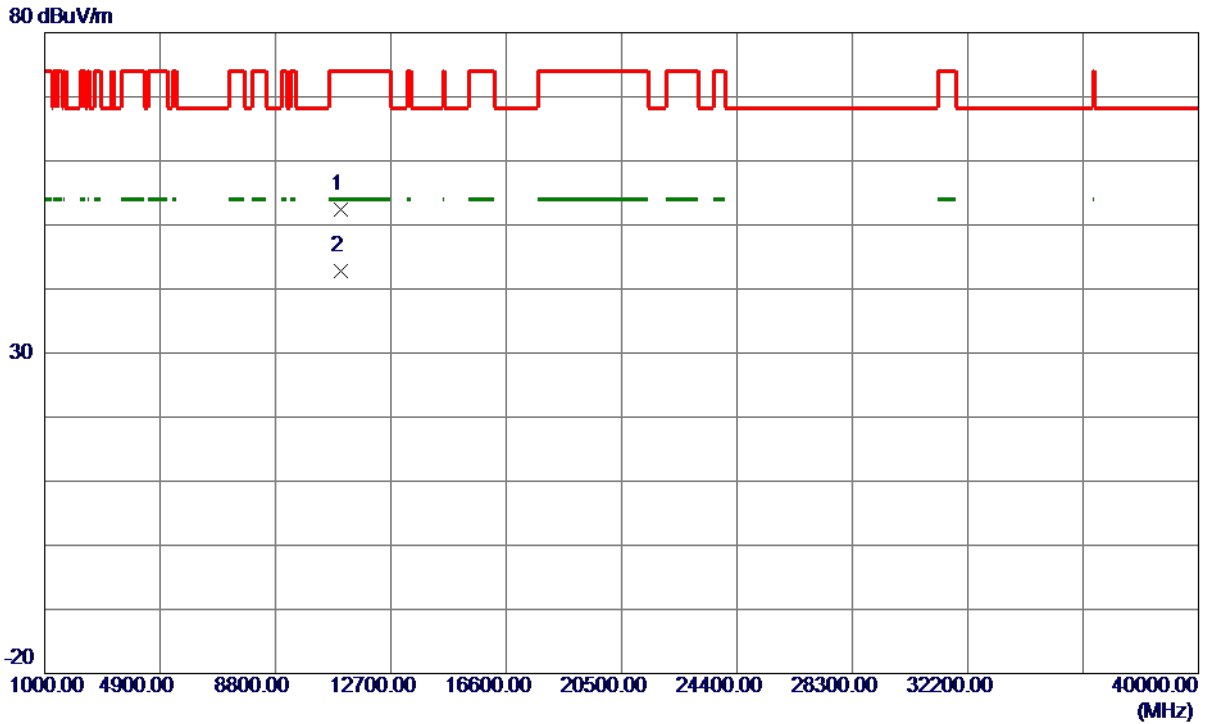

No.	Freq. MHz	Reading Level dBuV/m	Correct Factor dB	Measure ment dBuV/m	Limit dBuV/m	Margin dB	Detector	Comment
1	11002.3000	38.98	13.49	52.47	74.00	-21.53	Peak	
2 *	11002.4000	29.23	13.49	42.72	54.00	-11.28	AVG	

**REMARKS:**

- (1) Measurement Value = Reading Level + Correct Factor.
- (2) Margin Level = Measurement Value - Limit Value.

Orthogonal Axis	X
Test Mode	UNII-2C_TX N (HT20) Mode 5580 MHz

Vertical

130 dBuV/m

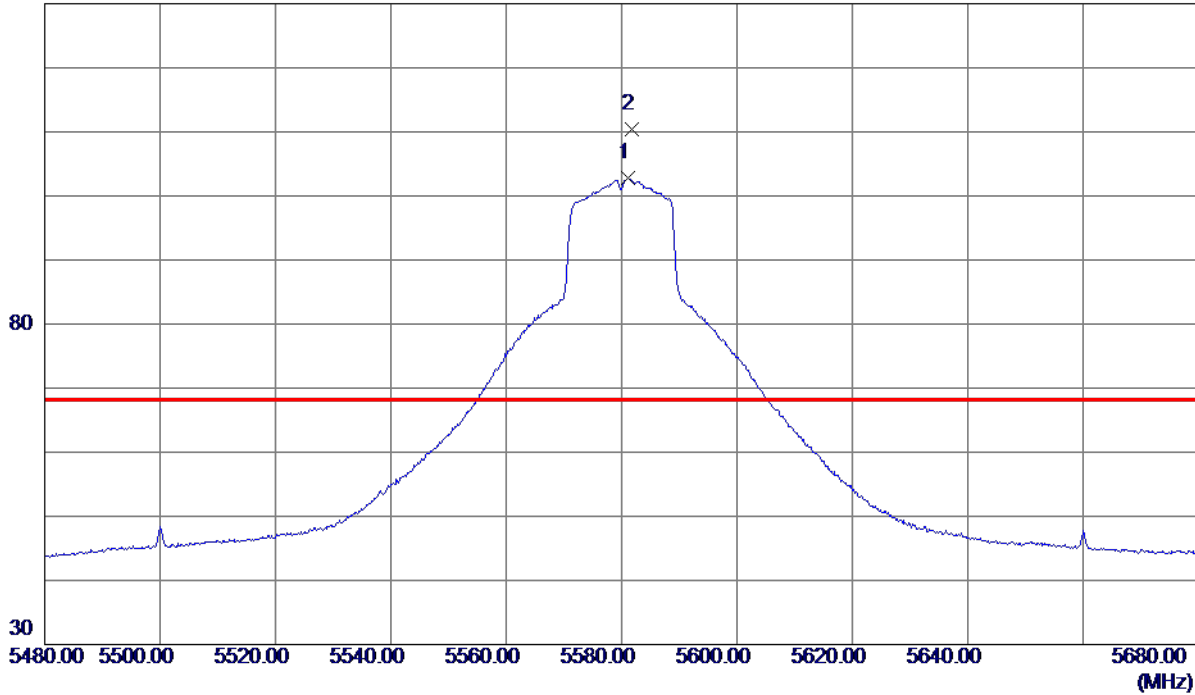

No.	Freq. MHz	Reading Level dBuV/m	Correct Factor dB	Measure ment dBuV/m	Limit dBuV/m	Margin dB	Detector	Comment
1	5581.2000	86.85	15.96	102.81	999.00	-896.19	AVG	No Limit
2 *	5581.8000	94.52	15.96	110.48	68.30	42.18	Peak	No Limit

REMARKS:

- (1) Measurement Value = Reading Level + Correct Factor.
- (2) Margin Level = Measurement Value - Limit Value.

Orthogonal Axis	X
Test Mode	UNII-2C_TX N (HT20) Mode 5580 MHz

**Vertical**

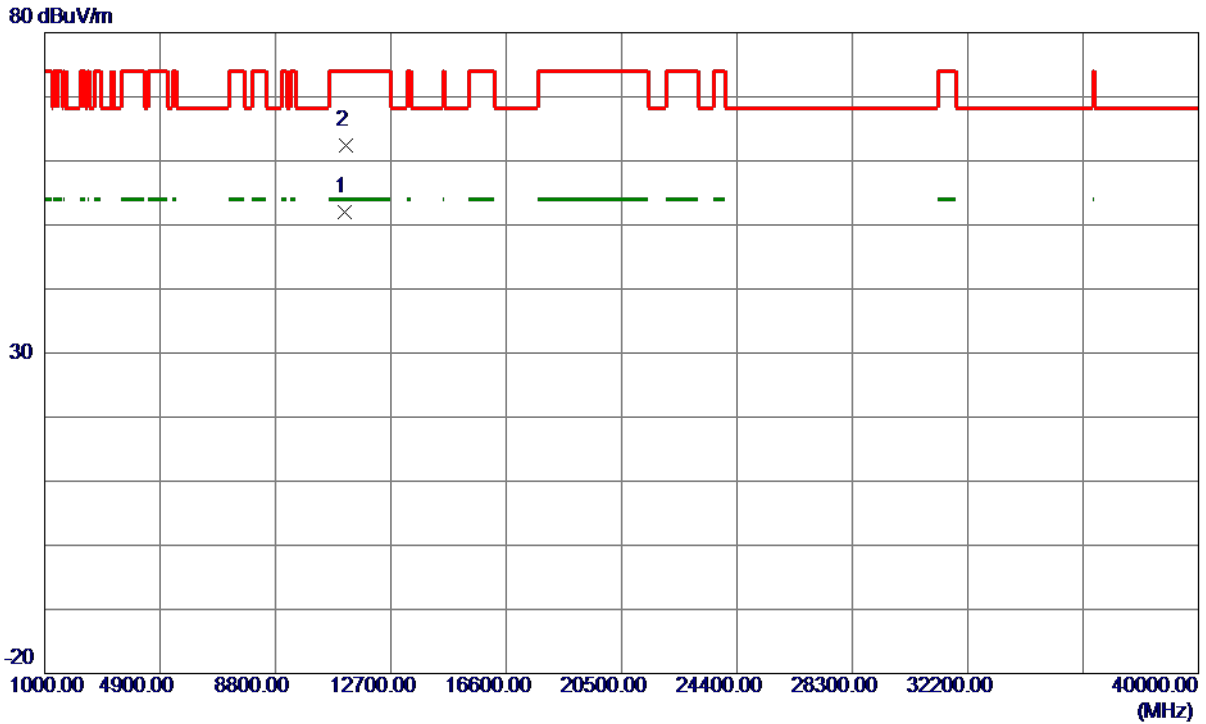

No.	Freq. MHz	Reading Level dBuV/m	Correct Factor dB	Measure ment dBuV/m	Limit dBuV/m	Margin dB	Detector	Comment
1 *	11158.1000	38.28	13.68	51.96	54.00	-2.04	AVG	
2	11166.7000	48.72	13.69	62.41	74.00	-11.59	Peak	

**REMARKS:**

- (1) Measurement Value = Reading Level + Correct Factor.
- (2) Margin Level = Measurement Value - Limit Value.

Orthogonal Axis	X
Test Mode	UNII-2C_TX N (HT20) Mode 5580 MHz

Horizontal

130 dBuV/m

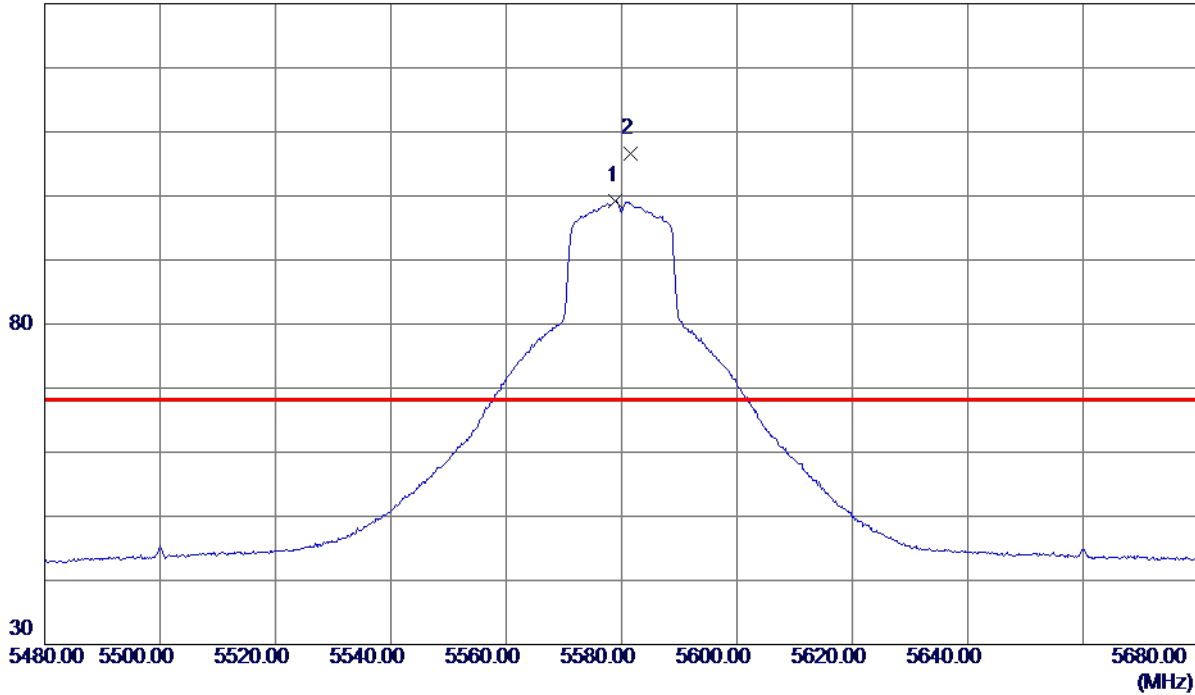

No.	Freq. MHz	Reading Level dBuV/m	Correct Factor dB	Measure ment dBuV/m	Limit dBuV/m	Margin dB	Detector	Comment
1	5579.0000	83.19	15.95	99.14	999.00	-899.86	AVG	No Limit
2 *	5581.5000	90.67	15.96	106.63	68.30	38.33	Peak	No Limit

REMARKS:

- (1) Measurement Value = Reading Level + Correct Factor.
- (2) Margin Level = Measurement Value - Limit Value.

Orthogonal Axis	X
Test Mode	UNII-2C_TX N (HT20) Mode 5580 MHz

Horizontal

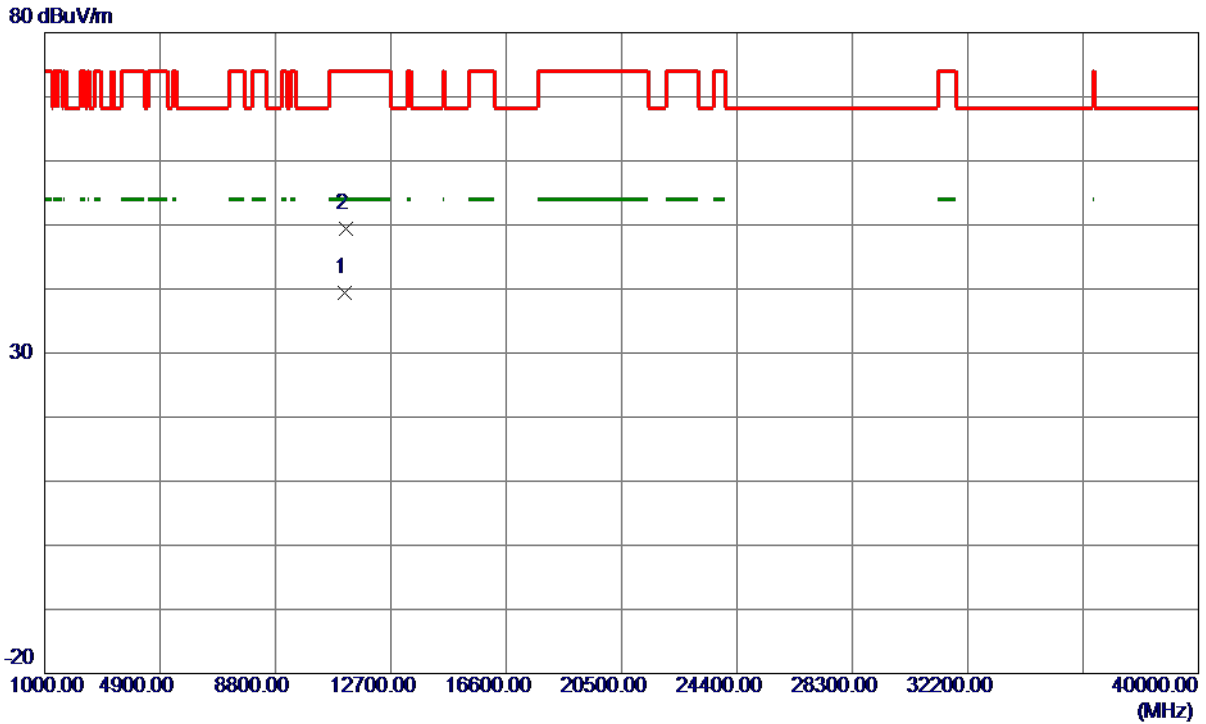

No.	Freq. MHz	Reading Level dBuV/m	Correct Factor dB	Measure ment dBuV/m	Limit dBuV/m	Margin dB	Detector	Comment
1 *	11159.4000	25.68	13.68	39.36	54.00	-14.64	AVG	
2	11165.7000	35.76	13.69	49.45	74.00	-24.55	Peak	

REMARKS:

- (1) Measurement Value = Reading Level + Correct Factor.
- (2) Margin Level = Measurement Value - Limit Value.



Orthogonal Axis	X
Test Mode	UNII-2C_TX N (HT20) Mode 5700 MHz

**Vertical**

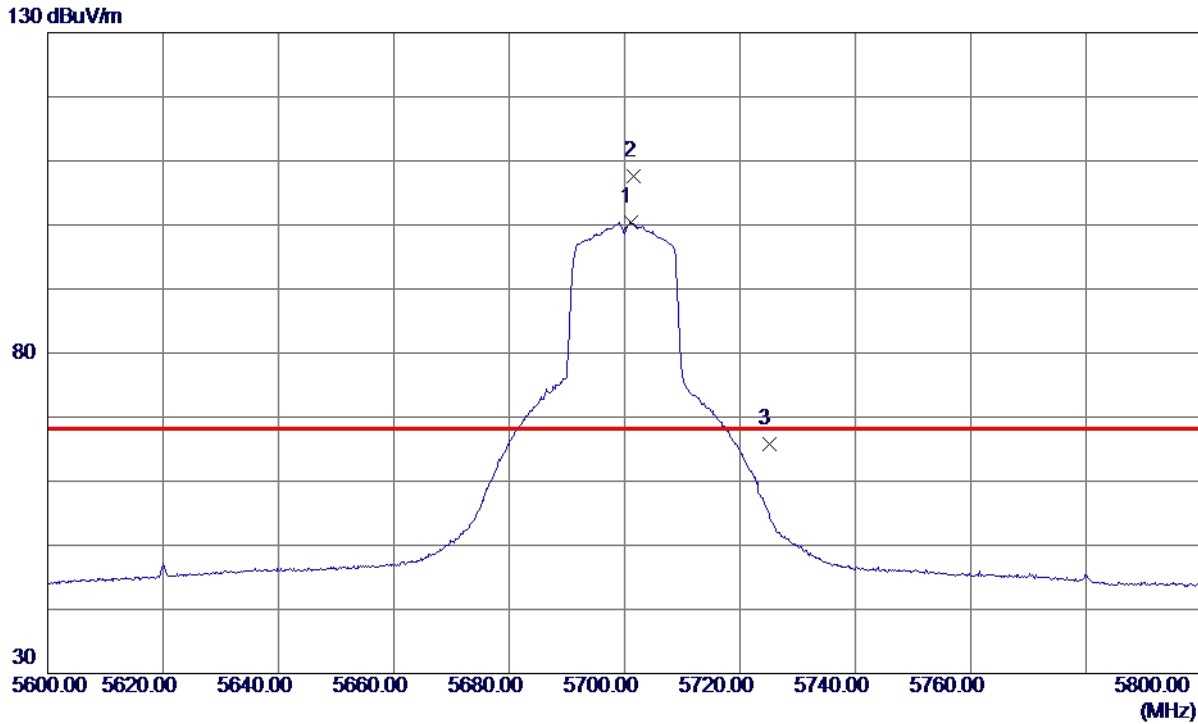

No.	Freq. MHz	Reading Level dBuV/m	Correct Factor dB	Measure ment dBuV/m	Limit dBuV/m	Margin dB	Detector	Comment
1	5701.0000	83.93	16.43	100.36	999.00	-898.64	AVG	No Limit
2 *	5701.5000	91.24	16.43	107.67	68.30	39.37	Peak	No Limit
3	5725.0000	49.34	16.52	65.86	68.30	-2.44	Peak	

**REMARKS:**

- (1) Measurement Value = Reading Level + Correct Factor.
- (2) Margin Level = Measurement Value - Limit Value.

Orthogonal Axis	X
Test Mode	UNII-2C_TX N (HT20) Mode 5700 MHz

**Vertical**

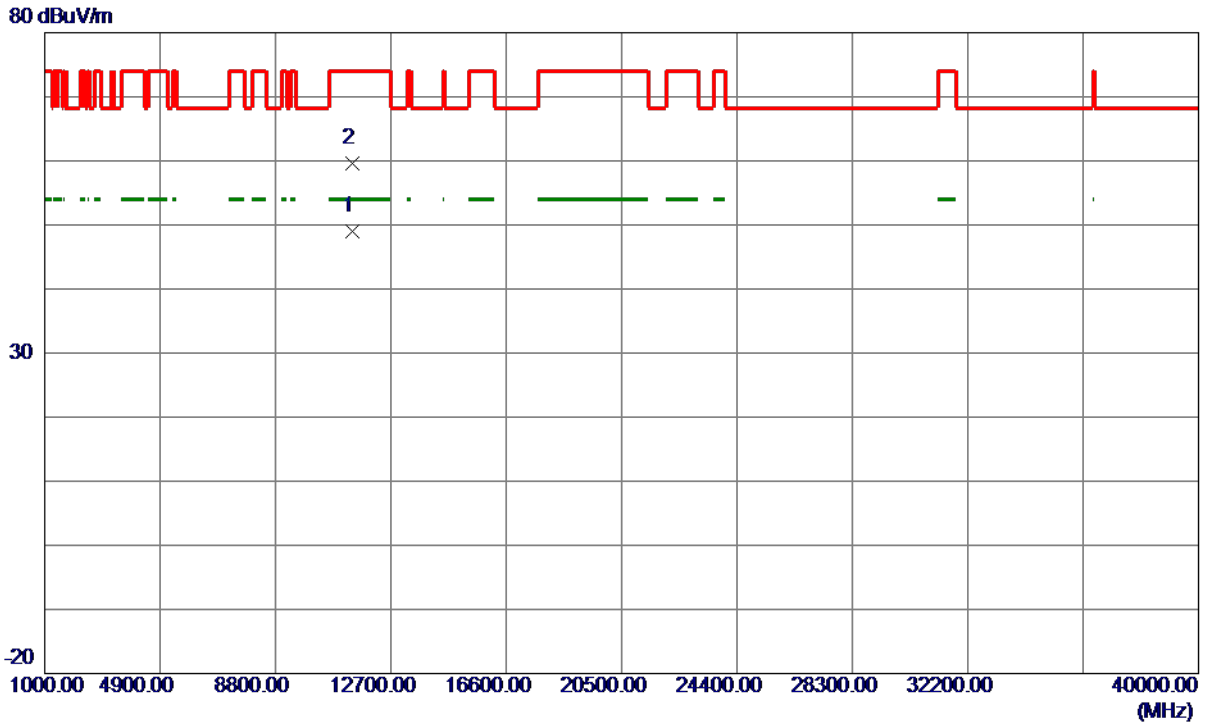

No.	Freq. MHz	Reading Level dBuV/m	Correct Factor dB	Measure ment dBuV/m	Limit dBuV/m	Margin dB	Detector	Comment
1 *	11399.1000	35.12	13.97	49.09	54.00	-4.91	AVG	
2	11404.3000	45.58	13.98	59.56	74.00	-14.44	Peak	

**REMARKS:**

- (1) Measurement Value = Reading Level + Correct Factor.
- (2) Margin Level = Measurement Value - Limit Value.

Orthogonal Axis	X
Test Mode	UNII-2C_TX N (HT20) Mode 5700 MHz

### Horizontal

130 dBuV/m

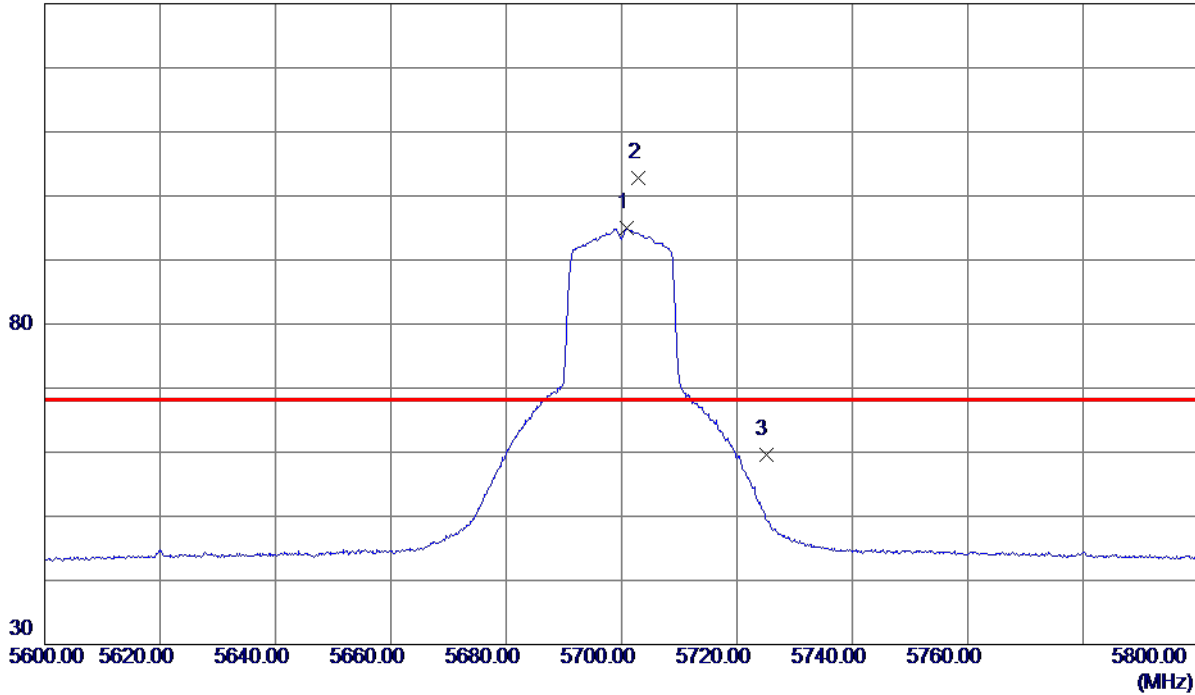

No.	Freq. MHz	Reading Level dBuV/m	Correct Factor dB	Measure ment dBuV/m	Limit dBuV/m	Margin dB	Detector	Comment
1	5700.8000	78.55	16.43	94.98	999.00	-904.02	AVG	No Limit
2 *	5702.9000	86.43	16.44	102.87	68.30	34.57	Peak	No Limit
3	5725.0000	43.06	16.52	59.58	68.30	-8.72	Peak	

**REMARKS:**

- (1) Measurement Value = Reading Level + Correct Factor.
- (2) Margin Level = Measurement Value - Limit Value.

Orthogonal Axis	X
Test Mode	UNII-2C_TX N (HT20) Mode 5700 MHz

**Horizontal**

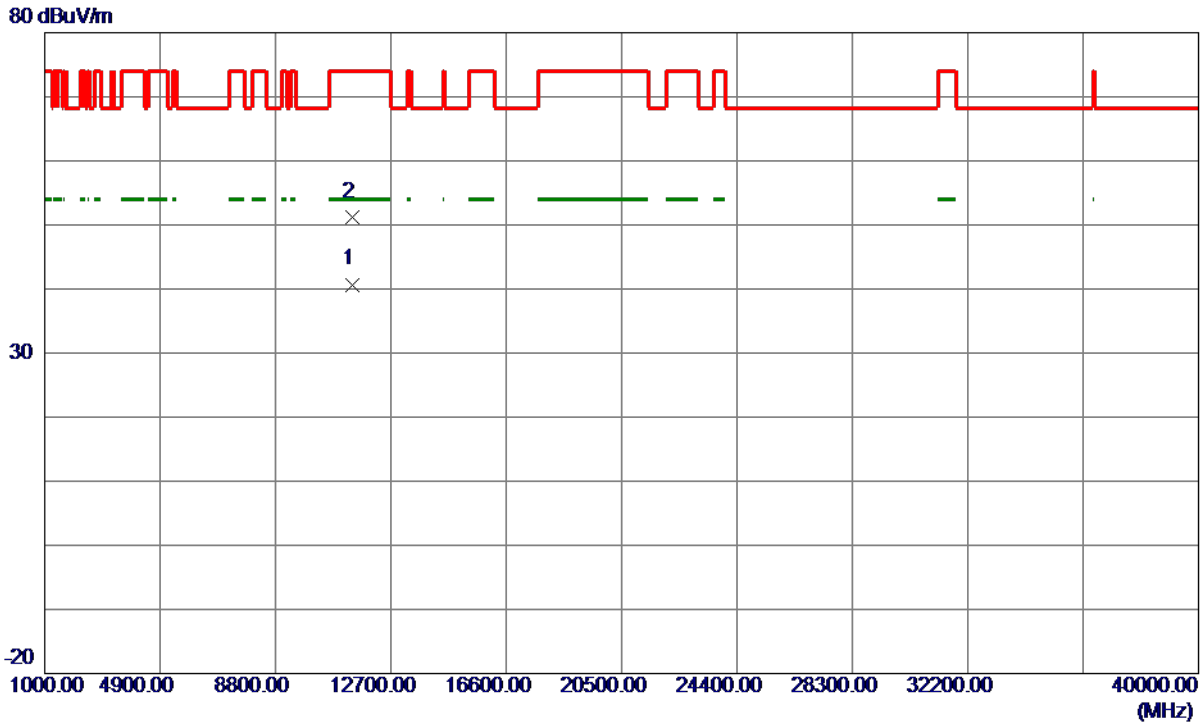

No.	Freq. MHz	Reading Level dBuV/m	Correct Factor dB	Measure ment dBuV/m	Limit dBuV/m	Margin dB	Detector	Comment
1 *	11401.1000	26.72	13.98	40.70	54.00	-13.30	AVG	
2	11401.8000	37.22	13.98	51.20	74.00	-22.80	Peak	

**REMARKS:**

- (1) Measurement Value = Reading Level + Correct Factor.
- (2) Margin Level = Measurement Value - Limit Value.

Orthogonal Axis	X
Test Mode	UNII-2C_TX N (HT40) Mode 5510 MHz

### Vertical

130 dBuV/m

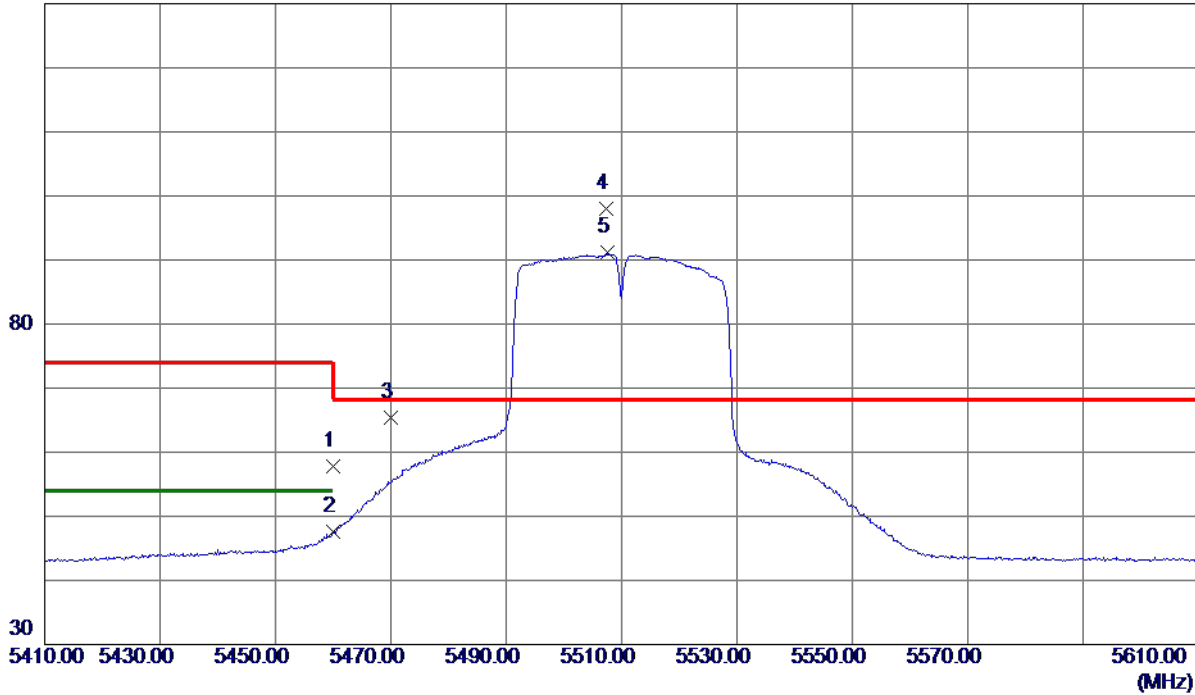

No.	Freq. MHz	Reading Level dBuV/m	Correct Factor dB	Measure ment dBuV/m	Limit dBuV/m	Margin dB	Detector	Comment
1	5460.0000	42.31	15.55	57.86	74.00	-16.14	Peak	
2	5460.0000	32.00	15.55	47.55	54.00	-6.45	AVG	
3	5470.0000	49.83	15.57	65.40	68.30	-2.90	Peak	
4 *	5507.3000	82.27	15.66	97.93	68.30	29.63	Peak	No Limit
5	5507.5000	75.52	15.66	91.18	999.00	-907.82	AVG	No Limit

**REMARKS:**

- (1) Measurement Value = Reading Level + Correct Factor.
- (2) Margin Level = Measurement Value - Limit Value.

Orthogonal Axis	X
Test Mode	UNII-2C_TX N (HT40) Mode 5510 MHz

**Vertical**

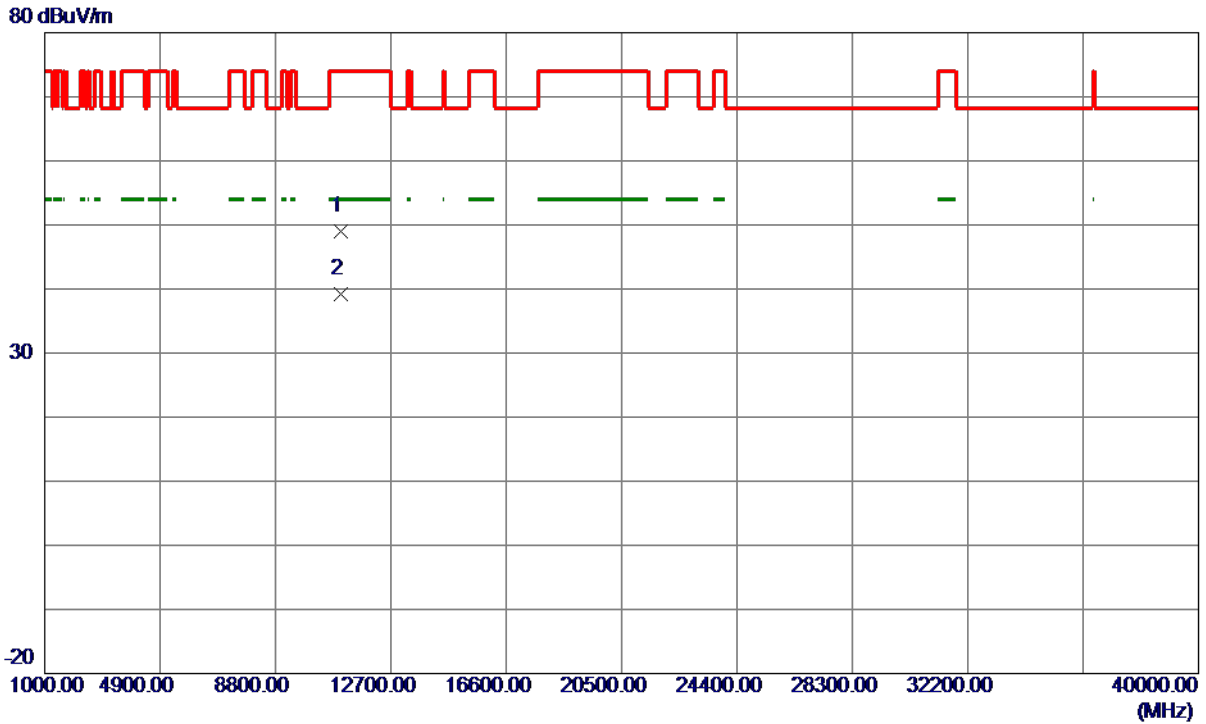

No.	Freq. MHz	Reading Level dBuV/m	Correct Factor dB	Measure ment dBuV/m	Limit dBuV/m	Margin dB	Detector	Comment
1	11016.8000	35.45	13.51	48.96	74.00	-25.04	Peak	
2 *	11020.8000	25.70	13.52	39.22	54.00	-14.78	AVG	

**REMARKS:**

- (1) Measurement Value = Reading Level + Correct Factor.
- (2) Margin Level = Measurement Value - Limit Value.

Orthogonal Axis	X
Test Mode	UNII-2C_TX N (HT40) Mode 5510 MHz

### Horizontal

130 dBuV/m

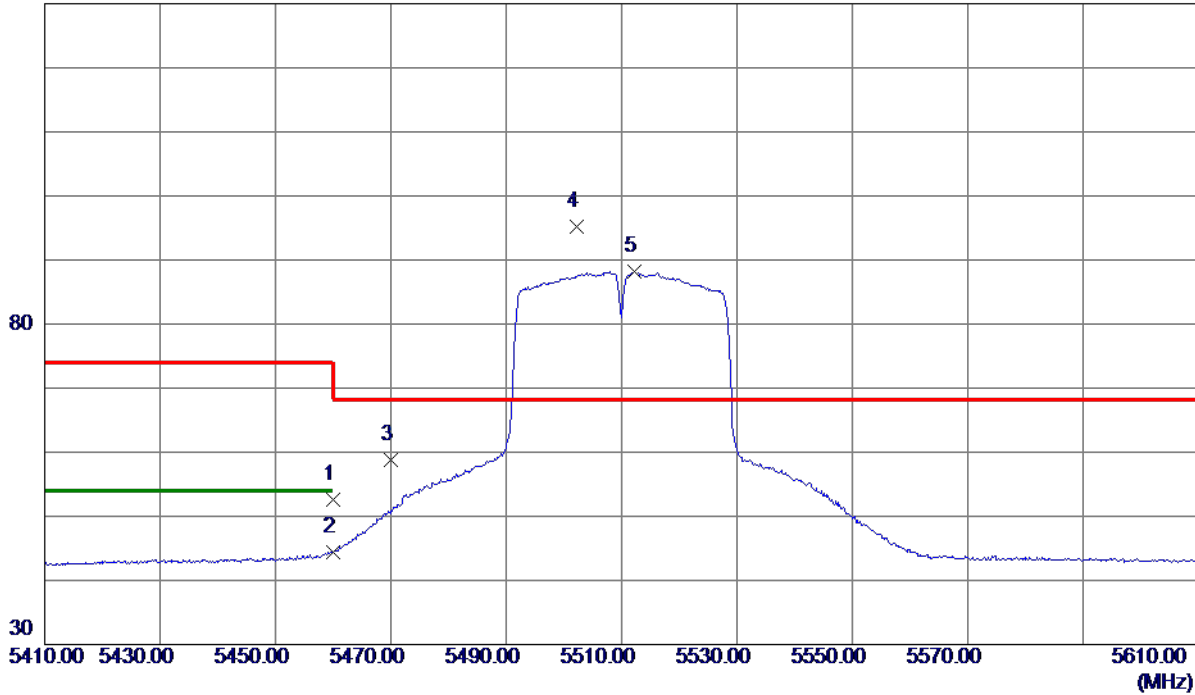

No.	Freq. MHz	Reading Level dBuV/m	Correct Factor dB	Measure ment dBuV/m	Limit dBuV/m	Margin dB	Detector	Comment
1	5460.0000	37.13	15.55	52.68	74.00	-21.32	Peak	
2	5460.0000	28.85	15.55	44.40	54.00	-9.60	AVG	
3	5470.0000	43.16	15.57	58.73	68.30	-9.57	Peak	
4 *	5502.2000	79.54	15.64	95.18	68.30	26.88	Peak	No Limit
5	5512.3000	72.43	15.68	88.11	999.00	-910.89	AVG	No Limit

**REMARKS:**

- (1) Measurement Value = Reading Level + Correct Factor.
- (2) Margin Level = Measurement Value - Limit Value.

Orthogonal Axis	X
Test Mode	UNII-2C_TX N (HT40) Mode 5510 MHz

### Horizontal

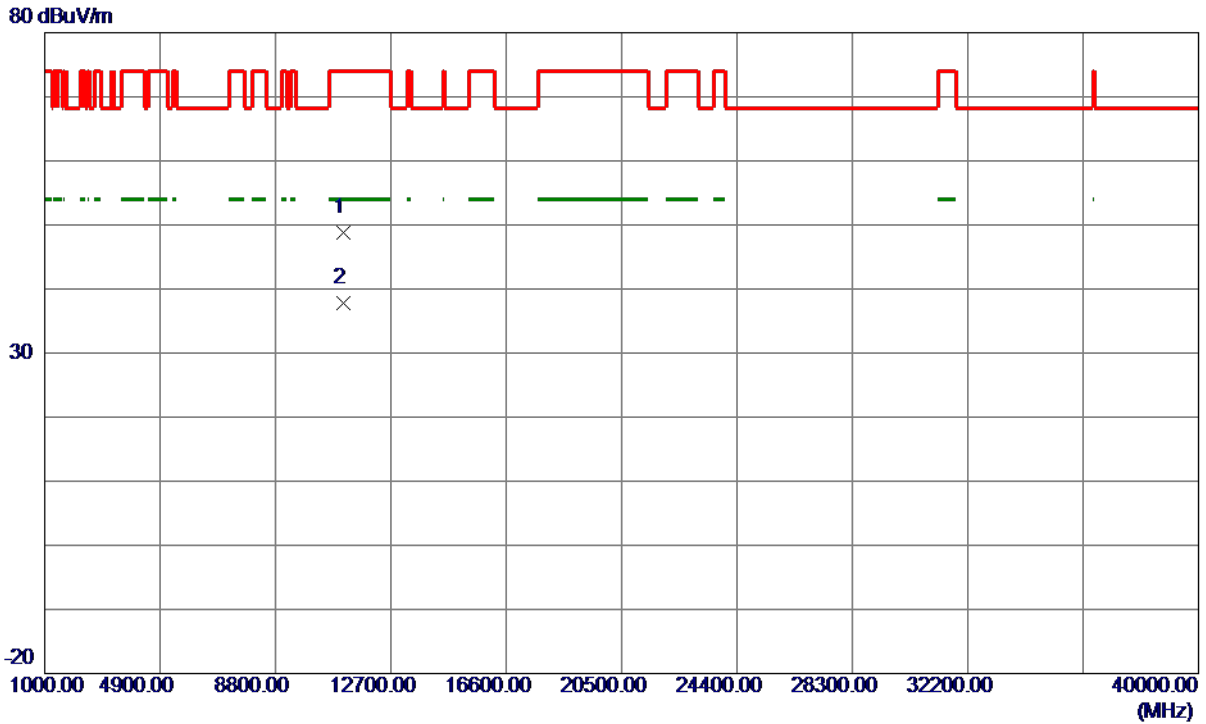

No.	Freq. MHz	Reading Level dBuV/m	Correct Factor dB	Measure ment dBuV/m	Limit dBuV/m	Margin dB	Detector	Comment
1	11081.0000	35.16	13.59	48.75	74.00	-25.25	Peak	
2 *	11085.2000	24.21	13.59	37.80	54.00	-16.20	AVG	

**REMARKS:**

- (1) Measurement Value = Reading Level + Correct Factor.
- (2) Margin Level = Measurement Value - Limit Value.



Orthogonal Axis	X
Test Mode	UNII-2C_TX N (HT40) Mode 5550 MHz

**Vertical**

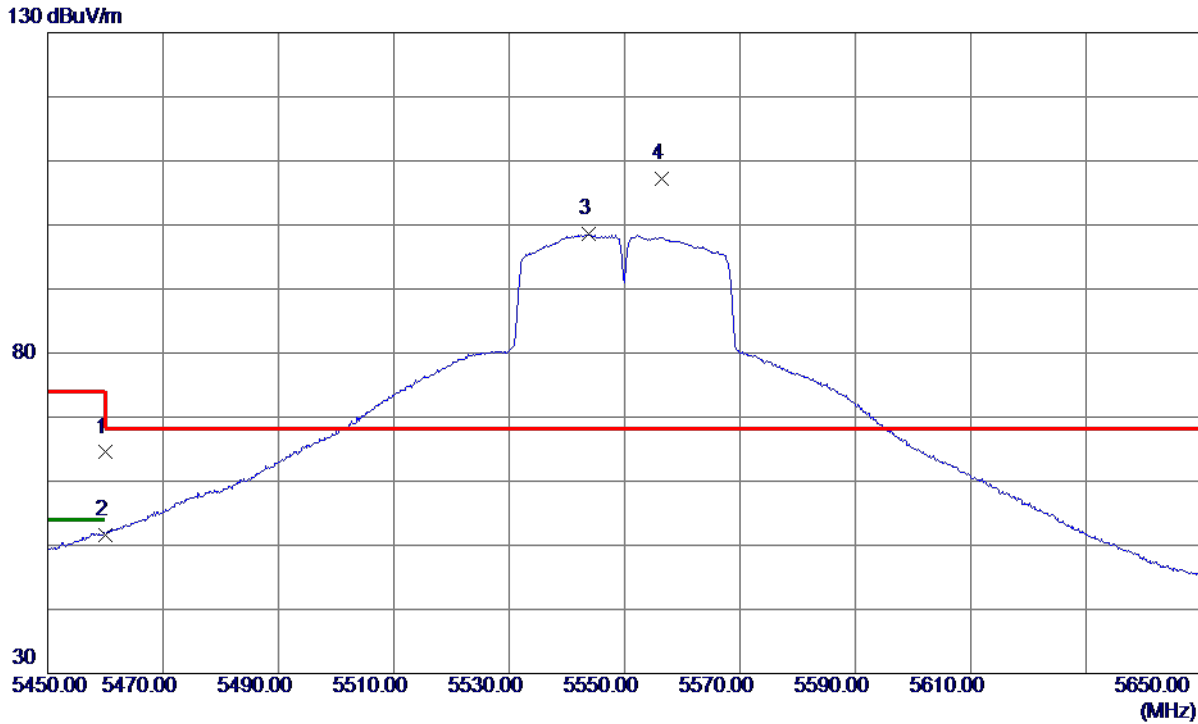

No.	Freq. MHz	Reading Level dBuV/m	Correct Factor dB	Measure ment dBuV/m	Limit dBuV/m	Margin dB	Detector	Comment
1	5460.0000	48.95	15.55	64.50	74.00	-9.50	Peak	
2	5460.0000	36.11	15.55	51.66	54.00	-2.34	AVG	
3	5543.7000	82.80	15.81	98.61	999.00	-900.39	AVG	No Limit
4 *	5556.4000	91.37	15.86	107.23	68.30	38.93	Peak	No Limit

**REMARKS:**

- (1) Measurement Value = Reading Level + Correct Factor.
- (2) Margin Level = Measurement Value - Limit Value.

Orthogonal Axis	X
Test Mode	UNII-2C_TX N (HT40) Mode 5550 MHz

**Vertical**

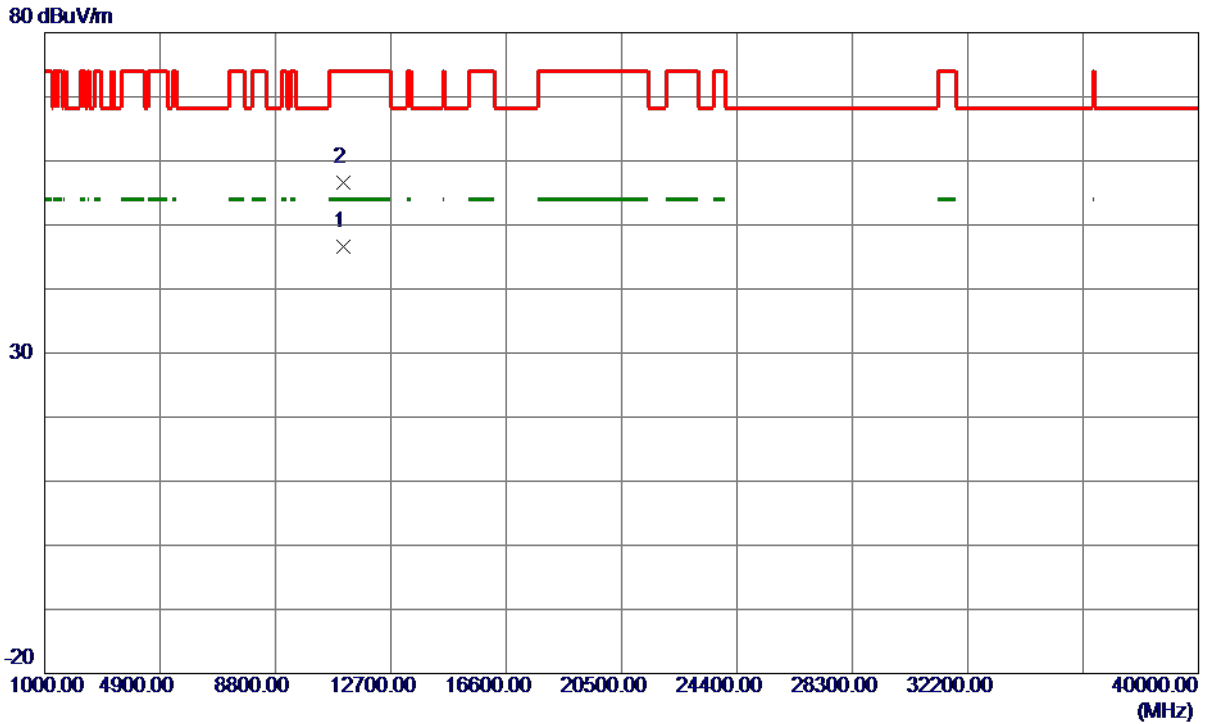

No.	Freq. MHz	Reading Level dBuV/m	Correct Factor dB	Measure ment dBuV/m	Limit dBuV/m	Margin dB	Detector	Comment
1 *	11099.2000	33.08	13.61	46.69	54.00	-7.31	AVG	
2	11107.2000	42.97	13.62	56.59	74.00	-17.41	Peak	

**REMARKS:**

- (1) Measurement Value = Reading Level + Correct Factor.
- (2) Margin Level = Measurement Value - Limit Value.

Orthogonal Axis	X
Test Mode	UNII-2C_TX N (HT40) Mode 5550 MHz

**Horizontal**

130 dBuV/m

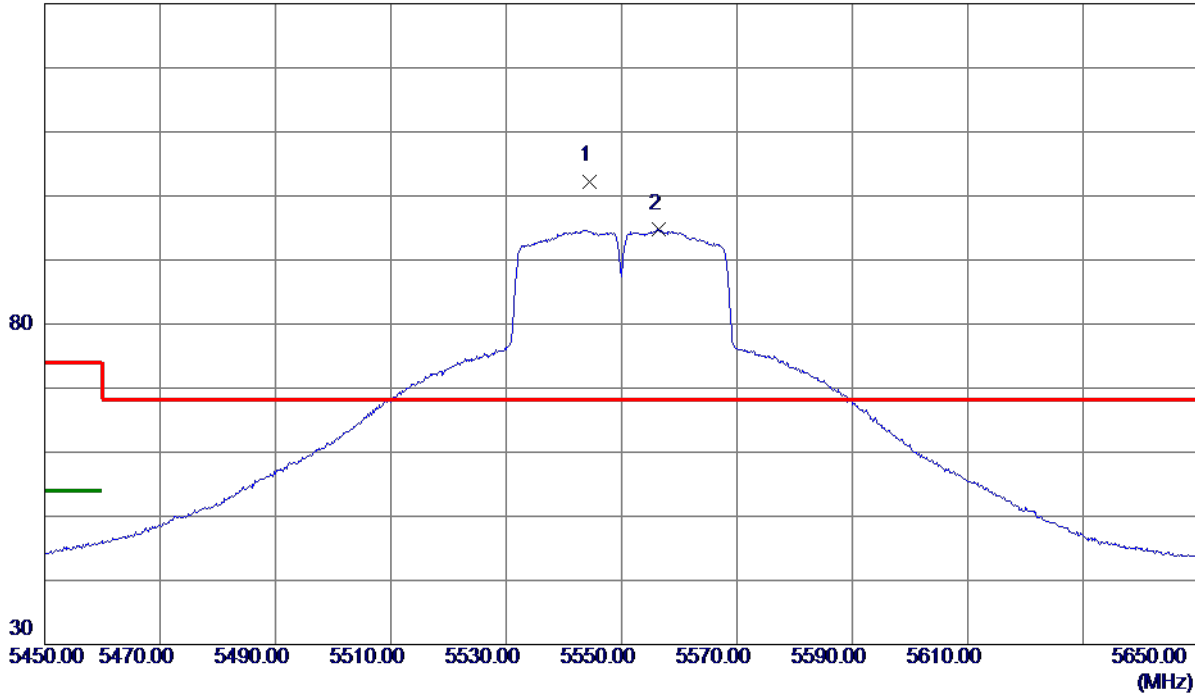

No.	Freq. MHz	Reading Level dBuV/m	Correct Factor dB	Measure ment dBuV/m	Limit dBuV/m	Margin dB	Detector	Comment
1 *	5544.5000	86.49	15.81	102.30	68.30	34.00	Peak	No Limit
2	5556.4000	78.94	15.86	94.80	999.00	-904.20	AVG	No Limit

**REMARKS:**

- (1) Measurement Value = Reading Level + Correct Factor.
- (2) Margin Level = Measurement Value - Limit Value.

Orthogonal Axis	X
Test Mode	UNII-2C_TX N (HT40) Mode 5550 MHz

**Horizontal**

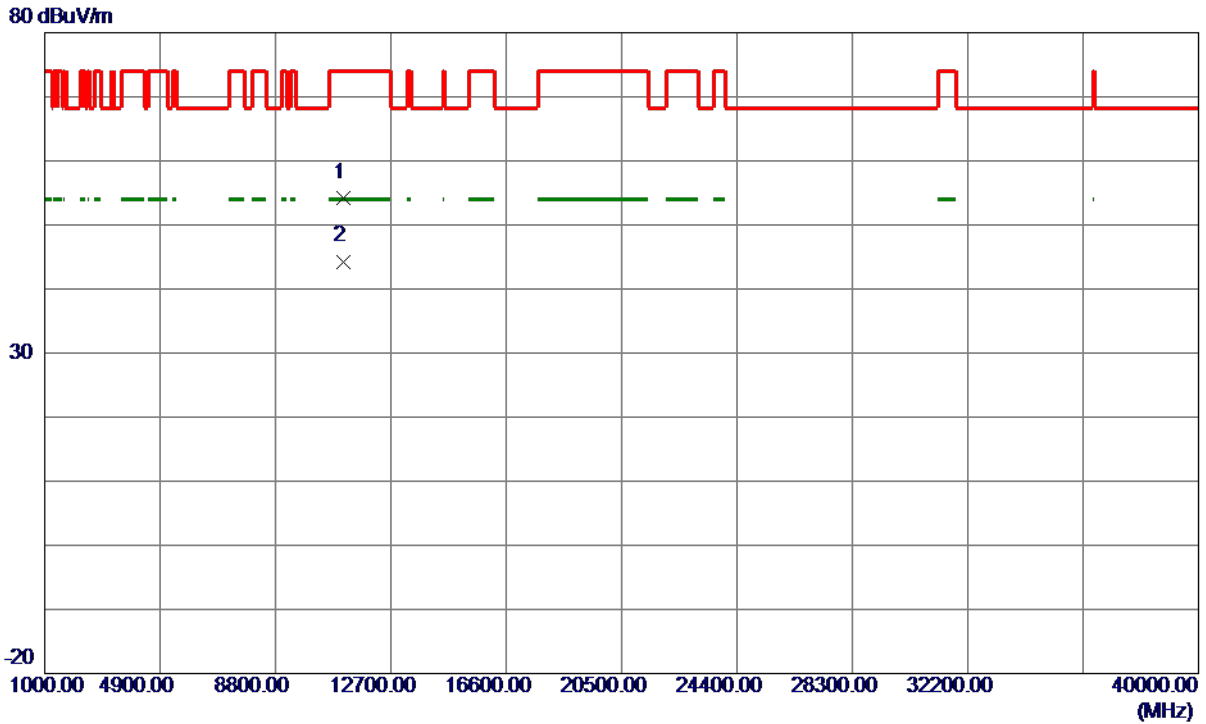

No.	Freq. MHz	Reading Level dBuV/m	Correct Factor dB	Measure ment dBuV/m	Limit dBuV/m	Margin dB	Detector	Comment
1	11096.2000	40.66	13.61	54.27	74.00	-19.73	Peak	
2 *	11099.6000	30.69	13.61	44.30	54.00	-9.70	AVG	

**REMARKS:**

- (1) Measurement Value = Reading Level + Correct Factor.
- (2) Margin Level = Measurement Value - Limit Value.

Orthogonal Axis	X
Test Mode	UNII-2C_TX N (HT40) Mode 5670 MHz

**Vertical**

130 dBuV/m

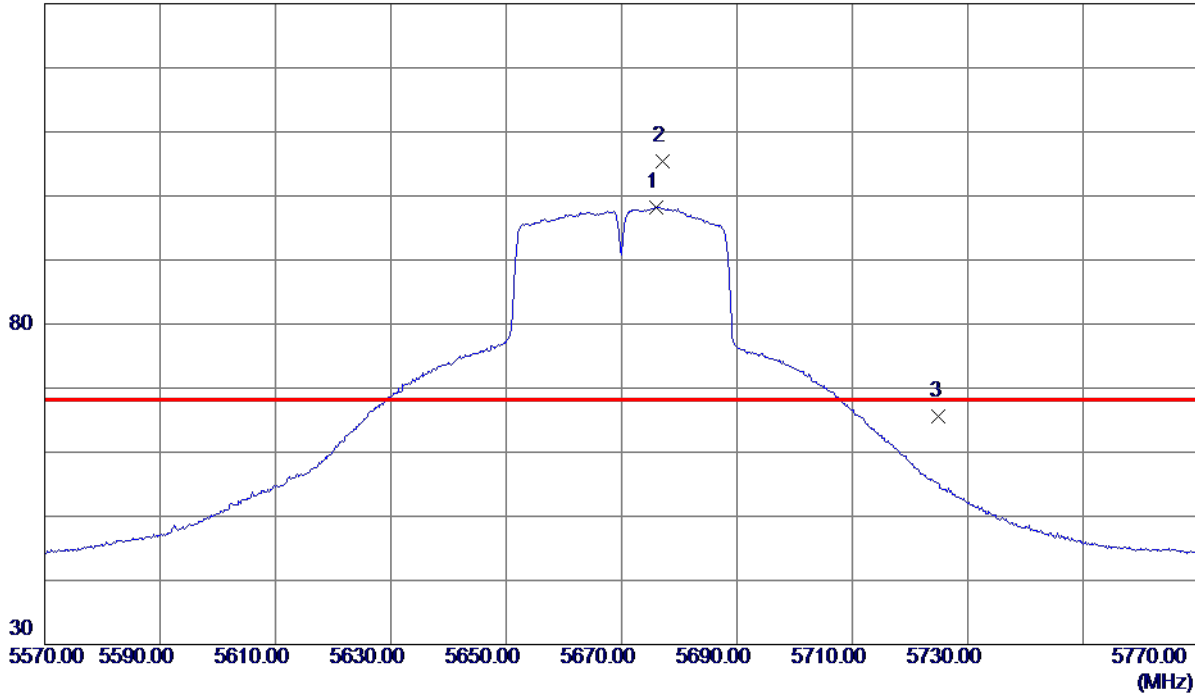

No.	Freq. MHz	Reading Level dBuV/m	Correct Factor dB	Measure ment dBuV/m	Limit dBuV/m	Margin dB	Detector	Comment
1	5676.0000	81.94	16.33	98.27	999.00	-900.73	AVG	No Limit
2 *	5677.1000	89.04	16.33	105.37	68.30	37.07	Peak	No Limit
3	5725.0000	49.16	16.52	65.68	68.30	-2.62	Peak	

**REMARKS:**

- (1) Measurement Value = Reading Level + Correct Factor.
- (2) Margin Level = Measurement Value - Limit Value.

Orthogonal Axis	X
Test Mode	UNII-2C_TX N (HT40) Mode 5670 MHz

**Vertical**

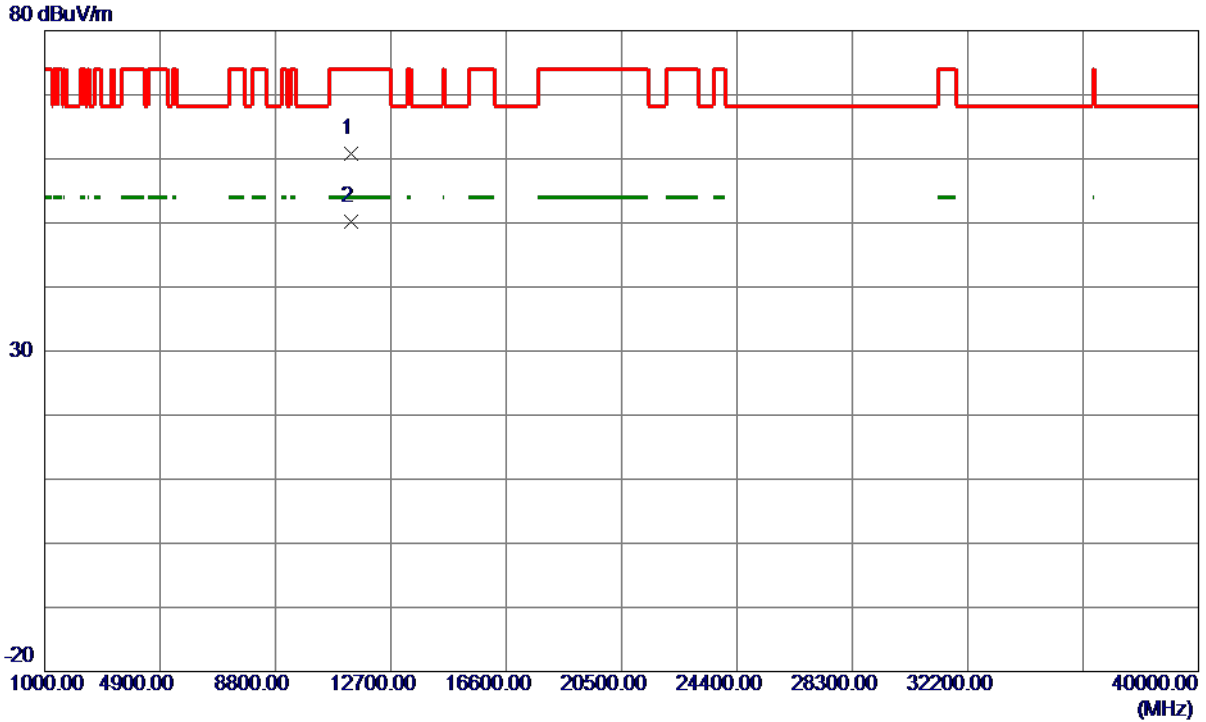

No.	Freq. MHz	Reading Level dBuV/m	Correct Factor dB	Measure ment dBuV/m	Limit dBuV/m	Margin dB	Detector	Comment
1	11336.8000	46.97	13.90	60.87	74.00	-13.13	Peak	
2 *	11339.6000	36.21	13.90	50.11	54.00	-3.89	AVG	

**REMARKS:**

- (1) Measurement Value = Reading Level + Correct Factor.
- (2) Margin Level = Measurement Value - Limit Value.

Orthogonal Axis	X
Test Mode	UNII-2C_TX N (HT40) Mode 5670 MHz

### Horizontal

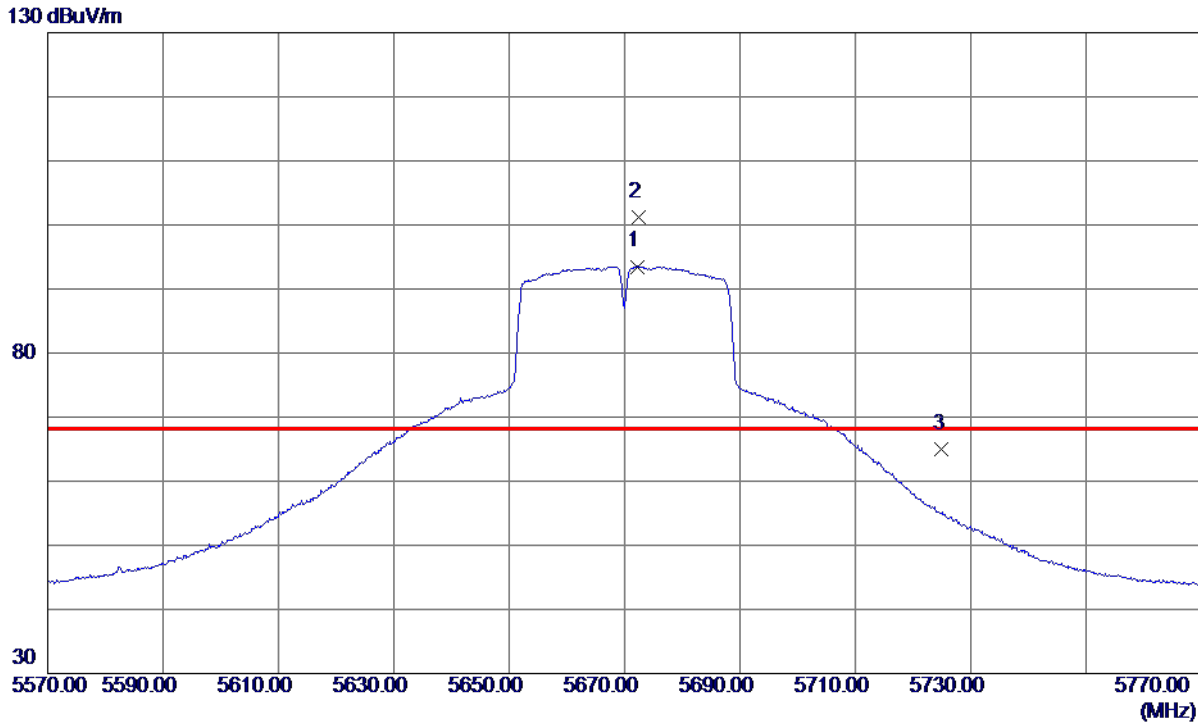

No.	Freq. MHz	Reading Level dBuV/m	Correct Factor dB	Measure ment dBuV/m	Limit dBuV/m	Margin dB	Detector	Comment
1	5672.3000	77.18	16.32	93.50	999.00	-905.50	AVG	No Limit
2 *	5672.5000	84.84	16.32	101.16	68.30	32.86	Peak	No Limit
3	5725.0000	48.51	16.52	65.03	68.30	-3.27	Peak	

**REMARKS:**

- (1) Measurement Value = Reading Level + Correct Factor.
- (2) Margin Level = Measurement Value - Limit Value.

Orthogonal Axis	X
Test Mode	UNII-2C_TX N (HT40) Mode 5670 MHz

**Horizontal**

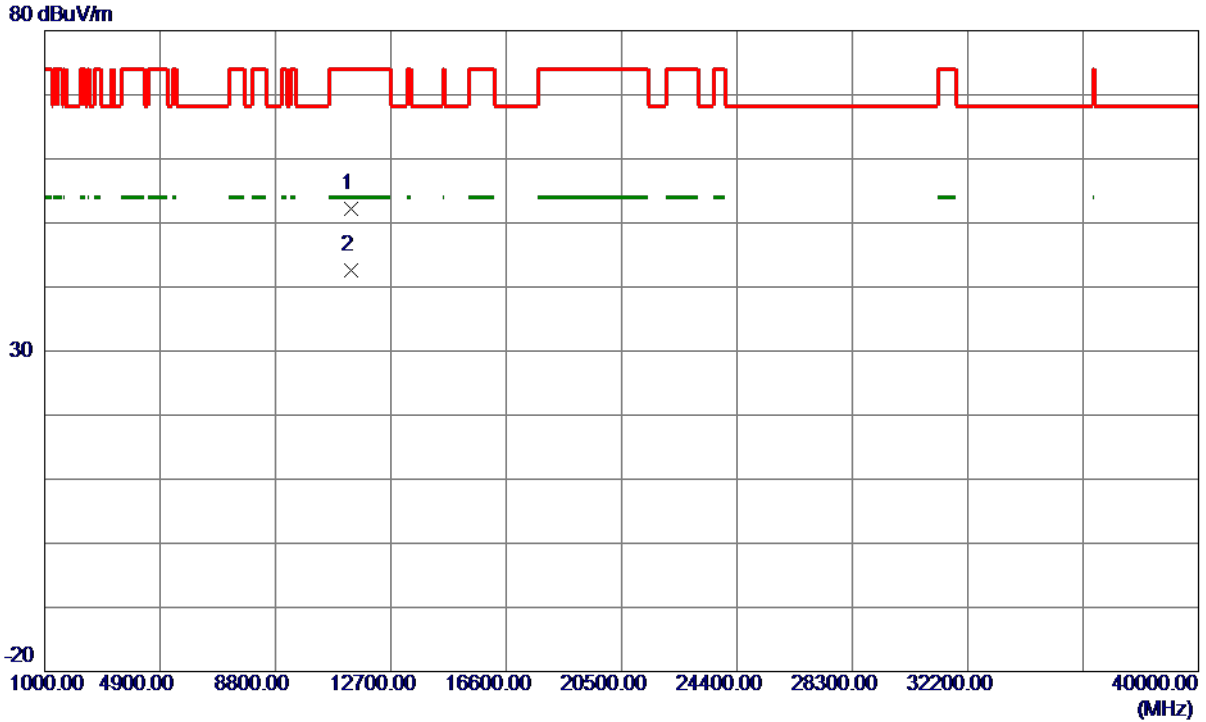

No.	Freq. MHz	Reading Level dBuV/m	Correct Factor dB	Measure ment dBuV/m	Limit dBuV/m	Margin dB	Detector	Comment
1	11336.8000	38.32	13.90	52.22	74.00	-21.78	Peak	
2 *	11340.2000	28.68	13.90	42.58	54.00	-11.42	AVG	

**REMARKS:**

- (1) Measurement Value = Reading Level + Correct Factor.
- (2) Margin Level = Measurement Value - Limit Value.



Orthogonal Axis	X
Test Mode	UNII-3_TX A Mode 5745 MHz

**Vertical**

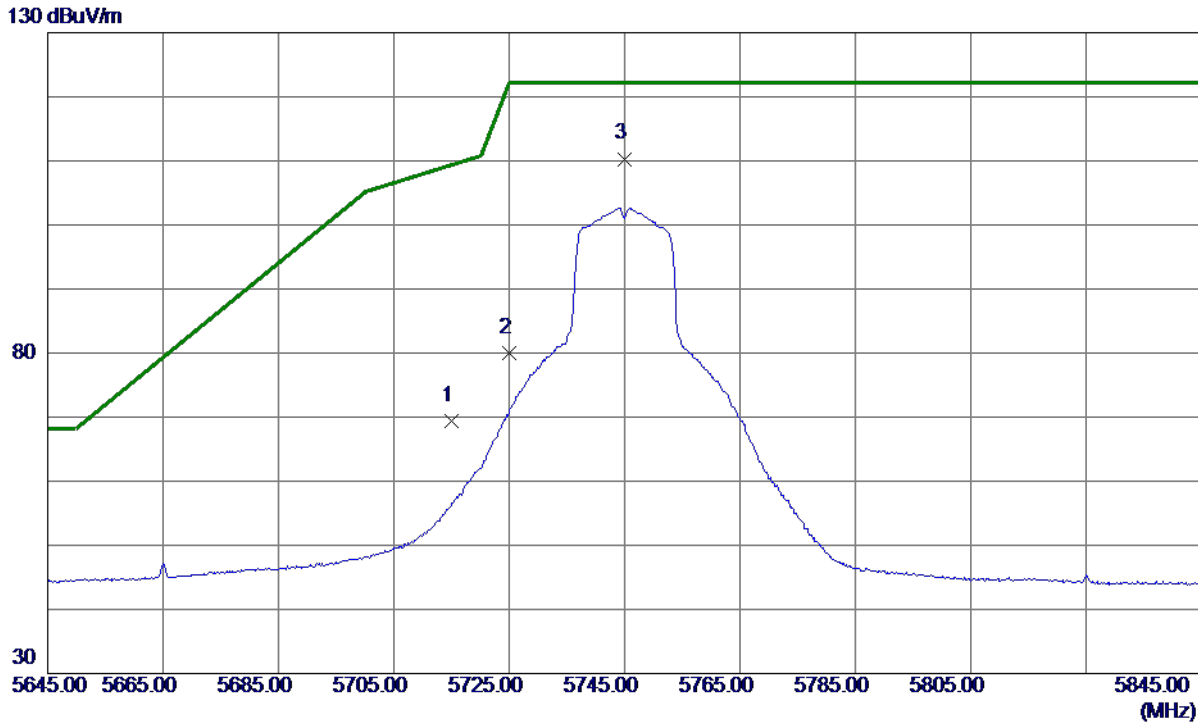

No.	Freq. MHz	Reading Level dBuV/m	Correct Factor dB	Measure ment dBuV/m	Limit dBuV/m	Margin dB	Detector	Comment
1	5715.0000	52.95	16.48	69.43	109.40	-39.97	Peak	
2	5725.0000	63.48	16.52	80.00	122.20	-42.20	Peak	
3 *	5745.1000	93.70	16.60	110.30	122.20	-11.90	Peak	No Limit

**REMARKS:**

- (1) Measurement Value = Reading Level + Correct Factor.
- (2) Margin Level = Measurement Value - Limit Value.

Orthogonal Axis	X
Test Mode	UNII-3_TX A Mode 5745 MHz

**Vertical**

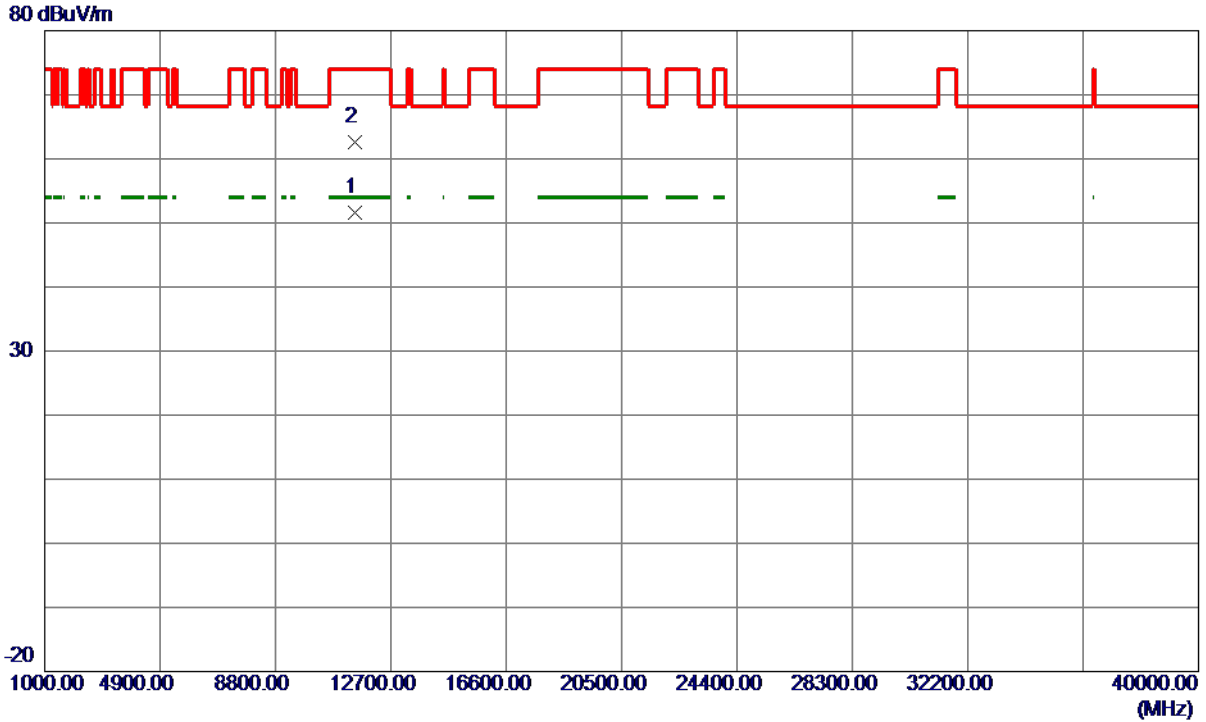

No.	Freq. MHz	Reading Level dBuV/m	Correct Factor dB	Measure ment dBuV/m	Limit dBuV/m	Margin dB	Detector	Comment
1 *	11490.1000	37.54	14.08	51.62	54.00	-2.38	AVG	
2	11490.7000	48.45	14.08	62.53	74.00	-11.47	Peak	

**REMARKS:**

- (1) Measurement Value = Reading Level + Correct Factor.
- (2) Margin Level = Measurement Value - Limit Value.

Orthogonal Axis	X
Test Mode	UNII-3_TX A Mode 5745 MHz

### Horizontal

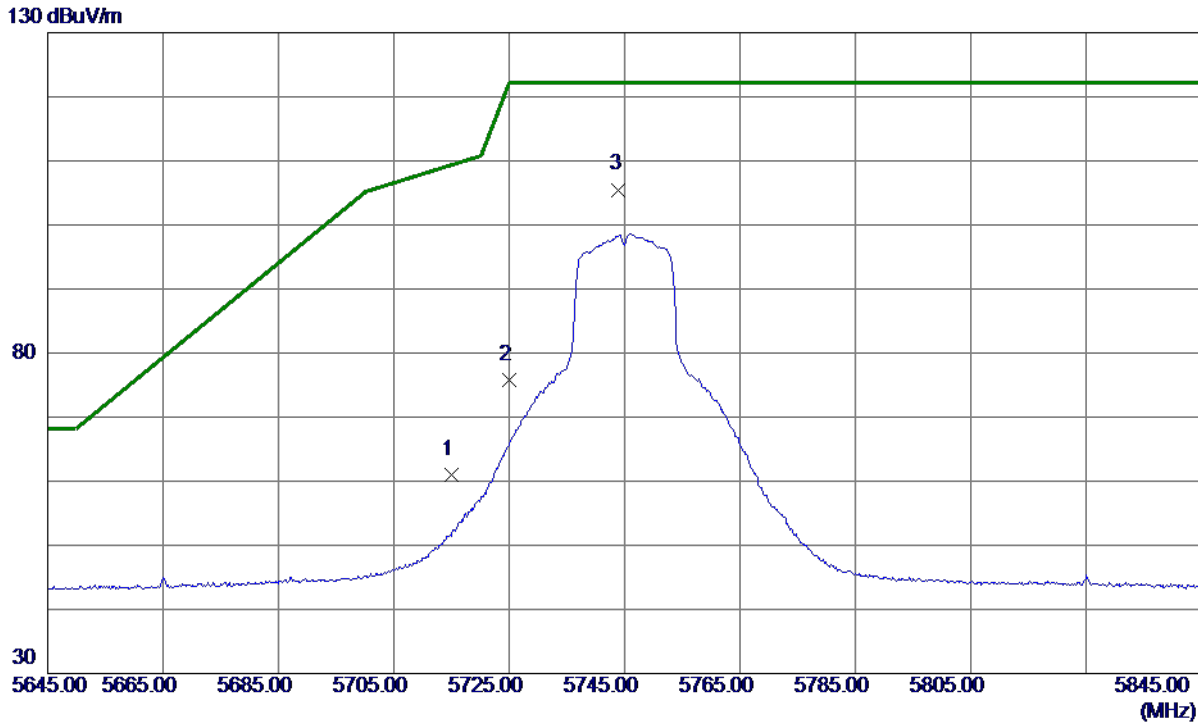

No.	Freq. MHz	Reading Level dBuV/m	Correct Factor dB	Measure ment dBuV/m	Limit dBuV/m	Margin dB	Detector	Comment
1	5715.0000	44.43	16.48	60.91	109.40	-48.49	Peak	
2	5725.0000	59.37	16.52	75.89	122.20	-46.31	Peak	
3 *	5744.0000	88.90	16.60	105.50	122.20	-16.70	Peak	No Limit

**REMARKS:**

- (1) Measurement Value = Reading Level + Correct Factor.
- (2) Margin Level = Measurement Value - Limit Value.

Orthogonal Axis	X
Test Mode	UNII-3_TX A Mode 5745 MHz

**Horizontal**

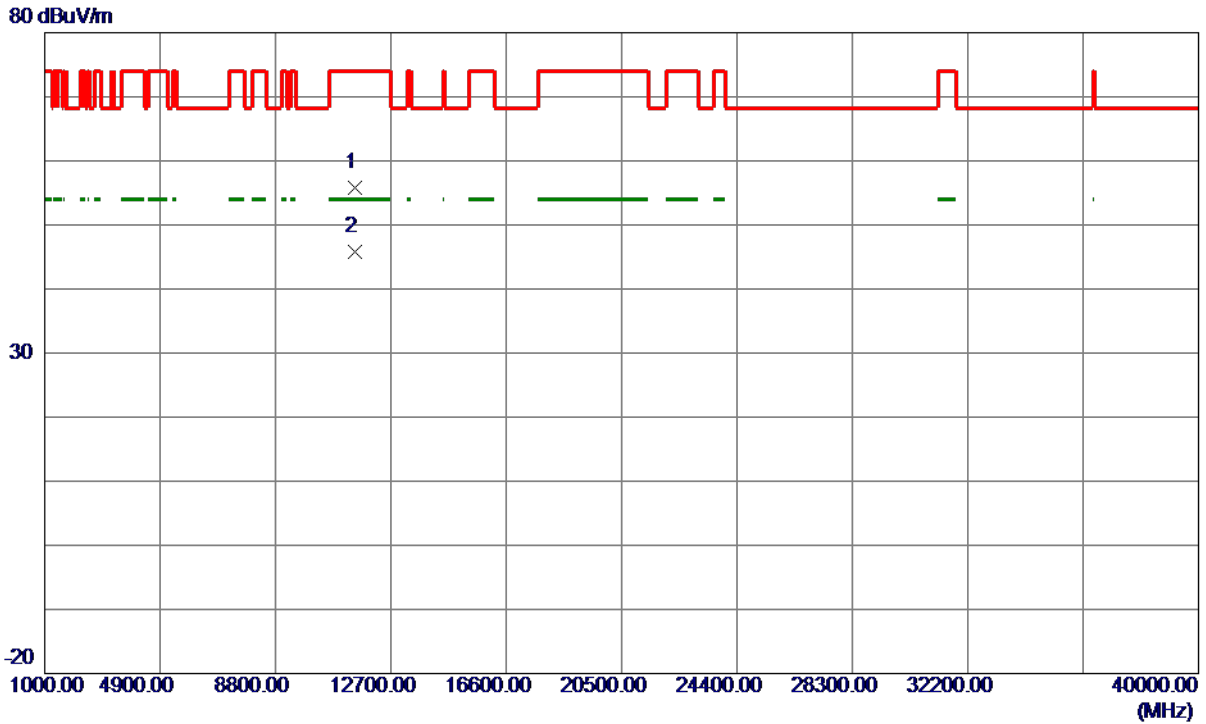

No.	Freq. MHz	Reading Level dBuV/m	Correct Factor dB	Measure ment dBuV/m	Limit dBuV/m	Margin dB	Detector	Comment
1	11490.5000	41.68	14.08	55.76	74.00	-18.24	Peak	
2 *	11492.1000	31.71	14.09	45.80	54.00	-8.20	AVG	

**REMARKS:**

- (1) Measurement Value = Reading Level + Correct Factor.
- (2) Margin Level = Measurement Value - Limit Value.

Orthogonal Axis	X
Test Mode	UNII-3_TX A Mode 5785 MHz

**Vertical**

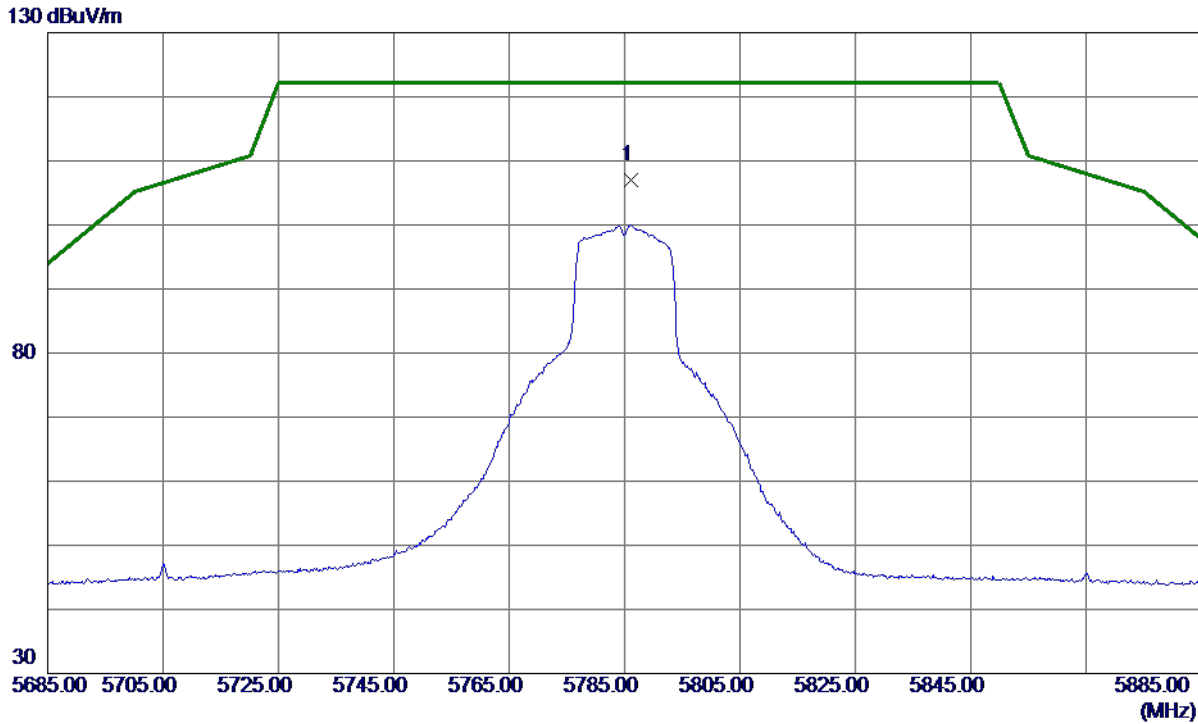

No.	Freq. MHz	Reading Level dBuV/m	Correct Factor dB	Measure ment dBuV/m	Limit dBuV/m	Margin dB	Detector	Comment
1 *	5786.2000	90.17	16.77	106.94	122.20	-15.26	Peak	No Limit

**REMARKS:**

- (1) Measurement Value = Reading Level + Correct Factor.
- (2) Margin Level = Measurement Value - Limit Value.

Orthogonal Axis	X
Test Mode	UNII-3_TX A Mode 5785 MHz

**Vertical**

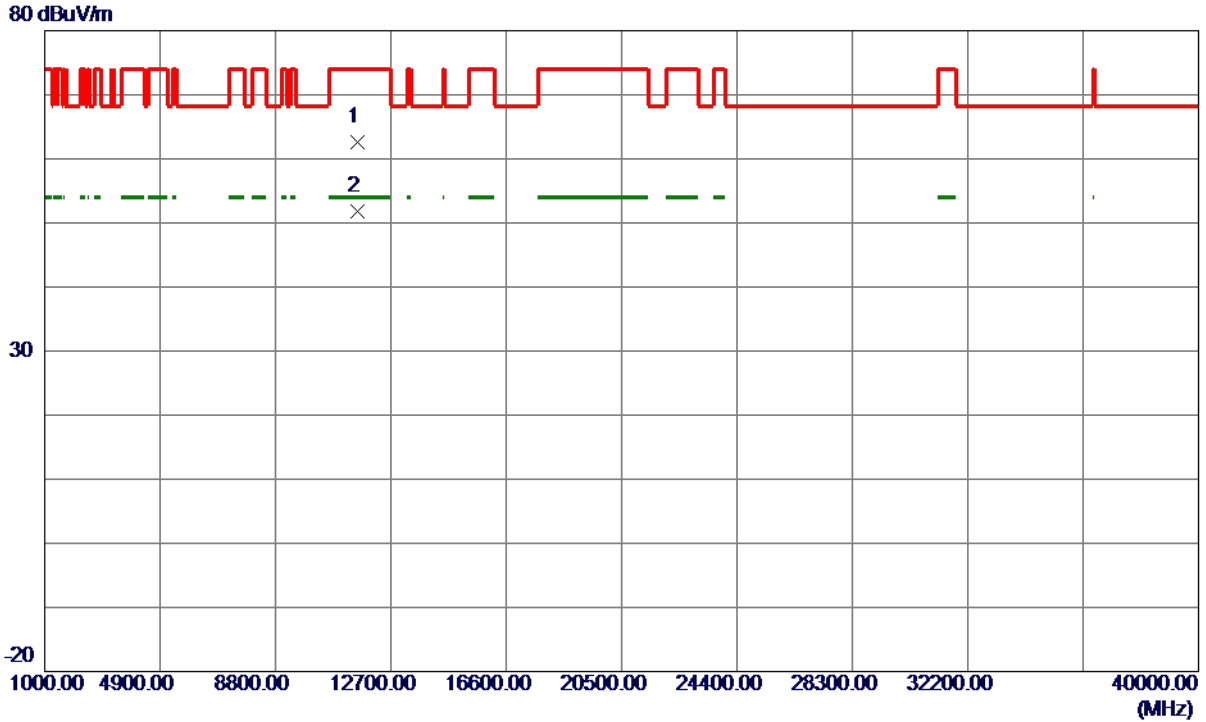

No.	Freq. MHz	Reading Level dBuV/m	Correct Factor dB	Measure ment dBuV/m	Limit dBuV/m	Margin dB	Detector	Comment
1	11569.0000	48.53	14.15	62.68	74.00	-11.32	Peak	
2 *	11569.6000	37.60	14.15	51.75	54.00	-2.25	AVG	

**REMARKS:**

- (1) Measurement Value = Reading Level + Correct Factor.
- (2) Margin Level = Measurement Value - Limit Value.

Orthogonal Axis	X
Test Mode	UNII-3_TX A Mode 5785 MHz

**Horizontal**

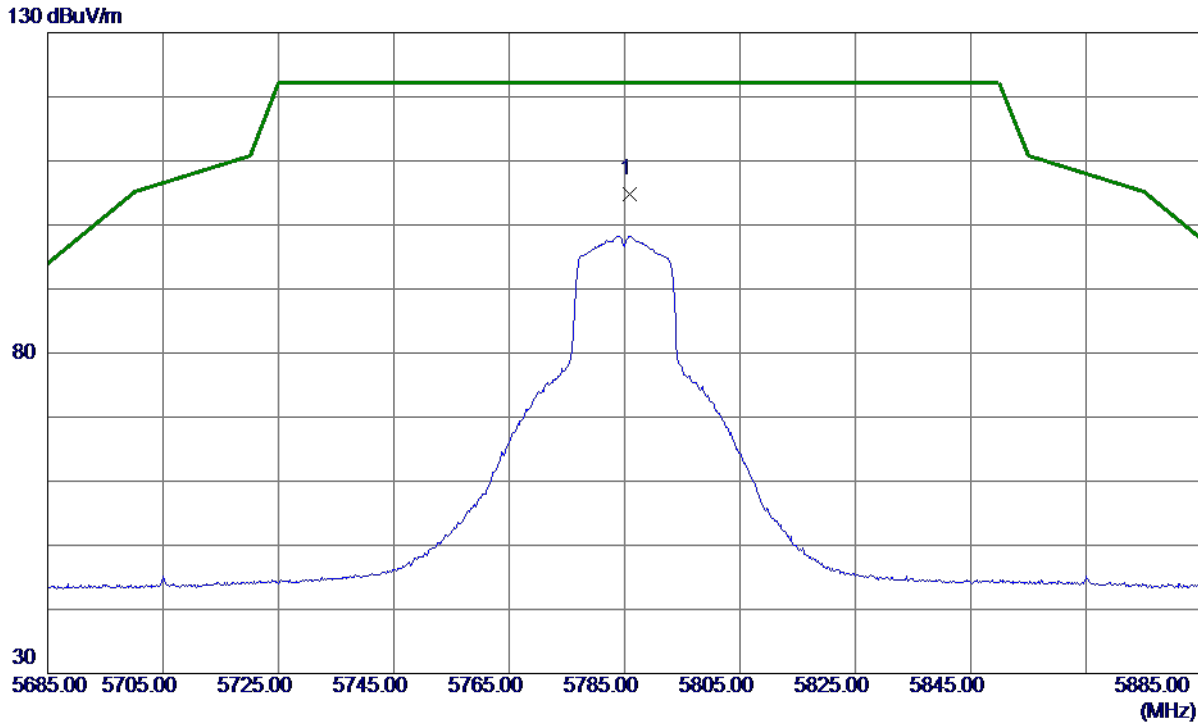

No.	Freq. MHz	Reading Level dBuV/m	Correct Factor dB	Measure ment dBuV/m	Limit dBuV/m	Margin dB	Detector	Comment
1 *	5785.9000	88.01	16.76	104.77	122.20	-17.43	Peak	No Limit

**REMARKS:**

- (1) Measurement Value = Reading Level + Correct Factor.
- (2) Margin Level = Measurement Value - Limit Value.

Orthogonal Axis	X
Test Mode	UNII-3_TX A Mode 5785 MHz

**Horizontal**

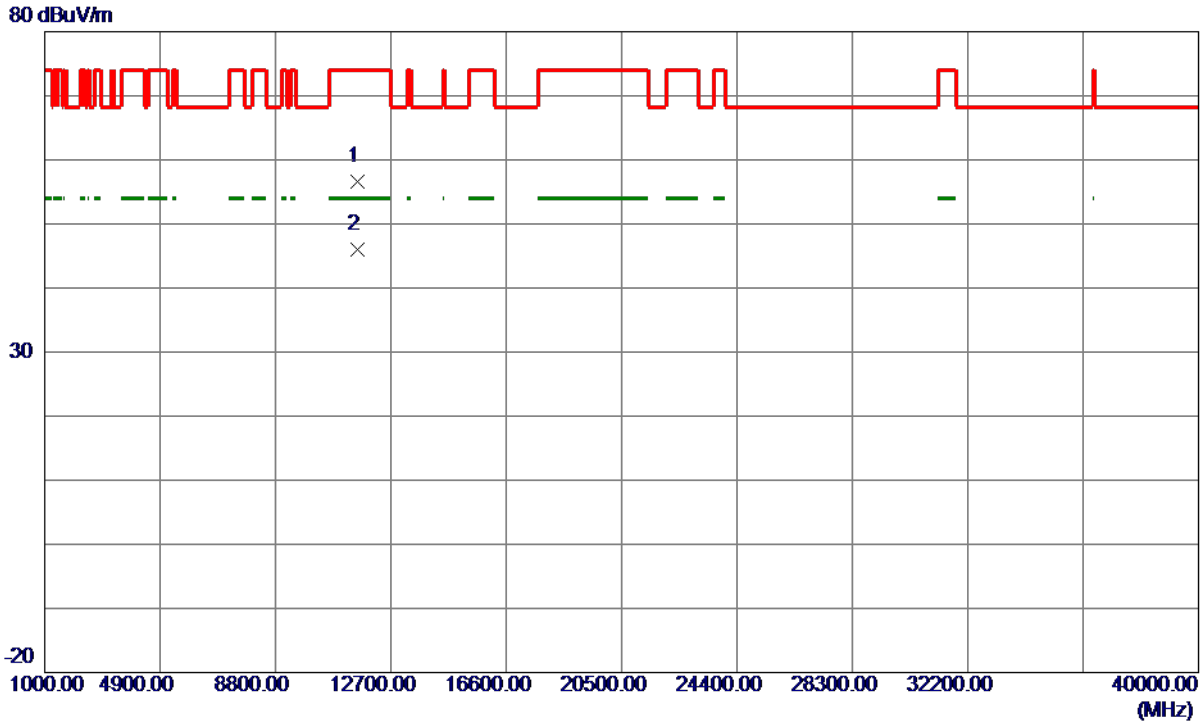

No.	Freq. MHz	Reading Level dBuV/m	Correct Factor dB	Measure ment dBuV/m	Limit dBuV/m	Margin dB	Detector	Comment
1	11566.7000	42.53	14.15	56.68	74.00	-17.32	Peak	
2 *	11569.8000	31.77	14.15	45.92	54.00	-8.08	AVG	

**REMARKS:**

- (1) Measurement Value = Reading Level + Correct Factor.
- (2) Margin Level = Measurement Value - Limit Value.



Orthogonal Axis	X
Test Mode	UNII-3_TX A Mode 5825 MHz

**Vertical**

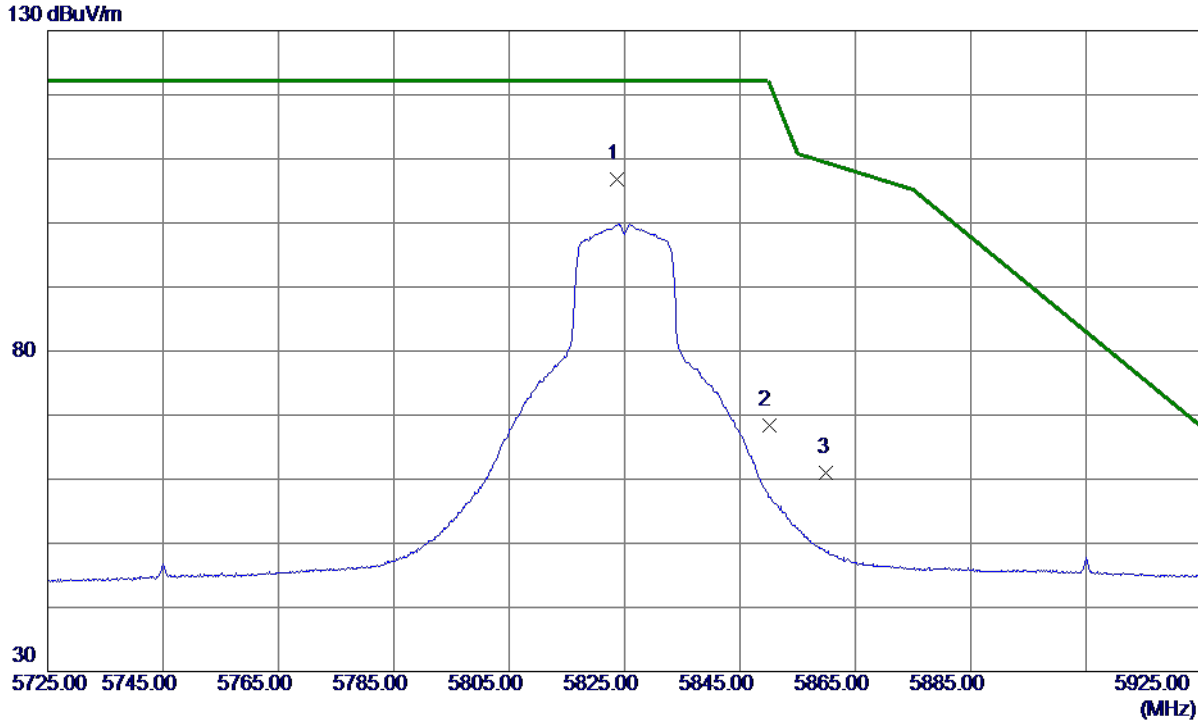

No.	Freq. MHz	Reading Level dBuV/m	Correct Factor dB	Measure ment dBuV/m	Limit dBuV/m	Margin dB	Detector	Comment
1 *	5823.7000	89.96	16.91	106.87	122.20	-15.33	Peak	No Limit
2	5850.0000	51.34	17.02	68.36	122.20	-53.84	Peak	
3	5860.0000	43.85	17.06	60.91	109.40	-48.49	Peak	

**REMARKS:**

- (1) Measurement Value = Reading Level + Correct Factor.
- (2) Margin Level = Measurement Value - Limit Value.

Orthogonal Axis	X
Test Mode	UNII-3_TX A Mode 5825 MHz

**Vertical**



No.	Freq. MHz	Reading Level dBuV/m	Correct Factor dB	Measure ment dBuV/m	Limit dBuV/m	Margin dB	Detector	Comment
1	11648.8000	48.16	14.21	62.37	74.00	-11.63	Peak	
2 *	11649.7000	37.53	14.21	51.74	54.00	-2.26	AVG	

**REMARKS:**

- (1) Measurement Value = Reading Level + Correct Factor.
- (2) Margin Level = Measurement Value - Limit Value.

Orthogonal Axis	X
Test Mode	UNII-3_TX A Mode 5825 MHz

**Horizontal**

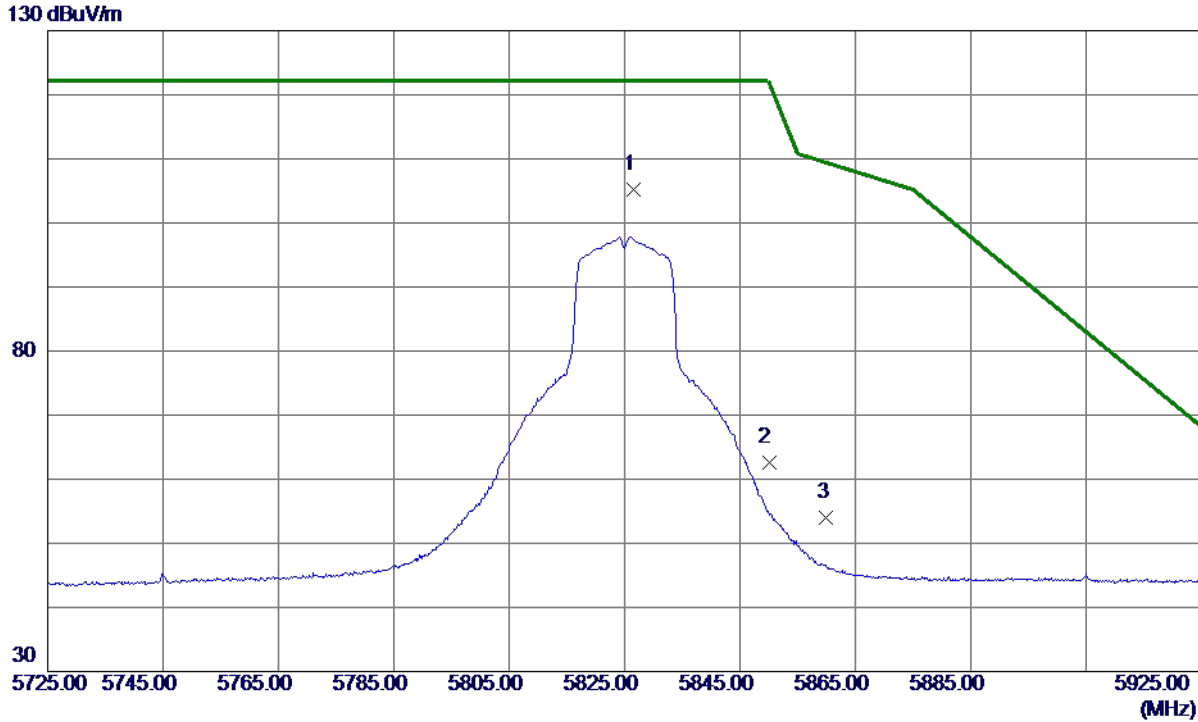

No.	Freq. MHz	Reading Level dBuV/m	Correct Factor dB	Measure ment dBuV/m	Limit dBuV/m	Margin dB	Detector	Comment
1 *	5826.5000	88.20	16.92	105.12	122.20	-17.08	Peak	No Limit
2	5850.0000	45.56	17.02	62.58	122.20	-59.62	Peak	
3	5860.0000	36.89	17.06	53.95	109.40	-55.45	Peak	

**REMARKS:**

- (1) Measurement Value = Reading Level + Correct Factor.
- (2) Margin Level = Measurement Value - Limit Value.

Orthogonal Axis	X
Test Mode	UNII-3_TX A Mode 5825 MHz

**Horizontal**

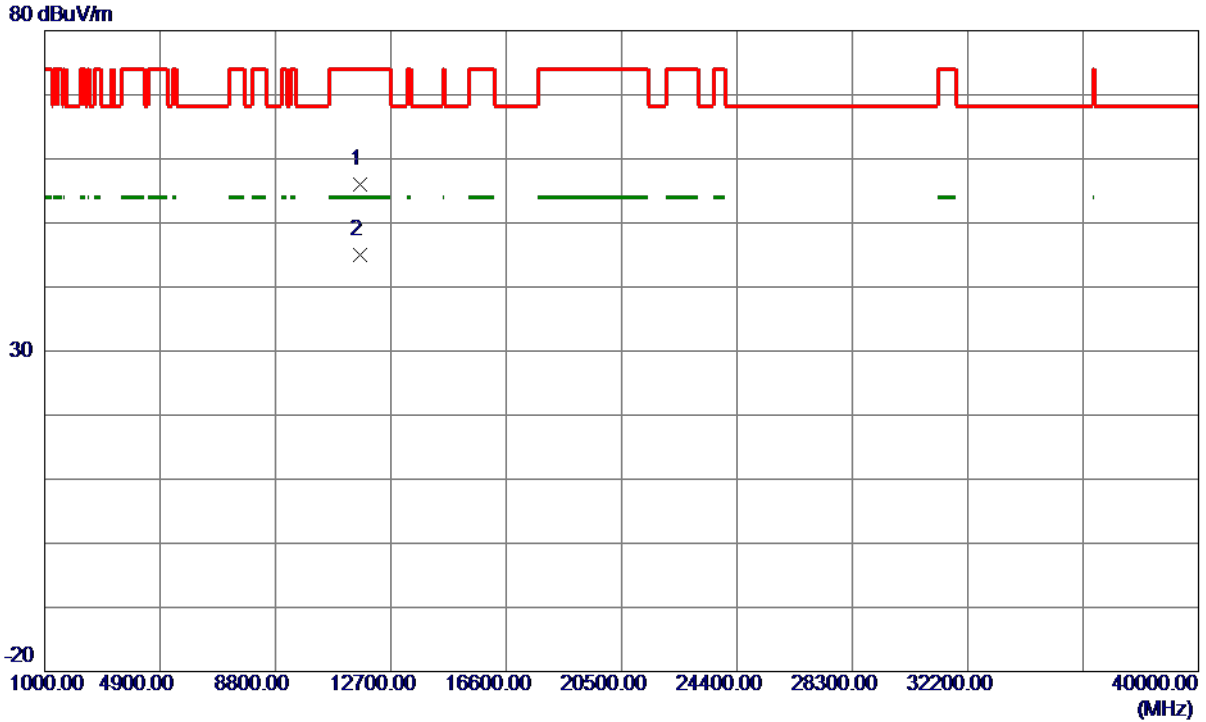

No.	Freq. MHz	Reading Level dBuV/m	Correct Factor dB	Measure ment dBuV/m	Limit dBuV/m	Margin dB	Detector	Comment
1	11648.3000	41.76	14.21	55.97	74.00	-18.03	Peak	
2 *	11648.5000	30.85	14.21	45.06	54.00	-8.94	AVG	

**REMARKS:**

- (1) Measurement Value = Reading Level + Correct Factor.
- (2) Margin Level = Measurement Value - Limit Value.

Orthogonal Axis	X
Test Mode	UNII-3_TX N (HT20) Mode 5745 MHz

**Vertical**

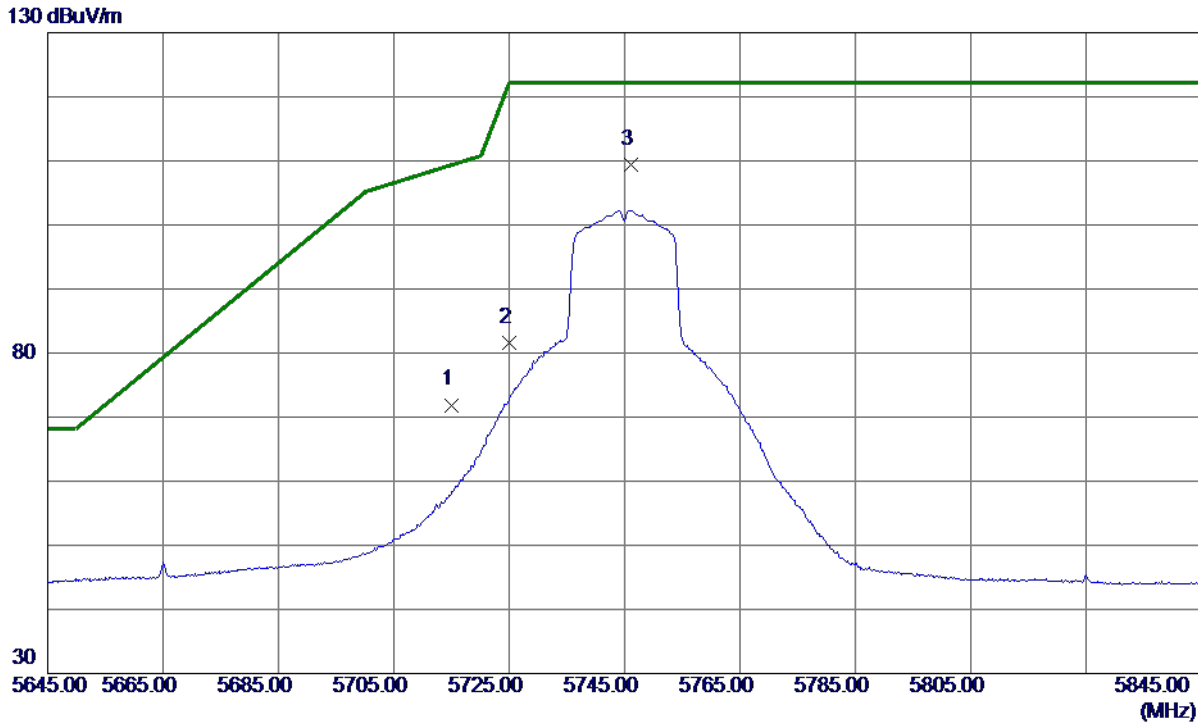

No.	Freq. MHz	Reading Level dBuV/m	Correct Factor dB	Measure ment dBuV/m	Limit dBuV/m	Margin dB	Detector	Comment
1	5715.0000	55.42	16.48	71.90	109.40	-37.50	Peak	
2	5725.0000	65.01	16.52	81.53	122.20	-40.67	Peak	
3 *	5746.1000	92.79	16.61	109.40	122.20	-12.80	Peak	No Limit

**REMARKS:**

- (1) Measurement Value = Reading Level + Correct Factor.
- (2) Margin Level = Measurement Value - Limit Value.

Orthogonal Axis	X
Test Mode	UNII-3_TX N (HT20) Mode 5745 MHz

Vertical

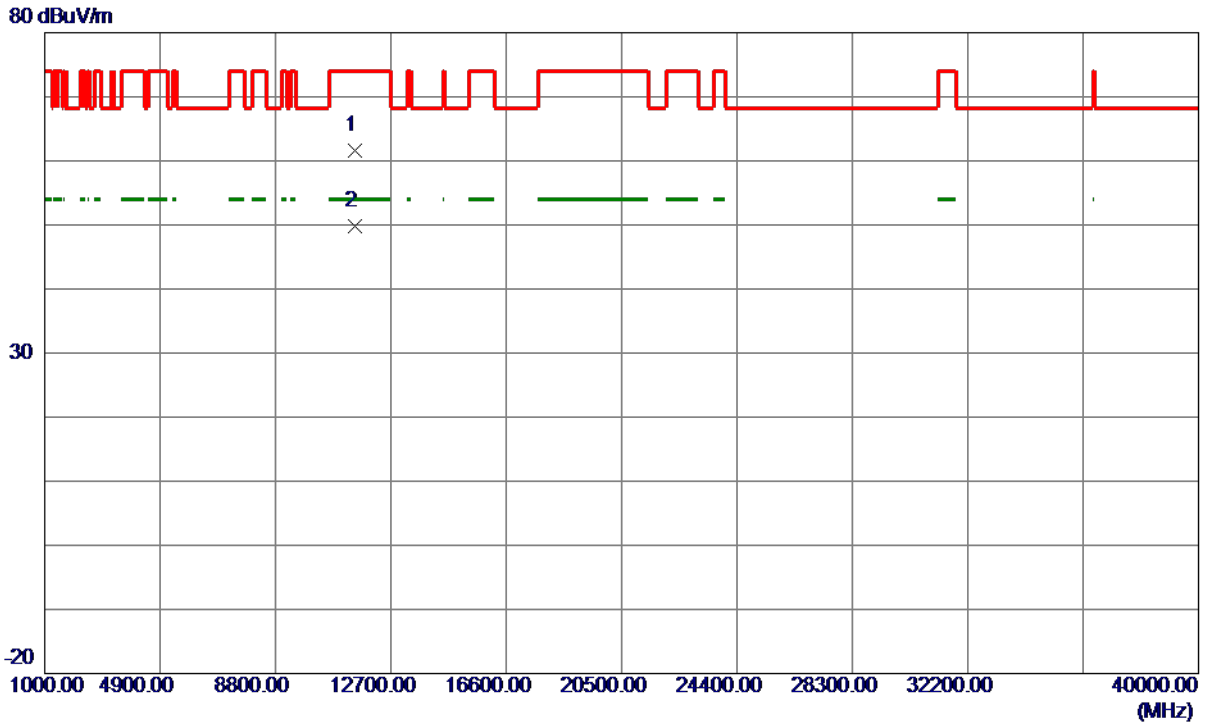

No.	Freq. MHz	Reading Level dBuV/m	Correct Factor dB	Measure ment dBuV/m	Limit dBuV/m	Margin dB	Detector	Comment
1	11490.0000	47.51	14.08	61.59	74.00	-12.41	Peak	
2 *	11491.2000	35.79	14.08	49.87	54.00	-4.13	AVG	

REMARKS:

- (1) Measurement Value = Reading Level + Correct Factor.
- (2) Margin Level = Measurement Value - Limit Value.

Orthogonal Axis	X
Test Mode	UNII-3_TX N (HT20) Mode 5745 MHz

**Horizontal**

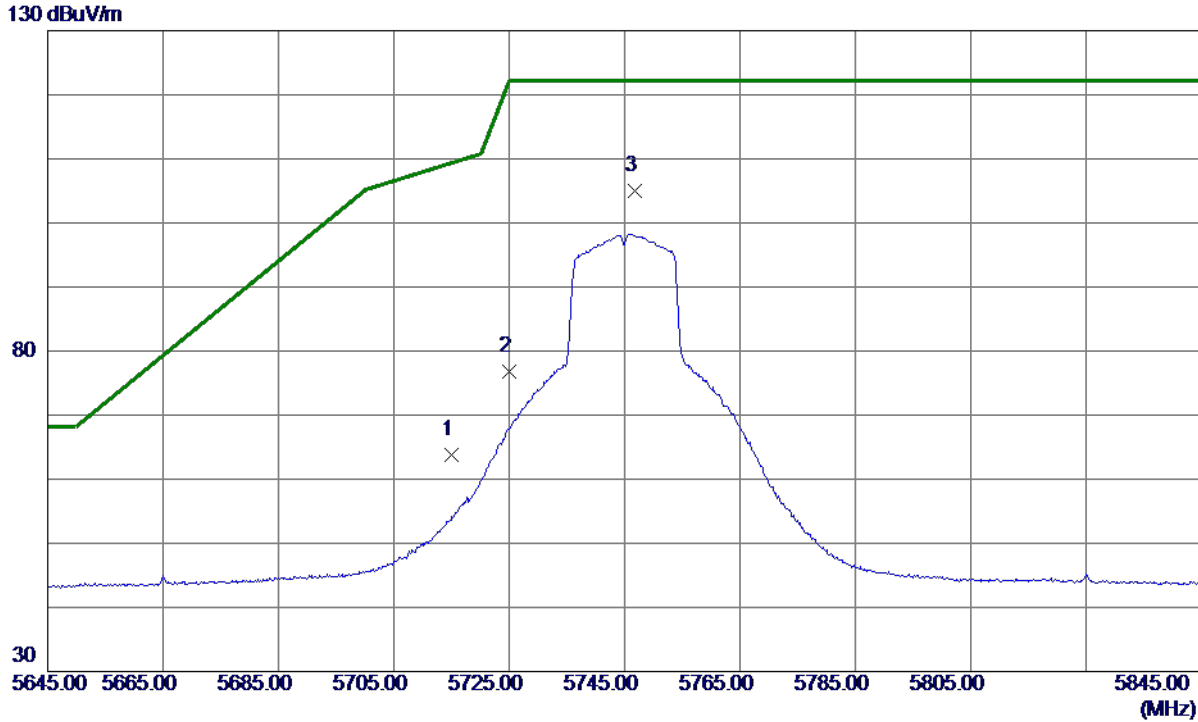

No.	Freq. MHz	Reading Level dBuV/m	Correct Factor dB	Measure ment dBuV/m	Limit dBuV/m	Margin dB	Detector	Comment
1	5715.0000	47.36	16.48	63.84	109.40	-45.56	Peak	
2	5725.0000	60.26	16.52	76.78	122.20	-45.42	Peak	
3 *	5746.7000	88.44	16.61	105.05	122.20	-17.15	Peak	No Limit

**REMARKS:**

- (1) Measurement Value = Reading Level + Correct Factor.
- (2) Margin Level = Measurement Value - Limit Value.

Orthogonal Axis	X
Test Mode	UNII-3_TX N (HT20) Mode 5745 MHz

**Horizontal**

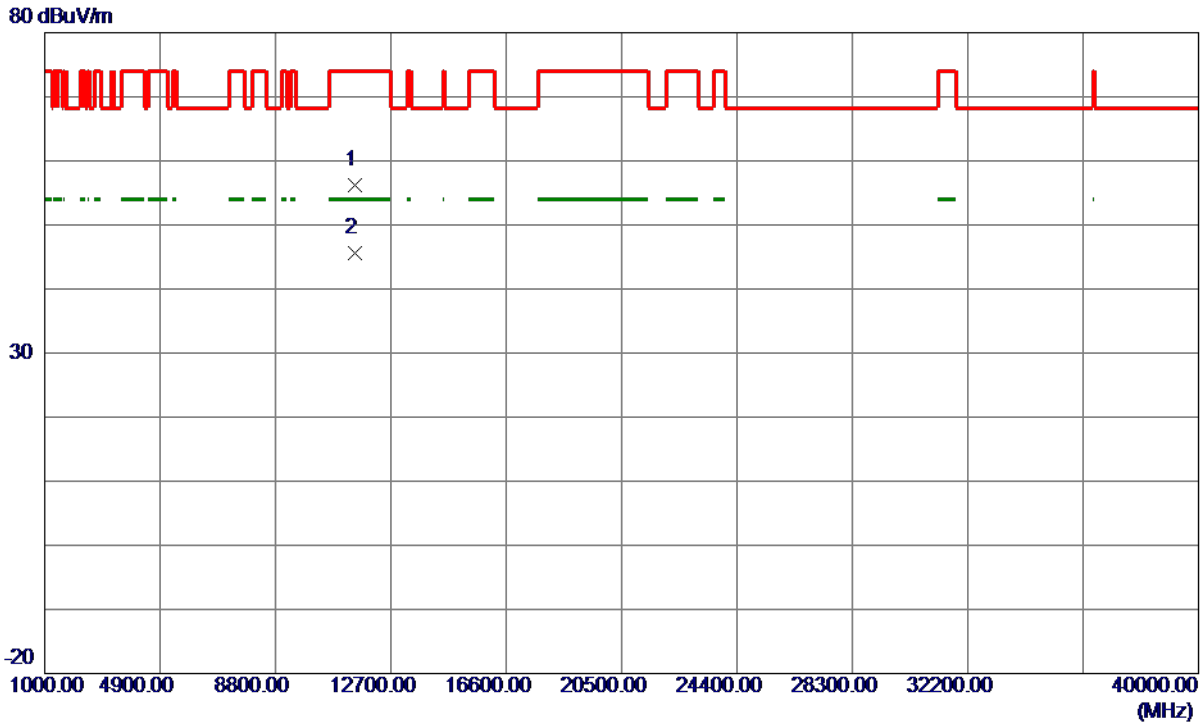

No.	Freq. MHz	Reading Level dBuV/m	Correct Factor dB	Measure ment dBuV/m	Limit dBuV/m	Margin dB	Detector	Comment
1	11487.7000	42.09	14.08	56.17	74.00	-17.83	Peak	
2 *	11491.1000	31.45	14.08	45.53	54.00	-8.47	AVG	

**REMARKS:**

- (1) Measurement Value = Reading Level + Correct Factor.
- (2) Margin Level = Measurement Value - Limit Value.



Orthogonal Axis	X
Test Mode	UNII-3_TX N (HT20) Mode 5785 MHz

**Vertical**

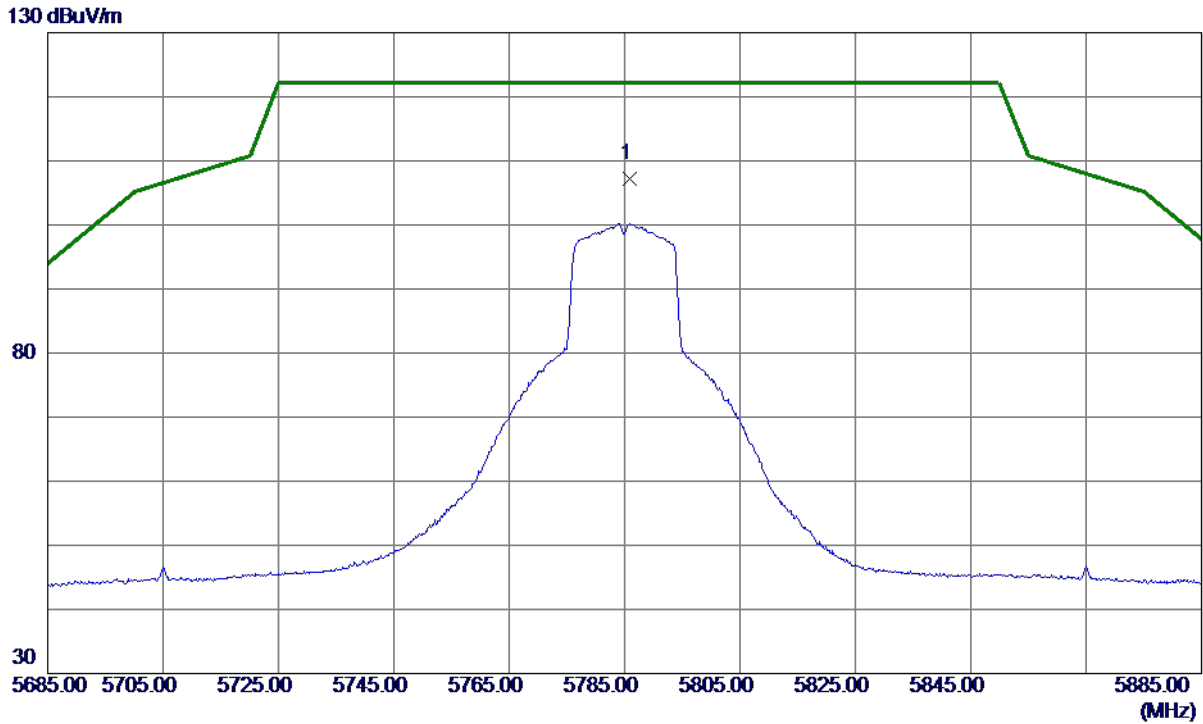

No.	Freq. MHz	Reading Level dBuV/m	Correct Factor dB	Measure ment dBuV/m	Limit dBuV/m	Margin dB	Detector	Comment
1 *	5785.9000	90.37	16.76	107.13	122.20	-15.07	Peak	No Limit

**REMARKS:**

- (1) Measurement Value = Reading Level + Correct Factor.
- (2) Margin Level = Measurement Value - Limit Value.

Orthogonal Axis	X
Test Mode	UNII-3_TX N (HT20) Mode 5785 MHz

**Vertical**

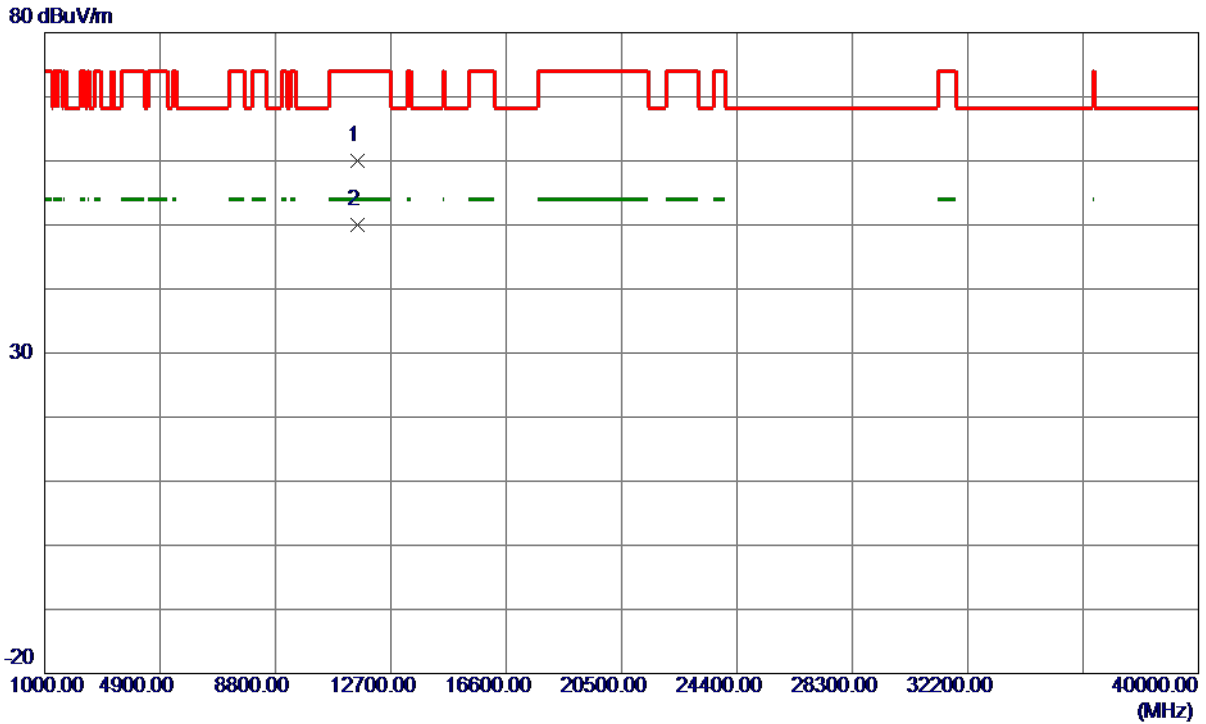

No.	Freq. MHz	Reading Level dBuV/m	Correct Factor dB	Measure ment dBuV/m	Limit dBuV/m	Margin dB	Detector	Comment
1	11571.2000	45.85	14.15	60.00	74.00	-14.00	Peak	
2 *	11571.8000	35.83	14.15	49.98	54.00	-4.02	AVG	

**REMARKS:**

- (1) Measurement Value = Reading Level + Correct Factor.
- (2) Margin Level = Measurement Value - Limit Value.

Orthogonal Axis	X
Test Mode	UNII-3_TX N (HT20) Mode 5785 MHz

### Horizontal

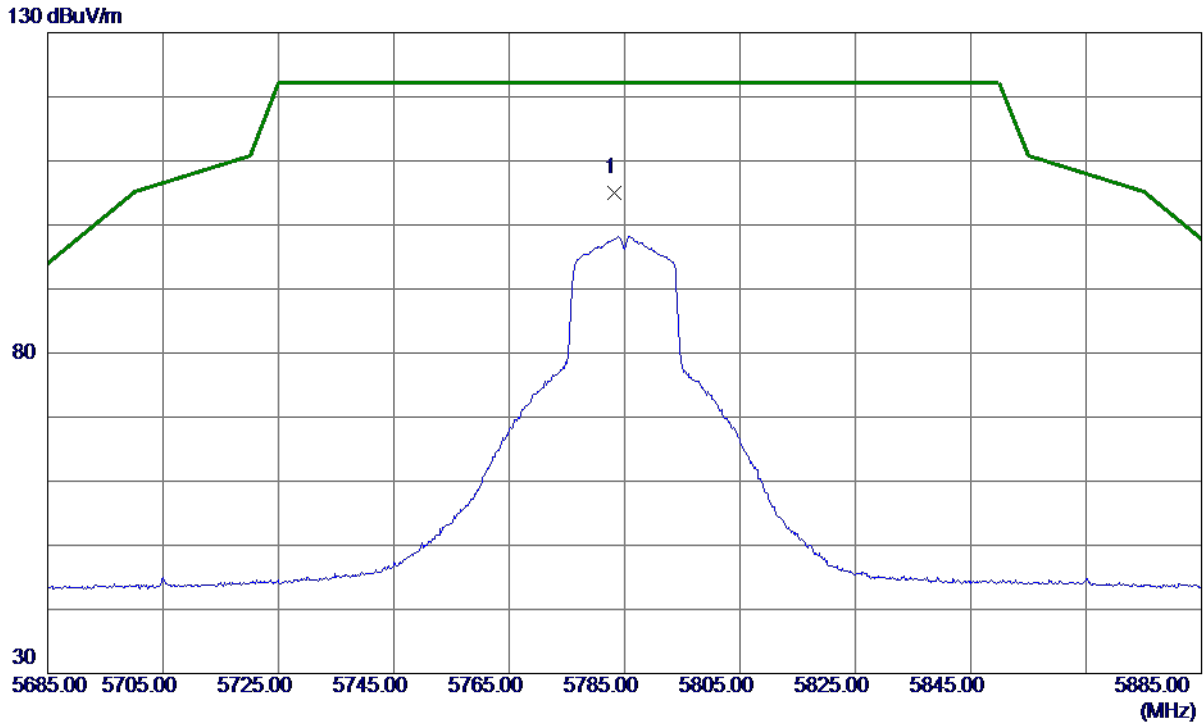

No.	Freq. MHz	Reading Level dBuV/m	Correct Factor dB	Measure ment dBuV/m	Limit dBuV/m	Margin dB	Detector	Comment
1 *	5783.2000	88.25	16.75	105.00	122.20	-17.20	Peak	No Limit

**REMARKS:**

- (1) Measurement Value = Reading Level + Correct Factor.
- (2) Margin Level = Measurement Value - Limit Value.

Orthogonal Axis	X
Test Mode	UNII-3_TX N (HT20) Mode 5785 MHz

**Horizontal**

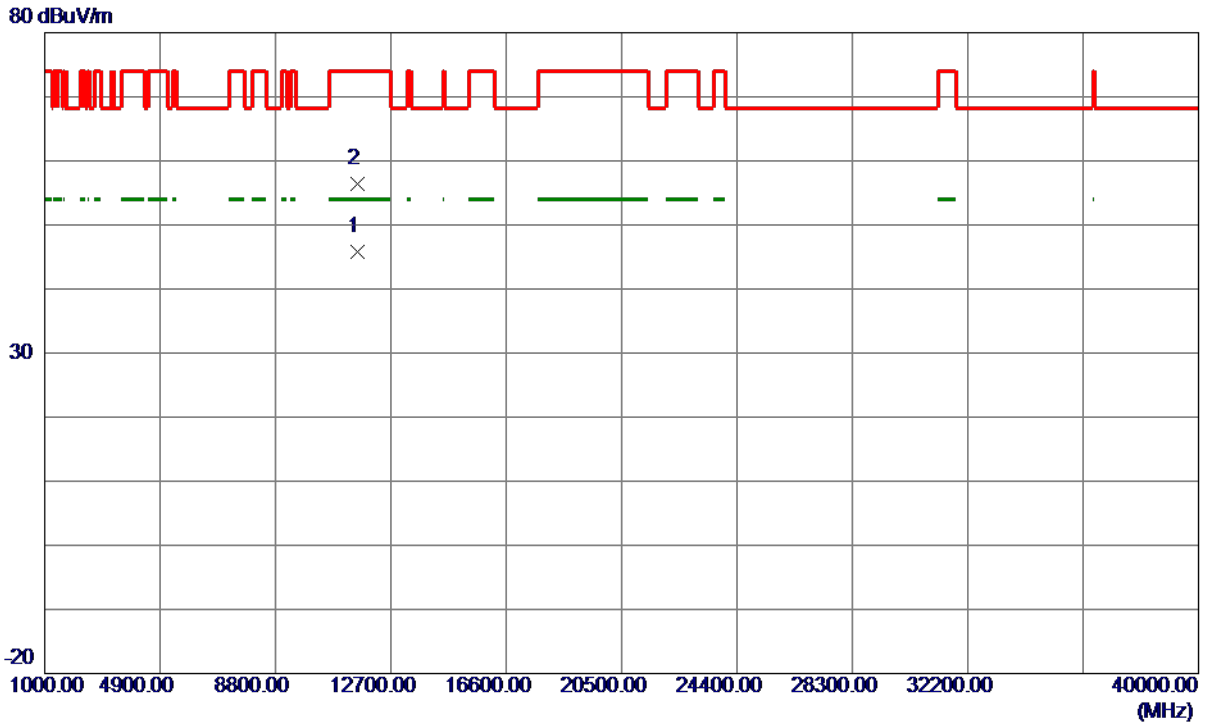

No.	Freq. MHz	Reading Level dBuV/m	Correct Factor dB	Measure ment dBuV/m	Limit dBuV/m	Margin dB	Detector	Comment
1 *	11570.3000	31.65	14.15	45.80	54.00	-8.20	AVG	
2	11572.5000	42.18	14.15	56.33	74.00	-17.67	Peak	

**REMARKS:**

- (1) Measurement Value = Reading Level + Correct Factor.
- (2) Margin Level = Measurement Value - Limit Value.

Orthogonal Axis	X
Test Mode	UNII-3_TX N (HT20) Mode 5825 MHz

**Vertical**

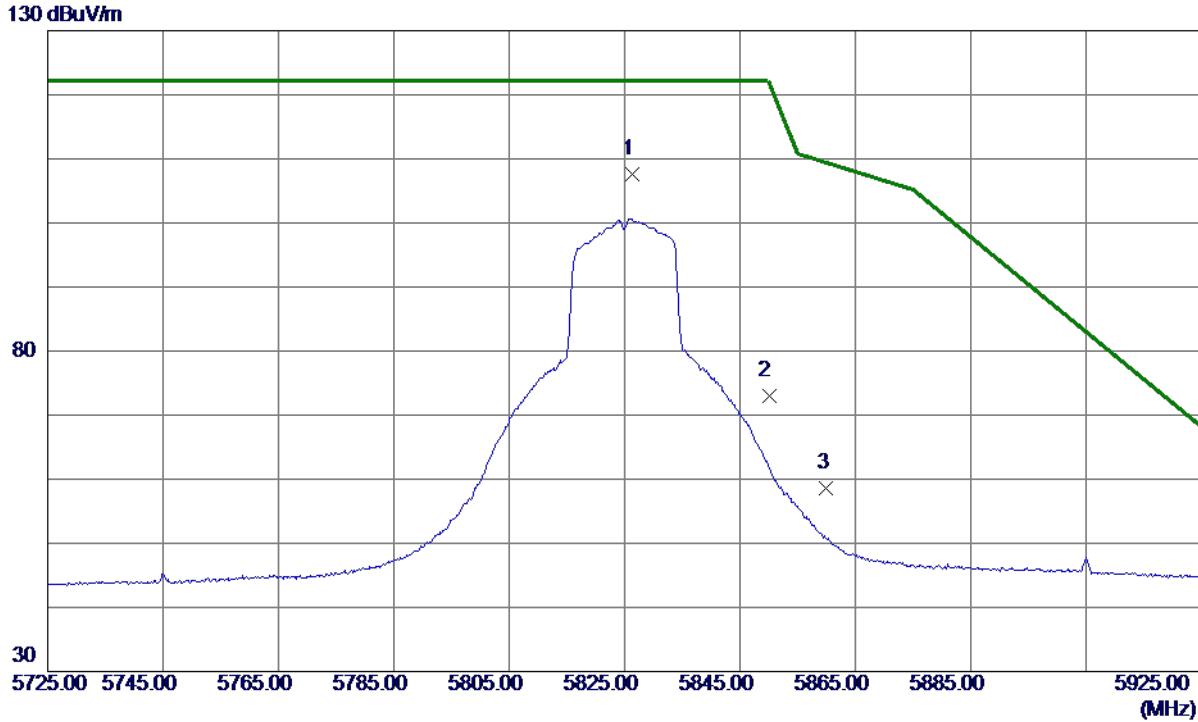

No.	Freq. MHz	Reading Level dBuV/m	Correct Factor dB	Measure ment dBuV/m	Limit dBuV/m	Margin dB	Detector	Comment
1 *	5826.3000	90.74	16.92	107.66	122.20	-14.54	Peak	No Limit
2	5850.0000	55.94	17.02	72.96	122.20	-49.24	Peak	
3	5860.0000	41.55	17.06	58.61	109.40	-50.79	Peak	

**REMARKS:**

- (1) Measurement Value = Reading Level + Correct Factor.
- (2) Margin Level = Measurement Value - Limit Value.

Orthogonal Axis	X
Test Mode	UNII-3_TX N (HT20) Mode 5825 MHz

**Vertical**

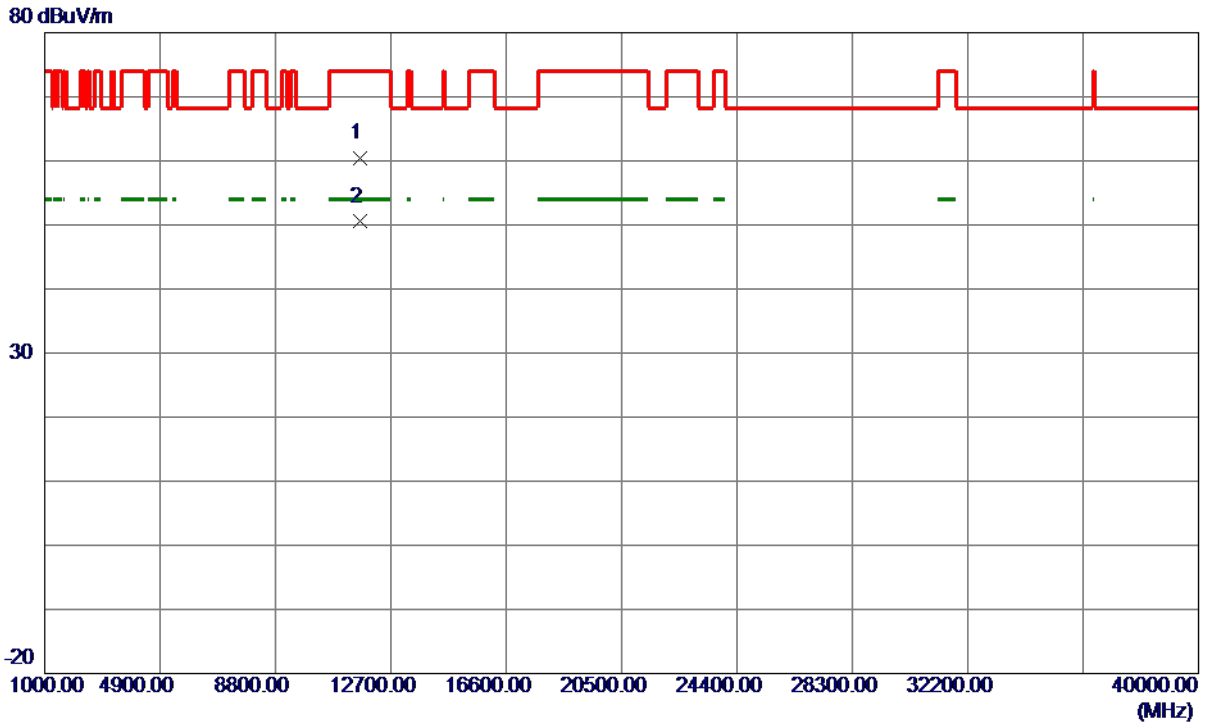

No.	Freq. MHz	Reading Level dBuV/m	Correct Factor dB	Measure ment dBuV/m	Limit dBuV/m	Margin dB	Detector	Comment
1	11651.6000	46.23	14.21	60.44	74.00	-13.56	Peak	
2 *	11652.2000	36.28	14.22	50.50	54.00	-3.50	AVG	

**REMARKS:**

- (1) Measurement Value = Reading Level + Correct Factor.
- (2) Margin Level = Measurement Value - Limit Value.

Orthogonal Axis	X
Test Mode	UNII-3_TX N (HT20) Mode 5825 MHz

**Horizontal**

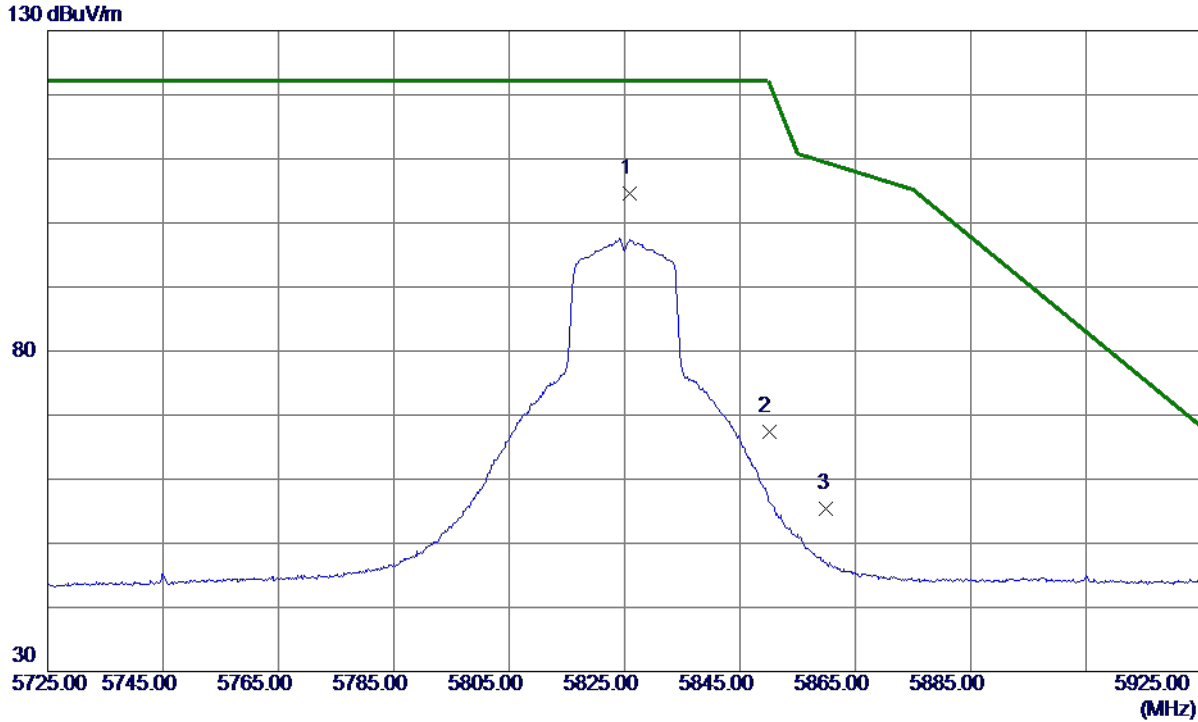

No.	Freq. MHz	Reading Level dBuV/m	Correct Factor dB	Measure ment dBuV/m	Limit dBuV/m	Margin dB	Detector	Comment
1 *	5825.9000	87.69	16.92	104.61	122.20	-17.59	Peak	No Limit
2	5850.0000	50.37	17.02	67.39	122.20	-54.81	Peak	
3	5860.0000	38.42	17.06	55.48	109.40	-53.92	Peak	

**REMARKS:**

- (1) Measurement Value = Reading Level + Correct Factor.
- (2) Margin Level = Measurement Value - Limit Value.

Orthogonal Axis	X
Test Mode	UNII-3_TX N (HT20) Mode 5825 MHz

**Horizontal**

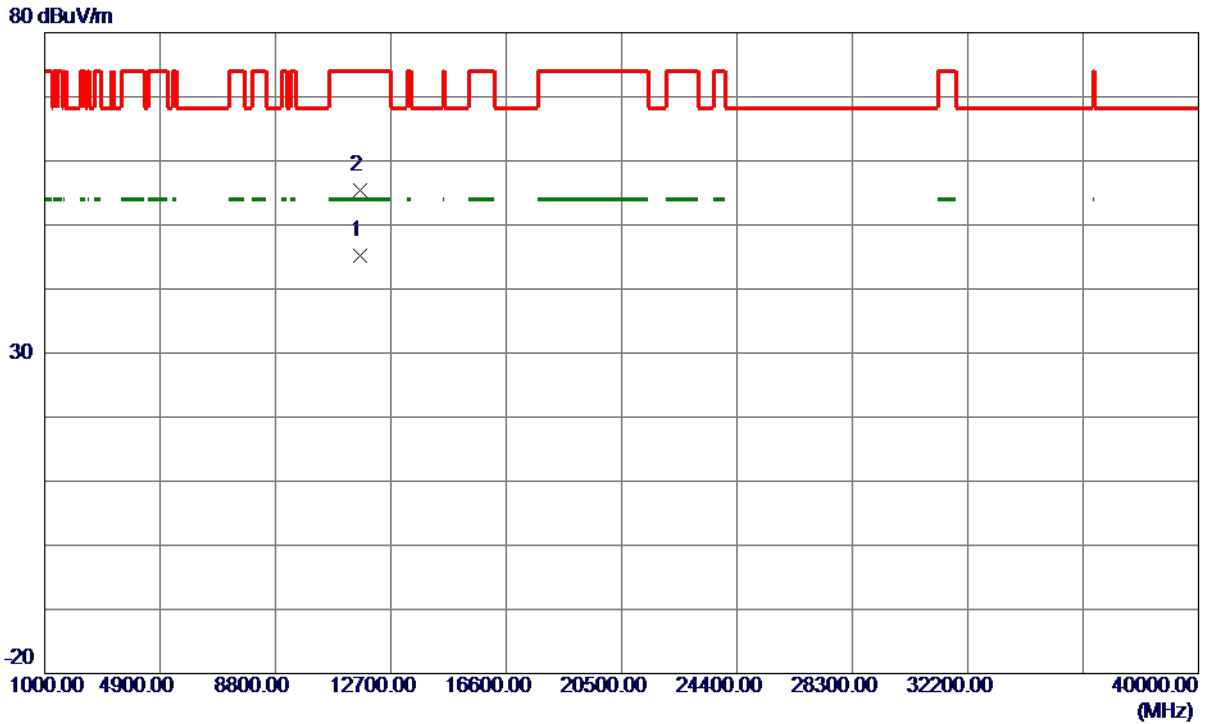

No.	Freq. MHz	Reading Level dBuV/m	Correct Factor dB	Measure ment dBuV/m	Limit dBuV/m	Margin dB	Detector	Comment
1 *	11648.8000	31.07	14.21	45.28	54.00	-8.72	AVG	
2	11654.0000	41.13	14.22	55.35	74.00	-18.65	Peak	

**REMARKS:**

- (1) Measurement Value = Reading Level + Correct Factor.
- (2) Margin Level = Measurement Value - Limit Value.