



CHANNEL BANDWIDTH: 5MHz QPSK

Channel	Frequency (MHz)	Conducted Power (dBm)	G _{T-Lc} (dB)	ERP (dBm)	ERP (mW)	Limit (W)
26815	826.5	22.3	-3	17.15	51.88	7
26915	836.5	22.28	-3	17.13	51.64	7
27015	846.5	22.46	-3	17.31	53.83	7

CHANNEL BANDWIDTH: 5MHz 16QAM

Channel	Frequency (MHz)	Conducted Power (dBm)	G _{T-Lc} (dB)	ERP (dBm)	ERP (mW)	Limit (W)
26815	826.5	21.77	-3	16.62	45.92	7
26915	836.5	21.81	-3	16.66	46.34	7
27015	846.5	21.9	-3	16.75	47.32	7

CHANNEL BANDWIDTH: 5MHz 64QAM

Channel	Frequency (MHz)	Conducted Power (dBm)	G _{T-Lc} (dB)	ERP (dBm)	ERP (mW)	Limit (W)
26815	826.5	20.46	-3	15.31	33.96	7
26915	836.5	20.43	-3	15.28	33.73	7
27015	846.5	20.6	-3	15.45	35.08	7



CHANNEL BANDWIDTH: 10MHz QPSK

Channel	Frequency (MHz)	Conducted Power (dBm)	G _{T-Lc} (dB)	ERP (dBm)	ERP (mW)	Limit (W)
26840	829	22.33	-3	17.18	52.24	7
26915	836.5	22.27	-3	17.12	51.52	7
26990	844	22.45	-3	17.3	53.7	7

CHANNEL BANDWIDTH: 10MHz 16QAM

Channel	Frequency (MHz)	Conducted Power (dBm)	G _{T-Lc} (dB)	ERP (dBm)	ERP (mW)	Limit (W)
26840	829	21.75	-3	16.6	45.71	7
26915	836.5	21.8	-3	16.65	46.24	7
26990	844	21.97	-3	16.82	48.08	7

CHANNEL BANDWIDTH: 10MHz 64QAM

Channel	Frequency (MHz)	Conducted Power (dBm)	G _{T-Lc} (dB)	ERP (dBm)	ERP (mW)	Limit (W)
26840	829	20.43	-3	15.28	33.73	7
26915	836.5	20.44	-3	15.29	33.81	7
26990	844	20.6	-3	15.45	35.08	7



CHANNEL BANDWIDTH: 15MHz QPSK

Channel	Frequency (MHz)	Conducted Power (dBm)	G _{T-Lc} (dB)	ERP (dBm)	ERP (mW)	Limit (W)
26865	831.5	22.37	-3	17.22	52.72	7
26915	836.5	22.33	-3	17.18	52.24	7
26965	841.5	22.48	-3	17.33	54.08	7

CHANNEL BANDWIDTH: 15MHz 16QAM

Channel	Frequency (MHz)	Conducted Power (dBm)	G _{T-Lc} (dB)	ERP (dBm)	ERP (mW)	Limit (W)
26865	831.5	21.82	-3	16.67	46.45	7
26915	836.5	21.85	-3	16.7	46.77	7
26965	841.5	21.98	-3	16.83	48.19	7

CHANNEL BANDWIDTH: 15MHz 64QAM

Channel	Frequency (MHz)	Conducted Power (dBm)	G _{T-Lc} (dB)	ERP (dBm)	ERP (mW)	Limit (W)
26865	831.5	20.47	-3	15.32	34.04	7
26915	836.5	20.49	-3	15.34	34.2	7
26965	841.5	20.62	-3	15.47	35.24	7

REMARKS: ERP Output Power (dBm) = EIRP (dBm) -2.15(dB).



3.2 FREQUENCY STABILITY MEASUREMENT

3.2.1 LIMITS OF FREQUENCY STABILITY MEASUREMENT

1.5 ppm is for base and fixed station. 2.5 ppm is for mobile station.

3.2.2 TEST PROCEDURE

- a. Device is placed at the oven room. The oven room could control the temperatures and humidity. Power warm up is at least 15 min and power applied should perform before recording frequency error.
- b. EUT is connected the external power supply to control the DC input power. The test voltage range is from minimum to maximum working voltage. Each step shall be record the frequency error rate.
- c. The temperature range step is 10 degrees in this test items. All temperature levels shall be hold the $\pm 0.5^{\circ}\text{C}$ during the measurement testing. The each temperature step shall be at least 0.5 hours, consider the EUT could be test under the stability condition.

NOTE: The frequency error was recorded frequency error from the communication simulator.

3.2.3 TEST SETUP

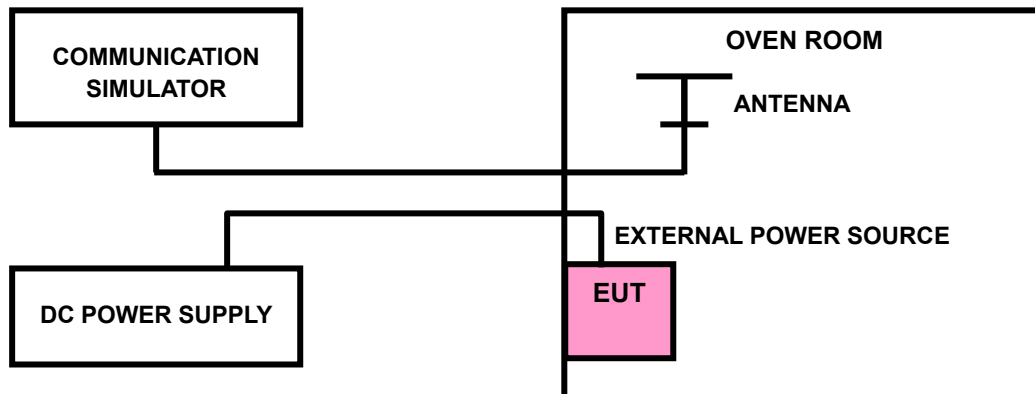



**BUREAU
VERITAS**

Test Report No.: W7L-P23030016RF04

3.2.4 TEST RESULTS

Please Refer to Appendix Of this test report.

Note: VL = Low voltage(3.6V); VN/NV = Normal voltage(3.7V); VH = High voltage(4.2V);
NT = Normal temperature (25°C)



3.3 OCCUPIED BANDWIDTH MEASUREMENT

3.3.1 LIMITS OF OCCUPIED BANDWIDTH MEASUREMENT

The width of a frequency band such that, below the lower and above the upper frequency limits, the mean powers emitted are each equal to a specified percentage 0.5 % of the total mean power of a given emission.

3.3.2 TEST SETUP

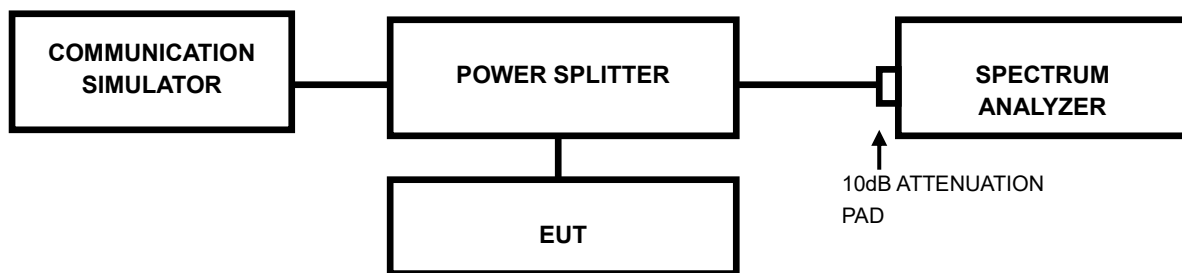

3.3.3 TEST PROCEDURES

- The conducted occupied bandwidth used the power splitter via EUT RF power connector between simulation base station and spectrum analyzer.
- Use OBW measurement function of Spectrum analyzer to measure 99 % occupied bandwidth.



BUREAU
VERITAS

Test Report No.: W7L-P23030016RF04

3.3.4 TEST RESULTS

Please Refer to Appendix Of this test report.

3.4 BAND EDGE MEASUREMENT

3.4.1 LIMITS OF BAND EDGE MEASUREMENT

Power of any emission outside of the authorized operating frequency ranges must be attenuated below the transmitting power (P) by a factor of at least $43 + 10 \log(P)$ dB. In the 1 MHz bands immediately outside and adjacent to the frequency block a resolution bandwidth of at least one percent of the emission bandwidth of the fundamental emission of the transmitter may be employed.

3.4.2 TEST SETUP

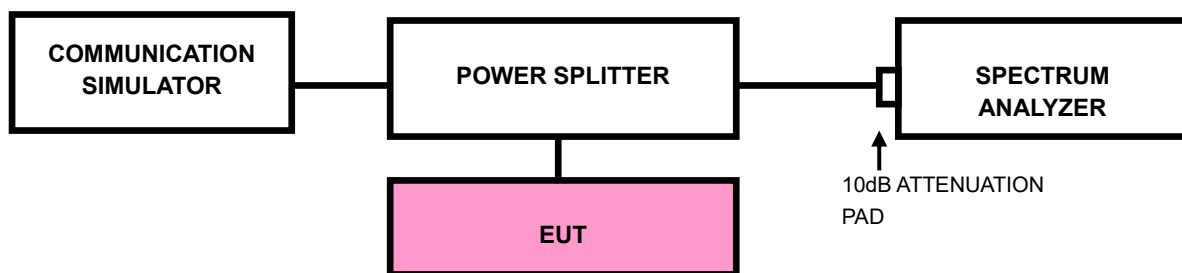



3.4.3 TEST PROCEDURES

- a) All measurements were done at low and high operational frequency range
- b) Connect the transmitter to the spectrum analyzer via coaxial cable while ensuring proper impedance matching.
- c) Tune the analyzer to the nominal center frequency of the emission bandwidth (EBW)
- d) .Set the resolution bandwidth (RBW) $\geq 1\%$ EBW in the 1MHz band immediately outside and adjacent to the band edge.
- e) Beyond the 1MHz band from the band edge, RBW=1MHz was used.
- f) Set the video bandwidth (VBW) to $\geq 3 \times$ RBW.
- g) Select the average power (RMS) display detector.
- h) Set the number of measurement points to ≥ 1001 .
- i) Use auto-coupled sweep time.
- j) Perform the measurement over an interval of time when the transmission is continuous and at its maximum power level.
- k) The RF fundamental frequency should be excluded against the limit line in the operating frequency band and use RBW is 10KHz or 100KHz.
- l) Record the max trace plot into the test report.



BUREAU
VERITAS

Test Report No.: W7L-P23030016RF04

3.4.4 TEST RESULTS

Please Refer to Appendix Of this test report.

3.5 CONDUCTED SPURIOUS EMISSIONS

3.5.1 LIMITS OF CONDUCTED SPURIOUS EMISSIONS MEASUREMENT

The power of any emission outside of the authorized operating frequency ranges must be attenuated below the transmitting power (P) by a factor of at least $43 + 10 \log(P)$ dB. The emission limit equal to -13dBm .

3.5.2 TEST PROCEDURE

- a. The EUT makes a phone call to the communication simulator. All measurements were done at low, middle and high operational frequency range.
- b. Measuring frequency range is from 9kHz up to a frequency including its 10th harmonic. 10dB attenuation pad is connected with spectrum. RBW=1MHz and VBW=3MHz is used for conducted emission measurement.

3.5.3 TEST SETUP

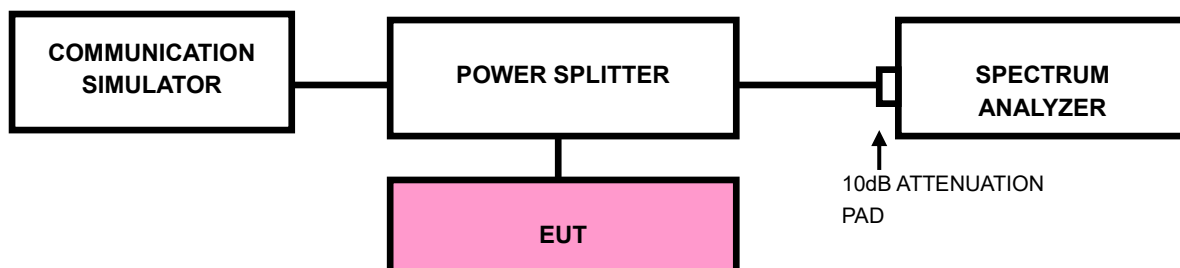



**BUREAU
VERITAS**

Test Report No.: W7L-P23030016RF04

3.5.4 TEST RESULTS

NOTE : The 9K~30MHz amplitude of spurious emissions attenuated more than 20 dB below the permissible value is not required in the report.

Please Refer to Appendix Of this test report.



3.6 RADIATED EMISSION MEASUREMENT

3.6.1 LIMITS OF RADIATED EMISSION MEASUREMENT

The power of any emission outside of the authorized operating frequency ranges must be attenuated below the transmitting power (P) by a factor of at least $43 + 10 \log(P)$ dB. The emission limit equal to -13dBm .

3.6.2 TEST PROCEDURES

- a. Substitution method is used for E.I.R.P measurement. In the semi-anechoic chamber, EUT placed on the 0.8m height of Turn Table, rotated the table around 360 degrees to search the maximum radiation power and receiver antenna shall be rotated vertical and horizontal polarization and moved height from 1m to 4m to find the maximum polar radiated power. The "Read Value" is the spectrum reading the maximum power value.
- b. The substitution horn antenna is substituted for EUT at the same position and signals generator export the CW signal to the substitution antenna via a TX cable. Rotated the Turn Table and moved receiving antenna to find the maximum radiation power. Adjust output power level of S.G to get a Value of spectrum reading equal to "Read Value " of step a. Record the power level of S.G
- c. $\text{EIRP} = \text{Output power level of S.G} - \text{TX cable loss} + \text{Antenna gain of substitution horn.}$
- d. E.R.P power can be calculated form E.I.R.P power by subtracting the gain of dipole,
 $\text{E.R.P power} = \text{E.I.P.R power} - 2.15\text{dBi.}$

NOTE: The resolution bandwidth and video bandwidth of test receiver/spectrum analyzer is 1MHz/3MHz.

3.6.3 DEVIATION FROM TEST STANDARD

No deviation



3.6.4 TEST SETUP

< Frequency Range below 30MHz >

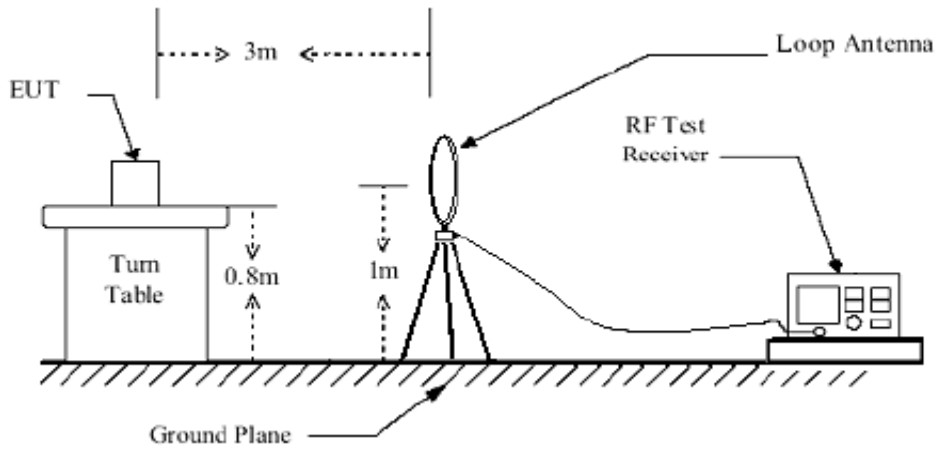

< Frequency Range 30MHz~1GHz >

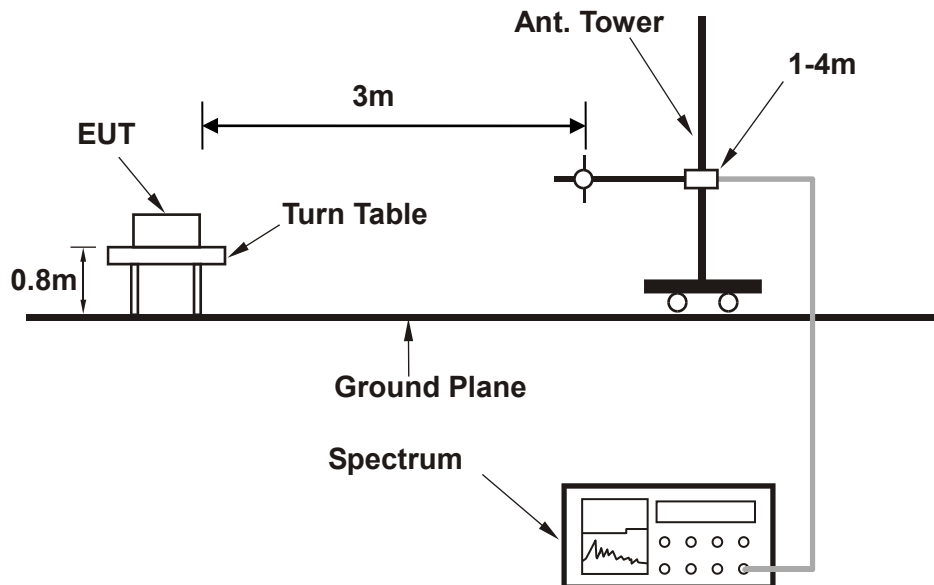



<Frequency Range above 1GHz>

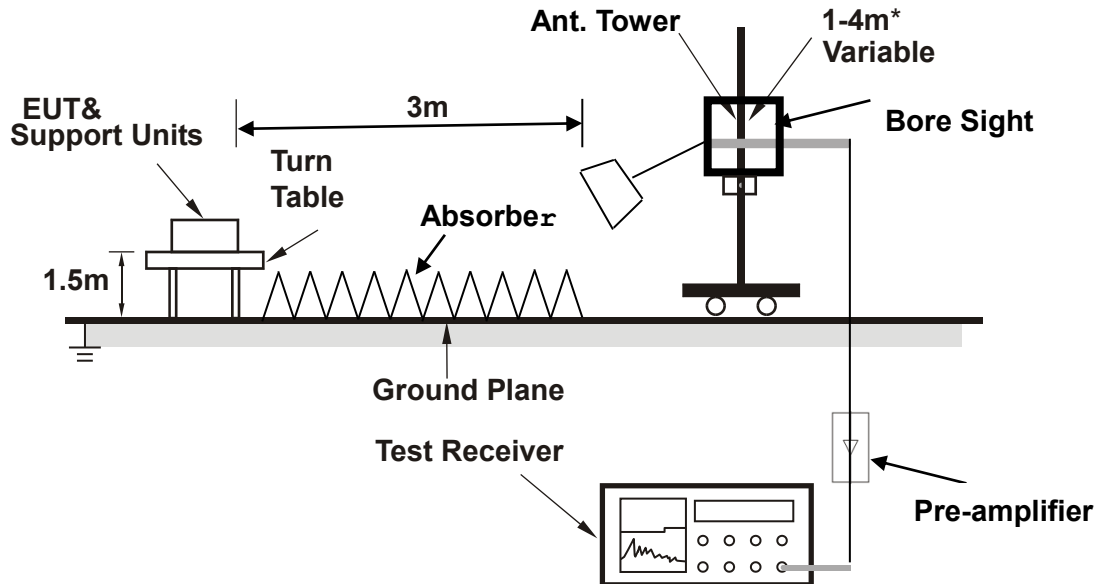

Note: Above 1G is a directional antenna

Depends on the EUT height and the antenna 3dB beamwidth both, refer to section 7.3 of CISPR 16-2-3.

For the actual test configuration, please refer to the attached file (Test Setup Photo).



3.6.5 TEST RESULTS

NOTE : The 9K~30MHz amplitude of spurious emissions attenuated more than 20 dB below the permissible value is not required in the report.

BELOW 1GHz WORST-CASE DATA

30 MHz – 1GHz data:

EDGE 850:

CHANNEL BANDWIDTH: 128 ~ 251

MODE	TX channel 189	FREQUENCY RANGE	Below 1000MHz
ENVIRONMENTAL CONDITIONS	23deg. C, 70%RH	INPUT POWER	AC 120V/60HZ
TESTED BY	Jace Hu		
ANTENNA POLARITY & TEST DISTANCE: HORIZONTAL AT 3 M			

	Freq	Level	Read Level	Limit Line	Over Limit	Factor	Remark	Pol/Phase
	MHz	dBm/m	dBm	dBm/m	dB	dB/m		
1	31.940	-68.45	-58.85	-13.00	-55.45	-9.60	Peak	Horizontal
2	72.680	-64.79	-43.54	-13.00	-51.79	-21.25	Peak	Horizontal
3	218.180	-69.25	-54.00	-13.00	-56.25	-15.25	Peak	Horizontal
4 PP	252.130	-64.42	-52.92	-13.00	-51.42	-11.50	Peak	Horizontal
5	328.760	-69.02	-57.26	-13.00	-56.02	-11.76	Peak	Horizontal
6	422.850	-69.97	-60.35	-13.00	-56.97	-9.62	Peak	Horizontal

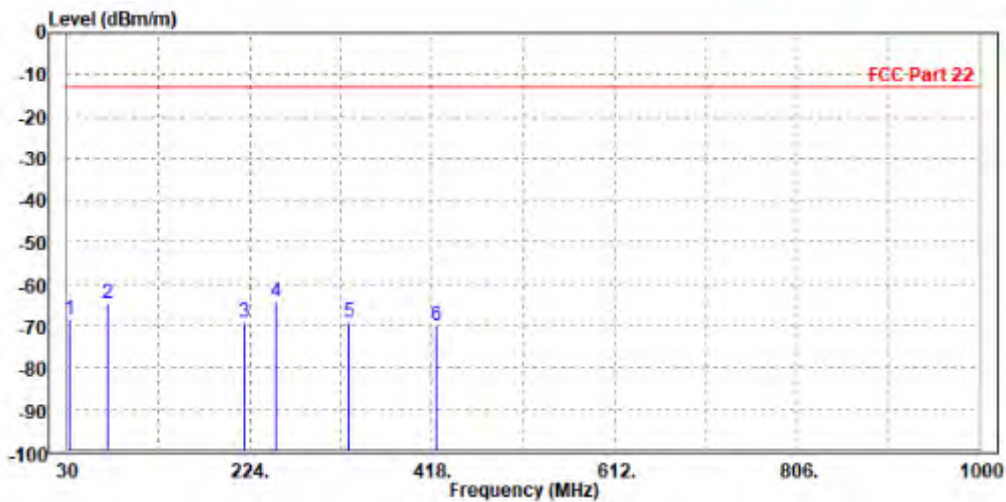



**BUREAU
VERITAS**

Test Report No.: W7L-P23030016RF04

MODE	TX channel 189	FREQUENCY RANGE	Below 1000MHz
ENVIRONMENTAL CONDITIONS	23deg. C, 70%RH	INPUT POWER	AC 120V/60HZ
TESTED BY	Jace Hu		
ANTENNA POLARITY & TEST DISTANCE: VERTICAL AT 3 M			

	Freq	Level	Read Level	Limit Line	Over Limit	Factor	Remark	Pol/Phase
	MHz	dBm/m	dBm	dBm/m	dB	dB/m		
1	34.850	-67.74	-47.17	-13.00	-54.74	-20.57	Peak	Vertical
2	74.620	-62.44	-41.39	-13.00	-49.44	-21.05	Peak	Vertical
3 PP	99.840	-55.72	-49.21	-13.00	-42.72	-6.51	Peak	Vertical
4	248.250	-67.83	-54.08	-13.00	-54.83	-13.75	Peak	Vertical
5	346.220	-67.77	-57.79	-13.00	-54.77	-9.98	Peak	Vertical
6	455.830	-69.68	-61.19	-13.00	-56.68	-8.49	Peak	Vertical

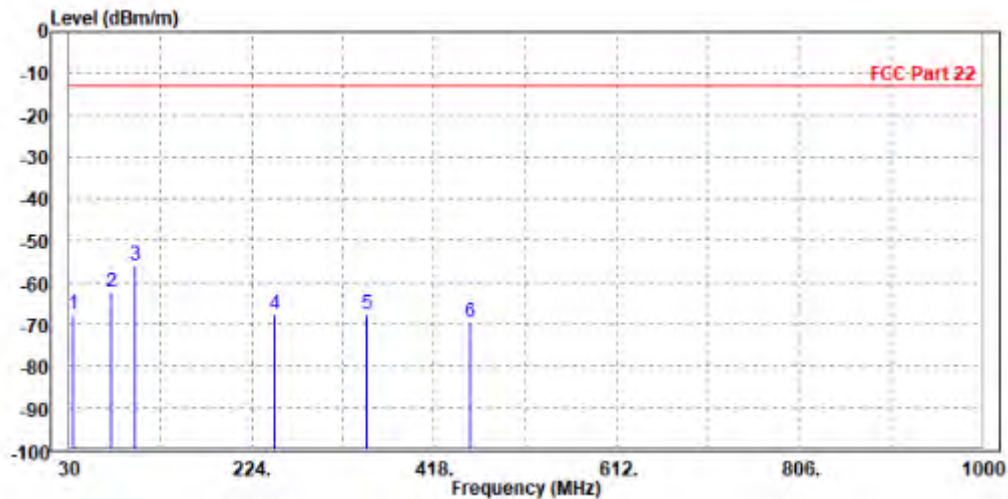



ABOVE 1GHz DATA

Note: For higher frequency, the emission is too low to be detected.

GSM 850

CH 128:

MODE	TX channel 128	FREQUENCY RANGE	Above 1000MHz
ENVIRONMENTAL CONDITIONS	23deg. C, 70%RH	INPUT POWER	AC 120V/60HZ
TESTED BY	Jace Hu		
ANTENNA POLARITY & TEST DISTANCE: HORIZONTAL AT 3 M			

	Freq	Level	Read Level	Limit Line	Over Limit	Factor	Remark	Pol/Phase
	MHz	dBm/m	dBm	dBm/m	dB	dB/m		
1	PP 1648.400	-43.02	-43.80	-13.00	-30.02	0.78	Peak	Horizontal
2	2476.000	-50.29	-55.64	-13.00	-37.29	5.35	Peak	Horizontal

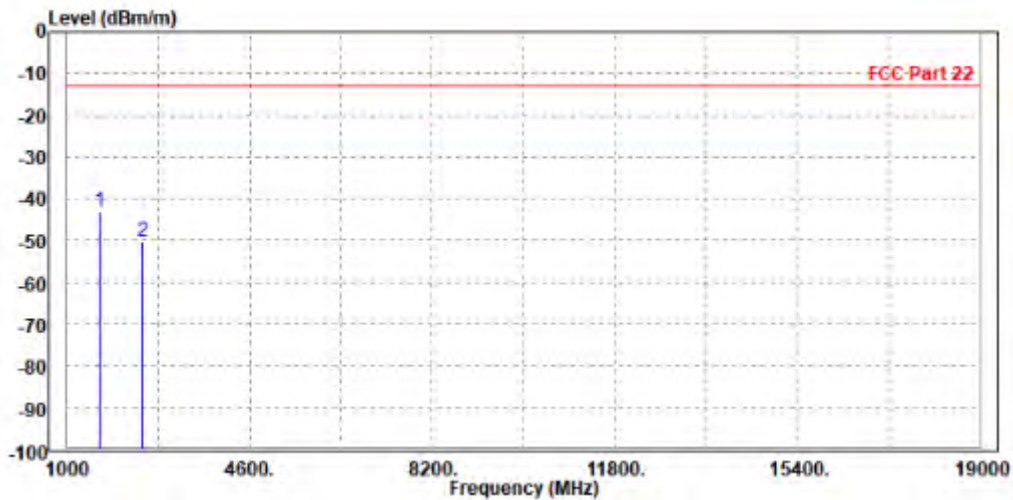



**BUREAU
VERITAS**

Test Report No.: W7L-P23030016RF04

MODE	TX channel 128	FREQUENCY RANGE	Above 1000MHz
ENVIRONMENTAL CONDITIONS	23deg. C, 70%RH	INPUT POWER	AC 120V/60HZ
TESTED BY	Jace Hu		
ANTENNA POLARITY & TEST DISTANCE: VERTICAL AT 3 M			

	Freq	Level	Read Level	Limit Line	Over Limit	Factor	Remark	Pol/Phase
	MHz	dBm/m	dBm	dBm/m	dB	dB/m		
1	PP 1648.000	-44.73	-45.77	-13.00	-31.73	1.04	Peak	Vertical
2	2472.600	-48.32	-53.18	-13.00	-35.32	4.86	Peak	Vertical

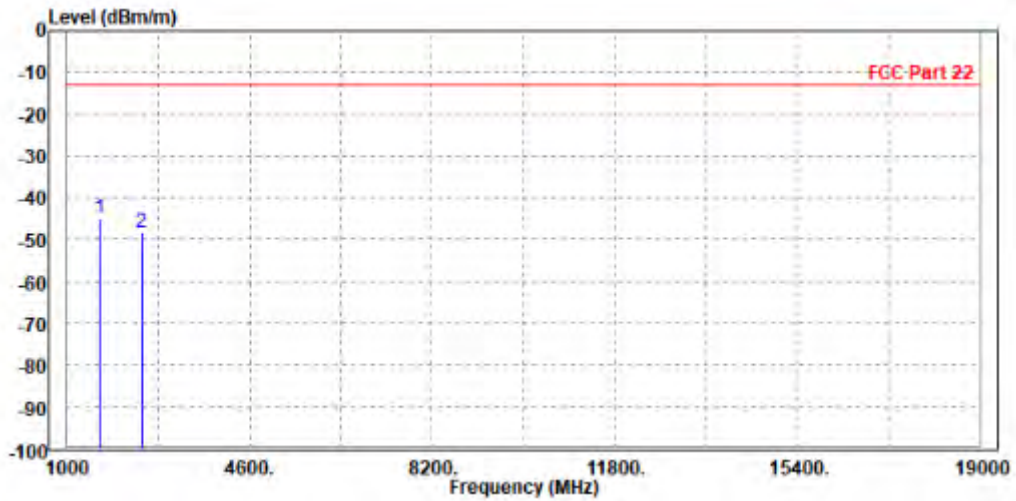



**BUREAU
VERITAS**

Test Report No.: W7L-P23030016RF04

CH 189:

MODE	TX channel 189	FREQUENCY RANGE	Above 1000MHz
ENVIRONMENTAL CONDITIONS	23deg. C, 70%RH	INPUT POWER	AC 120V/60HZ
TESTED BY	Jace Hu		
ANTENNA POLARITY & TEST DISTANCE: HORIZONTAL AT 3 M			

	Freq	Level	Read Level	Limit Line	Over Limit	Factor	Remark	Pol/Phase
	MHz	dBm/m	dBm	dBm/m	dB	dB/m		
1	PP 1666.000	-42.10	-43.02	-13.00	-29.10	0.92	Peak	Horizontal
2	2509.200	-47.96	-53.42	-13.00	-34.96	5.46	Peak	Horizontal

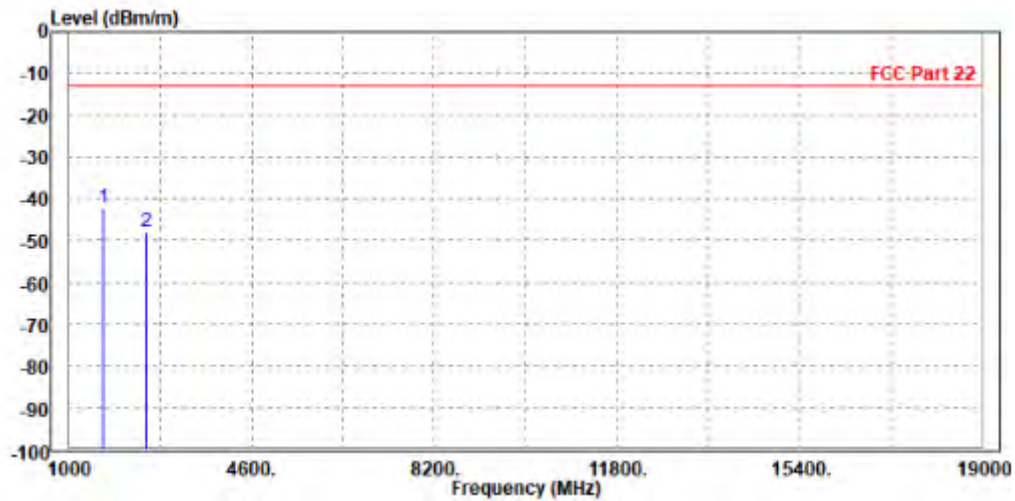



BUREAU VERITAS

Test Report No.: W7L-P23030016RF04

MODE	TX channel 189	FREQUENCY RANGE	Above 1000MHz
ENVIRONMENTAL CONDITIONS	23deg. C, 70%RH	INPUT POWER	AC 120V/60HZ
TESTED BY	Jace Hu		
ANTENNA POLARITY & TEST DISTANCE: VERTICAL AT 3 M			

	Freq	Level	Read Level	Limit Line	Over Limit	Factor	Remark	Pol/Phase
	MHz	dBm/m	dBm	dBm/m	dB	dB/m		
1	PP 1672.800	-35.31	-36.53	-13.00	-22.31	1.22	Peak	Vertical
2	2512.000	-48.41	-53.39	-13.00	-35.41	4.98	Peak	Vertical

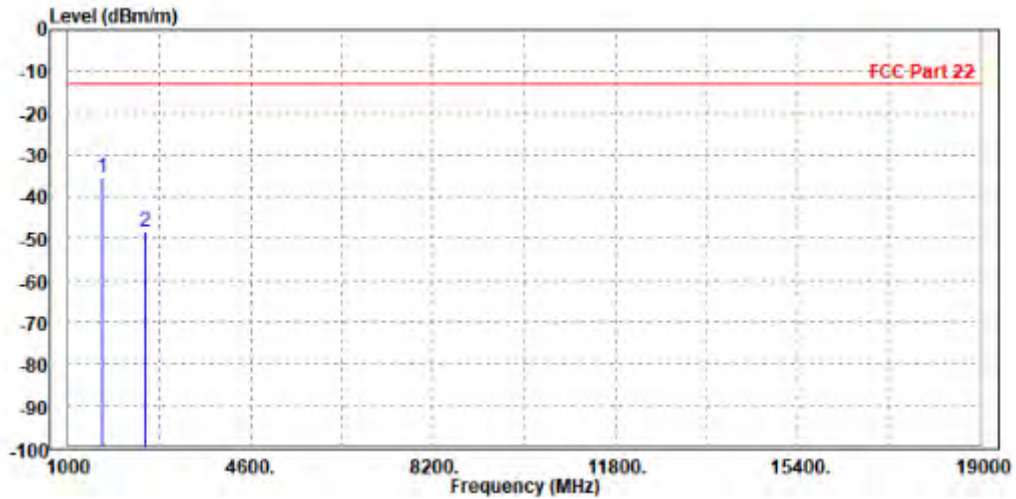



BUREAU VERITAS

Test Report No.: W7L-P23030016RF04

CH 251:

MODE	TX channel 251	FREQUENCY RANGE	Above 1000MHz
ENVIRONMENTAL CONDITIONS	23deg. C, 70%RH	INPUT POWER	AC 120V/60HZ
TESTED BY	Jace Hu		
ANTENNA POLARITY & TEST DISTANCE: HORIZONTAL AT 3 M			

	Freq	Level	Read Level	Limit Line	Over Limit	Factor	Remark	Pol/Phase
	MHz	dBm/m	dBm	dBm/m	dB	dB/m		
1	PP 1702.000	-38.63	-39.84	-13.00	-25.63	1.21	Peak	Horizontal
2	2546.400	-47.06	-52.61	-13.00	-34.06	5.55	Peak	Horizontal

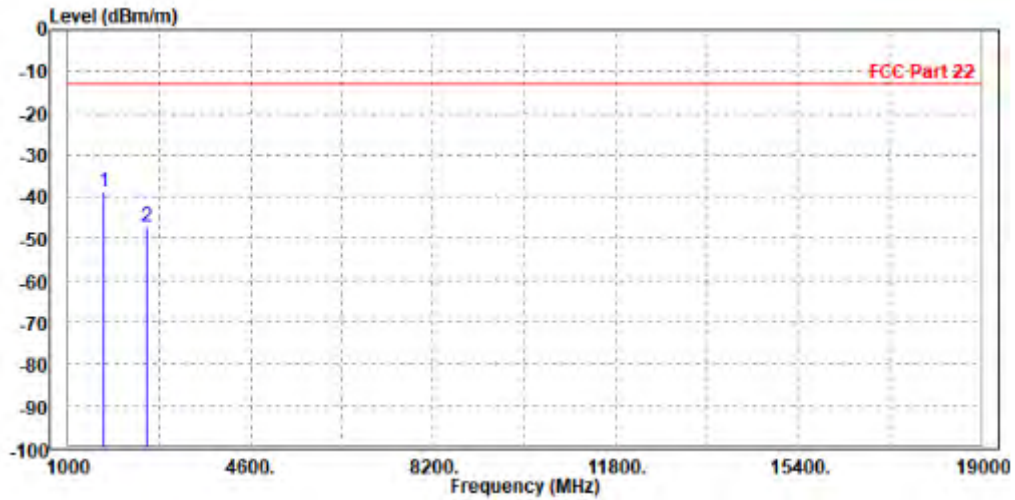



**BUREAU
VERITAS**

Test Report No.: W7L-P23030016RF04

MODE	TX channel 251	FREQUENCY RANGE	Above 1000MHz
ENVIRONMENTAL CONDITIONS	23deg. C, 70%RH	INPUT POWER	AC 120V/60HZ
TESTED BY	Jace Hu		
ANTENNA POLARITY & TEST DISTANCE: VERTICAL AT 3 M			

	Freq	Level	Read Level	Limit Line	Over Limit	Factor	Remark	Pol/Phase
	MHz	dBm/m	dBm	dBm/m	dB	dB/m		
1	PP 1697.600	-36.18	-37.58	-13.00	-23.18	1.40	Peak	Vertical
2	2548.000	-45.91	-51.00	-13.00	-32.91	5.09	Peak	Vertical

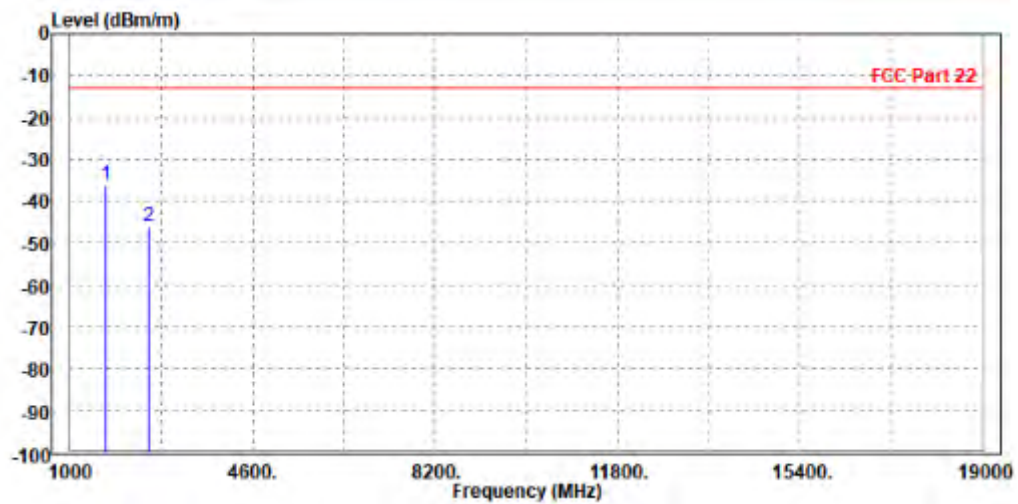



**BUREAU
VERITAS**

Test Report No.: W7L-P23030016RF04

EDGE 850:

CH 128:

MODE	TX channel 128	FREQUENCY RANGE	Above 1000MHz
ENVIRONMENTAL CONDITIONS	23deg. C, 70%RH	INPUT POWER	AC 120V/60HZ
TESTED BY	Jace Hu		
ANTENNA POLARITY & TEST DISTANCE: HORIZONTAL AT 3 M			

	Freq	Level	Read Level	Limit Line	Over Limit	Factor	Remark	Pol/Phase
	MHz	dBm/m	dBm	dBm/m	dB	dB/m		
1 PP	1648.000	-41.57	-42.34	-13.00	-28.57	0.77	Peak	Horizontal
2	2509.200	-52.98	-58.44	-13.00	-39.98	5.46	Peak	Horizontal

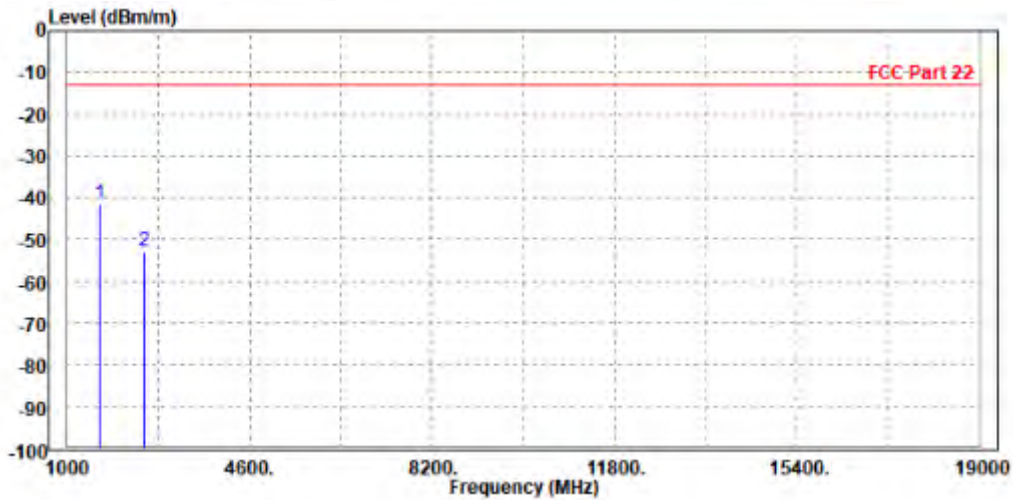



**BUREAU
VERITAS**

Test Report No.: W7L-P23030016RF04

MODE	TX channel 128	FREQUENCY RANGE	Above 1000MHz
ENVIRONMENTAL CONDITIONS	23deg. C, 70%RH	INPUT POWER	AC 120V/60HZ
TESTED BY	Jace Hu		
ANTENNA POLARITY & TEST DISTANCE: VERTICAL AT 3 M			

		Read	Limit	Over				
	Freq	Level	Level	Line	Limit	Factor	Remark	Pol/Phase
	MHz	dBm/m	dBm	dBm/m	dB	dB/m		
1	PP 1648.400	-40.17	-41.21	-13.00	-27.17	1.04	Peak	Vertical
2	2476.000	-52.25	-57.12	-13.00	-39.25	4.87	Peak	Vertical

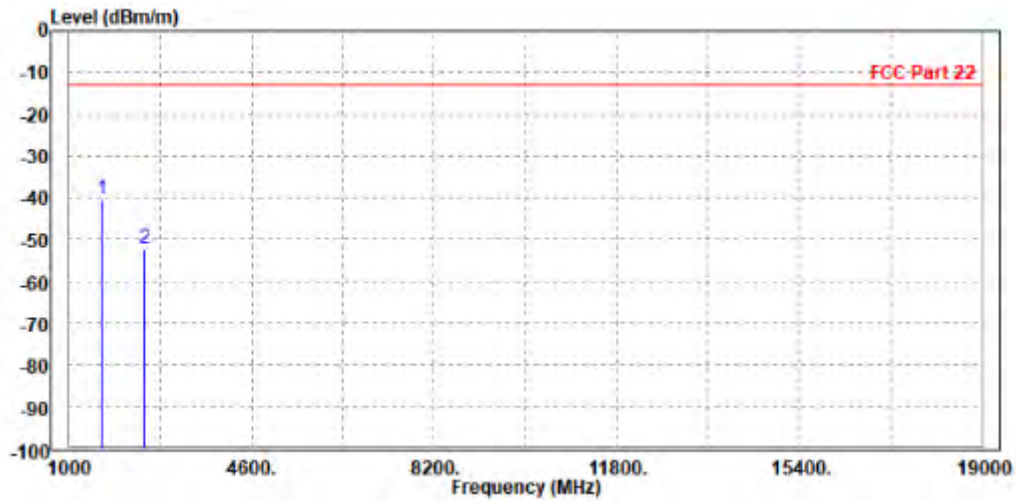



**BUREAU
VERITAS**

Test Report No.: W7L-P23030016RF04

CH 189:

MODE	TX channel 189	FREQUENCY RANGE	Above 1000MHz
ENVIRONMENTAL CONDITIONS	23deg. C, 70%RH	INPUT POWER	AC 120V/60HZ
TESTED BY	Jace Hu		
ANTENNA POLARITY & TEST DISTANCE: HORIZONTAL AT 3 M			

	Freq	Level	Read Level	Limit Line	Over Limit	Factor	Remark	Pol/Phase
	MHz	dBm/m	dBm	dBm/m	dB	dB/m		
1	PP 1672.800	-38.59	-39.56	-13.00	-25.59	0.97	Peak	Horizontal
2	2512.000	-48.15	-53.62	-13.00	-35.15	5.47	Peak	Horizontal

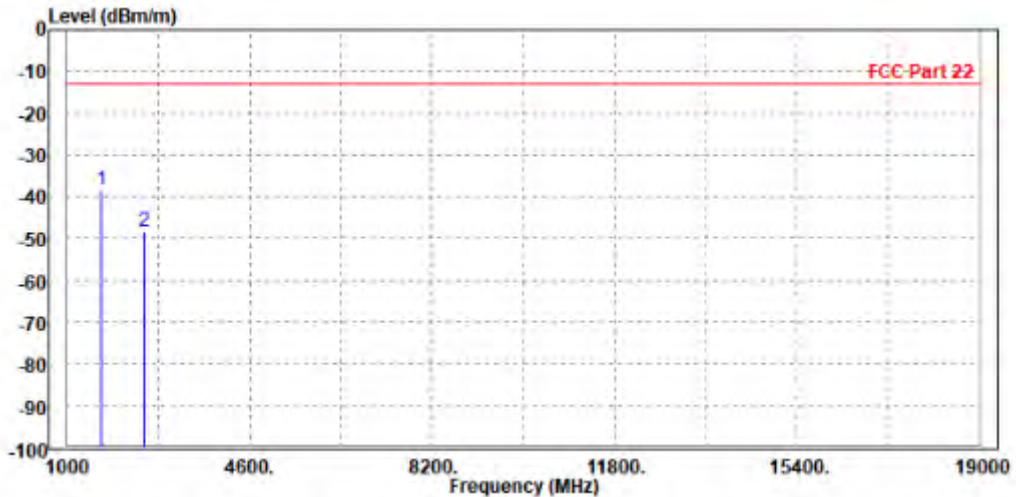



**BUREAU
VERITAS**

Test Report No.: W7L-P23030016RF04

MODE	TX channel 189	FREQUENCY RANGE	Above 1000MHz
ENVIRONMENTAL CONDITIONS	23deg. C, 70%RH	INPUT POWER	AC 120V/60HZ
TESTED BY	Jace Hu		
ANTENNA POLARITY & TEST DISTANCE: VERTICAL AT 3 M			

	Freq	Level	Read Level	Limit Line	Over Limit	Factor	Remark	Pol/Phase
	MHz	dBm/m	dBm	dBm/m	dB	dB/m		
1	PP 1666.000	-33.70	-34.87	-13.00	-20.70	1.17	Peak	Vertical
2	2509.200	-46.15	-51.12	-13.00	-33.15	4.97	Peak	Vertical

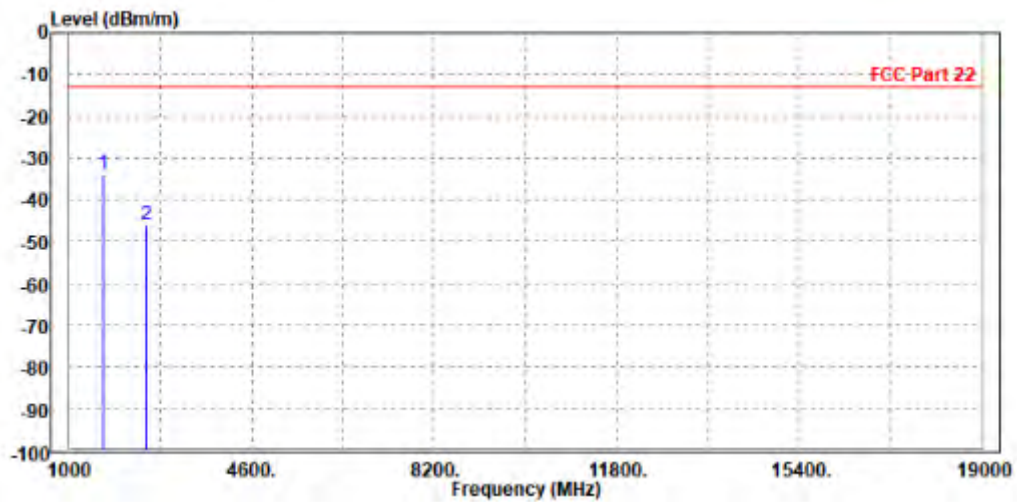



**BUREAU
VERITAS**

Test Report No.: W7L-P23030016RF04

CH 251:

MODE	TX channel 251	FREQUENCY RANGE	Above 1000MHz
ENVIRONMENTAL CONDITIONS	23deg. C, 70%RH	INPUT POWER	AC 120V/60HZ
TESTED BY	Jace Hu		
ANTENNA POLARITY & TEST DISTANCE: HORIZONTAL AT 3 M			

	Freq	Level	Read Level	Limit Line	Over Limit	Factor	Remark	Pol/Phase
	MHz	dBm/m	dBm	dBm/m	dB	dB/m		
1 PP	1702.000	-37.01	-38.22	-13.00	-24.01	1.21	Peak	Horizontal
2	2548.000	-44.61	-50.16	-13.00	-31.61	5.55	Peak	Horizontal

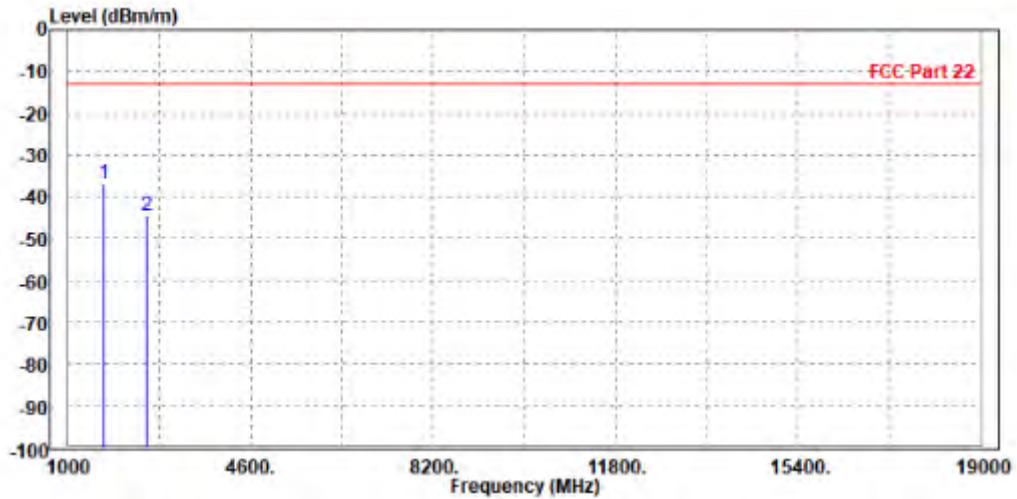



**BUREAU
VERITAS**

Test Report No.: W7L-P23030016RF04

MODE	TX channel 251	FREQUENCY RANGE	Above 1000MHz
ENVIRONMENTAL CONDITIONS	23deg. C, 70%RH	INPUT POWER	AC 120V/60HZ
TESTED BY	Jace Hu		
ANTENNA POLARITY & TEST DISTANCE: VERTICAL AT 3 M			

	Freq	Level	Read Level	Limit Line	Over Limit	Factor	Remark	Pol/Phase
	MHz	dBm/m	dBm	dBm/m	dB	dB/m		
1	PP 1702.000	-36.16	-37.59	-13.00	-23.16	1.43	Peak	Vertical
2	2546.400	-44.90	-49.99	-13.00	-31.90	5.09	Peak	Vertical

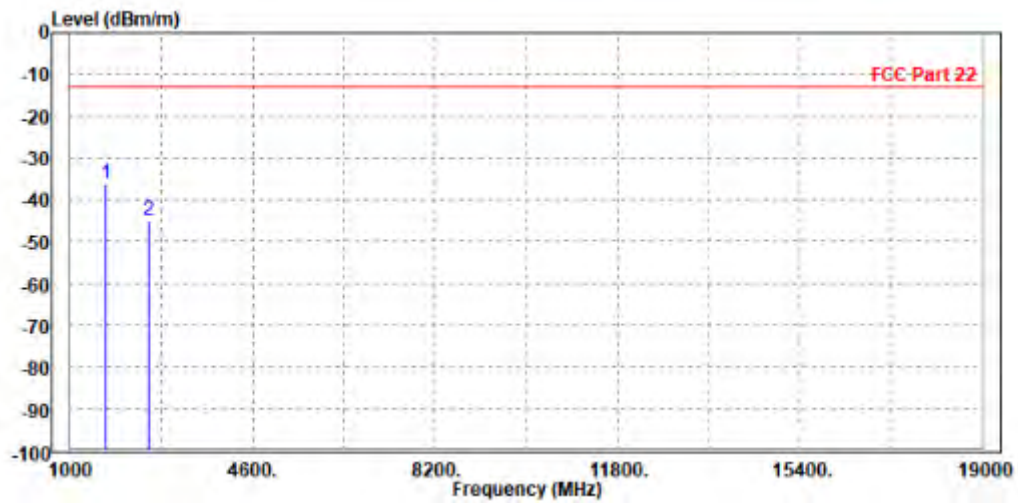



WCDMA Band V:

CH 4132:

MODE	TX channel 4132	FREQUENCY RANGE	Above 1000MHz
ENVIRONMENTAL CONDITIONS	23deg. C, 70%RH	INPUT POWER	AC 120V/60HZ
TESTED BY	Jace Hu		
ANTENNA POLARITY & TEST DISTANCE: HORIZONTAL AT 3 M			

	Freq	Level	Read Level	Limit Line	Over Limit	Factor	Remark	Pol/Phase
	MHz	dBm/m	dBm	dBm/m	dB	dB/m		
1	1652.800	-53.60	-54.41	-13.00	-40.60	0.81	Peak	Horizontal
2 PP	2476.000	-53.20	-58.55	-13.00	-40.20	5.35	Peak	Horizontal

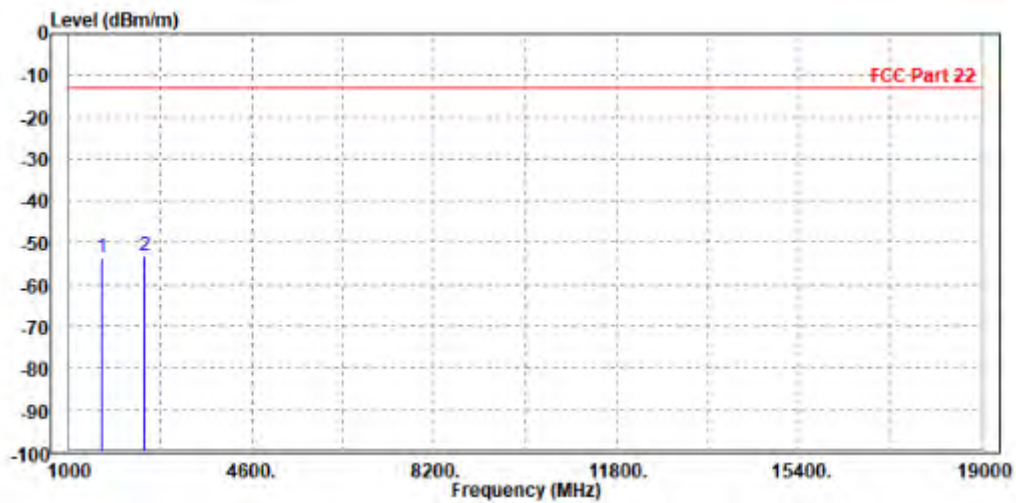



**BUREAU
VERITAS**

Test Report No.: W7L-P23030016RF04

MODE	TX channel 4132	FREQUENCY RANGE	Above 1000MHz
ENVIRONMENTAL CONDITIONS	23deg. C, 70%RH	INPUT POWER	AC 120V/60HZ
TESTED BY	Jace Hu		
ANTENNA POLARITY & TEST DISTANCE: VERTICAL AT 3 M			

	Freq	Level	Read Level	Limit Line	Over Limit	Factor	Remark	Pol/Phase
	MHz	dBm/m	dBm	dBm/m	dB	dB/m		
1	1648.000	-53.15	-54.19	-13.00	-40.15	1.04	Peak	Vertical
2 PP	2479.200	-52.93	-57.81	-13.00	-39.93	4.88	Peak	Vertical

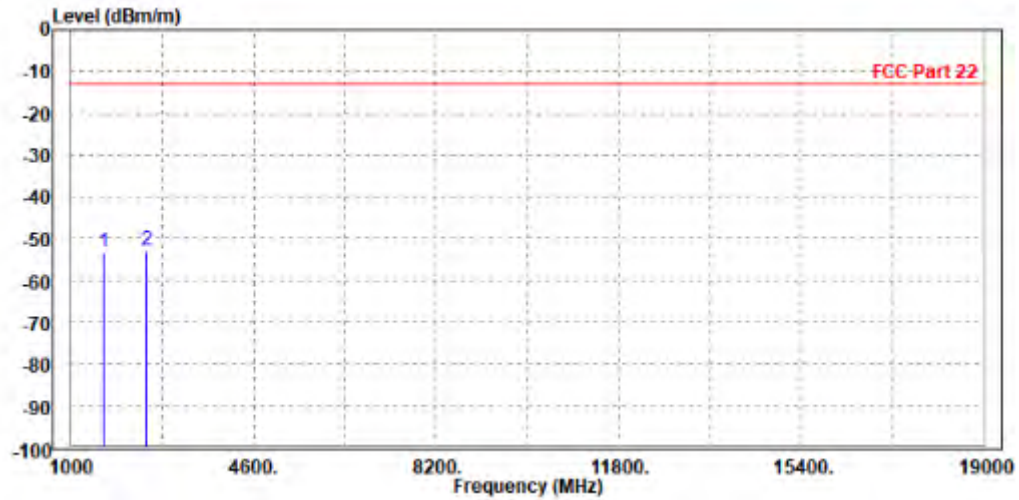



CH 4182:

MODE	TX channel 4182	FREQUENCY RANGE	Above 1000MHz
ENVIRONMENTAL CONDITIONS	23deg. C, 70%RH	INPUT POWER	AC 120V/60HZ
TESTED BY	Jace Hu		
ANTENNA POLARITY & TEST DISTANCE: HORIZONTAL AT 3 M			

	Freq	Level	Read Level	Limit Line	Over Limit	Factor	Remark	Pol/Phase
	MHz	dBm/m	dBm	dBm/m	dB	dB/m		
1	PP 1666.000	-52.70	-53.62	-13.00	-39.70	0.92	Peak	Horizontal
2	2509.200	-53.50	-58.96	-13.00	-40.50	5.46	Peak	Horizontal

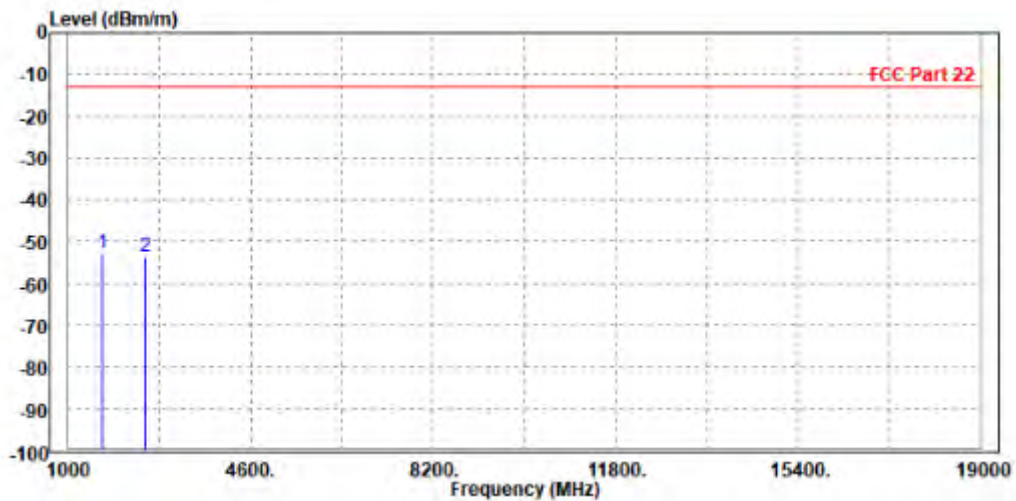



MODE	TX channel 4182	FREQUENCY RANGE	Above 1000MHz
ENVIRONMENTAL CONDITIONS	23deg. C, 70%RH	INPUT POWER	AC 120V/60HZ
TESTED BY	Jace Hu		
ANTENNA POLARITY & TEST DISTANCE: VERTICAL AT 3 M			

	Freq	Level	Read Level	Limit Line	Over Limit	Factor	Remark	Pol/Phase
	MHz	dBm/m	dBm	dBm/m	dB	dB/m		
1	PP 1672.800	-51.86	-53.08	-13.00	-38.86	1.22	Peak	Vertical
2	2512.000	-53.07	-58.05	-13.00	-40.07	4.98	Peak	Vertical

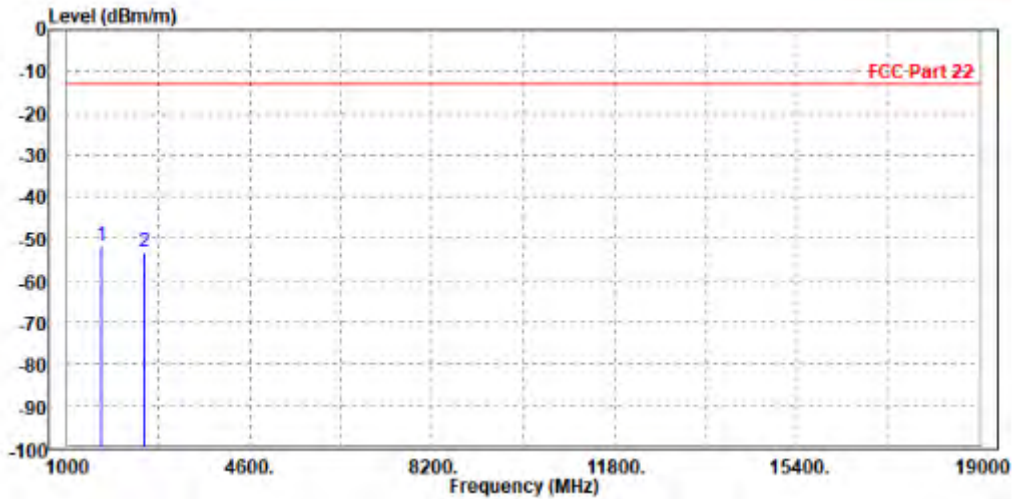



CH 4233:

MODE	TX channel 4233	FREQUENCY RANGE	Above 1000MHz
ENVIRONMENTAL CONDITIONS	23deg. C, 70%RH	INPUT POWER	AC 120V/60HZ
TESTED BY	Jace Hu		
ANTENNA POLARITY & TEST DISTANCE: HORIZONTAL AT 3 M			

	Freq	Level	Read Level	Limit Line	Over Limit	Factor	Remark	Pol/Phase
	MHz	dBm/m	dBm	dBm/m	dB	dB/m		
1	1702.000	-55.19	-56.40	-13.00	-42.19	1.21	Peak	Horizontal
2 PP	2539.800	-51.58	-57.11	-13.00	-38.58	5.53	Peak	Horizontal

