

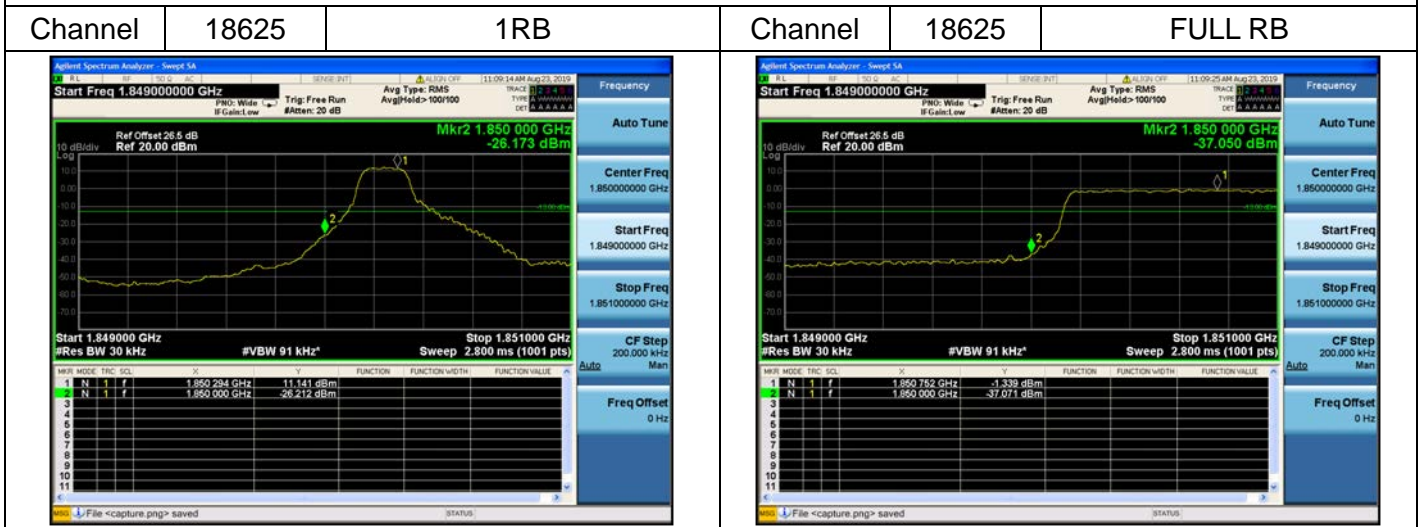

LTE Band 2

Channel Bandwidth: 5MHz



Channel Bandwidth: 5MHz

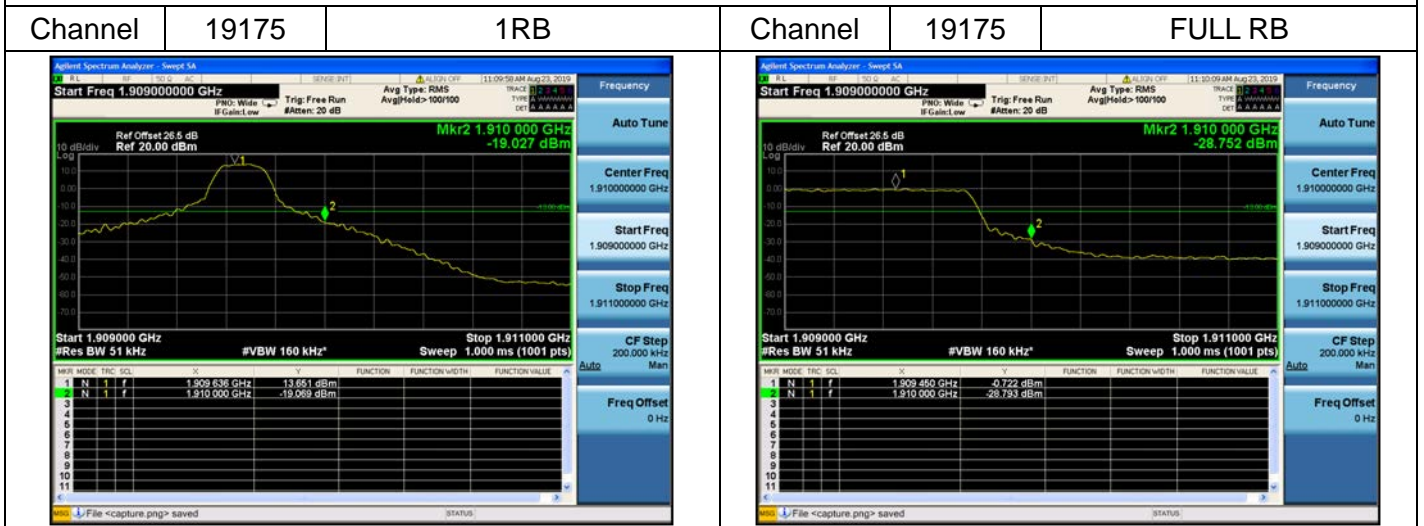



LTE Band 2

Channel Bandwidth: 10MHz

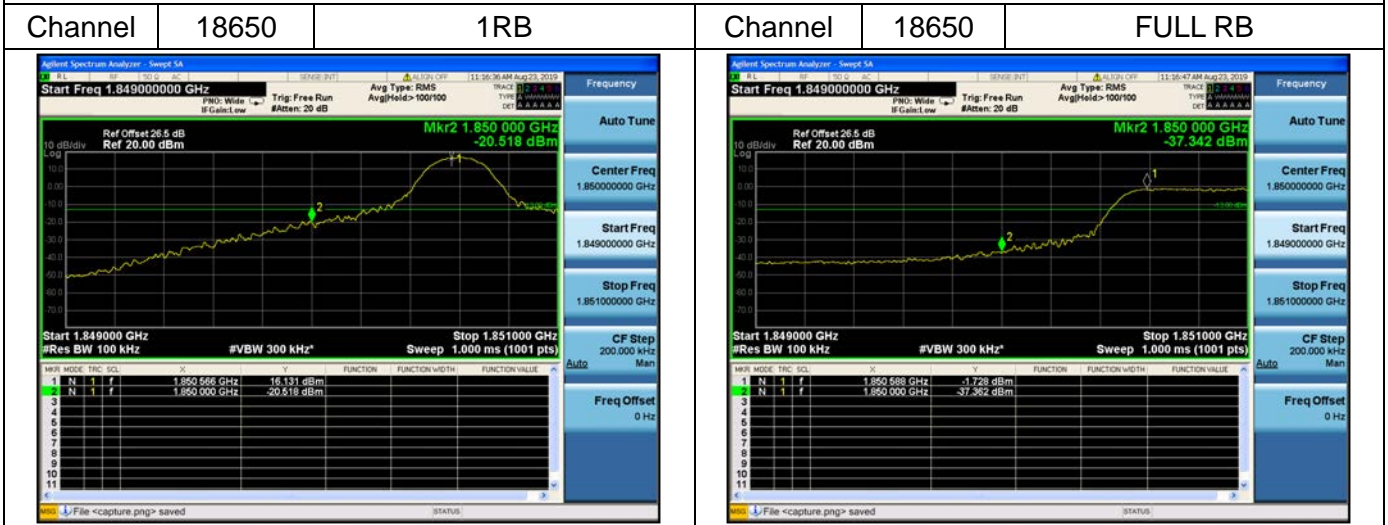

Channel Bandwidth: 10MHz

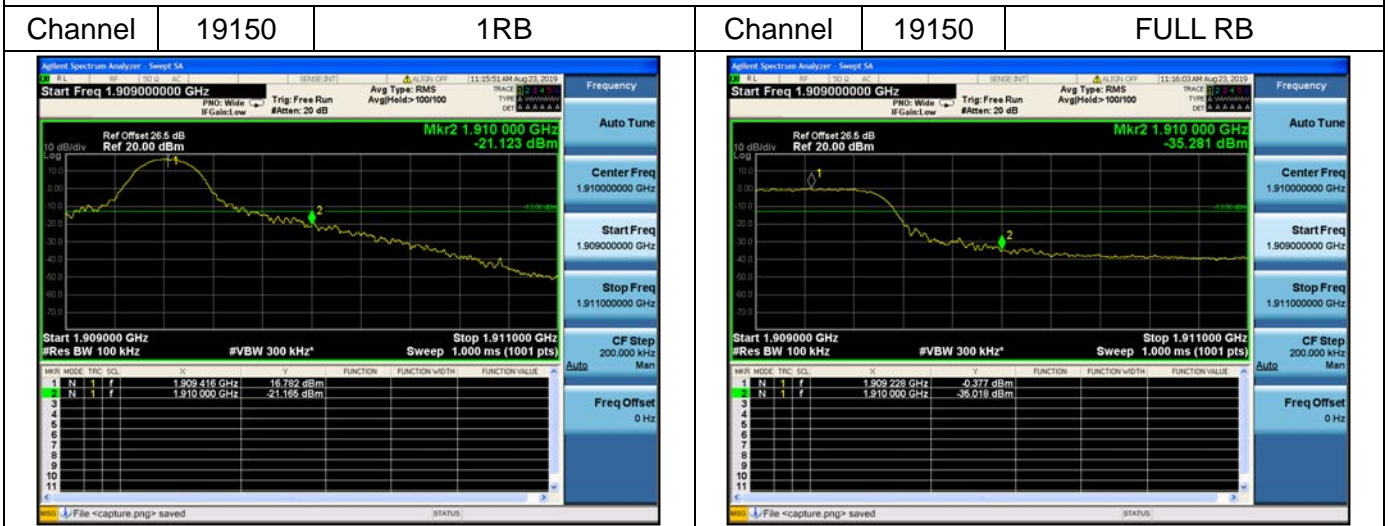



LTE Band 2

Channel Bandwidth: 15MHz

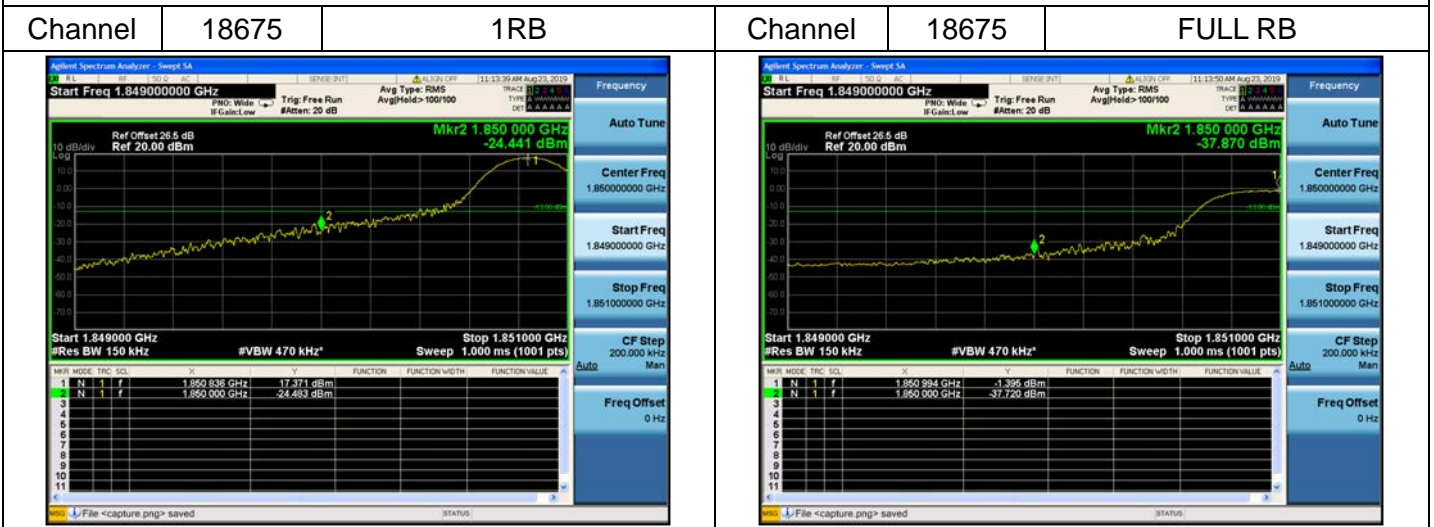

Channel Bandwidth: 15MHz

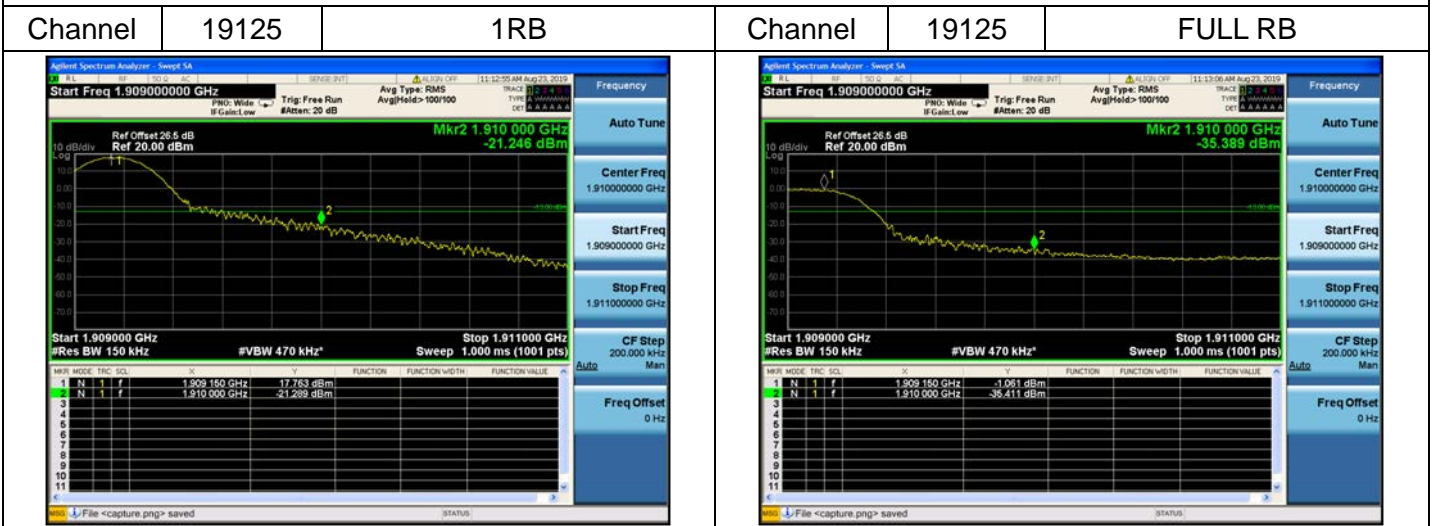



LTE Band 2

Channel Bandwidth: 20MHz

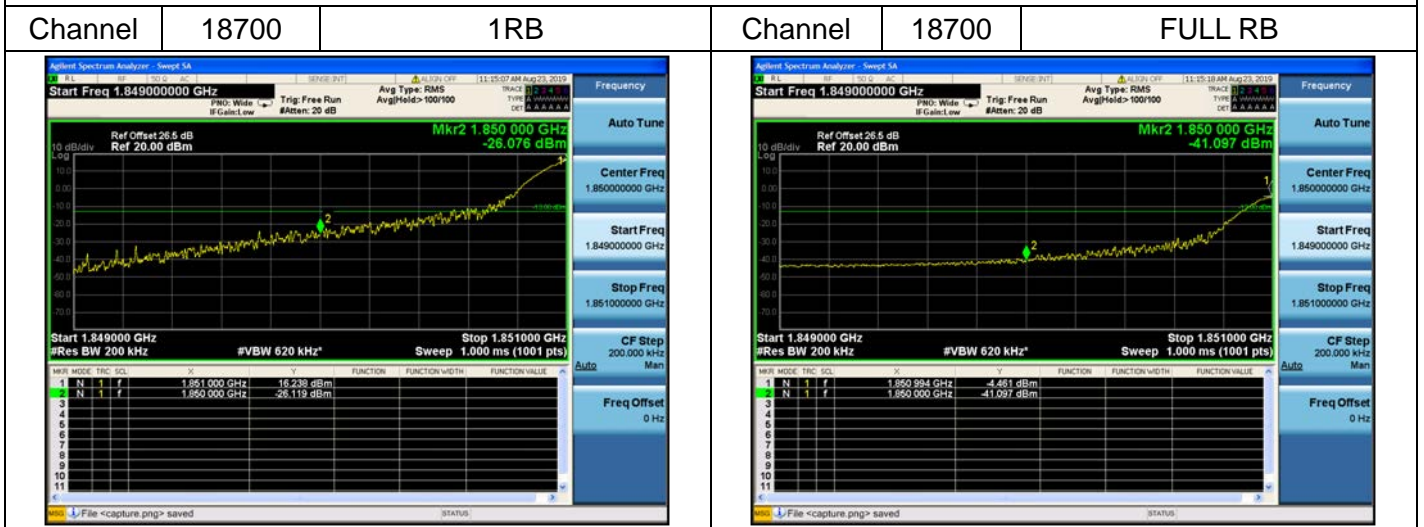

Channel Bandwidth: 20MHz

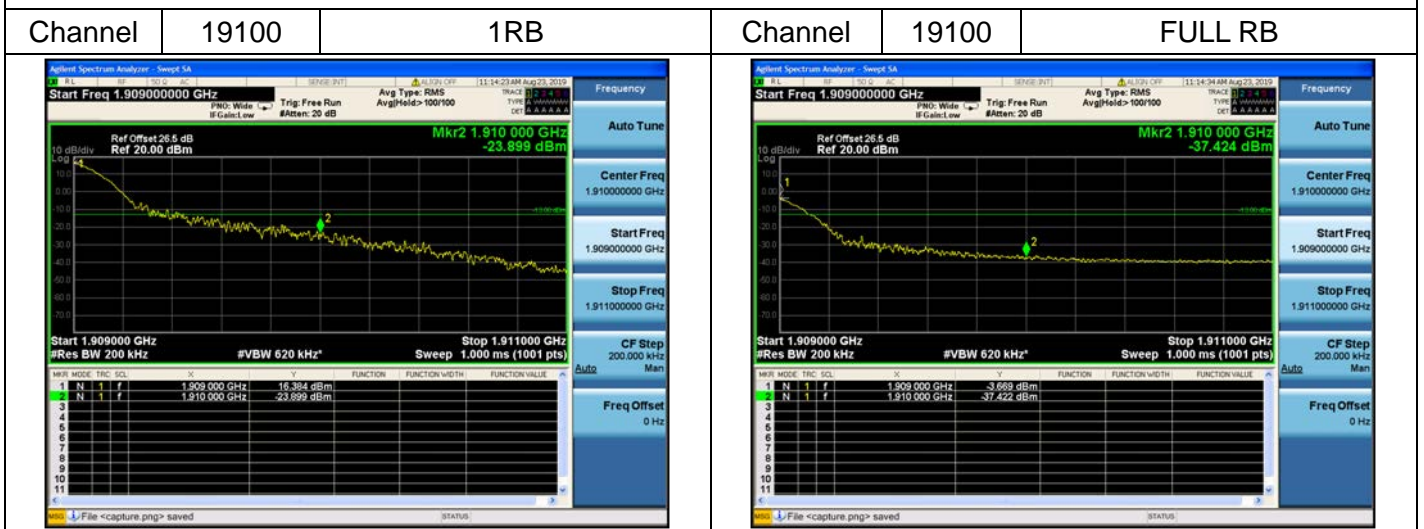



LTE Band 4

Channel Bandwidth: 1.4MHz

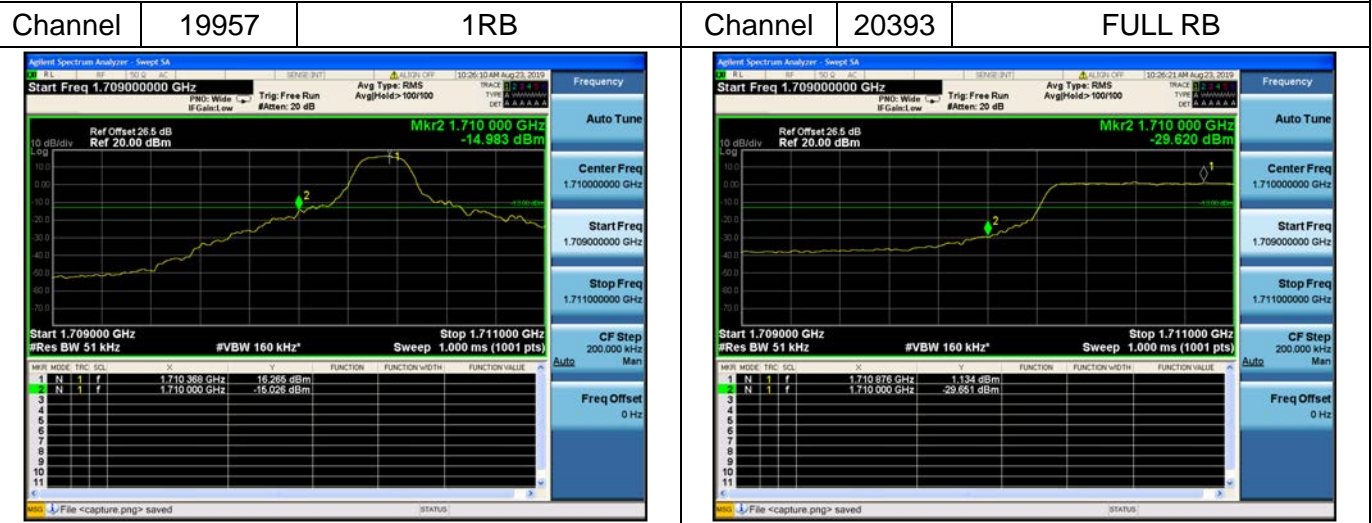

Channel Bandwidth: 1.4MHz

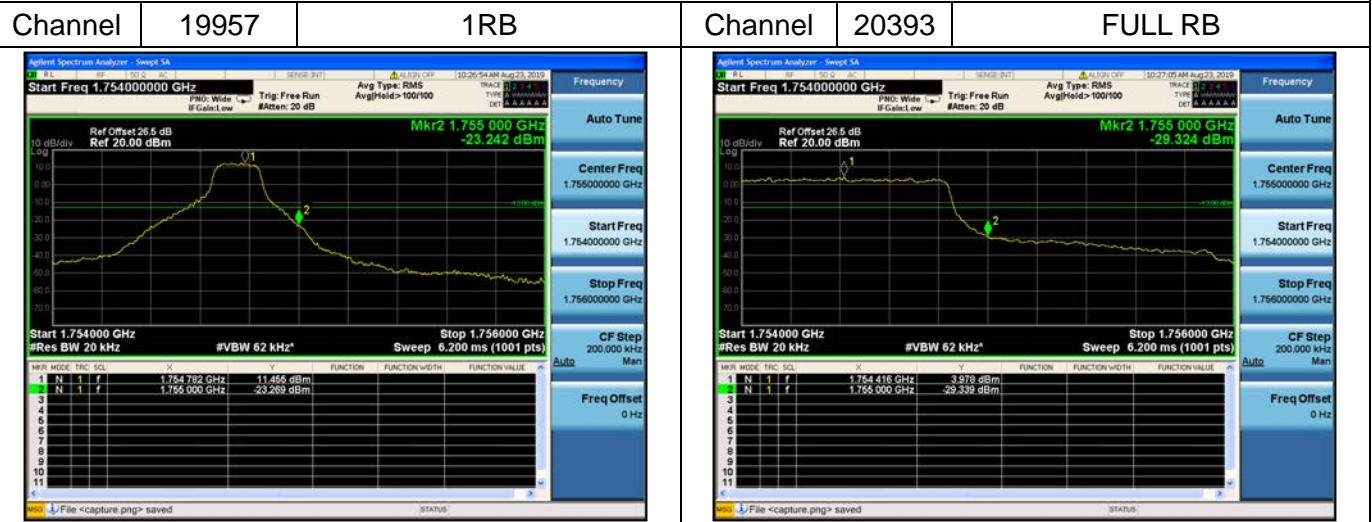



LTE Band 4

Channel Bandwidth: 3MHz

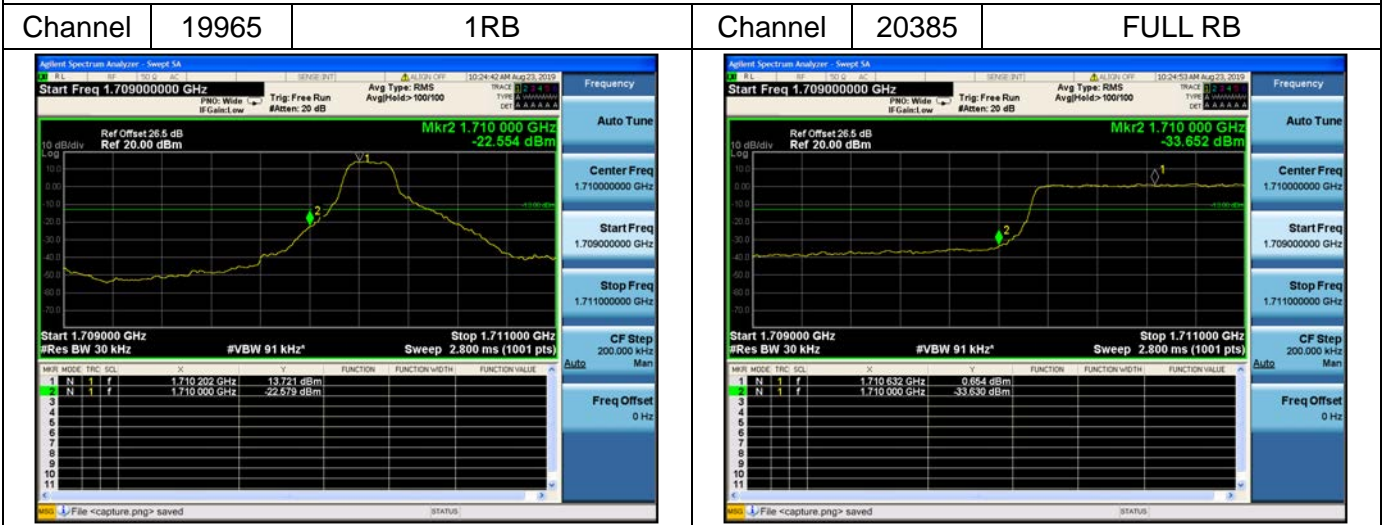

Channel Bandwidth: 3MHz

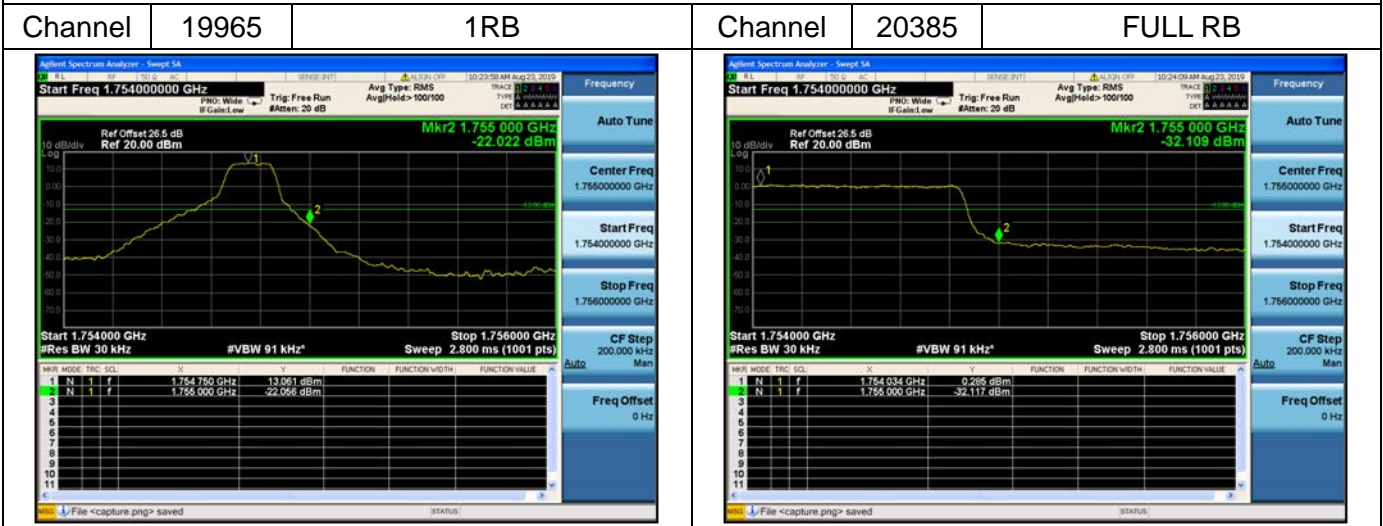



LTE Band 4

Channel Bandwidth: 5MHz

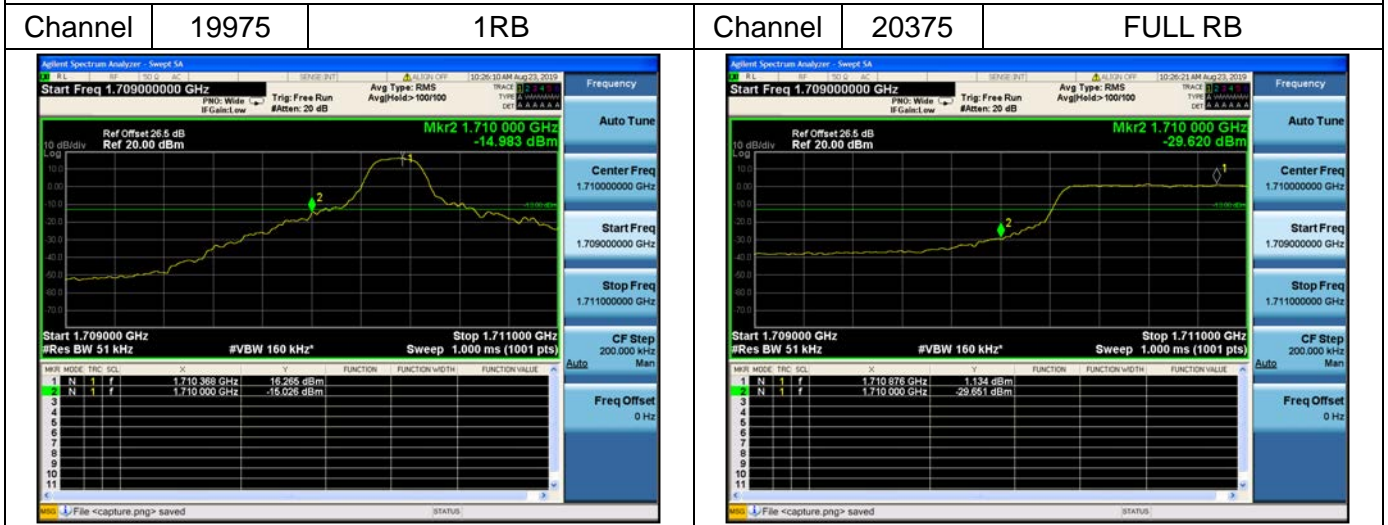

Channel Bandwidth: 5MHz

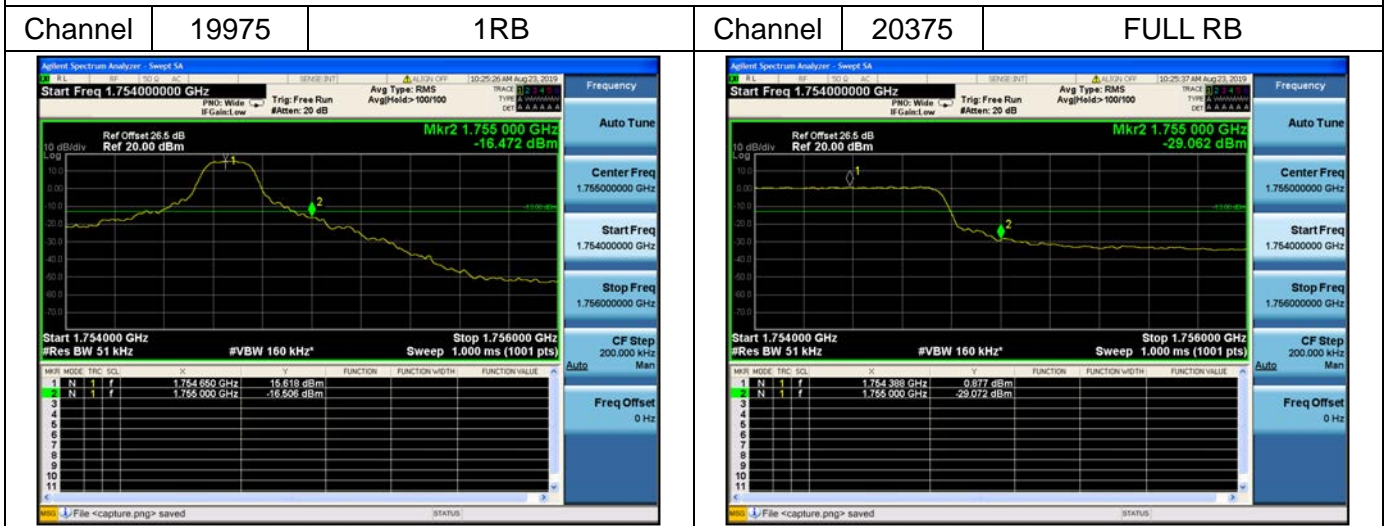



LTE Band 4

Channel Bandwidth: 10MHz

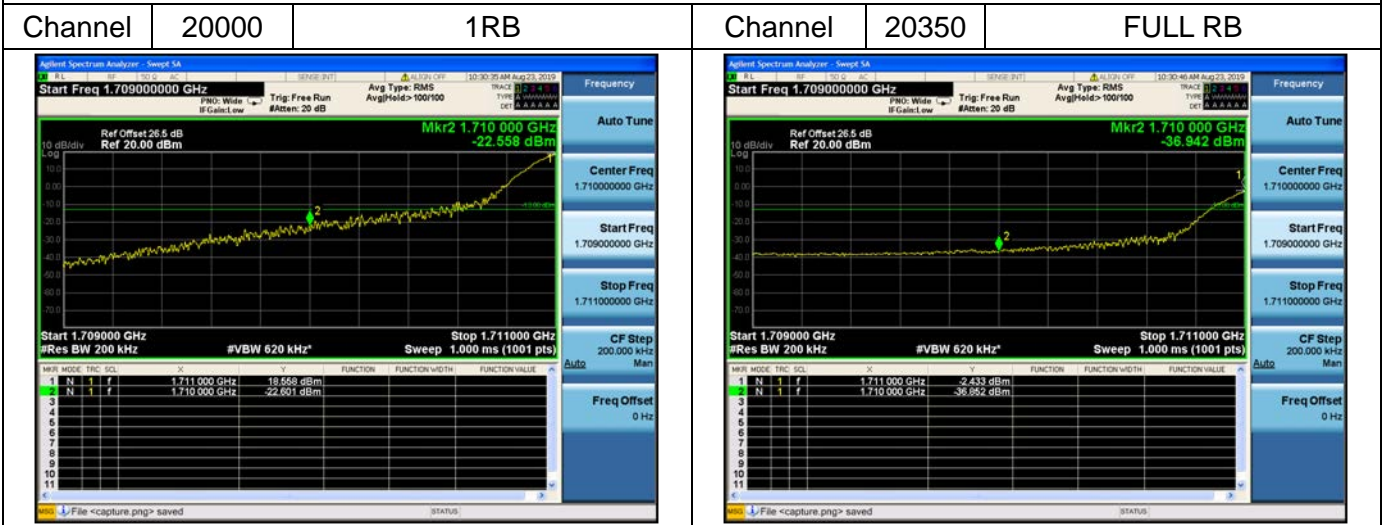

Channel Bandwidth: 10MHz

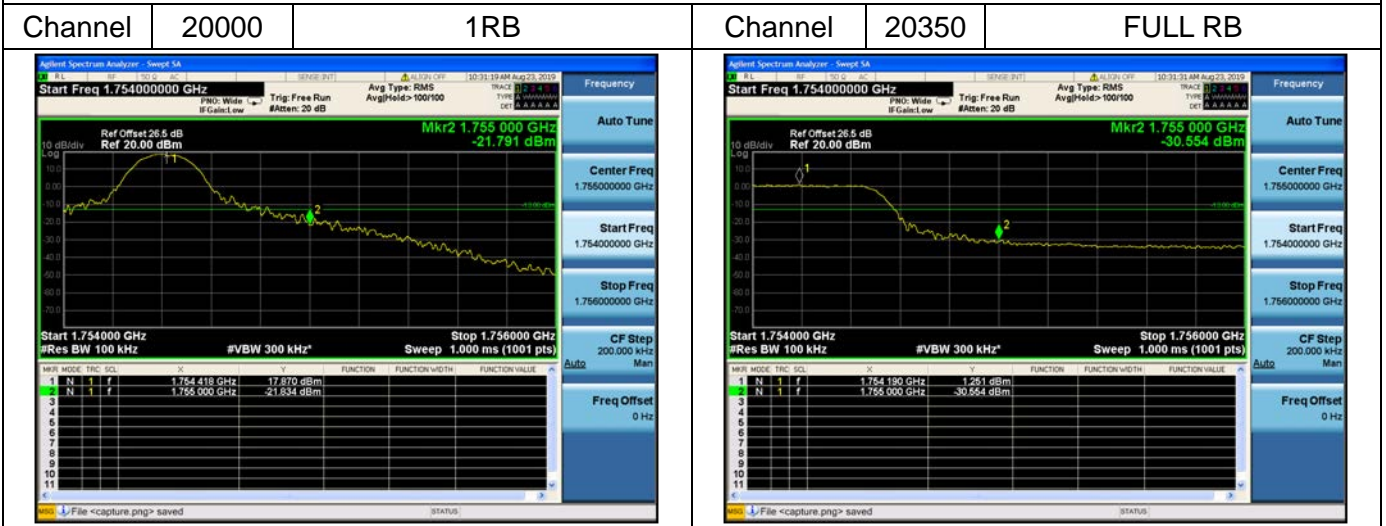



LTE Band 4

Channel Bandwidth: 15MHz

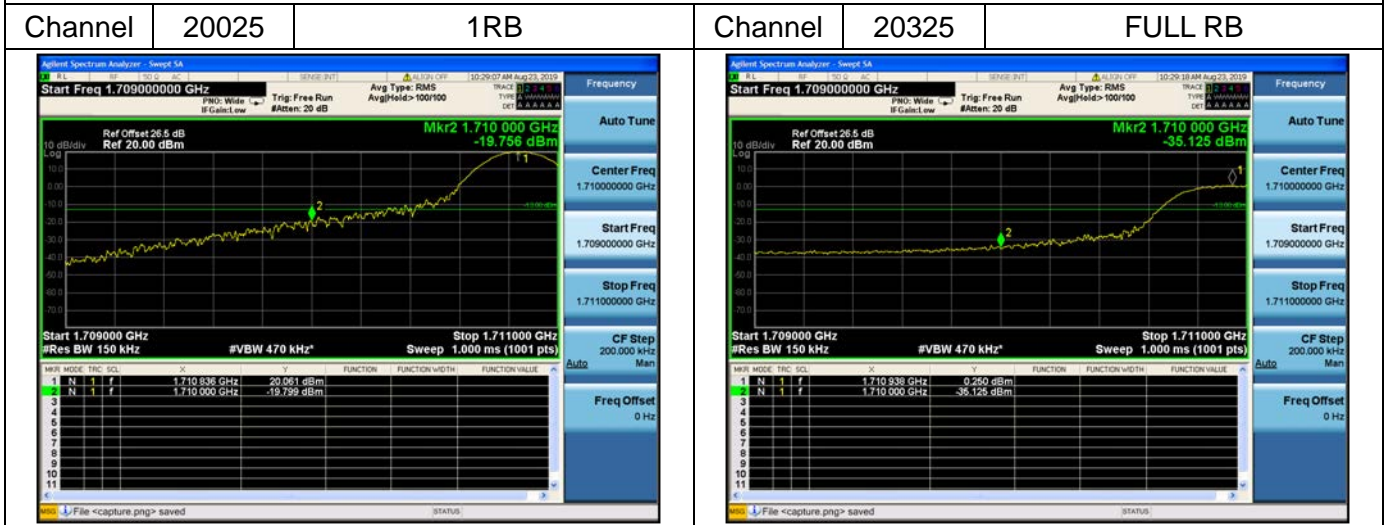

Channel Bandwidth: 15MHz

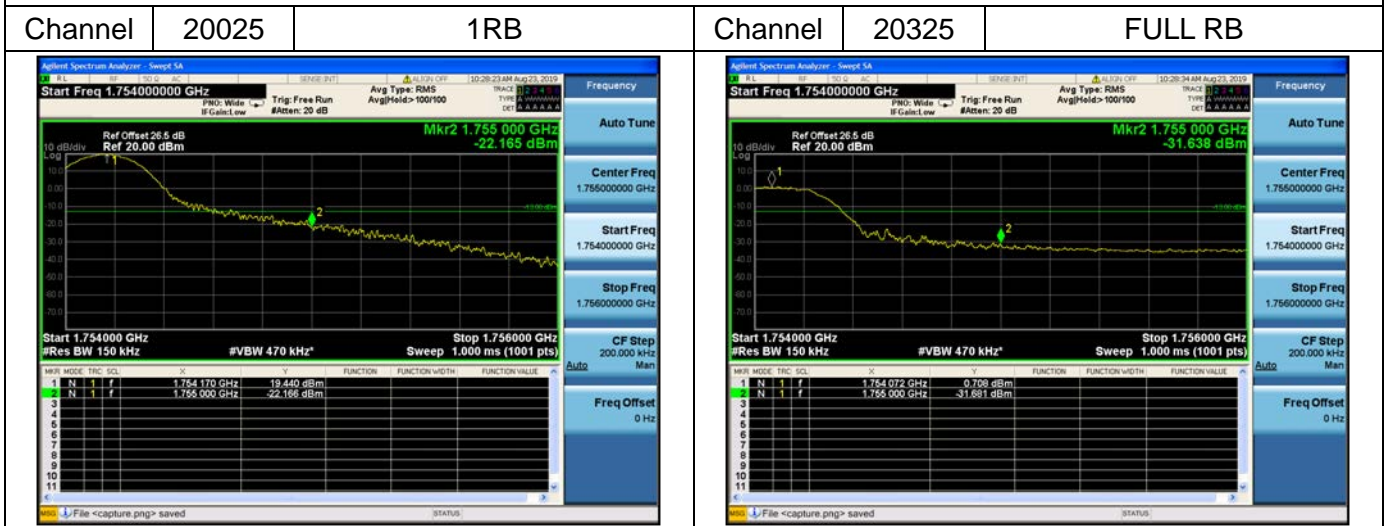



LTE Band 4

Channel Bandwidth: 20MHz

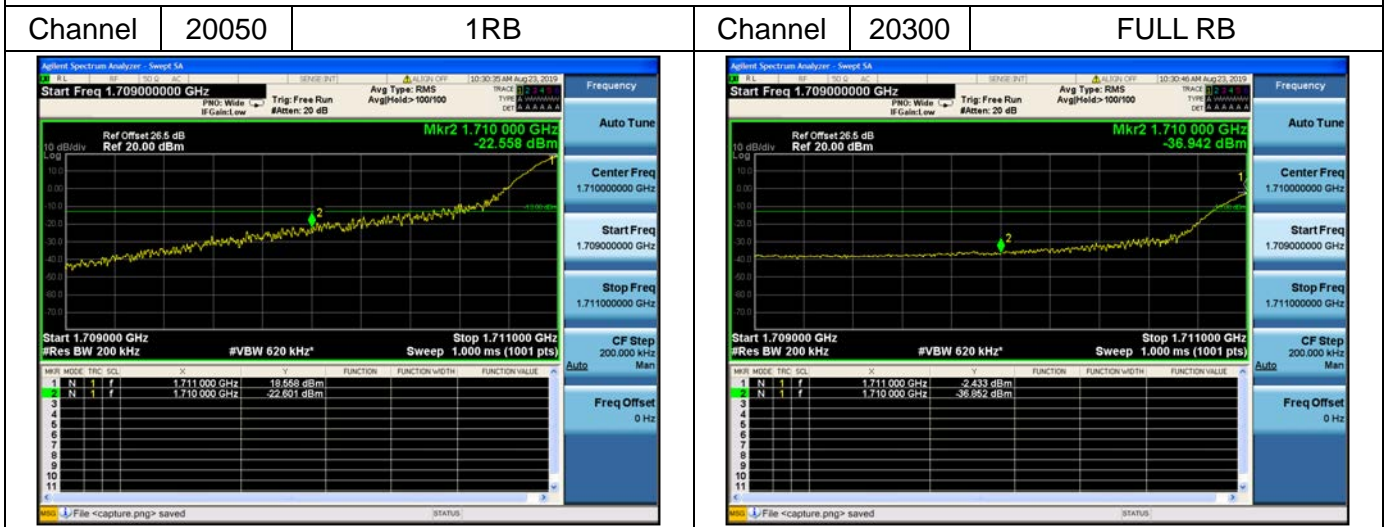

Channel Bandwidth: 20MHz

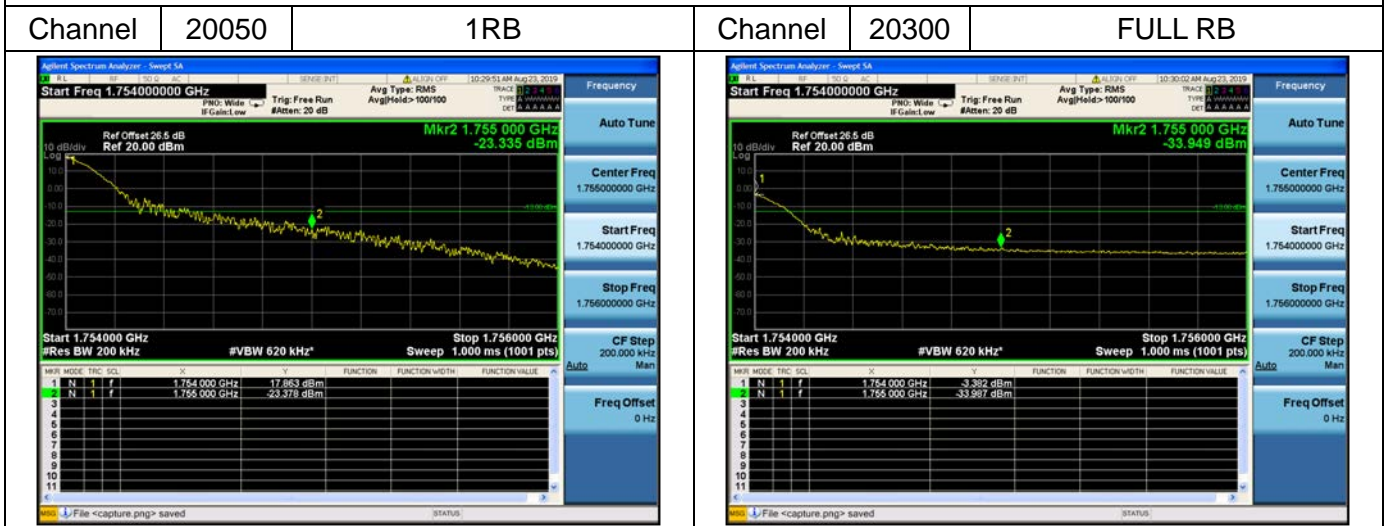



LTE Band 5

Channel Bandwidth: 1.4MHz

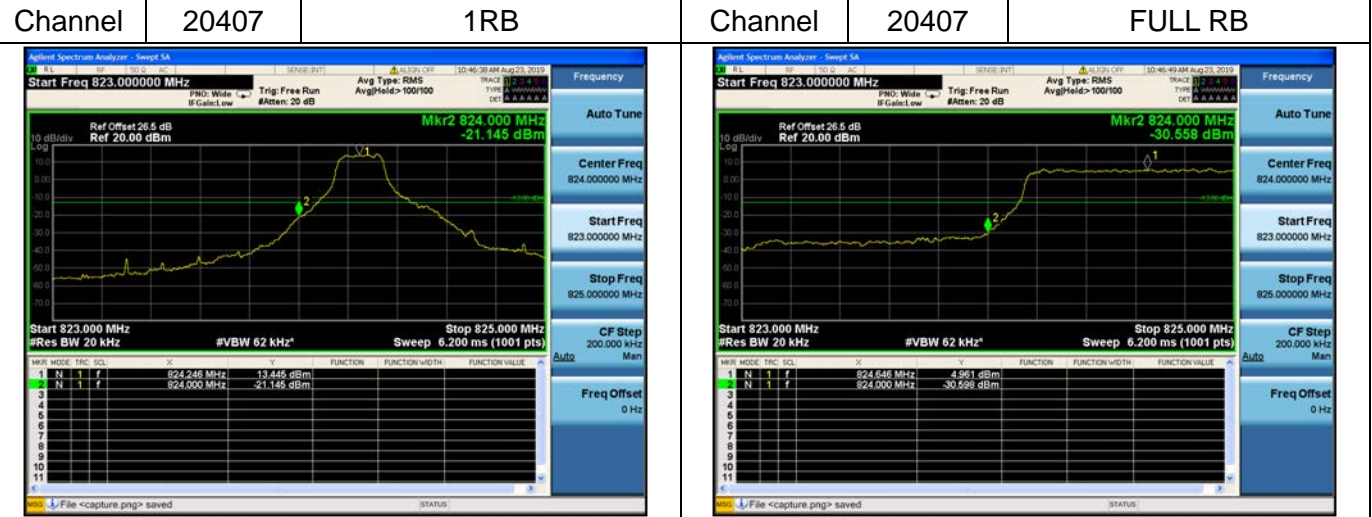

Channel Bandwidth: 1.4MHz

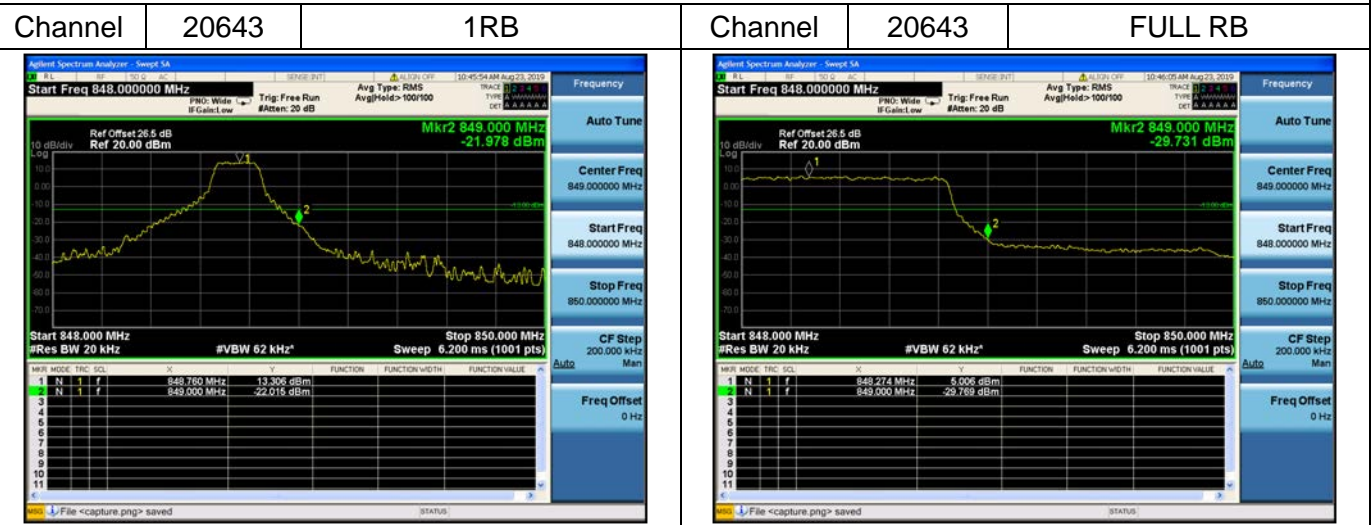



LTE Band 5

Channel Bandwidth: 3MHz

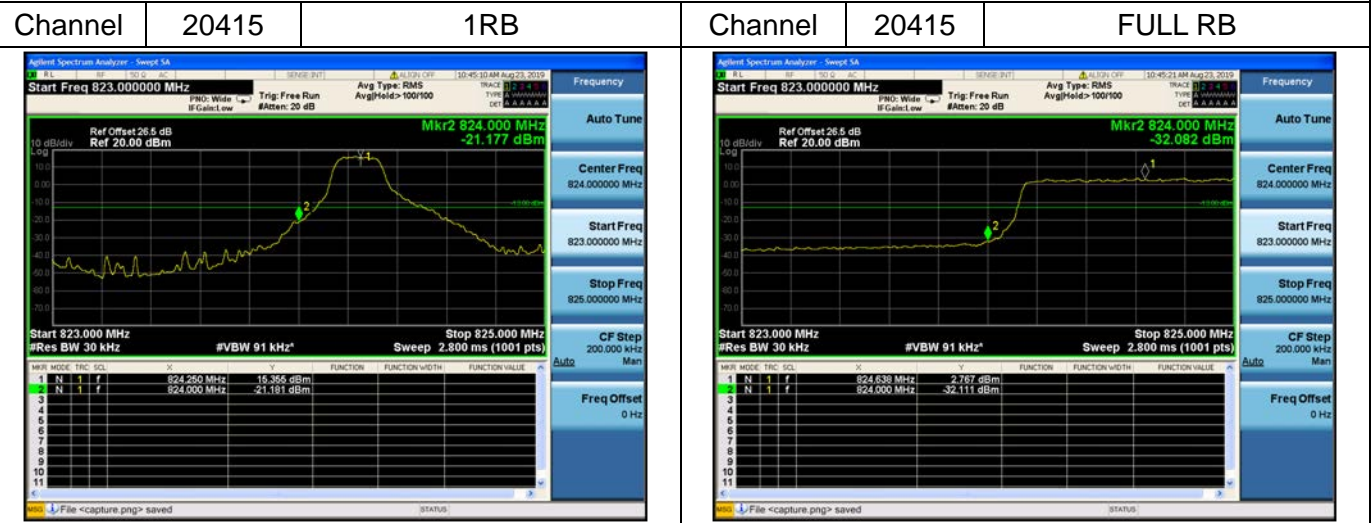

Channel Bandwidth: 3MHz

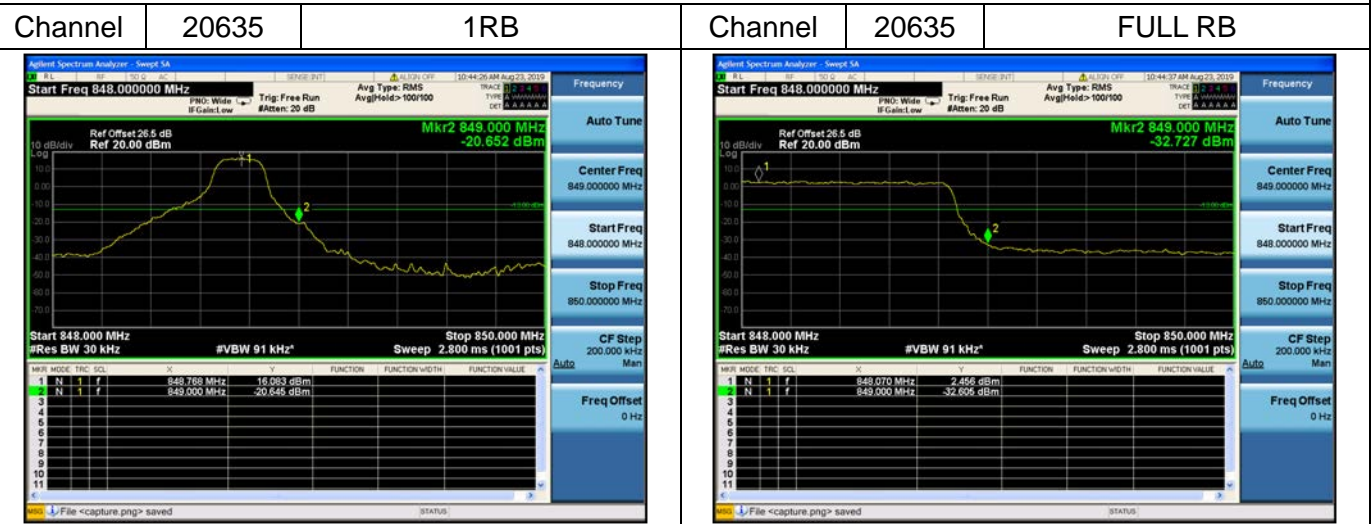



LTE Band 5

Channel Bandwidth: 5MHz

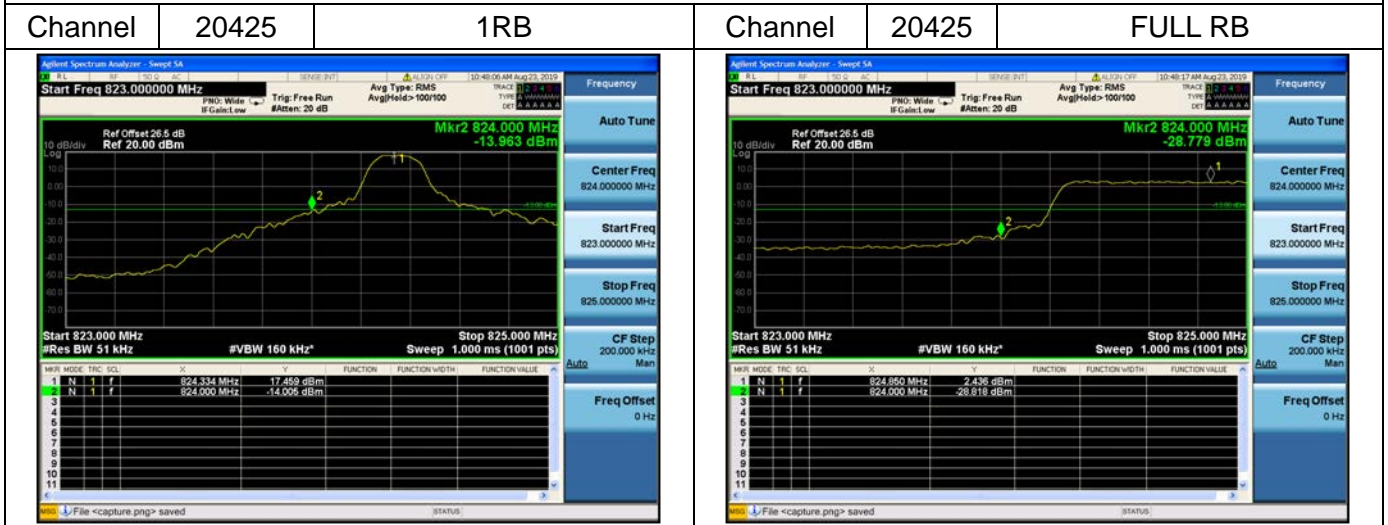

Channel Bandwidth: 5MHz

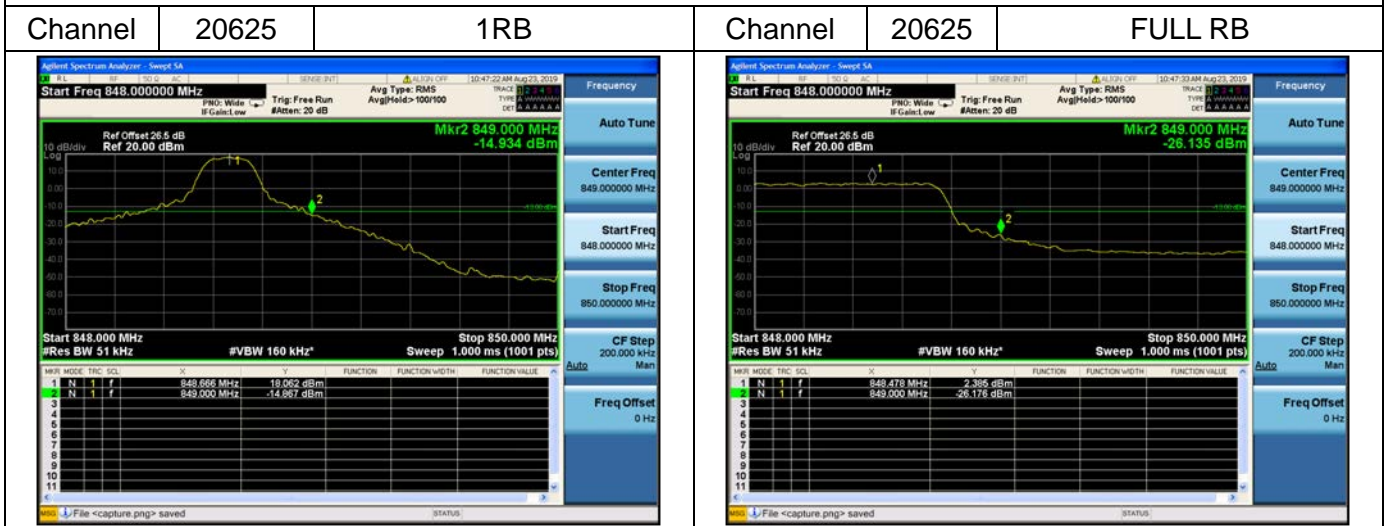



LTE Band 5

Channel Bandwidth: 10MHz

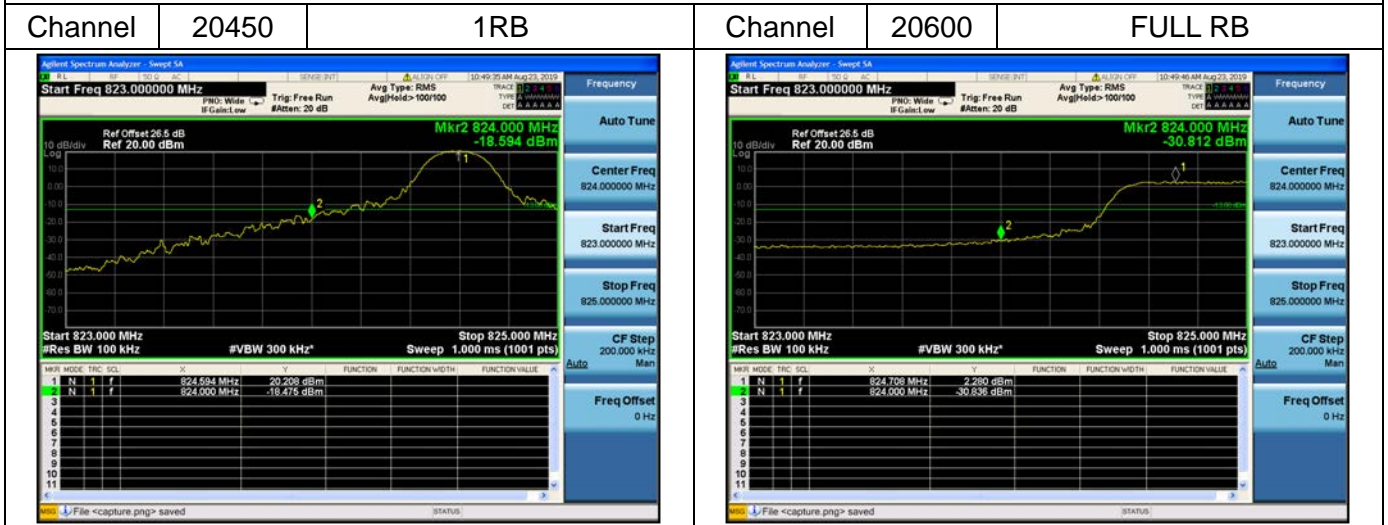

Channel Bandwidth: 10MHz

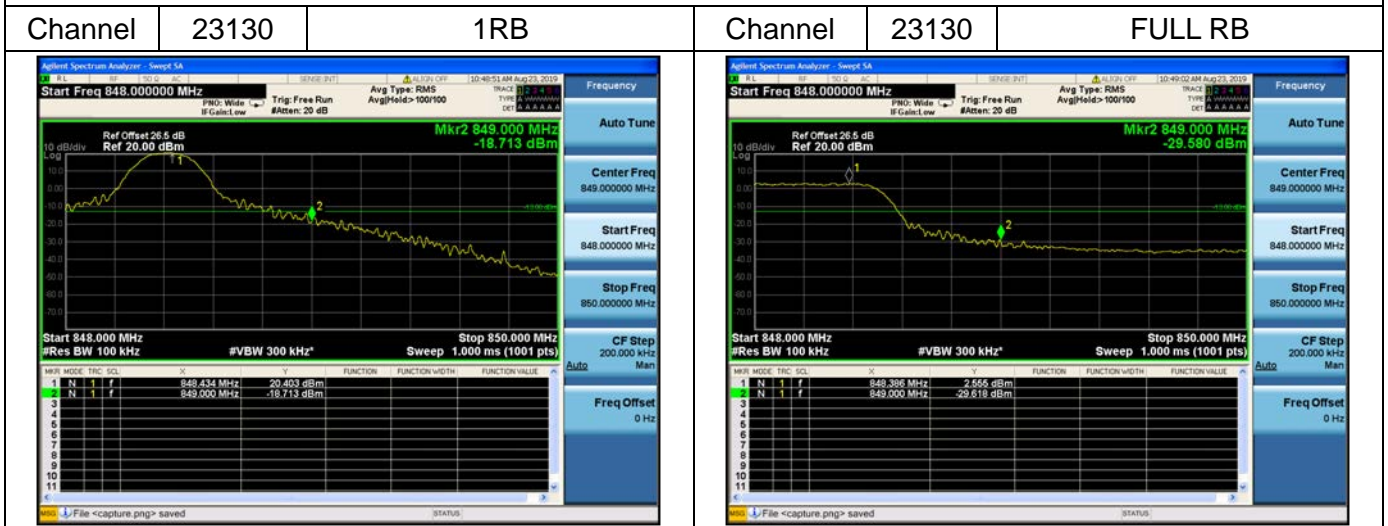



LTE Band 7

Channel Bandwidth: 5MHz

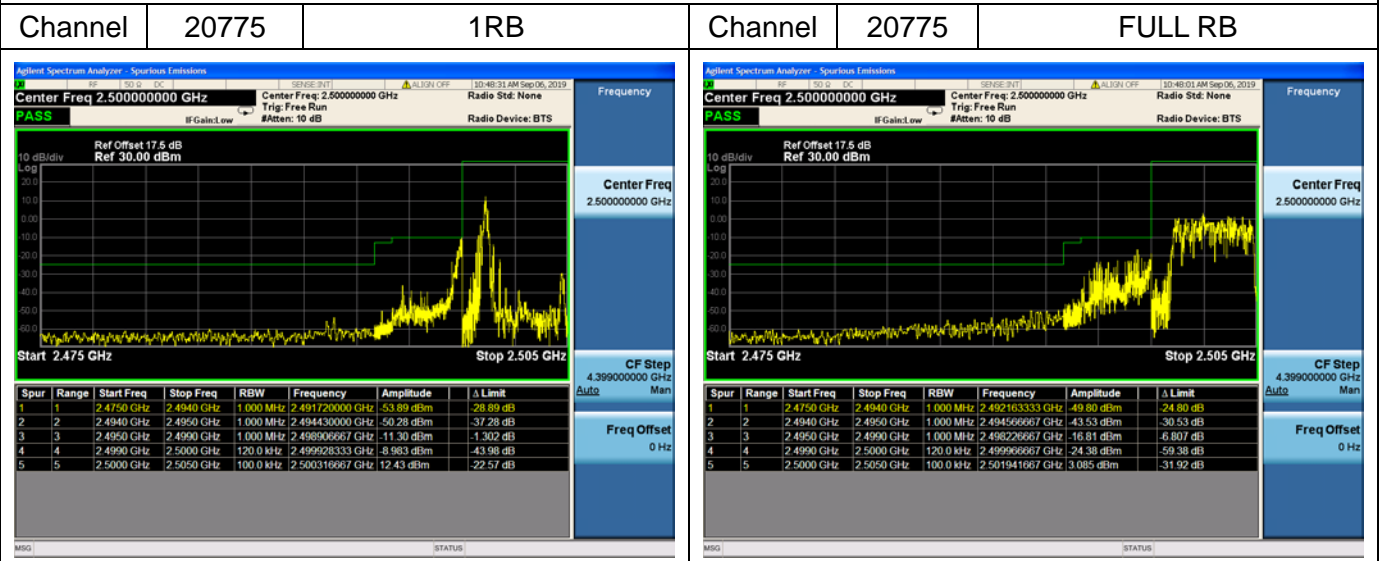

Channel Bandwidth: 5MHz

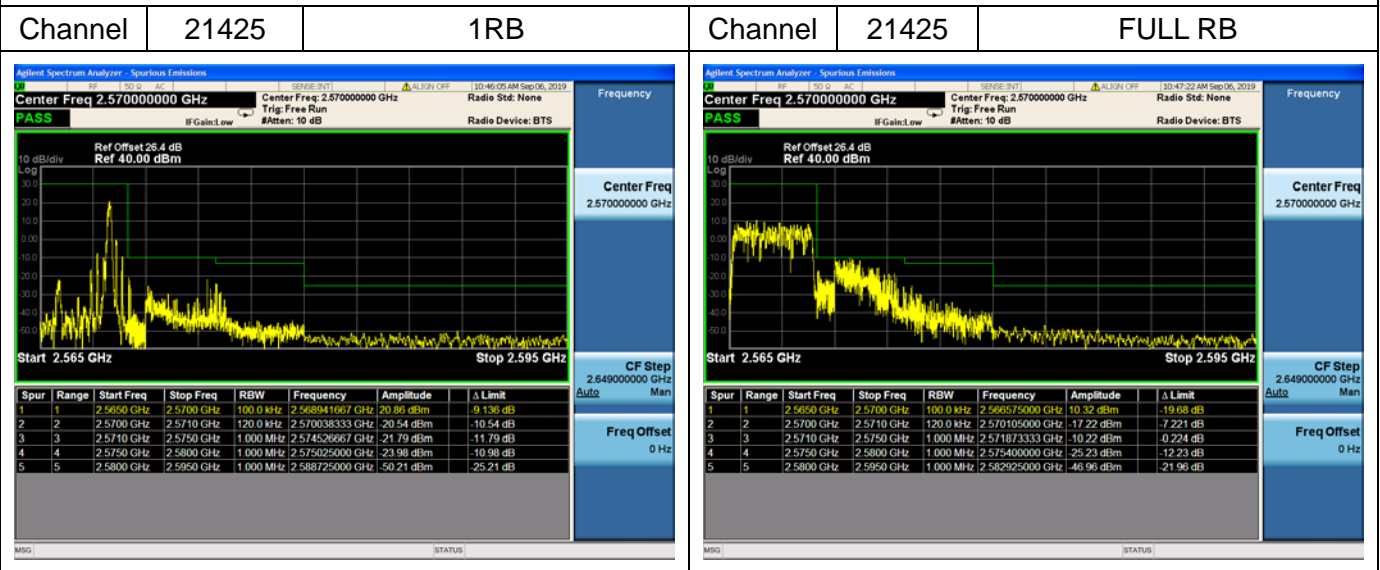



LTE Band 7

Channel Bandwidth: 10MHz

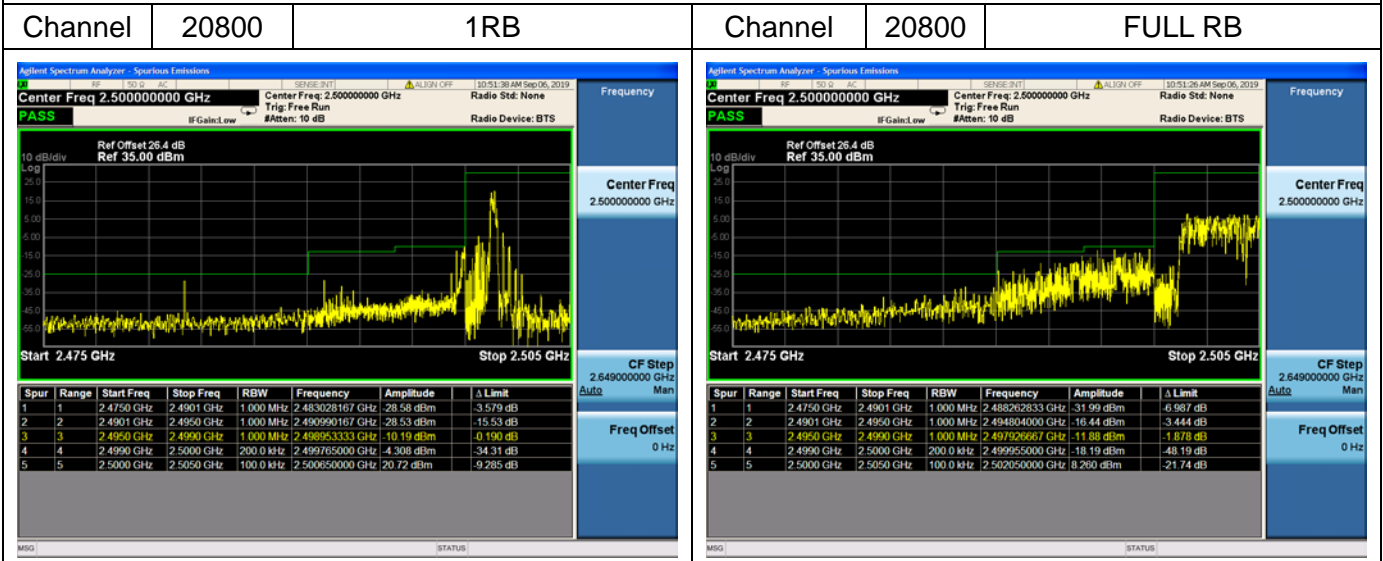

Channel Bandwidth: 10MHz

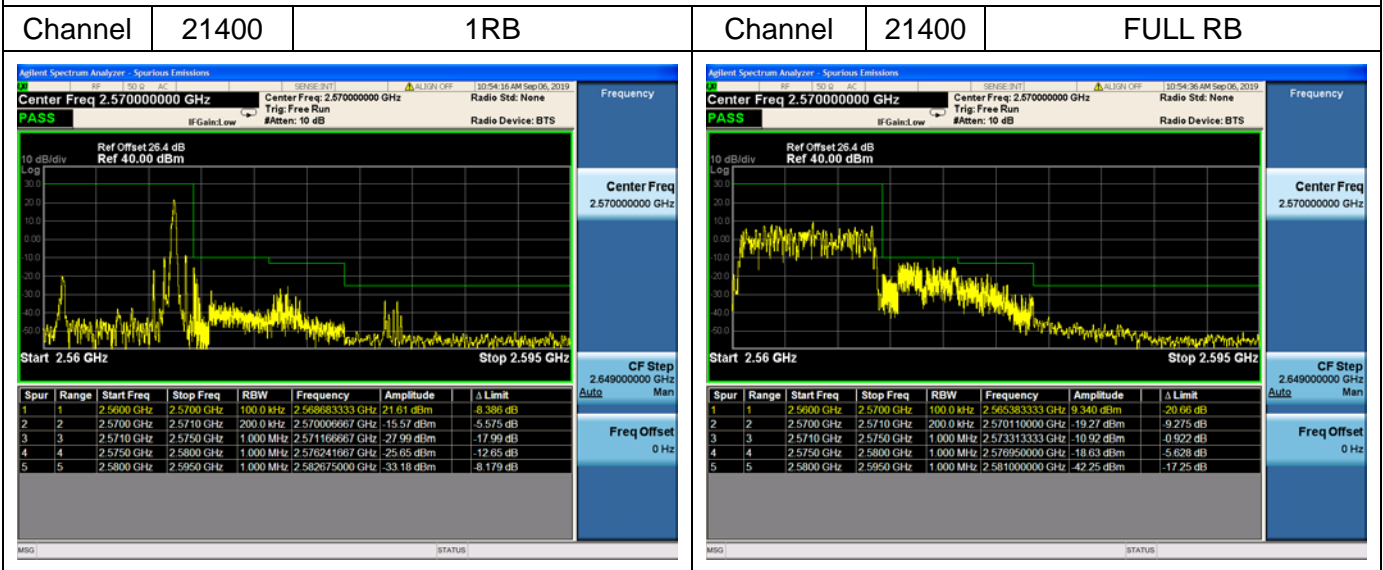



LTE Band 7

Channel Bandwidth: 15MHz

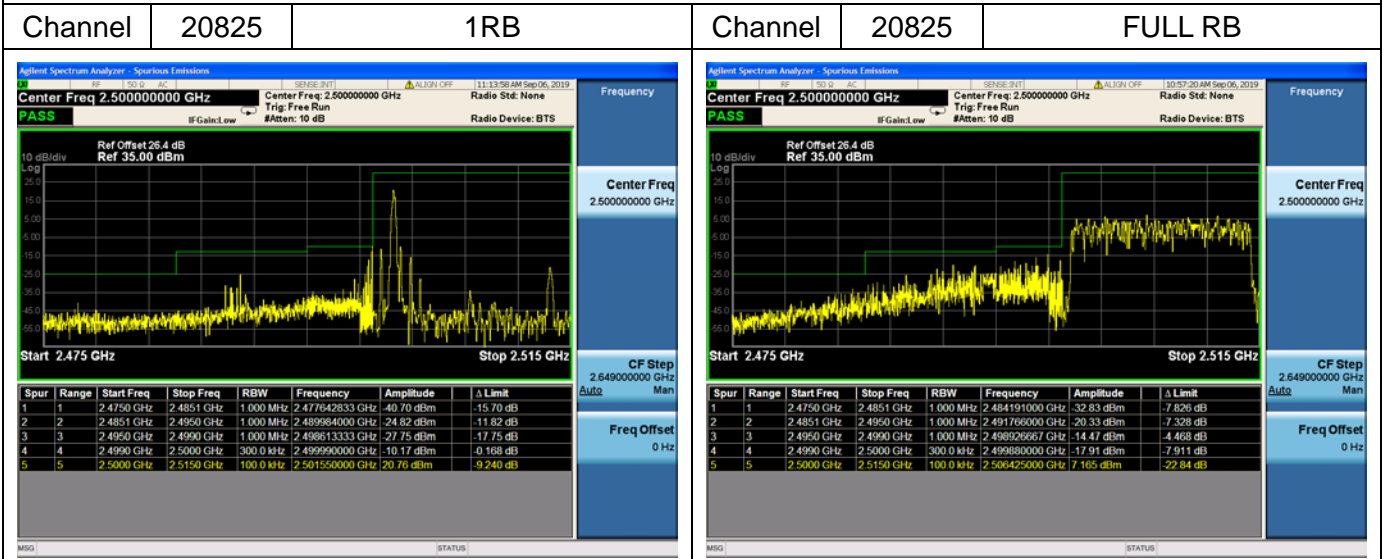

Channel Bandwidth: 15MHz

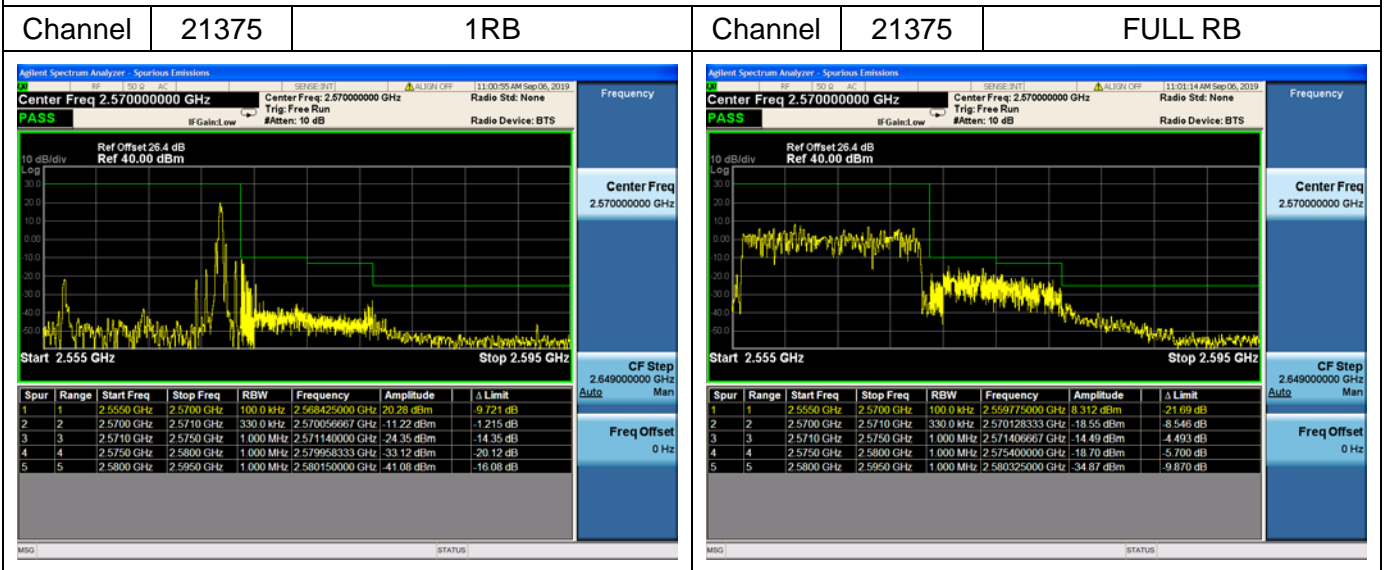



LTE Band 7

Channel Bandwidth: 20MHz

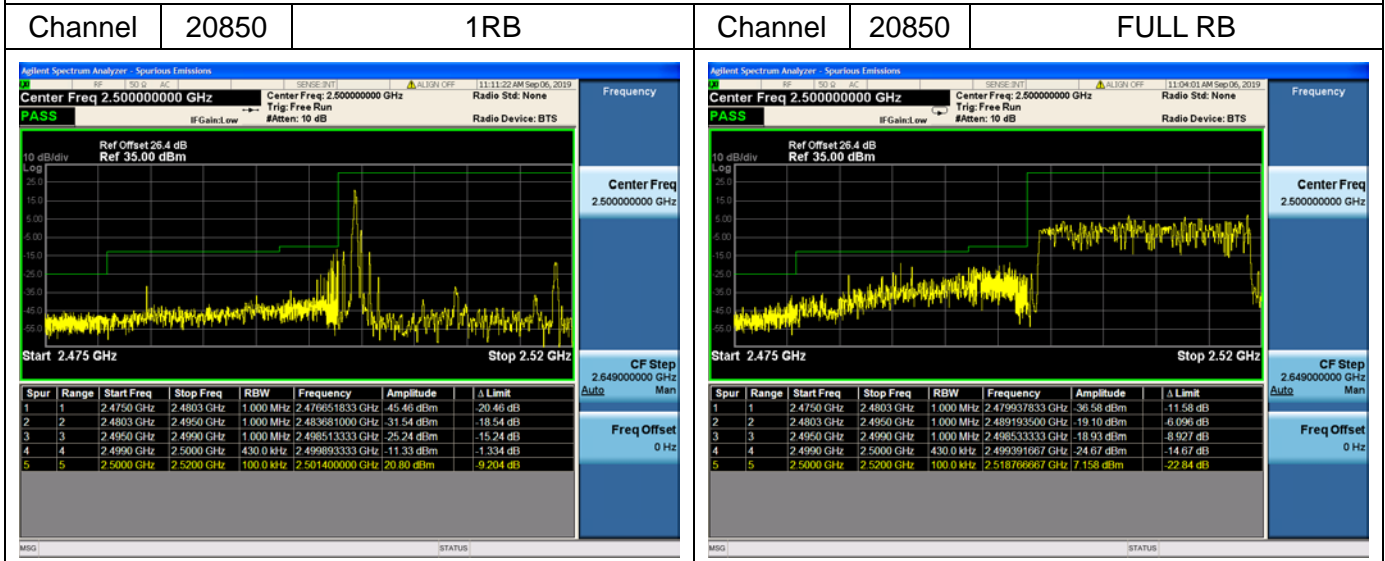

Channel Bandwidth: 20MHz

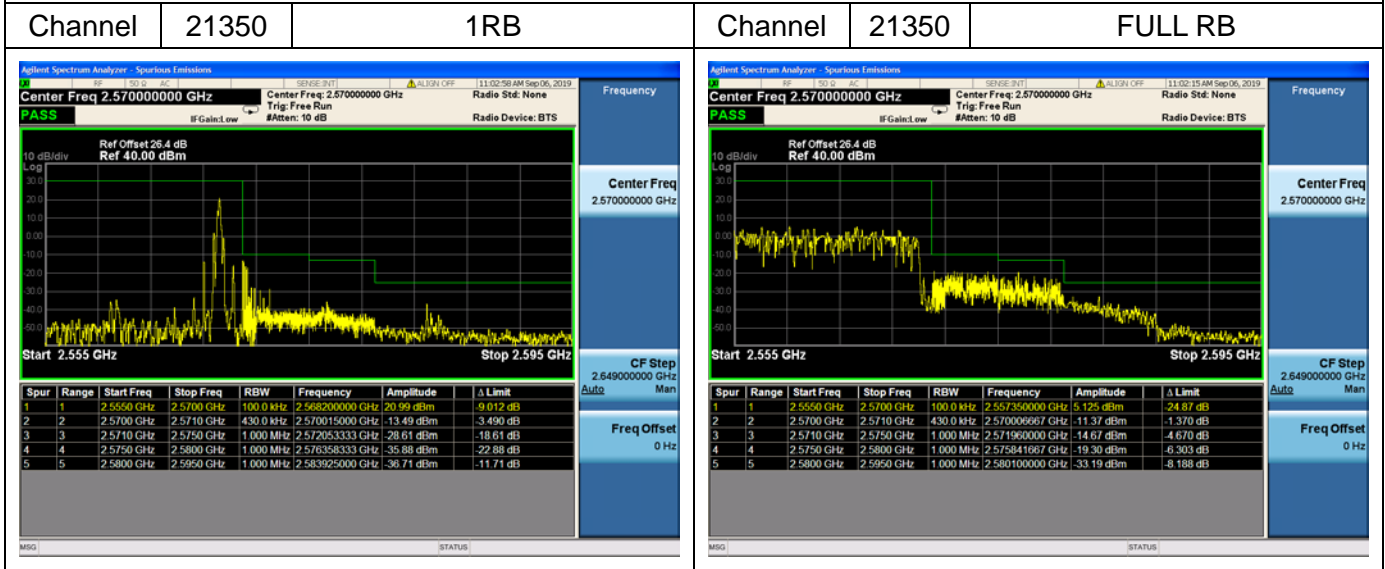

2.7. Radiated Spurious Emissions

2.7.1. Requirement

According to FCC section 2.1051, the power of any emission outside of the authorized operating frequency ranges must be attenuated below the transmitting power (P) by a factor of at least $43 + 10 \cdot \log(P)$ dB. This calculated to be -13dBm.

Additional requirement for LTE Band 7/41:

The power of any emission outside of the authorized operating frequency ranges must be attenuated below the transmitting power (P) by a factor of at least $55 + 10 \log(P)$ dB. This calculated to be -25dBm.

2.7.2. Test Description

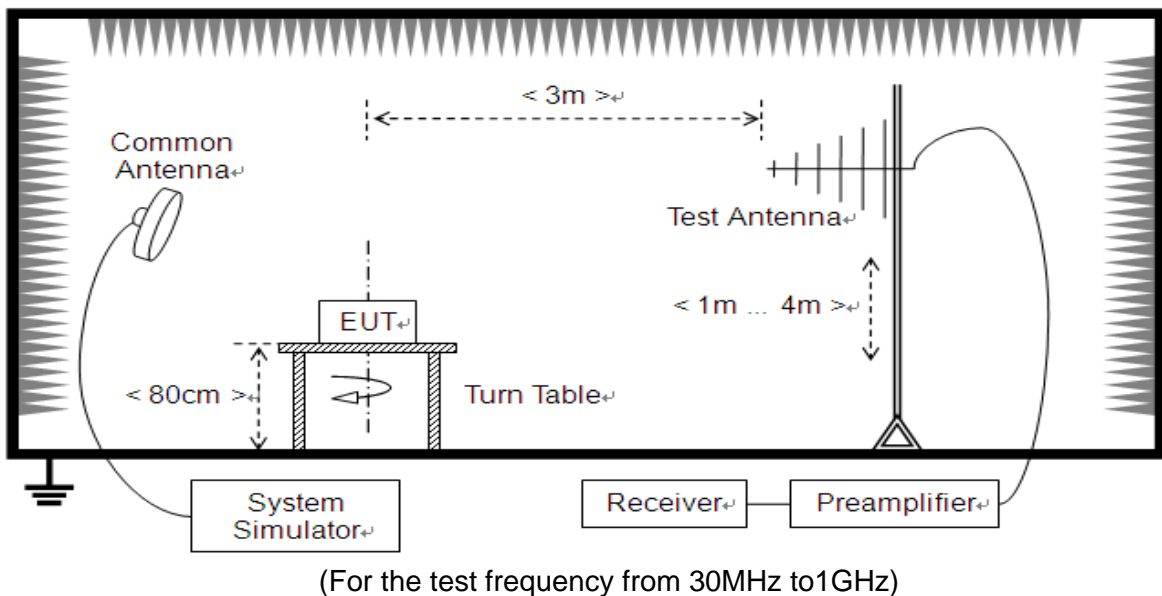

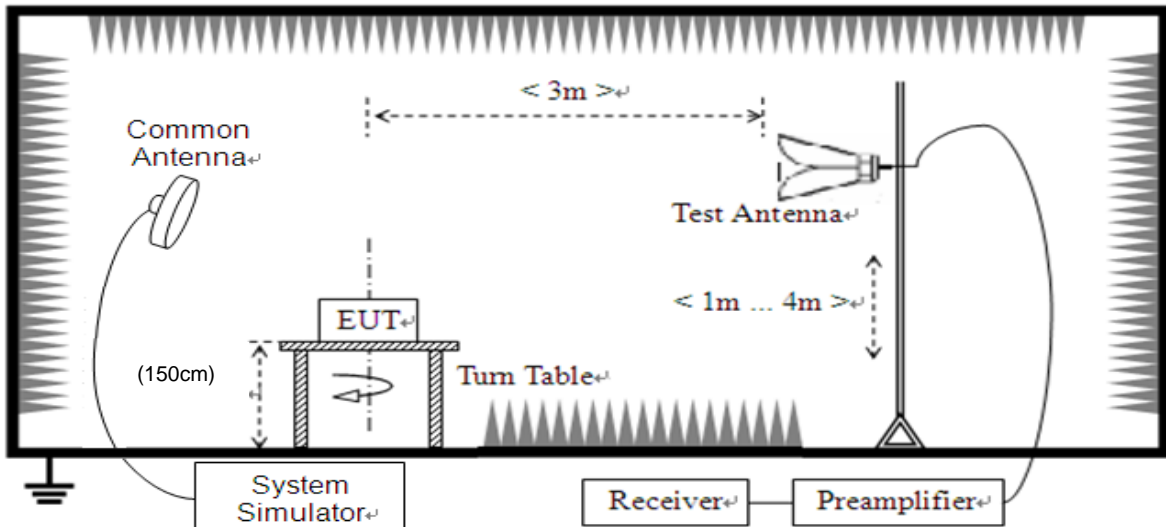

(For the test frequency above 1GHz)

The EUT is located in a 3m Full-Anechoic Chamber, the cable loss, air loss and so on of the site as factors are pre-calibrated using the "Substitution" method, and calculated to correct the reading. A call is established between the EUT and the SS via a Common Antenna. The EUT is commanded by the SS to operate at the maximum and minimum output power, and only the test result of the maximum output power was recorded.

In the frequency range above 30MHz, Bi-Log Test Antenna (30MHz to 1GHz) and Horn Test Antenna (above 1GHz) are used. Test Antenna is 3m away from the EUT. Test Antenna height is varied from 1m to 4m above the ground and the Turn Table is actuated to turn from 0° to 360° to determine the maximum value of the radiated power. The emission levels at both horizontal and vertical polarizations should be tested. The Filters consists of Notch Filters and High Pass Filter.

Note: when doing measurements above 1GHz, the EUT has been within the 3dB cone width of the horn antenna during horizontal antenna.

2.7.3. Test procedure

KDB 971168 D01v03 Section 5.8 and ANSI/TIA-603-E-2016.



2.7.4. Test Result

The measurement frequency range is from 30MHz to the 10th harmonic of the fundamental frequency. Test Antenna height is varied from 1m to 4m above the ground, and the Turn Table is actuated to turn from 0° to 360°, both horizontal and vertical polarizations of the Test Antenna are used to find the maximum radiated power. Mid channels on all channel bandwidth verified. Only the worst RB size/offset presented.

The substitution corrections are obtained as described below:

$$A_{\text{SUBST}} = P_{\text{SUBST_TX}} - P_{\text{SUBST_RX}} - L_{\text{SUBST_CABLES}} + G_{\text{SUBST_TX_ANT}}$$

$$A_{\text{TOT}} = L_{\text{CABLES}} + A_{\text{SUBST}}$$

Where A_{SUBST} is the final substitution correction including receive antenna gain.

$P_{\text{SUBST_TX}}$ is signal generator level,

$P_{\text{SUBST_RX}}$ is receiver level,

$L_{\text{SUBST_CABLES}}$ is cable losses including TX cable,

$G_{\text{SUBST_TX_ANT}}$ is substitution antenna gain.

A_{TOT} is total correction factor including cable loss and substitution correction

During the test, the data of A_{TOT} was added in the Test Spectrum Analyze, so Spectrum Analyze reading is the final values which contain the data of A_{TOT} .

Note1: The power of the EUT transmitting frequency should be ignored.

Note2: All Spurious Emission tests were performed in X, Y, Z axis direction. And only the worst axis test condition was recorded in this test report.

Note3: All bandwidth and test channel were considered and evaluated respectively by performing full test for each band, only the worst cases were recorded in this test report.



LTE Band 2 20MHz BW, Low Channel, QPSK

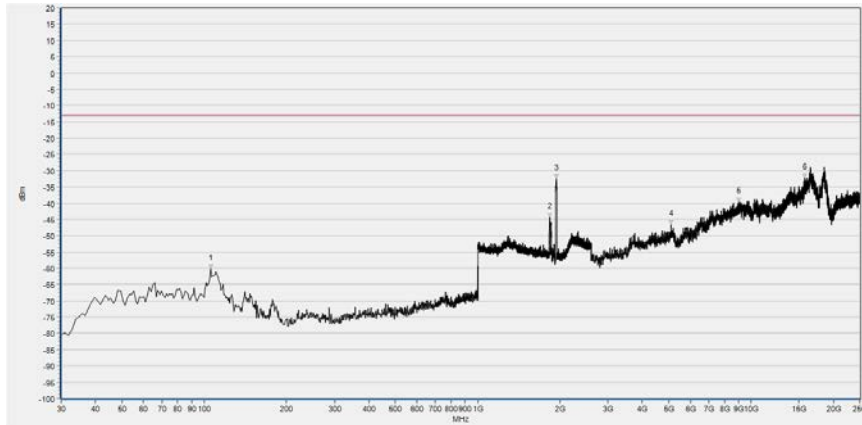

No.	Fre. (MHz)	Peak	Limit(PK)	Antenna	Verdict
1	105.660	-60.31	-13.00	Horizontal	PASS
2	1832.333	-44.36	-13.00	Horizontal	NA
3	1941.176	-32.56	-13.00	Horizontal	NA
4	5109.256	-46.68	-13.00	Horizontal	PASS
5	9023.859	-39.64	-13.00	Horizontal	PASS
6	15683.979	-32.27	-13.00	Horizontal	PASS

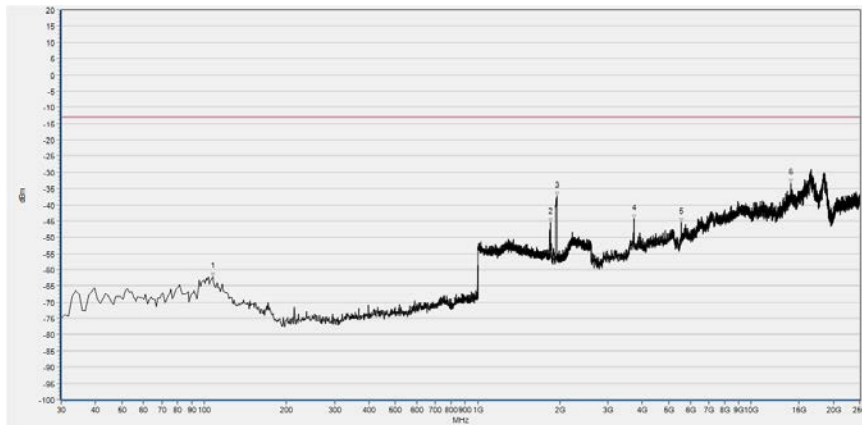

No.	Freq(MHz)	Peak	limit PK	Antenna	Verdict
1	107.600	-62.34	-13.00	Vertical	PASS
2	1851.541	-45.46	-13.00	Vertical	NA
3	1947.579	-37.45	-13.00	Vertical	NA
4	3736.498	-44.45	-13.00	Vertical	PASS
5	5557.338	-45.50	-13.00	Vertical	PASS
6	14001.637	-33.40	-13.00	Vertical	PASS

LTE Band 2 20MHz BW, Mid Channel, QPSK

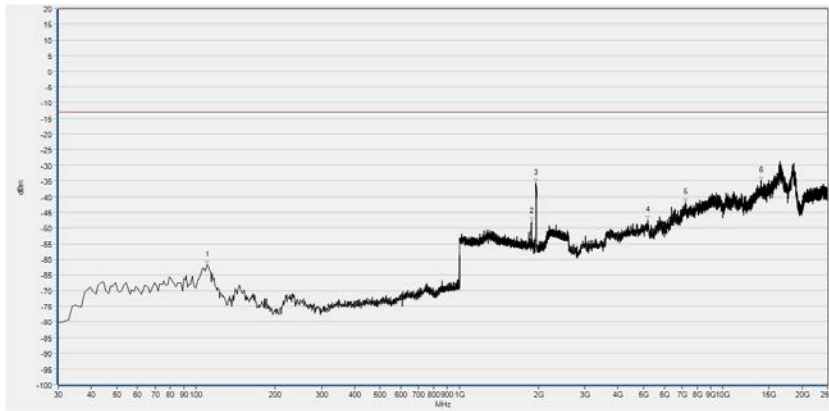

No.	Fre. (MHz)	Peak	Limit(PK)	Antenna	Verdict
1	110.510	-61.73	-13.00	Horizontal	PASS
2	1877.791	-47.99	-13.00	Horizontal	NA
3	1951.421	-35.60	-13.00	Horizontal	NA
4	5202.946	-47.50	-13.00	Horizontal	PASS
5	7219.313	-41.92	-13.00	Horizontal	PASS
6	13997.563	-34.86	-13.00	Horizontal	PASS

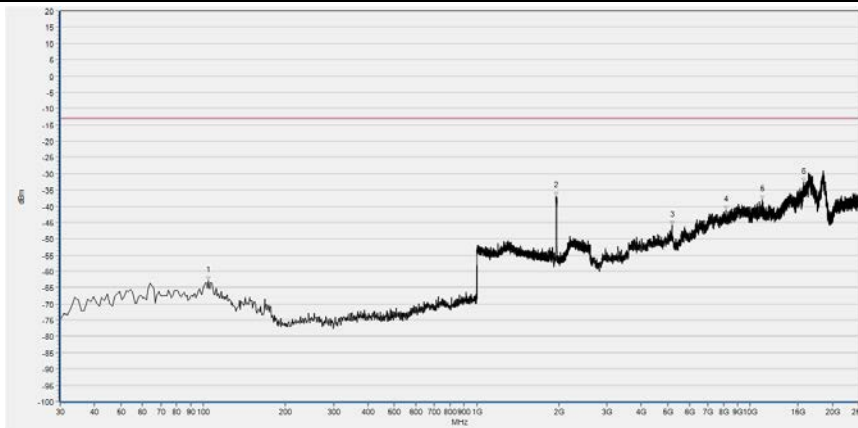

No.	Freq(MHz)	Peak	limit PK	Antenna	Verdict
1	104.690	-62.92	-13.00	Vertical	PASS
2	1952.061	-36.87	-13.00	Vertical	NA
3	5178.505	-46.00	-13.00	Vertical	PASS
4	8164.357	-41.18	-13.00	Vertical	PASS
5	11076.887	-38.00	-13.00	Vertical	PASS
6	15679.905	-32.79	-13.00	Vertical	PASS

LTE Band 2 20MHz BW, High Channel, QPSK

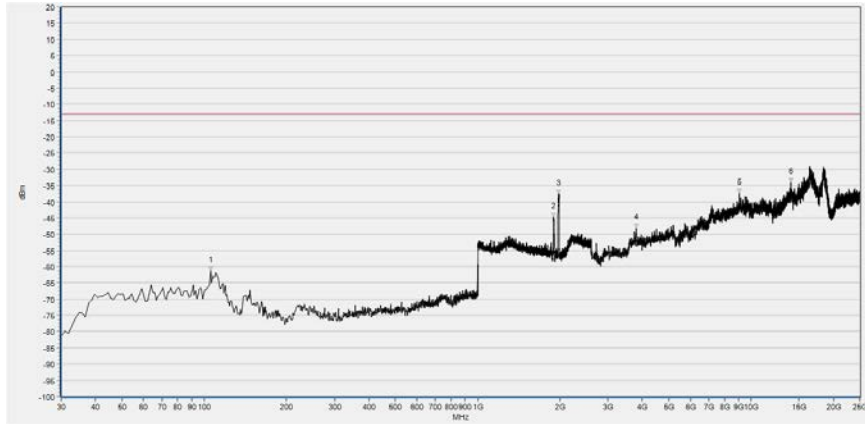

No.	Fre. (MHz)	Peak	Limit(PK)	Antenna	Verdict
1	105.660	-61.33	-13.00	Horizontal	PASS
2	1898.920	-44.90	-13.00	Horizontal	NA
3	1982.153	-37.71	-13.00	Horizontal	NA
4	3805.746	-48.08	-13.00	Horizontal	PASS
5	9072.740	-37.51	-13.00	Horizontal	PASS
6	14017.931	-34.02	-13.00	Horizontal	PASS

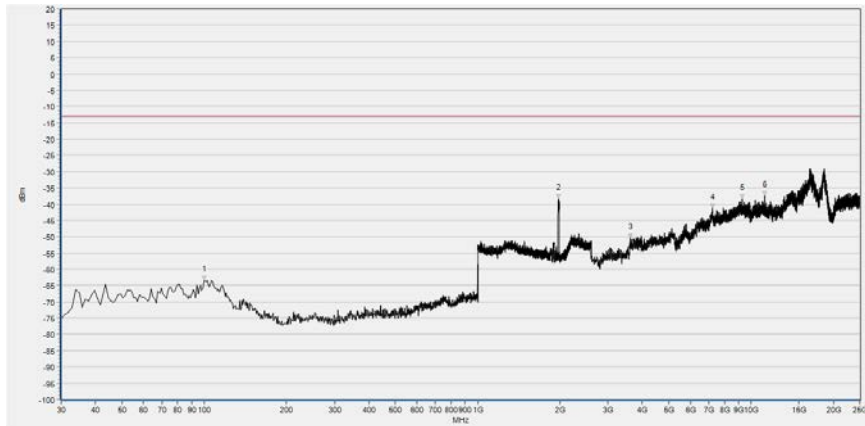

No.	Freq(MHz)	Peak	limit PK	Antenna	Verdict
1	99.840	-63.46	-13.00	Vertical	PASS
2	1971.909	-38.36	-13.00	Vertical	NA
3	3614.294	-50.43	-13.00	Vertical	PASS
4	7243.753	-41.13	-13.00	Vertical	PASS
5	9309.002	-38.40	-13.00	Vertical	PASS
6	11223.532	-37.38	-13.00	Vertical	PASS



LTE Band 4 20MHz BW, Low Channel, QPSK

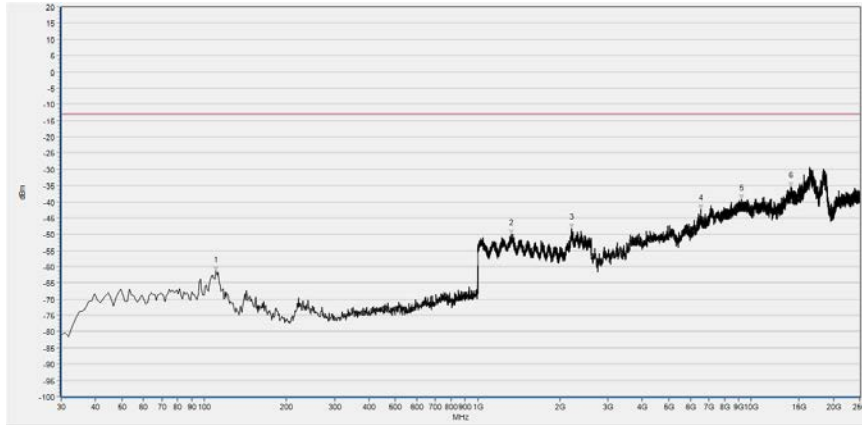

No.	Fre. (MHz)	Peak	Limit(PK)	Antenna	Verdict
1	110.510	-61.40	-13.00	Horizontal	PASS
2	1325.890	-49.84	-13.00	Horizontal	PASS
3	2212.005	-48.20	-13.00	Horizontal	PASS
4	6563.484	-42.39	-13.00	Horizontal	PASS
5	9211.238	-39.31	-13.00	Horizontal	PASS
6	14017.931	-35.51	-13.00	Horizontal	PASS

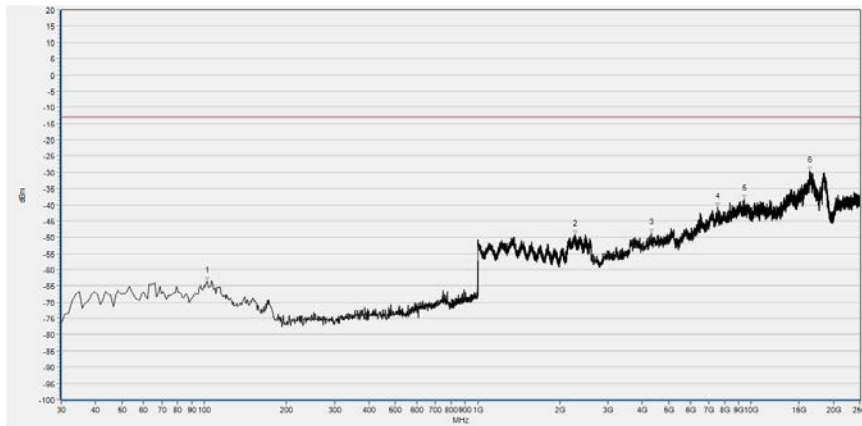

No.	Fre. (MHz)	Peak	Limit(PK)	Antenna	Verdict
1	102.750	-63.64	-13.00	Vertical	PASS
2	2274.750	-49.31	-13.00	Vertical	PASS
3	4323.077	-48.91	-13.00	Vertical	PASS
4	7561.484	-40.75	-13.00	Vertical	PASS
5	9451.573	-38.43	-13.00	Vertical	PASS
6	16404.983	-29.64	-13.00	Vertical	PASS

LTE Band 4 20MHz BW, Mid Channel, QPSK



No.	Fre. (MHz)	Peak	Limit(PK)	Antenna	Verdict
1	106.630	-60.94	-13.00	Horizontal	PASS
2	1239.456	-48.89	-13.00	Horizontal	PASS
3	2212.005	-48.67	-13.00	Horizontal	PASS
4	5145.917	-46.96	-13.00	Horizontal	PASS
5	8587.998	-41.04	-13.00	Horizontal	PASS
6	11125.768	-38.19	-13.00	Horizontal	PASS



No.	Fre. (MHz)	Peak	Limit(PK)	Antenna	Verdict
1	106.630	-63.09	-13.00	Vertical	PASS
2	1337.415	-49.48	-13.00	Vertical	PASS
3	2284.994	-48.81	-13.00	Vertical	PASS
4	7260.047	-40.71	-13.00	Vertical	PASS
5	9093.108	-38.35	-13.00	Vertical	PASS
6	13973.122	-35.85	-13.00	Vertical	PASS



LTE Band 4 20MHz BW, High Channel, QPSK

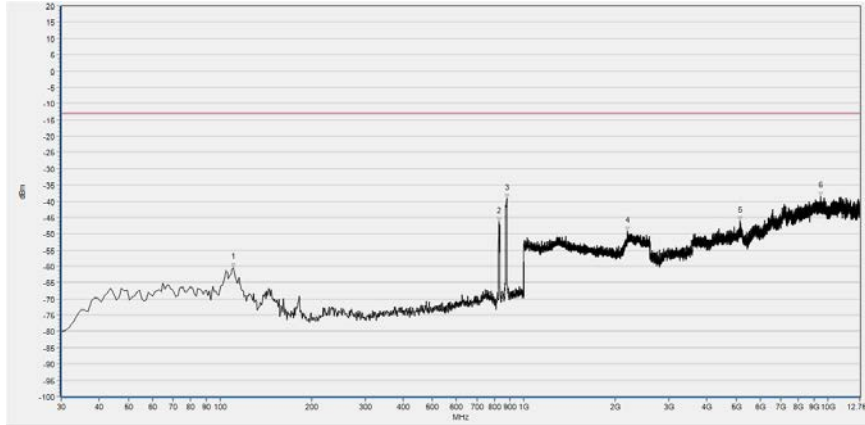

No.	Fre. (MHz)	Peak	Limit(PK)	Antenna	Verdict
1	110.510	-60.34	-13.00	Horizontal	PASS
2	827.340	-46.32	-13.00	Horizontal	NA
3	877.780	-39.26	-13.00	Horizontal	NA
4	2193.437	-49.33	-13.00	Horizontal	PASS
5	5134.270	-46.07	-13.00	Horizontal	PASS
6	9481.106	-38.44	-13.00	Horizontal	PASS

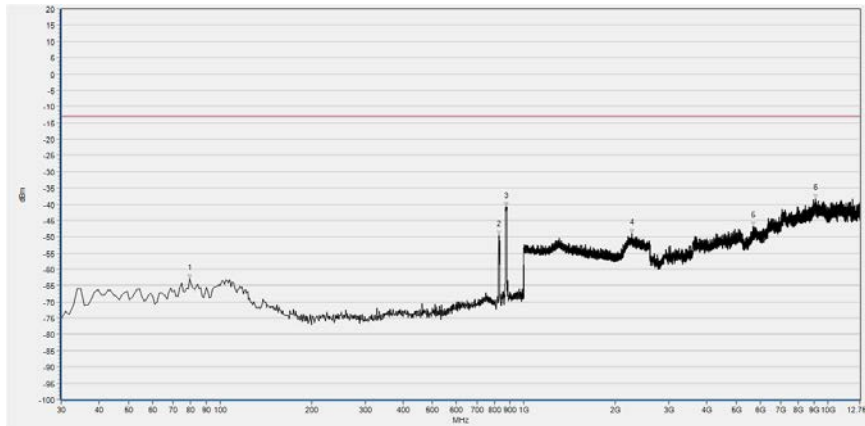

No.	Fre. (MHz)	Peak	Limit(PK)	Antenna	Verdict
1	79.470	-62.92	-13.00	Vertical	PASS
2	828.310	-49.43	-13.00	Vertical	NA
3	875.840	-40.79	-13.00	Vertical	NA
4	2271.549	-49.04	-13.00	Vertical	PASS
5	5684.315	-46.80	-13.00	Vertical	PASS
6	9102.719	-38.43	-13.00	Vertical	PASS

LTE Band 5 10MHz BW, Low Channel, QPSK

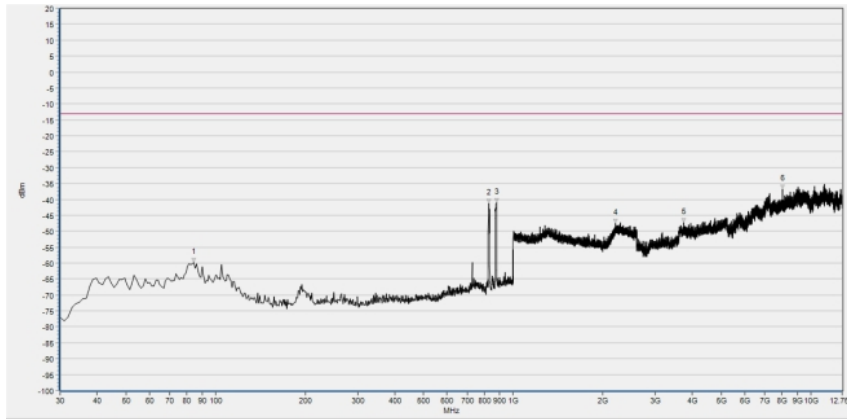

No.	Fre. (MHz)	Peak	Limit(PK)	Antenna	Verdict
1	84.320	-59.73	-13.00	Horizontal	PASS
2	827.340	-41.18	-13.00	Horizontal	N/A
3	877.780	-40.93	-13.00	Horizontal	N/A
4	2200.480	-47.52	-13.00	Horizontal	PASS
5	3731.469	-47.37	-13.00	Horizontal	PASS
6	8041.389	-36.72	-13.00	Horizontal	PASS

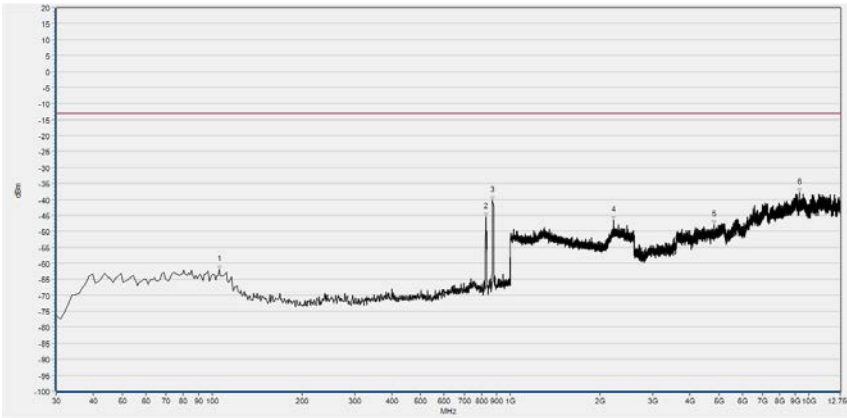

No.	Fre. (MHz)	Peak	Limit(PK)	Antenna	Verdict
1	95.960	-62.85	-13.00	Vertical	PASS
2	829.280	-51.04	-13.00	Vertical	N/A
3	870.020	-40.16	-13.00	Vertical	N/A
4	2377.191	-48.25	-13.00	Vertical	PASS
5	5759.993	-43.39	-13.00	Vertical	PASS
6	11208.765	-35.80	-13.00	Vertical	PASS

LTE Band 5 10MHz BW, Mid Channel, QPSK

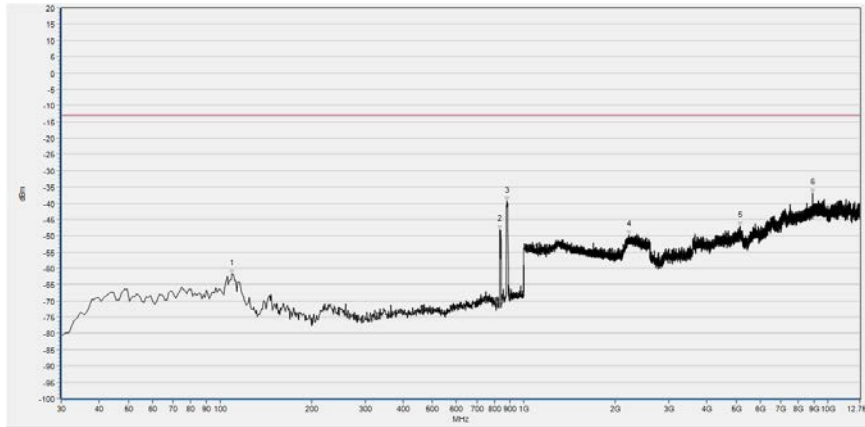

No.	Fre. (MHz)	Peak	Limit(PK)	Antenna	Verdict
1	109.540	-61.85	-13.00	Horizontal	PASS
2	834.130	-48.18	-13.00	Horizontal	NA
3	879.720	-39.53	-13.00	Horizontal	NA
4	2222.249	-49.82	-13.00	Horizontal	PASS
5	5150.882	-47.12	-13.00	Horizontal	PASS
6	8905.219	-37.04	-13.00	Horizontal	PASS

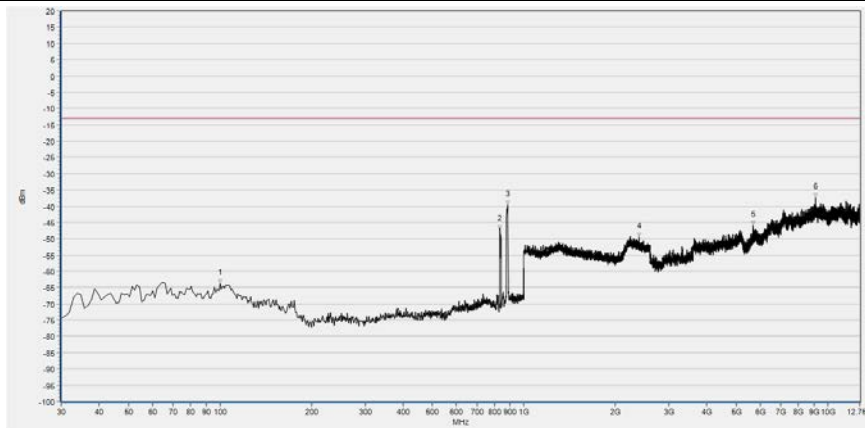

No.	Fre. (MHz)	Peak	Limit(PK)	Antenna	Verdict
1	99.840	-63.88	-13.00	Vertical	PASS
2	833.160	-47.35	-13.00	Vertical	NA
3	885.540	-39.65	-13.00	Vertical	NA
4	2398.319	-49.58	-13.00	Vertical	PASS
5	5684.315	-45.83	-13.00	Vertical	PASS
6	9093.490	-37.52	-13.00	Vertical	PASS



LTE Band 5 10MHz BW, High Channel, QPSK

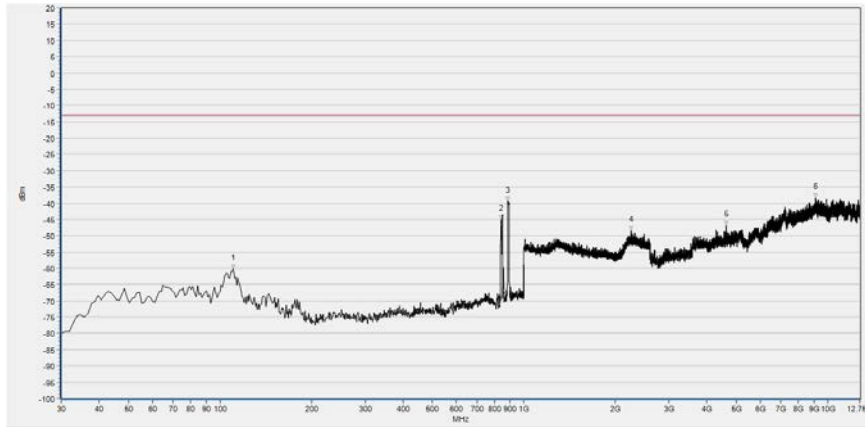

No.	Fre. (MHz)	Peak	Limit(PK)	Antenna	Verdict
1	110.510	-60.11	-13.00	Horizontal	PASS
2	842.860	-45.04	-13.00	Horizontal	NA
3	886.510	-39.36	-13.00	Horizontal	NA
4	2254.262	-48.49	-13.00	Horizontal	PASS
5	4635.907	-46.75	-13.00	Horizontal	PASS
6	9108.256	-38.37	-13.00	Horizontal	PASS



No.	Fre. (MHz)	Peak	Limit(PK)	Antenna	Verdict
1	80.440	-62.66	-13.00	Vertical	PASS
2	841.890	-51.99	-13.00	Vertical	NA
3	889.420	-38.14	-13.00	Vertical	NA
4	2273.469	-49.08	-13.00	Vertical	PASS
5	4423.641	-48.40	-13.00	Vertical	PASS
6	10952.200	-39.06	-13.00	Vertical	PASS

LTE Band 720MHz BW, Low Channel, QPSK

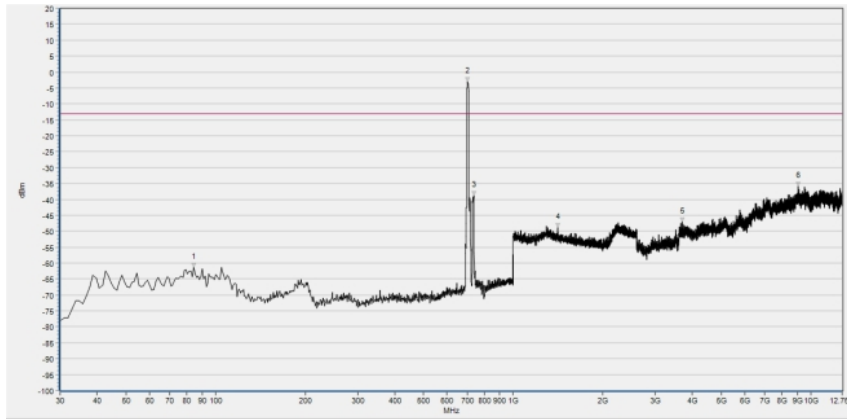

No.	Fre. (MHz)	Peak	Limit(PK)	Antenna	Verdict
1	84.320	-61.26	-13.00	Horizontal	PASS
2	703.180	-3.19	-13.00	Horizontal	N/A
3	738.100	-38.85	-13.00	Horizontal	N/A
4	1407.843	-48.84	-13.00	Horizontal	PASS
5	3703.783	-47.11	-13.00	Horizontal	PASS
6	9058.420	-35.95	-13.00	Horizontal	PASS

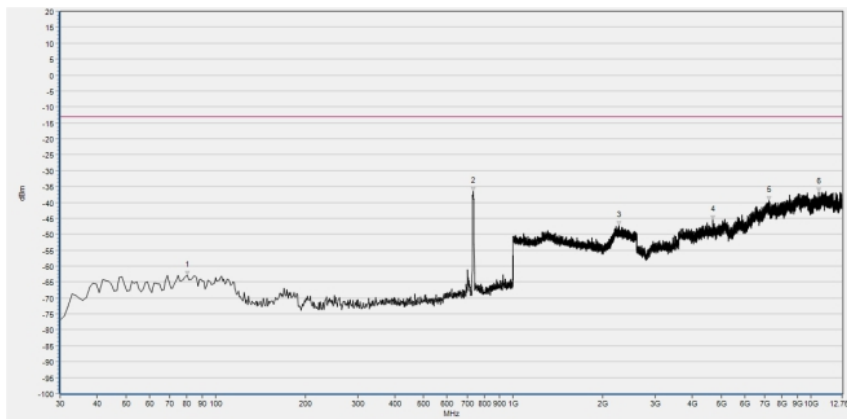

No.	Fre. (MHz)	Peak	Limit(PK)	Antenna	Verdict
1	80.440	-62.81	-13.00	Vertical	PASS
2	734.220	-36.64	-13.00	Vertical	N/A
3	2260.024	-47.33	-13.00	Vertical	PASS
4	4689.434	-45.39	-13.00	Vertical	PASS
5	7234.779	-39.38	-13.00	Vertical	PASS
6	10656.874	-36.85	-13.00	Vertical	PASS



LTE Band 720MHz BW, Mid Channel, QPSK

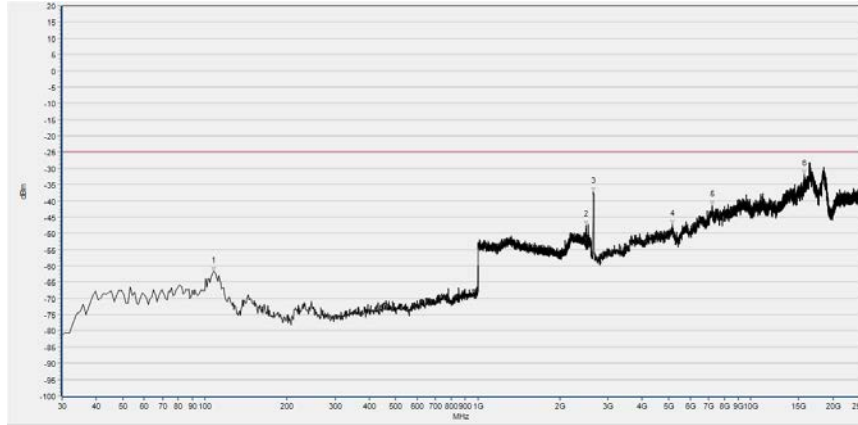

No.	Fre. (MHz)	Peak	Limit(PK)	Antenna	Verdict
1	107.600	-61.68	-13.00	Horizontal	PASS
2	2487.955	-47.57	-13.00	Horizontal	NA
3	2652.955	-37.11	-13.00	Horizontal	NA
4	5174.432	-47.34	-13.00	Horizontal	PASS
5	7247.827	-41.55	-13.00	Horizontal	PASS
6	15663.612	-31.93	-13.00	Horizontal	PASS

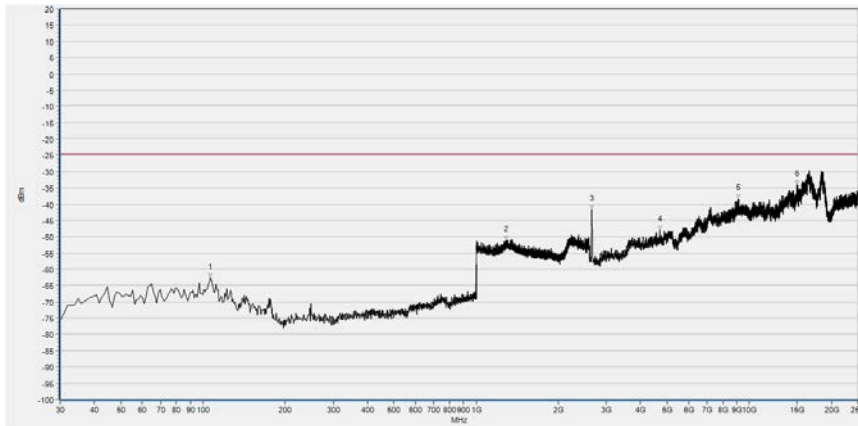

No.	Fre. (MHz)	Peak	Limit(PK)	Antenna	Verdict
1	106.630	-62.63	-13.00	Vertical	PASS
2	1286.194	-51.17	-13.00	Vertical	PASS
3	2648.882	-41.58	-13.00	Vertical	NA
4	4697.836	-47.92	-13.00	Vertical	PASS
5	9137.916	-38.22	-13.00	Vertical	PASS
6	14999.636	-34.18	-13.00	Vertical	PASS

LTE Band 720MHz BW, High Channel, QPSK

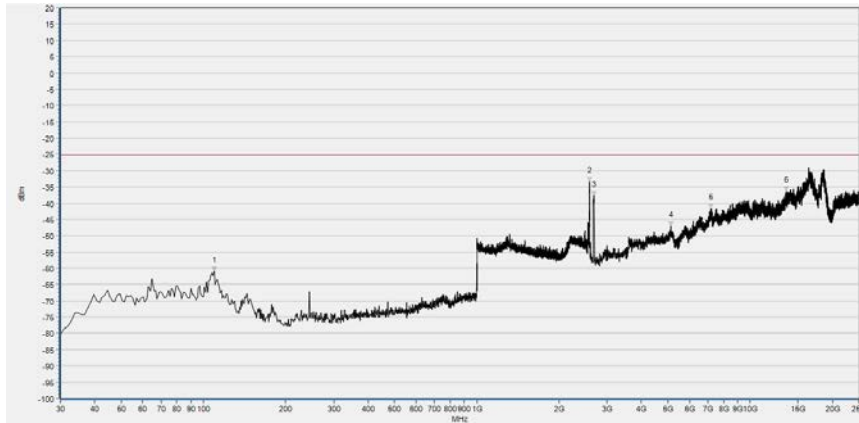

No.	Fre. (MHz)	Peak	Limit(PK)	Antenna	Verdict
1	109.540	-60.99	-13.00	Horizontal	PASS
2	2584.634	-33.30	-13.00	Horizontal	NA
3	2685.543	-37.60	-13.00	Horizontal	NA
4	5129.624	-46.95	-13.00	Horizontal	PASS
5	7190.798	-41.76	-13.00	Horizontal	PASS
6	13586.143	-36.25	-13.00	Horizontal	PASS

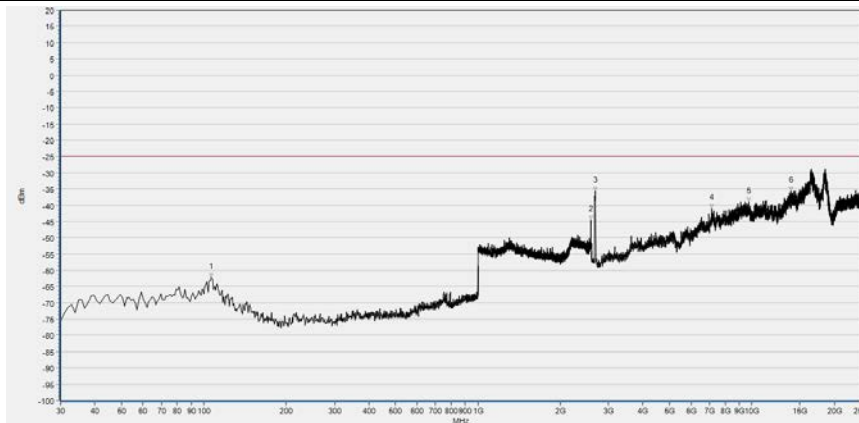

No.	Fre. (MHz)	Peak	Limit(PK)	Antenna	Verdict
1	106.630	-62.13	-13.00	Vertical	PASS
2	2582.713	-44.47	-13.00	Vertical	NA
3	2681.469	-35.68	-13.00	Vertical	NA
4	7158.211	-40.98	-13.00	Vertical	PASS
5	9740.789	-39.10	-13.00	Vertical	PASS
6	13895.726	-35.55	-13.00	Vertical	PASS



Annex A Test Uncertainty

Where relevant, the following measurement uncertainty levels have been estimated for test performed on the EUT as specified in CISPR 16-1-2:

Test items	Uncertainty
Output Power	± 2.22 dB
Bandwidth	$\pm 5\%$
Conducted Spurious Emission	± 2.77 dB
Band Edge	± 2.77 dB
Equivalent Isotropic Radiated Power	± 2.22 dB
Radiated Spurious Emissions	± 6 dB

This uncertainty represent an expanded uncertainty expressed at approximately the 95% confidence level using a coverage factor of $k=2$



Annex B Testing Laboratory Information

1. Identification of the Responsible Testing Laboratory

Company Name:	Shenzhen Morlab Communications Technology Co., Ltd.
Department:	Morlab Laboratory
Address:	FL.3, Building A, FeiYang Science Park, No.8 LongChang Road, Block 67, BaoAn District, ShenZhen, GuangDong Province, P. R. China
Responsible Test Lab Manager:	Mr. Su Feng
Telephone:	+86 755 36698555
Facsimile:	+86 755 36698525

2. Identification of the Responsible Testing Location

Name:	Shenzhen Morlab Communications Technology Co., Ltd. Morlab Laboratory
Address:	FL.3, Building A, FeiYang Science Park, No.8 LongChang Road, Block 67, BaoAn District, ShenZhen, GuangDong Province, P. R. China

3. Facilities and Accreditations

All measurement facilities used to collect the measurement data are located at FL.3, Building A, FeiYang Science Park, Block 67, BaoAn District, Shenzhen, 518101 P. R. China. The test site is constructed in conformance with the requirements of ANSI C63.10-2013 and CISPR Publication 22; the FCC designation number is CN1192, the test firm registration number is 226174.



4. Test Equipments Utilized

4.1 Conducted Test Equipments

Equipment Name	Serial No.	Type	Manufacturer	Cal. Date	Cal. Due
Power Splitter	NW521	1506A	Weinschel	2019.04.16	2020.04.15
Attenuator 1	(N/A.)	10dB	Resnet	2019.04.16	2020.04.15
Attenuator 2	(N/A.)	3dB	Resnet	2019.04.16	2020.04.15
EXA Signal Analyzer	MY53470836	N9010A	Agilent	2018.11.06	2019.11.05
USB Power Sensor	MY54210011	U2021XA	Agilent	2019.04.16	2019.04.15
System Simulator	152038	CMW500	R&S	2019.05.08	2020.05.07
RF cable (30MHz-26GHz)	CB01	RF01	Morlab	N/A	N/A
Coaxial cable	CB02	RF02	Morlab	N/A	N/A
SMA connector	CN01	RF03	HUBER-SUHNER	N/A	N/A
Temperature Chamber	(N/A)	HUT705P	CHONGQING HANBA EXPERIMENTAL EQUIPMENT CO.,LTD	2019.04.16	2020.04.15
Computer	T430i	Think Pad	Lenovo	N/A	N/A

**4.2 Radiated Test Equipments**

Equipment Name	Serial No.	Type	Manufacturer	Cal. Date	Cal.Due
System Simulator	152038	CMW500	R&S	2019.05.08	2020.05.07
Receiver	MY54130016	N9038A	Agilent	2019.05.18	2020.05.17
Test Antenna - Bi-Log	9163-519	VULB 9163	Schwarzbeck	2019.05.18	2020.05.17
Test Antenna - Horn	9170C-531	BBHA9170	Schwarzbeck	2019.08.06	2020.08.05
Test Antenna - Horn	01774	BBHA 9120D	Schwarzbeck	2019.08.02	2020.08.01
Coaxial cable (N male) (9KHz-30MHz)	CB04	EMC04	Morlab	N/A	N/A
Coaxial cable (N male) (30MHz-26GHz)	CB02	EMC02	Morlab	N/A	N/A
Coaxial cable(N male) (30MHz-26GHz)	CB03	EMC03	Morlab	N/A	N/A
1-18GHz pre-Amplifier	MA02	TS-PR18	Rohde& Schwarz	2019.05.08	2020.05.07
18-26.5GHz pre-Amplifier	MA03	TS-PR18	Rohde& Schwarz	2019.05.08	2020.05.07
Notch Filter	N/A	WRCGV -LTE B2	Wainwright	2018.12.01	2019.11.30
Notch Filter	N/A	WRCGV -LTE B4	Wainwright	2018.12.01	2019.11.30
Notch Filter	N/A	WRCGV -LTE B5	Wainwright	2018.12.01	2019.11.30
Notch Filter	N/A	WRCGV -LTE B7	Wainwright	2018.12.01	2019.11.30
Notch Filter	N/A	WRCGV -LTE B12	Wainwright	2018.12.01	2019.11.30
Notch Filter	N/A	WRCGV -LTE B17	Wainwright	2018.12.01	2019.11.30
Notch Filter	N/A	WRCGV -LTE B25	Wainwright	2018.12.01	2019.11.30



Equipment Name	Serial No.	Type	Manufacturer	Cal. Date	Cal.Due
Notch Filter	N/A	WRCGV -LTE B26	Wainwright	2018.12.01	2019.11.30
Notch Filter	N/A	WRCGV -LTE B41	Wainwright	2018.12.01	2019.11.30
Anechoic Chamber	N/A	9m*6m*6m	CRT	2017.11.19	2020.11.18

————— END OF REPORT —————