

6

5

4

3

2

1

REVISION RECORD			
LTR	ECO NO:	APPROVED:	DATE:

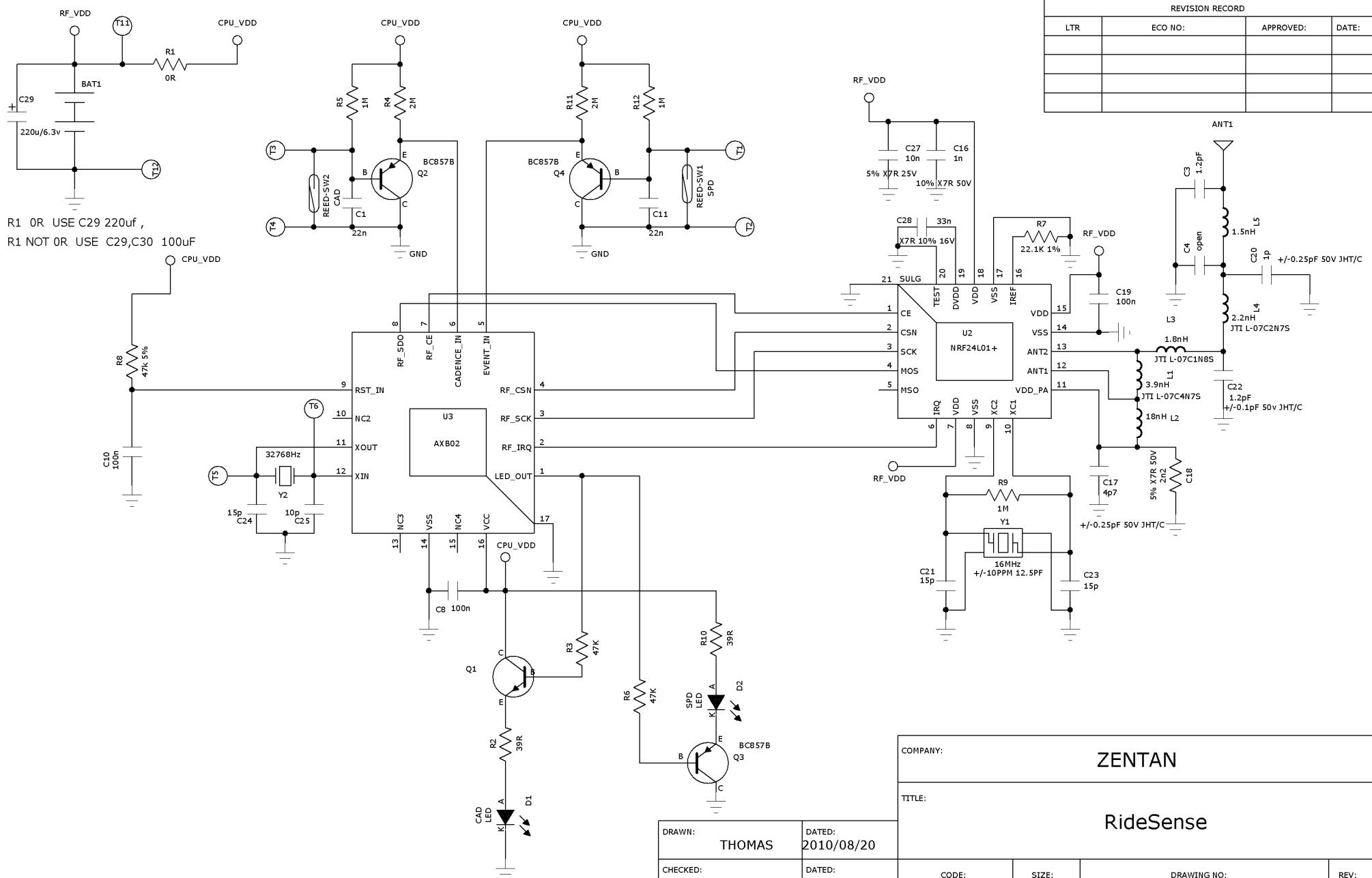

COMPANY: ZENTAN			
TITLE: RideSense			
DRAWN: THOMAS	DATED: 2010/08/20	CODE:	SIZE:
CHECKED: <Checked By>	DATED: <Checked Date>	DRAWING NO:	
QUALITY CONTROL: <QC By>	DATED: <QC Date>	<Code>	A3<Drawing Number>
RELEASED: <Released By>	DATED: <Release Date>	SCALE: <Scale>	REV: 1.2
SHEET: 1 of 1			1

RideSense-01A3

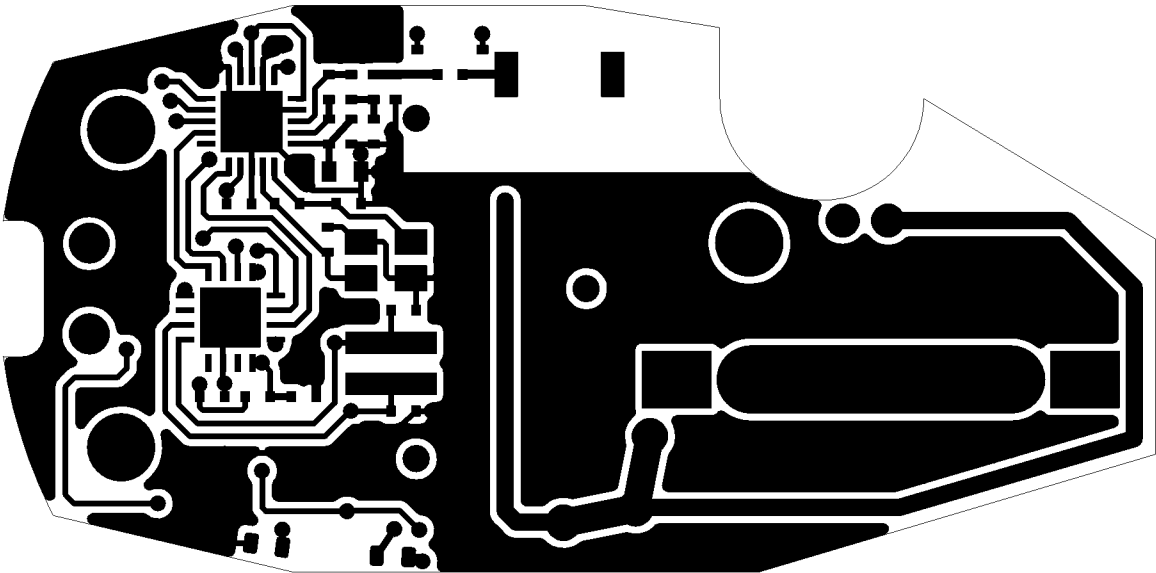

#COMP SIDE

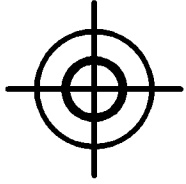

Ridesense-01A3

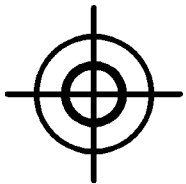
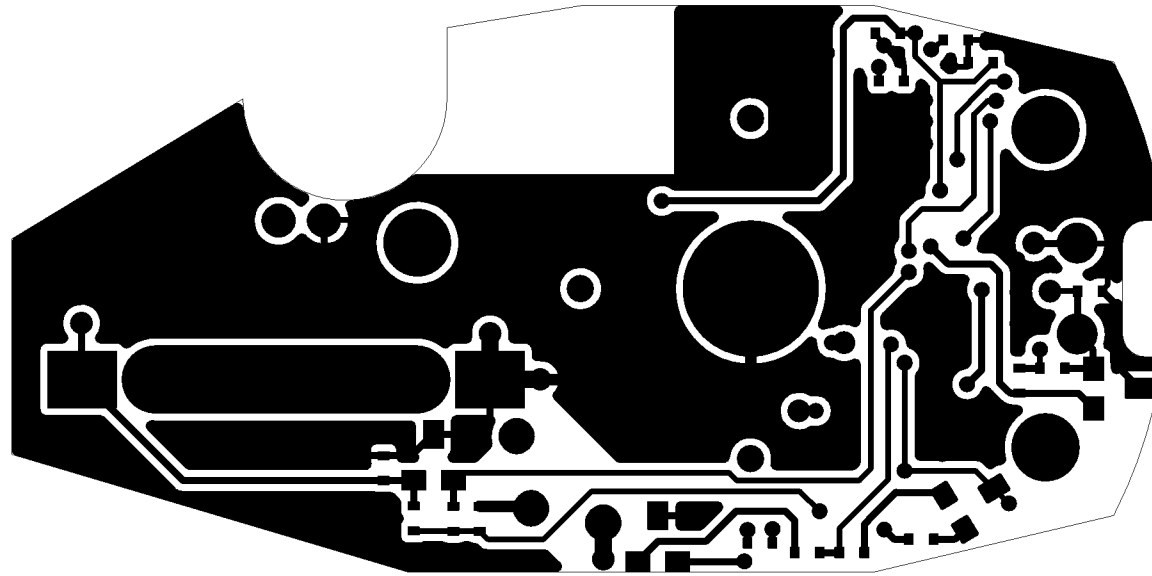
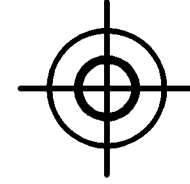

#SOLD SIDE

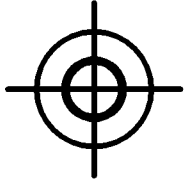

# RideSense-01A3

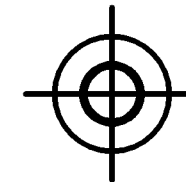
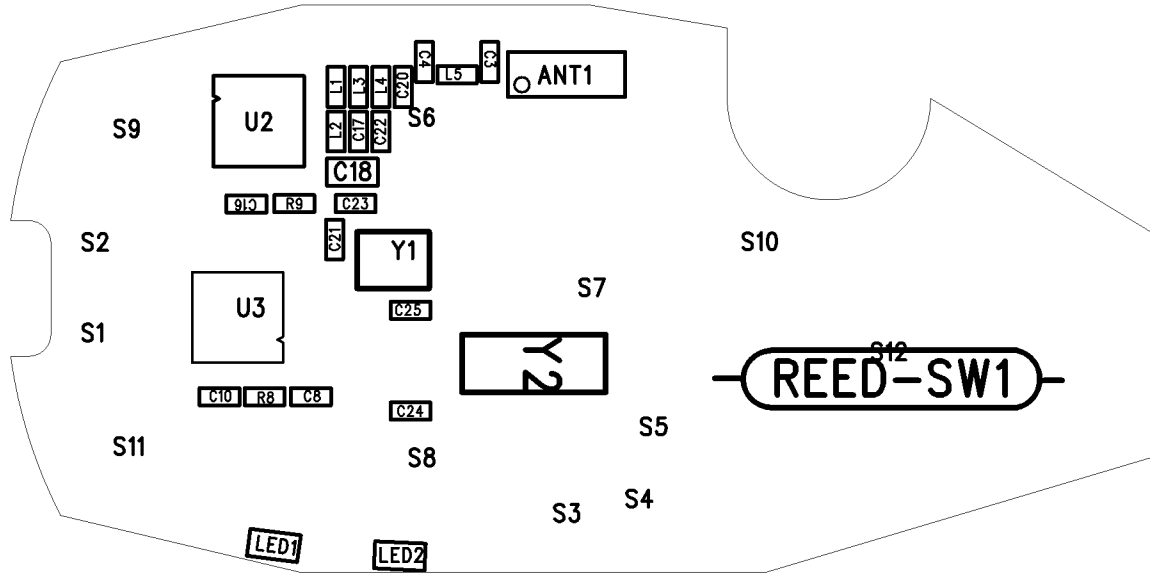
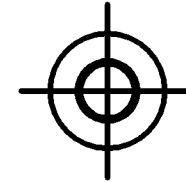

#COMP SILK

RibSense-01A3

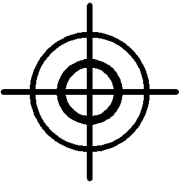
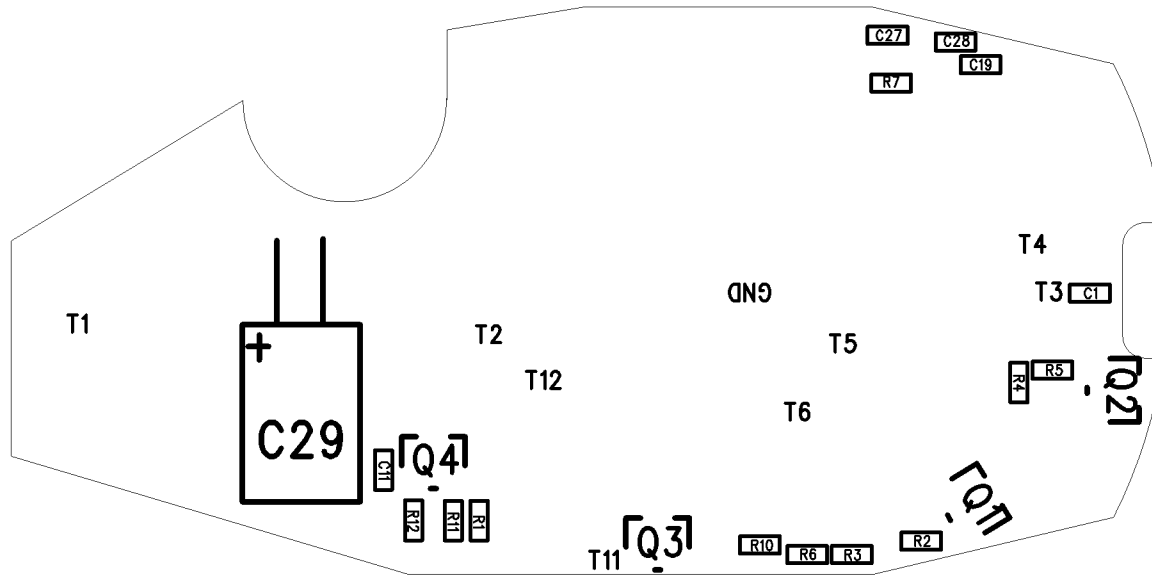
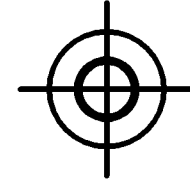
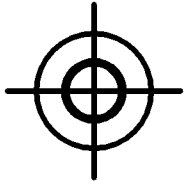

#SOLD SILK