

**FCC 47 CFR PART 15 SUBPART C**

**TEST REPORT**

**For**

**Bicycle Power Meter**

**Model Number: Power Pro-R, Power Pro-L**

**Trade Name: GIANT**

*Issued to*

**Giant Manufacturing Co., Ltd.**  
**No.19, Shunfan Rd., Dajia Dist., Taichung City 437, Taiwan (R.O.C.)**

*Issued by*

**Compliance Certification Services Inc.**  
**Wugu Laboratory**  
**No.11, Wugong 6th Rd., Wugu Dist.,**  
**New Taipei City 24891, Taiwan. (R.O.C.)**  
**<http://www.ccsrf.com>**  
**Issued Date: March 21, 2018**



---

**Note:** This report shall not be reproduced except in full, without the written approval of Compliance Certification Services Inc. This document may be altered or revised by Compliance Certification Services Inc. personnel only, and shall be noted in the revision section of the document.

**Revision History**

Rev.	Issue Date	Revisions	Effect Page	Revised By
00	March 21, 2018	Initial Issue	ALL	Doris Chu
01	May 7, 2018	1. Add loop antenna. 2. Remove KDB 558074.	P.11, P.15	Doris Chu

## TABLE OF CONTENTS

<b>1. TEST RESULT CERTIFICATION</b> .....	<b>4</b>
<b>2. TEST SUMMERY</b> .....	<b>5</b>
<b>3. EUT DESCRIPTION</b> .....	<b>6</b>
<b>4. TEST METHODOLOGY</b> .....	<b>8</b>
4.1 EUT CONFIGURATION .....	8
4.2 DESCRIPTION OF TEST MODES .....	8
4.3 THE WORST MODE OF MEASUREMENT .....	9
4.4 FCC PART 15.205 RESTRICTED BANDS OF OPERATIONS .....	10
<b>5. INSTRUMENT CALIBRATION</b> .....	<b>11</b>
5.1 MEASURING INSTRUMENT CALIBRATION .....	11
5.2 MEASUREMENT EQUIPMENT USED .....	11
5.3 MEASUREMENT UNCERTAINTY .....	12
<b>6. FACILITIES AND ACCREDITATIONS</b> .....	<b>13</b>
6.1 FACILITIES .....	13
6.2 EQUIPMENT .....	13
<b>7. SETUP OF EQUIPMENT UNDER TEST</b> .....	<b>14</b>
7.1 SETUP CONFIGURATION OF EUT .....	14
7.2 SUPPORT EQUIPMENT .....	14
<b>8. FCC PART 15.249 REQUIREMENTS</b> .....	<b>15</b>
8.1 20DB BANDWIDTH AND OCCUPIED BANDWIDTH(99%) .....	15
8.2 BAND EDGES AND FUNDAMENTAL MEASUREMENT .....	20
8.3 SPURIOUS EMISSION .....	29
8.4 POWERLINE CONDUCTED EMISSIONS .....	41
<b>APPENDIX I PHOTOGRAPHS OF TEST SETUP</b> .....	<b>43</b>
<b>APPENDIX 1 - PHOTOGRAPHS OF EUT</b>	

## 1. TEST RESULT CERTIFICATION

**Applicant:** Giant Manufacturing Co., Ltd.  
No.19, Shunfan Rd., Dajia Dist., Taichung City 437, Taiwan  
(R.O.C.)

**Manufacturer:** Giant Manufacturing Co., Ltd.  
No.19, Shunfan Rd., Dajia Dist., Taichung City 437, Taiwan  
(R.O.C.)

**Equipment Under Test:** Bicycle Power Meter

**Trade Name:** GIANT

**Model Number:** Power Pro-R, Power Pro-L

**Date of Test:** March 1 ~ 16, 2018

APPLICABLE STANDARDS	
STANDARD	TEST RESULT
FCC 47 CFR Part 15 Subpart C	No non-compliance noted

### We hereby certify that:

The test Result was tested by Compliance Certification Services Inc. The test data, data evaluation, test procedures, and equipment configurations shown in this report were given in ANSI C63.10: 2013 and compliance standards.

The test results of this report relate only to the tested sample (EUT) identified in this report. The test Report of full or partial shall not copy. Without written approval of CCS. Inc. The sample selected for test was production product and was provided by manufacturer.

Approved by:



---

Sam Chuang  
Manager  
Compliance Certification Services Inc.

Tested by:



---

Jerry Chuang  
Engineer  
Compliance Certification Services Inc.

## 2. TEST SUMMERY

<b>FCC Standard Section</b>	<b>Report Section</b>	<b>Test Item</b>	<b>Result</b>
15.203	3	Antenna Requirement	Pass
2.1049	8.1	20 dB Bandwidth	Pass
-	8.1	Occupied Bandwidth (99%)	Pass
15.209 15.249(a)	8.2	Band Edge and Fundamental measurement	Pass
15.249(a)	8.3	Radiation Spurious Emission	Pass
15.207(a)	8.4	Powerline Conducted Emission	N/A

### 3. EUT DESCRIPTION

<b>Product</b>	Bicycle Power Meter
<b>Trade Name</b>	GIANT
<b>Model Number</b>	Power Pro-R, Power Pro-L
<b>Model Discrepancy</b>	The two models use the same module, the difference for the fix location
<b>Received Date</b>	December 22, 2017
<b>Power Supply</b>	Power from DC Battery (DC3.7V)

	2401 ~ 2480MHz			
	Channel	Frequency (MHz)	Channel	Frequency (MHz)
<b>Frequency Range</b>	1	2401	41	2441
	2	2402	42	2442
	3	2403	43	2443
	4	2404	44	2444
	5	2405	45	2445
	6	2406	46	2446
	7	2407	47	2447
	8	2408	48	2448
	9	2409	49	2449
	10	2410	50	2450
	11	2411	51	2451
	12	2412	52	2452
	13	2413	53	2453
	14	2414	54	2454
	15	2415	55	2455
	16	2416	56	2456
	17	2417	57	2457
	18	2418	58	2458
	19	2419	59	2459
	20	2420	60	2460
	21	2421	61	2461
	22	2422	62	2462
	23	2423	63	2463
	24	2424	64	2464
	25	2425	65	2465
	26	2426	66	2466
	27	2427	67	2467
	28	2428	68	2468
	29	2429	69	2469
	30	2430	70	2470
	31	2431	71	2471
	32	2432	72	2472
	33	2433	73	2473
	34	2434	74	2474
	35	2435	75	2475
	36	2436	76	2476
	37	2437	77	2477
	38	2438	78	2478
	39	2439	79	2479
	40	2440	80	2480
<b>Modulation Technique</b>	GFSK			
<b>Antenna Gain</b>	Gain: 0 dBi			
<b>Antenna Designation</b>	PCB Antenna			
<b>Antenna Brand</b>	WUSA			
<b>Antenna Model</b>	PCB Layout printed			

**Remark:**

1. The sample selected for test was production product and was provided by manufacturer.

## **4. TEST METHODOLOGY**

The test methodology, setups and results comply with all requirements in accordance with ANSI C63.10:2013, FCC Part 2, FCC Part 15.249.

### **4.1 EUT CONFIGURATION**

The EUT configuration for testing is installed on RF field strength measurement to meet the Commissions requirement and operating in a manner that intends to maximize its emission characteristics in a continuous normal application.

### **4.2 DESCRIPTION OF TEST MODES**

The EUT (model: Power Pro-L) had been tested under operating condition.

Channel Low (2401MHz), Channel Mid (2440MHz) and Channel High (2480MHz) were chosen for the final testing.



### 4.3 THE WORST MODE OF MEASUREMENT

AC Power Line Conducted Emission	
Test Condition	AC Power line conducted emission for line and neutral
Voltage/Hz	DC 3.7V
Test Mode	Mode 1:EUT power by host system.
Worst Mode	<input checked="" type="checkbox"/> Mode 1 <input type="checkbox"/> Mode 2 <input type="checkbox"/> Mode 3 <input type="checkbox"/> Mode 4

Radiated Emission Measurement Above 1G	
Test Condition	Band edge, Emission for Unwanted and Fundamental
Voltage/Hz	DC 3.7V
Test Mode	Mode 1:EUT power by host system.
Worst Mode	<input checked="" type="checkbox"/> Mode 1 <input type="checkbox"/> Mode 2 <input type="checkbox"/> Mode 3 <input type="checkbox"/> Mode 4
Worst Position	<input type="checkbox"/> Placed in fixed position. <input checked="" type="checkbox"/> Placed in fixed position at X-Plane (E2-Plane) <input type="checkbox"/> Placed in fixed position at Y-Plane (E1-Plane) <input type="checkbox"/> Placed in fixed position at Z-Plane (H-Plane)
Worst Polarity	<input checked="" type="checkbox"/> Horizontal <input type="checkbox"/> Vertical

Radiated Emission Measurement Below 1G	
Test Condition	Radiated Emission Below 1G
Voltage/Hz	DC 3.7V
Test Mode	Mode 1:EUT power by host system.
Worst Mode	<input checked="" type="checkbox"/> Mode 1 <input type="checkbox"/> Mode 2 <input type="checkbox"/> Mode 3 <input type="checkbox"/> Mode 4

*Remark:*

1. The worst mode was record in this test report.
2. EUT pre-scanned in three axis ,X, Y, Z and two polarity, Horizontal and Vertical for radiated measurement. The worst case(X-Plane and Horizontal) were recorded in this report
3. For below 1G, AC power line conducted emission and radiation emission were performed the EUT transmit at the highest output power channel as worse case.

#### 4.4 FCC PART 15.205 RESTRICTED BANDS OF OPERATIONS

(a) Except as shown in paragraph (d) of this section, only spurious emissions are permitted in any of the frequency bands listed below:

MHz	MHz	MHz	GHz
0.090 - 0.110	16.42 - 16.423	399.9 - 410	4.5 - 5.15
<sup>1</sup> 0.495 - 0.505	16.69475 - 16.69525	608 - 614	5.35 - 5.46
2.1735 - 2.1905	16.80425 - 16.80475	960 - 1240	7.25 - 7.75
4.125 - 4.128	25.5 - 25.67	1300 - 1427	8.025 - 8.5
4.17725 - 4.17775	37.5 - 38.25	1435 - 1626.5	9.0 - 9.2
4.20725 - 4.20775	73 - 74.6	1645.5 - 1646.5	9.3 - 9.5
6.215 - 6.218	74.8 - 75.2	1660 - 1710	10.6 - 12.7
6.26775 - 6.26825	108 - 121.94	1718.8 - 1722.2	13.25 - 13.4
6.31175 - 6.31225	123 - 138	2200 - 2300	14.47 - 14.5
8.291 - 8.294	149.9 - 150.05	2310 - 2390	15.35 - 16.2
8.362 - 8.366	156.52475 -	2483.5 - 2500	17.7 - 21.4
8.37625 - 8.38675	156.52525	2655 - 2900	22.01 - 23.12
8.41425 - 8.41475	156.7 - 156.9	3260 - 3267	23.6 - 24.0
12.29 - 12.293	162.0125 - 167.17	3332 - 3339	31.2 - 31.8
12.51975 - 12.52025	167.72 - 173.2	3345.8 - 3358	36.43 - 36.5
12.57675 - 12.57725	240 - 285	3600 - 4400	( <sup>2</sup> )
13.36 - 13.41	322 - 335.4		

<sup>1</sup> Until February 1, 1999, this restricted band shall be 0.490-0.510 MHz.

<sup>2</sup> Above 38.6

(b) Except as provided in paragraphs (d) and (e), the field strength of emissions appearing within these frequency bands shall not exceed the limits shown in Section 15.209. At frequencies equal to or less than 1000 MHz, compliance with the limits in Section 15.209 shall be demonstrated using measurement instrumentation employing a CISPR quasi-peak detector. Above 1000 MHz, compliance with the emission limits in Section 15.209 shall be demonstrated based on the average value of the measured emissions. The provisions in Section 15.35 apply to these measurements.

## 5. INSTRUMENT CALIBRATION

### 5.1 MEASURING INSTRUMENT CALIBRATION

The measuring equipment, which was utilized in performing the tests documented herein, has been calibrated in accordance with the manufacturer's recommendations for utilizing calibration equipment, which is traceable to recognized national standards.

### 5.2 MEASUREMENT EQUIPMENT USED

#### Equipment Used for Emissions Measurement

*Remark: Each piece of equipment is scheduled for calibration once a year*

Wugu 966 Chamber A					
Name of Equipment	Manufacturer	Model	Serial Number	Calibration Date	Calibration Due
Bilog Antenna	Sunol Sciences	JB3	A030105	06/20/2017	06/19/2018
Horn Antenna	ETC	MCTD 1209	DRH13M02003	08/25/2017	08/24/2018
Pre-Amplifier	EMEC	EM330	60609	06/07/2017	06/06/2018
Spectrum Analyzer	Agilent	E4446A	US42510252	11/27/2017	11/26/2018
Loop Ant	COM-POWER	AL-130	121051	03/21/2018	03/20/2019
Antenna Tower	CCS	CC-A-1F	N/A	N.C.R	N.C.R
Controller	CCS	CC-C-1F	N/A	N.C.R	N.C.R
Turn Table	CCS	CC-T-1F	N/A	N.C.R	N.C.R
Pre-Amplifier	HP	8449B	3008A00965	06/27/2017	06/26/2018
Filter	N/A	2400-2500	N/A	N/A	N/A
Cable	HUBER SUHNER	SUCOFLEX 104PEA	25157	07/31/2017	07/30/2018
Cable	HUBER SUHNER	SUCOFLEX 104PEA	20995	07/31/2017	07/30/2018

RF Conducted Test Site					
Name of Equipment	Manufacturer	Model	Serial Number	Calibration Date	Calibration Due
Power Meter	Anritsu	ML2495A	1012009	07/03/2017	07/02/2018
Power Sensor	Anritsu	MA2411B	917072	07/03/2017	07/02/2018
Spectrum Analyzer	R&S	FSV 40	101073	10/02/2017	10/01/2018
Directional Coupler	Agilent	87301D	MY44350252	07/25/2017	07/24/2018
SUCOFLEX Cable	HUBER SUHNER	SUCOFLEX 104PEA	25157	07/31/2017	07/30/2018
Divider	Solvang Technology	2-18GHz 4Way	STI08-0015	07/26/2017	07/25/2018

Conducted Emission Room #B					
Name of Equipment	Manufacturer	Model	Serial Number	Calibration Date	Calibration Due
N/A					

**Remark:**

1. Each piece of equipment is scheduled for calibration once a year and Precision Dipole is scheduled for calibration once three years.
2. N.C.R. = No Calibration Request.

### 5.3 MEASUREMENT UNCERTAINTY

PARAMETER	UNCERTAINTY
AC Powerline Conducted Emission	+/- 1.2575
Emission bandwidth, 20dB bandwidth	+/- 1.4003
RF output power, conducted	+/- 1.1372
Power density, conducted	+/- 1.4003
3M Semi Anechoic Chamber / 30M~200M	+/- 4.0138
3M Semi Anechoic Chamber / 200M~1000M	+/- 3.9483
3M Semi Anechoic Chamber / 1G~8G	+/- 2.5975
3M Semi Anechoic Chamber / 8G~18G	+/- 2.6112
3M Semi Anechoic Chamber / 18G~26G	+/- 2.7389
3M Semi Anechoic Chamber / 26G~40G	+/- 2.9683
3M Semi Anechoic Chamber / 40G~60G	+/- 1.8509
3M Semi Anechoic Chamber / 60G~75G	+/- 1.9869
3M Semi Anechoic Chamber / 75G~110G	+/- 2.9651
3M Semi Anechoic Chamber / 110G~170G	+/- 2.7807
3M Semi Anechoic Chamber / 170G~220G	+/- 3.6437
3M Semi Anechoic Chamber / 220G~325G	+/- 4.2982

**Remark:**

1. This uncertainty represents an expanded uncertainty expressed at approximately the 95% confidence level using a coverage factor of  $k=2$
2. ISO/IEC 17025 requires that an estimate of the measurement uncertainties associated with the emissions test results be included in the report.

## **6. FACILITIES AND ACCREDITATIONS**

### **6.1 FACILITIES**

All measurement facilities used to collect the measurement data are located at

No.199, Chunghsen Road, Hsintien City, Taipei Hsien, Taiwan, R.O.C.

Tel: 886-2-2217-0894 / Fax: 886-2-2217-1029

No.11, Wugong 6th Rd., Wugu Dist., New Taipei City 24891, Taiwan. (R.O.C.)

Tel: 886-2-2299-9720 / Fax: 886-2-2298-4045

The sites are constructed in conformance with the requirements of ANSI C63.7, ANSI C63.4 and CISPR Publication 22.

### **6.2 EQUIPMENT**

Radiated emissions are measured with one or more of the following types of linearly polarized antennas: tuned dipole, biconical, log periodic, bi-log, and/or ridged waveguide, horn. Spectrum analyzers with pre-selectors and quasi-peak detectors are used to perform radiated measurements.

Conducted emissions are measured with Line Impedance Stabilization Networks and EMI Test Receivers.

Calibrated wideband preamplifiers, coaxial cables, and coaxial attenuators are also used for making measurements.

All receiving equipment conforms to CISPR Publication 16-1, "Radio Interference Measuring Apparatus and Measurement Methods."

## 7. SETUP OF EQUIPMENT UNDER TEST

### 7.1 SETUP CONFIGURATION OF EUT

See test photographs attached in Appendix I for the actual connections between EUT and support equipment.

### 7.2 SUPPORT EQUIPMENT

No	Device Type	Brand	Model	Series No.	FCC ID
1	NB(K)	Toshiba	voyager	ZD 154034s	N/A

**Remark:**

1. *All the equipment/cables were placed in the worst-case configuration to maximize the emission during the test.*
2. *Grounding was established in accordance with the manufacturer's requirements and conditions for the intended use.*

## 8. FCC PART 15.249 REQUIREMENTS

### 8.1 20DB BANDWIDTH AND OCCUPIED BANDWIDTH(99%)

#### LIMIT

**20 dB Bandwidth** : For reporting purposes only.

**Occupied Bandwidth(99%)** : For reporting purposes only.

#### Test Configuration

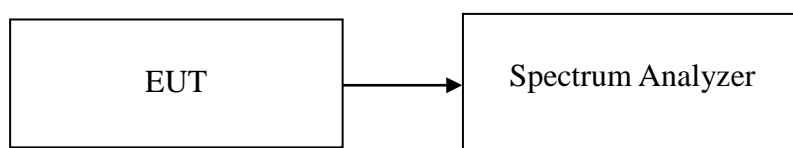

#### TEST PROCEDURE

Test method Refer as ANSI 63.10:2013 clause 6.9.2

1. The EUT RF output connected to the spectrum analyzer by RF cable.
2. Setting maximum power transmit of EUT
3. SA set RBW = 100kHz, VBW = 300kHz and Detector = Peak, to measurement 20 dB Bandwidth.
4. SA set RBW = 1% ~ 5% OBW, VBW = three times the RBW and Detector = Peak, to measurement 99% Bandwidth
5. Measure and record the result of 20 dB Bandwidth and 99% Bandwidth. in the test report.

#### TEST RESULTS

*No non-compliance noted*

#### Test Data

Test mode: ANT+ mode / 2401 ~ 2480MHz			
Channel	Frequency (MHz)	OBW(99%) (MHz)	20dB BW (MHz)
Low	2401	0.3820	0.7410
Mid	2440	0.3820	1.1317
High	2480	0.3936	1.1230

**Test Plot**

**20dB BW(MHz)**

**CH Low**

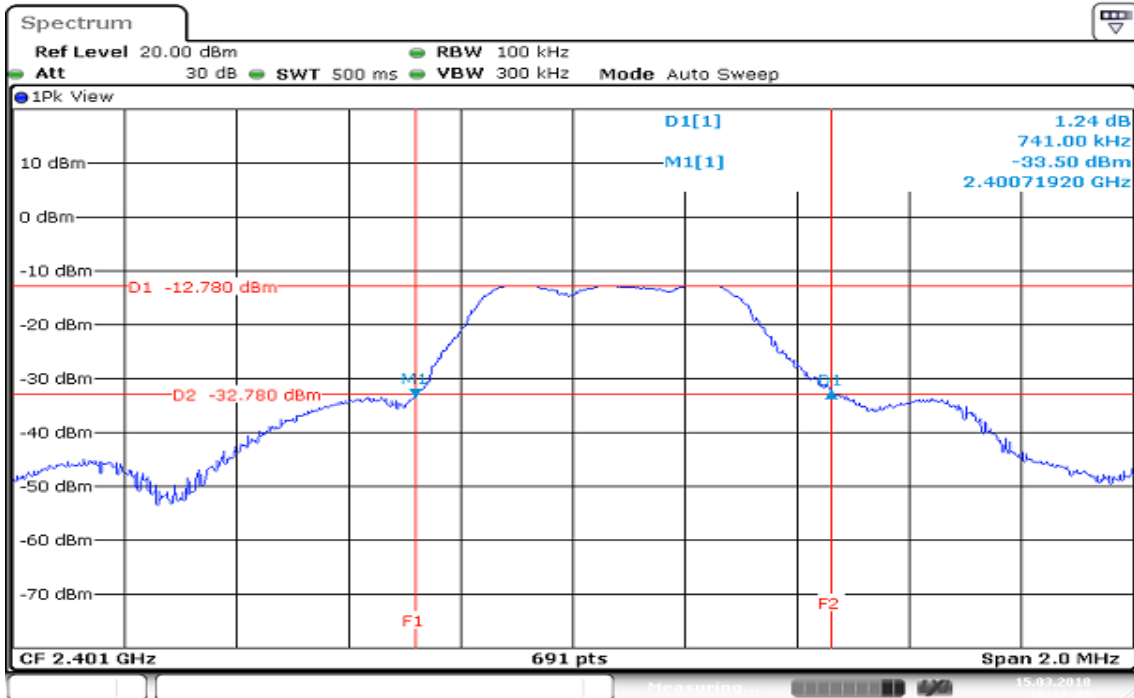

Date: 15 MAR 2018 10:12:45

**CH Mid**

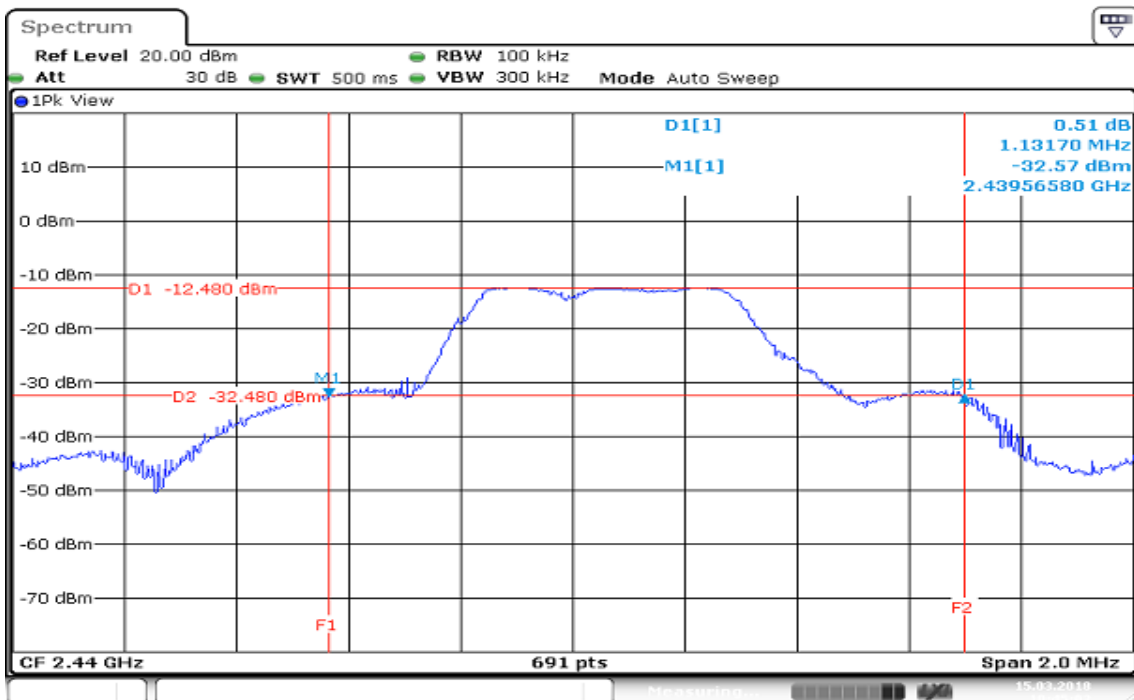

Date: 15 MAR 2018 10:45:04



### CH High

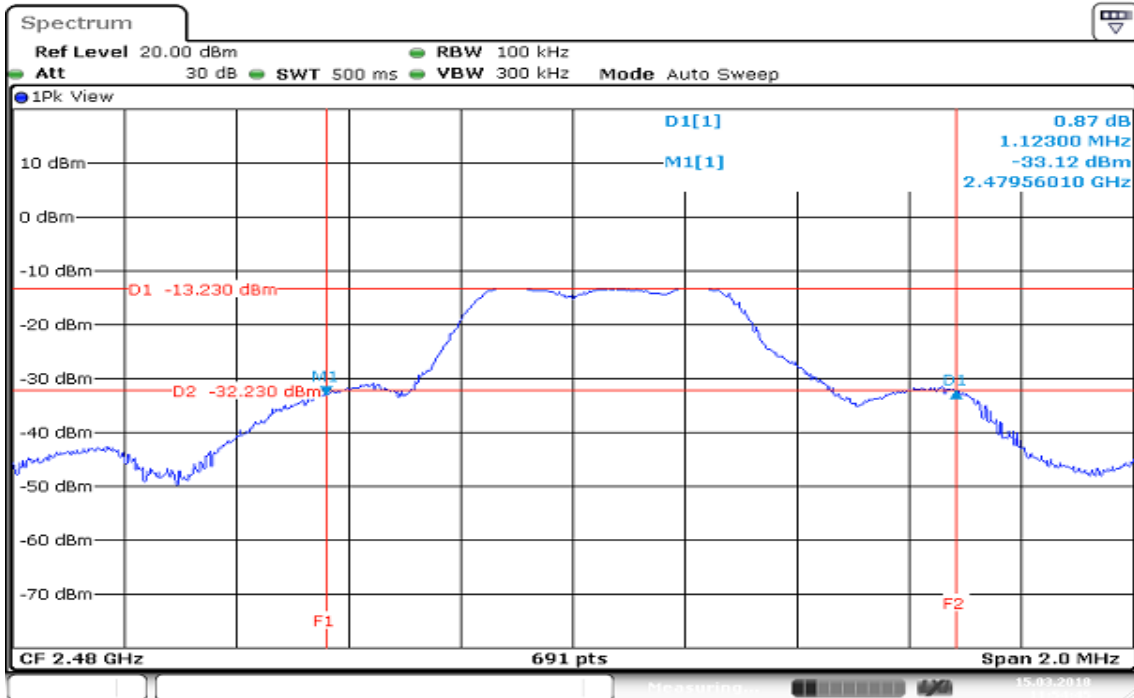

Date: 15 MAR 2018 11:54:45

**OBW(99%) (MHz)**

**CH Low**

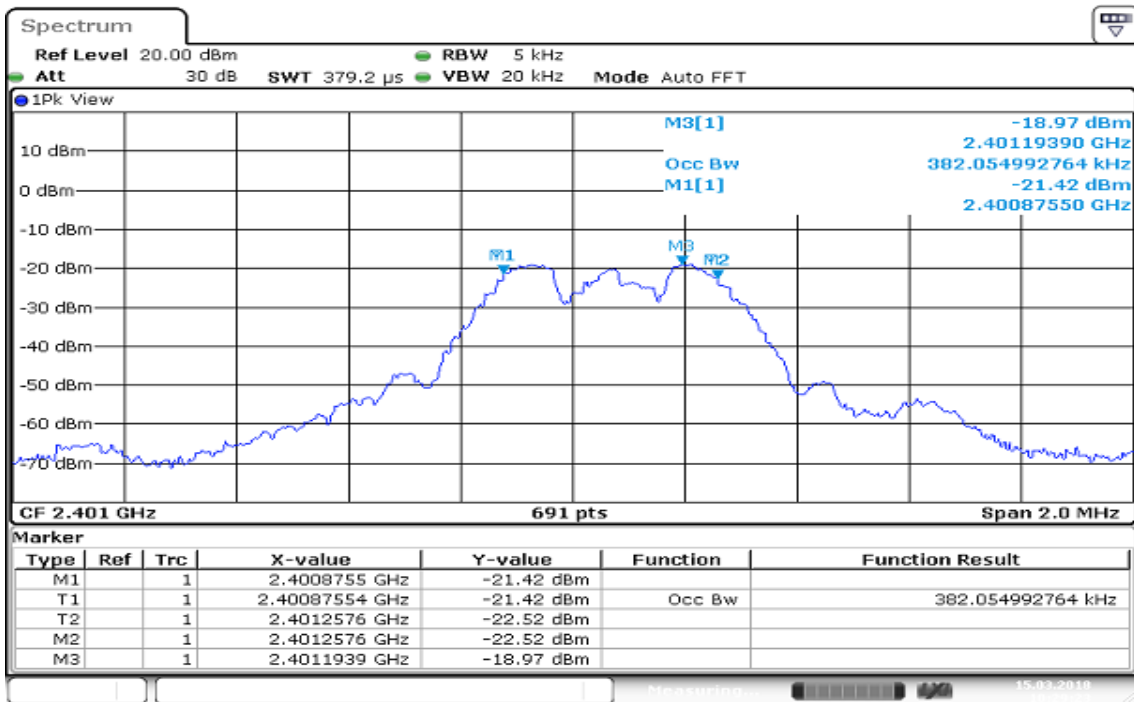

Date: 15 MAR 2018 10:29:23

**CH Mid**

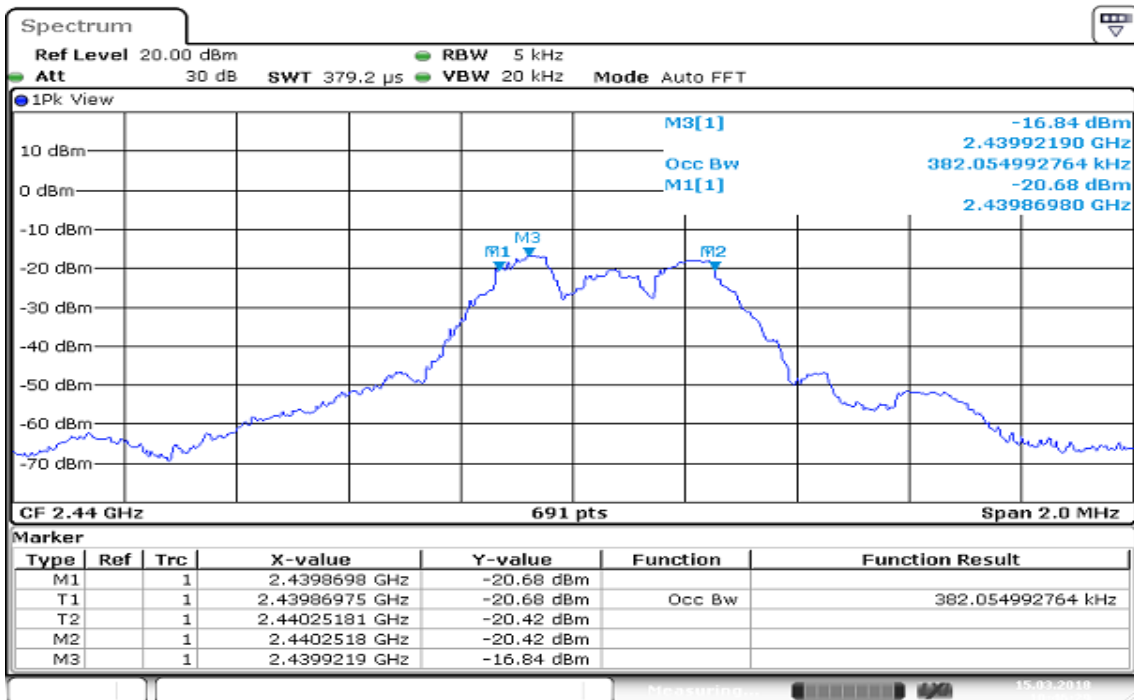

Date: 15 MAR 2018 10:46:30

**CH High**

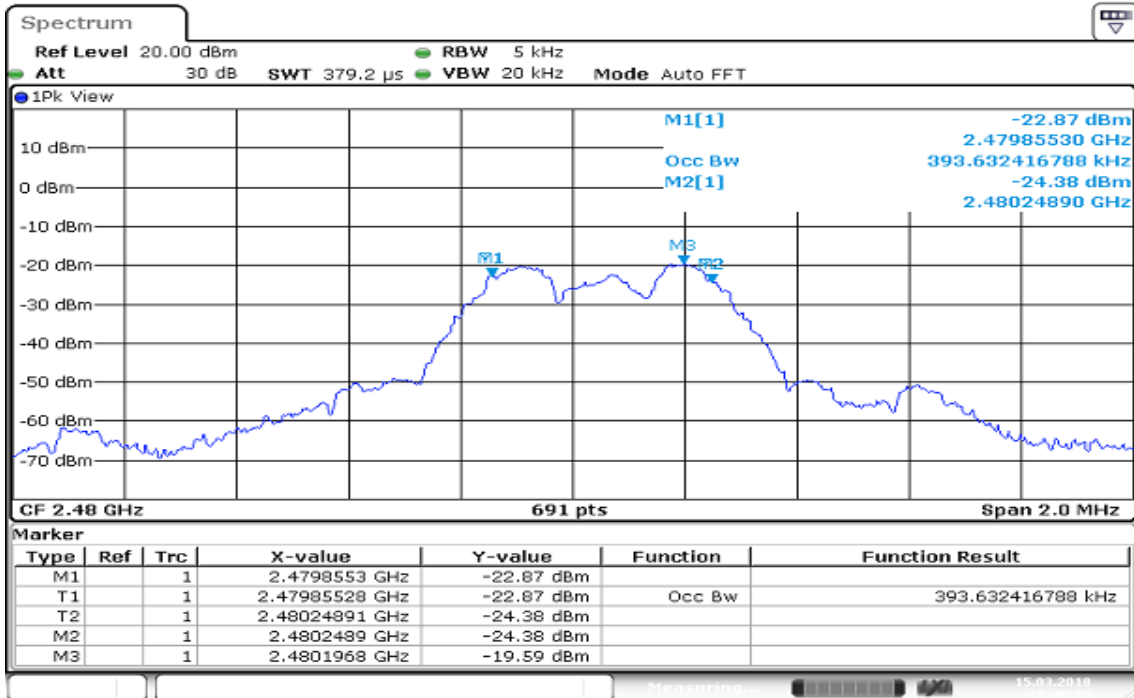

Date: 15 MAR 2018 10:49:29

## 8.2 BAND EDGES AND FUNDAMENTAL MEASUREMENT

### LIMIT

According to §15.209, §15.249(a)

(1) The field strength of emissions from intentional radiators operated within these frequency bands shall comply with the following:

Fundamental frequency (MHz)	Field strength of fundamental (millivolts/meter)	Field strength of harmonics (microvolts/meter)
2400-2483.5	50	500
5725-5875	50	500
24000-24250	250	2500

\* Field strength limits are specified at a distance of 3 meters

Fundamental Limit Conversion		
Average (mV/m) at 3M	Average (dBuV/m) at 3M	Peak (dBuV/m) at 3M
50	93.98	113.98

Harmonic Limit Conversion		
Average (uV/m) at 3M	Average (dBuV/m) at 3M	Peak (dBuV/m) at 1M
500	53.97	73.97

\*(Limit=20LOG(500)=53.79 dBuV/m)

(2) Emissions radiated outside of the specified frequency bands, except for harmonics, shall be attenuated by at least 50 dB below the level of the fundamental or to the general radiated emission limits in §15.209(follow the table), whichever is the lesser attenuation

**Below 30 MHz**

Frequency	Field Strength (microvolts/m)	Measurement Distance (metres)
9-490 kHz	2,400/F (F in kHz)	300
490-1,705 kHz	24,000/F (F in kHz)	30
1.705-30 MHz	30	30

**Above 30 MHz**

Frequency	Field Strength (microvolts/m)	Measurement Distance (metres)
30-88	100	3
88-216	150	3
216-960	200	3
Above 960	500	3

**Test Configuration**

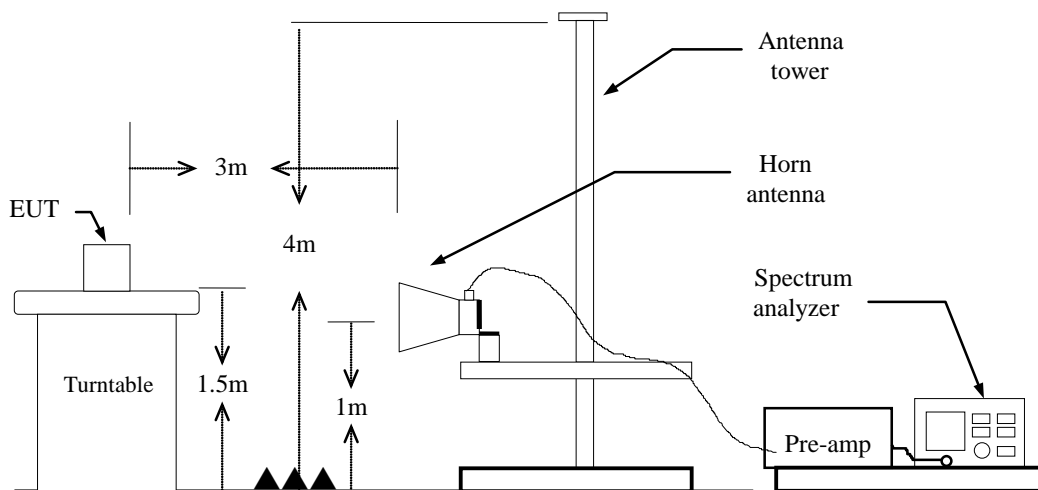

**TEST PROCEDURE**

1. The EUT is placed on a turntable, which is 1.5m above the ground plane.
2. The turntable shall be rotated for 360 degrees to determine the position of maximum emission level.
3. EUT is set 3m away from the receiving antenna, which is varied from 1m to 4m to find out the highest emission.
4. Set the spectrum analyzer in the following setting in order to capture the lower and upper band-edges of the emission:
  - (a) PEAK: RBW=1MHz / VBW=3MHz / Sweep=AUTO
  - (b) AVERAGE: RBW=1MHz,  
if duty cycle  $\geq 98\%$ , VBW=10Hz.  
if duty cycle  $< 98\%$  VBW=1/T.

About Test :

**ANT+:** = 99%, VBW= 10Hz

5. Repeat the procedures until all the PEAK and AVERAGE versus POLARIZATION are measured.
6. Result = Spectrum Reading + cable loss(spectrum to Amp) - Amp Gain + Cable loss(Amp to receive Ant)+ Receive Ant

**DUTY CYCLE**

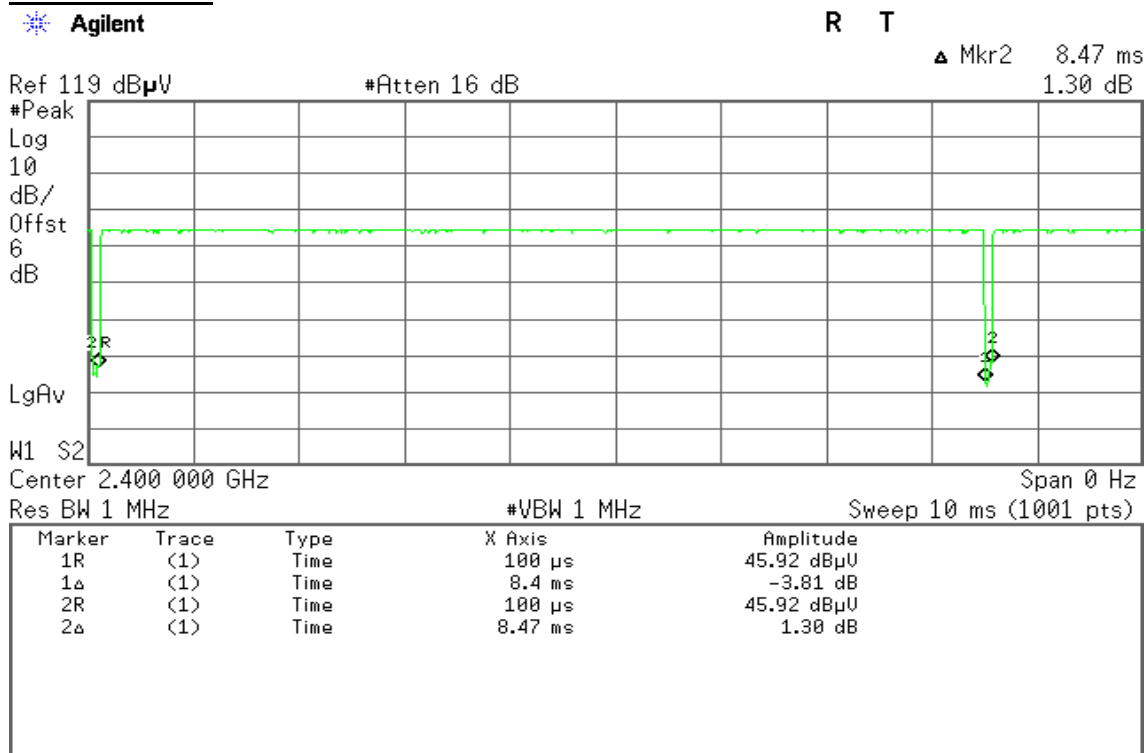

**TEST RESULTS**

Refer to attach spectrum analyzer data chart.

**Band Edges (CH Low)**

**Detector mode: Peak**

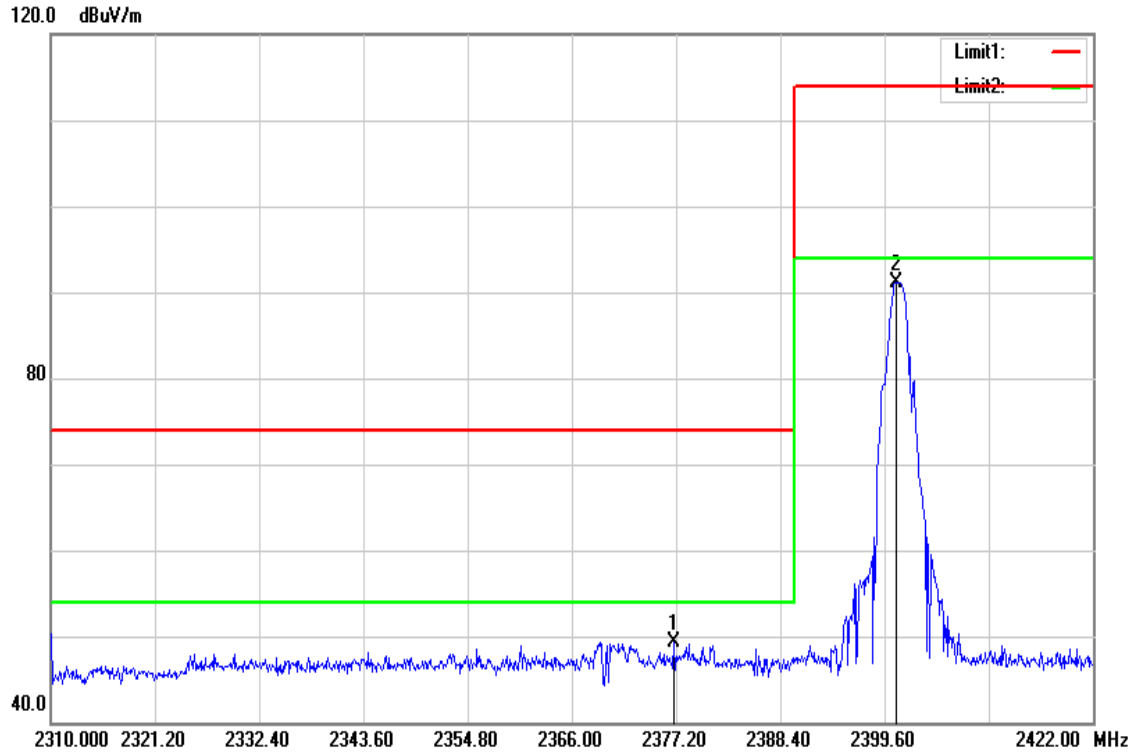

No.	Frequency (MHz)	Reading (dBuV)	Correct Factor(dB/m)	Result (dBuV/m)	Limit (dBuV/m)	Margin (dB)	Remark
1	2376.976	52.41	-3.02	49.39	74.00	-24.61	peak
2	2400.832	94.14	-2.95	91.19	114.00	-22.81	peak

**Detector mode: Average**

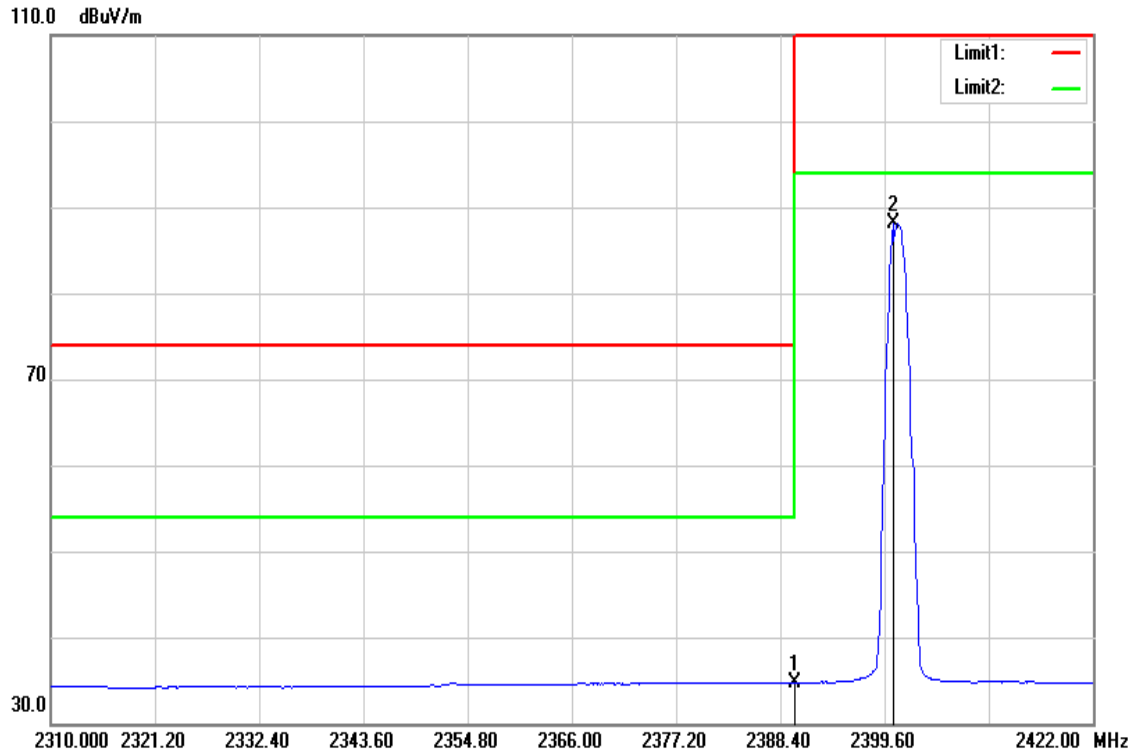

No.	Frequency (MHz)	Reading (dBuV)	Correct Factor(dB/m)	Result (dBuV/m)	Limit (dBuV/m)	Margin (dB)	Remark
1	2390.000	37.68	-2.98	34.70	54.00	-19.30	AVG
2	2400.552	91.13	-2.95	88.18	94.00	-5.82	AVG



**Band Edges (CH Mid)**

**Detector mode: Peak**

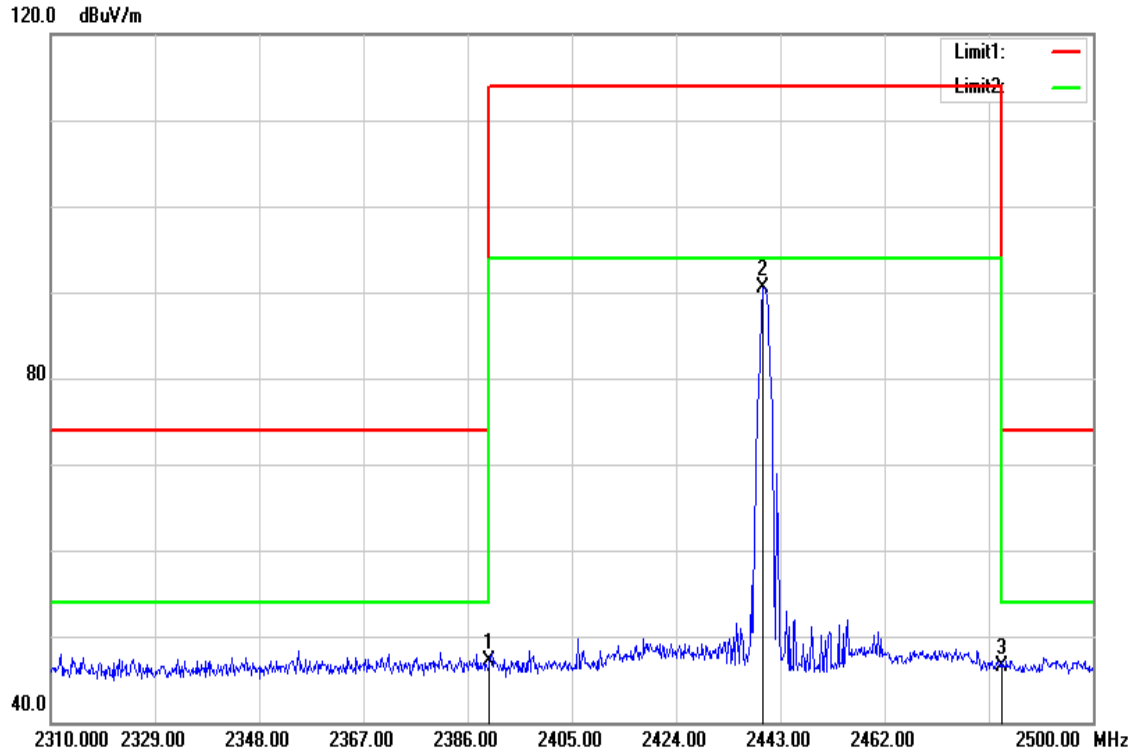

No.	Frequency (MHz)	Reading (dBuV)	Correct Factor(dB/m)	Result (dBuV/m)	Limit (dBuV/m)	Margin (dB)	Remark
1	2390.000	50.08	-2.98	47.10	74.00	-26.90	peak
2	2439.865	93.26	-2.82	90.44	114.00	-23.56	peak
3	2483.500	49.22	-2.69	46.53	74.00	-27.47	peak

**Detector mode: Average**

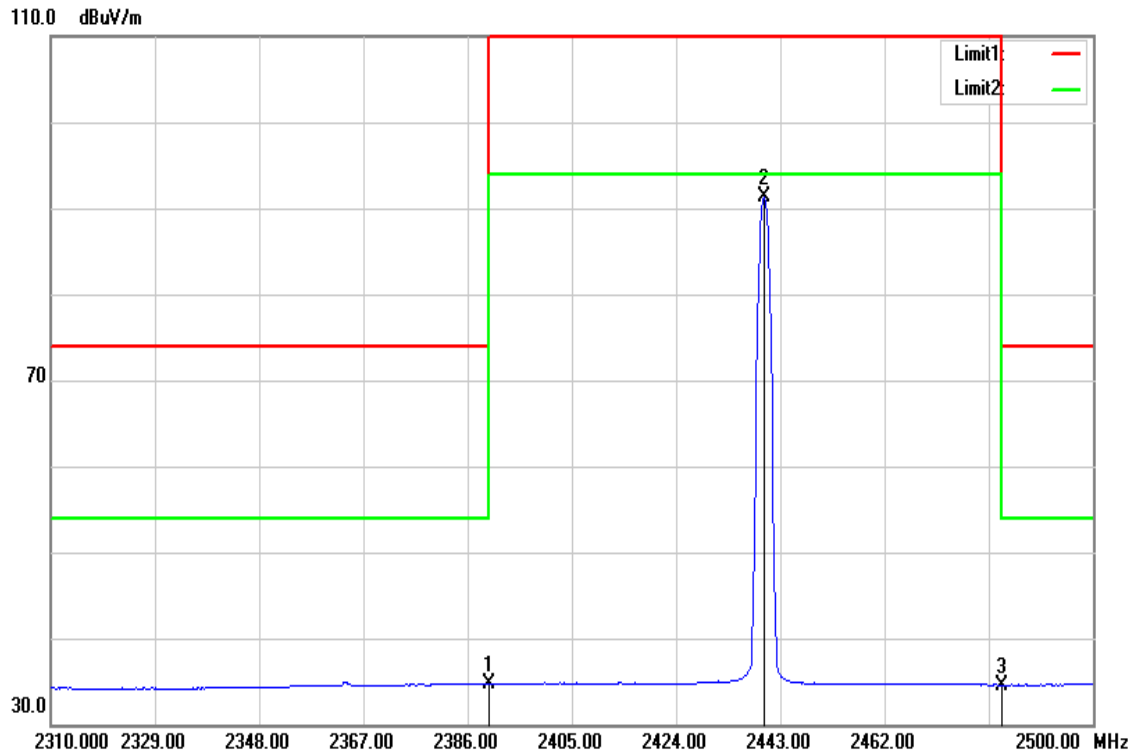

No.	Frequency (MHz)	Reading (dBuV)	Correct Factor(dB/m)	Result (dBuV/m)	Limit (dBuV/m)	Margin (dB)	Remark
1	2390.000	37.64	-2.98	34.66	54.00	-19.34	AVG
2	2440.055	94.17	-2.82	91.35	94.00	-2.65	AVG
3	2483.500	37.27	-2.69	34.58	54.00	-19.42	AVG

**Band Edges (CH High)**

**Detector mode: Peak**

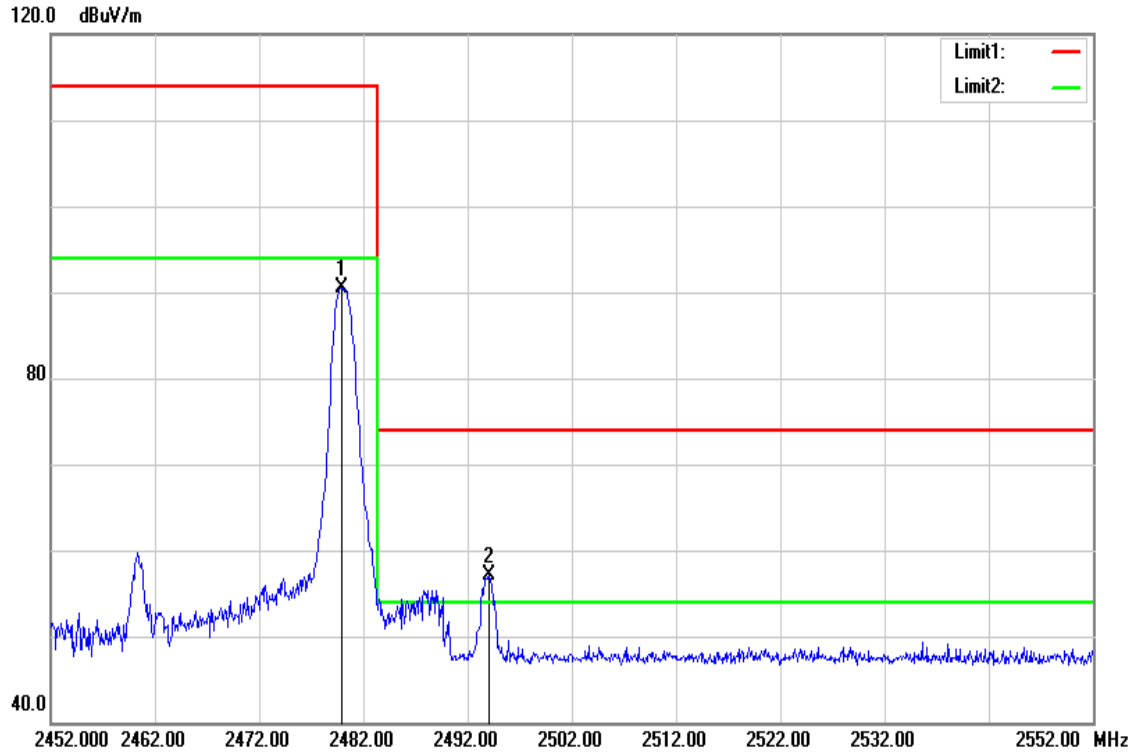

No.	Frequency (MHz)	Reading (dBuV)	Correct Factor(dB/m)	Result (dBuV/m)	Limit (dBuV/m)	Margin (dB)	Remark
1	2479.900	93.14	-2.70	90.44	114.00	-23.56	peak
2	2494.000	59.75	-2.66	57.09	74.00	-16.91	peak

**Detector mode: Average**

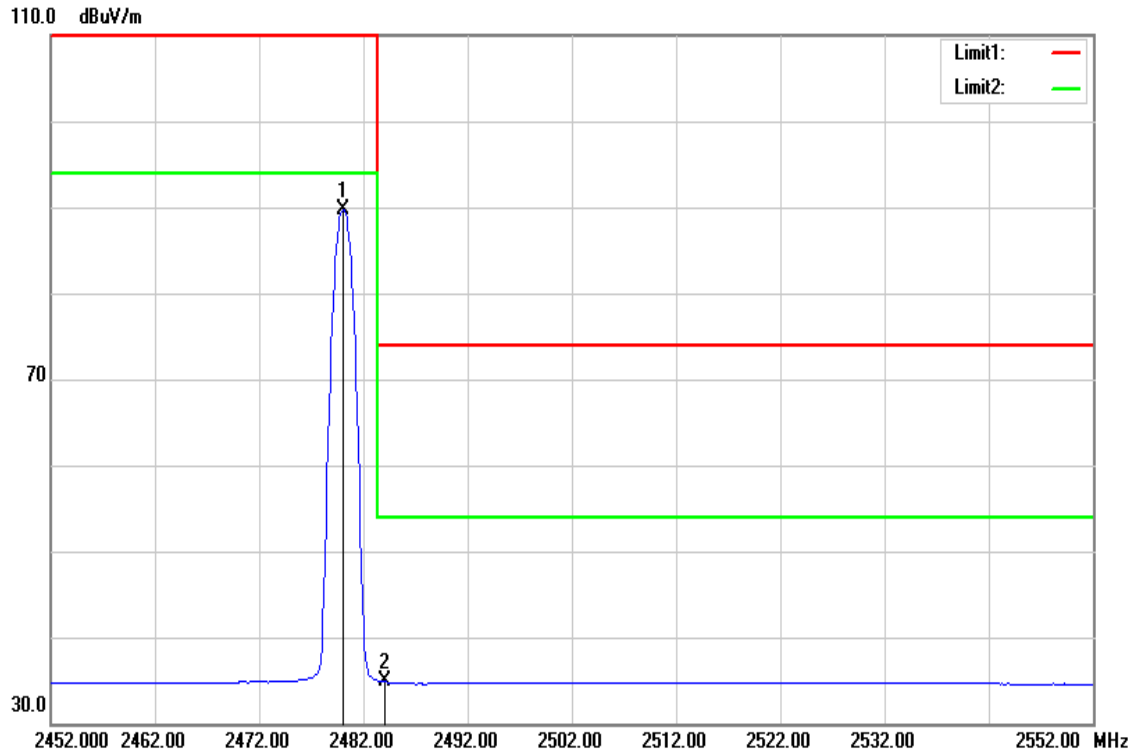

No.	Frequency (MHz)	Reading (dBuV)	Correct Factor(dB/m)	Result (dBuV/m)	Limit (dBuV/m)	Margin (dB)	Remark
1	2480.050	92.44	-2.70	89.74	94.00	-4.26	AVG
2	2484.000	37.55	-2.69	34.86	54.00	-19.14	AVG

### 8.3 SPURIOUS EMISSION

#### LIMIT

According to §15.209, §15.249(a)

Emissions radiated outside of the specified frequency bands, except for harmonics, shall be attenuated by at least 50 dB below the level of the fundamental or to the general radiated emission limits in §15.209(follow the table), whichever is the lesser attenuation

#### Below 30 MHz

Frequency	Field Strength (microvolts/m)	Measurement Distance (metres)
9-490 kHz	2,400/F (F in kHz)	300
490-1,705 kHz	24,000/F (F in kHz)	30
1.705-30 MHz	30	30

#### Above 30 MHz

Frequency	Field Strength (microvolts/m)	Measurement Distance (metres)
30-88	100	3
88-216	150	3
216-960	200	3
Above 960	500	3

**Test Configuration**

**9kHz ~ 30MHz**

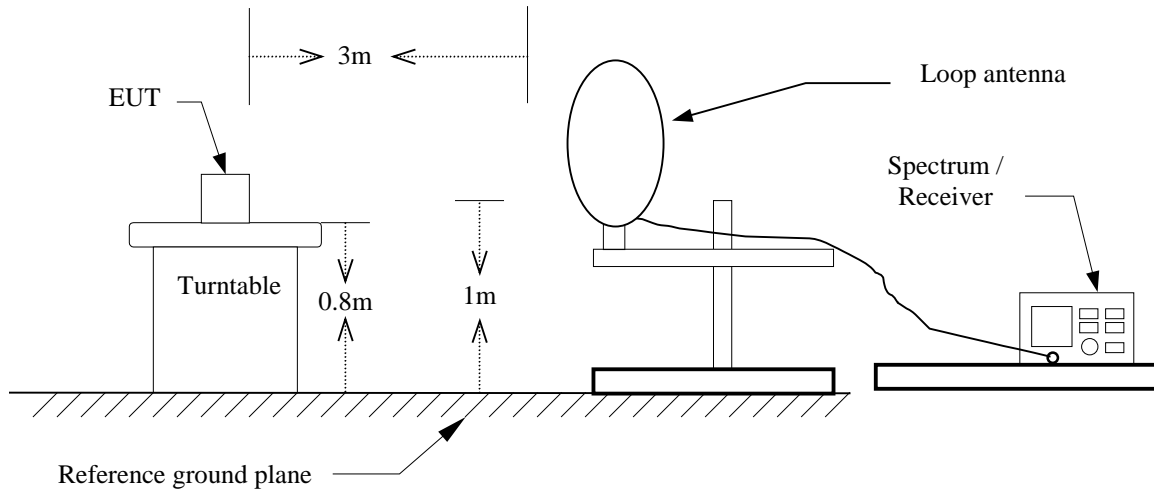

**30MHz ~ 1GHz**

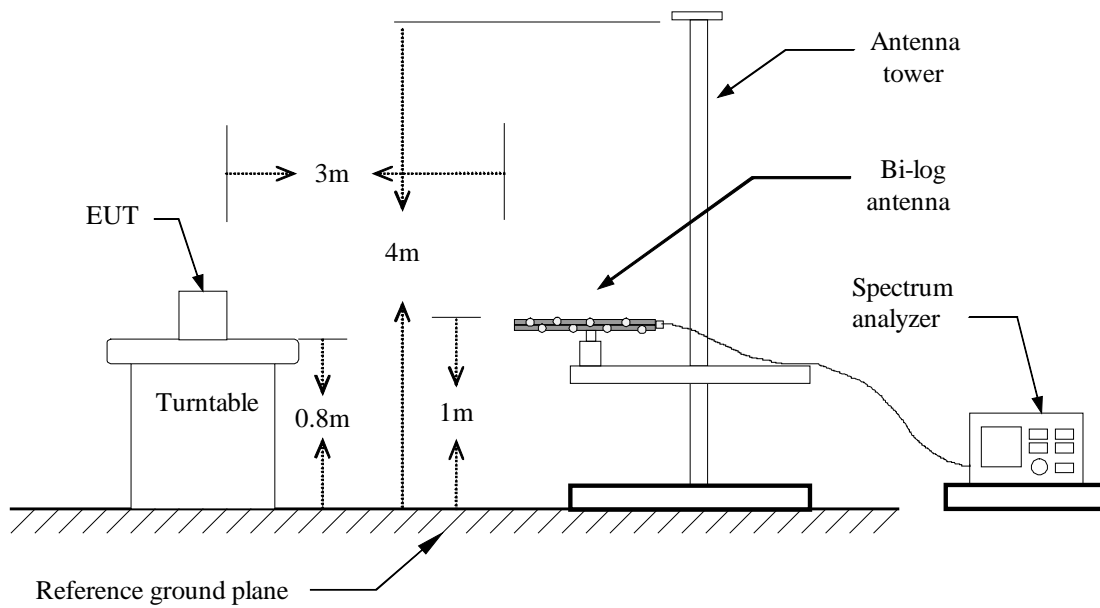

**Above 1 GHz**

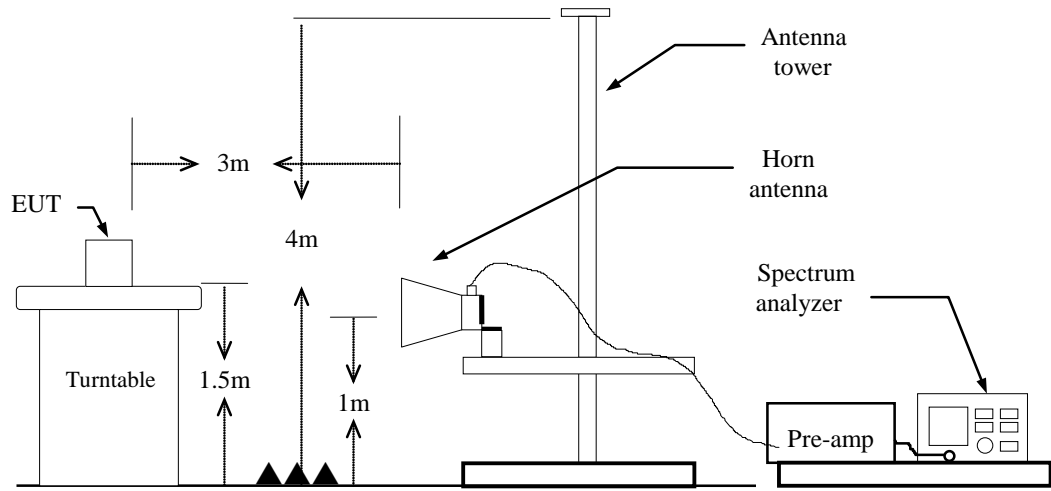

## **TEST PROCEDURE**

1. The EUT is placed on a turntable, Above 1 GHz is 1.5m high and below 1 GHz is 0.8m high above ground plane.
2. The turntable shall be rotated for 360 degrees to determine the position of maximum emission level.
3. EUT is set 3m away from the receiving antenna, which is varied from 1m to 4m to find out the highest emissions.
4. Maximum procedure was performed on the six highest emissions to ensure EUT compliance.
5. And also, each emission was to be maximized by changing the polarization of receiving antenna both horizontal and vertical.
6. Set the spectrum analyzer in the following setting as:

Below 1GHz:

RBW=100kHz / VBW=300kHz / Sweep=AUTO

Above 1GHz:

(a)PEAK: RBW=1MHz / VBW=3MHz / Sweep=AUTO

(b)AVERAGE: RBW=1MHz,

if duty cycle $\geq$ 98%, VBW=10Hz.

if duty cycle<98% VBW=1/T.

About test

**ANT+**: = 99%, VBW= 10Hz

7. Repeat above procedures until the measurements for all frequencies are complete.
8. Result = Spectrum Reading + cable loss(spectrum to Amp) - Amp Gain + Cable loss(Amp to receive Ant)+ Receive Ant

**Note:** We checked every harmonics frequencies from Fundamental frequencies with reduced VBW, and we mark a point to prove pass or not if we find any emission. For this case, there are no emissions hidden in the noise floor.



**Below 1 GHz**

**Operation Mode:** Normal Link

**Test Date:** March 1, 2018

**Temperature:** 22°C

**Tested by:** Jerry Chuang

**Humidity:** 34% RH

**Polarity:** Ver.

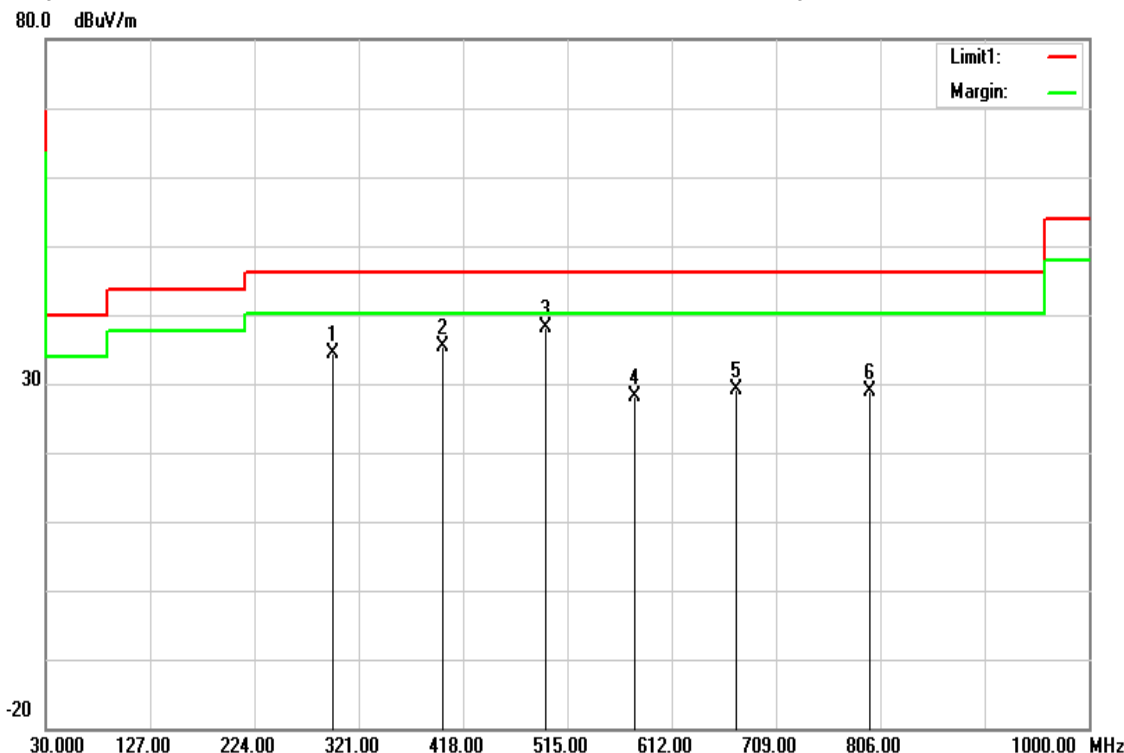

Frequency (MHz)	Reading (dBuV)	Correction Factor (dB/m)	Result (dBuV/m)	Limit (dBuV/m)	Margin (dB)	Remark	Ant. Pol. (H/V)
297.2350	48.59	-14.09	34.50	46.02	-11.52	peak	V
399.5700	46.77	-11.40	35.37	46.02	-10.65	peak	V
494.6300	46.85	-8.61	38.24	46.02	-7.78	peak	V
578.5350	35.31	-7.19	28.12	46.02	-17.90	peak	V
672.6250	34.39	-5.25	29.14	46.02	-16.88	peak	V
796.7850	32.30	-3.44	28.86	46.02	-17.16	peak	V

**Remark:**

1. No emission found between lowest internal used/generated frequency to 30MHz (9kHz~30MHz)
2. Radiated emissions measured in frequency range from 30 MHz to 1000MHz were made with an instrument using peak/quasi-peak detector mode.
3. Quasi-peak test would be performed if the peak result were greater than the quasi-peak limit or as required by the applicant.
4. Measurements above show only up to 6 maximum emissions noted, or would be lesser, with " N/A " remark, if no specific emissions from the EUT are recorded (ie: margin>20dB from the applicable limit) and considered that's already beyond the background noise floor.
5. Margin (dB) = Remark result (dBuV/m) – Quasi-peak limit (dBuV/m).

**Operation Mode:** Normal Link

**Test Date:** March 1, 2018

**Temperature:** 22°C

**Tested by:** Jerry Chuang

**Humidity:** 34% RH

**Polarity:** Hor.

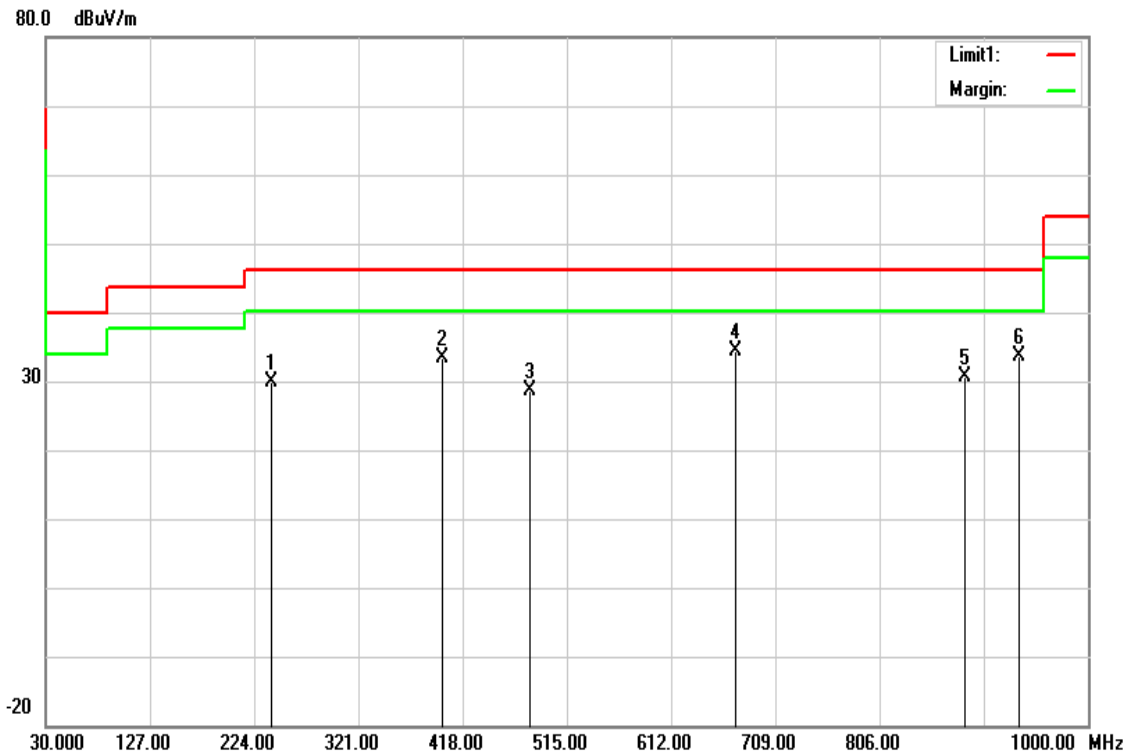

Frequency (MHz)	Reading (dBuV)	Correction Factor (dB/m)	Result (dBuV/m)	Limit (dBuV/m)	Margin (dB)	Remark	Ant. Pol. (H/V)
240.0050	45.99	-16.13	29.86	46.02	-16.16	peak	H
399.0850	44.68	-11.41	33.27	46.02	-12.75	peak	H
480.0800	37.47	-8.94	28.53	46.02	-17.49	peak	H
672.6250	39.71	-5.25	34.46	46.02	-11.56	peak	H
886.0250	32.81	-2.25	30.56	46.02	-15.46	peak	H
935.9800	35.07	-1.42	33.65	46.02	-12.37	peak	H

**Remark:**

1. No emission found between lowest internal used/generated frequency to 30MHz (9kHz~30MHz)
2. Radiated emissions measured in frequency range from 30 MHz to 1000MHz were made with an instrument using peak/quasi-peak detector mode.
3. Quasi-peak test would be performed if the peak result were greater than the quasi-peak limit or as required by the applicant.
4. Measurements above show only up to 6 maximum emissions noted, or would be lesser, with " N/A " remark, if no specific emissions from the EUT are recorded (ie: margin>20dB from the applicable limit) and considered that's already beyond the background noise floor.
5. Margin (dB) = Remark result (dBuV/m) – Quasi-peak limit (dBuV/m).

**Above 1 GHz**

**TX / CH Low**

**Polarity: Vertical**

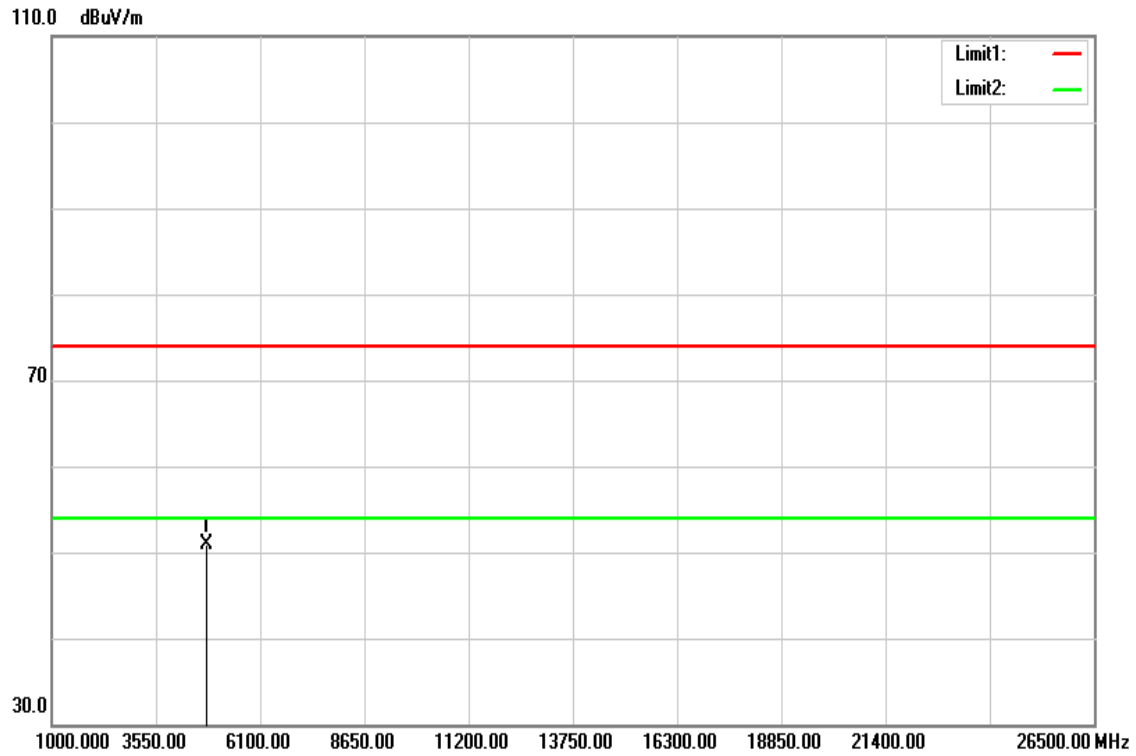

**Polarity: Horizontal**

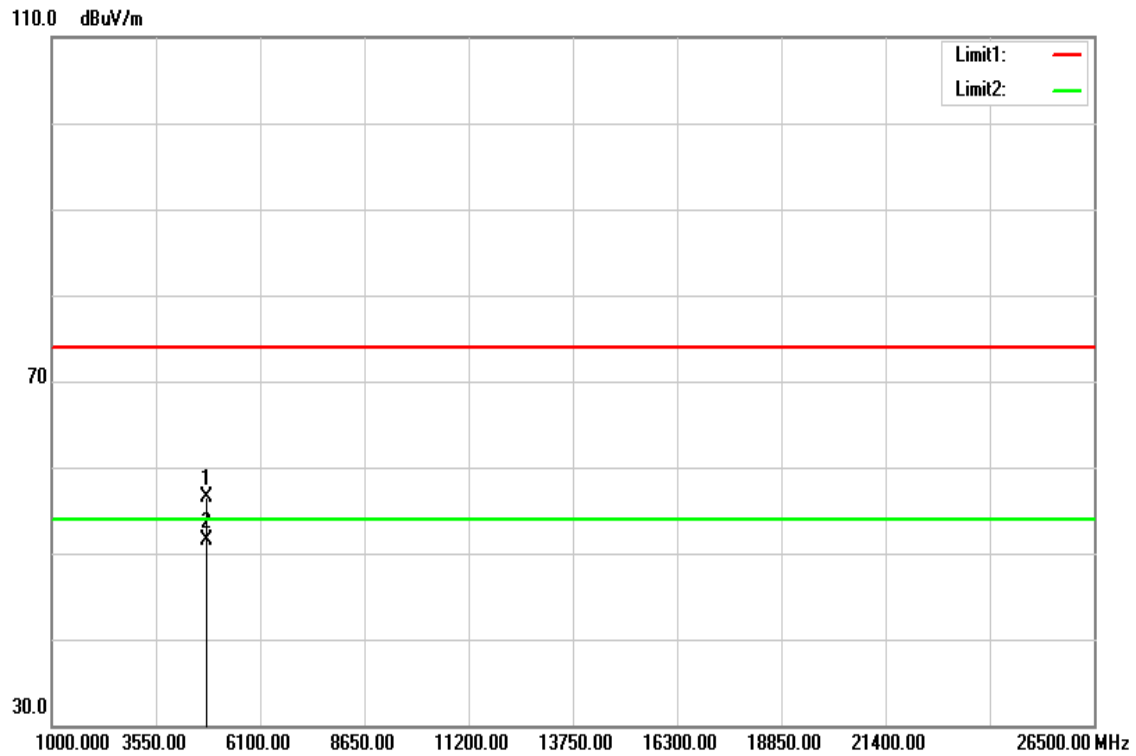

**Above 1 GHz**

**Operation Mode:** Tx / CH Low                      **Test Date:** March 16, 2018  
**Temperature:** 22°C                                      **Tested by:** Jerry Chuang  
**Humidity:** 34% RH                                      **Polarity:** Ver. / Hor.

Frequency (MHz)	Reading (dBuV)	Correction Factor (dB/m)	Result (dBuV/m)	Limit (dBuV/m)	Margin (dB)	Remark	Ant.Pol. (H/V)
4802.500	46.63	4.33	50.96	74.00	-23.04	peak	V
N/A							
4802.500	52.22	4.33	56.55	74.00	-17.45	peak	H
4802.500	47.25	4.33	51.58	54.00	-2.42	AVG	H
N/A							

**Remark:**

1. Measuring frequencies from 1 GHz to the 10th harmonic of highest fundamental frequency.
2. Radiated emissions measured in frequency above 1000MHz were made with an instrument using peak/average detector mode.
3. Average test would be performed if the peak result were greater than the average limit or as required by the applicant.
4. Data of measurement within this frequency range shown " --- " in the table above means the reading of emissions are attenuated more than 20dB below the permissible limits or the field strength is too small to be measured.
5. Measurements above show only up to 6 maximum emissions noted, or would be lesser, with " N/A " remark, if no specific emissions from the EUT are recorded (ie: margin>20dB from the applicable limit) and considered that's already beyond the background noise floor.
6. Margin (dB) = Result (dBuV/m) – limit (dBuV/m).

**TX / CH Mid**

**Polarity: Vertical**

110.0 dBuV/m

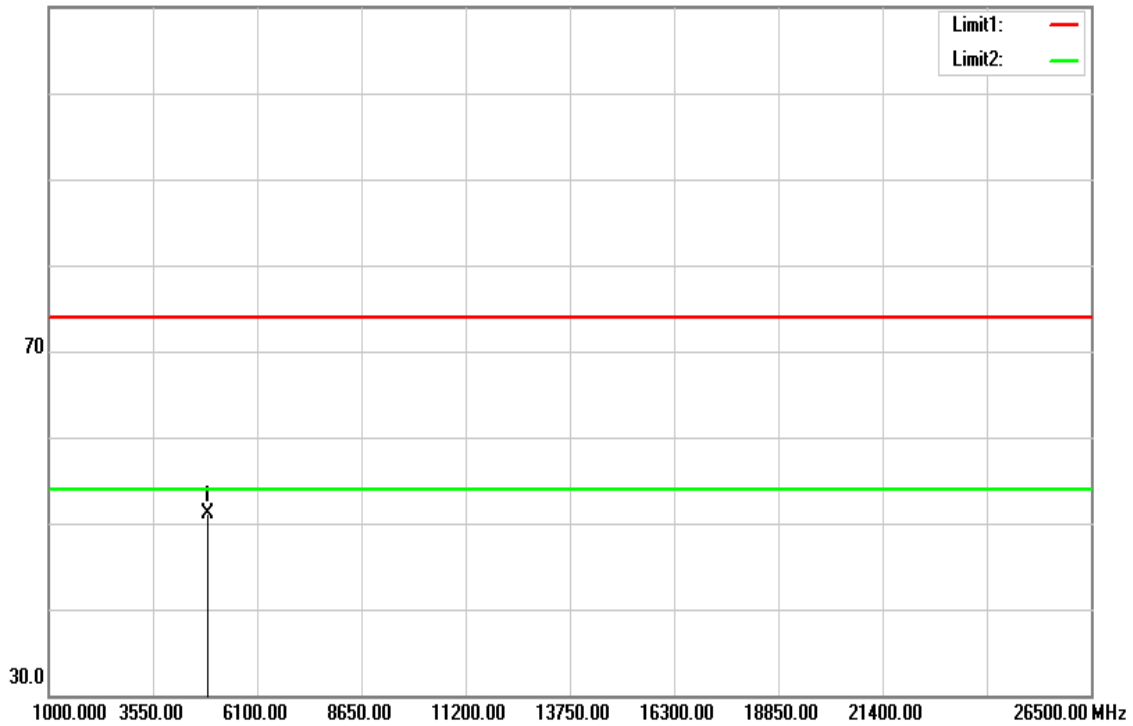

**Polarity: Horizontal**

110.0 dBuV/m

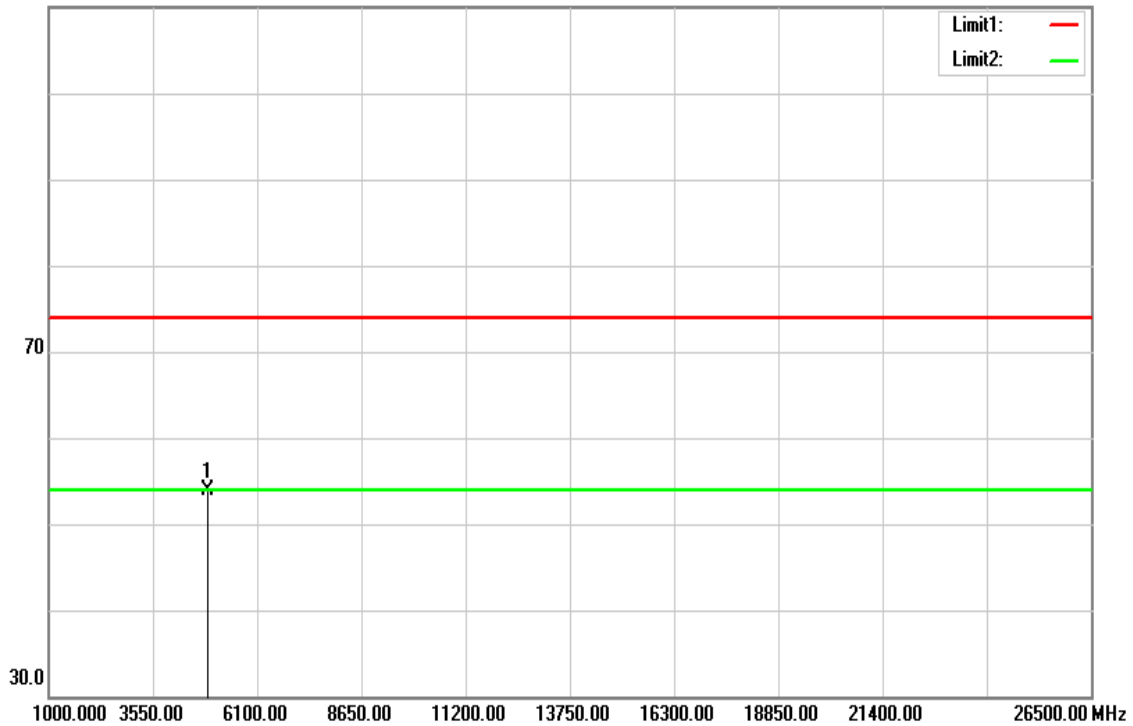

**Operation Mode:** Tx / CH Mid                      **Test Date:** March 1, 2018  
**Temperature:** 22°C                                      **Tested by:** Jerry Chuang  
**Humidity:** 34% RH                                      **Polarity:** Ver. / Hor.

Frequency (MHz)	Reading (dBuV)	Correction Factor (dB/m)	Result (dBuV/m)	Limit (dBuV/m)	Margin (dB)	Remark	Ant.Pol. (H/V)
4879.500	46.71	4.48	51.19	74.00	-22.81	peak	V
N/A							
4879.500	49.49	4.48	53.97	74.00	-20.03	peak	H
N/A							

**Remark:**

1. Measuring frequencies from 1 GHz to the 10th harmonic of highest fundamental frequency.
2. Radiated emissions measured in frequency above 1000MHz were made with an instrument using peak/average detector mode.
3. Average test would be performed if the peak result were greater than the average limit or as required by the applicant.
4. Data of measurement within this frequency range shown “ --- ” in the table above means the reading of emissions are attenuated more than 20dB below the permissible limits or the field strength is too small to be measured.
5. Measurements above show only up to 6 maximum emissions noted, or would be lesser, with “ N/A ” remark, if no specific emissions from the EUT are recorded (ie: margin>20dB from the applicable limit) and considered that's already beyond the background noise floor.
6. Margin (dB) = Result (dBuV/m) – limit (dBuV/m).

**TX / CH High**

**Polarity: Vertical**

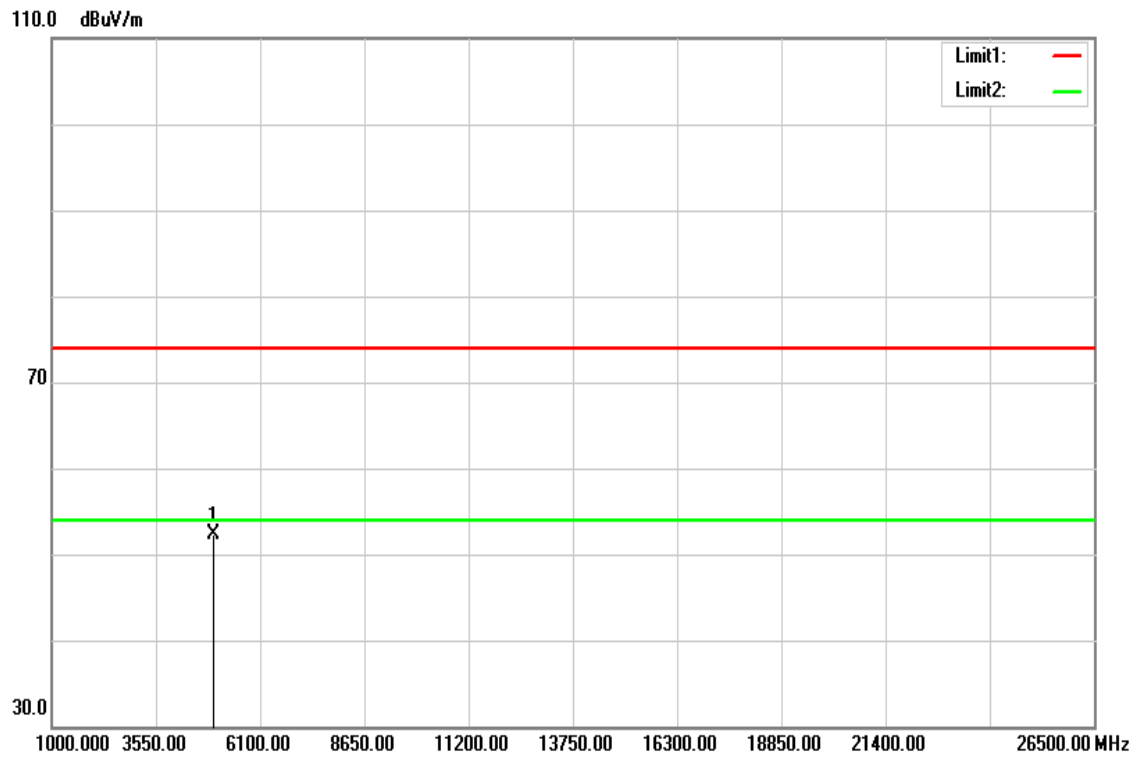

**Polarity: Horizontal**

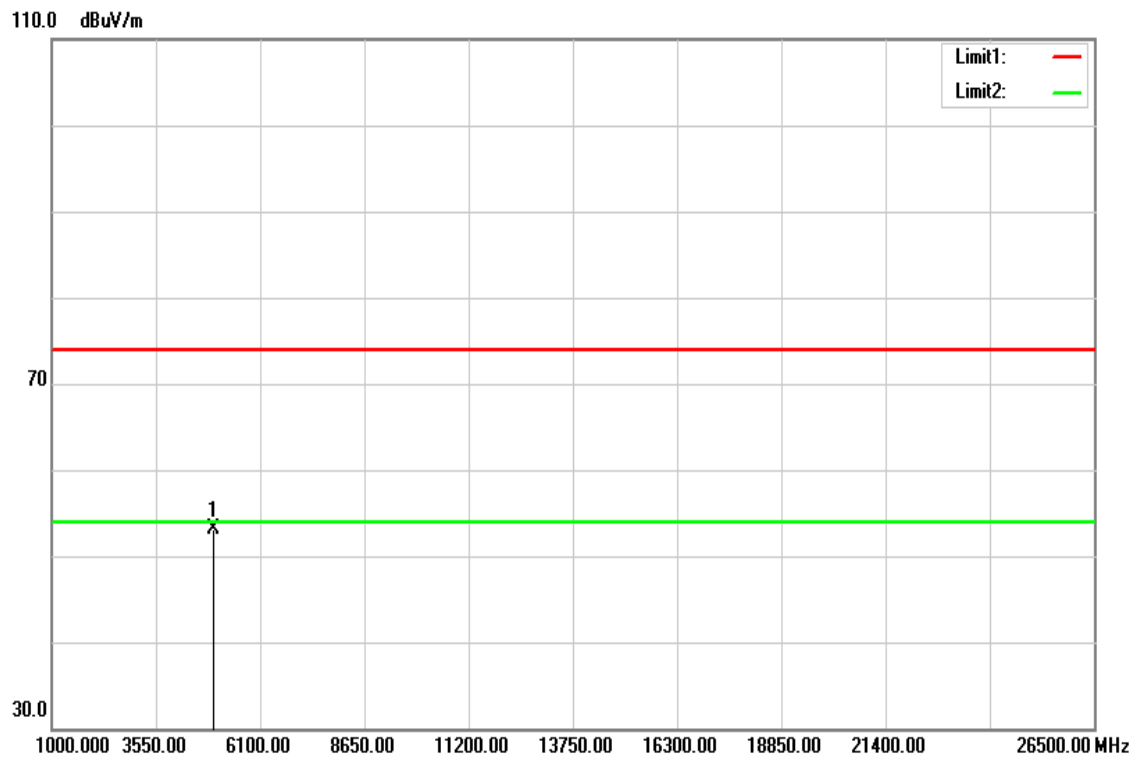

**Operation Mode:** Tx / CH High      **Test Date:** March 1, 2018  
**Temperature:** 22°C      **Tested by:** Jerry Chuang  
**Humidity:** 34% RH      **Polarity:** Ver. / Hor.

Frequency (MHz)	Reading (dBuV)	Correction Factor (dB/m)	Result (dBuV/m)	Limit (dBuV/m)	Margin (dB)	Remark	Ant.Pol. (H/V)
4960.000	47.77	4.61	52.38	74.00	-21.62	peak	V
N/A							
4960.000	48.45	4.61	53.06	74.00	-20.94	peak	H
N/A							

**Remark:**

1. Measuring frequencies from 1 GHz to the 10th harmonic of highest fundamental frequency.
2. Radiated emissions measured in frequency above 1000MHz were made with an instrument using peak/average detector mode.
3. Average test would be performed if the peak result were greater than the average limit or as required by the applicant.
4. Data of measurement within this frequency range shown “ --- ” in the table above means the reading of emissions are attenuated more than 20dB below the permissible limits or the field strength is too small to be measured.
5. Measurements above show only up to 6 maximum emissions noted, or would be lesser, with “ N/A ” remark, if no specific emissions from the EUT are recorded (ie: margin>20dB from the applicable limit) and considered that's already beyond the background noise floor.
6. Margin (dB) = Result (dBuV/m) – limit (dBuV/m).



## 8.4 POWERLINE CONDUCTED EMISSIONS

### LIMIT

According to §15.207(a), for an intentional radiator that is designed to be connected to the public utility (AC) power line, the radio frequency voltage that is conducted back onto the AC power line on any frequency or frequencies within the band 150 kHz to 30 MHz shall not exceed the limits in the following table, as measured using a 50  $\mu$ H/50 ohms line impedance stabilization network (LISN). Compliance with the provisions of this paragraph shall be based on the measurement of the radio frequency voltage between each power line and ground at the power terminal. The lower limit applies at the boundary between the frequency ranges.

Frequency Range (MHz)	Limits (dB $\mu$ V)	
	Quasi-peak	Average
0.15 to 0.50	66 to 56*	56 to 46*
0.50 to 5	56	46
5 to 30	60	50

### Test Configuration

See test photographs attached in Appendix I for the actual connections between EUT and support equipment.

### TEST PROCEDURE

1. The EUT was placed on a table, which is 0.8m above ground plane.
2. Maximum procedure was performed on the six highest emissions to ensure EUT compliance.
3. Repeat above procedures until all frequency measured were complete.

## **TEST RESULTS**

The initial step in collecting conducted data is a spectrum analyzer peak scan of the measurement range. Significant peaks are then marked as shown on the following data page, and these signals are then quasi-peaked.

### **Test Data**

**Not applicable, because EUT not connect to AC Main Source direct.**