



FCC RF Test Report

APPLICANT : Bullitt Group
EQUIPMENT : Rugged Smart Phone
BRAND NAME : CAT
MODEL NAME : S61
FCC ID : ZL5S61
STANDARD : FCC 47 CFR Part 2, 22(H), 24(E), 27(L)
CLASSIFICATION : PCS Licensed Transmitter Held to Ear (PCE)

The product was received on Jan. 11, 2018 and testing was completed on Mar. 30, 2018. We, SPORTON INTERNATIONAL INC., would like to declare that the tested sample has been evaluated in accordance with the test procedures given in ANSI / TIA-603-E and has been in compliance with the applicable technical standards.

The test results in this report apply exclusively to the tested model / sample. Without written approval of SPORTON INTERNATIONAL INC., the test report shall not be reproduced except in full.

Reviewed by: Joseph Lin / Supervisor

Approved by: Jones Tsai / Manager



SPORTON INTERNATIONAL INC.

No. 52, Hwa Ya 1st Rd., Hwa Ya Technology Park, Kwei-Shan District, Tao Yuan City, Taiwan, R.O.C.

SPORTON INTERNATIONAL INC.

TEL : 886-3-327-3456

FAX : 886-3-328-4978

FCC ID : ZL5S61

Page Number : 1 of 20

Report Issued Date : May 03, 2018

Report Version : Rev. 01

Report Template No.: BU5-FG22/24/27 Version 2.0



TABLE OF CONTENTS

REVISION HISTORY..... 3

SUMMARY OF TEST RESULT 4

1 GENERAL DESCRIPTION 5

 1.1 Applicant..... 5

 1.2 Manufacturer 5

 1.3 Product Feature of Equipment Under Test 5

 1.4 Modification of EUT 5

 1.5 Testing Location 6

 1.6 Applicable Standards 6

2 TEST CONFIGURATION OF EQUIPMENT UNDER TEST 7

 2.1 Test Mode..... 7

 2.2 Connection Diagram of Test System 8

 2.3 Support Unit used in test configuration 8

 2.4 Measurement Results Explanation Example 8

 2.5 Frequency List of Low/Middle/High Channels..... 9

3 CONDUCTED TEST RESULT..... 10

 3.1 Measuring Instruments..... 10

 3.2 Test Setup 10

 3.3 Test Result of Conducted Test..... 10

 3.4 Conducted Output Power and ERP/EIRP 11

 3.5 Peak-to-Average Ratio 12

 3.6 99% Occupied Bandwidth and 26dB Bandwidth Measurement..... 13

 3.7 Conducted Band Edge 14

 3.8 Conducted Spurious Emission 15

 3.9 Frequency Stability..... 16

4 RADIATED TEST ITEMS 17

 4.1 Measuring Instruments..... 17

 4.2 Test Setup 17

 4.3 Test Result of Radiated Test..... 17

 4.4 Field Strength of Spurious Radiation Measurement 18

5 LIST OF MEASURING EQUIPMENT 19

6 UNCERTAINTY OF EVALUATION 20

APPENDIX A. TEST RESULTS OF CONDUCTED TEST

APPENDIX B. TEST RESULTS OF RADIATED TEST

APPENDIX C. TEST SETUP PHOTOGRAPHS



SUMMARY OF TEST RESULT

Report Section	FCC Rule	Description	Limit	Result	Remark
3.4	§2.1046	Conducted Output Power	Reporting Only	PASS	-
	§22.913(a)(2)	Effective Radiated Power	< 7 Watts	PASS	-
	§24.232(c)	Equivalent Isotropic Radiated Power	< 2 Watts	PASS	-
	§27.50(d)(4)	Equivalent Isotropic Radiated Power	< 1 Watts	PASS	-
3.5	§24.232(d)	Peak-to-Average Ratio	< 13 dB	PASS	-
3.6	§2.1049 §22.917(b) §24.238(b) §27.53(g)	Occupied Bandwidth	Reporting Only	PASS	-
3.7	§2.1051 §22.917(a) §24.238(a) §27.53(h)	Band Edge Measurement	< 43+10log ₁₀ (P[Watts])	PASS	-
3.8	§2.1051 §22.917(a) §24.238(a) §27.53(h)	Conducted Emission	< 43+10log ₁₀ (P[Watts])	PASS	-
3.9	§2.1055 §22.355	Frequency Stability for Temperature & Voltage	< 2.5 ppm for Part 22	PASS	-
	§2.1055 §24.235 §27.54		Within Authorized Band		
4.4	§2.1053 §22.917(a) §24.238(a) §27.53(h)	Field Strength of Spurious Radiation	< 43+10log ₁₀ (P[Watts])	PASS	Under limit 18.82 dB at 2512.000 MHz



1 General Description

1.1 Applicant

Bullitt Group

One Valpy, Valpy Street, Reading, Berkshire, England RG1 1AR

1.2 Manufacturer

Compal Electronics, INC.

No. 385, Yangguang St. Neihu District, Taipei City 11491, Taiwan, R.O.C

1.3 Product Feature of Equipment Under Test

GSM/WCDMA/LTE, Bluetooth, Wi-Fi 2.4GHz 802.11b/g/n, Wi-Fi 5GHz 802.11a/n/ac, FM Receiver, NFC, and GNSS.

Product specification subjective to this standard	
Antenna Type	WWAN: PIFA Antenna WLAN: PIFA Antenna Bluetooth: PIFA Antenna GPS / Glonass / BDS / Galileo / SBAS : PIFA Antenna NFC: Loop Antenna FM: using earphone as antenna

<Sample Information>

S61 has 2 different Variant	
Sample 1	Dual SIM
Sample 2	Single SIM
Dual SIM to Single SIM choose by SIM tray HW detection to select by image setting. (Two setting, by HW detection pin to trigger)	

Remark: All test items were performed with Sample 1.

1.4 Modification of EUT

No modifications are made to the EUT during all test items.

1.5 Testing Location

Sporton Lab is accredited to ISO 17025 by Taiwan Accreditation Foundation (TAF code : 1190) and the FCC designation No. TW1190 and TW0007 under the FCC 2.948(e) by Mutual Recognition Agreement (MRA) in FCC Test.

Test Site	SPORTON INTERNATIONAL INC.
Test Site Location	No. 52, Hwa Ya 1 st Rd., Hwa Ya Technology Park, Kwei-Shan District, Tao Yuan City, Taiwan, R.O.C. TEL: +886-3-327-3456 FAX: +886-3-328-4978
Test Site No.	Sporton Site No.
	TH03-HY

Note: The test site complies with ANSI C63.4 2014 requirement.

Test Site	SPORTON INTERNATIONAL INC.
Test Site Location	No.58, Aly. 75, Ln. 564, Wenhua 3rd Rd. Guishan Dist, Taoyuan City, Taiwan (R.O.C.) TEL: +886-3-327-0868 FAX: +886-3-327-0855
Test Site No.	Sporton Site No.
	03CH11-HY

Note: The test site complies with ANSI C63.4 2014 requirement.

1.6 Applicable Standards

According to the specifications of the manufacturer, the EUT must comply with the requirements of the following standards:

- 47 CFR Part 2, 22(H), 24(E), 27(L)
- ANSI / TIA-603-E
- FCC KDB 971168 D01 Power Meas. License Digital Systems v03
- FCC KDB 412172 D01 Determining ERP and EIRP v01r01

Remark:

1. All test items were verified and recorded according to the standards and without any deviation during the test.
2. This EUT has also been tested and complied with the requirements of FCC Part 15, Subpart B, recorded in a separate test report.



2 Test Configuration of Equipment Under Test

2.1 Test Mode

Antenna port conducted and radiated test items were performed according to KDB 971168 D01 Power Meas. License Digital Systems v03 with maximum output power.

Radiated measurements were performed with rotating EUT in different three orthogonal test planes to find the maximum emission.

Radiated emissions were investigated as following frequency range:

1. 30 MHz to 9000 MHz for GSM850 and WCDMA Band V.
2. 30 MHz to 18000 MHz for WCDMA Band IV.
3. 30 MHz to 19100 MHz for GSM1900 and WCDMA Band II.

All modes and data rates and positions were investigated.

Test modes are chosen to be reported as the worst case configuration below:

Test Modes		
Band	Radiated TCs	Conducted TCs
GSM 850	■ GPRS class 8 Link ■ EDGE class 8 Link	■ GPRS class 8 Link ■ EDGE class 8 Link
GSM 1900	■ GPRS class 8 Link ■ EDGE class 8 Link	■ GPRS class 8 Link ■ EDGE class 8 Link
WCDMA Band V	■ RMC 12.2Kbps Link	■ RMC 12.2Kbps Link
WCDMA Band II	■ RMC 12.2Kbps Link	■ RMC 12.2Kbps Link
WCDMA Band IV	■ RMC 12.2Kbps Link	■ RMC 12.2Kbps Link

2.2 Connection Diagram of Test System

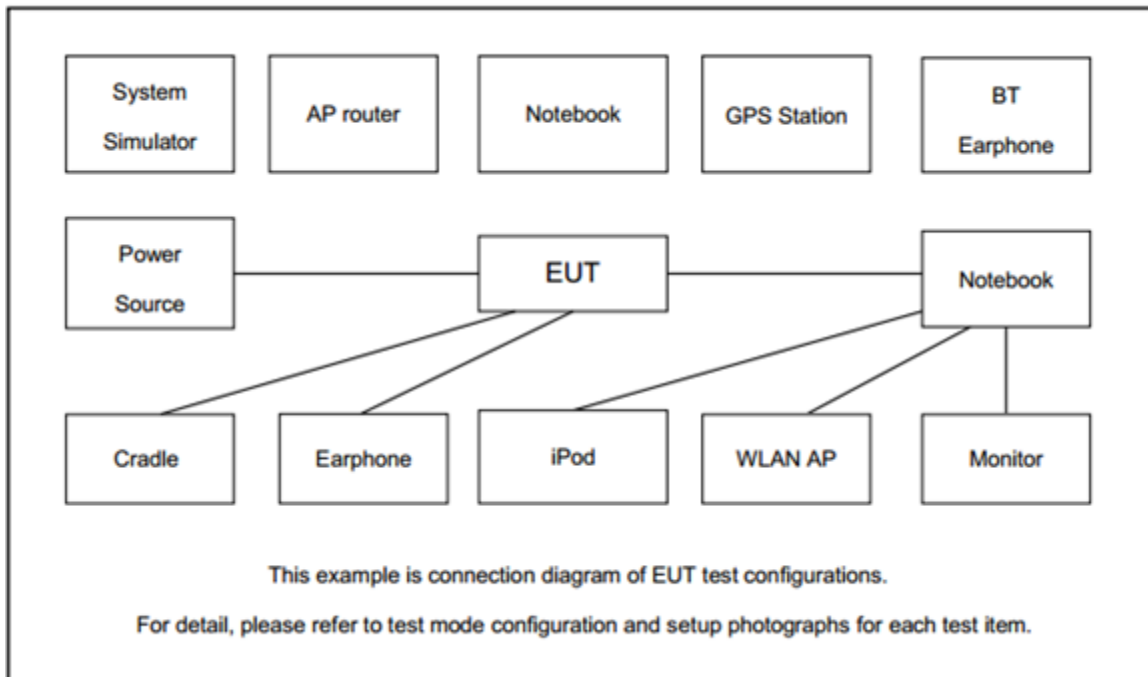

2.3 Support Unit used in test configuration

Item	Equipment	Trade Name	Model No.	FCC ID	Data Cable	Power Cord
1.	System Simulator	R&S	CMU 200	N/A	N/A	Unshielded, 1.8 m

2.4 Measurement Results Explanation Example

For all conducted test items:

The offset level is set in the spectrum analyzer to compensate the RF cable loss and attenuator factor between RF conducted output port and spectrum analyzer. With the offset compensation, the spectrum analyzer reading level will be exactly the RF output level.

The spectrum analyzer offset is derived from RF cable loss and attenuator factor.

Offset = RF cable loss + attenuator factor.

The following shows an offset computation example with RF cable loss 4.2 dB and a 10dB attenuator.

Example :

$$\begin{aligned} \text{Offset}(dB) &= \text{RF cable loss}(dB) + \text{attenuator factor}(dB). \\ &= 4.2 + 10 = 14.2 \text{ (dB)} \end{aligned}$$



2.5 Frequency List of Low/Middle/High Channels

Frequency List				
Band	Channel/Frequency(MHz)	Lowest	Middle	Highest
GSM850	Channel	128	189	251
	Frequency	824.2	836.4	848.8
WCDMA Band V	Channel	4132	4182	4233
	Frequency	826.4	836.4	846.6
GSM1900	Channel	512	661	810
	Frequency	1850.2	1880.0	1909.8
WCDMA Band II	Channel	9262	9400	9538
	Frequency	1852.4	1880.0	1907.6
WCDMA Band IV	Channel	1312	1413	1513
	Frequency	1712.4	1732.6	1752.6

3 Conducted Test Result

3.1 Measuring Instruments

See list of measuring instruments of this test report.

3.2 Test Setup

Conducted Output Power

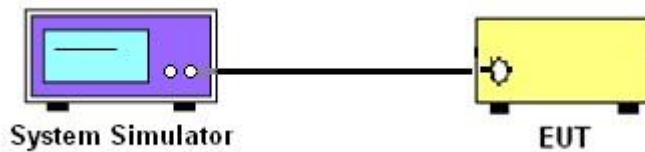

Peak-to-Average Ratio, Occupied Bandwidth, Conducted Band-Edge and Conducted Spurious Emission

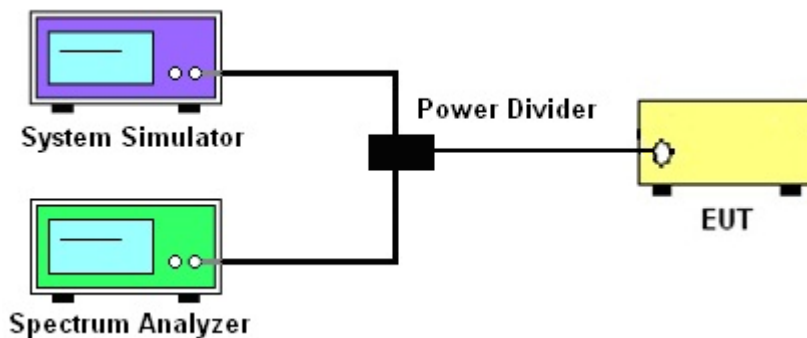

Frequency Stability

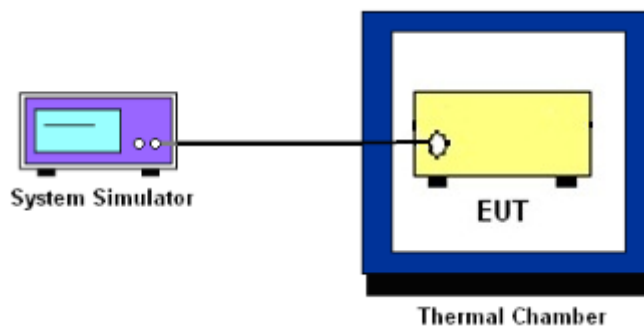

3.3 Test Result of Conducted Test

Please refer to Appendix A.



3.4 Conducted Output Power and ERP/EIRP

Description of the Conducted Output Power and ERP/EIRP

A system simulator was used to establish communication with the EUT. Its parameters were set to enforce EUT transmitting at the maximum power. The measured power in the radio frequency on the transmitter output terminals shall be reported.

The ERP of mobile transmitters must not exceed 7 Watts for GSM850 and WCDMA Band V.

The EIRP of mobile transmitters must not exceed 2 Watts for GSM1900 and WCDMA Band II.

The EIRP of mobile transmitters must not exceed 1 Watts for WCDMA Band IV.

According to KDB 412172 D01 Power Approach,

$EIRP = P_T + G_T - L_C$, $ERP = EIRP - 2.15$, where

P_T = transmitter output power in dBm

G_T = gain of the transmitting antenna in dBi

L_C = signal attenuation in the connecting cable between the transmitter and antenna in dB

Test Procedures

1. The transmitter output port was connected to the system simulator.
2. Set EUT at maximum power through system simulator.
3. Select lowest, middle, and highest channels for each band and different modulation.
4. Measure the maximum burst average power for GSM and maximum average power for other modulation signal.



3.5 Peak-to-Average Ratio

Description of the PAR Measurement

The peak-to-average ratio (PAR) of the transmission may not exceed 13 dB.

Test Procedures

1. The testing follows FCC KDB 971168 D01 v03 Section 5.7.1.
2. The EUT was connected to spectrum analyzer and system simulator via a power divider.
3. Set EUT to transmit at maximum output power.
4. When the duty cycle is less than 98%, then signal gating will be implemented on the spectrum analyzer by triggering from the system simulator.
5. Set the CCDF (Complementary Cumulative Distribution Function) option of the spectrum analyzer.
Record the maximum PAPR level associated with a probability of 0.1%.



3.6 99% Occupied Bandwidth and 26dB Bandwidth Measurement

Description of 99% Occupied Bandwidth and 26dB Bandwidth Measurement

The occupied bandwidth is the width of a frequency band such that, below the lower and above the upper frequency limits, the mean powers emitted are each equal to a specified percentage 0.5% of the total mean transmitted power.

The 26 dB emission bandwidth is defined as the frequency range between two points, one above and one below the carrier frequency, at which the spectral density of the emission is attenuated 26 dB below the maximum in-band spectral density of the modulated signal. Spectral density (power per unit bandwidth) is to be measured with a detector of resolution bandwidth equal to approximately 1.0% of the emission bandwidth.

Test Procedures

1. The testing follows FCC KDB 971168 v03 Section 4.2.
2. The EUT was connected to spectrum analyzer and system simulator via a power divider.
3. The spectrum analyzer center frequency is set to the nominal EUT channel center frequency. The span range for the spectrum analyzer shall be between two and five times the anticipated OBW.
4. The nominal resolution bandwidth (RBW) shall be in the range of 1 to 5 % of the anticipated OBW, and the VBW shall be at least 3 times the RBW.
5. Set the detection mode to peak, and the trace mode to max hold.
6. Determine the reference value: Set the EUT to transmit a modulated signal. Allow the trace to stabilize. Set the spectrum analyzer marker to the highest level of the displayed trace.
(this is the reference value)
7. Determine the “-26 dB down amplitude” as equal to (Reference Value – X).
8. Place two markers, one at the lowest and the other at the highest frequency of the envelope of the spectral display such that each marker is at or slightly below the “-X dB down amplitude” determined in step 6. If a marker is below this “-X dB down amplitude” value it shall be placed as close as possible to this value. The OBW is the positive frequency difference between the two markers.
9. Use the 99 % power bandwidth function of the spectrum analyzer and report the measured bandwidth.



3.7 Conducted Band Edge

Description of Conducted Band Edge Measurement

The power of any emission outside of the authorized operating frequency ranges must be lower than the transmitter power (P) by a factor of at least $43 + 10 \log (P)$ dB.

3.7.1 Test Procedures

1. The testing follows FCC KDB 971168 D01 v03 Section 6.0.
2. The EUT was connected to the spectrum analyzer and system simulator via a power divider.
3. The RF output of EUT was connected to the spectrum analyzer by an RF cable and attenuator. The path loss was compensated to the results for each measurement.
4. The band edges of low and high channels for the highest RF powers were measured.
5. The RF fundamental frequency should be excluded against the limit line in the operating frequency band.
6. The limit line is derived from $43 + 10\log(P)$ dB below the transmitter power P(Watts)



3.8 Conducted Spurious Emission

Description of Conducted Spurious Emission Measurement

The power of any emission outside of the authorized operating frequency ranges must be lower than the transmitter power (P) by a factor of at least $43 + 10 \log (P)$ dB.

It is measured by means of a calibrated spectrum analyzer and scanned from 30 MHz up to a frequency including its 10th harmonic.

Test Procedures

1. The testing follows FCC KDB 971168 D01 v03 Section 6.0.
2. The EUT was connected to the spectrum analyzer and system simulator via a power divider.
3. The RF output of EUT was connected to the spectrum analyzer by an RF cable and attenuator. The path loss was compensated to the results for each measurement.
4. The middle channel for the highest RF power within the transmitting frequency was measured.
5. The conducted spurious emission for the whole frequency range was taken.
6. The RF fundamental frequency should be excluded against the limit line in the operating frequency band.
7. The limit line is derived from $43 + 10\log(P)$ dB below the transmitter power P(Watts)



3.9 Frequency Stability

Description of Frequency Stability Measurement

The frequency stability shall be measured by variation of ambient temperature and variation of primary supply voltage to ensure that the fundamental emission stays within the authorized frequency block. The frequency stability of the transmitter shall be maintained within $\pm 0.00025\%$ ($\pm 2.5\text{ppm}$) of the center frequency.

3.9.1 Test Procedures for Temperature Variation

1. The testing follows FCC KDB 971168 D01 v03 Section 9.0.
2. The EUT was set up in the thermal chamber and connected with the system simulator.
3. With power OFF, the temperature was decreased to -30°C and the EUT was stabilized before testing. Power was applied and the maximum change in frequency was recorded within one minute.
4. With power OFF, the temperature was raised in 10°C steps up to 50°C . The EUT was stabilized at each step for at least half an hour. Power was applied and the maximum frequency change was recorded within one minute.

3.9.2 Test Procedures for Voltage Variation

1. The testing follows FCC KDB 971168 D01 v03 Section 9.0.
2. The EUT was placed in a temperature chamber at $20\pm 5^{\circ}\text{C}$ and connected with the system simulator.
3. The power supply voltage to the EUT was varied from 85% to 115% of the nominal value measured at the input to the EUT.
4. The variation in frequency was measured for the worst case.

4 Radiated Test Items

4.1 Measuring Instruments

See list of measuring instruments of this test report.

4.2 Test Setup

For radiated test from 30MHz to 1GHz

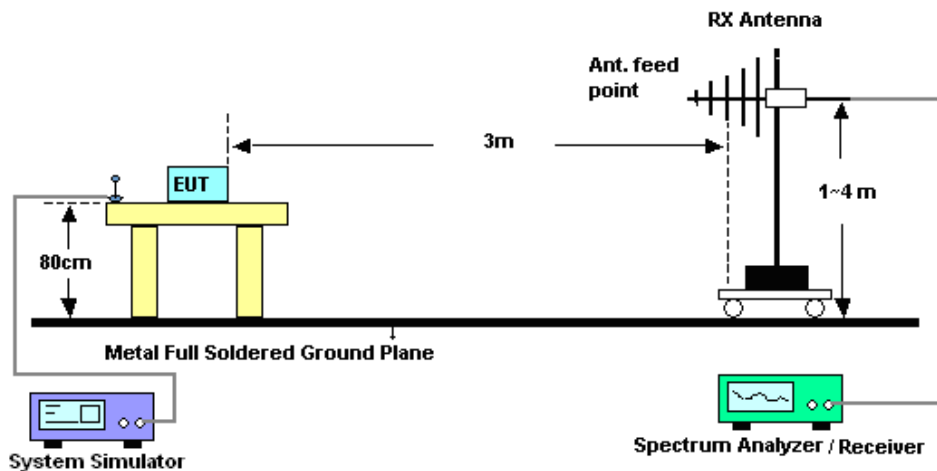

For radiated test above 1GHz

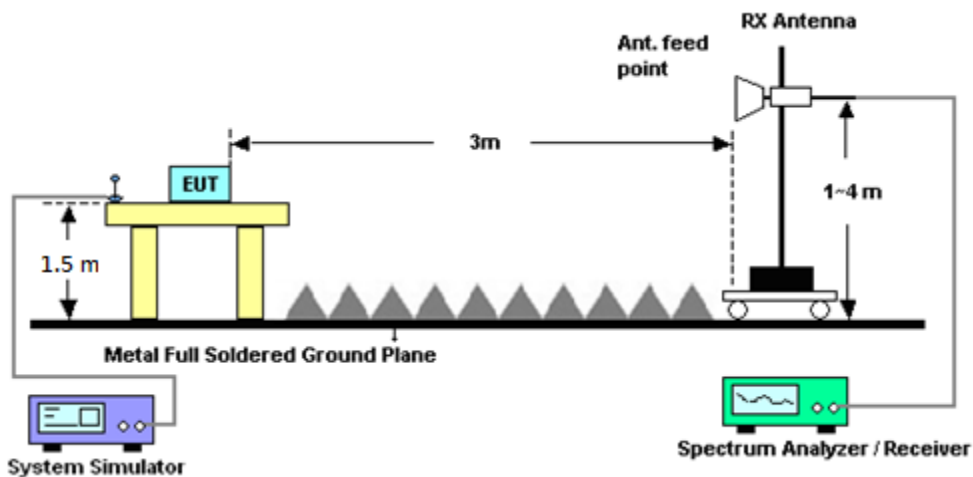

4.3 Test Result of Radiated Test

Please refer to Appendix B.



4.4 Field Strength of Spurious Radiation Measurement

Description of Field Strength of Spurious Radiated Measurement

The power of any emission outside of the authorized operating frequency ranges must be attenuated below the transmitter power (P) by a factor of at least $43 + 10 \log (P)$ dB. The spectrum is scanned from 30 MHz up to a frequency including its 10th harmonic.

Test Procedures

1. The testing follows FCC KDB 971168 D01 v03 Section 5.8 and ANSI / TIA-603-D-2010 Section 2.2.12.
2. The EUT was placed on a rotatable wooden table 0.8 meters for frequency below 1GHz and 1.5 meter for frequency above 1GHz above the ground.
3. The EUT was set 3 meters from the receiving antenna, which was mounted on the antenna tower.
4. The table was rotated 360 degrees to determine the position of the highest spurious emission.
5. The height of the receiving antenna is varied between one meter and four meters to search for the maximum spurious emission for both horizontal and vertical polarizations.
6. Make the measurement with the spectrum analyzer's RBW = 1MHz, VBW = 3MHz, taking record of maximum spurious emission.
7. A horn antenna was substituted in place of the EUT and was driven by a signal generator.
8. Tune the output power of signal generator to the same emission level with EUT maximum spurious emission.
9. Taking the record of output power at antenna port.
10. Repeat step 7 to step 8 for another polarization.
11. $EIRP (dBm) = S.G. Power - Tx Cable Loss + Tx Antenna Gain$
12. $ERP (dBm) = EIRP - 2.15$
13. The RF fundamental frequency should be excluded against the limit line in the operating frequency band.
14. The limit line is derived from $43 + 10\log(P)$ dB below the transmitter power P(Watts)



5 List of Measuring Equipment

Instrument	Manufacturer	Model No.	Serial No.	Characteristics	Calibration Date	Test Date	Due Date	Remark
Spectrum Analyzer	Rohde & Schwarz	FSP30	101329	9kHz~30GHz	Jun. 26, 2017	Mar. 24, 2018~ Mar. 30, 2018	Jun. 25, 2018	Conducted (TH03-HY)
Temperature Chamber	ESPEC	SU-641	92013721	-30℃ ~70℃	Dec. 06, 2017	Mar. 24, 2018~ Mar. 30, 2018	Dec. 05, 2019	Conducted (TH03-HY)
Programmable Power Supply	GW Instek	PSS-2005	EL883644	Voltage:0~20V; Current:0~5A	Dec. 06, 2017	Mar. 24, 2018~ Mar. 30, 2018	Dec. 05, 2019	Conducted (TH03-HY)
Base Station (Measure)	Rohde & Schwarz	CMU200	117995	GSM / GPRS / WCDMA / CDMA	Aug. 09, 2017	Mar. 24, 2018~ Mar. 30, 2018	Aug. 08, 2018	Conducted (TH03-HY)
Amplifier	MITEQ	TTA1840-35-H G	1871923	18GHz~40GHz, VSWR : 2.5:1 max	Jul. 18, 2017	Mar. 23, 2018~ Mar. 29, 2018	Jul. 17, 2018	Radiation (03CH11-HY)
Amplifier	SONOMA	310N	187312	9kHz~1GHz	Nov. 10, 2016	Mar. 23, 2018~ Mar. 29, 2018	Nov. 09, 2018	Radiation (03CH11-HY)
Bilog Antenna	TESEQ	CBL 6111D&N-6-06	35414&AT-N0 602	30MHz~1GHz	Oct. 14, 2017	Mar. 23, 2018~ Mar. 29, 2018	Oct. 13, 2018	Radiation (03CH11-HY)
Horn Antenna	SCHWARZBE CK	BBHA 9120 D	9120D-1326	1GHz ~ 18GHz	Oct. 16, 2017	Mar. 23, 2018~ Mar. 29, 2018	Oct. 15, 2018	Radiation (03CH11-HY)
Horn Antenna	SCHWARZBE CK	BBHA 9120D	9120D-1328	1GHz ~ 18GHz	Oct. 20, 2017	Mar. 23, 2018~ Mar. 29, 2018	Oct. 19, 2018	Radiation (03CH11-HY)
Loop Antenna	Rohde & Schwarz	HFH2-Z2	100488	9 kHz~30 MHz	Nov. 23, 2017	Mar. 23, 2018~ Mar. 29, 2018	Nov. 22, 2019	Radiation (03CH11-HY)
Preamplifier	Keysight	83017A	MY53270080	1GHz~26.5GHz	Nov. 10, 2016	Mar. 23, 2018~ Mar. 29, 2018	Nov. 09, 2018	Radiation (03CH11-HY)
Spectrum Analyzer	Keysight	N9010A	MY54200486	10Hz ~ 44GHz	Oct. 19, 2017	Mar. 23, 2018~ Mar. 29, 2018	Oct. 18, 2018	Radiation (03CH11-HY)
Filter	Wainwright	WHKX12-1080 -1200-1500-60 SS	SN2	1.2G High Pass	Sep. 18, 2017	Mar. 23, 2018~ Mar. 29, 2018	Sep. 17, 2018	Radiation (03CH11-HY)
Filter	Wainwright	WHKX12-2700 -3000-18000-6 0SS	SN3	2.7G High Pass	Sep. 18, 2017	Mar. 23, 2018~ Mar. 29, 2018	Sep. 17, 2018	Radiation (03CH11-HY)
Antenna Mast	EMEC	AM-BS-4500-B	N/A	1~4m	N/A	Mar. 23, 2018~ Mar. 29, 2018	N/A	Radiation (03CH11-HY)
Turn Table	EMEC	TT 2000	N/A	0~360 Degree	N/A	Mar. 23, 2018~ Mar. 29, 2018	N/A	Radiation (03CH11-HY)
EMI Test Receiver	Keysight	N9038A(MXE)	MY57290111	3Hz~26.5GHz	Nov. 02, 2017	Mar. 23, 2018~ Mar. 29, 2018	Nov. 01, 2018	Radiation (03CH11-HY)
SHF-EHF Horn Antenna	SCHWARZBE CK	BBHA 9170	BBHA917057 6	18GHz- 40GHz	Apr. 27, 2017	Mar. 23, 2018~ Mar. 29, 2018	Apr. 26, 2018	Radiation (03CH11-HY)
SHF-EHF Horn Antenna	SCHWARZBE CK	BBHA 9170	BBHA917058 4	18GHz- 40GHz	Nov. 27, 2017	Mar. 23, 2018~ Mar. 29, 2018	Nov. 26, 2018	Radiation (03CH11-HY)
Test Software	Audix	E3 6.2009-8-24	RK-001042	N/A	N/A	Mar. 23, 2018~ Mar. 29, 2018	N/A	Radiation (03CH11-HY)



6 Uncertainty of Evaluation

Uncertainty of Radiated Emission Measurement (30 MHz ~ 1000 MHz)

Measuring Uncertainty for a Level of Confidence of 95% ($U = 2Uc(y)$)	3.37
-------------------------------------------------------------------------	------

Uncertainty of Radiated Emission Measurement (1 GHz ~ 18 GHz)

Measuring Uncertainty for a Level of Confidence of 95% ($U = 2Uc(y)$)	3.67
-------------------------------------------------------------------------	------

Uncertainty of Radiated Emission Measurement (18 GHz ~ 40 GHz)

Measuring Uncertainty for a Level of Confidence of 95% ($U = 2Uc(y)$)	4.03
-------------------------------------------------------------------------	------



Appendix A. Test Results of Conducted Test

Conducted Output Power(Average power)

Conducted Power (*Unit: dBm)						
Band	GSM850			GSM1900		
Channel	128	189	251	512	661	810
Frequency	824.2	836.4	848.8	1850.2	1880	1909.8
GSM	33.20	33.26	33.70	29.70	29.83	29.89
GPRS class 8	33.31	33.49	33.73	29.73	29.86	29.92
GPRS class 10	30.79	30.87	31.20	27.05	27.18	27.45
GPRS class 11	29.36	29.35	29.61	25.43	25.55	25.61
GPRS class 12	27.94	28.05	28.30	24.26	24.40	24.42
EGPRS class 8	26.83	26.91	27.26	25.35	25.40	25.50
EGPRS class 10	26.55	26.87	27.01	25.15	25.31	25.41
EGPRS class 11	26.39	26.56	26.89	25.00	25.11	25.30
EGPRS class 12	26.06	26.40	26.60	24.85	24.91	24.98

Conducted Power (*Unit: dBm)						
Band	WCDMA Band V			WCDMA Band II		
Channel	4132	4182	4233	9262	9400	9538
Frequency	826.4	836.4	846.6	1852.4	1880	1907.6
RMC 12.2K	24.40	24.79	24.70	22.68	22.77	22.54
HSDPA Subtest-1	23.72	23.73	23.62	21.58	21.72	21.48
HSDPA Subtest-2	23.75	23.74	23.66	21.60	21.74	21.50
HSDPA Subtest-3	23.24	23.27	23.16	21.14	21.27	21.02
HSDPA Subtest-4	23.23	23.26	23.17	21.14	21.26	21.02
HSUPA Subtest-1	23.44	23.43	23.33	21.39	21.50	21.29
HSUPA Subtest-2	21.44	21.44	21.32	19.39	19.51	19.28
HSUPA Subtest-3	22.44	22.44	22.32	20.41	20.51	20.29
HSUPA Subtest-4	21.42	21.42	21.33	19.41	19.50	19.31
HSUPA Subtest-5	23.50	23.40	23.30	21.38	21.48	21.28

Conducted Power (*Unit: dBm)			
Band	WCDMA Band IV		
Channel	1312	1413	1513
Frequency	1712.4	1732.6	1752.6
RMC 12.2K	24.18	24.29	24.18
HSDPA Subtest-1	23.08	23.36	23.19
HSDPA Subtest-2	23.08	23.38	23.20
HSDPA Subtest-3	22.58	22.88	22.70
HSDPA Subtest-4	22.57	22.87	22.69
HSUPA Subtest-1	23.06	23.36	23.34
HSUPA Subtest-2	21.07	21.36	21.34
HSUPA Subtest-3	22.06	22.35	22.25
HSUPA Subtest-4	21.08	21.35	21.35
HSUPA Subtest-5	23.10	23.40	23.32



A2. GSM

Peak-to-Average Ratio

Mode	GSM850		Limit: 13dB
Mod.	GPRS class 8	EDGE class 8	Result
Lowest CH	0.44	3.60	PASS
Middle CH	0.48	3.64	
Highest CH	0.44	3.64	

Mode	GSM1900		Limit: 13dB
Mod.	GPRS class 8	EDGE class 8	Result
Lowest CH	0.60	3.48	PASS
Middle CH	0.64	3.40	
Highest CH	0.68	3.60	



GSM850 (GPRS class 8)	GSM850 (EDGE class 8)
<p align="center">Lowest Channel</p> <p>Center 824.2 MHz 2 dB/ Mean Pwr + 20 dB</p> <p>Complementary Cumulative Distribution Function (100000 samples)</p> <p>Trace 1</p> <p>Mean 32.33 dBm Peak 32.83 dBm Crest 0.50 dB</p> <p>10 % 0.32 dB 1 % 0.40 dB .1 % 0.44 dB .01 % 0.44 dB</p> <p>Date: 24.MAR.2018 10:01:16</p>	<p align="center">Lowest Channel</p> <p>Center 824.2 MHz 2 dB/ Mean Pwr + 20 dB</p> <p>Complementary Cumulative Distribution Function (100000 samples)</p> <p>Trace 1</p> <p>Mean 26.35 dBm Peak 30.01 dBm Crest 3.66 dB</p> <p>10 % 2.72 dB 1 % 3.36 dB .1 % 3.60 dB .01 % 3.64 dB</p> <p>Date: 24.MAR.2018 10:15:56</p>
<p align="center">Middle Channel</p> <p>Center 836.4 MHz 2 dB/ Mean Pwr + 20 dB</p> <p>Complementary Cumulative Distribution Function (100000 samples)</p> <p>Trace 1</p> <p>Mean 32.09 dBm Peak 32.55 dBm Crest 0.46 dB</p> <p>10 % 0.32 dB 1 % 0.40 dB .1 % 0.48 dB .01 % 0.48 dB</p> <p>Date: 24.MAR.2018 10:01:33</p>	<p align="center">Middle Channel</p> <p>Center 836.4 MHz 2 dB/ Mean Pwr + 20 dB</p> <p>Complementary Cumulative Distribution Function (100000 samples)</p> <p>Trace 1</p> <p>Mean 25.95 dBm Peak 29.72 dBm Crest 3.77 dB</p> <p>10 % 2.72 dB 1 % 3.44 dB .1 % 3.64 dB .01 % 3.72 dB</p> <p>Date: 24.MAR.2018 10:16:12</p>
<p align="center">Highest Channel</p> <p>Center 848.8 MHz 2 dB/ Mean Pwr + 20 dB</p> <p>Complementary Cumulative Distribution Function (100000 samples)</p> <p>Trace 1</p> <p>Mean 32.06 dBm Peak 32.55 dBm Crest 0.49 dB</p> <p>10 % 0.32 dB 1 % 0.40 dB .1 % 0.44 dB .01 % 0.48 dB</p> <p>Date: 24.MAR.2018 10:01:47</p>	<p align="center">Highest Channel</p> <p>Center 848.8 MHz 2 dB/ Mean Pwr + 20 dB</p> <p>Complementary Cumulative Distribution Function (100000 samples)</p> <p>Trace 1</p> <p>Mean 25.68 dBm Peak 29.37 dBm Crest 3.69 dB</p> <p>10 % 2.72 dB 1 % 3.48 dB .1 % 3.64 dB .01 % 3.72 dB</p> <p>Date: 24.MAR.2018 10:16:29</p>



GSM1900 (GPRS class 8)	GSM1900 (EDGE class 8)
<p align="center">Lowest Channel</p> <p>Center 1.8502 GHz 2 dB/ Mean Pwr = 20 dB</p> <p>Complementary Cumulative Distribution Function (100000 samples)</p> <p>Trace 1</p> <p>Mean 26.14 dBm Peak 26.78 dBm Crest 0.64 dB</p> <p>10 % 0.44 dB 1 % 0.56 dB .1 % 0.60 dB .01 % 0.64 dB</p> <p>Date: 30.MAR.2018 14:44:21</p>	<p align="center">Lowest Channel</p> <p>Center 1.8502 GHz 2 dB/ Mean Pwr = 20 dB</p> <p>Complementary Cumulative Distribution Function (100000 samples)</p> <p>Trace 1</p> <p>Mean 25.14 dBm Peak 28.76 dBm Crest 3.62 dB</p> <p>10 % 2.60 dB 1 % 3.32 dB .1 % 3.48 dB .01 % 3.56 dB</p> <p>Date: 30.MAR.2018 14:27:17</p>
<p align="center">Middle Channel</p> <p>Center 1.88 GHz 2 dB/ Mean Pwr = 20 dB</p> <p>Complementary Cumulative Distribution Function (100000 samples)</p> <p>Trace 1</p> <p>Mean 26.00 dBm Peak 26.71 dBm Crest 0.71 dB</p> <p>10 % 0.44 dB 1 % 0.60 dB .1 % 0.64 dB .01 % 0.68 dB</p> <p>Date: 30.MAR.2018 14:44:48</p>	<p align="center">Middle Channel</p> <p>Center 1.88 GHz 2 dB/ Mean Pwr = 20 dB</p> <p>Complementary Cumulative Distribution Function (100000 samples)</p> <p>Trace 1</p> <p>Mean 24.96 dBm Peak 28.48 dBm Crest 3.51 dB</p> <p>10 % 2.52 dB 1 % 3.24 dB .1 % 3.40 dB .01 % 3.48 dB</p> <p>Date: 30.MAR.2018 14:27:38</p>
<p align="center">Highest Channel</p> <p>Center 1.9098 GHz 2 dB/ Mean Pwr = 20 dB</p> <p>Complementary Cumulative Distribution Function (100000 samples)</p> <p>Trace 1</p> <p>Mean 25.90 dBm Peak 26.57 dBm Crest 0.67 dB</p> <p>10 % 0.48 dB 1 % 0.60 dB .1 % 0.68 dB .01 % 0.68 dB</p> <p>Date: 30.MAR.2018 14:45:09</p>	<p align="center">Highest Channel</p> <p>Center 1.9098 GHz 2 dB/ Mean Pwr = 20 dB</p> <p>Complementary Cumulative Distribution Function (100000 samples)</p> <p>Trace 1</p> <p>Mean 24.66 dBm Peak 28.41 dBm Crest 3.74 dB</p> <p>10 % 2.64 dB 1 % 3.32 dB .1 % 3.60 dB .01 % 3.68 dB</p> <p>Date: 30.MAR.2018 14:27:54</p>



26dB Bandwidth

Mode	GSM850	
Mod.	GPRS class 8	EDGE class 8
Lowest CH	0.312	0.300
Middle CH	0.310	0.305
Highest CH	0.317	0.294

Mode	GSM1900	
Mod.	GPRS class 8	EDGE class 8
Lowest CH	0.299	0.305
Middle CH	0.305	0.311
Highest CH	0.314	0.307

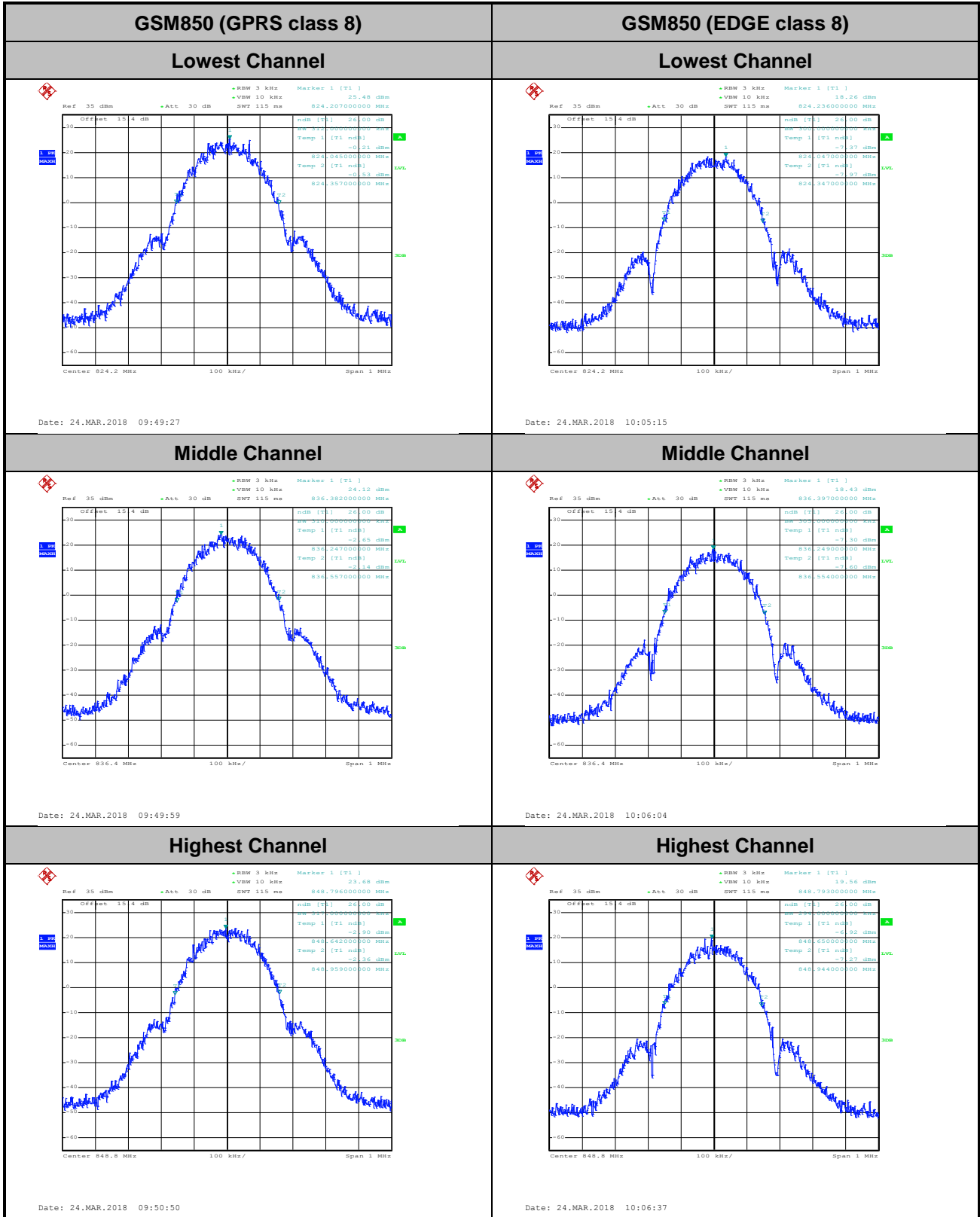

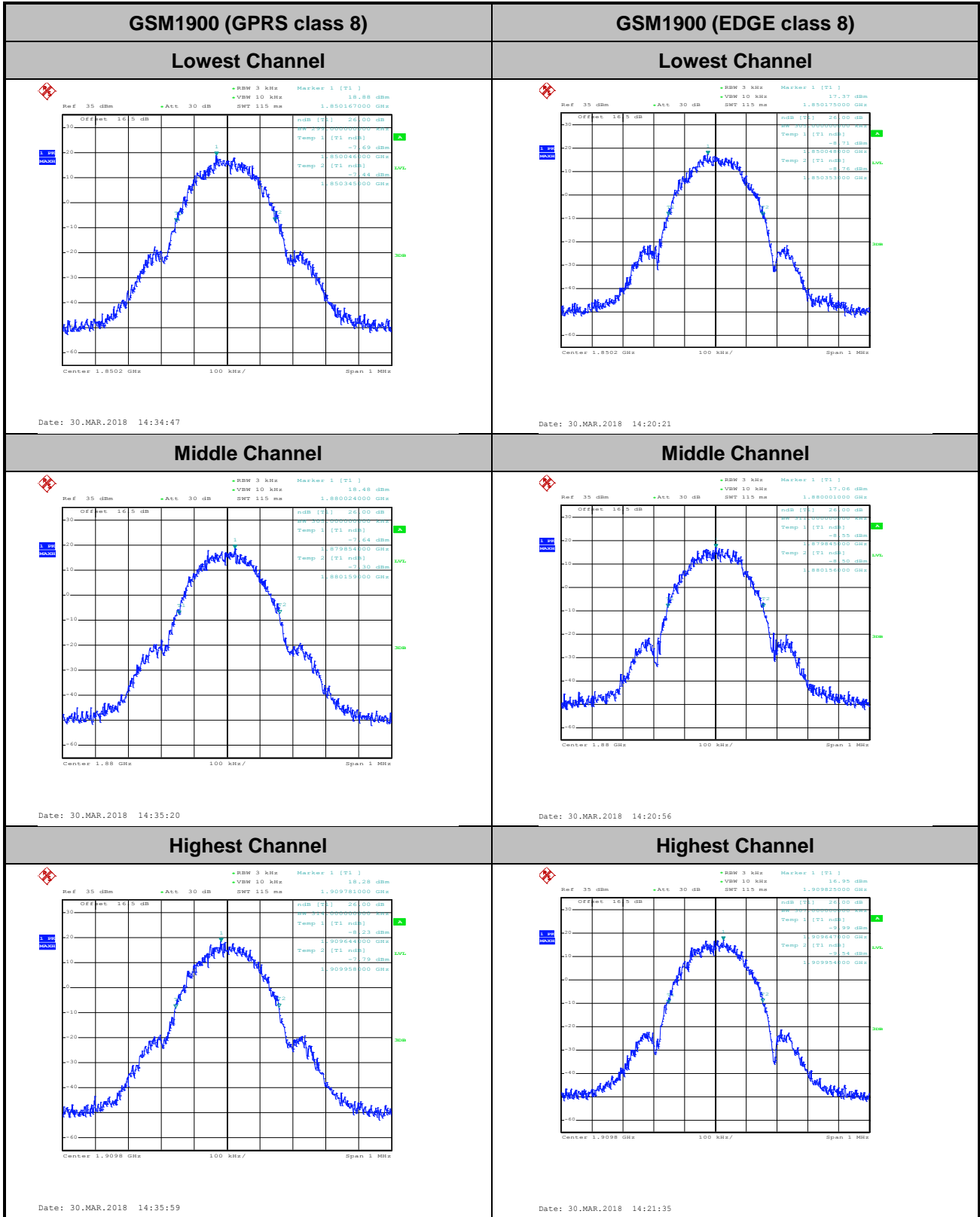



Occupied Bandwidth

Mode	GSM850	
Mod.	GPRS class 8	EDGE class 8
Lowest CH	0.245	0.244
Middle CH	0.246	0.246
Highest CH	0.243	0.243

Mode	GSM1900	
Mod.	GPRS class 8	EDGE class 8
Lowest CH	0.244	0.250
Middle CH	0.243	0.250
Highest CH	0.246	0.246

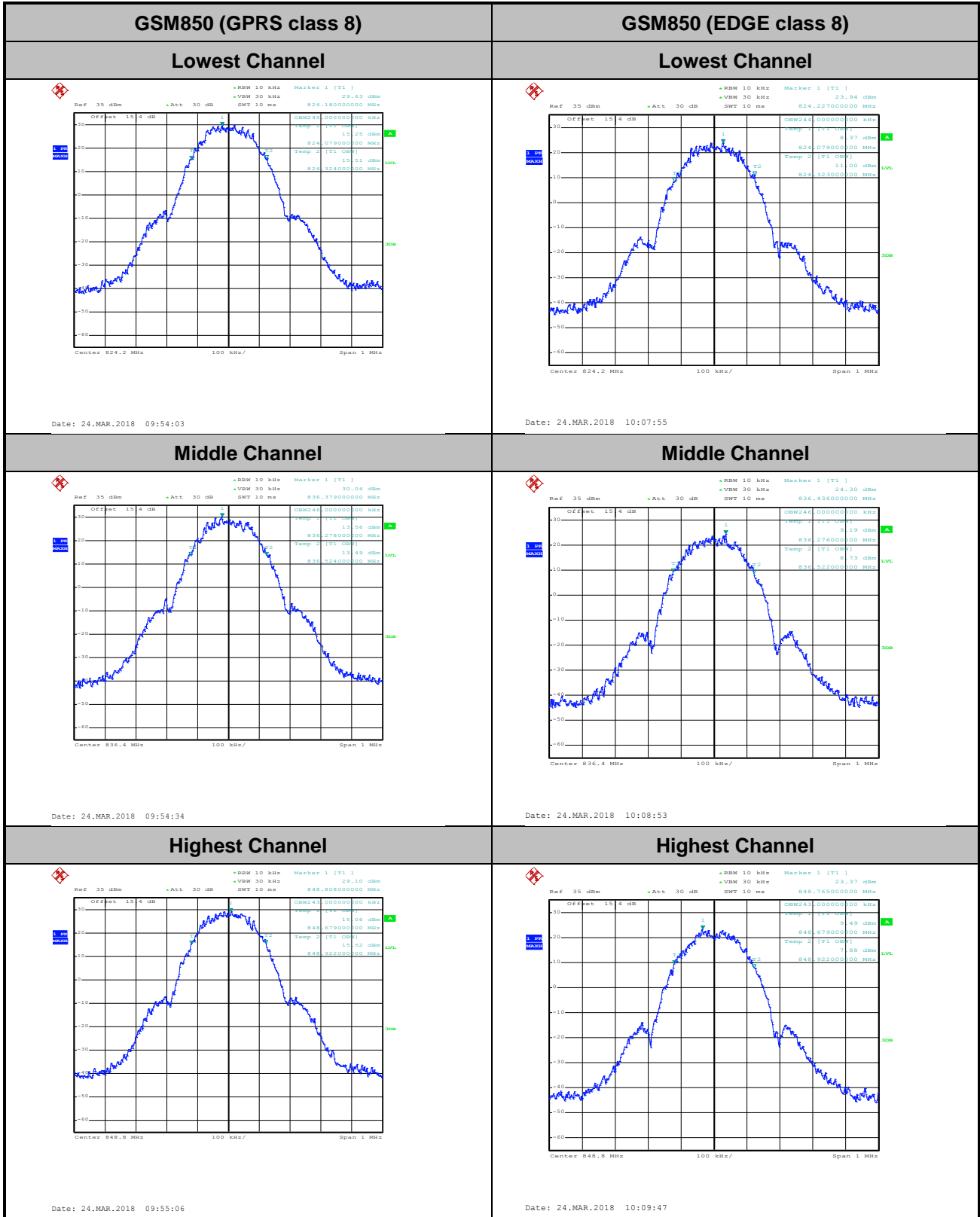

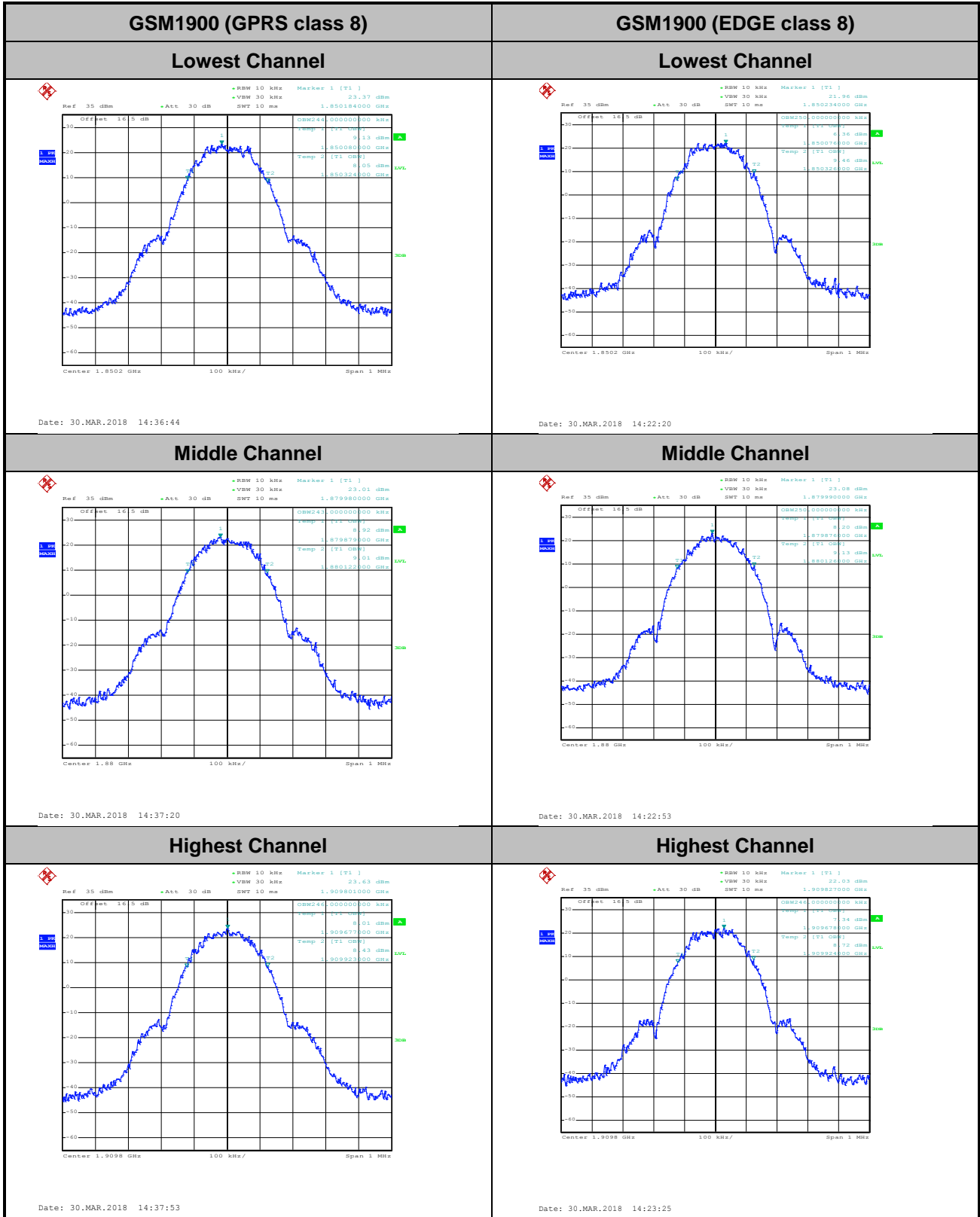



Conducted Band Edge

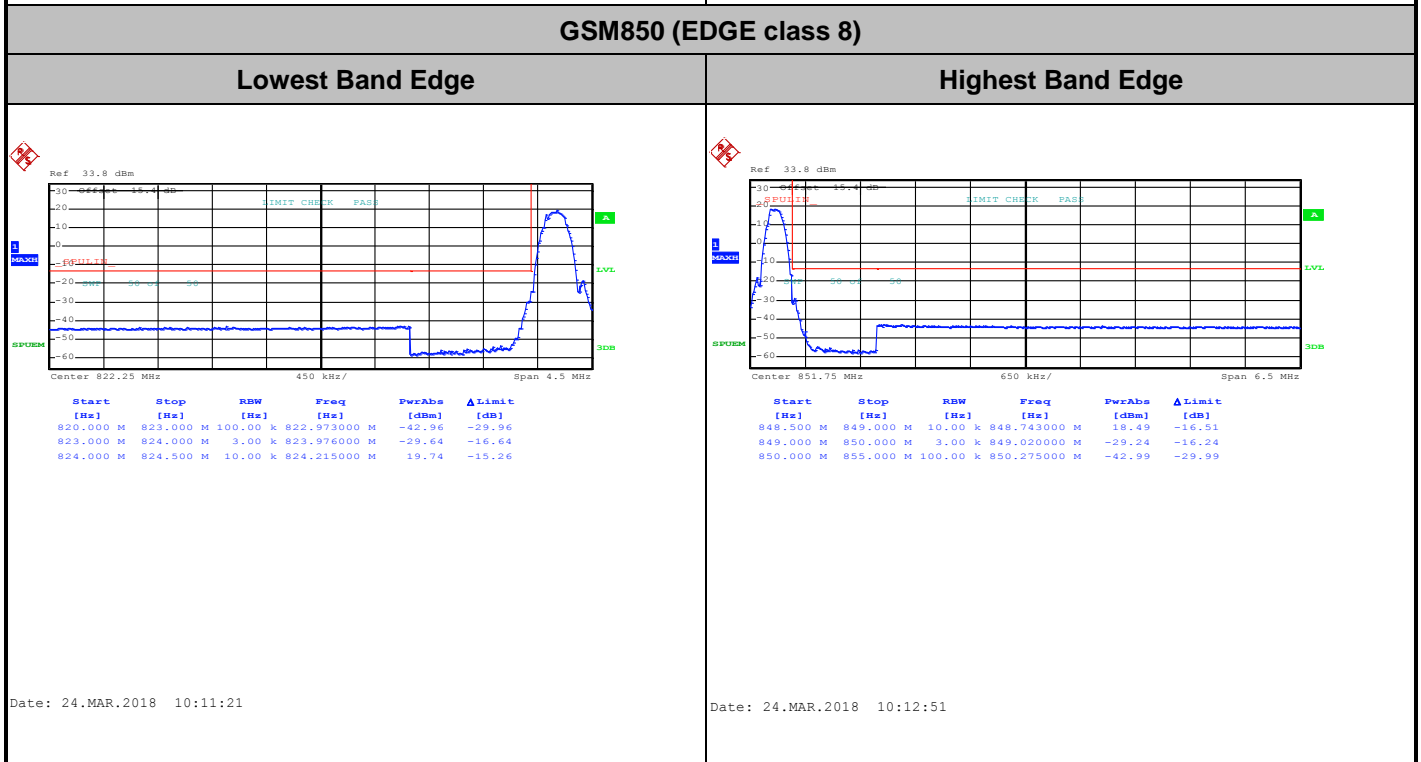
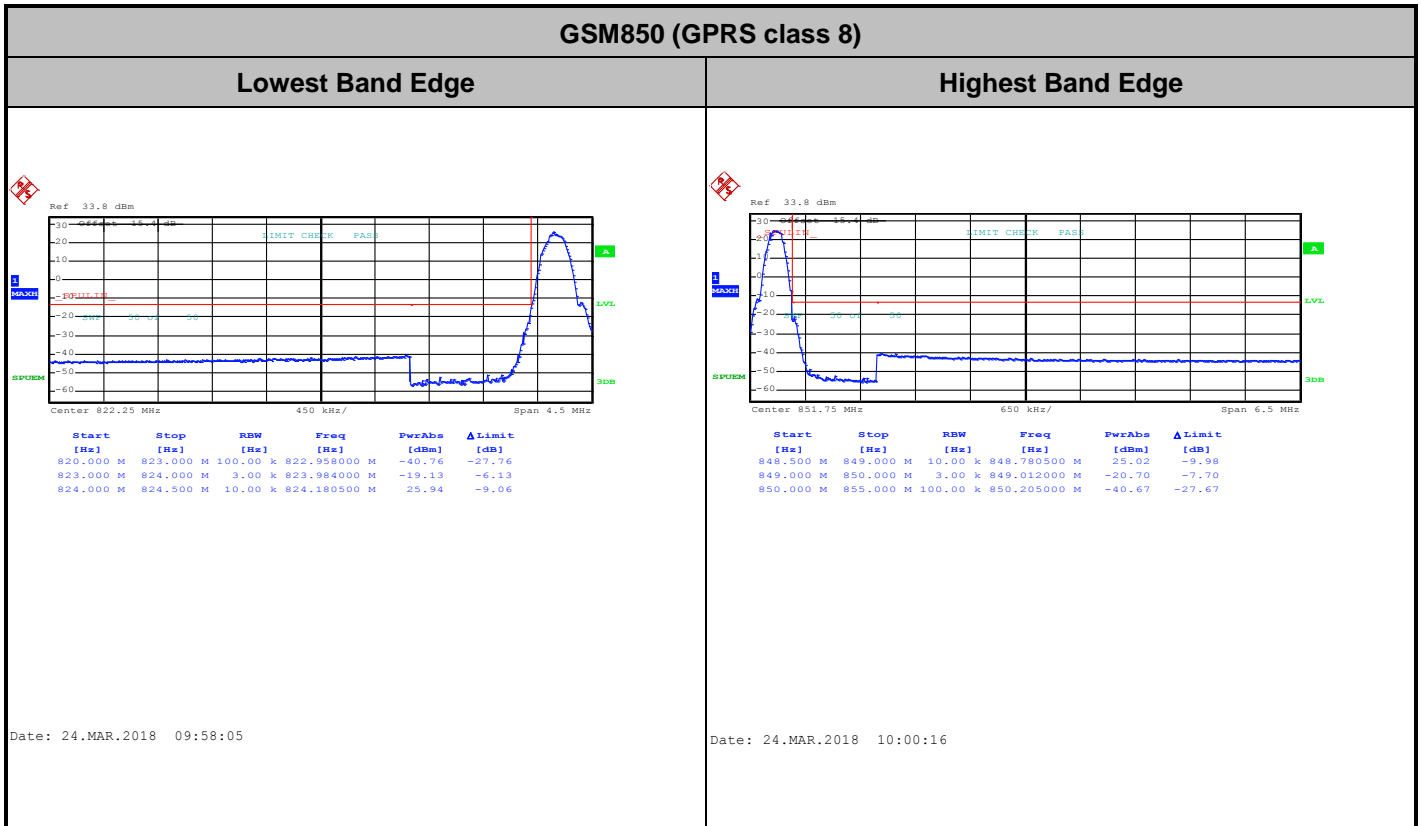



GSM1900 (GPRS class 8)

Lowest Band Edge

Highest Band Edge

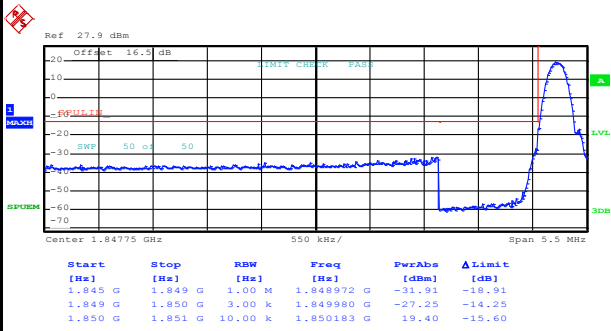

Date: 30.MAR.2018 14:39:43

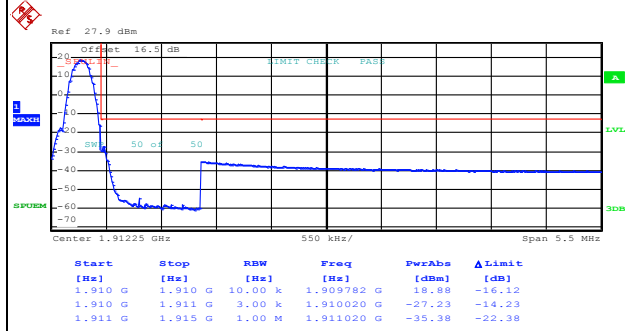

Date: 30.MAR.2018 14:41:15

GSM1900 (EDGE class 8)

Lowest Band Edge

Highest Band Edge

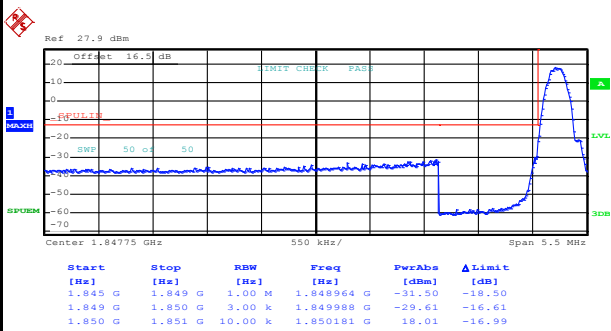

Date: 30.MAR.2018 14:25:00

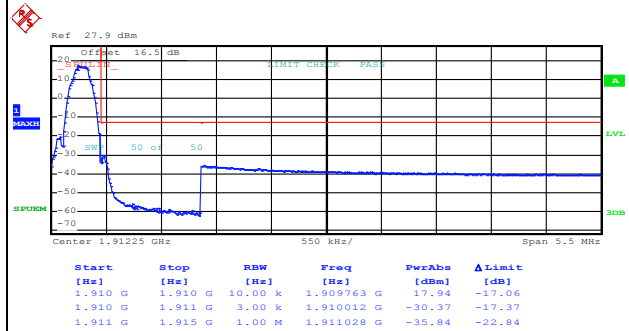

Date: 30.MAR.2018 14:26:32



Conducted Spurious Emission

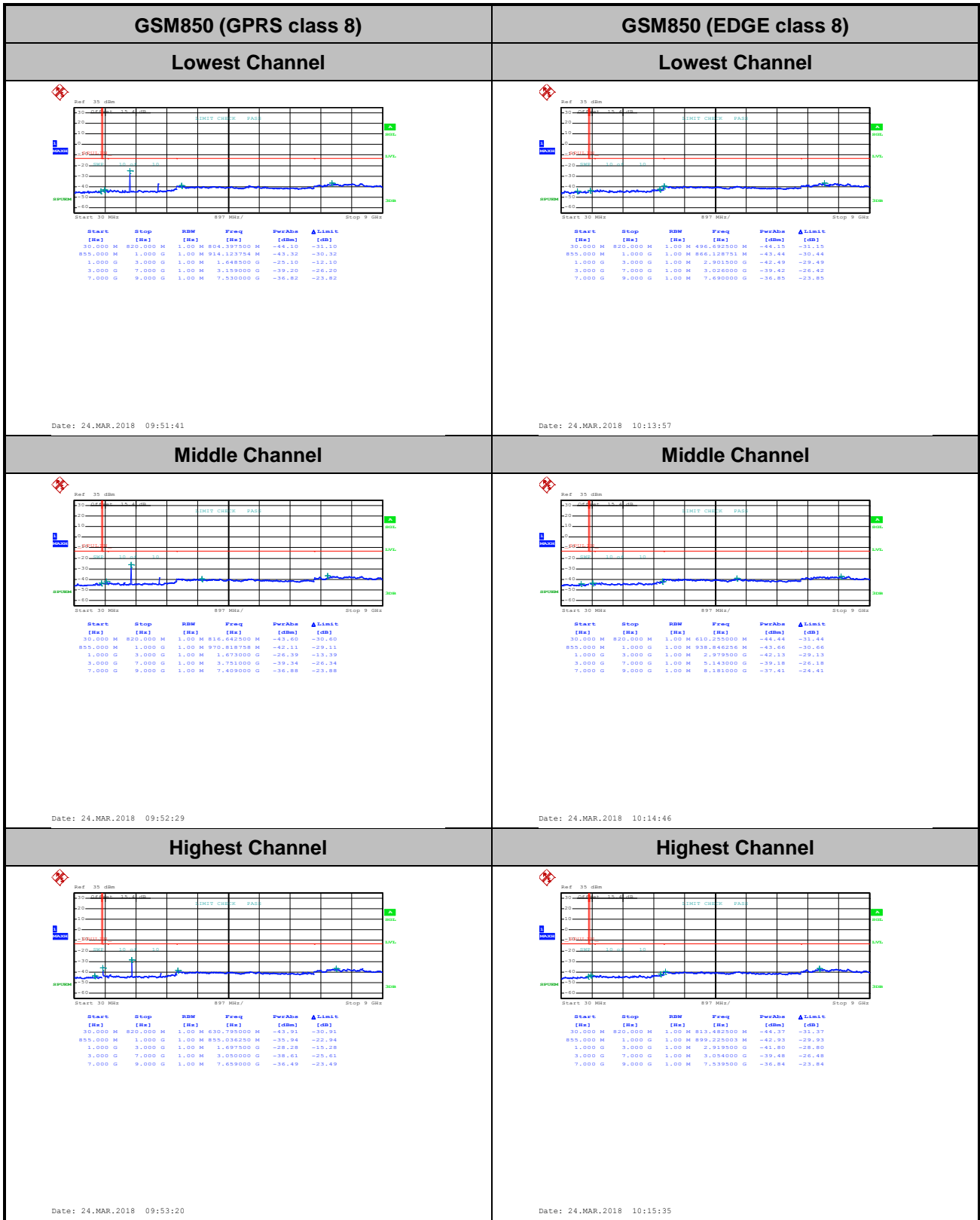

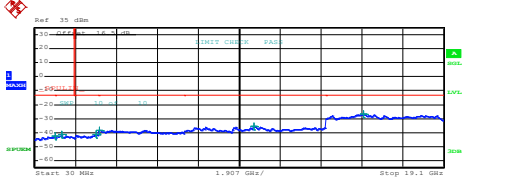
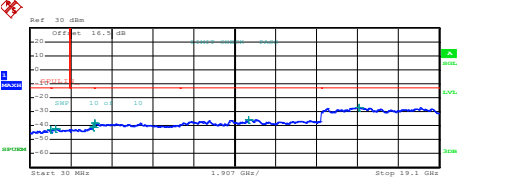
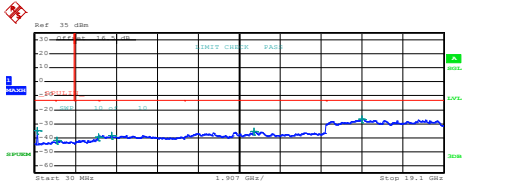
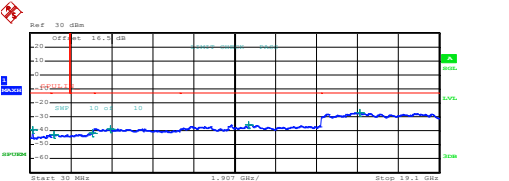
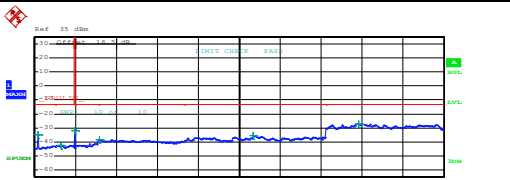
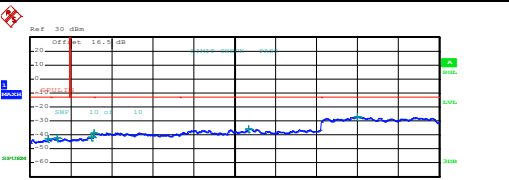

GSM1900 (GPRS class 8)	GSM1900 (EDGE class 8)																																																																																				
Lowest Channel	Lowest Channel																																																																																				
 <table border="1" data-bbox="239 571 750 672"> <thead> <tr> <th>Start [Hz]</th> <th>Stop [Hz]</th> <th>RBW [Hz]</th> <th>Freq [Hz]</th> <th>PwrAbs [dBm]</th> <th>ΔLimit [dB]</th> </tr> </thead> <tbody> <tr><td>30,000 M</td><td>1,000 G</td><td>1,000 M</td><td>978,902500 M</td><td>-42.73</td><td>-29.73</td></tr> <tr><td>1,000 G</td><td>1,845 G</td><td>1,000 M</td><td>1,276949 G</td><td>-41.27</td><td>-28.27</td></tr> <tr><td>1,845 G</td><td>3,000 G</td><td>1,000 M</td><td>2,900961 G</td><td>-42.41</td><td>-28.41</td></tr> <tr><td>3,000 G</td><td>7,000 G</td><td>1,000 M</td><td>3,024000 G</td><td>-38.31</td><td>-25.31</td></tr> <tr><td>7,000 G</td><td>13,600 G</td><td>1,000 M</td><td>10,230825 G</td><td>-35.58</td><td>-22.58</td></tr> <tr><td>13,600 G</td><td>19,100 G</td><td>1,000 M</td><td>15,374438 G</td><td>-26.54</td><td>-13.54</td></tr> </tbody> </table> <p>Date: 30.MAR.2018 14:42:21</p>	Start [Hz]	Stop [Hz]	RBW [Hz]	Freq [Hz]	PwrAbs [dBm]	ΔLimit [dB]	30,000 M	1,000 G	1,000 M	978,902500 M	-42.73	-29.73	1,000 G	1,845 G	1,000 M	1,276949 G	-41.27	-28.27	1,845 G	3,000 G	1,000 M	2,900961 G	-42.41	-28.41	3,000 G	7,000 G	1,000 M	3,024000 G	-38.31	-25.31	7,000 G	13,600 G	1,000 M	10,230825 G	-35.58	-22.58	13,600 G	19,100 G	1,000 M	15,374438 G	-26.54	-13.54	 <table border="1" data-bbox="893 571 1404 672"> <thead> <tr> <th>Start [Hz]</th> <th>Stop [Hz]</th> <th>RBW [Hz]</th> <th>Freq [Hz]</th> <th>PwrAbs [dBm]</th> <th>ΔLimit [dB]</th> </tr> </thead> <tbody> <tr><td>30,000 M</td><td>1,000 G</td><td>1,000 M</td><td>990,342500 M</td><td>-42.67</td><td>-29.67</td></tr> <tr><td>1,000 G</td><td>1,845 G</td><td>1,000 M</td><td>1,206603 G</td><td>-42.16</td><td>-29.16</td></tr> <tr><td>1,845 G</td><td>3,000 G</td><td>1,000 M</td><td>2,980741 G</td><td>-41.06</td><td>-28.06</td></tr> <tr><td>3,000 G</td><td>7,000 G</td><td>1,000 M</td><td>3,049000 G</td><td>-38.25</td><td>-25.25</td></tr> <tr><td>7,000 G</td><td>13,600 G</td><td>1,000 M</td><td>10,230700 G</td><td>-35.58</td><td>-22.58</td></tr> <tr><td>13,600 G</td><td>19,100 G</td><td>1,000 M</td><td>15,307563 G</td><td>-26.76</td><td>-13.76</td></tr> </tbody> </table> <p>Date: 30.MAR.2018 14:17:08</p>	Start [Hz]	Stop [Hz]	RBW [Hz]	Freq [Hz]	PwrAbs [dBm]	ΔLimit [dB]	30,000 M	1,000 G	1,000 M	990,342500 M	-42.67	-29.67	1,000 G	1,845 G	1,000 M	1,206603 G	-42.16	-29.16	1,845 G	3,000 G	1,000 M	2,980741 G	-41.06	-28.06	3,000 G	7,000 G	1,000 M	3,049000 G	-38.25	-25.25	7,000 G	13,600 G	1,000 M	10,230700 G	-35.58	-22.58	13,600 G	19,100 G	1,000 M	15,307563 G	-26.76	-13.76
Start [Hz]	Stop [Hz]	RBW [Hz]	Freq [Hz]	PwrAbs [dBm]	ΔLimit [dB]																																																																																
30,000 M	1,000 G	1,000 M	978,902500 M	-42.73	-29.73																																																																																
1,000 G	1,845 G	1,000 M	1,276949 G	-41.27	-28.27																																																																																
1,845 G	3,000 G	1,000 M	2,900961 G	-42.41	-28.41																																																																																
3,000 G	7,000 G	1,000 M	3,024000 G	-38.31	-25.31																																																																																
7,000 G	13,600 G	1,000 M	10,230825 G	-35.58	-22.58																																																																																
13,600 G	19,100 G	1,000 M	15,374438 G	-26.54	-13.54																																																																																
Start [Hz]	Stop [Hz]	RBW [Hz]	Freq [Hz]	PwrAbs [dBm]	ΔLimit [dB]																																																																																
30,000 M	1,000 G	1,000 M	990,342500 M	-42.67	-29.67																																																																																
1,000 G	1,845 G	1,000 M	1,206603 G	-42.16	-29.16																																																																																
1,845 G	3,000 G	1,000 M	2,980741 G	-41.06	-28.06																																																																																
3,000 G	7,000 G	1,000 M	3,049000 G	-38.25	-25.25																																																																																
7,000 G	13,600 G	1,000 M	10,230700 G	-35.58	-22.58																																																																																
13,600 G	19,100 G	1,000 M	15,307563 G	-26.76	-13.76																																																																																
Middle Channel	Middle Channel																																																																																				
 <table border="1" data-bbox="239 1086 750 1187"> <thead> <tr> <th>Start [Hz]</th> <th>Stop [Hz]</th> <th>RBW [Hz]</th> <th>Freq [Hz]</th> <th>PwrAbs [dBm]</th> <th>ΔLimit [dB]</th> </tr> </thead> <tbody> <tr><td>30,000 M</td><td>1,000 G</td><td>1,000 M</td><td>141,792500 M</td><td>-34.94</td><td>-21.94</td></tr> <tr><td>1,000 G</td><td>3,845 G</td><td>1,000 M</td><td>1,002001 G</td><td>-42.18</td><td>-28.18</td></tr> <tr><td>1,915 G</td><td>3,000 G</td><td>1,000 M</td><td>2,985931 G</td><td>-39.82</td><td>-26.82</td></tr> <tr><td>3,000 G</td><td>7,000 G</td><td>1,000 M</td><td>3,022000 G</td><td>-38.50</td><td>-25.50</td></tr> <tr><td>7,000 G</td><td>13,600 G</td><td>1,000 M</td><td>10,238950 G</td><td>-35.59</td><td>-22.59</td></tr> <tr><td>13,600 G</td><td>19,100 G</td><td>1,000 M</td><td>15,283000 G</td><td>-26.61</td><td>-13.61</td></tr> </tbody> </table> <p>Date: 30.MAR.2018 14:43:13</p>	Start [Hz]	Stop [Hz]	RBW [Hz]	Freq [Hz]	PwrAbs [dBm]	ΔLimit [dB]	30,000 M	1,000 G	1,000 M	141,792500 M	-34.94	-21.94	1,000 G	3,845 G	1,000 M	1,002001 G	-42.18	-28.18	1,915 G	3,000 G	1,000 M	2,985931 G	-39.82	-26.82	3,000 G	7,000 G	1,000 M	3,022000 G	-38.50	-25.50	7,000 G	13,600 G	1,000 M	10,238950 G	-35.59	-22.59	13,600 G	19,100 G	1,000 M	15,283000 G	-26.61	-13.61	 <table border="1" data-bbox="893 1086 1404 1187"> <thead> <tr> <th>Start [Hz]</th> <th>Stop [Hz]</th> <th>RBW [Hz]</th> <th>Freq [Hz]</th> <th>PwrAbs [dBm]</th> <th>ΔLimit [dB]</th> </tr> </thead> <tbody> <tr><td>30,000 M</td><td>1,000 G</td><td>1,000 M</td><td>141,550000 M</td><td>-35.29</td><td>-22.29</td></tr> <tr><td>1,000 G</td><td>3,845 G</td><td>1,000 M</td><td>1,136206 G</td><td>-42.54</td><td>-28.54</td></tr> <tr><td>1,915 G</td><td>3,000 G</td><td>1,000 M</td><td>2,938969 G</td><td>-41.68</td><td>-28.68</td></tr> <tr><td>3,000 G</td><td>7,000 G</td><td>1,000 M</td><td>3,078000 G</td><td>-38.54</td><td>-25.54</td></tr> <tr><td>7,000 G</td><td>13,600 G</td><td>1,000 M</td><td>10,239975 G</td><td>-35.62</td><td>-22.62</td></tr> <tr><td>13,600 G</td><td>19,100 G</td><td>1,000 M</td><td>15,410875 G</td><td>-27.09</td><td>-14.09</td></tr> </tbody> </table> <p>Date: 30.MAR.2018 14:17:58</p>	Start [Hz]	Stop [Hz]	RBW [Hz]	Freq [Hz]	PwrAbs [dBm]	ΔLimit [dB]	30,000 M	1,000 G	1,000 M	141,550000 M	-35.29	-22.29	1,000 G	3,845 G	1,000 M	1,136206 G	-42.54	-28.54	1,915 G	3,000 G	1,000 M	2,938969 G	-41.68	-28.68	3,000 G	7,000 G	1,000 M	3,078000 G	-38.54	-25.54	7,000 G	13,600 G	1,000 M	10,239975 G	-35.62	-22.62	13,600 G	19,100 G	1,000 M	15,410875 G	-27.09	-14.09
Start [Hz]	Stop [Hz]	RBW [Hz]	Freq [Hz]	PwrAbs [dBm]	ΔLimit [dB]																																																																																
30,000 M	1,000 G	1,000 M	141,792500 M	-34.94	-21.94																																																																																
1,000 G	3,845 G	1,000 M	1,002001 G	-42.18	-28.18																																																																																
1,915 G	3,000 G	1,000 M	2,985931 G	-39.82	-26.82																																																																																
3,000 G	7,000 G	1,000 M	3,022000 G	-38.50	-25.50																																																																																
7,000 G	13,600 G	1,000 M	10,238950 G	-35.59	-22.59																																																																																
13,600 G	19,100 G	1,000 M	15,283000 G	-26.61	-13.61																																																																																
Start [Hz]	Stop [Hz]	RBW [Hz]	Freq [Hz]	PwrAbs [dBm]	ΔLimit [dB]																																																																																
30,000 M	1,000 G	1,000 M	141,550000 M	-35.29	-22.29																																																																																
1,000 G	3,845 G	1,000 M	1,136206 G	-42.54	-28.54																																																																																
1,915 G	3,000 G	1,000 M	2,938969 G	-41.68	-28.68																																																																																
3,000 G	7,000 G	1,000 M	3,078000 G	-38.54	-25.54																																																																																
7,000 G	13,600 G	1,000 M	10,239975 G	-35.62	-22.62																																																																																
13,600 G	19,100 G	1,000 M	15,410875 G	-27.09	-14.09																																																																																
Highest Channel	Highest Channel																																																																																				
 <table border="1" data-bbox="239 1601 750 1702"> <thead> <tr> <th>Start [Hz]</th> <th>Stop [Hz]</th> <th>RBW [Hz]</th> <th>Freq [Hz]</th> <th>PwrAbs [dBm]</th> <th>ΔLimit [dB]</th> </tr> </thead> <tbody> <tr><td>30,000 M</td><td>1,000 G</td><td>1,000 M</td><td>171,602500 M</td><td>-34.88</td><td>-21.88</td></tr> <tr><td>1,000 G</td><td>1,845 G</td><td>1,000 M</td><td>1,243783 G</td><td>-42.25</td><td>-29.25</td></tr> <tr><td>1,845 G</td><td>3,000 G</td><td>1,000 M</td><td>1,932071 G</td><td>-32.16</td><td>-19.16</td></tr> <tr><td>3,000 G</td><td>7,000 G</td><td>1,000 M</td><td>3,053000 G</td><td>-38.16</td><td>-25.16</td></tr> <tr><td>7,000 G</td><td>13,600 G</td><td>1,000 M</td><td>10,219150 G</td><td>-35.44</td><td>-22.44</td></tr> <tr><td>13,600 G</td><td>19,100 G</td><td>1,000 M</td><td>15,143500 G</td><td>-27.93</td><td>-14.93</td></tr> </tbody> </table> <p>Date: 30.MAR.2018 14:44:04</p>	Start [Hz]	Stop [Hz]	RBW [Hz]	Freq [Hz]	PwrAbs [dBm]	ΔLimit [dB]	30,000 M	1,000 G	1,000 M	171,602500 M	-34.88	-21.88	1,000 G	1,845 G	1,000 M	1,243783 G	-42.25	-29.25	1,845 G	3,000 G	1,000 M	1,932071 G	-32.16	-19.16	3,000 G	7,000 G	1,000 M	3,053000 G	-38.16	-25.16	7,000 G	13,600 G	1,000 M	10,219150 G	-35.44	-22.44	13,600 G	19,100 G	1,000 M	15,143500 G	-27.93	-14.93	 <table border="1" data-bbox="893 1601 1404 1702"> <thead> <tr> <th>Start [Hz]</th> <th>Stop [Hz]</th> <th>RBW [Hz]</th> <th>Freq [Hz]</th> <th>PwrAbs [dBm]</th> <th>ΔLimit [dB]</th> </tr> </thead> <tbody> <tr><td>30,000 M</td><td>1,000 G</td><td>1,000 M</td><td>876,235000 M</td><td>-42.69</td><td>-29.69</td></tr> <tr><td>1,000 G</td><td>1,845 G</td><td>1,000 M</td><td>1,287723 G</td><td>-41.95</td><td>-28.95</td></tr> <tr><td>1,845 G</td><td>3,000 G</td><td>1,000 M</td><td>2,903204 G</td><td>-41.66</td><td>-28.66</td></tr> <tr><td>3,000 G</td><td>7,000 G</td><td>1,000 M</td><td>3,003000 G</td><td>-38.47</td><td>-25.47</td></tr> <tr><td>7,000 G</td><td>13,600 G</td><td>1,000 M</td><td>10,224100 G</td><td>-35.52</td><td>-22.52</td></tr> <tr><td>13,600 G</td><td>19,100 G</td><td>1,000 M</td><td>15,288500 G</td><td>-26.93</td><td>-13.93</td></tr> </tbody> </table> <p>Date: 30.MAR.2018 14:18:50</p>	Start [Hz]	Stop [Hz]	RBW [Hz]	Freq [Hz]	PwrAbs [dBm]	ΔLimit [dB]	30,000 M	1,000 G	1,000 M	876,235000 M	-42.69	-29.69	1,000 G	1,845 G	1,000 M	1,287723 G	-41.95	-28.95	1,845 G	3,000 G	1,000 M	2,903204 G	-41.66	-28.66	3,000 G	7,000 G	1,000 M	3,003000 G	-38.47	-25.47	7,000 G	13,600 G	1,000 M	10,224100 G	-35.52	-22.52	13,600 G	19,100 G	1,000 M	15,288500 G	-26.93	-13.93
Start [Hz]	Stop [Hz]	RBW [Hz]	Freq [Hz]	PwrAbs [dBm]	ΔLimit [dB]																																																																																
30,000 M	1,000 G	1,000 M	171,602500 M	-34.88	-21.88																																																																																
1,000 G	1,845 G	1,000 M	1,243783 G	-42.25	-29.25																																																																																
1,845 G	3,000 G	1,000 M	1,932071 G	-32.16	-19.16																																																																																
3,000 G	7,000 G	1,000 M	3,053000 G	-38.16	-25.16																																																																																
7,000 G	13,600 G	1,000 M	10,219150 G	-35.44	-22.44																																																																																
13,600 G	19,100 G	1,000 M	15,143500 G	-27.93	-14.93																																																																																
Start [Hz]	Stop [Hz]	RBW [Hz]	Freq [Hz]	PwrAbs [dBm]	ΔLimit [dB]																																																																																
30,000 M	1,000 G	1,000 M	876,235000 M	-42.69	-29.69																																																																																
1,000 G	1,845 G	1,000 M	1,287723 G	-41.95	-28.95																																																																																
1,845 G	3,000 G	1,000 M	2,903204 G	-41.66	-28.66																																																																																
3,000 G	7,000 G	1,000 M	3,003000 G	-38.47	-25.47																																																																																
7,000 G	13,600 G	1,000 M	10,224100 G	-35.52	-22.52																																																																																
13,600 G	19,100 G	1,000 M	15,288500 G	-26.93	-13.93																																																																																



Frequency Stability

Test Conditions	Middle Channel	GSM850 (GPRS class 8)	GSM850 (EDGE class 8)	Limit 2.5ppm
Temperature (°C)	Voltage (Volt)	Deviation (ppm)		Result
50	Normal Voltage	0.0048	0.0120	PASS
40	Normal Voltage	0.0036	0.0036	
30	Normal Voltage	0.0060	0.0108	
20(Ref.)	Normal Voltage	0.0000	0.0000	
10	Normal Voltage	0.0108	0.0060	
0	Normal Voltage	0.0024	0.0024	
-10	Normal Voltage	0.0024	0.0036	
-20	Normal Voltage	0.0024	0.0048	
-30	Normal Voltage	0.0096	0.0012	
20	Maximum Voltage	0.0036	0.0000	
20	Normal Voltage	0.0000	0.0000	
20	Battery End Point	0.0024	0.0036	



Test Conditions	Middle Channel	GSM1900 (GPRS class 8)	GSM1900 (EDGE class 8)	Limit Note 2.
Temperature (°C)	Voltage (Volt)	Deviation (ppm)		Result
50	Normal Voltage	0.0032	0.0090	PASS
40	Normal Voltage	0.0011	0.0048	
30	Normal Voltage	0.0000	0.0011	
20(Ref.)	Normal Voltage	0.0000	0.0000	
10	Normal Voltage	0.0032	0.0032	
0	Normal Voltage	0.0069	0.0032	
-10	Normal Voltage	0.0090	0.0122	
-20	Normal Voltage	0.0005	0.0021	
-30	Normal Voltage	0.0011	0.0011	
20	Maximum Voltage	0.0016	0.0186	
20	Normal Voltage	0.0000	0.0000	
20	Battery End Point	0.0005	0.0005	

Note:

- 1. Normal Voltage = 3.85V. ; Battery End Point (BEP) = 3.4 V. ; Maximum Voltage =4.4 V
- 2. The frequency fundamental emissions stay within the authorized frequency block.



A3. WCDMA

Peak-to-Average Ratio

Mode	WCDMA Band V	WCDMA Band II	WCDMA Band IV	Limit: 13dB
Mod.	RMC 12.2Kbps	RMC 12.2Kbps	RMC 12.2Kbps	Result
Lowest CH	2.80	3.00	2.76	PASS
Middle CH	2.56	3.16	2.68	
Highest CH	2.20	3.20	2.92	

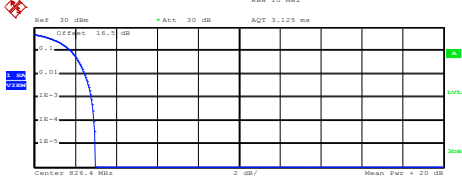
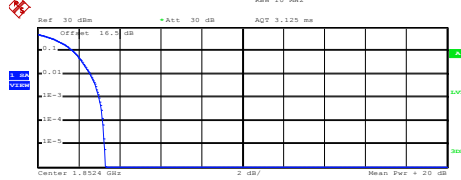
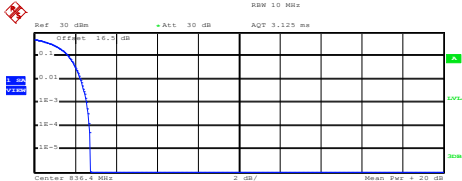
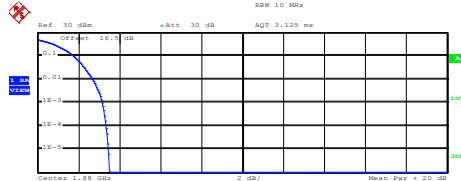
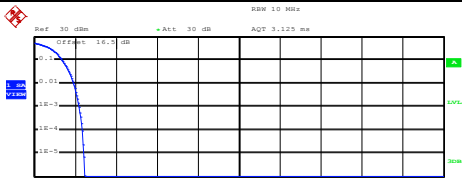
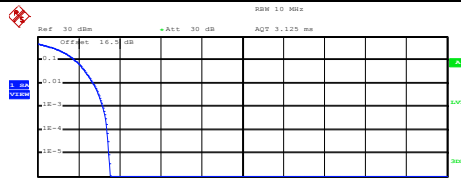

WCDMA Band V (RMC 12.2Kbps)	WCDMA Band II (RMC 12.2Kbps)																
<p style="text-align: center;">Lowest Channel</p>  <p>Center 826.4 MHz 2 dB/ Mean Pwr + 20 dB</p> <p>Complementary Cumulative Distribution Function (100000 samples) Trace 1 Mean 24.98 dBm Peak 27.97 dBm Crest 2.99 dB</p> <table border="1"> <tr><td>10 %</td><td>1.80 dB</td></tr> <tr><td>1 %</td><td>2.48 dB</td></tr> <tr><td>.1 %</td><td>2.80 dB</td></tr> <tr><td>.01 %</td><td>2.92 dB</td></tr> </table> <p>Date: 24.MAR.2018 11:16:40</p>	10 %	1.80 dB	1 %	2.48 dB	.1 %	2.80 dB	.01 %	2.92 dB	<p style="text-align: center;">Lowest Channel</p>  <p>Center 1.8524 GHz 2 dB/ Mean Pwr + 20 dB</p> <p>Complementary Cumulative Distribution Function (100000 samples) Trace 1 Mean 21.80 dBm Peak 25.10 dBm Crest 3.30 dB</p> <table border="1"> <tr><td>10 %</td><td>1.72 dB</td></tr> <tr><td>1 %</td><td>2.56 dB</td></tr> <tr><td>.1 %</td><td>3.00 dB</td></tr> <tr><td>.01 %</td><td>3.20 dB</td></tr> </table> <p>Date: 30.MAR.2018 14:06:11</p>	10 %	1.72 dB	1 %	2.56 dB	.1 %	3.00 dB	.01 %	3.20 dB
10 %	1.80 dB																
1 %	2.48 dB																
.1 %	2.80 dB																
.01 %	2.92 dB																
10 %	1.72 dB																
1 %	2.56 dB																
.1 %	3.00 dB																
.01 %	3.20 dB																
<p style="text-align: center;">Middle Channel</p>  <p>Center 836.4 MHz 2 dB/ Mean Pwr + 20 dB</p> <p>Complementary Cumulative Distribution Function (100000 samples) Trace 1 Mean 25.09 dBm Peak 27.83 dBm Crest 2.74 dB</p> <table border="1"> <tr><td>10 %</td><td>1.68 dB</td></tr> <tr><td>1 %</td><td>2.28 dB</td></tr> <tr><td>.1 %</td><td>2.56 dB</td></tr> <tr><td>.01 %</td><td>2.68 dB</td></tr> </table> <p>Date: 24.MAR.2018 11:16:54</p>	10 %	1.68 dB	1 %	2.28 dB	.1 %	2.56 dB	.01 %	2.68 dB	<p style="text-align: center;">Middle Channel</p>  <p>Center 1.88 GHz 2 dB/ Mean Pwr + 20 dB</p> <p>Complementary Cumulative Distribution Function (100000 samples) Trace 1 Mean 21.82 dBm Peak 25.31 dBm Crest 3.49 dB</p> <table border="1"> <tr><td>10 %</td><td>1.76 dB</td></tr> <tr><td>1 %</td><td>2.68 dB</td></tr> <tr><td>.1 %</td><td>3.16 dB</td></tr> <tr><td>.01 %</td><td>3.36 dB</td></tr> </table> <p>Date: 30.MAR.2018 14:06:23</p>	10 %	1.76 dB	1 %	2.68 dB	.1 %	3.16 dB	.01 %	3.36 dB
10 %	1.68 dB																
1 %	2.28 dB																
.1 %	2.56 dB																
.01 %	2.68 dB																
10 %	1.76 dB																
1 %	2.68 dB																
.1 %	3.16 dB																
.01 %	3.36 dB																
<p style="text-align: center;">Highest Channel</p>  <p>Center 846.6 MHz 2 dB/ Mean Pwr + 20 dB</p> <p>Complementary Cumulative Distribution Function (100000 samples) Trace 1 Mean 25.02 dBm Peak 27.48 dBm Crest 2.45 dB</p> <table border="1"> <tr><td>10 %</td><td>1.36 dB</td></tr> <tr><td>1 %</td><td>1.92 dB</td></tr> <tr><td>.1 %</td><td>2.20 dB</td></tr> <tr><td>.01 %</td><td>2.36 dB</td></tr> </table> <p>Date: 24.MAR.2018 11:17:12</p>	10 %	1.36 dB	1 %	1.92 dB	.1 %	2.20 dB	.01 %	2.36 dB	<p style="text-align: center;">Highest Channel</p>  <p>Center 1.9076 GHz 2 dB/ Mean Pwr + 20 dB</p> <p>Complementary Cumulative Distribution Function (100000 samples) Trace 1 Mean 21.77 dBm Peak 25.31 dBm Crest 3.54 dB</p> <table border="1"> <tr><td>10 %</td><td>1.84 dB</td></tr> <tr><td>1 %</td><td>2.72 dB</td></tr> <tr><td>.1 %</td><td>3.20 dB</td></tr> <tr><td>.01 %</td><td>3.40 dB</td></tr> </table> <p>Date: 30.MAR.2018 14:06:36</p>	10 %	1.84 dB	1 %	2.72 dB	.1 %	3.20 dB	.01 %	3.40 dB
10 %	1.36 dB																
1 %	1.92 dB																
.1 %	2.20 dB																
.01 %	2.36 dB																
10 %	1.84 dB																
1 %	2.72 dB																
.1 %	3.20 dB																
.01 %	3.40 dB																



WCDMA Band IV (RMC 12.2Kbps)

Lowest Channel

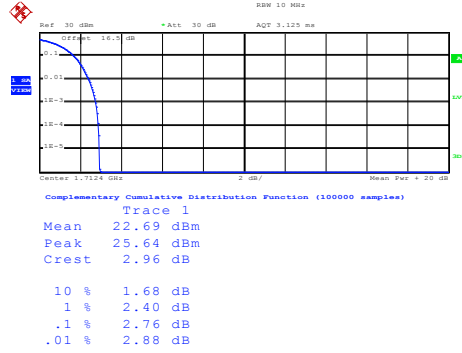

Date: 24.MAR.2018 10:43:30

Middle Channel

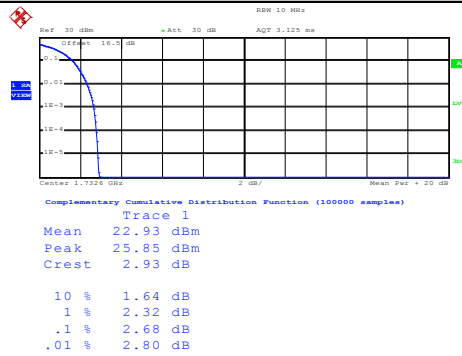

Date: 24.MAR.2018 10:43:42

Highest Channel

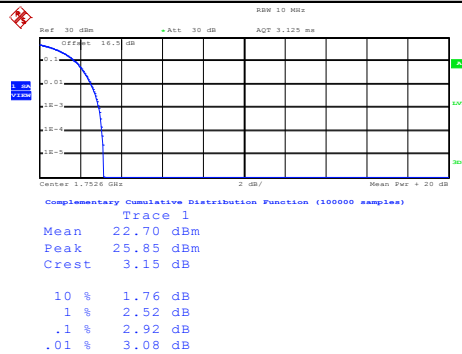

Date: 24.MAR.2018 10:43:53



26dB Bandwidth

Mode	WCDMA Band V	WCDMA Band II	WCDMA Band IV
Mod.	RMC 12.2Kbps	RMC 12.2Kbps	RMC 12.2Kbps
Lowest CH	4.72	4.70	4.72
Middle CH	4.73	4.70	4.73
Highest CH	4.79	4.69	4.70



WCDMA Band V (RMC 12.2Kbps)

WCDMA Band II (RMC 12.2Kbps)

Lowest Channel

Lowest Channel

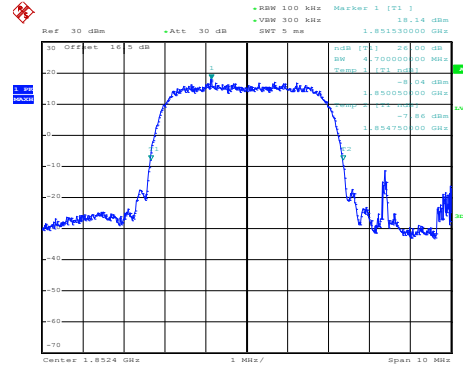
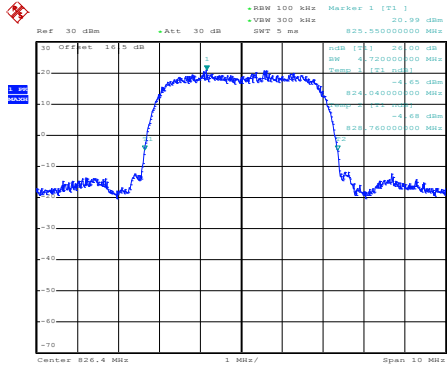

Date: 24.MAR.2018 10:59:05

Date: 30.MAR.2018 14:02:59

Middle Channel

Middle Channel

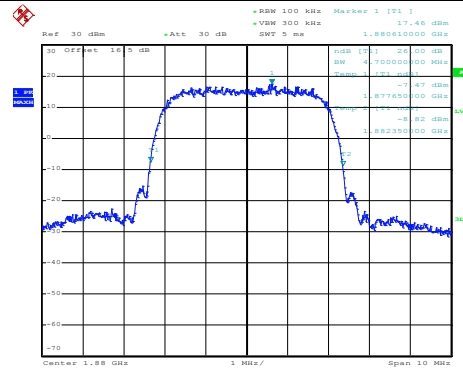
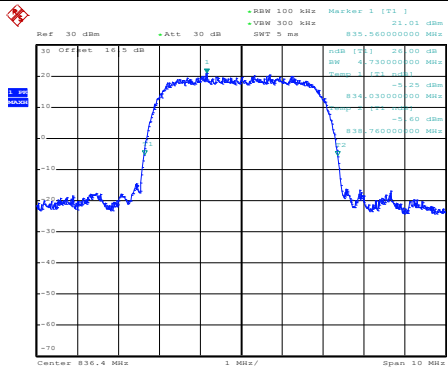

Date: 24.MAR.2018 10:59:38

Date: 30.MAR.2018 14:03:30

Highest Channel

Highest Channel

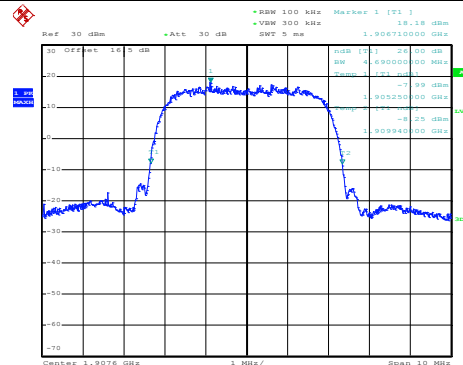
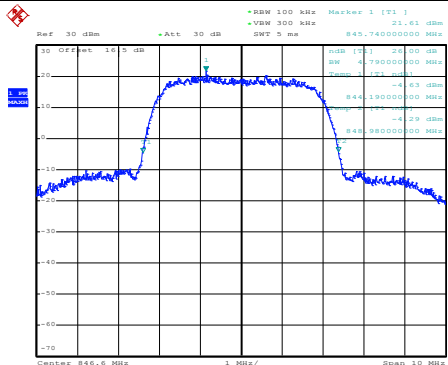

Date: 24.MAR.2018 11:00:11

Date: 30.MAR.2018 14:04:12



WCDMA Band IV (RMC 12.2Kbps)

Lowest Channel

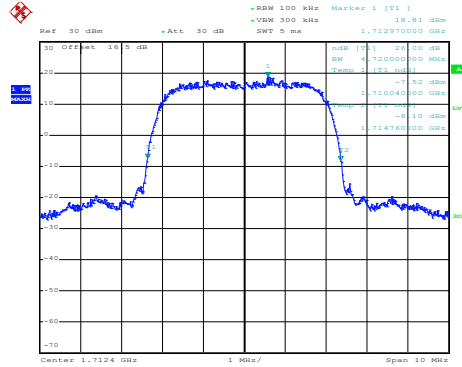

Date: 24.MAR.2018 10:37:40

Middle Channel

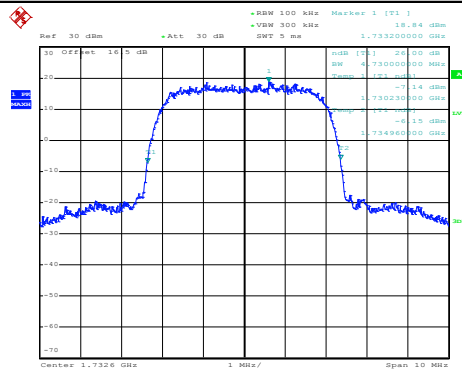

Date: 24.MAR.2018 10:38:11

Highest Channel

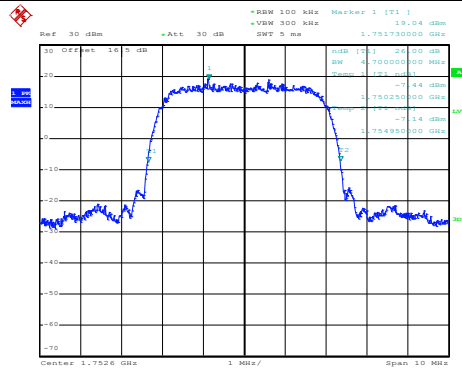

Date: 24.MAR.2018 10:38:43



Occupied Bandwidth

Mode	WCDMA Band V	WCDMA Band II	WCDMA Band IV
Mod.	RMC 12.2Kbps	RMC 12.2Kbps	RMC 12.2Kbps
Lowest CH	4.14	4.14	4.14
Middle CH	4.14	4.14	4.14
Highest CH	4.18	4.14	4.14



WCDMA Band V (RMC 12.2Kbps)	WCDMA Band II (RMC 12.2Kbps)
<p style="text-align: center;">Lowest Channel</p> <p>Date: 24.MAR.2018 11:00:46</p>	<p style="text-align: center;">Lowest Channel</p> <p>Date: 30.MAR.2018 14:04:50</p>
<p style="text-align: center;">Middle Channel</p> <p>Date: 24.MAR.2018 11:01:19</p>	<p style="text-align: center;">Middle Channel</p> <p>Date: 30.MAR.2018 14:05:21</p>
<p style="text-align: center;">Highest Channel</p> <p>Date: 24.MAR.2018 11:01:53</p>	<p style="text-align: center;">Highest Channel</p> <p>Date: 30.MAR.2018 14:05:54</p>



WCDMA Band IV (RMC 12.2Kbps)

Lowest Channel

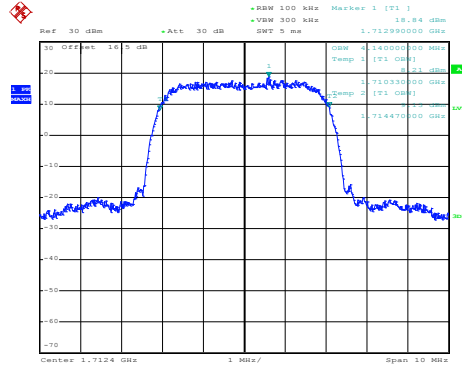

Date: 24.MAR.2018 10:42:07

Middle Channel

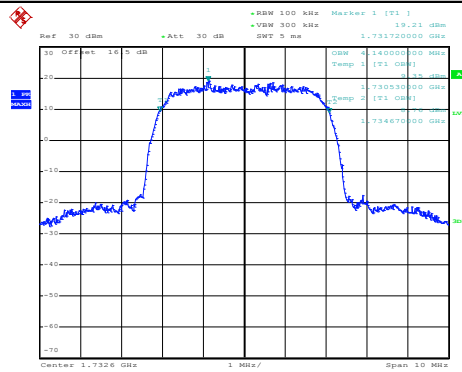

Date: 24.MAR.2018 10:42:42

Highest Channel

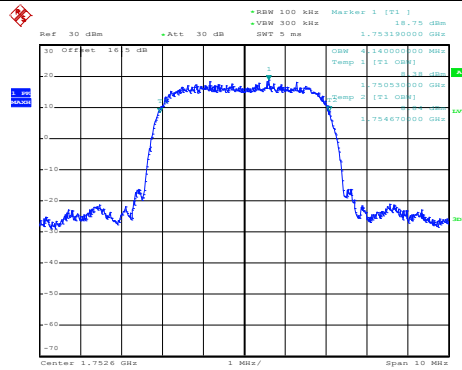

Date: 24.MAR.2018 10:43:12



Conducted Band Edge

WCDMA Band V (RMC 12.2Kbps)

Lowest Band Edge

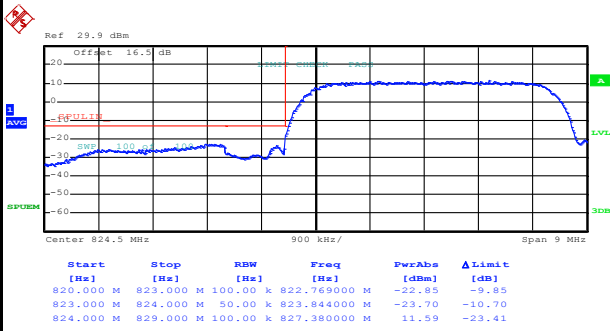

Date: 24.MAR.2018 11:04:41

Highest Band Edge

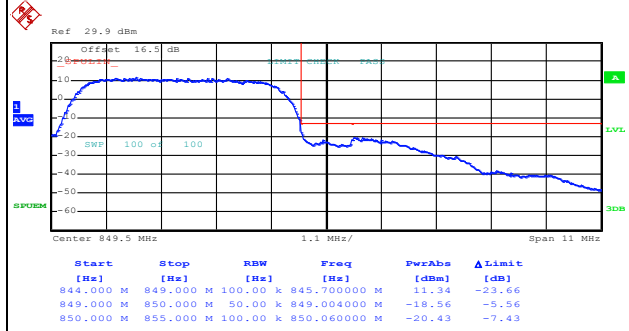

Date: 24.MAR.2018 11:13:02



WCDMA Band II (RMC 12.2Kbps)

Lowest Band Edge

Highest Band Edge

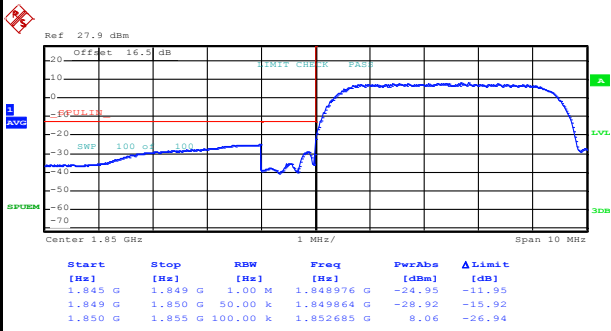

Date: 30.MAR.2018 14:09:23

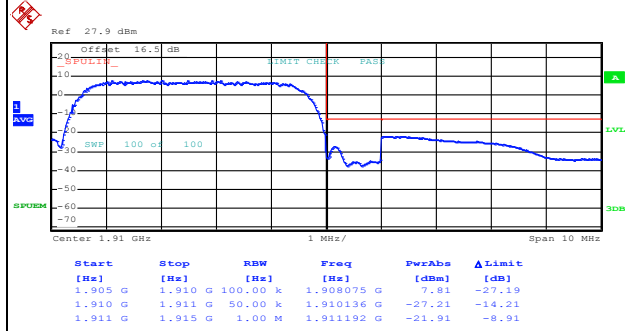

Date: 30.MAR.2018 14:13:26



WCDMA Band IV (RMC 12.2Kbps)

Lowest Band Edge

Highest Band Edge

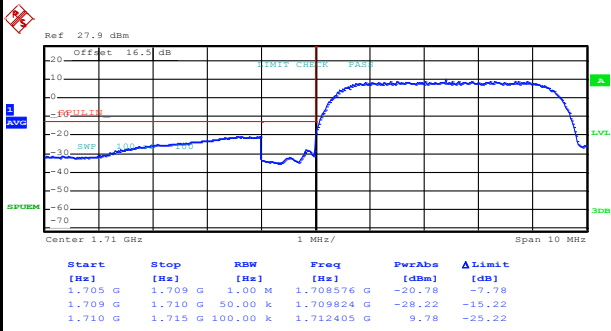

Date: 24.MAR.2018 10:46:39

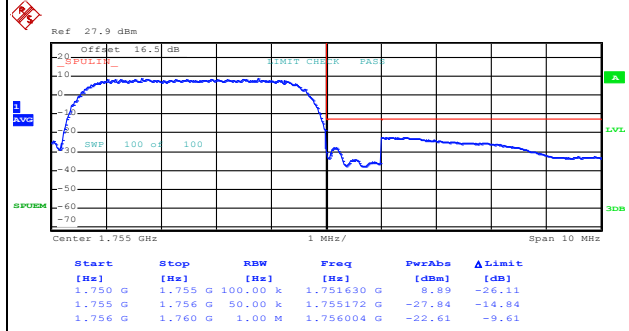

Date: 24.MAR.2018 10:49:27

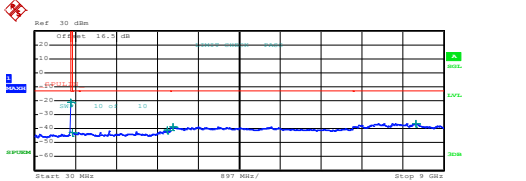
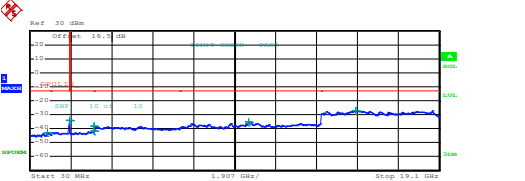
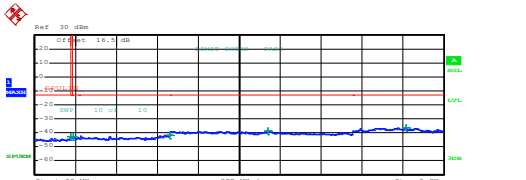
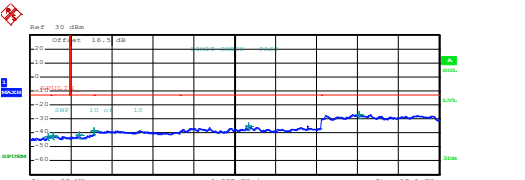
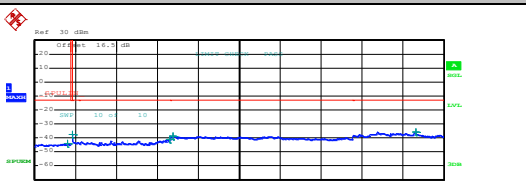
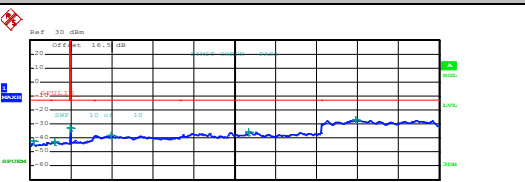

Conducted Spurious Emission

WCDMA Band V (RMC 12.2Kbps)	WCDMA Band II (RMC 12.2Kbps)																																																																														
Lowest Channel	Lowest Channel																																																																														
 <table border="1" data-bbox="239 660 750 739"> <thead> <tr> <th>Start [Hz]</th> <th>Stop [Hz]</th> <th>RBW [Hz]</th> <th>Freq [Hz]</th> <th>PwrAve [dBm]</th> <th>ΔLimit [dB]</th> </tr> </thead> <tbody> <tr> <td>30.000 M</td> <td>820.000 M</td> <td>1.00 M</td> <td>819.210000 M</td> <td>-21.38</td> <td>-8.38</td> </tr> <tr> <td>855.000 M</td> <td>1.000 G</td> <td>1.00 M</td> <td>863.808751 M</td> <td>-42.57</td> <td>-29.57</td> </tr> <tr> <td>1.000 G</td> <td>3.000 G</td> <td>1.00 M</td> <td>2.934000 G</td> <td>-42.24</td> <td>-28.24</td> </tr> <tr> <td>3.000 G</td> <td>7.000 G</td> <td>1.00 M</td> <td>3.055000 G</td> <td>-38.56</td> <td>-25.56</td> </tr> <tr> <td>7.000 G</td> <td>9.000 G</td> <td>1.00 M</td> <td>8.381500 G</td> <td>-36.09</td> <td>-23.09</td> </tr> </tbody> </table> <p>Date: 24.MAR.2018 11:14:23</p>	Start [Hz]	Stop [Hz]	RBW [Hz]	Freq [Hz]	PwrAve [dBm]	ΔLimit [dB]	30.000 M	820.000 M	1.00 M	819.210000 M	-21.38	-8.38	855.000 M	1.000 G	1.00 M	863.808751 M	-42.57	-29.57	1.000 G	3.000 G	1.00 M	2.934000 G	-42.24	-28.24	3.000 G	7.000 G	1.00 M	3.055000 G	-38.56	-25.56	7.000 G	9.000 G	1.00 M	8.381500 G	-36.09	-23.09	 <table border="1" data-bbox="893 660 1404 739"> <thead> <tr> <th>Start [Hz]</th> <th>Stop [Hz]</th> <th>RBW [Hz]</th> <th>Freq [Hz]</th> <th>PwrAve [dBm]</th> <th>ΔLimit [dB]</th> </tr> </thead> <tbody> <tr> <td>30.000 M</td> <td>1.000 G</td> <td>1.00 M</td> <td>826.855000 M</td> <td>-42.99</td> <td>-29.99</td> </tr> <tr> <td>1.000 G</td> <td>3.000 G</td> <td>1.00 M</td> <td>3.044578 G</td> <td>-33.82</td> <td>-20.82</td> </tr> <tr> <td>3.000 G</td> <td>7.000 G</td> <td>1.00 M</td> <td>2.990778 G</td> <td>-41.56</td> <td>-28.56</td> </tr> <tr> <td>7.000 G</td> <td>13.600 G</td> <td>1.00 M</td> <td>3.008000 G</td> <td>-38.40</td> <td>-25.40</td> </tr> <tr> <td>13.600 G</td> <td>19.100 G</td> <td>1.00 M</td> <td>10.207600 G</td> <td>-35.32</td> <td>-22.32</td> </tr> <tr> <td>19.100 G</td> <td>19.100 G</td> <td>1.00 M</td> <td>15.237000 G</td> <td>-26.74</td> <td>-13.74</td> </tr> </tbody> </table> <p>Date: 30.MAR.2018 14:00:33</p>	Start [Hz]	Stop [Hz]	RBW [Hz]	Freq [Hz]	PwrAve [dBm]	ΔLimit [dB]	30.000 M	1.000 G	1.00 M	826.855000 M	-42.99	-29.99	1.000 G	3.000 G	1.00 M	3.044578 G	-33.82	-20.82	3.000 G	7.000 G	1.00 M	2.990778 G	-41.56	-28.56	7.000 G	13.600 G	1.00 M	3.008000 G	-38.40	-25.40	13.600 G	19.100 G	1.00 M	10.207600 G	-35.32	-22.32	19.100 G	19.100 G	1.00 M	15.237000 G	-26.74	-13.74
Start [Hz]	Stop [Hz]	RBW [Hz]	Freq [Hz]	PwrAve [dBm]	ΔLimit [dB]																																																																										
30.000 M	820.000 M	1.00 M	819.210000 M	-21.38	-8.38																																																																										
855.000 M	1.000 G	1.00 M	863.808751 M	-42.57	-29.57																																																																										
1.000 G	3.000 G	1.00 M	2.934000 G	-42.24	-28.24																																																																										
3.000 G	7.000 G	1.00 M	3.055000 G	-38.56	-25.56																																																																										
7.000 G	9.000 G	1.00 M	8.381500 G	-36.09	-23.09																																																																										
Start [Hz]	Stop [Hz]	RBW [Hz]	Freq [Hz]	PwrAve [dBm]	ΔLimit [dB]																																																																										
30.000 M	1.000 G	1.00 M	826.855000 M	-42.99	-29.99																																																																										
1.000 G	3.000 G	1.00 M	3.044578 G	-33.82	-20.82																																																																										
3.000 G	7.000 G	1.00 M	2.990778 G	-41.56	-28.56																																																																										
7.000 G	13.600 G	1.00 M	3.008000 G	-38.40	-25.40																																																																										
13.600 G	19.100 G	1.00 M	10.207600 G	-35.32	-22.32																																																																										
19.100 G	19.100 G	1.00 M	15.237000 G	-26.74	-13.74																																																																										
Middle Channel	Middle Channel																																																																														
 <table border="1" data-bbox="239 1176 750 1254"> <thead> <tr> <th>Start [Hz]</th> <th>Stop [Hz]</th> <th>RBW [Hz]</th> <th>Freq [Hz]</th> <th>PwrAve [dBm]</th> <th>ΔLimit [dB]</th> </tr> </thead> <tbody> <tr> <td>30.000 M</td> <td>820.000 M</td> <td>1.00 M</td> <td>819.407500 M</td> <td>-42.95</td> <td>-29.95</td> </tr> <tr> <td>855.000 M</td> <td>1.000 G</td> <td>1.00 M</td> <td>867.223751 M</td> <td>-43.06</td> <td>-30.06</td> </tr> <tr> <td>1.000 G</td> <td>3.000 G</td> <td>1.00 M</td> <td>2.983000 G</td> <td>-41.52</td> <td>-28.52</td> </tr> <tr> <td>3.000 G</td> <td>7.000 G</td> <td>1.00 M</td> <td>3.145000 G</td> <td>-38.54</td> <td>-25.54</td> </tr> <tr> <td>7.000 G</td> <td>9.000 G</td> <td>1.00 M</td> <td>8.175500 G</td> <td>-36.62</td> <td>-23.62</td> </tr> </tbody> </table> <p>Date: 24.MAR.2018 11:15:23</p>	Start [Hz]	Stop [Hz]	RBW [Hz]	Freq [Hz]	PwrAve [dBm]	ΔLimit [dB]	30.000 M	820.000 M	1.00 M	819.407500 M	-42.95	-29.95	855.000 M	1.000 G	1.00 M	867.223751 M	-43.06	-30.06	1.000 G	3.000 G	1.00 M	2.983000 G	-41.52	-28.52	3.000 G	7.000 G	1.00 M	3.145000 G	-38.54	-25.54	7.000 G	9.000 G	1.00 M	8.175500 G	-36.62	-23.62	 <table border="1" data-bbox="893 1176 1404 1254"> <thead> <tr> <th>Start [Hz]</th> <th>Stop [Hz]</th> <th>RBW [Hz]</th> <th>Freq [Hz]</th> <th>PwrAve [dBm]</th> <th>ΔLimit [dB]</th> </tr> </thead> <tbody> <tr> <td>30.000 M</td> <td>1.000 G</td> <td>1.00 M</td> <td>860.562500 M</td> <td>-42.55</td> <td>-29.55</td> </tr> <tr> <td>1.000 G</td> <td>3.000 G</td> <td>1.00 M</td> <td>3.109250 G</td> <td>-41.98</td> <td>-28.98</td> </tr> <tr> <td>3.000 G</td> <td>7.000 G</td> <td>1.00 M</td> <td>2.315385 G</td> <td>-41.40</td> <td>-28.40</td> </tr> <tr> <td>7.000 G</td> <td>13.600 G</td> <td>1.00 M</td> <td>3.023000 G</td> <td>-38.48</td> <td>-25.48</td> </tr> <tr> <td>13.600 G</td> <td>19.100 G</td> <td>1.00 M</td> <td>10.227400 G</td> <td>-35.45</td> <td>-22.45</td> </tr> <tr> <td>19.100 G</td> <td>19.100 G</td> <td>1.00 M</td> <td>15.362750 G</td> <td>-26.99</td> <td>-13.99</td> </tr> </tbody> </table> <p>Date: 30.MAR.2018 14:01:25</p>	Start [Hz]	Stop [Hz]	RBW [Hz]	Freq [Hz]	PwrAve [dBm]	ΔLimit [dB]	30.000 M	1.000 G	1.00 M	860.562500 M	-42.55	-29.55	1.000 G	3.000 G	1.00 M	3.109250 G	-41.98	-28.98	3.000 G	7.000 G	1.00 M	2.315385 G	-41.40	-28.40	7.000 G	13.600 G	1.00 M	3.023000 G	-38.48	-25.48	13.600 G	19.100 G	1.00 M	10.227400 G	-35.45	-22.45	19.100 G	19.100 G	1.00 M	15.362750 G	-26.99	-13.99
Start [Hz]	Stop [Hz]	RBW [Hz]	Freq [Hz]	PwrAve [dBm]	ΔLimit [dB]																																																																										
30.000 M	820.000 M	1.00 M	819.407500 M	-42.95	-29.95																																																																										
855.000 M	1.000 G	1.00 M	867.223751 M	-43.06	-30.06																																																																										
1.000 G	3.000 G	1.00 M	2.983000 G	-41.52	-28.52																																																																										
3.000 G	7.000 G	1.00 M	3.145000 G	-38.54	-25.54																																																																										
7.000 G	9.000 G	1.00 M	8.175500 G	-36.62	-23.62																																																																										
Start [Hz]	Stop [Hz]	RBW [Hz]	Freq [Hz]	PwrAve [dBm]	ΔLimit [dB]																																																																										
30.000 M	1.000 G	1.00 M	860.562500 M	-42.55	-29.55																																																																										
1.000 G	3.000 G	1.00 M	3.109250 G	-41.98	-28.98																																																																										
3.000 G	7.000 G	1.00 M	2.315385 G	-41.40	-28.40																																																																										
7.000 G	13.600 G	1.00 M	3.023000 G	-38.48	-25.48																																																																										
13.600 G	19.100 G	1.00 M	10.227400 G	-35.45	-22.45																																																																										
19.100 G	19.100 G	1.00 M	15.362750 G	-26.99	-13.99																																																																										
Highest Channel	Highest Channel																																																																														
 <table border="1" data-bbox="239 1691 750 1769"> <thead> <tr> <th>Start [Hz]</th> <th>Stop [Hz]</th> <th>RBW [Hz]</th> <th>Freq [Hz]</th> <th>PwrAve [dBm]</th> <th>ΔLimit [dB]</th> </tr> </thead> <tbody> <tr> <td>30.000 M</td> <td>820.000 M</td> <td>1.00 M</td> <td>741.150500 M</td> <td>-44.22</td> <td>-31.22</td> </tr> <tr> <td>855.000 M</td> <td>1.000 G</td> <td>1.00 M</td> <td>855.108750 M</td> <td>-37.82</td> <td>-24.82</td> </tr> <tr> <td>1.000 G</td> <td>3.000 G</td> <td>1.00 M</td> <td>2.984500 G</td> <td>-42.28</td> <td>-28.28</td> </tr> <tr> <td>3.000 G</td> <td>7.000 G</td> <td>1.00 M</td> <td>3.066000 G</td> <td>-38.68</td> <td>-25.68</td> </tr> <tr> <td>7.000 G</td> <td>9.000 G</td> <td>1.00 M</td> <td>8.381500 G</td> <td>-36.04</td> <td>-23.04</td> </tr> </tbody> </table> <p>Date: 24.MAR.2018 11:16:20</p>	Start [Hz]	Stop [Hz]	RBW [Hz]	Freq [Hz]	PwrAve [dBm]	ΔLimit [dB]	30.000 M	820.000 M	1.00 M	741.150500 M	-44.22	-31.22	855.000 M	1.000 G	1.00 M	855.108750 M	-37.82	-24.82	1.000 G	3.000 G	1.00 M	2.984500 G	-42.28	-28.28	3.000 G	7.000 G	1.00 M	3.066000 G	-38.68	-25.68	7.000 G	9.000 G	1.00 M	8.381500 G	-36.04	-23.04	 <table border="1" data-bbox="893 1691 1404 1769"> <thead> <tr> <th>Start [Hz]</th> <th>Stop [Hz]</th> <th>RBW [Hz]</th> <th>Freq [Hz]</th> <th>PwrAve [dBm]</th> <th>ΔLimit [dB]</th> </tr> </thead> <tbody> <tr> <td>30.000 M</td> <td>1.000 G</td> <td>1.00 M</td> <td>170.607500 M</td> <td>-49.31</td> <td>-36.31</td> </tr> <tr> <td>1.000 G</td> <td>3.000 G</td> <td>1.00 M</td> <td>1.172893 G</td> <td>-42.72</td> <td>-29.72</td> </tr> <tr> <td>3.000 G</td> <td>7.000 G</td> <td>1.00 M</td> <td>2.934000 G</td> <td>-39.04</td> <td>-26.04</td> </tr> <tr> <td>7.000 G</td> <td>13.600 G</td> <td>1.00 M</td> <td>3.811000 G</td> <td>-38.28</td> <td>-25.28</td> </tr> <tr> <td>13.600 G</td> <td>19.100 G</td> <td>1.00 M</td> <td>10.212550 G</td> <td>-35.87</td> <td>-22.87</td> </tr> <tr> <td>19.100 G</td> <td>19.100 G</td> <td>1.00 M</td> <td>15.230325 G</td> <td>-27.13</td> <td>-14.13</td> </tr> </tbody> </table> <p>Date: 30.MAR.2018 14:02:16</p>	Start [Hz]	Stop [Hz]	RBW [Hz]	Freq [Hz]	PwrAve [dBm]	ΔLimit [dB]	30.000 M	1.000 G	1.00 M	170.607500 M	-49.31	-36.31	1.000 G	3.000 G	1.00 M	1.172893 G	-42.72	-29.72	3.000 G	7.000 G	1.00 M	2.934000 G	-39.04	-26.04	7.000 G	13.600 G	1.00 M	3.811000 G	-38.28	-25.28	13.600 G	19.100 G	1.00 M	10.212550 G	-35.87	-22.87	19.100 G	19.100 G	1.00 M	15.230325 G	-27.13	-14.13
Start [Hz]	Stop [Hz]	RBW [Hz]	Freq [Hz]	PwrAve [dBm]	ΔLimit [dB]																																																																										
30.000 M	820.000 M	1.00 M	741.150500 M	-44.22	-31.22																																																																										
855.000 M	1.000 G	1.00 M	855.108750 M	-37.82	-24.82																																																																										
1.000 G	3.000 G	1.00 M	2.984500 G	-42.28	-28.28																																																																										
3.000 G	7.000 G	1.00 M	3.066000 G	-38.68	-25.68																																																																										
7.000 G	9.000 G	1.00 M	8.381500 G	-36.04	-23.04																																																																										
Start [Hz]	Stop [Hz]	RBW [Hz]	Freq [Hz]	PwrAve [dBm]	ΔLimit [dB]																																																																										
30.000 M	1.000 G	1.00 M	170.607500 M	-49.31	-36.31																																																																										
1.000 G	3.000 G	1.00 M	1.172893 G	-42.72	-29.72																																																																										
3.000 G	7.000 G	1.00 M	2.934000 G	-39.04	-26.04																																																																										
7.000 G	13.600 G	1.00 M	3.811000 G	-38.28	-25.28																																																																										
13.600 G	19.100 G	1.00 M	10.212550 G	-35.87	-22.87																																																																										
19.100 G	19.100 G	1.00 M	15.230325 G	-27.13	-14.13																																																																										



WCDMA Band IV (RMC 12.2Kbps)

Lowest Channel

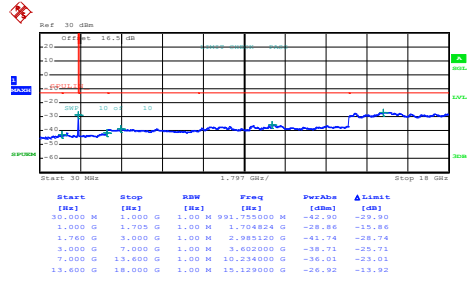

Date: 24.MAR.2018 10:39:41

Middle Channel

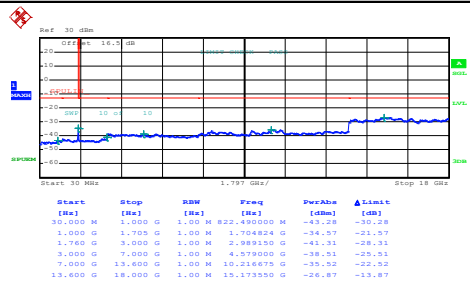

Date: 24.MAR.2018 10:40:30

Highest Channel

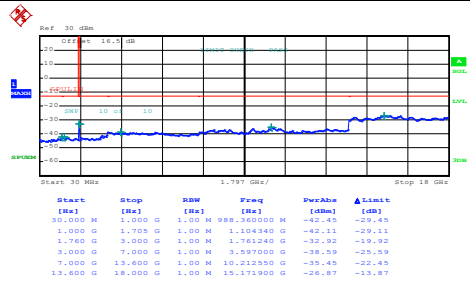

Date: 24.MAR.2018 10:41:20



Frequency Stability

Test Conditions	Middle Channel	WCDMA Band V (RMC 12.2Kbps)	Limit 2.5ppm
Temperature (°C)	Voltage (Volt)	Deviation (ppm)	Result
50	Normal Voltage	0.0000	PASS
40	Normal Voltage	0.0023	
30	Normal Voltage	0.0185	
20(Ref.)	Normal Voltage	0.0000	
10	Normal Voltage	0.0294	
0	Normal Voltage	0.0364	
-10	Normal Voltage	0.0352	
-20	Normal Voltage	0.0346	
-30	Normal Voltage	0.0358	
20	Maximum Voltage	0.0000	
20	Normal Voltage	0.0000	
20	Battery End Point	0.0006	



Test Conditions	Middle Channel	WCDMA Band II (RMC 12.2Kbps)	Limit Note 2.
Temperature (°C)	Voltage (Volt)	Deviation (ppm)	Result
50	Normal Voltage	0.0027	PASS
40	Normal Voltage	0.0021	
30	Normal Voltage	0.0000	
20(Ref.)	Normal Voltage	0.0000	
10	Normal Voltage	0.0037	
0	Normal Voltage	0.0048	
-10	Normal Voltage	0.0048	
-20	Normal Voltage	0.0048	
-30	Normal Voltage	0.0053	
20	Maximum Voltage	0.0011	
20	Normal Voltage	0.0000	
20	Battery End Point	0.0005	

Test Conditions	Middle Channel	WCDMA Band IV (RMC 12.2Kbps)	Limit Note 2.
Temperature (°C)	Voltage (Volt)	Deviation (ppm)	Result
50	Normal Voltage	0.0000	PASS
40	Normal Voltage	0.0012	
30	Normal Voltage	0.0179	
20(Ref.)	Normal Voltage	0.0000	
10	Normal Voltage	0.0215	
0	Normal Voltage	0.0215	
-10	Normal Voltage	0.0215	
-20	Normal Voltage	0.0191	
-30	Normal Voltage	0.0191	
20	Maximum Voltage	0.0012	
20	Normal Voltage	0.0000	
20	Battery End Point	0.0000	

Note:

1. Normal Voltage = 3.85V. ; Battery End Point (BEP) = 3.4 V. ; Maximum Voltage =4.4 V
2. The frequency fundamental emissions stay within the authorized frequency block.



Appendix B. Test Results of ERP/EIRP and Radiated Test

ERP/EIRP

Channel	Mode	Conducted		ERP	
		Power (dBm)	Power (Watts)	ERP(dBm)	ERP(W)
Lowest	GSM850	33.31	2.1429	29.66	0.9247
Middle	GPRS class 8	33.49	2.2336	29.84	0.9638
Highest	(GT - LC = -1.5 dB)	33.73	2.3605	30.08	1.0186
Lowest	GSM850	26.83	0.4819	23.18	0.2080
Middle	EDGE class 8	26.91	0.4909	23.26	0.2118
Highest	(GT - LC = -1.5 dB)	27.26	0.5321	23.61	0.2296
Lowest	WCDMA Band V	24.40	0.2754	20.75	0.1189
Middle	RMC 12.2Kbps	24.79	0.3013	21.14	0.1300
Highest	(GT - LC = -1.5 dB)	24.70	0.2951	21.05	0.1274
Limit	ERP < 7W	Result		PASS	

Channel	Mode	Conducted		EIRP	
		Power (dBm)	Power (Watts)	EIRP(dBm)	EIRP(W)
Lowest	GSM1900	29.73	0.9397	29.63	0.9183
Middle	GPRS class 8	29.86	0.9683	29.76	0.9462
Highest	(GT - LC = -0.1 dB)	29.92	0.9817	29.82	0.9594
Lowest	GSM1900	25.35	0.3428	25.25	0.3350
Middle	EDGE class 8	25.40	0.3467	25.30	0.3388
Highest	(GT - LC = -0.1 dB)	25.50	0.3548	25.40	0.3467
Lowest	WCDMA Band II	22.68	0.1854	22.58	0.1811
Middle	RMC 12.2Kbps	22.77	0.1892	22.67	0.1849
Highest	(GT - LC = -0.1 dB)	22.54	0.1795	22.44	0.1754
Limit	EIRP < 2W	Result		PASS	

Channel	Mode	Conducted		EIRP	
		Power (dBm)	Power (Watts)	EIRP(dBm)	EIRP(W)
Lowest	WCDMA Band IV	24.18	0.2618	24.38	0.2742
Middle	RMC 12.2Kbps	24.29	0.2685	24.49	0.2812
Highest	(GT - LC = 0.2 dB)	24.18	0.2618	24.38	0.2742
Limit	EIRP < 1W	Result		PASS	



Radiated Spurious Emission

GPRS 850

GPRS 850									
Channel	Frequency (MHz)	ERP (dBm)	Limit (dBm)	Over Limit (dB)	SPA Reading (dBm)	S.G. Power (dBm)	TX Cable loss (dB)	TX Antenna Gain (dBi)	Polarization (H/V)
Lowest	1648	-50.11	-13	-37.11	-60.02	-57.06	0.53	9.63	H
	2472	-33.06	-13	-20.06	-46.5	-41.04	0.65	10.78	H
	3296	-56.16	-13	-43.16	-72.3	-65.24	0.76	11.99	H
	4120	-54.89	-13	-41.89	-72.28	-64.23	0.86	12.35	H
									H
									H
	1648	-48.91	-13	-35.91	-58.53	-55.86	0.53	9.63	V
	2472	-32.59	-13	-19.59	-46.52	-40.57	0.65	10.78	V
	3296	-53.44	-13	-40.44	-69.55	-62.52	0.76	11.99	V
	4120	-56.26	-13	-43.26	-74.83	-65.6	0.86	12.35	V
									V
									V
Middle	1672	-54.83	-13	-41.83	-64.92	-61.83	0.53	9.68	H
	2512	-35.09	-13	-22.09	-48.51	-43.09	0.66	10.81	H
	3344	-58.41	-13	-45.41	-74.61	-67.63	0.76	12.13	H
	4184	-56.20	-13	-43.20	-73.64	-65.54	0.84	12.33	H
									H
									H
	1672	-50.44	-13	-37.44	-60.13	-57.44	0.53	9.68	V
	2512	-31.82	-13	-18.82	-45.65	-39.82	0.66	10.81	V
	3344	-55.77	-13	-42.77	-71.78	-64.99	0.76	12.13	V
	4184	-55.46	-13	-42.46	-74.13	-64.8	0.84	12.33	V
									V
									V



Highest	1696	-49.81	-13	-36.81	-60.19	-56.86	0.53	9.73	H
	2544	-32.37	-13	-19.37	-45.85	-40.38	0.67	10.83	H
	3392	-58.47	-13	-45.47	-74.78	-67.83	0.77	12.28	H
	4248	-56.23	-13	-43.23	-73.84	-65.54	0.84	12.30	H
									H
									H
									H
	1696	-48.80	-13	-35.80	-58.56	-55.85	0.53	9.73	V
	2544	-38.74	-13	-25.74	-52.59	-46.75	0.67	10.83	V
	3392	-58.81	-13	-45.81	-74.71	-68.17	0.77	12.28	V
	4248	-52.57	-13	-39.57	-71.45	-61.88	0.84	12.30	V
									V
									V
									V

Remark: Spurious emissions within 30-1000MHz were found more than 20dB below limit line.



EDGE 850

EDGE 850										
Channel	Frequency (MHz)	ERP (dBm)	Limit (dBm)	Over Limit (dB)	SPA Reading (dBm)	S.G. Power (dBm)	TX Cable loss (dB)	TX Antenna Gain (dBi)	Polarization (H/V)	
Lowest	1648	-51.79	-13	-38.79	-61.7	-58.74	0.53	9.63	H	
	2472	-36.32	-13	-23.32	-49.76	-44.3	0.65	10.78	H	
	3296	-57.29	-13	-44.29	-73.43	-66.37	0.76	11.99	H	
	4120	-53.75	-13	-40.75	-71.14	-63.09	0.86	12.35	H	
										H
										H
										H
	1648	-50.46	-13	-37.46	-60.08	-57.41	0.53	9.63	V	
	2472	-36.90	-13	-23.90	-50.12	-44.88	0.65	10.78	V	
	3296	-56.47	-13	-43.47	-72.58	-65.55	0.76	11.99	V	
	4120	-53.91	-13	-40.91	-72.48	-63.25	0.86	12.35	V	
										V
										V
										V
Middle	1672	-52.85	-13	-39.85	-62.94	-59.85	0.53	9.68	H	
	2512	-42.58	-13	-29.58	-56	-50.58	0.66	10.81	H	
	3344	-57.35	-13	-44.35	-73.55	-66.57	0.76	12.13	H	
	4184	-53.43	-13	-40.43	-70.87	-62.77	0.84	12.33	H	
										H
										H
										H
	1672	-52.11	-13	-39.11	-61.8	-59.11	0.53	9.68	V	
	2512	-34.92	-13	-21.92	-48.75	-42.92	0.66	10.81	V	
	3344	-58.64	-13	-45.64	-74.65	-67.86	0.76	12.13	V	
	4184	-55.37	-13	-42.37	-74.04	-64.71	0.84	12.33	V	
										V
										V
										V



Highest	1696	-50.48	-13	-37.48	-60.86	-57.53	0.53	9.73	H
	2544	-37.64	-13	-24.64	-51.12	-45.65	0.67	10.83	H
	3392	-58.50	-13	-45.50	-74.81	-67.86	0.77	12.28	H
									H
									H
									H
									H
	1696	-47.88	-13	-34.88	-57.64	-54.93	0.53	9.73	V
	2544	-37.74	-13	-24.74	-51.59	-45.75	0.67	10.83	V
	3392	-59.09	-13	-46.09	-74.99	-68.45	0.77	12.28	V
									V
									V
									V
									V

Remark: Spurious emissions within 30-1000MHz were found more than 20dB below limit line.



WCDMA 850

WCDMA 850									
Channel	Frequency (MHz)	ERP (dBm)	Limit (dBm)	Over Limit (dB)	SPA Reading (dBm)	S.G. Power (dBm)	TX Cable loss (dB)	TX Antenna Gain (dBi)	Polarization (H/V)
Lowest	1648	-63.16	-13	-50.16	-73.07	-70.11	0.53	9.63	H
	2480	-60.04	-13	-47.04	-73.48	-68.02	0.65	10.78	H
	3304	-58.46	-13	-45.46	-74.59	-67.56	0.76	12.01	H
									H
									H
									H
									H
	1648	-60.78	-13	-47.78	-70.4	-67.73	0.53	9.63	V
	2480	-58.64	-13	-45.64	-72.57	-66.62	0.65	10.78	V
	3304	-59.01	-13	-46.01	-75.11	-68.11	0.76	12.01	V
									V
									V
									V
									V
Middle	1672	-63.06	-13	-50.06	-73.15	-70.06	0.53	9.68	H
	2504	-59.27	-13	-46.27	-72.7	-67.27	0.66	10.80	H
	3336	-58.41	-13	-45.41	-74.62	-67.61	0.76	12.11	H
									H
									H
									H
									H
	1672	-62.92	-13	-49.92	-72.61	-69.92	0.53	9.68	V
	2504	-56.57	-13	-43.57	-70.41	-64.57	0.66	10.80	V
	3336	-58.88	-13	-45.88	-74.9	-68.08	0.76	12.11	V
									V
									V
									V
									V



Highest	1688	-63.10	-13	-50.10	-73.35	-70.13	0.53	9.71	H
	2536	-60.47	-13	-47.47	-73.92	-68.48	0.66	10.82	H
	3384	-58.95	-13	-45.95	-75.25	-68.28	0.77	12.25	H
									H
									H
									H
									H
	1688	-61.46	-13	-48.46	-71.21	-68.49	0.53	9.71	V
	2536	-59.08	-13	-46.08	-72.91	-67.09	0.66	10.82	V
	3384	-59.21	-13	-46.21	-75.1	-68.54	0.77	12.25	V
									V
									V
									V
									V

Remark: Spurious emissions within 30-1000MHz were found more than 20dB below limit line.



WCDMA 1700

WCDMA 1700									
Channel	Frequency (MHz)	EIRP (dBm)	Limit (dBm)	Over Limit (dB)	SPA Reading (dBm)	S.G. Power (dBm)	TX Cable loss (dB)	TX Antenna Gain (dBi)	Polarization (H/V)
Lowest	3424	-57.01	-13	-44.01	-74.17	-68.61	0.77	12.37	H
	5136	-55.31	-13	-42.31	-76.01	-66.81	0.97	12.47	H
	6848	-53.50	-13	-40.50	-77.19	-64.31	0.82	11.63	H
									H
									H
									H
									H
	3424	-56.66	-13	-43.66	-73.63	-68.26	0.77	12.37	V
	5136	-55.07	-13	-42.07	-75.94	-66.57	0.97	12.47	V
	6848	-53.43	-13	-40.43	-77.59	-64.24	0.82	11.63	V
									V
									V
									V
									V
Middle	3462	-56.07	-13	-43.07	-73.27	-67.78	0.78	12.49	H
	5196	-53.06	-13	-40.06	-73.85	-64.66	0.99	12.59	H
	6928	-52.11	-13	-39.11	-76	-62.57	1.00	11.46	H
									H
									H
									H
									H
	3462	-55.32	-13	-42.32	-72.91	-67.03	0.78	12.49	V
	5196	-51.24	-13	-38.24	-72.19	-62.84	0.99	12.59	V
	6928	-52.23	-13	-39.23	-76.5	-62.69	1.00	11.46	V
									V
									V
									V
									V



Highest	3504	-58.06	-13	-45.06	-75.31	-69.88	0.78	12.60	H
	5262	-50.58	-13	-37.58	-71.55	-62.29	1.01	12.72	H
	7008	-52.55	-13	-39.55	-76.58	-62.67	1.17	11.29	H
									H
									H
									H
									H
	3504	-55.87	-13	-42.87	-74.09	-67.69	0.78	12.60	V
	5262	-46.50	-13	-33.50	-67.61	-58.21	1.01	12.72	V
	7008	-52.31	-13	-39.31	-76.64	-62.43	1.17	11.29	V
									V
									V
									V
									V

Remark: Spurious emissions within 30-1000MHz were found more than 20dB below limit line.



GPRS 1900

GPRS 1900									
Channel	Frequency (MHz)	EIRP (dBm)	Limit (dBm)	Over Limit (dB)	SPA Reading (dBm)	S.G. Power (dBm)	TX Cable loss (dB)	TX Antenna Gain (dBi)	Polarization (H/V)
Lowest	3702	-47.07	-13	-34.07	-64.06	-58.86	0.72	12.52	H
	5550	-35.09	-13	-22.09	-56.95	-47.26	1.00	13.17	H
	7398	-52.21	-13	-39.21	-77.33	-61.61	1.18	10.58	H
									H
									H
									H
									H
	3702	-49.12	-13	-36.12	-67.28	-60.91	0.72	12.52	V
	5550	-45.31	-13	-32.31	-67.26	-57.48	1.00	13.17	V
	7398	-51.68	-13	-38.68	-76.59	-61.08	1.18	10.58	V
									V
									V
									V
									V
Middle	3762	-49.47	-13	-36.47	-66.62	-61.28	0.69	12.50	H
	5640	-35.55	-13	-22.55	-57.27	-47.68	0.98	13.12	H
	7518	-52.17	-13	-39.17	-77.08	-61.44	1.18	10.45	H
									H
									H
									H
									H
	3762	-51.46	-13	-38.46	-69.82	-63.27	0.69	12.50	V
	5640	-42.95	-13	-29.95	-64.84	-55.08	0.98	13.12	V
	7518	-50.29	-13	-37.29	-75.25	-59.56	1.18	10.45	V
									V
									V
									V
									V



Highest	3822	-50.28	-13	-37.28	-67.55	-62.06	0.69	12.47	H
	5730	-43.34	-13	-30.34	-65.08	-55.41	0.99	13.06	H
	7638	-49.72	-13	-36.72	-74.9	-59.32	1.18	10.79	H
									H
									H
									H
									H
	3822	-50.79	-13	-37.79	-69.28	-62.57	0.69	12.47	V
	5730	-47.95	-13	-34.95	-69.9	-60.02	0.99	13.06	V
	7638	-49.11	-13	-36.11	-74.04	-58.71	1.18	10.79	V
									V
									V
									V
									V

Remark: Spurious emissions within 30-1000MHz were found more than 20dB below limit line.



EDGE1900

EDGE 1900									
Channel	Frequency (MHz)	EIRP (dBm)	Limit (dBm)	Over Limit (dB)	SPA Reading (dBm)	S.G. Power (dBm)	TX Cable loss (dB)	TX Antenna Gain (dBi)	Polarization (H/V)
Lowest	3702	-46.95	-13	-33.95	-63.94	-58.74	0.72	12.52	H
	5550	-39.35	-13	-26.35	-61.21	-51.52	1.00	13.17	H
	7398	-52.32	-13	-39.32	-77.44	-61.72	1.18	10.58	H
									H
									H
									H
									H
	3702	-48.26	-13	-35.26	-66.42	-60.05	0.72	12.52	V
	5550	-41.49	-13	-28.49	-63.44	-53.66	1.00	13.17	V
	7398	-52.08	-13	-39.08	-76.99	-61.48	1.18	10.58	V
									V
									V
									V
									V
Middle	3762	-47.77	-13	-34.77	-64.92	-59.58	0.69	12.50	H
	5640	-40.31	-13	-27.31	-62.03	-52.44	0.98	13.12	H
	7518	-52.01	-13	-39.01	-76.92	-61.28	1.18	10.45	H
									H
									H
									H
									H
	3762	-51.93	-13	-38.93	-70.29	-63.74	0.69	12.50	V
	5640	-43.54	-13	-30.54	-65.43	-55.67	0.98	13.12	V
	7518	-51.28	-13	-38.28	-76.24	-60.55	1.18	10.45	V
									V
									V
									V
									V



Highest	3822	-49.61	-13	-36.61	-66.88	-61.39	0.69	12.47	H
	5730	-41.89	-13	-28.89	-63.63	-53.96	0.99	13.06	H
	7638	-49.26	-13	-36.26	-74.44	-58.86	1.18	10.79	H
									H
									H
									H
									H
	3822	-51.08	-13	-38.08	-69.57	-62.86	0.69	12.47	V
	5730	-45.27	-13	-32.27	-67.22	-57.34	0.99	13.06	V
	7638	-48.94	-13	-35.94	-73.87	-58.54	1.18	10.79	V
									V
									V
									V
									V

Remark: Spurious emissions within 30-1000MHz were found more than 20dB below limit line.



WCDMA 1900

WCDMA 1900									
Channel	Frequency (MHz)	EIRP (dBm)	Limit (dBm)	Over Limit (dB)	SPA Reading (dBm)	S.G. Power (dBm)	TX Cable loss (dB)	TX Antenna Gain (dBi)	Polarization (H/V)
Lowest	3702	-56.98	-13	-43.98	-73.97	-68.77	0.72	12.52	H
	5556	-50.89	-13	-37.89	-72.7	-63.06	1.00	13.17	H
	7410	-51.86	-13	-38.86	-76.94	-61.24	1.18	10.56	H
									H
									H
									H
									H
	3702	-56.45	-13	-43.45	-74.61	-68.24	0.72	12.52	V
	5556	-53.76	-13	-40.76	-75.69	-65.93	1.00	13.17	V
	7410	-52.18	-13	-39.18	-77.11	-61.56	1.18	10.56	V
									V
									V
									V
									V
Middle	3762	-57.01	-13	-44.01	-74.16	-68.82	0.69	12.50	H
	5640	-53.26	-13	-40.26	-74.98	-65.39	0.98	13.12	H
	7518	-51.92	-13	-38.92	-76.83	-61.19	1.18	10.45	H
									H
									H
									H
									H
	3762	-55.53	-13	-42.53	-73.89	-67.34	0.69	12.50	V
	5640	-52.62	-13	-39.62	-74.51	-64.75	0.98	13.12	V
	7518	-51.59	-13	-38.59	-76.55	-60.86	1.18	10.45	V
									V
									V
									V
									V



Highest	3816	-57.19	-13	-44.19	-74.46	-68.98	0.69	12.47	H
	5724	-53.09	-13	-40.09	-74.84	-65.16	0.99	13.07	H
	7632	-51.39	-13	-38.39	-76.57	-60.98	1.18	10.77	H
									H
									H
									H
									H
	3816	-55.77	-13	-42.77	-74.26	-67.56	0.69	12.47	V
	5724	-53.00	-13	-40.00	-74.96	-65.07	0.99	13.07	V
	7632	-51.63	-13	-38.63	-76.56	-61.22	1.18	10.77	V
									V
									V
									V
									V

Remark: Spurious emissions within 30-1000MHz were found more than 20dB below limit line.