

### #01\_GSM850\_GPRS (4 Tx slots)\_Right Cheek\_Ch128

Communication System: GSM850 ; Frequency: 824.2 MHz;Duty Cycle: 1:2.08

Medium: HSL\_850\_180320 Medium parameters used :  $f = 824.2$  MHz;  $\sigma = 0.877$  S/m;  $\epsilon_r = 43$ ;  $\rho = 1000$  kg/m<sup>3</sup>

Ambient Temperature : 23.2 °C ; Liquid Temperature : 22.2 °C

#### DASY5 Configuration:

- Probe: ES3DV3 - SN3270; ConvF(6.18, 6.18, 6.18); Calibrated: 2017/9/25;
- Sensor-Surface: 3mm (Mechanical Surface Detection)
- Electronics: DAE4 Sn778; Calibrated: 2017/5/22
- Phantom: SAM-Right; Type: SAM; Serial: TP-1503
- Measurement SW: DASY52, Version 52.8 (8);SEMCAD X Version 14.6.10 (7373)

**Area Scan (61x121x1):** Interpolated grid: dx=1.500 mm, dy=1.500 mm

Maximum value of SAR (interpolated) = 0.331 W/kg

**Zoom Scan (5x5x7)/Cube 0:** Measurement grid: dx=8mm, dy=8mm, dz=5mm

Reference Value = 7.297 V/m; Power Drift = 0.07 dB

Peak SAR (extrapolated) = 0.374 W/kg

**SAR(1 g) = 0.297 W/kg; SAR(10 g) = 0.231 W/kg**

Maximum value of SAR (measured) = 0.324 W/kg

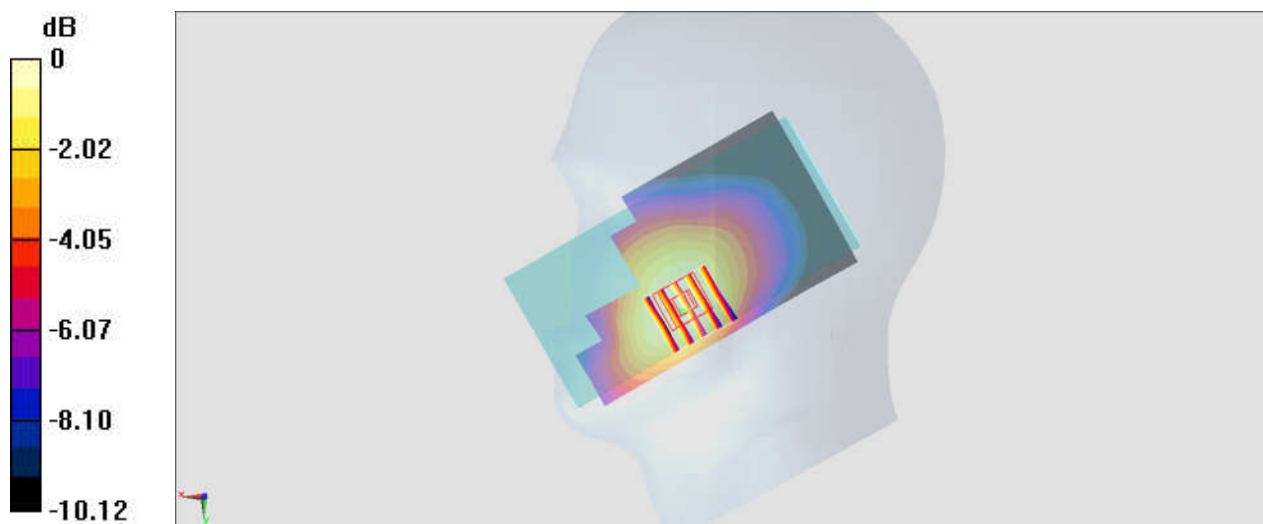

0 dB = 0.324 W/kg = -4.89 dBW/kg

### #02\_GSM1900\_GPRS (4 Tx slots)\_Left Cheek\_Ch512

Communication System: PCS; Frequency: 1850.2 MHz; Duty Cycle: 1:8.3  
Medium: HSL\_1900\_180328 Medium parameters used :  $f = 1850.2$  MHz;  $\sigma = 1.394$  S/m;  $\epsilon_r = 41.296$ ;  $\rho = 1000$  kg/m<sup>3</sup>  
Ambient Temperature : 23.3 °C; Liquid Temperature : 22.3 °C

#### DASY5 Configuration:

- Probe: EX3DV4 - SN3925; ConvF(8.73, 8.73, 8.73); Calibrated: 2017/5/24;
- Sensor-Surface: 1.4mm (Mechanical Surface Detection)
- Electronics: DAE4 Sn1424; Calibrated: 2018/1/18
- Phantom: SAM\_Left; Type: QD000P40CD; Serial: TP:1431
- Measurement SW: DASY52, Version 52.8 (8); SEMCAD X Version 14.6.10 (7373)

**Area Scan (61x121x1):** Interpolated grid: dx=1.500 mm, dy=1.500 mm  
Maximum value of SAR (interpolated) = 0.782 W/kg

**Zoom Scan (5x5x7)/Cube 0:** Measurement grid: dx=8mm, dy=8mm, dz=5mm  
Reference Value = 11.24 V/m; Power Drift = 0.06 dB  
Peak SAR (extrapolated) = 1.06 W/kg  
**SAR(1 g) = 0.571 W/kg; SAR(10 g) = 0.286 W/kg**  
Maximum value of SAR (measured) = 0.803 W/kg

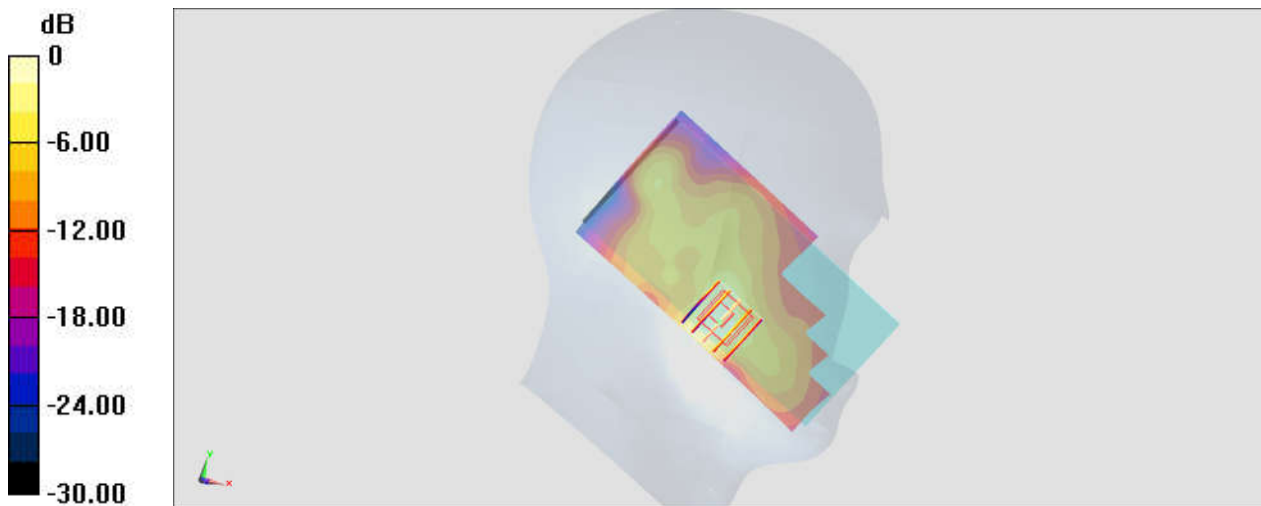

0 dB = 0.803 W/kg = -0.95 dBW/kg

**#03\_WCDMA II\_RMC 12.2Kbps\_Left Cheek\_Ch9262**

Communication System: WCDMA; Frequency: 1852.4 MHz; Duty Cycle: 1:1

Medium: HSL\_1900\_180323 Medium parameters used:  $f = 1852.4$  MHz;  $\sigma = 1.374$  S/m;  $\epsilon_r = 38.817$ ;  $\rho = 1000$  kg/m<sup>3</sup>

Ambient Temperature : 23.6 °C ; Liquid Temperature : 22.6 °C

**DASY5 Configuration**

- Probe: EX3DV4 - SN3931; ConvF(8.45, 8.45, 8.45); Calibrated: 2017/9/29;
- Sensor-Surface: 1.4mm (Mechanical Surface Detection)
- Electronics: DAE4 Sn1399; Calibrated: 2017/11/16
- Phantom: SAM\_Right; Type: QD000P40CD; Serial: S/N:1796
- Measurement SW: DASY52, Version 52.8 (8); SEMCAD X Version 14.6.10 (7373)

**Area Scan (71x131x1):** Interpolated grid: dx=1.500 mm, dy=1.500 mm

Maximum value of SAR (interpolated) = 0.870 W/kg

**Zoom Scan (5x5x7)/Cube 0:** Measurement grid: dx=8mm, dy=8mm, dz=5mm

Reference Value = 12.94 V/m; Power Drift = -0.11 dB

Peak SAR (extrapolated) = 1.01 W/kg

**SAR(1 g) = 0.630 W/kg; SAR(10 g) = 0.343 W/kg**

Maximum value of SAR (measured) = 0.864 W/kg

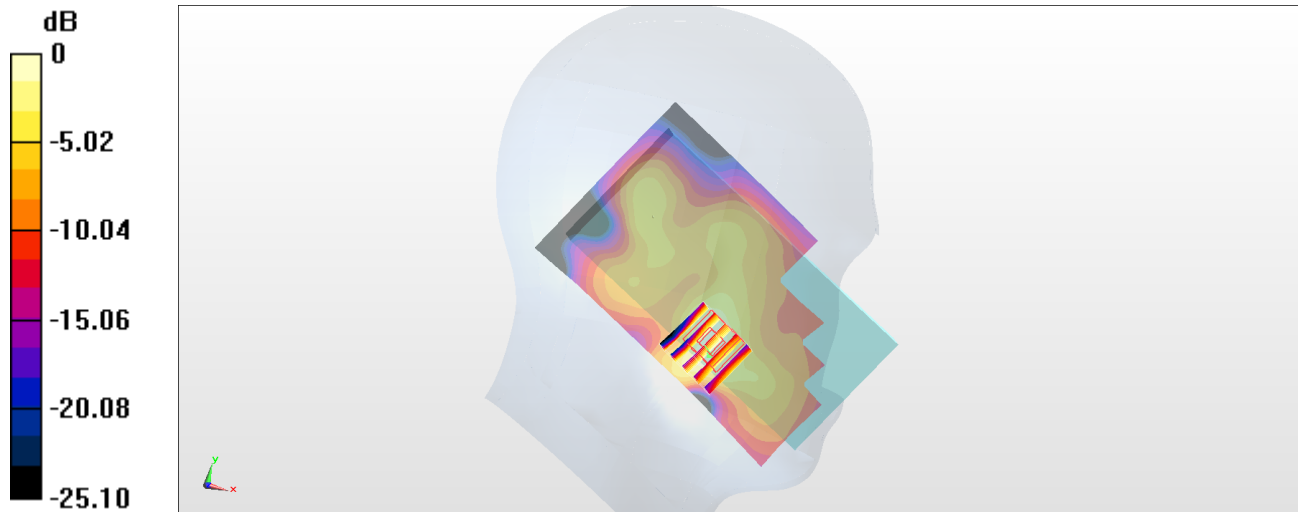

0 dB = 0.864 W/kg = -0.63 dBW/kg

**#04\_WCDMA IV\_RMC 12.2Kbps\_Left Cheek\_Ch1513**

Communication System: WCDMA ; Frequency: 1752.6 MHz;Duty Cycle: 1:1

Medium: HSL\_1750\_180323 Medium parameters used:  $f = 1753$  MHz;  $\sigma = 1.375$  S/m;  $\epsilon_r = 41.288$ ;  $\rho = 1000$  kg/m<sup>3</sup>

Ambient Temperature : 23.6 °C ; Liquid Temperature : 22.6 °C

**DASY5 Configuration**

- Probe: EX3DV4 - SN3931; ConvF(8.8, 8.8, 8.8); Calibrated: 2017/9/29;
- Sensor-Surface: 1.4mm (Mechanical Surface Detection)
- Electronics: DAE4 Sn1399; Calibrated: 2017/11/16
- Phantom: SAM\_Right; Type: QD000P40CD; Serial: S/N:1796
- Measurement SW: DASY52, Version 52.8 (8); SEMCAD X Version 14.6.10 (7373)

**Area Scan (71x121x1):** Interpolated grid: dx=1.500 mm, dy=1.500 mm

Maximum value of SAR (interpolated) = 1.03 W/kg

**Zoom Scan (5x5x7)/Cube 0:** Measurement grid: dx=8mm, dy=8mm, dz=5mm

Reference Value = 14.90 V/m; Power Drift = -0.05 dB

Peak SAR (extrapolated) = 1.20 W/kg

**SAR(1 g) = 0.732 W/kg; SAR(10 g) = 0.404 W/kg**

Maximum value of SAR (measured) = 1.03 W/kg

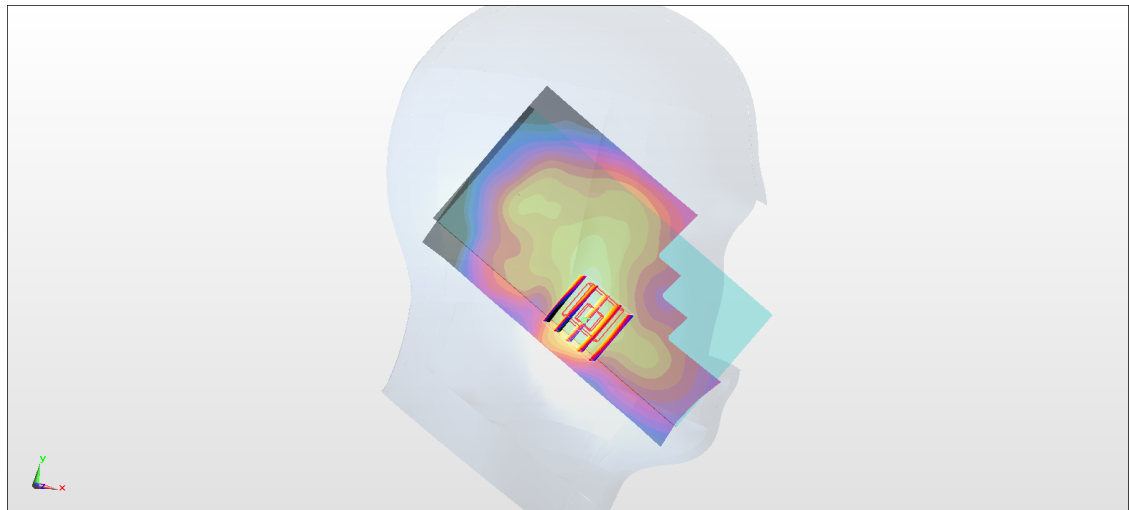
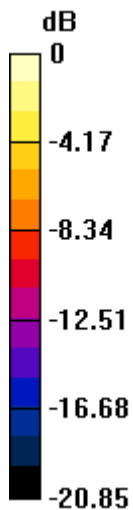

0 dB = 1.03 W/kg = 0.13 dBW/kg

### #05\_WCDMA V\_RMC 12.2Kbps\_Right Cheek\_Ch4132

Communication System: WCDMA ; Frequency: 826.4 MHz;Duty Cycle: 1:1  
Medium: HSL\_850\_180320 Medium parameters used :  $f = 826.4$  MHz;  $\sigma = 0.879$  S/m;  $\epsilon_r = 42.975$ ;  
 $\rho = 1000$  kg/m<sup>3</sup>  
Ambient Temperature : 23.2 °C ; Liquid Temperature : 22.2 °C

#### DASY5 Configuration:

- Probe: ES3DV3 - SN3270; ConvF(6.18, 6.18, 6.18); Calibrated: 2017/9/25;
- Sensor-Surface: 3mm (Mechanical Surface Detection)
- Electronics: DAE4 Sn778; Calibrated: 2017/5/22
- Phantom: SAM-Right; Type: SAM; Serial: TP-1503
- Measurement SW: DASY52, Version 52.8 (8);SEMCAD X Version 14.6.10 (7373)

**Area Scan (61x121x1):** Interpolated grid: dx=1.500 mm, dy=1.500 mm  
Maximum value of SAR (interpolated) = 0.327 W/kg

**Zoom Scan (5x5x7)/Cube 0:** Measurement grid: dx=8mm, dy=8mm, dz=5mm  
Reference Value = 6.453 V/m; Power Drift = 0.05 dB  
Peak SAR (extrapolated) = 0.364 W/kg  
**SAR(1 g) = 0.298 W/kg; SAR(10 g) = 0.233 W/kg**  
Maximum value of SAR (measured) = 0.321 W/kg

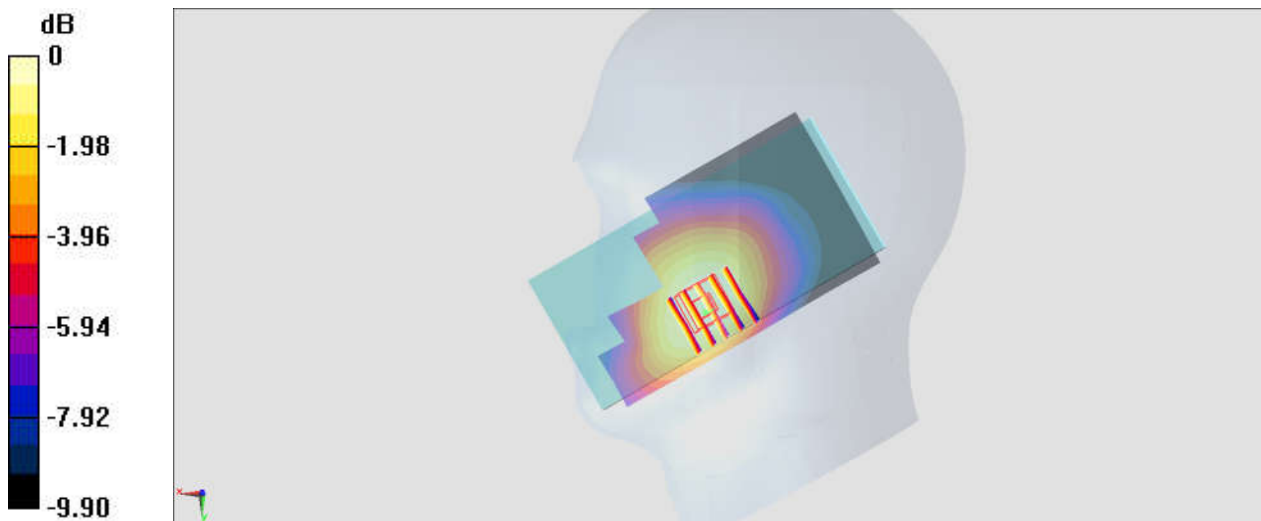

0 dB = 0.321 W/kg = -4.93 dBW/kg

**#06\_LTE Band 4\_20M\_QPSK\_1\_0\_Left Cheek\_Ch20175**

Communication System: LTE ; Frequency: 1732.5 MHz;Duty Cycle: 1:1

Medium: HSL\_1750\_180323 Medium parameters used :  $f = 1732.5$  MHz;  $\sigma = 1.356$  S/m;  $\epsilon_r = 41.346$ ;  $\rho = 1000$  kg/m<sup>3</sup>

Ambient Temperature : 23.6 °C ; Liquid Temperature : 22.6 °C

**DASY5 Configuration**

- Probe: EX3DV4 - SN3931; ConvF(8.8, 8.8, 8.8); Calibrated: 2017/9/29;
- Sensor-Surface: 1.4mm (Mechanical Surface Detection)
- Electronics: DAE4 Sn1399; Calibrated: 2017/11/16
- Phantom: SAM\_Right; Type: QD000P40CD; Serial: S/N:1796
- Measurement SW: DASY52, Version 52.8 (8); SEMCAD X Version 14.6.10 (7373)

**Area Scan (61x121x1):** Interpolated grid: dx=1.500 mm, dy=1.500 mm

Maximum value of SAR (interpolated) = 0.932 W/kg

**Zoom Scan (5x5x7)/Cube 0:** Measurement grid: dx=8mm, dy=8mm, dz=5mm

Reference Value = 11.27 V/m; Power Drift = -0.11 dB

Peak SAR (extrapolated) = 1.07 W/kg

**SAR(1 g) = 0.678 W/kg; SAR(10 g) = 0.376 W/kg**

Maximum value of SAR (measured) = 0.923 W/kg

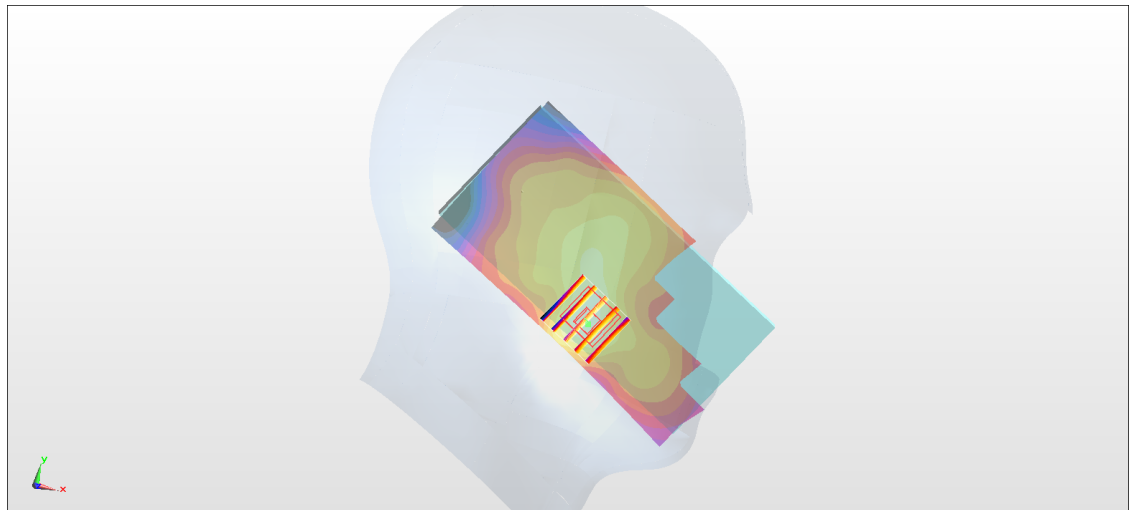
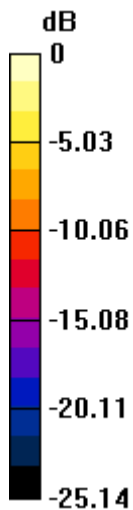

0 dB = 0.923 W/kg = -0.35 dBW/kg

### #07\_LTE Band 5\_10M\_QPSK\_1\_0\_Right Cheek\_Ch20525

Communication System: LTE; Frequency: 836.5 MHz; Duty Cycle: 1:1  
Medium: HSL\_850\_180320 Medium parameters used:  $f = 836.5$  MHz;  $\sigma = 0.889$  S/m;  $\epsilon_r = 42.855$ ;  
 $\rho = 1000$  kg/m<sup>3</sup>  
Ambient Temperature : 23.2 °C ; Liquid Temperature : 22.2 °C

#### DASY5 Configuration:

- Probe: ES3DV3 - SN3270; ConvF(6.18, 6.18, 6.18); Calibrated: 2017/9/25;
- Sensor-Surface: 3mm (Mechanical Surface Detection)
- Electronics: DAE4 Sn778; Calibrated: 2017/5/22
- Phantom: SAM-Right; Type: SAM; Serial: TP-1503
- Measurement SW: DASY52, Version 52.8 (8); SEMCAD X Version 14.6.10 (7373)

**Area Scan (61x121x1):** Interpolated grid: dx=1.500 mm, dy=1.500 mm  
Maximum value of SAR (interpolated) = 0.230 W/kg

**Zoom Scan (5x6x7)/Cube 0:** Measurement grid: dx=8mm, dy=8mm, dz=5mm  
Reference Value = 7.897 V/m; Power Drift = -0.08 dB  
Peak SAR (extrapolated) = 0.258 W/kg  
**SAR(1 g) = 0.210 W/kg; SAR(10 g) = 0.164 W/kg**  
Maximum value of SAR (measured) = 0.226 W/kg

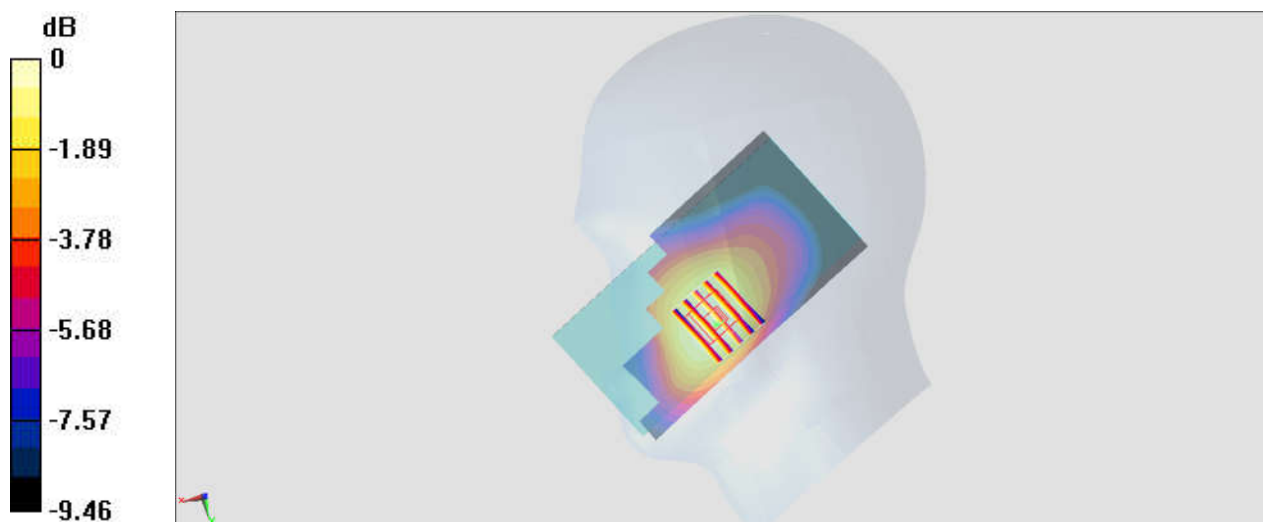

0 dB = 0.226 W/kg = -6.46 dBW/kg

**#08\_LTE Band 7\_20M\_QPSK\_1\_49\_Right Cheek\_Ch20850**

Communication System: LTE ; Frequency: 2510 MHz;Duty Cycle: 1:1

Medium: HSL\_2600\_180323 Medium parameters used:  $f = 2510$  MHz;  $\sigma = 1.819$  S/m;  $\epsilon_r = 38.463$ ;  $\rho = 1000$  kg/m<sup>3</sup>

Ambient Temperature : 23.6 °C ; Liquid Temperature : 22.6 °C

**DASY5 Configuration**

- Probe: EX3DV4 - SN3931; ConvF(7.38, 7.38, 7.38); Calibrated: 2017/9/29;
- Sensor-Surface: 1.4mm (Mechanical Surface Detection)
- Electronics: DAE4 Sn1399; Calibrated: 2017/11/16
- Phantom: SAM\_Right; Type: QD000P40CD; Serial: S/N:1796
- Measurement SW: DASY52, Version 52.8 (8); SEMCAD X Version 14.6.10 (7373)

**Area Scan (91x161x1):** Interpolated grid: dx=1.200 mm, dy=1.200 mm

Maximum value of SAR (interpolated) = 0.926 W/kg

**Zoom Scan (7x7x7)/Cube 0:** Measurement grid: dx=5mm, dy=5mm, dz=5mm

Reference Value = 4.786 V/m; Power Drift = -0.09 dB

Peak SAR (extrapolated) = 1.16 W/kg

**SAR(1 g) = 0.555 W/kg; SAR(10 g) = 0.253 W/kg**

Maximum value of SAR (measured) = 0.943 W/kg

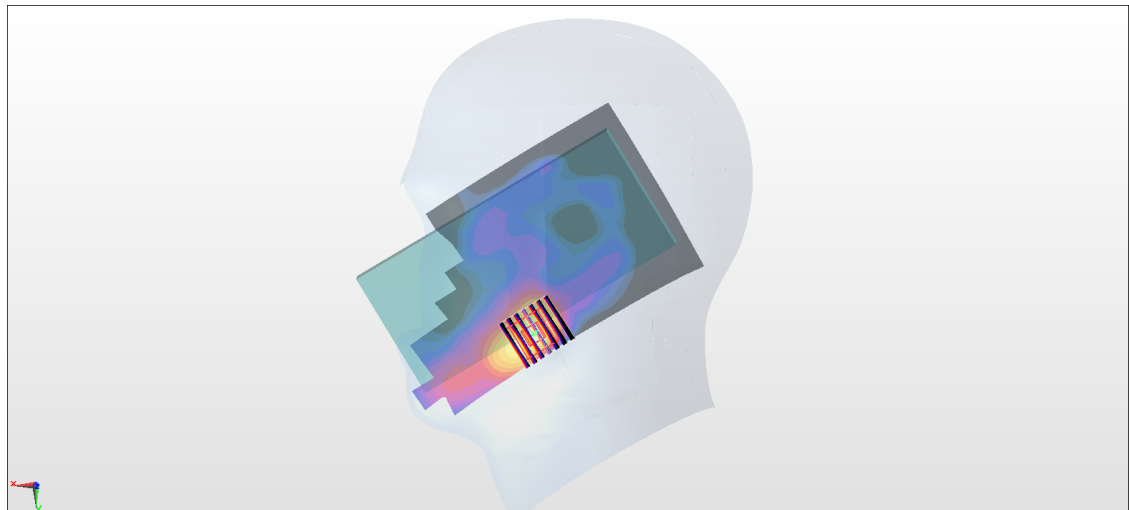
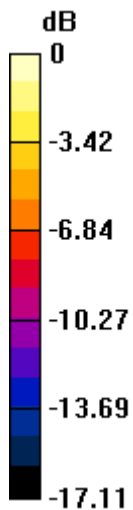



**#09\_LTE Band 12\_10M\_QPSK\_1\_0\_Right Cheek\_Ch23095**

Communication System: LTE; Frequency: 707.5 MHz; Duty Cycle: 1:1

Medium: HSL\_750\_180321 Medium parameters used :  $f = 707.5$  MHz;  $\sigma = 0.849$  S/m;  $\epsilon_r = 44.107$ ;

$\rho = 1000$  kg/m<sup>3</sup>

Ambient Temperature : 23.3 °C ; Liquid Temperature : 22.3 °C

DASY5 Configuration:

- Probe: ES3DV3 - SN3270; ConvF(6.34, 6.34, 6.34); Calibrated: 2017/9/25;

- Sensor-Surface: 3mm (Mechanical Surface Detection)

- Electronics: DAE4 Sn778; Calibrated: 2017/5/22

- Phantom: SAM-Right; Type: SAM; Serial: TP-1503

- Measurement SW: DASY52, Version 52.8 (8); SEMCAD X Version 14.6.10 (7373)

**Area Scan (61x121x1):** Interpolated grid: dx=1.500 mm, dy=1.500 mm

Maximum value of SAR (interpolated) = 0.135 W/kg

**Zoom Scan (5x5x7)/Cube 0:** Measurement grid: dx=8mm, dy=8mm, dz=5mm

Reference Value = 4.300 V/m; Power Drift = 0.06 dB

Peak SAR (extrapolated) = 0.148 W/kg

**SAR(1 g) = 0.125 W/kg; SAR(10 g) = 0.101 W/kg**

Maximum value of SAR (measured) = 0.134 W/kg

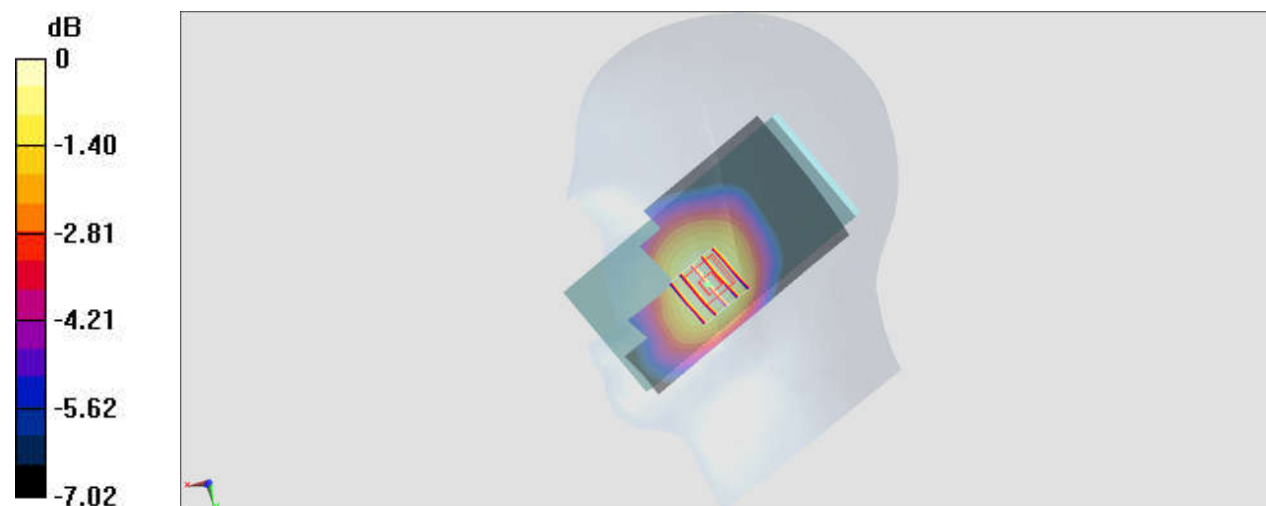

0 dB = 0.134 W/kg = -8.73 dBW/kg

**#10\_LTE Band 13\_10M\_QPSK\_1\_0\_Right Cheek\_Ch23230**

Communication System: LTE; Frequency: 782 MHz; Duty Cycle: 1:1

Medium: HSL\_750\_180321 Medium parameters used:  $f = 782$  MHz;  $\sigma = 0.924$  S/m;  $\epsilon_r = 43.075$ ;  $\rho = 1000$  kg/m<sup>3</sup>

Ambient Temperature : 23.3 °C; Liquid Temperature : 22.3 °C

DASY5 Configuration:

- Probe: ES3DV3 - SN3270; ConvF(6.34, 6.34, 6.34); Calibrated: 2017/9/25;
- Sensor-Surface: 3mm (Mechanical Surface Detection)
- Electronics: DAE4 Sn778; Calibrated: 2017/5/22
- Phantom: SAM-Right; Type: SAM; Serial: TP-1503
- Measurement SW: DASY52, Version 52.8 (8); SEMCAD X Version 14.6.10 (7373)

**Area Scan (61x121x1):** Interpolated grid: dx=1.500 mm, dy=1.500 mm

Maximum value of SAR (interpolated) = 0.174 W/kg

**Zoom Scan (5x5x7)/Cube 0:** Measurement grid: dx=8mm, dy=8mm, dz=5mm

Reference Value = 5.561 V/m; Power Drift = 0.04 dB

Peak SAR (extrapolated) = 0.195 W/kg

**SAR(1 g) = 0.160 W/kg; SAR(10 g) = 0.127 W/kg**

Maximum value of SAR (measured) = 0.173 W/kg

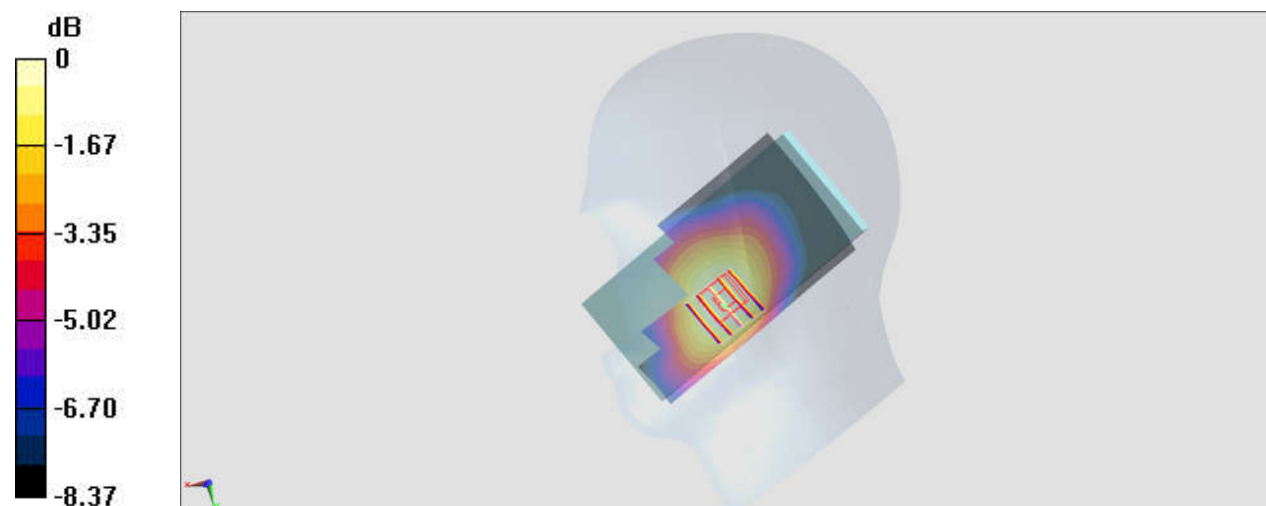

0 dB = 0.173 W/kg = -7.62 dBW/kg

### #11\_LTE Band 25\_20M\_QPSK\_1\_0\_Left Cheek\_Ch26140

Communication System: LTE; Frequency: 1860 MHz; Duty Cycle: 1:1  
Medium: HSL\_1900\_180328 Medium parameters used:  $f = 1860$  MHz;  $\sigma = 1.405$  S/m;  $\epsilon_r = 41.255$ ;  
 $\rho = 1000$  kg/m<sup>3</sup>  
Ambient Temperature : 23.3 °C; Liquid Temperature : 22.3 °C

#### DASY5 Configuration:

- Probe: EX3DV4 - SN3925; ConvF(8.73, 8.73, 8.73); Calibrated: 2017/5/24;
- Sensor-Surface: 1.4mm (Mechanical Surface Detection)
- Electronics: DAE4 Sn1424; Calibrated: 2018/1/18
- Phantom: SAM\_Left; Type: QD000P40CD; Serial: TP:1431
- Measurement SW: DASY52, Version 52.8 (8); SEMCAD X Version 14.6.10 (7373)

**Area Scan (61x121x1):** Interpolated grid: dx=1.500 mm, dy=1.500 mm  
Maximum value of SAR (interpolated) = 0.971 W/kg

**Zoom Scan (5x5x7)/Cube 0:** Measurement grid: dx=8mm, dy=8mm, dz=5mm  
Reference Value = 12.85 V/m; Power Drift = 0.06 dB  
Peak SAR (extrapolated) = 1.12 W/kg  
**SAR(1 g) = 0.681 W/kg; SAR(10 g) = 0.365 W/kg**  
Maximum value of SAR (measured) = 0.972 W/kg

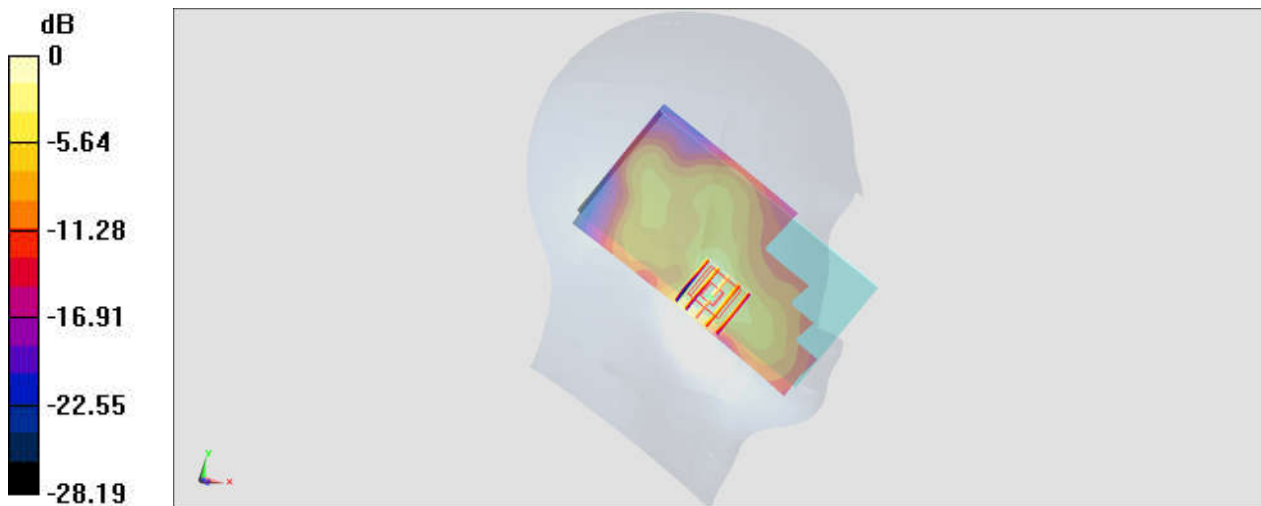

0 dB = 0.972 W/kg = -0.12 dBW/kg

## #12\_LTE Band 26\_15M\_QPSK\_1\_0\_Right Cheek\_Ch26865

Communication System: LTE; Frequency: 831.5 MHz; Duty Cycle: 1:1

Medium: HSL\_850\_180320 Medium parameters used:  $f = 831.5$  MHz;  $\sigma = 0.884$  S/m;  $\epsilon_r = 42.913$ ;

$\rho = 1000$  kg/m<sup>3</sup>

Ambient Temperature : 23.2 °C ; Liquid Temperature : 22.2 °C

DASY5 Configuration:

- Probe: ES3DV3 - SN3270; ConvF(6.18, 6.18, 6.18); Calibrated: 2017/9/25;
- Sensor-Surface: 3mm (Mechanical Surface Detection)
- Electronics: DAE4 Sn778; Calibrated: 2017/5/22
- Phantom: SAM-Right; Type: SAM; Serial: TP-1503
- Measurement SW: DASY52, Version 52.8 (8); SEMCAD X Version 14.6.10 (7373)

**Area Scan (61x121x1):** Interpolated grid: dx=1.500 mm, dy=1.500 mm

Maximum value of SAR (interpolated) = 0.130 W/kg

**Zoom Scan (5x5x7)/Cube 0:** Measurement grid: dx=8mm, dy=8mm, dz=5mm

Reference Value = 5.297 V/m; Power Drift = 0.19 dB

Peak SAR (extrapolated) = 0.147 W/kg

**SAR(1 g) = 0.119 W/kg; SAR(10 g) = 0.092 W/kg**

Maximum value of SAR (measured) = 0.127 W/kg

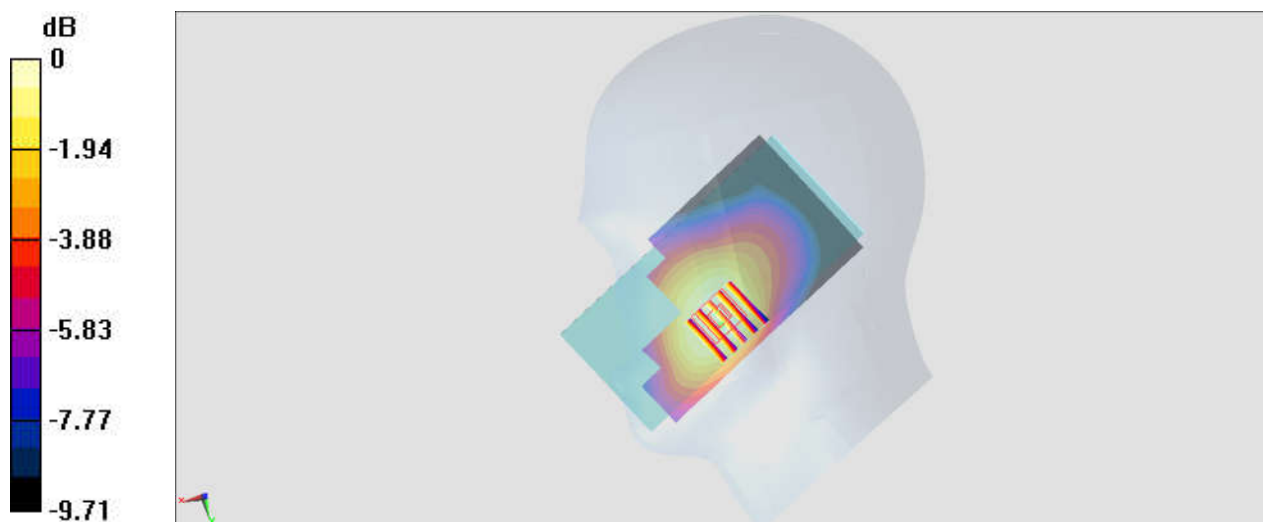

0 dB = 0.127 W/kg = -8.96 dBW/kg

**#13\_LTE Band 66\_20M\_QPSK\_1\_0\_Left Cheek\_Ch132572**

Communication System: LTE; Frequency: 1770 MHz; Duty Cycle: 1:1

Medium: HSL\_1750\_180323 Medium parameters used:  $f = 1770$  MHz;  $\sigma = 1.39$  S/m;  $\epsilon_r = 41.248$ ;  $\rho = 1000$  kg/m<sup>3</sup>

Ambient Temperature : 23.6 °C ; Liquid Temperature : 22.6 °C

**DASY5 Configuration**

- Probe: EX3DV4 - SN3931; ConvF(8.8, 8.8, 8.8); Calibrated: 2017/9/29;
- Sensor-Surface: 1.4mm (Mechanical Surface Detection)
- Electronics: DAE4 Sn1399; Calibrated: 2017/11/16
- Phantom: SAM\_Right; Type: QD000P40CD; Serial: S/N:1796
- Measurement SW: DASY52, Version 52.8 (8); SEMCAD X Version 14.6.10 (7373)

**Area Scan (71x131x1):** Interpolated grid: dx=1.500 mm, dy=1.500 mm

Maximum value of SAR (interpolated) = 0.976 W/kg

**Zoom Scan (5x5x7)/Cube 0:** Measurement grid: dx=8mm, dy=8mm, dz=5mm

Reference Value = 10.99 V/m; Power Drift = 0.11 dB

Peak SAR (extrapolated) = 1.14 W/kg

**SAR(1 g) = 0.695 W/kg; SAR(10 g) = 0.379 W/kg**

Maximum value of SAR (measured) = 0.984 W/kg

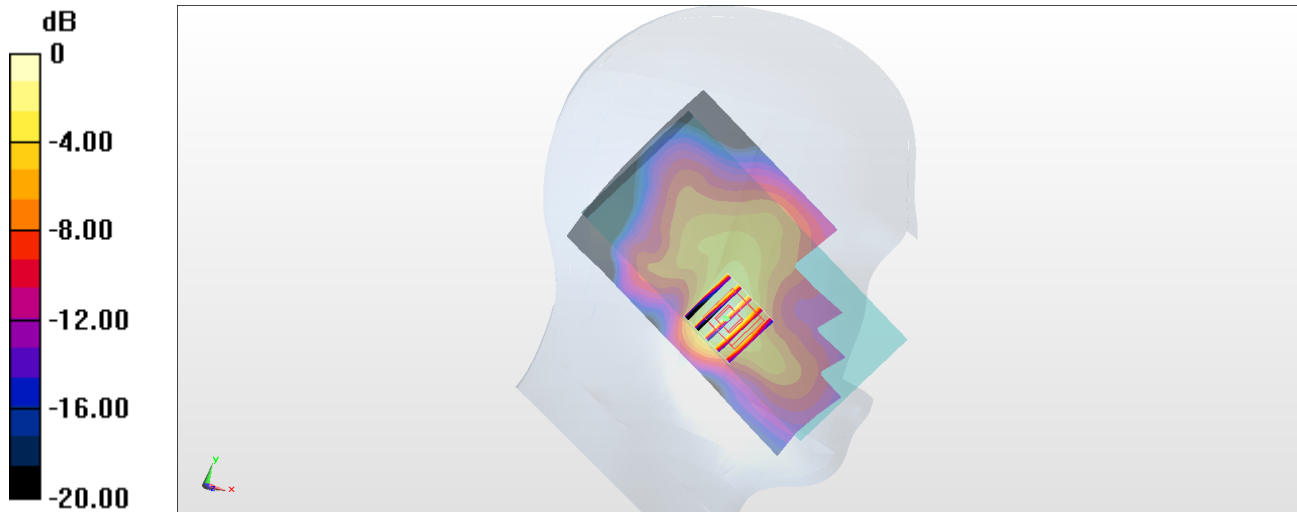

0 dB = 0.984 W/kg = -0.07 dBW/kg

## #14\_Bluetooth\_1Mbps\_Left Cheek\_Ch39

Communication System: Bluetooth; Frequency: 2441 MHz; Duty Cycle: 1:1.297

Medium: HSL\_2450\_180323 Medium parameters used :  $f = 2441$  MHz;  $\sigma = 1.742$  S/m;  $\epsilon_r = 38.699$ ;  $\rho = 1000$  kg/m<sup>3</sup>

Ambient Temperature : 23.6 °C ; Liquid Temperature : 22.6 °C

### DASY5 Configuration

- Probe: EX3DV4 - SN3931; ConvF(7.62, 7.62, 7.62); Calibrated: 2017/9/29;
- Sensor-Surface: 1.4mm (Mechanical Surface Detection)
- Electronics: DAE4 Sn1399; Calibrated: 2017/11/16
- Phantom: SAM\_Right; Type: QD000P40CD; Serial: S/N:1796
- Measurement SW: DASY52, Version 52.8 (8); SEMCAD X Version 14.6.10 (7373)

**Area Scan (91x161x1):** Interpolated grid: dx=1.200 mm, dy=1.200 mm

Maximum value of SAR (interpolated) = 0.251 W/kg

**Zoom Scan (7x7x7)/Cube 0:** Measurement grid: dx=5mm, dy=5mm, dz=5mm

Reference Value = 4.798 V/m; Power Drift = -0.03 dB

Peak SAR (extrapolated) = 0.313 W/kg

**SAR(1 g) = 0.155 W/kg; SAR(10 g) = 0.069 W/kg**

Maximum value of SAR (measured) = 0.255 W/kg

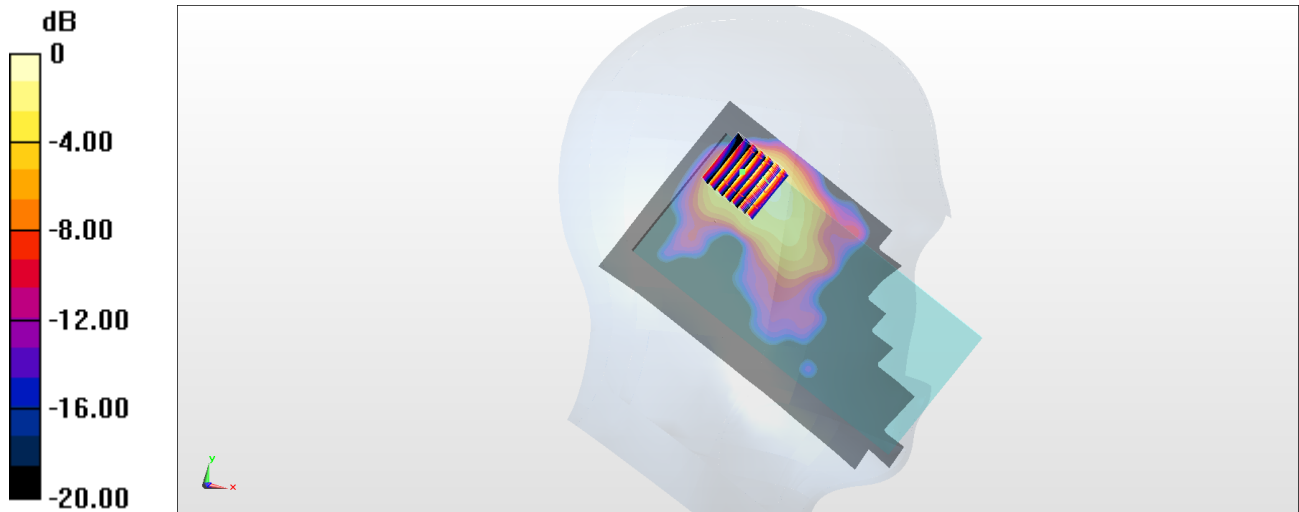

0 dB = 0.255 W/kg = -5.93 dBW/kg

### #15\_WLAN2.4GHz\_802.11b 1Mbps\_Left Cheek\_Ch6

Communication System: 802.11b; Frequency: 2437 MHz; Duty Cycle: 1:1.010  
Medium: HSL\_2450\_180328 Medium parameters used:  $f = 2437$  MHz;  $\sigma = 1.816$  S/m;  $\epsilon_r = 39.11$ ;  $\rho = 1000$  kg/m<sup>3</sup>  
Ambient Temperature : 23.7 °C; Liquid Temperature : 22.7 °C

#### DASY5 Configuration:

- Probe: EX3DV4 - SN3925; ConvF(7.85, 7.85, 7.85); Calibrated: 2017/5/24;
- Sensor-Surface: 1.4mm (Mechanical Surface Detection)
- Electronics: DAE4 Sn1424; Calibrated: 2018/1/18
- Phantom: SAM\_Left; Type: QD000P40CD; Serial: TP:1431
- Measurement SW: DASY52, Version 52.8 (8); SEMCAD X Version 14.6.10 (7373)

**Area Scan (91x71x1):** Interpolated grid: dx=1.200 mm, dy=1.200 mm  
Maximum value of SAR (interpolated) = 1.98 W/kg

**Zoom Scan (7x7x7)/Cube 0:** Measurement grid: dx=5mm, dy=5mm, dz=5mm  
Reference Value = 12.77 V/m; Power Drift = 0.04 dB  
Peak SAR (extrapolated) = 2.47 W/kg  
**SAR(1 g) = 1.15 W/kg; SAR(10 g) = 0.530 W/kg**  
Maximum value of SAR (measured) = 1.87 W/kg

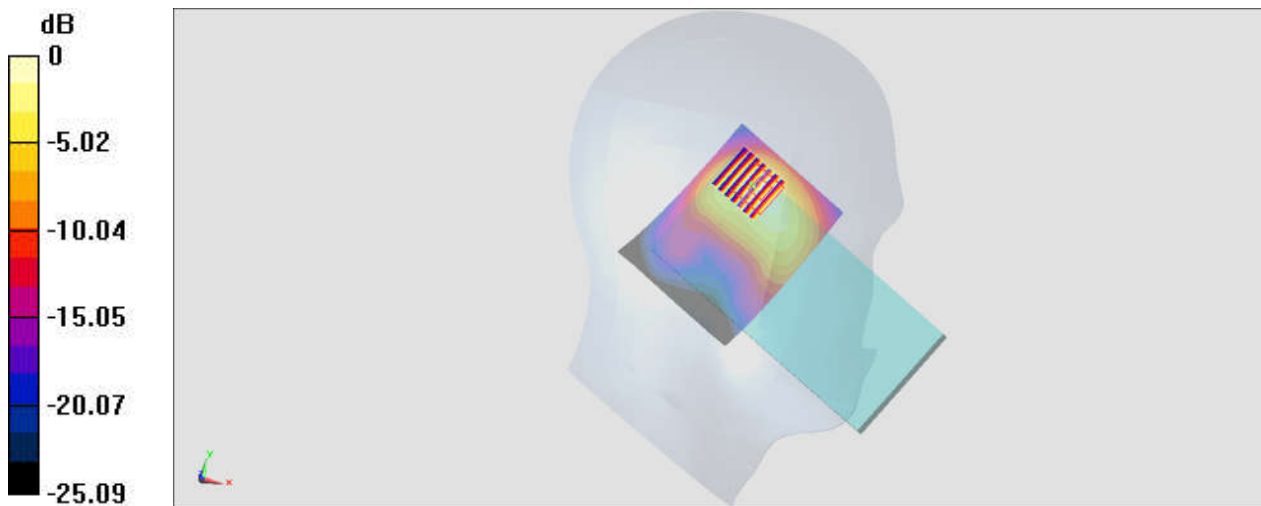

0 dB = 1.87 W/kg = 2.72 dBW/kg

**#16\_WLAN5GHz\_802.11a 6Mbps\_Left Cheek\_Ch56**

Communication System: 802.11a ; Frequency: 5280 MHz;Duty Cycle: 1:1.054

Medium: HSL\_5G\_180405 Medium parameters used:  $f = 5280$  MHz;  $\sigma = 4.656$  S/m;  $\epsilon_r = 36.658$ ;  $\rho = 1000$  kg/m<sup>3</sup>

Ambient Temperature : 23.6 °C ; Liquid Temperature : 22.6 °C

DASY5 Configuration:

- Probe: EX3DV4 - SN3925; ConvF(5.36, 5.36, 5.36); Calibrated: 2017/5/24;
- Sensor-Surface: 1.4mm (Mechanical Surface Detection)
- Electronics: DAE4 Sn1424; Calibrated: 2018/1/18
- Phantom: SAM\_Left; Type: QD000P40CD; Serial: TP:1477
- Measurement SW: DASY52, Version 52.8 (8);SEMCAD X Version 14.6.10 (7373)

**Area Scan (101x181x1):** Interpolated grid: dx=1.000 mm, dy=1.000 mm

Maximum value of SAR (interpolated) = 1.80 W/kg

**Zoom Scan (7x7x7)/Cube 0:** Measurement grid: dx=4mm, dy=4mm, dz=1.4mm

Reference Value = 17.85 V/m; Power Drift = -0.06 dB

Peak SAR (extrapolated) = 3.60 W/kg

**SAR(1 g) = 0.721 W/kg; SAR(10 g) = 0.229 W/kg**

Maximum value of SAR (measured) = 2.02 W/kg

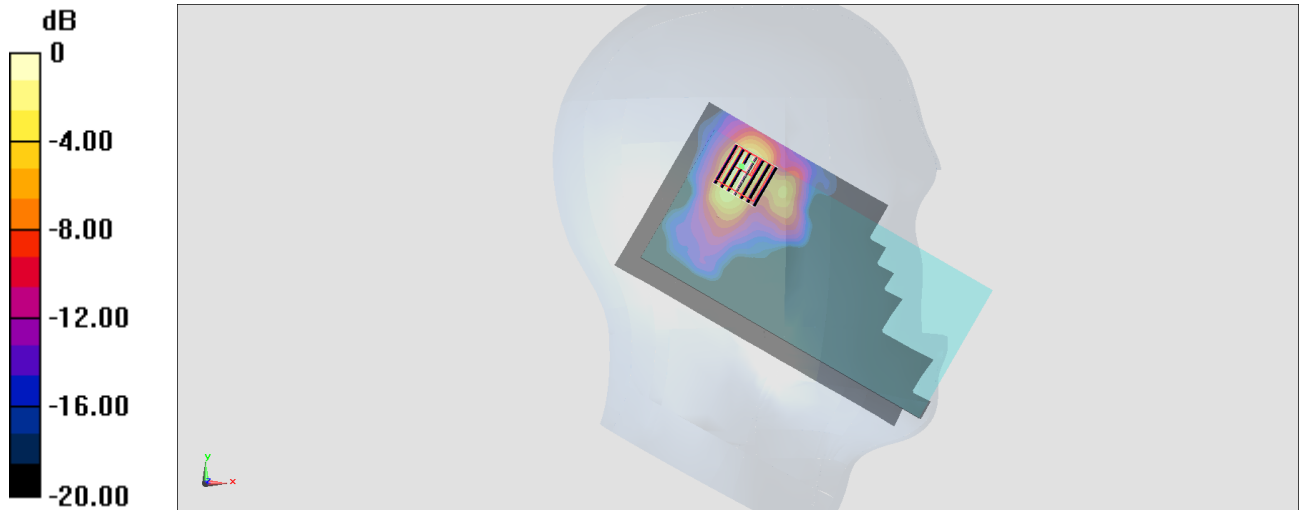

0 dB = 2.02 W/kg = 3.05 dBW/kg



## #17\_WLAN5GHz\_802.11a 6Mbps\_Left Cheek\_Ch116

Communication System: 802.11a; Frequency: 5580 MHz; Duty Cycle: 1:1.052

Medium: HSL\_5G\_180316 Medium parameters used:  $f = 5580$  MHz;  $\sigma = 4.965$  S/m;  $\epsilon_r = 36.246$ ;  $\rho = 1000$  kg/m<sup>3</sup>

Ambient Temperature : 23.6 °C ; Liquid Temperature : 22.6 °C

DASY5 Configuration:

- Probe: EX3DV4 - SN3925; ConvF(4.72, 4.72, 4.72); Calibrated: 2017/5/24;
- Sensor-Surface: 1.4mm (Mechanical Surface Detection)
- Electronics: DAE4 Sn1424; Calibrated: 2018/1/18
- Phantom: SAM\_Left; Type: QD000P40CD; Serial: TP:1477
- Measurement SW: DASY52, Version 52.8 (8); SEMCAD X Version 14.6.10 (7373)

**Area Scan (101x181x1):** Interpolated grid: dx=1.000 mm, dy=1.000 mm

Maximum value of SAR (interpolated) = 1.17 W/kg

**Zoom Scan (7x7x7)/Cube 0:** Measurement grid: dx=4mm, dy=4mm, dz=1.4mm

Reference Value = 11.18 V/m; Power Drift = 0.05 dB

Peak SAR (extrapolated) = 1.68 W/kg

**SAR(1 g) = 0.414 W/kg; SAR(10 g) = 0.116 W/kg**

Maximum value of SAR (measured) = 1.06 W/kg

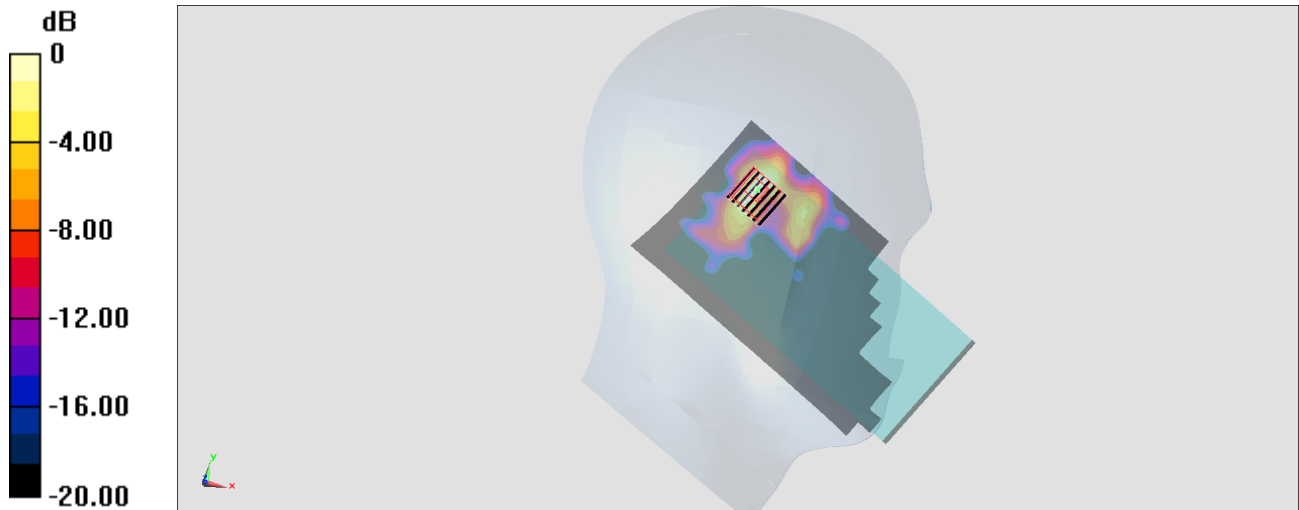

0 dB = 1.06 W/kg = 0.25 dBW/kg

**#18\_WLAN5GHz\_802.11a 6Mbps\_Left Cheek\_Ch149**

Communication System: 802.11a ; Frequency: 5745 MHz; Duty Cycle: 1:1.054

Medium: HSL\_5G\_180316 Medium parameters used:  $f = 5745$  MHz;  $\sigma = 5.135$  S/m;  $\epsilon_r = 36.013$ ;  $\rho = 1000$  kg/m<sup>3</sup>

Ambient Temperature : 23.6 °C ; Liquid Temperature : 22.6 °C

DASY5 Configuration:

- Probe: EX3DV4 - SN3925; ConvF(4.87, 4.87, 4.87); Calibrated: 2017/5/24;
- Sensor-Surface: 1.4mm (Mechanical Surface Detection)
- Electronics: DAE4 Sn1424; Calibrated: 2018/1/18
- Phantom: SAM\_Left; Type: QD000P40CD; Serial: TP:1477
- Measurement SW: DASY52, Version 52.8 (8); SEMCAD X Version 14.6.10 (7373)

**Area Scan (101x181x1):** Interpolated grid: dx=1.000 mm, dy=1.000 mm

Maximum value of SAR (interpolated) = 1.32 W/kg

**Zoom Scan (7x7x7)/Cube 0:** Measurement grid: dx=4mm, dy=4mm, dz=1.4mm

Reference Value = 16.09 V/m; Power Drift = 0.16 dB

Peak SAR (extrapolated) = 2.28 W/kg

**SAR(1 g) = 0.511 W/kg; SAR(10 g) = 0.150 W/kg**

Maximum value of SAR (measured) = 1.37 W/kg

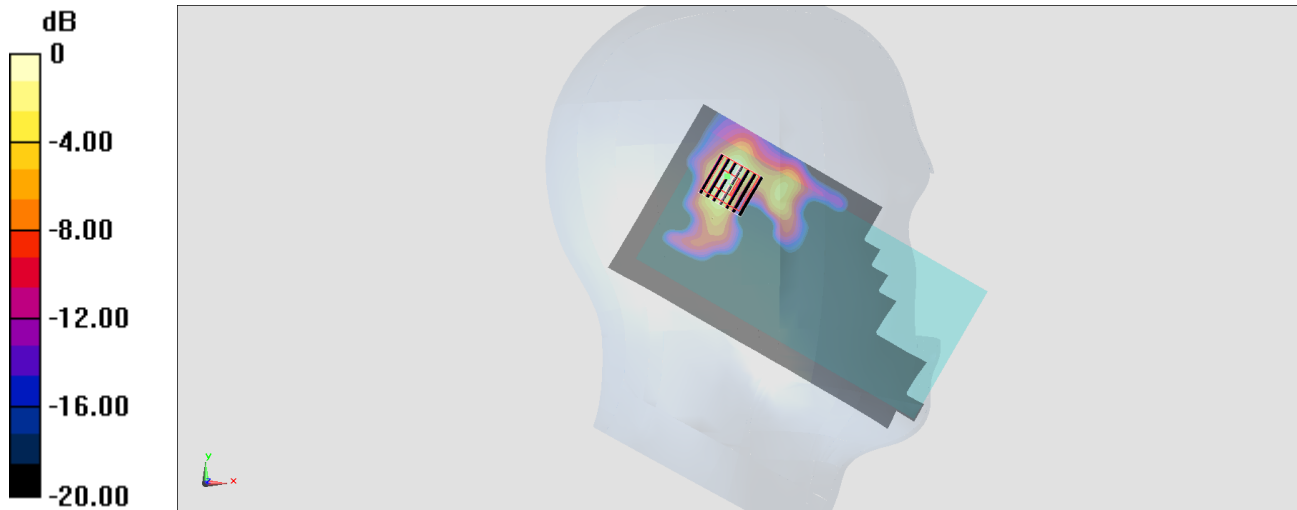

0 dB = 1.37 W/kg = 1.37 dBW/kg

## #19\_GSM850\_GPRS (4 Tx slots)\_Back\_10mm\_Ch128

Communication System: GSM850 ; Frequency: 824.2 MHz; Duty Cycle: 1:2.08

Medium: MSL\_850\_180320 Medium parameters used :  $f = 824.2$  MHz;  $\sigma = 0.954$  S/m;  $\epsilon_r = 56.908$ ;  $\rho = 1000$  kg/m<sup>3</sup>

Ambient Temperature : 23.6 °C ; Liquid Temperature : 22.6 °C

### DASY5 Configuration

- Probe: EX3DV4 - SN3931; ConvF(10.09, 10.09, 10.09); Calibrated: 2017/9/29;
- Sensor-Surface: 1.4mm (Mechanical Surface Detection)
- Electronics: DAE4 Sn1399; Calibrated: 2017/11/16
- Phantom: SAM\_Right; Type: QD000P40CD; Serial: S/N:1796
- Measurement SW: DASY52, Version 52.8 (8); SEMCAD X Version 14.6.10 (7373)

**Area Scan (71x121x1):** Interpolated grid: dx=1.500 mm, dy=1.500 mm

Maximum value of SAR (interpolated) = 0.975 W/kg

**Zoom Scan (5x5x7)/Cube 0:** Measurement grid: dx=8mm, dy=8mm, dz=5mm

Reference Value = 23.33 V/m; Power Drift = -0.04 dB

Peak SAR (extrapolated) = 1.24 W/kg

**SAR(1 g) = 0.695 W/kg; SAR(10 g) = 0.396 W/kg**

Maximum value of SAR (measured) = 1.04 W/kg

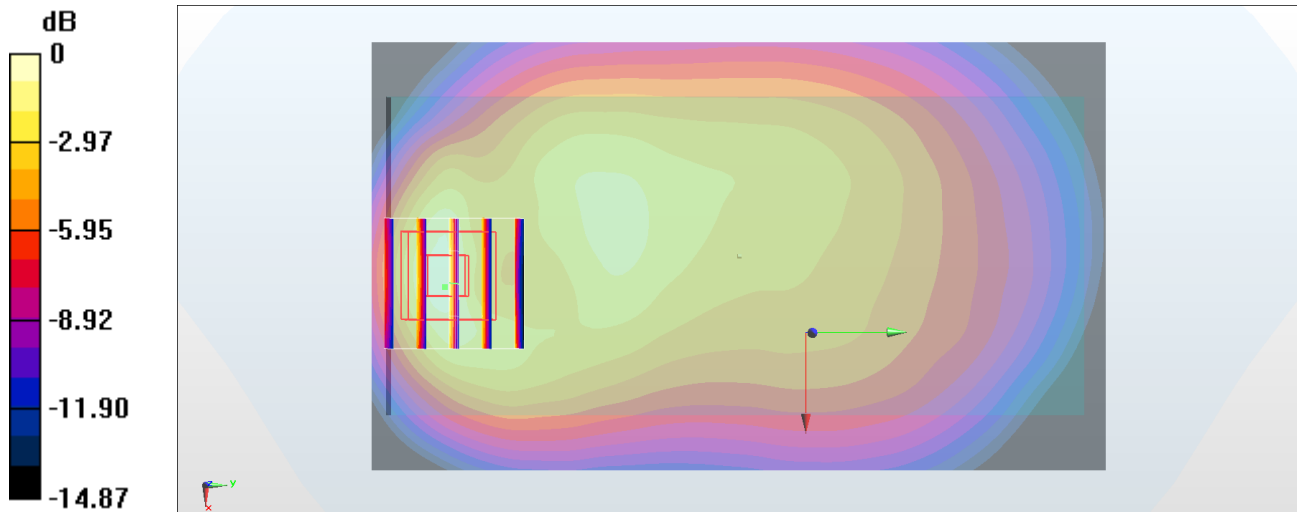

## #20\_GSM1900\_GPRS (4 Tx slots)\_Back\_10mm\_Ch810

Communication System: PCS; Frequency: 1909.8 MHz; Duty Cycle: 1:2.08

Medium: MSL\_1900\_180326 Medium parameters used:  $f = 1910$  MHz;  $\sigma = 1.56$  S/m;  $\epsilon_r = 51.604$ ;  $\rho = 1000$  kg/m<sup>3</sup>

Ambient Temperature : 23.5 °C ; Liquid Temperature : 22.5 °C

### DASY5 Configuration

- Probe: EX3DV4 - SN3931; ConvF(8.12, 8.12, 8.12); Calibrated: 2017/9/29;
- Sensor-Surface: 1.4mm (Mechanical Surface Detection)
- Electronics: DAE4 Sn1399; Calibrated: 2017/11/16
- Phantom: SAM\_Left; Type: QD000P40CD; Serial: S/N:1801
- Measurement SW: DASY52, Version 52.8 (8); SEMCAD X Version 14.6.10 (7373)

**Area Scan (71x71x1):** Interpolated grid: dx=1.500 mm, dy=1.500 mm

Maximum value of SAR (interpolated) = 1.20 W/kg

**Zoom Scan (5x5x7)/Cube 0:** Measurement grid: dx=8mm, dy=8mm, dz=5mm

Reference Value = 7.133 V/m; Power Drift = 0.09 dB

Peak SAR (extrapolated) = 1.47 W/kg

**SAR(1 g) = 0.823 W/kg; SAR(10 g) = 0.420 W/kg**

Maximum value of SAR (measured) = 1.25 W/kg

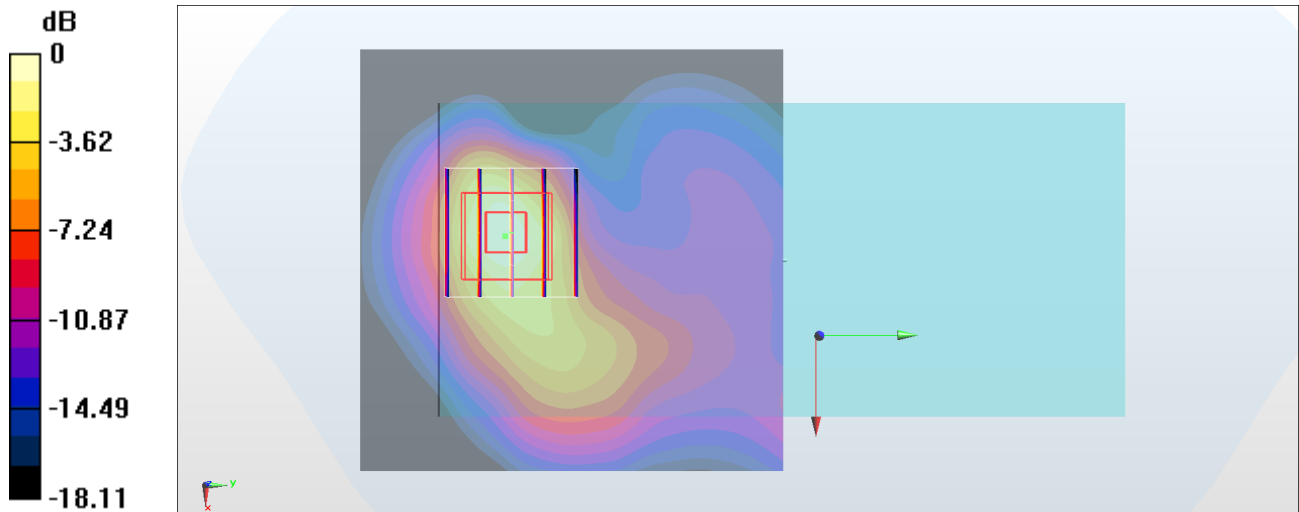

0 dB = 1.25 W/kg = 0.97 dBW/kg

**#21\_WCDMA II\_RMC 12.2Kbps\_Back\_10mm\_Ch9538**

Communication System: WCDMA; Frequency: 1907.6 MHz; Duty Cycle: 1:1

Medium: MSL\_1900\_180326 Medium parameters used:  $f = 1908$  MHz;  $\sigma = 1.557$  S/m;  $\epsilon_r = 51.612$ ;  $\rho = 1000$  kg/m<sup>3</sup>

Ambient Temperature : 23.5 °C ; Liquid Temperature : 22.5 °C

**DASY5 Configuration**

- Probe: EX3DV4 - SN3931; ConvF(8.12, 8.12, 8.12); Calibrated: 2017/9/29;
- Sensor-Surface: 1.4mm (Mechanical Surface Detection)
- Electronics: DAE4 Sn1399; Calibrated: 2017/11/16
- Phantom: SAM\_Left; Type: QD000P40CD; Serial: S/N:1801
- Measurement SW: DASY52, Version 52.8 (8); SEMCAD X Version 14.6.10 (7373)

**Area Scan (71x71x1):** Interpolated grid: dx=1.500 mm, dy=1.500 mm

Maximum value of SAR (interpolated) = 1.43 W/kg

**Zoom Scan (5x5x7)/Cube 0:** Measurement grid: dx=8mm, dy=8mm, dz=5mm

Reference Value = 29.23 V/m; Power Drift = -0.09 dB

Peak SAR (extrapolated) = 1.70 W/kg

**SAR(1 g) = 0.948 W/kg; SAR(10 g) = 0.485 W/kg**

Maximum value of SAR (measured) = 1.44 W/kg

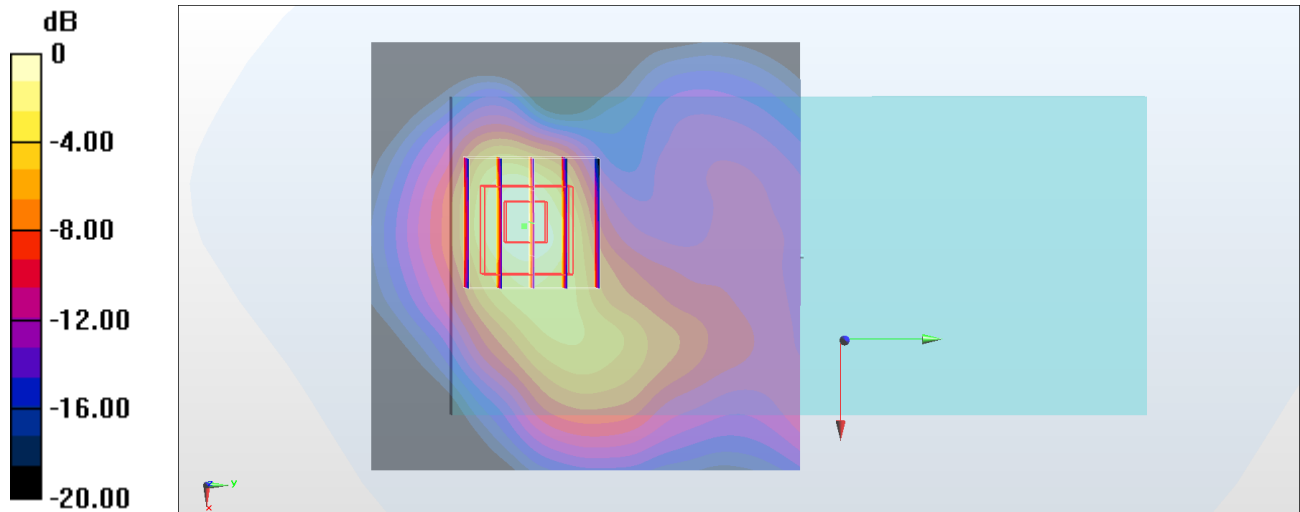

0 dB = 1.44 W/kg = 1.58 dBW/kg

**#22\_WCDMA IV\_RMC 12.2Kbps\_Back\_10mm\_Ch1312**

Communication System: WCDMA ; Frequency: 1712.4 MHz;Duty Cycle: 1:1  
Medium: MSL\_1750\_180322 Medium parameters used :  $f = 1712.4$  MHz;  $\sigma = 1.445$  S/m;  $\epsilon_r = 54.911$ ;  $\rho = 1000$  kg/m<sup>3</sup>  
Ambient Temperature : 23.2 °C ; Liquid Temperature : 22.2 °C

**DASY5 Configuration**

- Probe: EX3DV4 - SN3931; ConvF(8.43, 8.43, 8.43); Calibrated: 2017/9/29;
- Sensor-Surface: 1.4mm (Mechanical Surface Detection)
- Electronics: DAE4 Sn1399; Calibrated: 2017/11/16
- Phantom: SAM\_Left; Type: QD000P40CD; Serial: S/N:1801
- Measurement SW: DASY52, Version 52.8 (8); SEMCAD X Version 14.6.10 (7373)

**Area Scan (71x121x1):** Interpolated grid: dx=1.500 mm, dy=1.500 mm  
Maximum value of SAR (interpolated) = 1.49 W/kg

**Zoom Scan (5x5x7)/Cube 0:** Measurement grid: dx=8mm, dy=8mm, dz=5mm  
Reference Value = 6.429 V/m; Power Drift = -0.04 dB  
Peak SAR (extrapolated) = 1.83 W/kg  
**SAR(1 g) = 1.11 W/kg; SAR(10 g) = 0.624 W/kg**  
Maximum value of SAR (measured) = 1.59 W/kg

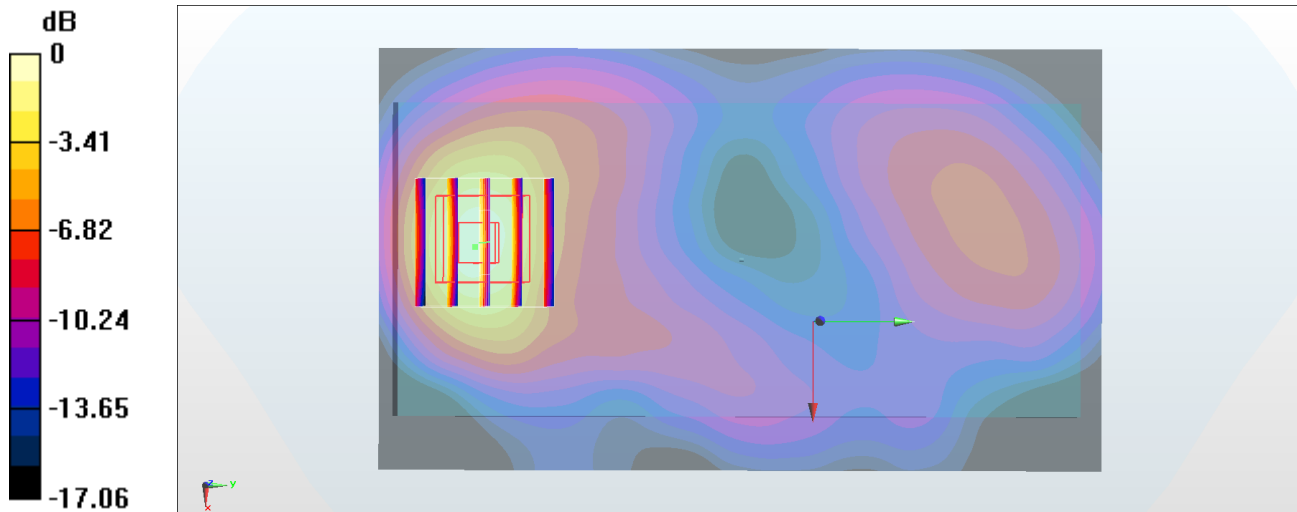

0 dB = 1.59 W/kg = 2.01 dBW/kg

### #23\_WCDMA V\_RMC 12.2Kbps\_Back\_10mm\_Ch4233

Communication System: WCDMA; Frequency: 846.6 MHz; Duty Cycle: 1:1  
Medium: MSL\_850\_180318 Medium parameters used:  $f = 847$  MHz;  $\sigma = 0.989$  S/m;  $\epsilon_r = 55.781$ ;  $\rho = 1000$  kg/m<sup>3</sup>  
Ambient Temperature : 23.2 °C ; Liquid Temperature : 22.2 °C

#### DASY5 Configuration:

- Probe: ES3DV3 - SN3270; ConvF(6.09, 6.09, 6.09); Calibrated: 2017/9/25;
- Sensor-Surface: 3mm (Mechanical Surface Detection)
- Electronics: DAE4 Sn778; Calibrated: 2017/5/22
- Phantom: SAM\_Left; Type: QD000P40CD; Serial: TP:1431
- Measurement SW: DASY52, Version 52.8 (8); SEMCAD X Version 14.6.10 (7373)

**Area Scan (61x121x1):** Interpolated grid: dx=1.500 mm, dy=1.500 mm  
Maximum value of SAR (interpolated) = 0.997 W/kg

**Zoom Scan (5x5x7)/Cube 0:** Measurement grid: dx=8mm, dy=8mm, dz=5mm  
Reference Value = 21.27 V/m; Power Drift = 0.02 dB  
Peak SAR (extrapolated) = 1.40 W/kg  
**SAR(1 g) = 0.831 W/kg; SAR(10 g) = 0.464 W/kg**  
Maximum value of SAR (measured) = 1.02 W/kg

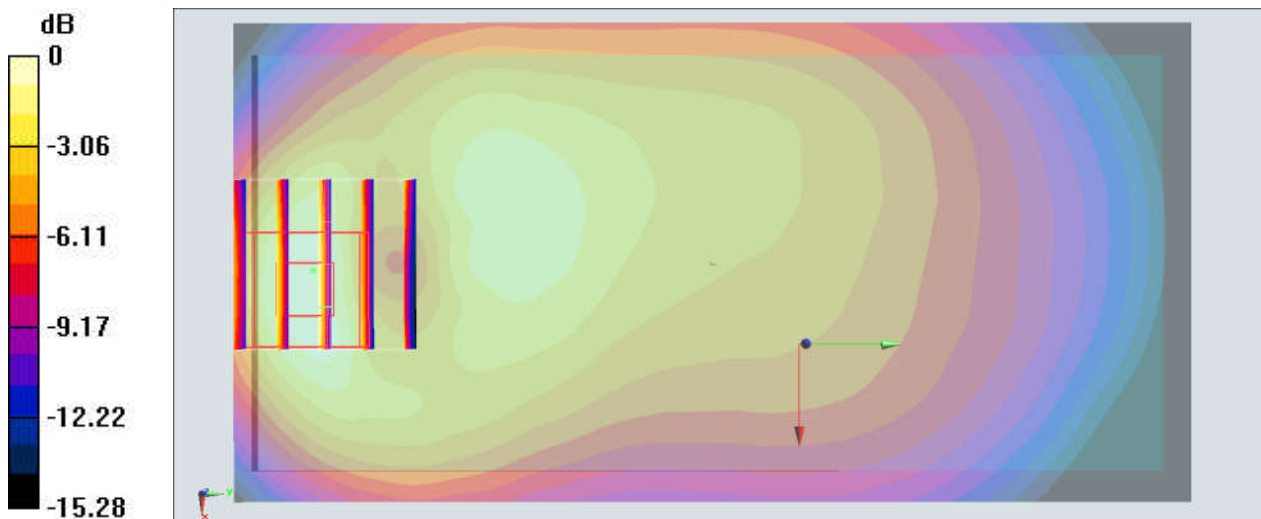

0 dB = 1.02 W/kg = 0.09 dBW/kg

### #24\_LTE Band 4\_20M\_QPSK\_1\_0\_Back\_10mm\_Ch20175

Communication System: LTE ; Frequency: 1732.5 MHz;Duty Cycle: 1:1  
Medium: MSL1750\_180320 Medium parameters used :  $f = 1732.5$  MHz;  $\sigma = 1.449$  S/m;  $\epsilon_r = 55.773$ ;  $\rho = 1000$  kg/m<sup>3</sup>  
Ambient Temperature : 23.5 °C ; Liquid Temperature : 22.5 °C

#### DASY5 Configuration:

- Probe: ES3DV3 - SN3270; ConvF(5, 5, 5); Calibrated: 2017/9/25;
- Sensor-Surface: 3mm (Mechanical Surface Detection)
- Electronics: DAE4 Sn778; Calibrated: 2017/5/22
- Phantom: SAM-Right; Type: SAM; Serial: TP-1503
- Measurement SW: DASY52, Version 52.8 (8);SEMCAD X Version 14.6.10 (7373)

**Area Scan (61x131x1):** Interpolated grid: dx=1.500 mm, dy=1.500 mm  
Maximum value of SAR (interpolated) = 1.37 W/kg

**Zoom Scan (5x5x7)/Cube 0:** Measurement grid: dx=8mm, dy=8mm, dz=5mm  
Reference Value = 6.133 V/m; Power Drift = -0.11 dB  
Peak SAR (extrapolated) = 1.82 W/kg  
**SAR(1 g) = 1.1 W/kg; SAR(10 g) = 0.612 W/kg**  
Maximum value of SAR (measured) = 1.36 W/kg

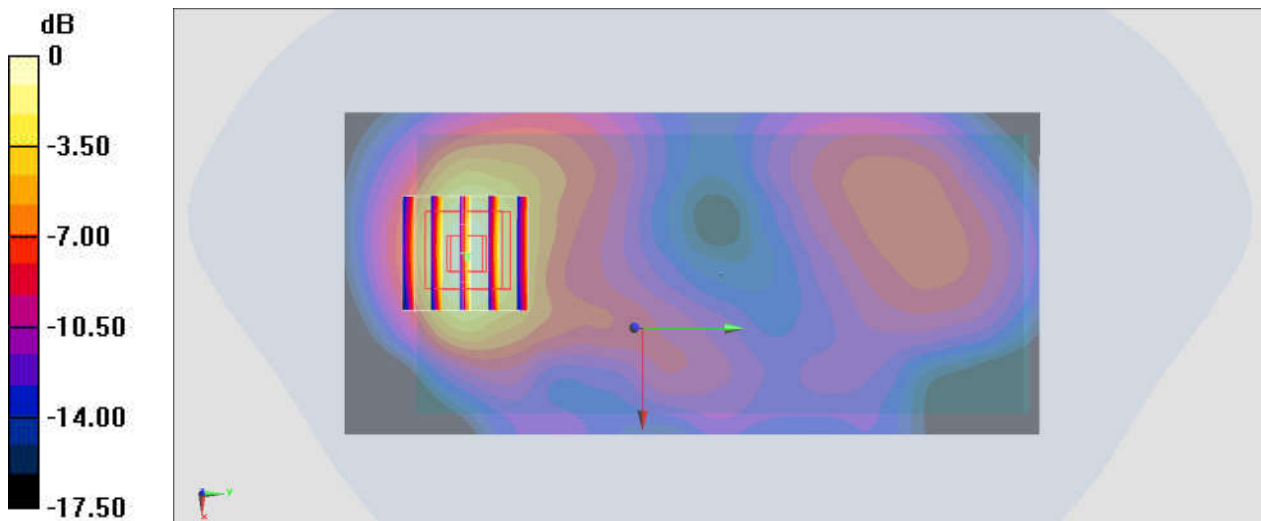

0 dB = 1.36 W/kg = 1.34 dBW/kg



### #25\_LTE Band 5\_10M\_QPSK\_1\_0\_Back\_10mm\_Ch20525

Communication System: LTE; Frequency: 836.5 MHz; Duty Cycle: 1:1  
Medium: MSL\_850\_180318 Medium parameters used:  $f = 836.5$  MHz;  $\sigma = 0.979$  S/m;  $\epsilon_r = 55.883$ ;  
 $\rho = 1000$  kg/m<sup>3</sup>  
Ambient Temperature : 23.3 °C ; Liquid Temperature : 22.3 °C

#### DASY5 Configuration:

- Probe: ES3DV3 - SN3270; ConvF(6.09, 6.09, 6.09); Calibrated: 2017/9/25;
- Sensor-Surface: 3mm (Mechanical Surface Detection)
- Electronics: DAE4 Sn778; Calibrated: 2017/5/22
- Phantom: SAM\_Left; Type: QD000P40CD; Serial: TP:1431
- Measurement SW: DASY52, Version 52.8 (8); SEMCAD X Version 14.6.10 (7373)

**Area Scan (61x121x1):** Interpolated grid: dx=1.500 mm, dy=1.500 mm  
Maximum value of SAR (interpolated) = 0.694 W/kg

**Zoom Scan (5x5x7)/Cube 0:** Measurement grid: dx=8mm, dy=8mm, dz=5mm  
Reference Value = 17.49 V/m; Power Drift = 0.04 dB  
Peak SAR (extrapolated) = 1.13 W/kg  
**SAR(1 g) = 0.670 W/kg; SAR(10 g) = 0.378 W/kg**  
Maximum value of SAR (measured) = 0.833 W/kg

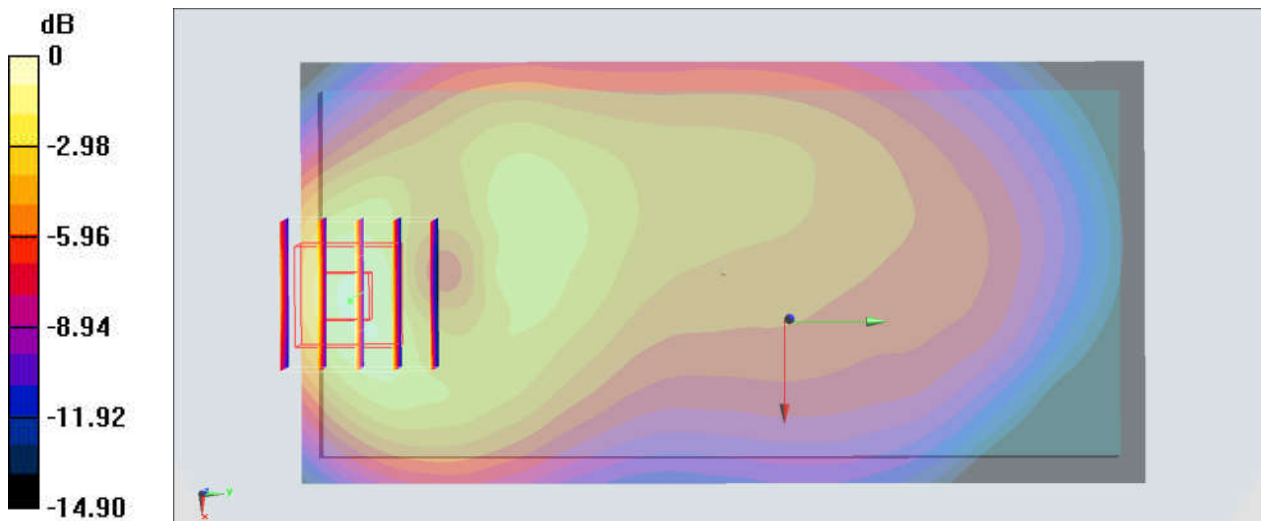

0 dB = 0.833 W/kg = -0.79 dBW/kg

**#26\_LTE Band 7\_20M\_QPSK\_1\_49\_Bottom Side\_10mm\_Ch21350**

Communication System: LTE ; Frequency: 2560 MHz;Duty Cycle: 1:1

Medium: MSL\_2600\_180322 Medium parameters used:  $f = 2560$  MHz;  $\sigma = 2.166$  S/m;  $\epsilon_r = 52.843$ ;  $\rho = 1000$  kg/m<sup>3</sup>

Ambient Temperature : 23.6 °C ; Liquid Temperature : 22.6 °C

**DASY5 Configuration**

- Probe: EX3DV4 - SN3931; ConvF(7.45, 7.45, 7.45); Calibrated: 2017/9/29;
- Sensor-Surface: 1.4mm (Mechanical Surface Detection)
- Electronics: DAE4 Sn1399; Calibrated: 2017/11/16
- Phantom: SAM\_Right; Type: QD000P40CD; Serial: S/N:1796
- Measurement SW: DASY52, Version 52.8 (8); SEMCAD X Version 14.6.10 (7373)

**Area Scan (51x91x1):** Interpolated grid: dx=1.200 mm, dy=1.200 mm

Maximum value of SAR (interpolated) = 1.87 W/kg

**Zoom Scan (7x7x7)/Cube 0:** Measurement grid: dx=5mm, dy=5mm, dz=5mm

Reference Value = 25.37 V/m; Power Drift = -0.02 dB

Peak SAR (extrapolated) = 2.26 W/kg

**SAR(1 g) = 1.13 W/kg; SAR(10 g) = 0.557 W/kg**

Maximum value of SAR (measured) = 1.82 W/kg

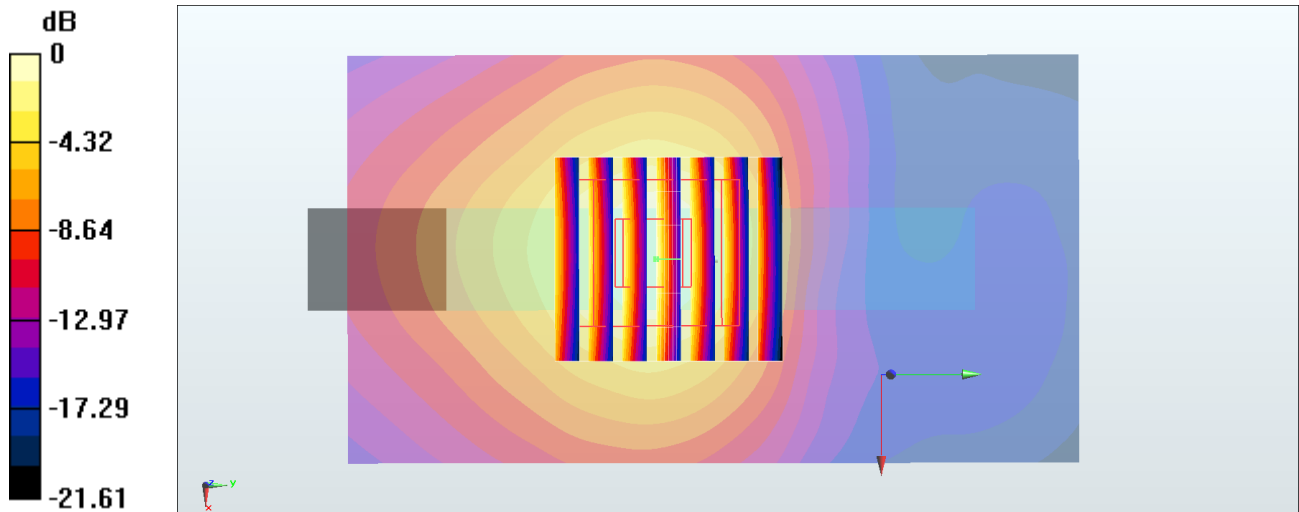

0 dB = 1.82 W/kg = 2.60 dBW/kg

### #27\_LTE Band 12\_10M\_QPSK\_25\_0\_Back\_10mm\_Ch23095

Communication System: LTE; Frequency: 707.5 MHz; Duty Cycle: 1:1  
Medium: MSL\_750\_180318 Medium parameters used:  $f = 707.5$  MHz;  $\sigma = 0.936$  S/m;  $\epsilon_r = 54.755$ ;  
 $\rho = 1000$  kg/m<sup>3</sup>  
Ambient Temperature : 23.3 °C ; Liquid Temperature : 22.3 °C

#### DASY5 Configuration:

- Probe: ES3DV3 - SN3270; ConvF(6.31, 6.31, 6.31); Calibrated: 2017/9/25;
- Sensor-Surface: 3mm (Mechanical Surface Detection)
- Electronics: DAE4 Sn778; Calibrated: 2017/5/22
- Phantom: SAM\_Left; Type: QD000P40CD; Serial: TP:1431
- Measurement SW: DASY52, Version 52.8 (8); SEMCAD X Version 14.6.10 (7373)

**Area Scan (61x11x1):** Interpolated grid: dx=1.500 mm, dy=1.500 mm  
Maximum value of SAR (interpolated) = 0.423 W/kg

**Zoom Scan (5x5x7)/Cube 0:** Measurement grid: dx=8mm, dy=8mm, dz=5mm  
Reference Value = 18.82 V/m; Power Drift = 0.04 dB  
Peak SAR (extrapolated) = 0.600 W/kg  
**SAR(1 g) = 0.354 W/kg; SAR(10 g) = 0.216 W/kg**  
Maximum value of SAR (measured) = 0.431 W/kg

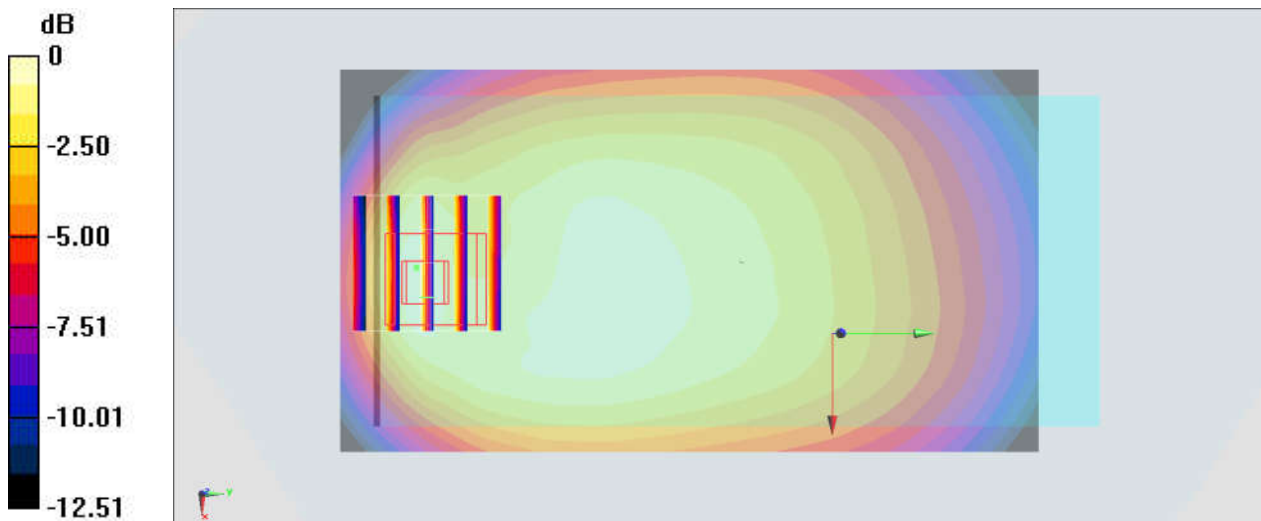

0 dB = 0.431 W/kg = -3.66 dBW/kg

### #28\_LTE Band 13\_10M\_QPSK\_1\_0\_Back\_10mm\_Ch23230

Communication System: LTE; Frequency: 782 MHz; Duty Cycle: 1:1  
Medium: MSL\_750\_180318 Medium parameters used:  $f = 782$  MHz;  $\sigma = 1.006$  S/m;  $\epsilon_r = 54.048$ ;  $\rho = 1000$  kg/m<sup>3</sup>  
Ambient Temperature : 23.3 °C; Liquid Temperature : 22.3 °C

#### DASY5 Configuration:

- Probe: ES3DV3 - SN3270; ConvF(6.31, 6.31, 6.31); Calibrated: 2017/9/25;
- Sensor-Surface: 3mm (Mechanical Surface Detection)
- Electronics: DAE4 Sn778; Calibrated: 2017/5/22
- Phantom: SAM\_Left; Type: QD000P40CD; Serial: TP:1431
- Measurement SW: DASY52, Version 52.8 (8); SEMCAD X Version 14.6.10 (7373)

**Area Scan (61x11x1):** Interpolated grid: dx=1.500 mm, dy=1.500 mm  
Maximum value of SAR (interpolated) = 0.516 W/kg

**Zoom Scan (5x5x7)/Cube 0:** Measurement grid: dx=8mm, dy=8mm, dz=5mm  
Reference Value = 19.50 V/m; Power Drift = -0.01 dB  
Peak SAR (extrapolated) = 0.746 W/kg  
**SAR(1 g) = 0.434 W/kg; SAR(10 g) = 0.249 W/kg**  
Maximum value of SAR (measured) = 0.533 W/kg

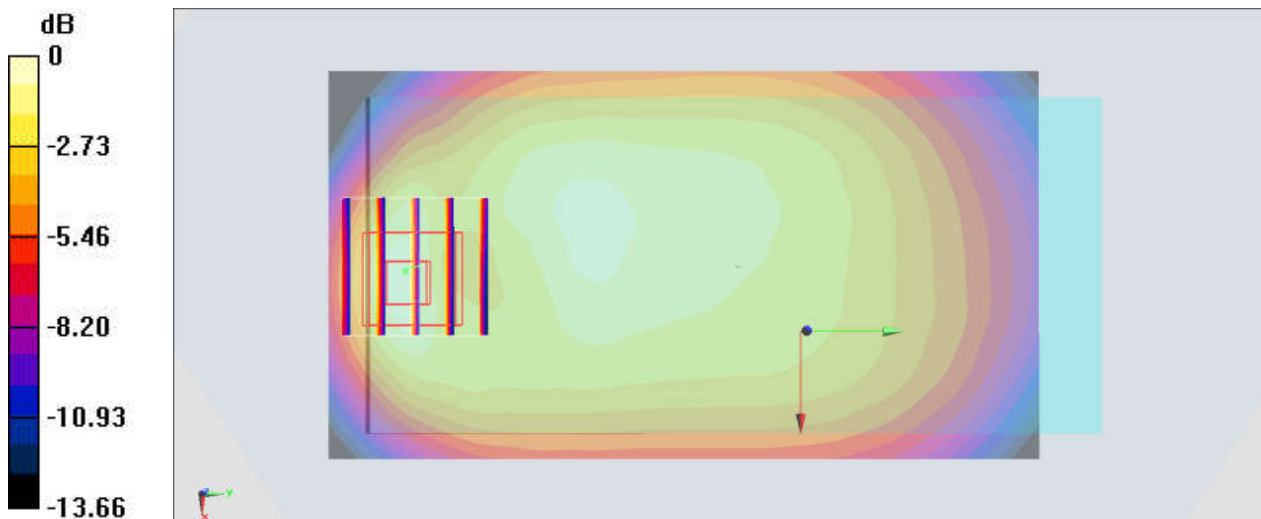

0 dB = 0.533 W/kg = -2.73 dBW/kg

**#29\_LTE Band 25\_20M\_QPSK\_1\_49\_Back\_10mm\_Ch26590**

Communication System: LTE; Frequency: 1905 MHz; Duty Cycle: 1:1

Medium: MSL\_1900\_180326 Medium parameters used:  $f = 1905$  MHz;  $\sigma = 1.555$  S/m;  $\epsilon_r = 51.625$ ;  $\rho = 1000$  kg/m<sup>3</sup>

Ambient Temperature : 23.5 °C ; Liquid Temperature : 22.5 °C

**DASY5 Configuration**

- Probe: EX3DV4 - SN3931; ConvF(8.12, 8.12, 8.12); Calibrated: 2017/9/29;
- Sensor-Surface: 1.4mm (Mechanical Surface Detection)
- Electronics: DAE4 Sn1399; Calibrated: 2017/11/16
- Phantom: SAM\_Left; Type: QD000P40CD; Serial: S/N:1801
- Measurement SW: DASY52, Version 52.8 (8); SEMCAD X Version 14.6.10 (7373)

**Area Scan (71x71x1):** Interpolated grid: dx=1.500 mm, dy=1.500 mm

Maximum value of SAR (interpolated) = 1.41 W/kg

**Zoom Scan (5x5x7)/Cube 0:** Measurement grid: dx=8mm, dy=8mm, dz=5mm

Reference Value = 7.659 V/m; Power Drift = -0.15 dB

Peak SAR (extrapolated) = 1.55 W/kg

**SAR(1 g) = 0.880 W/kg; SAR(10 g) = 0.455 W/kg**

Maximum value of SAR (measured) = 1.28 W/kg

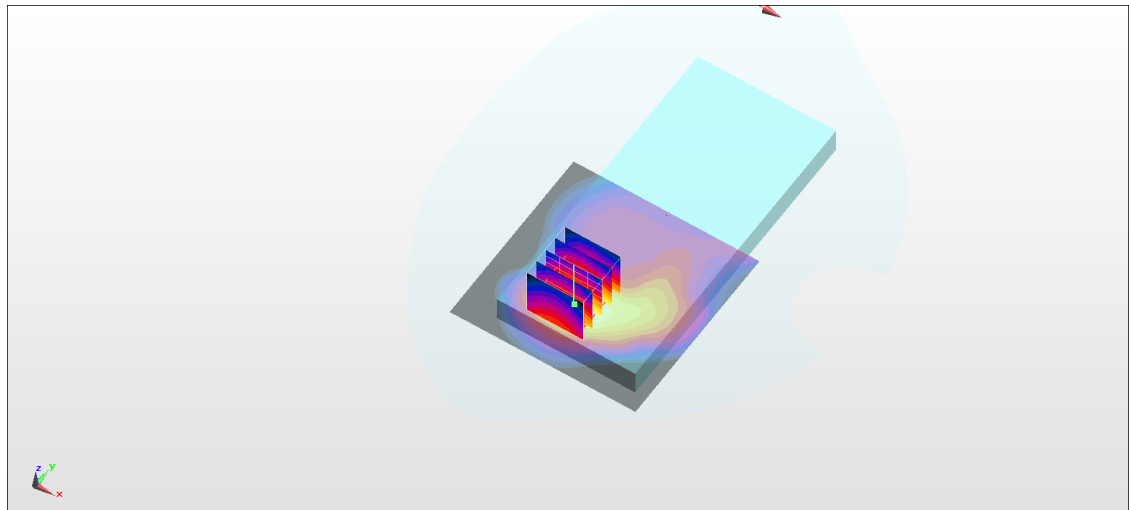
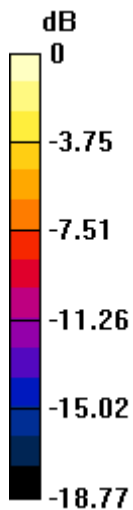

### #30\_LTE Band 26\_15M\_QPSK\_1\_0\_Back\_10mm\_Ch26865

Communication System: LTE; Frequency: 831.5 MHz; Duty Cycle: 1:1  
 Medium: MSL\_850\_180318 Medium parameters used:  $f = 831.5$  MHz;  $\sigma = 0.973$  S/m;  $\epsilon_r = 55.916$ ;  
 $\rho = 1000$  kg/m<sup>3</sup>  
 Ambient Temperature : 23.3 °C ; Liquid Temperature : 22.3 °C

**DASY5 Configuration:**

- Probe: ES3DV3 - SN3270; ConvF(6.09, 6.09, 6.09); Calibrated: 2017/9/25;
- Sensor-Surface: 3mm (Mechanical Surface Detection)
- Electronics: DAE4 Sn778; Calibrated: 2017/5/22
- Phantom: SAM\_Left; Type: QD000P40CD; Serial: TP:1431
- Measurement SW: DASY52, Version 52.8 (8); SEMCAD X Version 14.6.10 (7373)

**Area Scan (61x101x1):** Interpolated grid: dx=1.500 mm, dy=1.500 mm  
 Maximum value of SAR (interpolated) = 0.467 W/kg

**Zoom Scan (5x5x7)/Cube 0:** Measurement grid: dx=8mm, dy=8mm, dz=5mm  
 Reference Value = 14.34 V/m; Power Drift = 0.03 dB  
 Peak SAR (extrapolated) = 0.675 W/kg  
**SAR(1 g) = 0.399 W/kg; SAR(10 g) = 0.226 W/kg**  
 Maximum value of SAR (measured) = 0.482 W/kg

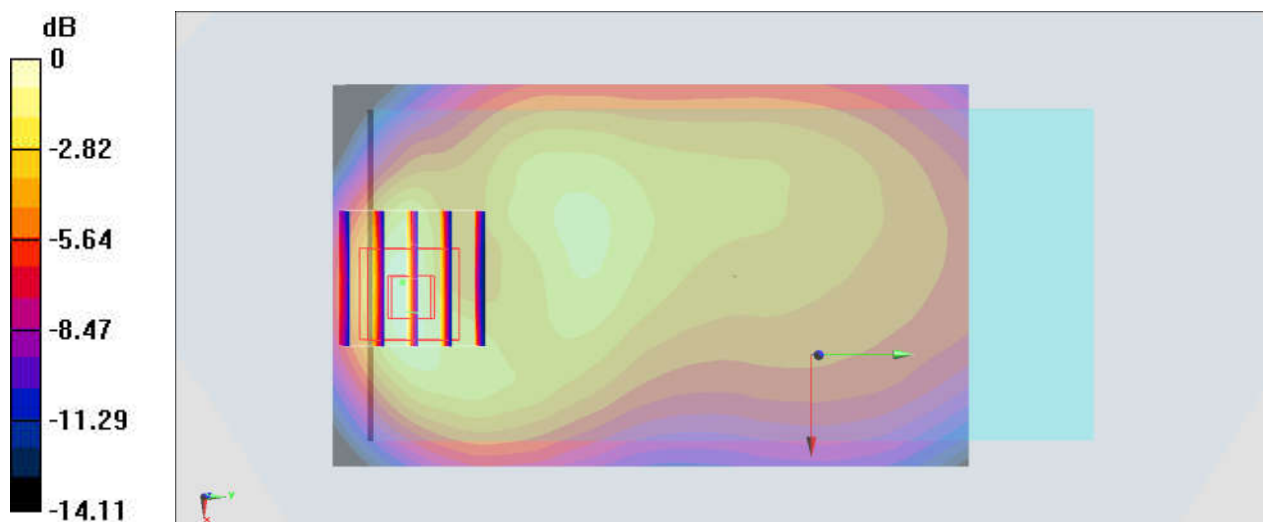

0 dB = 0.482 W/kg = -3.17 dBW/kg

### #31\_LTE Band 66\_20M\_QPSK\_1\_0\_Back\_10mm\_Ch132072

Communication System: LTE ; Frequency: 1720 MHz;Duty Cycle: 1:1

Medium: MSL1750\_180320 Medium parameters used:  $f = 1720$  MHz;  $\sigma = 1.437$  S/m;  $\epsilon_r = 55.817$ ;  $\rho = 1000$  kg/m<sup>3</sup>

Ambient Temperature : 23.5 °C ; Liquid Temperature : 22.5 °C

#### DASY5 Configuration:

- Probe: ES3DV3 - SN3270; ConvF(5, 5, 5); Calibrated: 2017/9/25;
- Sensor-Surface: 3mm (Mechanical Surface Detection)
- Electronics: DAE4 Sn778; Calibrated: 2017/5/22
- Phantom: SAM-Right; Type: SAM; Serial: TP-1503
- Measurement SW: DASY52, Version 52.8 (8);SEMCAD X Version 14.6.10 (7373)

**Area Scan (61x131x1):** Interpolated grid: dx=1.500 mm, dy=1.500 mm

Maximum value of SAR (interpolated) = 1.18 W/kg

**Zoom Scan (5x5x7)/Cube 0:** Measurement grid: dx=8mm, dy=8mm, dz=5mm

Reference Value = 5.784 V/m; Power Drift = -0.05 dB

Peak SAR (extrapolated) = 1.55 W/kg

**SAR(1 g) = 0.945 W/kg; SAR(10 g) = 0.528 W/kg**

Maximum value of SAR (measured) = 1.16 W/kg

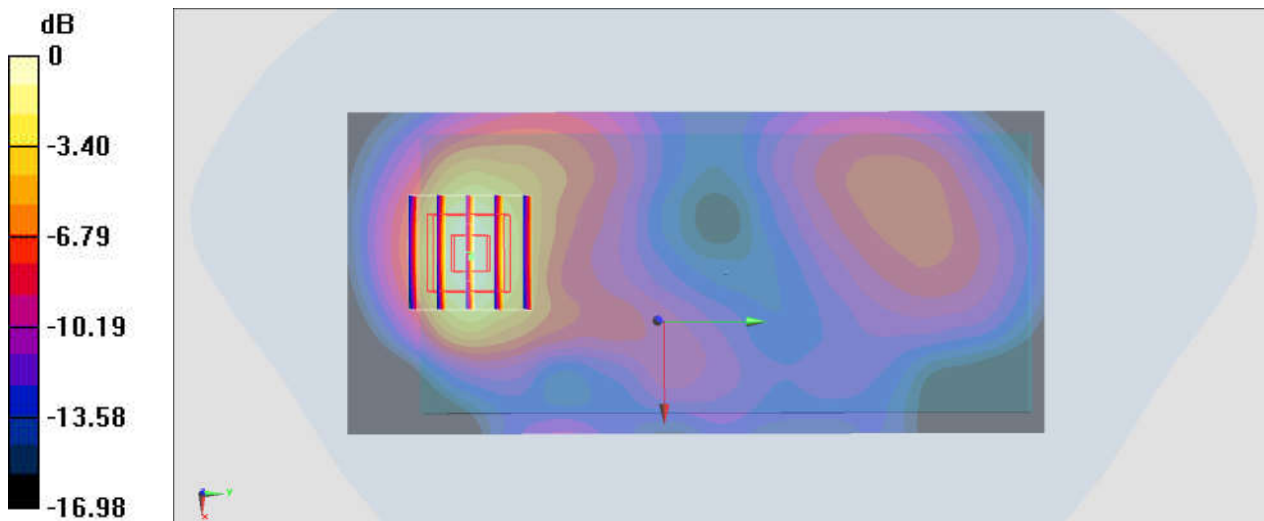

0 dB = 1.16 W/kg = 0.64 dBW/kg

### #32\_Bluetooth\_1Mbps\_Right Side\_10mm\_Ch39

Communication System: Bluetooth; Frequency: 2441 MHz; Duty Cycle: 1:1.297

Medium: MSL\_2450\_180324 Medium parameters used :  $f = 2441$  MHz;  $\sigma = 1.961$  S/m;  $\epsilon_r = 51.195$ ;  $\rho = 1000$  kg/m<sup>3</sup>

Ambient Temperature : 23.5 °C ; Liquid Temperature : 22.5 °C

#### DASY5 Configuration

- Probe: EX3DV4 - SN3931; ConvF(7.69, 7.69, 7.69); Calibrated: 2017/9/29;
- Sensor-Surface: 1.4mm (Mechanical Surface Detection)
- Electronics: DAE4 Sn1399; Calibrated: 2017/11/16
- Phantom: SAM\_Left; Type: QD000P40CD; Serial: S/N:1801
- Measurement SW: DASY52, Version 52.8 (8); SEMCAD X Version 14.6.10 (7373)

**Area Scan (51x101x1):** Interpolated grid: dx=1.200 mm, dy=1.200 mm

Maximum value of SAR (interpolated) = 0.0761 W/kg

**Zoom Scan (7x7x7)/Cube 0:** Measurement grid: dx=5mm, dy=5mm, dz=5mm

Reference Value = 5.725 V/m; Power Drift = -0.00 dB

Peak SAR (extrapolated) = 0.0930 W/kg

**SAR(1 g) = 0.048 W/kg; SAR(10 g) = 0.024 W/kg**

Maximum value of SAR (measured) = 0.0757 W/kg

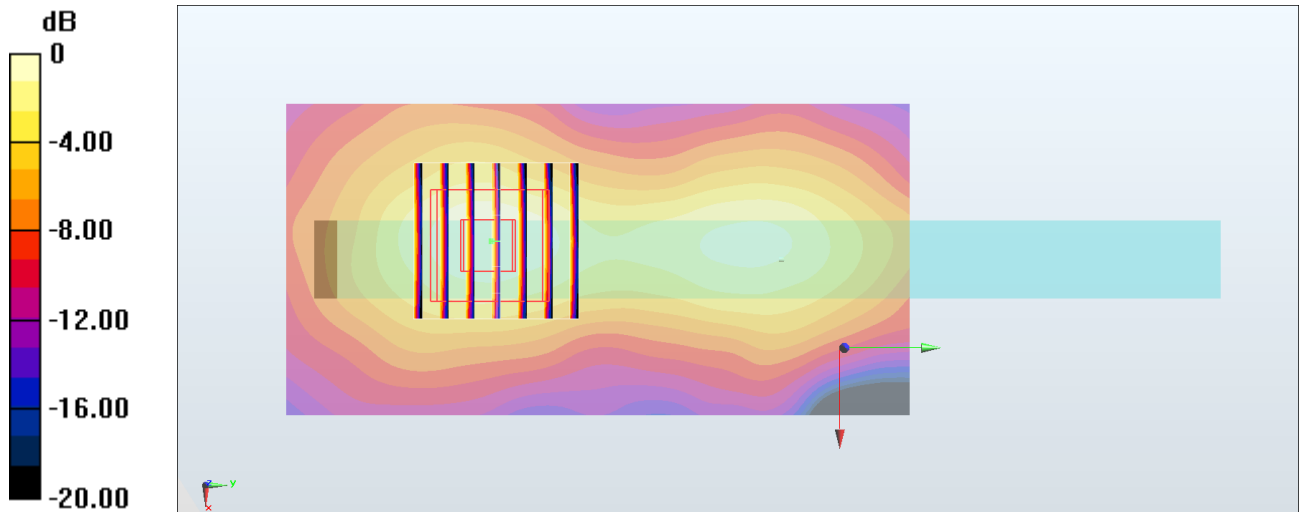

0 dB = 0.0757 W/kg = -11.21 dBW/kg



### #33\_WLAN2.4GHz\_802.11b 1Mbps\_Front\_10mm\_Ch1

Communication System: 802.11b ; Frequency: 2412 MHz;Duty Cycle: 1:1.01  
Medium: MSL\_2450\_180328 Medium parameters used:  $f = 2412$  MHz;  $\sigma = 1.971$  S/m;  $\epsilon_r = 54.623$ ;  
 $\rho = 1000$  kg/m<sup>3</sup>  
Ambient Temperature : 23.2 °C ; Liquid Temperature : 22.2 °C

#### DASY5 Configuration:

- Probe: EX3DV4 - SN3925; ConvF(7.94, 7.94, 7.94); Calibrated: 2017/5/24;
- Sensor-Surface: 1.4mm (Mechanical Surface Detection)
- Electronics: DAE4 Sn1424; Calibrated: 2018/1/18
- Phantom: SAM-Right; Type: SAM; Serial: TP-1503
- Measurement SW: DASY52, Version 52.8 (8);SEMCAD X Version 14.6.10 (7373)

**Area Scan (81x71x1):** Interpolated grid: dx=1.200 mm, dy=1.200 mm  
Maximum value of SAR (interpolated) = 0.347 W/kg

**Zoom Scan (7x7x7)/Cube 0:** Measurement grid: dx=5mm, dy=5mm, dz=5mm  
Reference Value = 7.553 V/m; Power Drift = 0.02 dB  
Peak SAR (extrapolated) = 0.423 W/kg  
**SAR(1 g) = 0.227 W/kg; SAR(10 g) = 0.122 W/kg**  
Maximum value of SAR (measured) = 0.345 W/kg

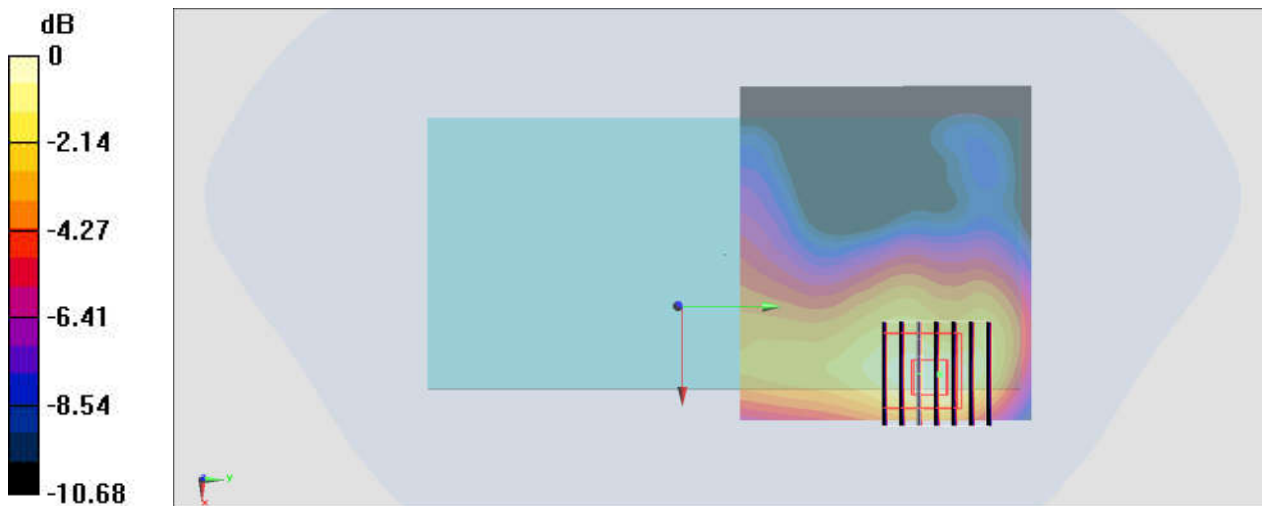

0 dB = 0.345 W/kg = -4.62 dBW/kg

### #34\_WLAN5GHz\_802.11a 6Mbps\_Back\_10mm\_Ch40

Communication System: 802.11a; Frequency: 5200 MHz; Duty Cycle: 1:1.054  
Medium: MSL\_5G\_180405 Medium parameters used:  $f = 5200$  MHz;  $\sigma = 5.457$  S/m;  $\epsilon_r = 47.144$ ;  $\rho = 1000$  kg/m<sup>3</sup>  
Ambient Temperature : 23.5 °C ; Liquid Temperature : 22.5 °C

#### DASY5 Configuration:

- Probe: EX3DV4 - SN3925; ConvF(4.59, 4.59, 4.59); Calibrated: 2017/5/24;
- Sensor-Surface: 1.4mm (Mechanical Surface Detection)
- Electronics: DAE4 Sn1424; Calibrated: 2018/1/18
- Phantom: SAM-Right; Type: SAM; Serial: TP-1503
- Measurement SW: DASY52, Version 52.8 (8); SEMCAD X Version 14.6.10 (7373)

**Area Scan (101x101x1):** Interpolated grid: dx=1.000 mm, dy=1.000 mm  
Maximum value of SAR (interpolated) = 1.27 W/kg

**Zoom Scan (9x8x7)/Cube 0:** Measurement grid: dx=4mm, dy=4mm, dz=1.4mm  
Reference Value = 8.218 V/m; Power Drift = 0.08 dB  
Peak SAR (extrapolated) = 3.17 W/kg  
**SAR(1 g) = 0.781 W/kg; SAR(10 g) = 0.236 W/kg**  
Maximum value of SAR (measured) = 1.93 W/kg

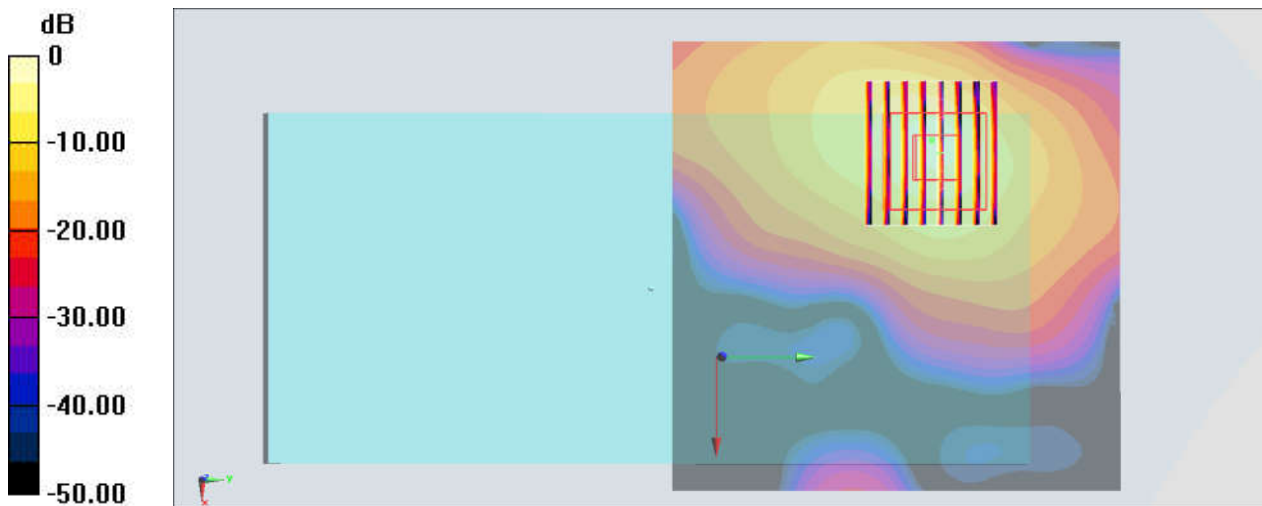

0 dB = 1.93 W/kg = 2.86 dBW/kg

### #35\_WLAN5GHz\_802.11a 6Mbps\_Back\_10mm\_Ch165

Communication System: 802.11a ; Frequency: 5825 MHz;Duty Cycle: 1:1.054  
Medium: MSL\_5G\_180329 Medium parameters used:  $f = 5825$  MHz;  $\sigma = 6.263$  S/m;  $\epsilon_r = 45.984$ ;  $\rho = 1000$  kg/m<sup>3</sup>  
Ambient Temperature : 23.5 °C ; Liquid Temperature : 22.5 °C

#### DASY5 Configuration:

- Probe: EX3DV4 - SN3925; ConvF(4.14, 4.14, 4.14); Calibrated: 2017/5/24;
- Sensor-Surface: 1.4mm (Mechanical Surface Detection)
- Electronics: DAE4 Sn1424; Calibrated: 2018/1/18
- Phantom: SAM-Right; Type: SAM; Serial: TP-1503
- Measurement SW: DASY52, Version 52.8 (8);SEMCAD X Version 14.6.10 (7373)

**Area Scan (101x101x1):** Interpolated grid: dx=1.000 mm, dy=1.000 mm  
Maximum value of SAR (interpolated) = 2.06 W/kg

**Zoom Scan (7x7x7)/Cube 0:** Measurement grid: dx=4mm, dy=4mm, dz=1.4mm  
Reference Value = 2.242 V/m; Power Drift = 0.19 dB  
Peak SAR (extrapolated) = 3.51 W/kg  
**SAR(1 g) = 0.838 W/kg; SAR(10 g) = 0.261 W/kg**  
Maximum value of SAR (measured) = 2.03 W/kg

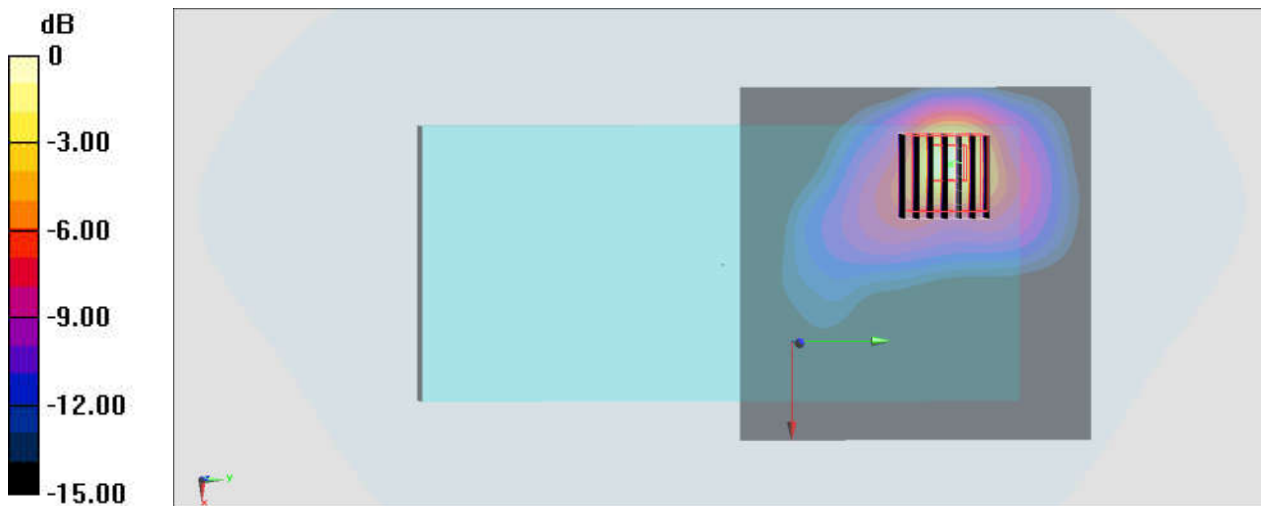

0 dB = 2.03 W/kg = 3.07 dBW/kg

**#36\_GSM850\_GPRS (4 Tx slots)\_Back\_15mm\_Ch128**

Communication System: GSM850 ; Frequency: 824.2 MHz; Duty Cycle: 1:2.08

Medium: MSL\_850\_180320 Medium parameters used :  $f = 824.2$  MHz;  $\sigma = 0.954$  S/m;  $\epsilon_r = 56.908$ ;  $\rho = 1000$  kg/m<sup>3</sup>

Ambient Temperature : 23.6 °C ; Liquid Temperature : 22.6 °C

**DASY5 Configuration**

- Probe: EX3DV4 - SN3931; ConvF(10.09, 10.09, 10.09); Calibrated: 2017/9/29;
- Sensor-Surface: 1.4mm (Mechanical Surface Detection)
- Electronics: DAE4 Sn1399; Calibrated: 2017/11/16
- Phantom: SAM\_Right; Type: QD000P40CD; Serial: S/N:1796
- Measurement SW: DASY52, Version 52.8 (8); SEMCAD X Version 14.6.10 (7373)

**Area Scan (61x131x1):** Interpolated grid: dx=1.500 mm, dy=1.500 mm

Maximum value of SAR (interpolated) = 0.552 W/kg

**Zoom Scan (5x5x7)/Cube 0:** Measurement grid: dx=8mm, dy=8mm, dz=5mm

Reference Value = 21.93 V/m; Power Drift = 0.06 dB

Peak SAR (extrapolated) = 0.611 W/kg

**SAR(1 g) = 0.461 W/kg; SAR(10 g) = 0.346 W/kg**

Maximum value of SAR (measured) = 0.554 W/kg

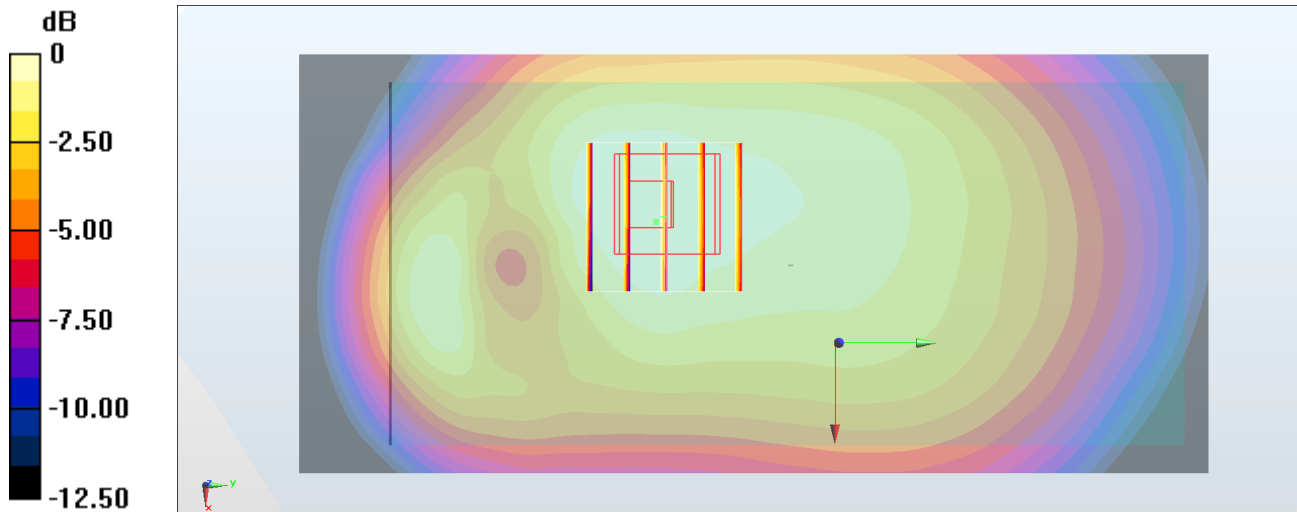

0 dB = 0.554 W/kg = -2.56 dBW/kg

**#37\_GSM1900\_GPRS (4 Tx slots)\_Back\_15mm\_Ch810**

Communication System: PCS; Frequency: 1909.8 MHz; Duty Cycle: 1:2.08

Medium: MSL\_1900\_180326 Medium parameters used:  $f = 1910$  MHz;  $\sigma = 1.56$  S/m;  $\epsilon_r = 51.604$ ;  $\rho = 1000$  kg/m<sup>3</sup>

Ambient Temperature : 23.5 °C ; Liquid Temperature : 22.5 °C

**DASY5 Configuration**

- Probe: EX3DV4 - SN3931; ConvF(8.12, 8.12, 8.12); Calibrated: 2017/9/29;
- Sensor-Surface: 1.4mm (Mechanical Surface Detection)
- Electronics: DAE4 Sn1399; Calibrated: 2017/11/16
- Phantom: SAM\_Left; Type: QD000P40CD; Serial: S/N:1801
- Measurement SW: DASY52, Version 52.8 (8); SEMCAD X Version 14.6.10 (7373)

**Area Scan (71x71x1):** Interpolated grid: dx=1.500 mm, dy=1.500 mm

Maximum value of SAR (interpolated) = 0.707 W/kg

**Zoom Scan (5x5x7)/Cube 0:** Measurement grid: dx=8mm, dy=8mm, dz=5mm

Reference Value = 6.775 V/m; Power Drift = -0.09 dB

Peak SAR (extrapolated) = 0.818 W/kg

**SAR(1 g) = 0.483 W/kg; SAR(10 g) = 0.263 W/kg**

Maximum value of SAR (measured) = 0.701 W/kg

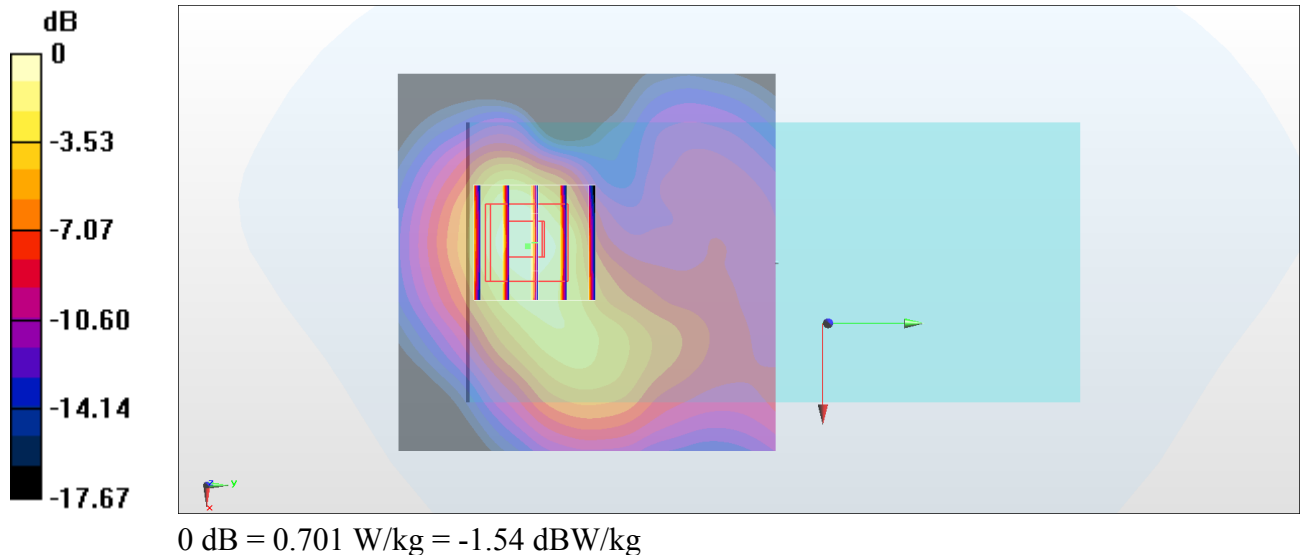

**#38\_WCDMA II\_RMC 12.2Kbps\_Back\_15mm\_Ch9538**

Communication System: WCDMA; Frequency: 1907.6 MHz; Duty Cycle: 1:1

Medium: MSL\_1900\_180326 Medium parameters used:  $f = 1908$  MHz;  $\sigma = 1.557$  S/m;  $\epsilon_r = 51.612$ ;  $\rho = 1000$  kg/m<sup>3</sup>

Ambient Temperature : 23.5 °C; Liquid Temperature : 22.5 °C

**DASY5 Configuration**

- Probe: EX3DV4 - SN3931; ConvF(8.12, 8.12, 8.12); Calibrated: 2017/9/29;
- Sensor-Surface: 1.4mm (Mechanical Surface Detection)
- Electronics: DAE4 Sn1399; Calibrated: 2017/11/16
- Phantom: SAM\_Left; Type: QD000P40CD; Serial: S/N:1801
- Measurement SW: DASY52, Version 52.8 (8); SEMCAD X Version 14.6.10 (7373)

**Area Scan (71x71x1):** Interpolated grid: dx=1.500 mm, dy=1.500 mm

Maximum value of SAR (interpolated) = 1.09 W/kg

**Zoom Scan (5x5x7)/Cube 0:** Measurement grid: dx=8mm, dy=8mm, dz=5mm

Reference Value = 25.64 V/m; Power Drift = -0.11 dB

Peak SAR (extrapolated) = 1.29 W/kg

**SAR(1 g) = 0.755 W/kg; SAR(10 g) = 0.413 W/kg**

Maximum value of SAR (measured) = 1.09 W/kg

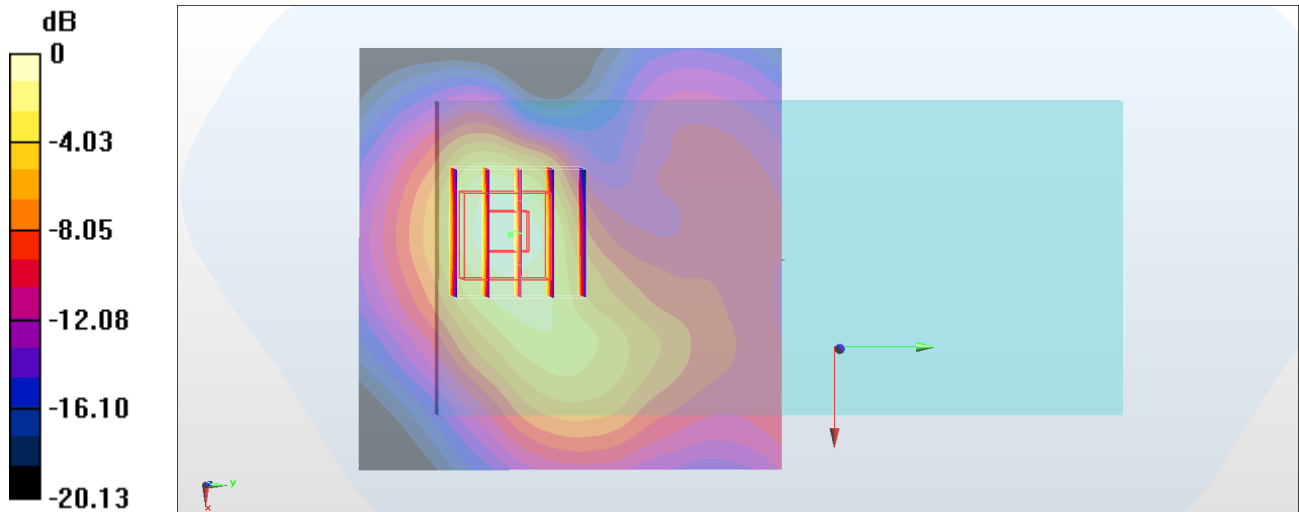

0 dB = 1.09 W/kg = 0.37 dBW/kg

**#39\_WCDMA IV\_RMC 12.2Kbps\_Back\_15mm\_Ch1312**

Communication System: WCDMA ; Frequency: 1712.4 MHz;Duty Cycle: 1:1

Medium: MSL\_1750\_180322 Medium parameters used :  $f = 1712.4$  MHz;  $\sigma = 1.445$  S/m;  $\epsilon_r = 54.911$ ;  $\rho = 1000$  kg/m<sup>3</sup>

Ambient Temperature : 23.2 °C ; Liquid Temperature : 22.2 °C

**DASY5 Configuration**

- Probe: EX3DV4 - SN3931; ConvF(8.43, 8.43, 8.43); Calibrated: 2017/9/29;
- Sensor-Surface: 1.4mm (Mechanical Surface Detection)
- Electronics: DAE4 Sn1399; Calibrated: 2017/11/16
- Phantom: SAM\_Left; Type: QD000P40CD; Serial: S/N:1801
- Measurement SW: DASY52, Version 52.8 (8); SEMCAD X Version 14.6.10 (7373)

**Area Scan (71x121x1):** Interpolated grid: dx=1.500 mm, dy=1.500 mm

Maximum value of SAR (interpolated) = 0.763 W/kg

**Zoom Scan (5x5x7)/Cube 0:** Measurement grid: dx=8mm, dy=8mm, dz=5mm

Reference Value = 4.835 V/m; Power Drift = -0.17 dB

Peak SAR (extrapolated) = 0.894 W/kg

**SAR(1 g) = 0.565 W/kg; SAR(10 g) = 0.339 W/kg**

Maximum value of SAR (measured) = 0.783 W/kg

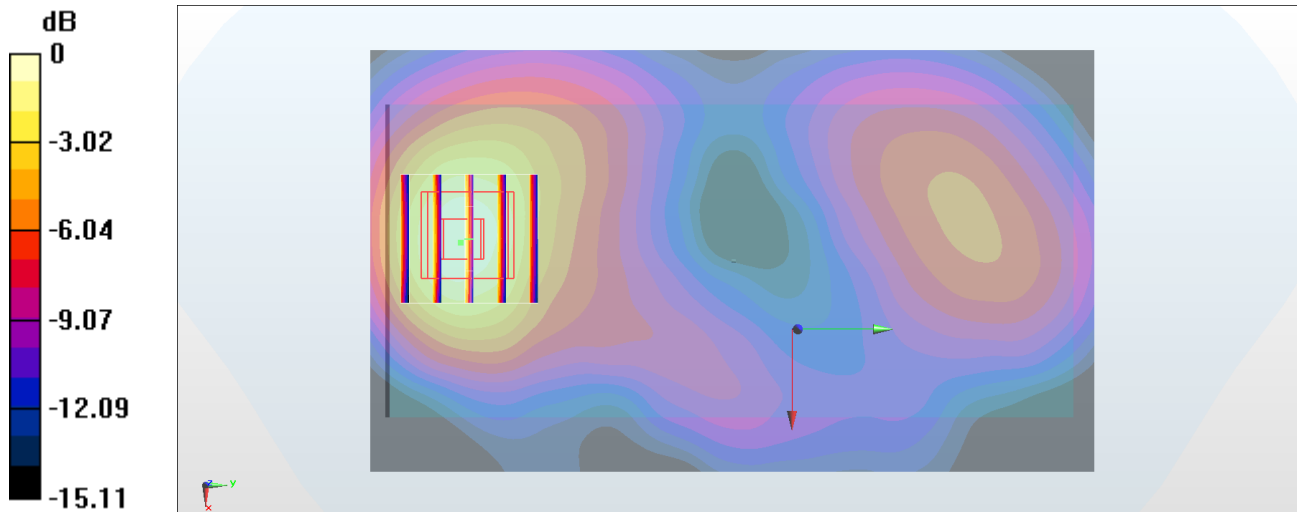

0 dB = 0.783 W/kg = -1.06 dBW/kg

### #40\_WCDMA V\_RMC 12.2Kbps\_Back\_15mm\_Ch4132

Communication System: WCDMA; Frequency: 826.4 MHz; Duty Cycle: 1:1  
Medium: MSL\_850\_180318 Medium parameters used:  $f = 826.4$  MHz;  $\sigma = 0.969$  S/m;  $\epsilon_r = 55.971$ ;  
 $\rho = 1000$  kg/m<sup>3</sup>  
Ambient Temperature : 23.2 °C ; Liquid Temperature : 22.2 °C

#### DASY5 Configuration:

- Probe: ES3DV3 - SN3270; ConvF(6.09, 6.09, 6.09); Calibrated: 2017/9/25;
- Sensor-Surface: 3mm (Mechanical Surface Detection)
- Electronics: DAE4 Sn778; Calibrated: 2017/5/22
- Phantom: SAM\_Left; Type: QD000P40CD; Serial: TP:1431
- Measurement SW: DASY52, Version 52.8 (8); SEMCAD X Version 14.6.10 (7373)

**Area Scan (61x121x1):** Interpolated grid: dx=1.500 mm, dy=1.500 mm  
Maximum value of SAR (interpolated) = 0.546 W/kg

**Zoom Scan (5x5x7)/Cube 0:** Measurement grid: dx=8mm, dy=8mm, dz=5mm  
Reference Value = 20.74 V/m; Power Drift = 0.17 dB  
Peak SAR (extrapolated) = 0.636 W/kg  
**SAR(1 g) = 0.497 W/kg; SAR(10 g) = 0.371 W/kg**  
Maximum value of SAR (measured) = 0.544 W/kg

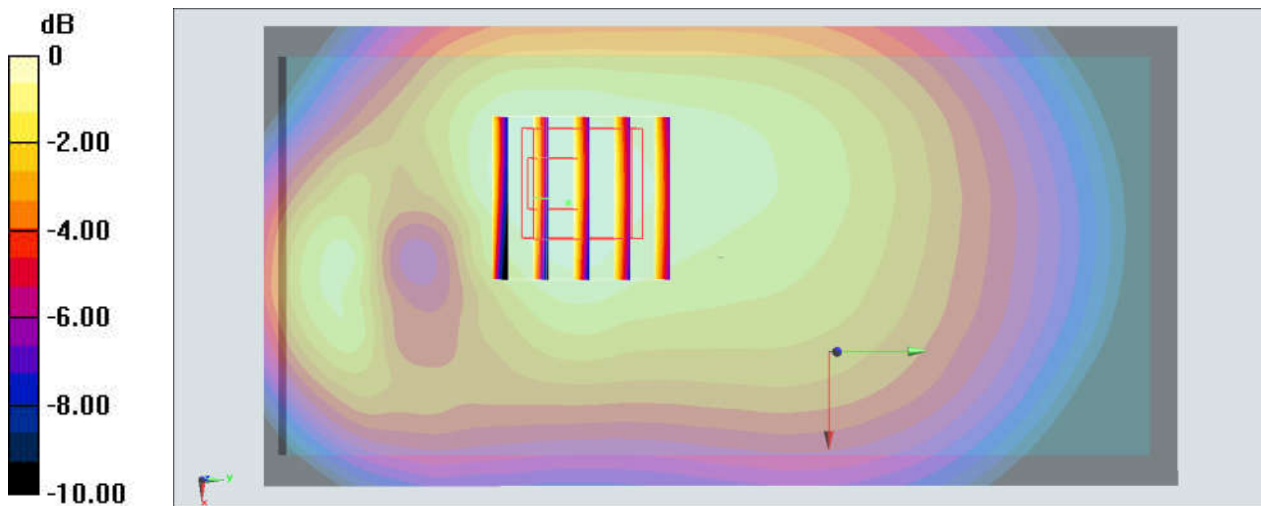

0 dB = 0.544 W/kg = -2.64 dBW/kg



### #41\_LTE Band 4\_20M\_QPSK\_1\_0\_Back\_15mm\_Ch20175

Communication System: LTE; Frequency: 1732.5 MHz; Duty Cycle: 1:1  
Medium: MSL1750\_180320 Medium parameters used:  $f = 1732.5$  MHz;  $\sigma = 1.449$  S/m;  $\epsilon_r = 55.773$ ;  
 $\rho = 1000$  kg/m<sup>3</sup>  
Ambient Temperature : 23.5 °C ; Liquid Temperature : 22.5 °C

#### DASY5 Configuration:

- Probe: ES3DV3 - SN3270; ConvF(5, 5, 5); Calibrated: 2017/9/25;
- Sensor-Surface: 3mm (Mechanical Surface Detection)
- Electronics: DAE4 Sn778; Calibrated: 2017/5/22
- Phantom: SAM-Right; Type: SAM; Serial: TP-1503
- Measurement SW: DASY52, Version 52.8 (8); SEMCAD X Version 14.6.10 (7373)

**Area Scan (61x131x1):** Interpolated grid: dx=1.500 mm, dy=1.500 mm  
Maximum value of SAR (interpolated) = 0.648 W/kg

**Zoom Scan (5x5x7)/Cube 0:** Measurement grid: dx=8mm, dy=8mm, dz=5mm  
Reference Value = 4.095 V/m; Power Drift = -0.04 dB  
Peak SAR (extrapolated) = 0.839 W/kg  
**SAR(1 g) = 0.529 W/kg; SAR(10 g) = 0.313 W/kg**  
Maximum value of SAR (measured) = 0.635 W/kg

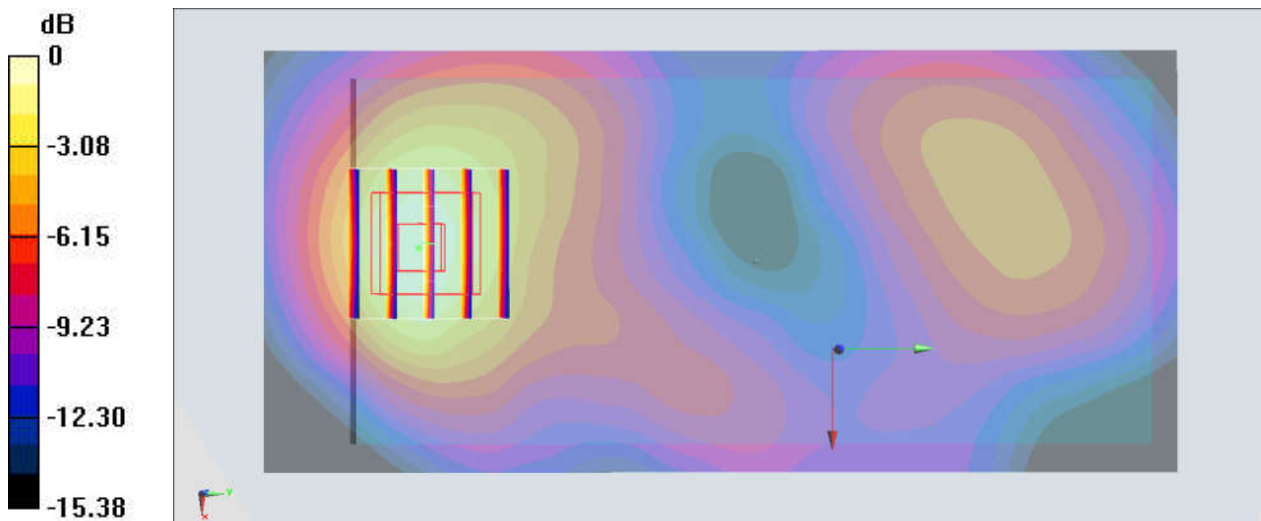

0 dB = 0.635 W/kg = -1.97 dBW/kg

### #42\_LTE Band 5\_10M\_QPSK\_1\_0\_Back\_15mm\_Ch20525

Communication System: LTE; Frequency: 836.5 MHz; Duty Cycle: 1:1  
Medium: MSL\_850\_180318 Medium parameters used:  $f = 836.5$  MHz;  $\sigma = 0.979$  S/m;  $\epsilon_r = 55.883$ ;  
 $\rho = 1000$  kg/m<sup>3</sup>  
Ambient Temperature : 23.3 °C ; Liquid Temperature : 22.3 °C

#### DASY5 Configuration:

- Probe: ES3DV3 - SN3270; ConvF(6.09, 6.09, 6.09); Calibrated: 2017/9/25;
- Sensor-Surface: 3mm (Mechanical Surface Detection)
- Electronics: DAE4 Sn778; Calibrated: 2017/5/22
- Phantom: SAM\_Left; Type: QD000P40CD; Serial: TP:1431
- Measurement SW: DASY52, Version 52.8 (8); SEMCAD X Version 14.6.10 (7373)

**Area Scan (61x121x1):** Interpolated grid: dx=1.500 mm, dy=1.500 mm  
Maximum value of SAR (interpolated) = 0.377 W/kg

**Zoom Scan (5x6x7)/Cube 0:** Measurement grid: dx=8mm, dy=8mm, dz=5mm  
Reference Value = 16.11 V/m; Power Drift = 0.04 dB  
Peak SAR (extrapolated) = 0.431 W/kg  
**SAR(1 g) = 0.334 W/kg; SAR(10 g) = 0.246 W/kg**  
Maximum value of SAR (measured) = 0.371 W/kg

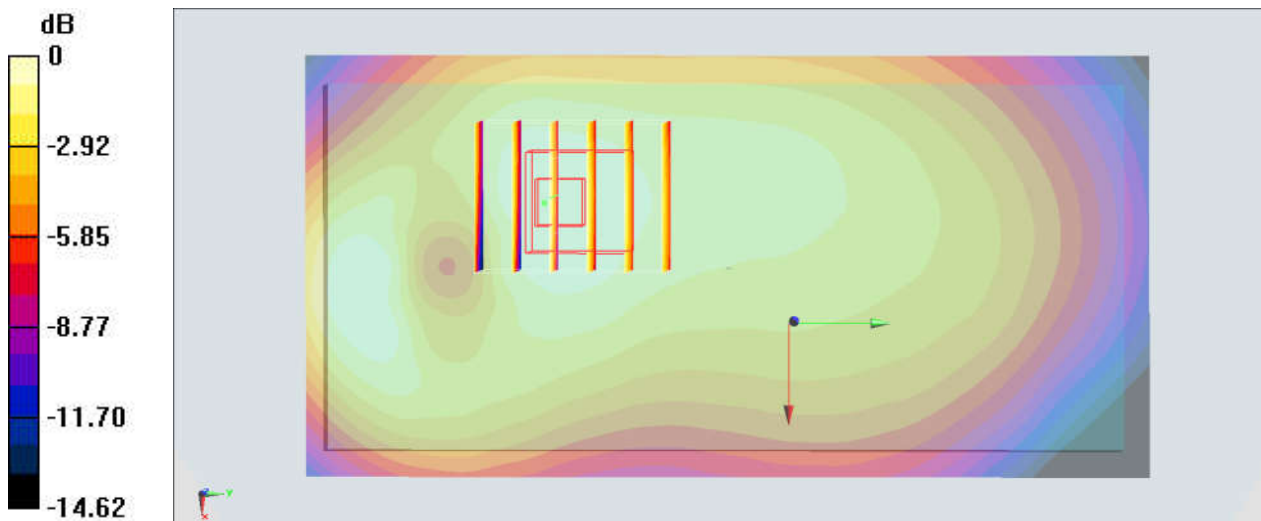

0 dB = 0.371 W/kg = -4.31 dBW/kg

**#43\_LTE Band 7\_20M\_QPSK\_1\_49\_Front\_15mm\_Ch21350**

Communication System: LTE ; Frequency: 2560 MHz;Duty Cycle: 1:1

Medium: MSL\_2600\_180322 Medium parameters used:  $f = 2560$  MHz;  $\sigma = 2.166$  S/m;  $\epsilon_r = 52.843$ ;  $\rho = 1000$  kg/m<sup>3</sup>

Ambient Temperature : 23.6 °C ; Liquid Temperature : 22.6 °C

**DASY5 Configuration**

- Probe: EX3DV4 - SN3931; ConvF(7.45, 7.45, 7.45); Calibrated: 2017/9/29;
- Sensor-Surface: 1.4mm (Mechanical Surface Detection)
- Electronics: DAE4 Sn1399; Calibrated: 2017/11/16
- Phantom: SAM\_Right; Type: QD000P40CD; Serial: S/N:1796
- Measurement SW: DASY52, Version 52.8 (8); SEMCAD X Version 14.6.10 (7373)

**Area Scan (81x81x1):** Interpolated grid: dx=1.200 mm, dy=1.200 mm

Maximum value of SAR (interpolated) = 0.680 W/kg

**Zoom Scan (7x7x7)/Cube 0:** Measurement grid: dx=5mm, dy=5mm, dz=5mm

Reference Value = 3.490 V/m; Power Drift = 0.07 dB

Peak SAR (extrapolated) = 0.826 W/kg

**SAR(1 g) = 0.425 W/kg; SAR(10 g) = 0.221 W/kg**

Maximum value of SAR (measured) = 0.669 W/kg

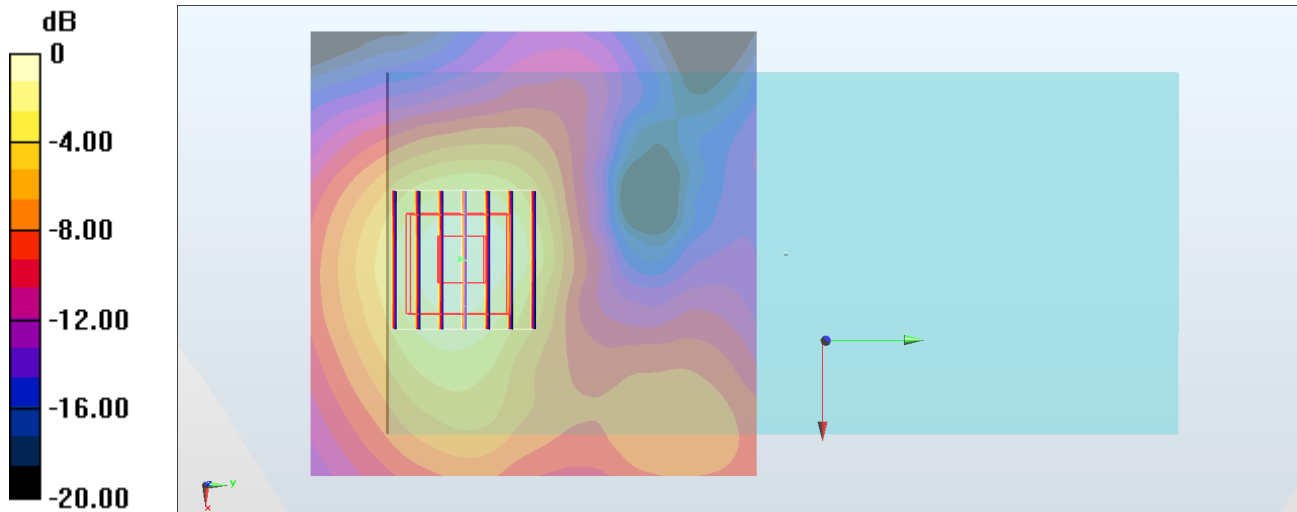

0 dB = 0.669 W/kg = -1.75 dBW/kg

### #44\_LTE Band 12\_10M\_QPSK\_1\_0\_Back\_15mm\_Ch23095

Communication System: LTE; Frequency: 707.5 MHz; Duty Cycle: 1:1  
Medium: MSL\_750\_180319 Medium parameters used :  $f = 707.5$  MHz;  $\sigma = 0.925$  S/m;  $\epsilon_r = 54.554$ ;  
 $\rho = 1000$  kg/m<sup>3</sup>  
Ambient Temperature : 23.3 °C; Liquid Temperature : 22.3 °C

#### DASY5 Configuration:

- Probe: ES3DV3 - SN3270; ConvF(6.31, 6.31, 6.31); Calibrated: 2017/9/25;
- Sensor-Surface: 3mm (Mechanical Surface Detection)
- Electronics: DAE4 Sn778; Calibrated: 2017/5/22
- Phantom: SAM\_Left; Type: QD000P40CD; Serial: TP:1431
- Measurement SW: DASY52, Version 52.8 (8); SEMCAD X Version 14.6.10 (7373)

**Area Scan (61x121x1):** Interpolated grid: dx=1.500 mm, dy=1.500 mm  
Maximum value of SAR (interpolated) = 0.314 W/kg

**Zoom Scan (5x5x7)/Cube 0:** Measurement grid: dx=8mm, dy=8mm, dz=5mm  
Reference Value = 17.40 V/m; Power Drift = -0.00 dB  
Peak SAR (extrapolated) = 0.357 W/kg  
**SAR(1 g) = 0.287 W/kg; SAR(10 g) = 0.228 W/kg**  
Maximum value of SAR (measured) = 0.311 W/kg

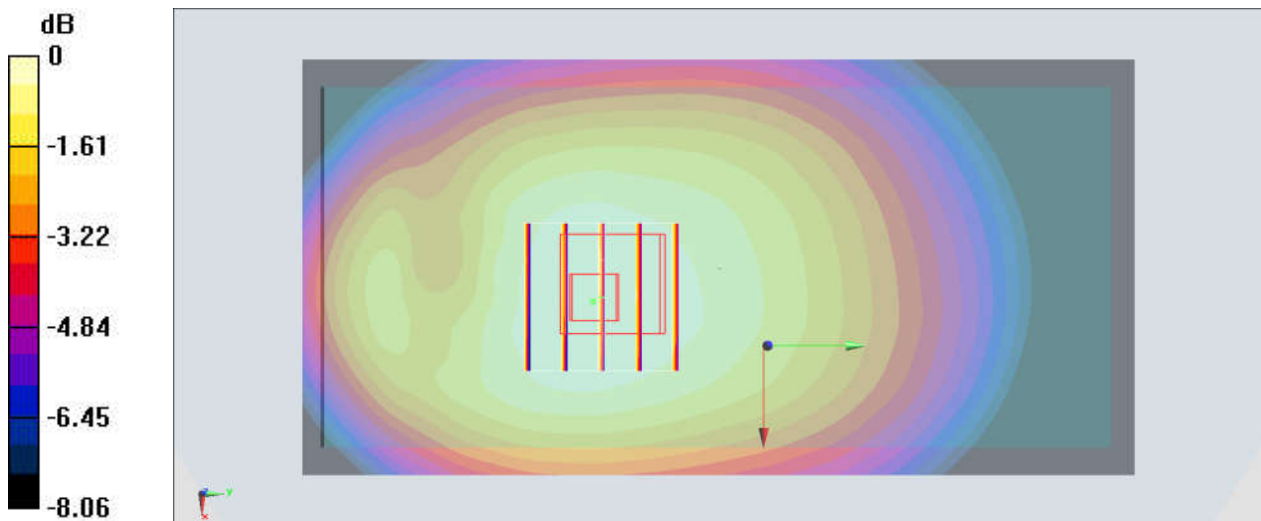

0 dB = 0.311 W/kg = -5.07 dBW/kg

### #45\_LTE Band 13\_10M\_QPSK\_1\_0\_Back\_15mm\_Ch23230

Communication System: LTE; Frequency: 782 MHz; Duty Cycle: 1:1  
Medium: MSL\_750\_180319 Medium parameters used:  $f = 782 \text{ MHz}$ ;  $\sigma = 0.994 \text{ S/m}$ ;  $\epsilon_r = 53.846$ ;  $\rho = 1000 \text{ kg/m}^3$   
Ambient Temperature :  $23.3 \text{ }^\circ\text{C}$ ; Liquid Temperature :  $22.3 \text{ }^\circ\text{C}$

#### DASY5 Configuration:

- Probe: ES3DV3 - SN3270; ConvF(6.31, 6.31, 6.31); Calibrated: 2017/9/25;
- Sensor-Surface: 3mm (Mechanical Surface Detection)
- Electronics: DAE4 Sn778; Calibrated: 2017/5/22
- Phantom: SAM\_Left; Type: QD000P40CD; Serial: TP:1431
- Measurement SW: DASY52, Version 52.8 (8); SEMCAD X Version 14.6.10 (7373)

**Area Scan (61x121x1):** Interpolated grid:  $dx=1.500 \text{ mm}$ ,  $dy=1.500 \text{ mm}$   
Maximum value of SAR (interpolated) =  $0.356 \text{ W/kg}$

**Zoom Scan (5x5x7)/Cube 0:** Measurement grid:  $dx=8\text{mm}$ ,  $dy=8\text{mm}$ ,  $dz=5\text{mm}$   
Reference Value =  $18.36 \text{ V/m}$ ; Power Drift =  $0.02 \text{ dB}$   
Peak SAR (extrapolated) =  $0.402 \text{ W/kg}$   
**SAR(1 g) =  $0.323 \text{ W/kg}$ ; SAR(10 g) =  $0.253 \text{ W/kg}$**   
Maximum value of SAR (measured) =  $0.352 \text{ W/kg}$

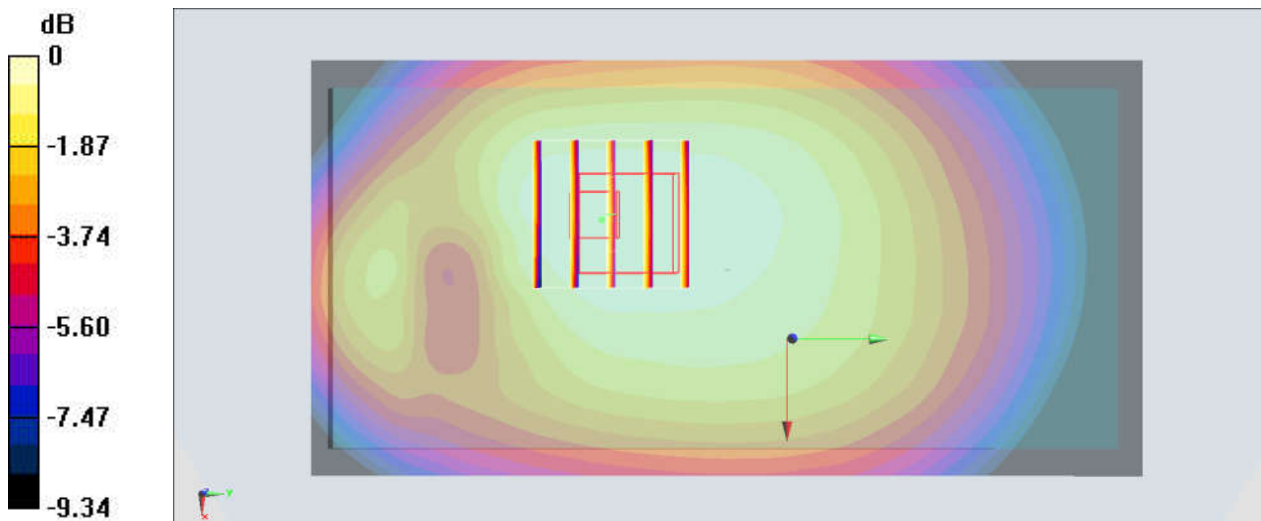

0 dB =  $0.352 \text{ W/kg} = -4.53 \text{ dBW/kg}$

## #46\_LTE Band 25\_20M\_QPSK\_1\_0\_Back\_15mm\_Ch26590

Communication System: LTE; Frequency: 1905 MHz; Duty Cycle: 1:1

Medium: MSL\_1900\_180326 Medium parameters used:  $f = 1905$  MHz;  $\sigma = 1.555$  S/m;  $\epsilon_r = 51.625$ ;  $\rho = 1000$  kg/m<sup>3</sup>

Ambient Temperature : 23.5 °C ; Liquid Temperature : 22.5 °C

### DASY5 Configuration

- Probe: EX3DV4 - SN3931; ConvF(8.12, 8.12, 8.12); Calibrated: 2017/9/29;
- Sensor-Surface: 1.4mm (Mechanical Surface Detection)
- Electronics: DAE4 Sn1399; Calibrated: 2017/11/16
- Phantom: SAM\_Left; Type: QD000P40CD; Serial: S/N:1801
- Measurement SW: DASY52, Version 52.8 (8); SEMCAD X Version 14.6.10 (7373)

**Area Scan (71x71x1):** Interpolated grid: dx=1.500 mm, dy=1.500 mm

Maximum value of SAR (interpolated) = 0.773 W/kg

**Zoom Scan (5x5x7)/Cube 0:** Measurement grid: dx=8mm, dy=8mm, dz=5mm

Reference Value = 20.94 V/m; Power Drift = -0.16 dB

Peak SAR (extrapolated) = 0.919 W/kg

**SAR(1 g) = 0.542 W/kg; SAR(10 g) = 0.300 W/kg**

Maximum value of SAR (measured) = 0.790 W/kg

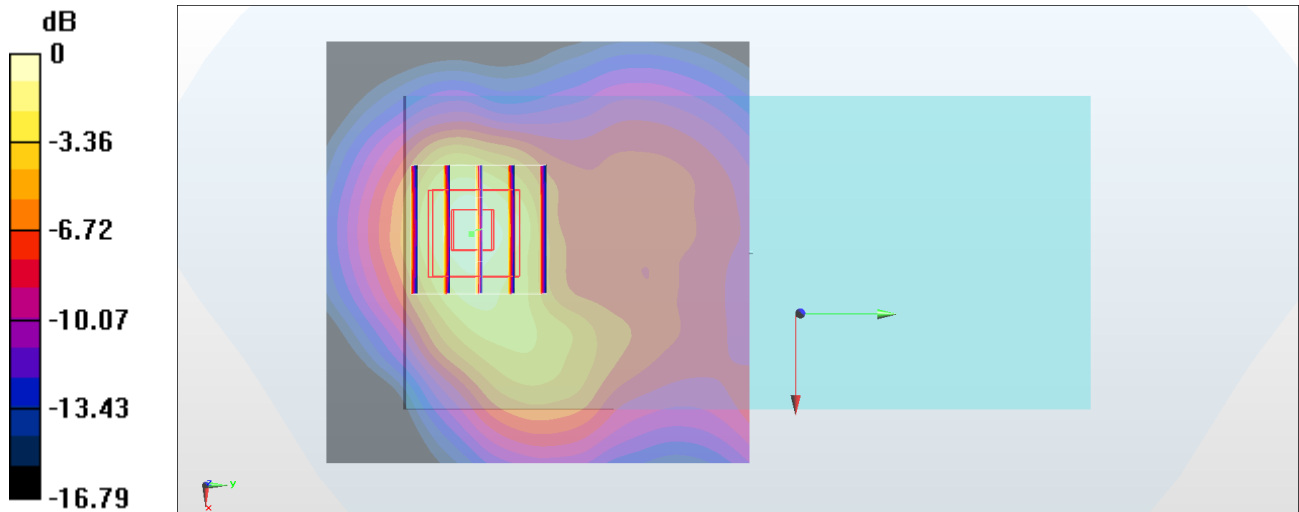

0 dB = 0.790 W/kg = -1.02 dBW/kg

### #47\_LTE Band 26\_15M\_QPSK\_1\_0\_Back\_15mm\_Ch26865

Communication System: LTE; Frequency: 831.5 MHz; Duty Cycle: 1:1  
Medium: MSL\_850\_180318 Medium parameters used:  $f = 831.5$  MHz;  $\sigma = 0.973$  S/m;  $\epsilon_r = 55.916$ ;  
 $\rho = 1000$  kg/m<sup>3</sup>  
Ambient Temperature : 23.3 °C ; Liquid Temperature : 22.3 °C

#### DASY5 Configuration:

- Probe: ES3DV3 - SN3270; ConvF(6.09, 6.09, 6.09); Calibrated: 2017/9/25;
- Sensor-Surface: 3mm (Mechanical Surface Detection)
- Electronics: DAE4 Sn778; Calibrated: 2017/5/22
- Phantom: SAM\_Left; Type: QD000P40CD; Serial: TP:1431
- Measurement SW: DASY52, Version 52.8 (8); SEMCAD X Version 14.6.10 (7373)

**Area Scan (61x121x1):** Interpolated grid: dx=1.500 mm, dy=1.500 mm  
Maximum value of SAR (interpolated) = 0.233 W/kg

**Zoom Scan (5x6x7)/Cube 0:** Measurement grid: dx=8mm, dy=8mm, dz=5mm  
Reference Value = 13.77 V/m; Power Drift = 0.06 dB  
Peak SAR (extrapolated) = 0.287 W/kg  
**SAR(1 g) = 0.224 W/kg; SAR(10 g) = 0.166 W/kg**  
Maximum value of SAR (measured) = 0.248 W/kg

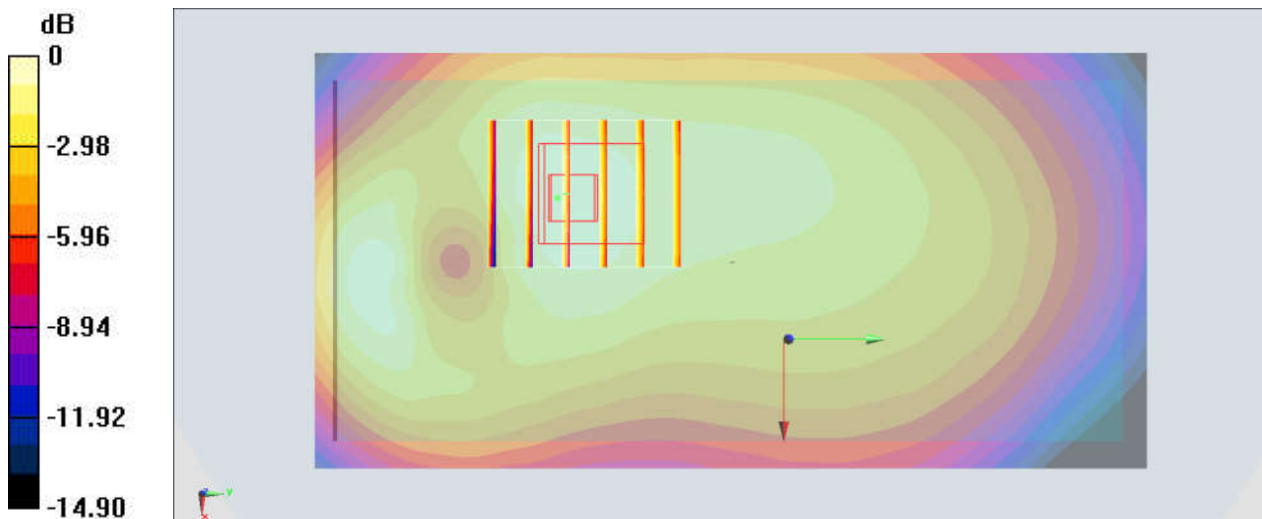

0 dB = 0.248 W/kg = -6.06 dBW/kg

### #48\_LTE Band 66\_20M\_QPSK\_1\_0\_Back\_15mm\_Ch132072

Communication System: LTE; Frequency: 1720 MHz; Duty Cycle: 1:1

Medium: MSL1750\_180320 Medium parameters used:  $f = 1720$  MHz;  $\sigma = 1.437$  S/m;  $\epsilon_r = 55.817$ ;  $\rho = 1000$  kg/m<sup>3</sup>

Ambient Temperature : 23.5 °C ; Liquid Temperature : 22.5 °C

#### DASY5 Configuration:

- Probe: ES3DV3 - SN3270; ConvF(5, 5, 5); Calibrated: 2017/9/25;
- Sensor-Surface: 3mm (Mechanical Surface Detection)
- Electronics: DAE4 Sn778; Calibrated: 2017/5/22
- Phantom: SAM-Right; Type: SAM; Serial: TP-1503
- Measurement SW: DASY52, Version 52.8 (8); SEMCAD X Version 14.6.10 (7373)

**Area Scan (61x131x1):** Interpolated grid: dx=1.500 mm, dy=1.500 mm

Maximum value of SAR (interpolated) = 0.578 W/kg

**Zoom Scan (5x5x7)/Cube 0:** Measurement grid: dx=8mm, dy=8mm, dz=5mm

Reference Value = 3.982 V/m; Power Drift = 0.09 dB

Peak SAR (extrapolated) = 0.741 W/kg

**SAR(1 g) = 0.469 W/kg; SAR(10 g) = 0.278 W/kg**

Maximum value of SAR (measured) = 0.561 W/kg

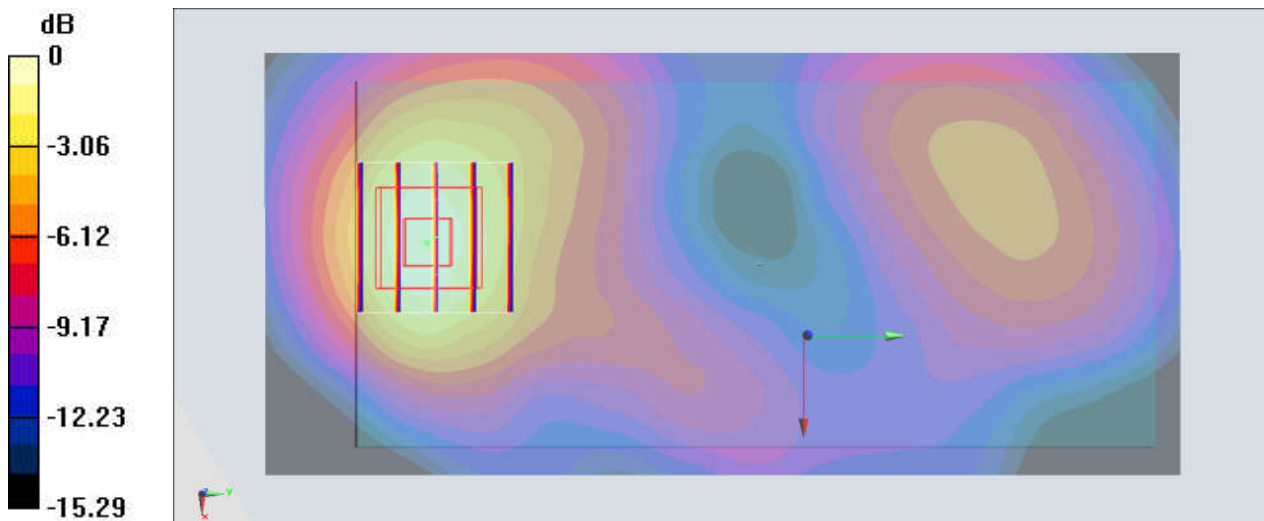

0 dB = 0.561 W/kg = -2.51 dBW/kg



## #49\_Bluetooth\_1Mbps\_Front\_15mm\_Ch0

Communication System: Bluetooth; Frequency: 2402 MHz; Duty Cycle: 1:1.297

Medium: MSL\_2450\_180324 Medium parameters used:  $f = 2402$  MHz;  $\sigma = 1.916$  S/m;  $\epsilon_r = 51.379$ ;  $\rho = 1000$  kg/m<sup>3</sup>

Ambient Temperature : 23.5 °C ; Liquid Temperature : 22.5 °C

### DASY5 Configuration

- Probe: EX3DV4 - SN3931; ConvF(7.69, 7.69, 7.69); Calibrated: 2017/9/29;
- Sensor-Surface: 1.4mm (Mechanical Surface Detection)
- Electronics: DAE4 Sn1399; Calibrated: 2017/11/16
- Phantom: SAM\_Left; Type: QD000P40CD; Serial: S/N:1801
- Measurement SW: DASY52, Version 52.8 (8); SEMCAD X Version 14.6.10 (7373)

**Area Scan (91x101x1):** Interpolated grid: dx=1.200 mm, dy=1.200 mm

Maximum value of SAR (interpolated) = 0.0258 W/kg

**Zoom Scan (7x7x7)/Cube 0:** Measurement grid: dx=5mm, dy=5mm, dz=5mm

Reference Value = 3.128 V/m; Power Drift = -0.19 dB

Peak SAR (extrapolated) = 0.0330 W/kg

**SAR(1 g) = 0.017 W/kg; SAR(10 g) = 0.00923 W/kg**

Maximum value of SAR (measured) = 0.0272 W/kg

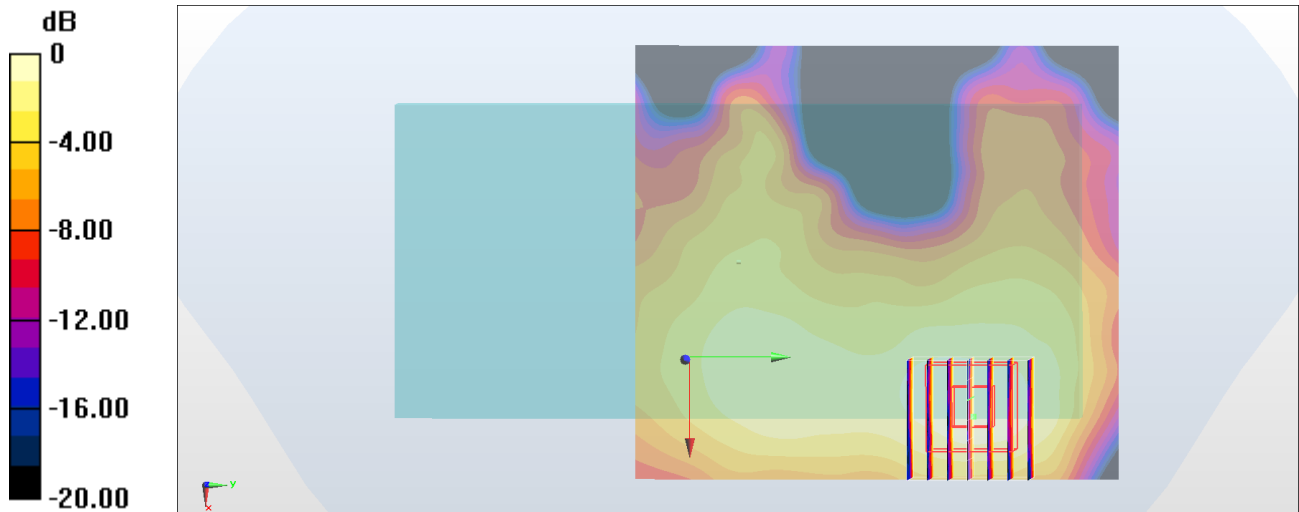

0 dB = 0.0272 W/kg = -15.65 dBW/kg

### #50\_WLAN2.4GHz\_802.11b 1Mbps\_Front\_15mm\_Ch1

Communication System: 802.11b ; Frequency: 2412 MHz;Duty Cycle: 1:1.01  
Medium: MSL\_2450\_180328 Medium parameters used:  $f = 2412$  MHz;  $\sigma = 1.971$  S/m;  $\epsilon_r = 54.623$ ;  
 $\rho = 1000$  kg/m<sup>3</sup>  
Ambient Temperature : 23.2 °C ; Liquid Temperature : 22.2 °C

#### DASY5 Configuration:

- Probe: EX3DV4 - SN3925; ConvF(7.94, 7.94, 7.94); Calibrated: 2017/5/24;
- Sensor-Surface: 1.4mm (Mechanical Surface Detection)
- Electronics: DAE4 Sn1424; Calibrated: 2018/1/18
- Phantom: SAM-Right; Type: SAM; Serial: TP-1503
- Measurement SW: DASY52, Version 52.8 (8);SEMCAD X Version 14.6.10 (7373)

**Area Scan (81x71x1):** Interpolated grid: dx=1.200 mm, dy=1.200 mm  
Maximum value of SAR (interpolated) = 0.181 W/kg

**Zoom Scan (7x7x7)/Cube 0:** Measurement grid: dx=5mm, dy=5mm, dz=5mm  
Reference Value = 6.228 V/m; Power Drift = 0.01 dB  
Peak SAR (extrapolated) = 0.220 W/kg  
**SAR(1 g) = 0.121 W/kg; SAR(10 g) = 0.068 W/kg**  
Maximum value of SAR (measured) = 0.181 W/kg

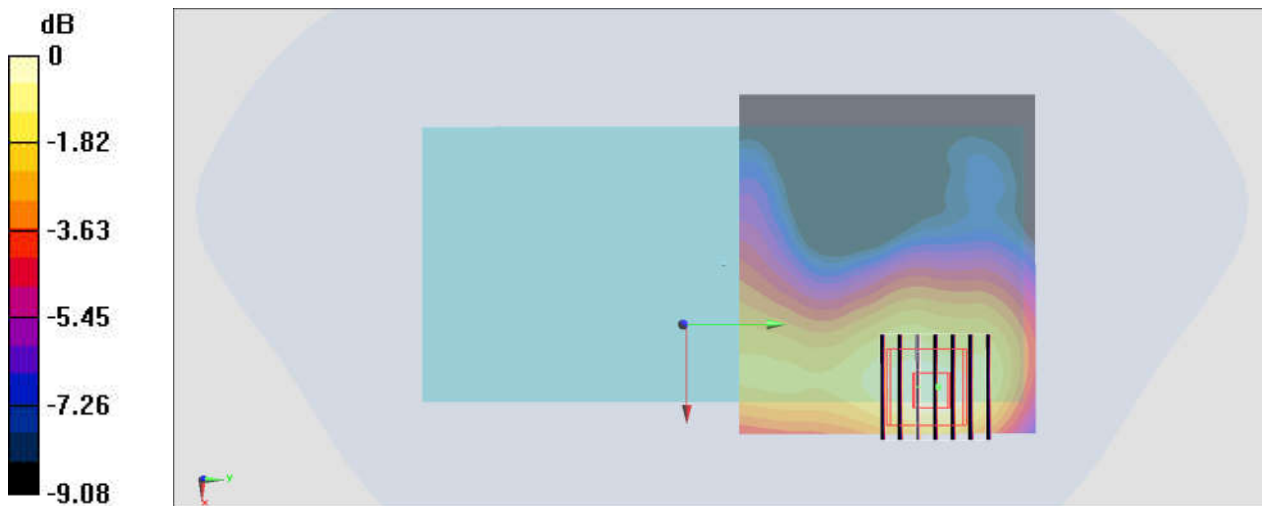

0 dB = 0.181 W/kg = -7.42 dBW/kg

### #51\_WLAN5GHz\_802.11a 6Mbps\_Back\_15mm\_Ch52

Communication System: 802.11a; Frequency: 5260 MHz; Duty Cycle: 1:1.054  
Medium: MSL\_5G\_180405 Medium parameters used:  $f = 5260$  MHz;  $\sigma = 5.533$  S/m;  $\epsilon_r = 47.038$ ;  $\rho = 1000$  kg/m<sup>3</sup>  
Ambient Temperature : 23.5 °C ; Liquid Temperature : 22.5 °C

#### DASY5 Configuration:

- Probe: EX3DV4 - SN3925; ConvF(4.59, 4.59, 4.59); Calibrated: 2017/5/24;
- Sensor-Surface: 1.4mm (Mechanical Surface Detection)
- Electronics: DAE4 Sn1424; Calibrated: 2018/1/18
- Phantom: SAM-Right; Type: SAM; Serial: TP-1503
- Measurement SW: DASY52, Version 52.8 (8); SEMCAD X Version 14.6.10 (7373)

**Area Scan (101x101x1):** Interpolated grid: dx=1.000 mm, dy=1.000 mm  
Maximum value of SAR (interpolated) = 1.31 W/kg

**Zoom Scan (9x8x7)/Cube 0:** Measurement grid: dx=4mm, dy=4mm, dz=1.4mm  
Reference Value = 0 V/m; Power Drift = 0.07 dB  
Peak SAR (extrapolated) = 2.15 W/kg  
**SAR(1 g) = 0.545 W/kg; SAR(10 g) = 0.202 W/kg**  
Maximum value of SAR (measured) = 1.34 W/kg

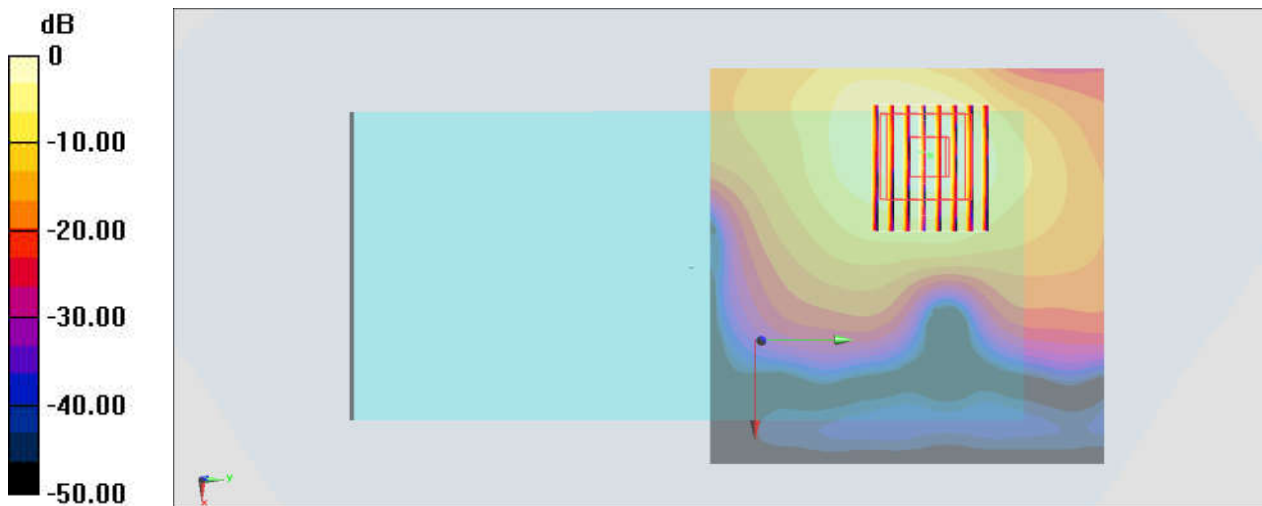

0 dB = 1.34 W/kg = 1.27 dBW/kg

### #52\_WLAN5GHz\_802.11a 6Mbps\_Back\_15mm\_Ch144

Communication System: 802.11a; Frequency: 5720 MHz; Duty Cycle: 1:1.054  
Medium: MSL\_5G\_180329 Medium parameters used:  $f = 5720$  MHz;  $\sigma = 6.124$  S/m;  $\epsilon_r = 46.176$ ;  $\rho = 1000$  kg/m<sup>3</sup>  
Ambient Temperature : 23.5 °C ; Liquid Temperature : 22.5 °C

#### DASY5 Configuration:

- Probe: EX3DV4 - SN3925; ConvF(4.14, 4.14, 4.14); Calibrated: 2017/5/24;
- Sensor-Surface: 1.4mm (Mechanical Surface Detection)
- Electronics: DAE4 Sn1424; Calibrated: 2018/1/18
- Phantom: SAM-Right; Type: SAM; Serial: TP-1503
- Measurement SW: DASY52, Version 52.8 (8); SEMCAD X Version 14.6.10 (7373)

**Area Scan (101x101x1):** Interpolated grid: dx=1.000 mm, dy=1.000 mm  
Maximum value of SAR (interpolated) = 1.00 W/kg

**Zoom Scan (8x8x7)/Cube 0:** Measurement grid: dx=4mm, dy=4mm, dz=1.4mm  
Reference Value = 9.629 V/m; Power Drift = 0.09 dB  
Peak SAR (extrapolated) = 2.09 W/kg  
**SAR(1 g) = 0.524 W/kg; SAR(10 g) = 0.186 W/kg**  
Maximum value of SAR (measured) = 1.24 W/kg

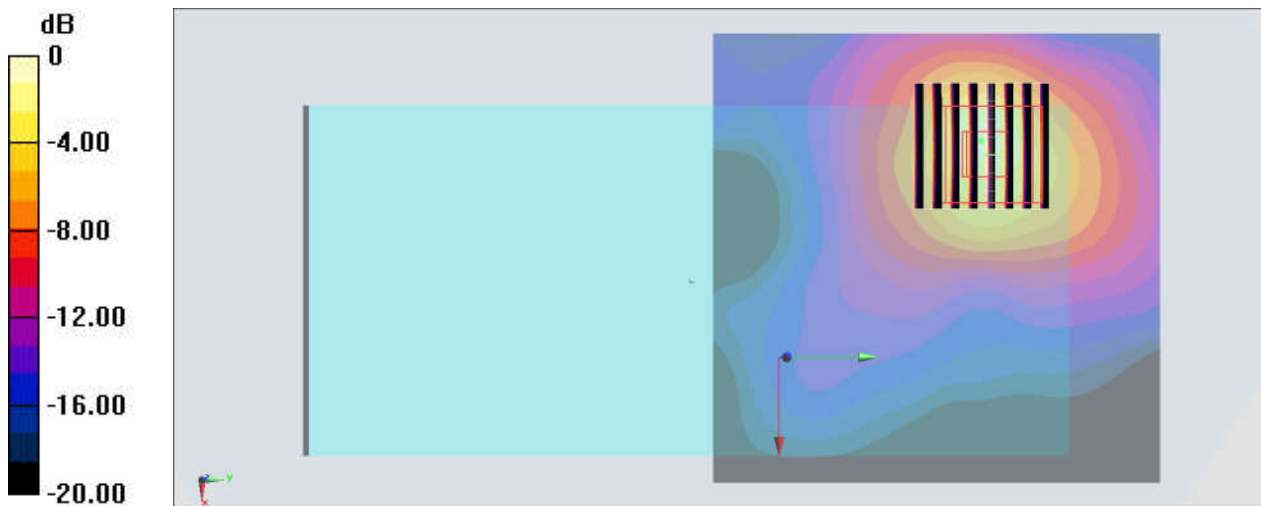

0 dB = 1.24 W/kg = 0.93 dBW/kg

### #53\_WLAN5GHz\_802.11a\_6Mbps\_Back\_15mm\_Ch149

Communication System: 802.11a; Frequency: 5745 MHz; Duty Cycle: 1:1.054  
Medium: MSL\_5G\_180329 Medium parameters used:  $f = 5745$  MHz;  $\sigma = 6.157$  S/m;  $\epsilon_r = 46.12$ ;  $\rho = 1000$  kg/m<sup>3</sup>  
Ambient Temperature : 23.5 °C ; Liquid Temperature : 22.5 °C

#### DASY5 Configuration:

- Probe: EX3DV4 - SN3925; ConvF(4.14, 4.14, 4.14); Calibrated: 2017/5/24;
- Sensor-Surface: 1.4mm (Mechanical Surface Detection)
- Electronics: DAE4 Sn1424; Calibrated: 2018/1/18
- Phantom: SAM-Right; Type: SAM; Serial: TP-1503
- Measurement SW: DASY52, Version 52.8 (8); SEMCAD X Version 14.6.10 (7373)

**Area Scan (101x101x1):** Interpolated grid: dx=1.000 mm, dy=1.000 mm  
Maximum value of SAR (interpolated) = 1.25 W/kg

**Zoom Scan (8x8x7)/Cube 0:** Measurement grid: dx=4mm, dy=4mm, dz=1.4mm  
Reference Value = 1.471 V/m; Power Drift = -0.03 dB  
Peak SAR (extrapolated) = 2.05 W/kg  
**SAR(1 g) = 0.540 W/kg; SAR(10 g) = 0.194 W/kg**  
Maximum value of SAR (measured) = 1.24 W/kg

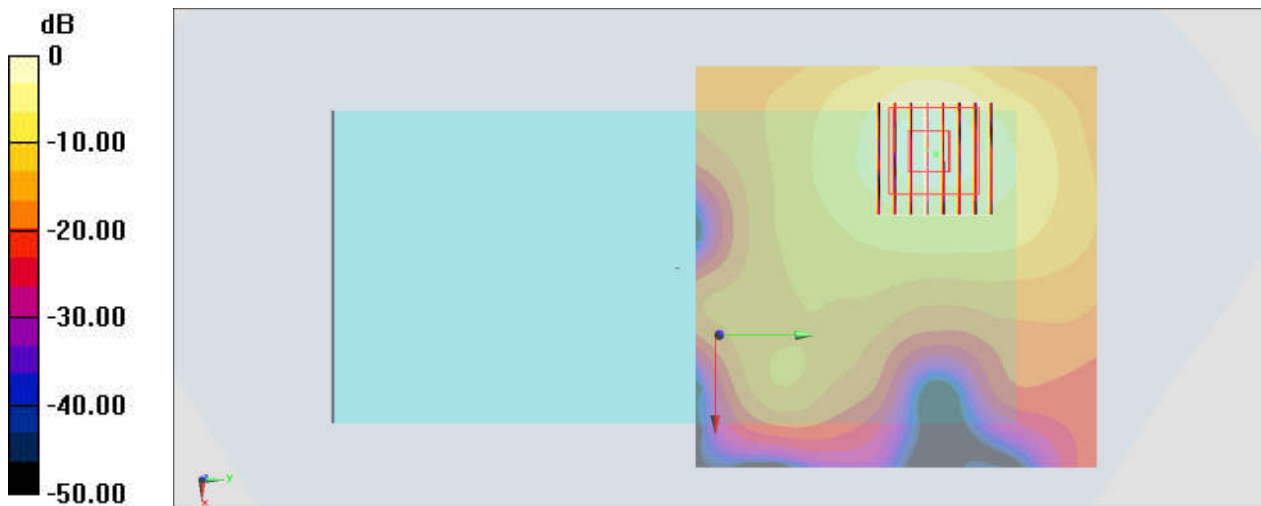

0 dB = 1.24 W/kg = 0.93 dBW/kg

**#54\_WCDMA II\_RMC 12.2Kbps\_Back\_0mm\_Ch9262**

Communication System: WCDMA; Frequency: 1852.4 MHz; Duty Cycle: 1:1

Medium: MSL\_1900\_180326 Medium parameters used :  $f = 1852.4$  MHz;  $\sigma = 1.495$  S/m;  $\epsilon_r = 51.809$ ;  $\rho = 1000$  kg/m<sup>3</sup>

Ambient Temperature : 23.5 °C ; Liquid Temperature : 22.5 °C

**DASY5 Configuration**

- Probe: EX3DV4 - SN3931; ConvF(8.12, 8.12, 8.12); Calibrated: 2017/9/29;
- Sensor-Surface: 1.4mm (Mechanical Surface Detection)
- Electronics: DAE4 Sn1399; Calibrated: 2017/11/16
- Phantom: SAM\_Left; Type: QD000P40CD; Serial: S/N:1801
- Measurement SW: DASY52, Version 52.8 (8); SEMCAD X Version 14.6.10 (7373)

**Area Scan (71x71x1):** Interpolated grid: dx=1.500 mm, dy=1.500 mm

Maximum value of SAR (interpolated) = 10.8 W/kg

**Zoom Scan (5x5x7)/Cube 0:** Measurement grid: dx=8mm, dy=8mm, dz=5mm

Reference Value = 87.79 V/m; Power Drift = -0.04 dB

Peak SAR (extrapolated) = 18.1 W/kg

**SAR(1 g) = 7.28 W/kg; SAR(10 g) = 3.05 W/kg**

Maximum value of SAR (measured) = 14.9 W/kg

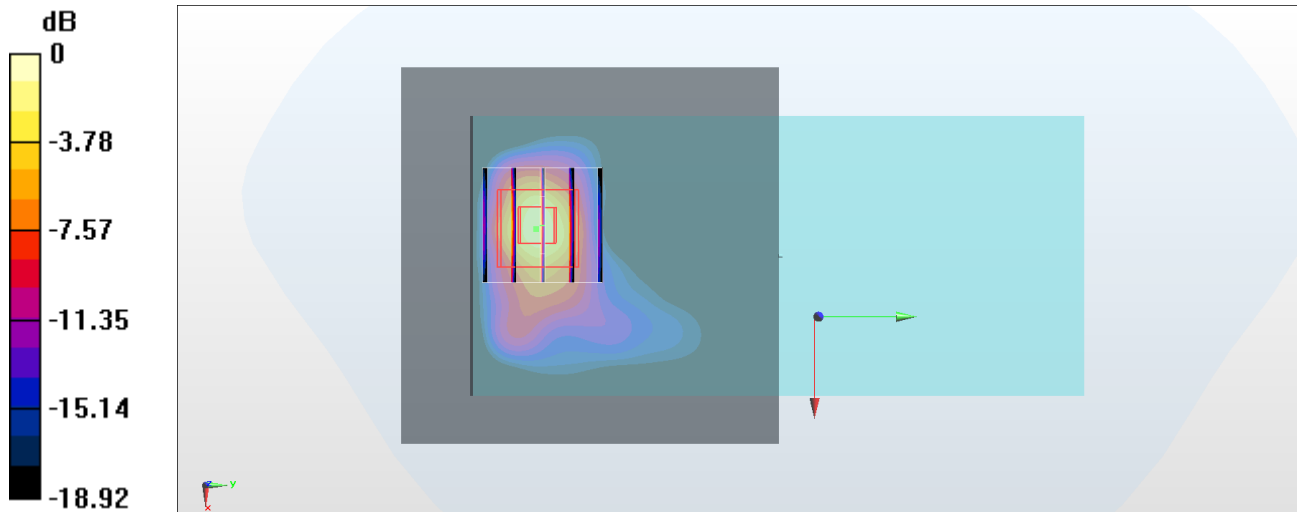

0 dB = 14.9 W/kg = 11.73 dBW/kg

### #55\_LTE Band 25\_20M\_QPSK\_1\_0\_Back\_0mm\_Ch26140

Communication System: LTE ; Frequency: 1860 MHz;Duty Cycle: 1:1  
Medium: MSL\_1900\_180328 Medium parameters used:  $f = 1860$  MHz;  $\sigma = 1.519$  S/m;  $\epsilon_r = 54.129$ ;  
 $\rho = 1000$  kg/m<sup>3</sup>  
Ambient Temperature : 23.3 °C ; Liquid Temperature : 22.3 °C

#### DASY5 Configuration:

- Probe: EX3DV4 - SN3925; ConvF(8.25, 8.25, 8.25); Calibrated: 2017/5/24;
- Sensor-Surface: 1.4mm (Mechanical Surface Detection)
- Electronics: DAE4 Sn1424; Calibrated: 2018/1/18
- Phantom: SAM-Right; Type: SAM; Serial: TP-1503
- Measurement SW: DASY52, Version 52.8 (8);SEMCAD X Version 14.6.10 (7373)

**Area Scan (71x71x1):** Interpolated grid: dx=1.500 mm, dy=1.500 mm  
Maximum value of SAR (interpolated) = 8.25 W/kg

**Zoom Scan (5x5x7)/Cube 0:** Measurement grid: dx=8mm, dy=8mm, dz=5mm  
Reference Value = 6.239 V/m; Power Drift = 0.10 dB  
Peak SAR (extrapolated) = 14.0 W/kg  
**SAR(1 g) = 6.15 W/kg; SAR(10 g) = 2.63 W/kg**  
Maximum value of SAR (measured) = 11.4 W/kg

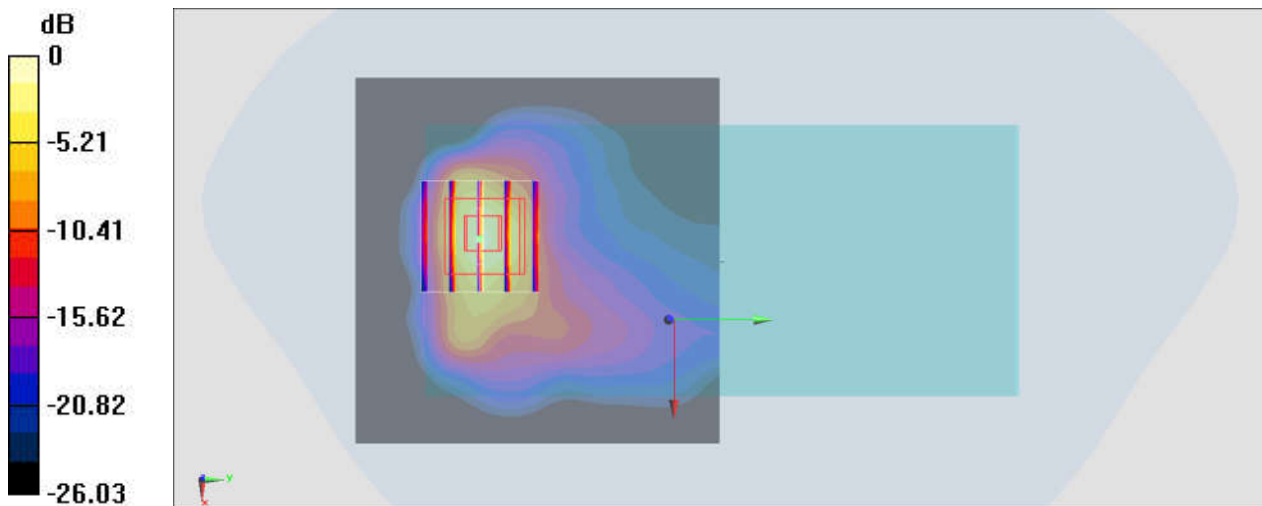

0 dB = 11.4 W/kg = 10.57 dBW/kg

### #56\_WLAN5GHz\_802.11a\_6Mbps\_Back\_0mm\_Ch52

Communication System: 802.11a; Frequency: 5260 MHz; Duty Cycle: 1:1.054  
Medium: MSL\_5G\_180405 Medium parameters used:  $f = 5260$  MHz;  $\sigma = 5.533$  S/m;  $\epsilon_r = 47.038$ ;  $\rho = 1000$  kg/m<sup>3</sup>  
Ambient Temperature : 23.5 °C; Liquid Temperature : 22.5 °C

#### DASY5 Configuration:

- Probe: EX3DV4 - SN3925; ConvF(4.59, 4.59, 4.59); Calibrated: 2017/5/24;
- Sensor-Surface: 1.4mm (Mechanical Surface Detection)
- Electronics: DAE4 Sn1424; Calibrated: 2018/1/18
- Phantom: SAM-Right; Type: SAM; Serial: TP-1503
- Measurement SW: DASY52, Version 52.8 (8); SEMCAD X Version 14.6.10 (7373)

**Area Scan (101x101x1):** Interpolated grid: dx=1.000 mm, dy=1.000 mm  
Maximum value of SAR (interpolated) = 36.1 W/kg

**Zoom Scan (9x9x7)/Cube 0:** Measurement grid: dx=4mm, dy=4mm, dz=1.4mm  
Reference Value = 1.041 V/m; Power Drift = 0.05 dB  
Peak SAR (extrapolated) = 78 W/kg  
**SAR(1 g) = 11.5 W/kg; SAR(10 g) = 2.06 W/kg**  
Maximum value of SAR (measured) = 39.2 W/kg

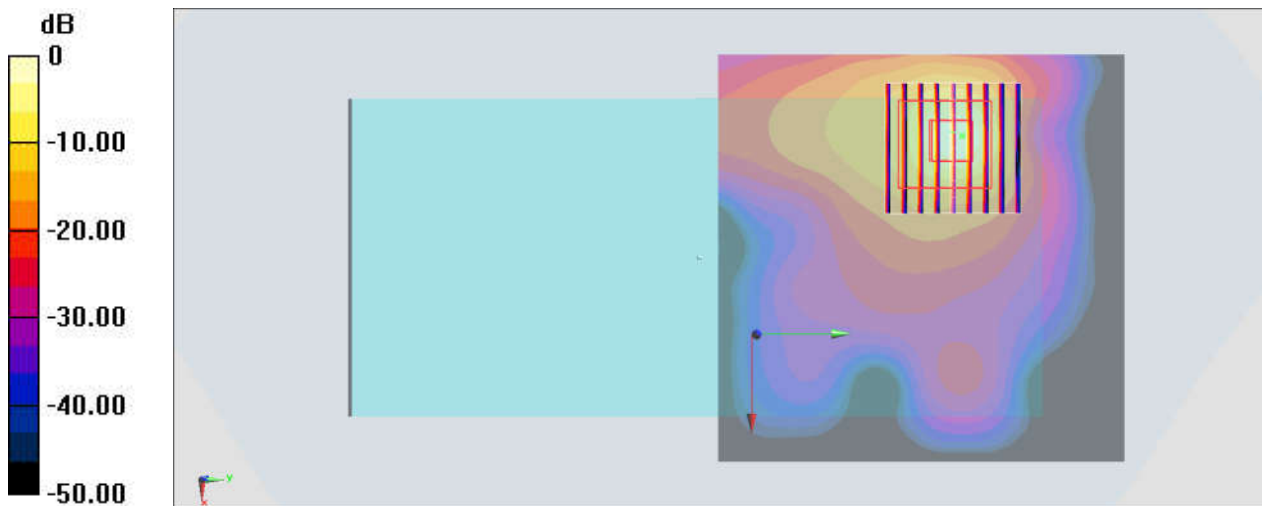

0 dB = 39.2 W/kg = 15.93 dBW/kg



### #57\_WLAN5GHz\_802.11a 6Mbps\_Back\_0mm\_Ch144

Communication System: 802.11a; Frequency: 5720 MHz; Duty Cycle: 1:1.054  
Medium: MSL\_5G\_180329 Medium parameters used:  $f = 5720$  MHz;  $\sigma = 6.124$  S/m;  $\epsilon_r = 46.176$ ;  $\rho = 1000$  kg/m<sup>3</sup>  
Ambient Temperature : 23.5 °C; Liquid Temperature : 22.5 °C

#### DASY5 Configuration:

- Probe: EX3DV4 - SN3925; ConvF(4.14, 4.14, 4.14); Calibrated: 2017/5/24;
- Sensor-Surface: 1.4mm (Mechanical Surface Detection)
- Electronics: DAE4 Sn1424; Calibrated: 2018/1/18
- Phantom: SAM-Right; Type: SAM; Serial: TP-1503
- Measurement SW: DASY52, Version 52.8 (8); SEMCAD X Version 14.6.10 (7373)

**Area Scan (101x101x1):** Interpolated grid: dx=1.000 mm, dy=1.000 mm  
Maximum value of SAR (interpolated) = 11.6 W/kg

**Zoom Scan (8x8x7)/Cube 0:** Measurement grid: dx=4mm, dy=4mm, dz=1.4mm  
Reference Value = 0 V/m; Power Drift = 0.00 dB  
Peak SAR (extrapolated) = 70.1 W/kg  
**SAR(1 g) = 9.51 W/kg; SAR(10 g) = 1.94 W/kg**  
Maximum value of SAR (measured) = 37.4 W/kg

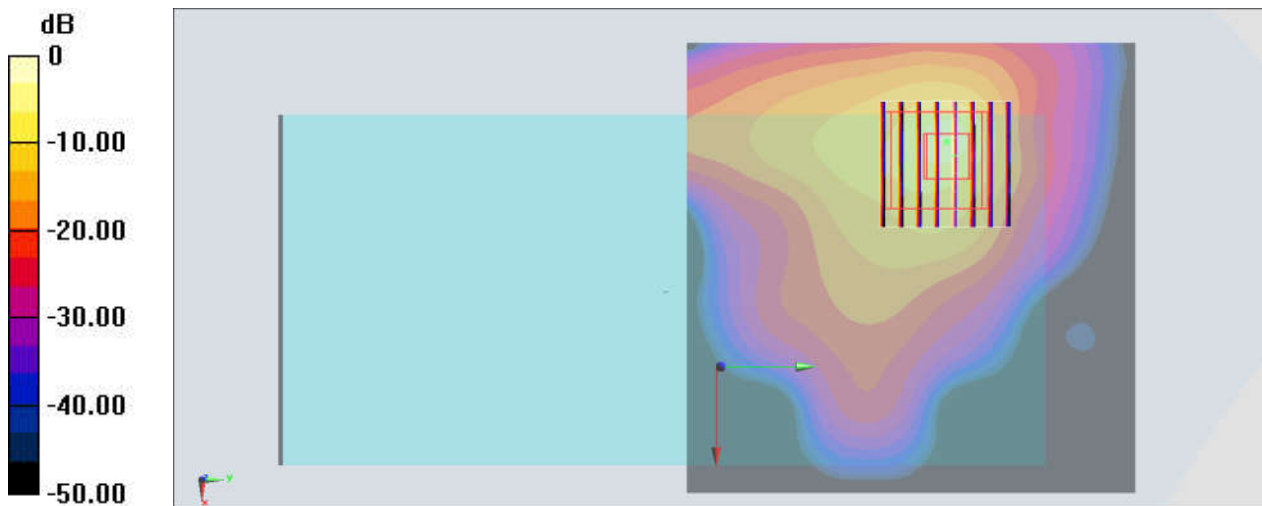

0 dB = 37.4 W/kg = 15.73 dBW/kg