



FCC RF Test Report

APPLICANT : Bullitt Group
EQUIPMENT : Rugged Smart Phone
BRAND NAME : CAT
MODEL NAME : S60
MARKETING NAME : S60
FCC ID : ZL5S60
STANDARD : FCC Part 15 Subpart C §15.225
CLASSIFICATION : (DXX) Low Power Communication Device Transmitter

The testing was completed on Mar. 03, 2016. We, SPORTON INTERNATIONAL INC., would like to declare that the tested sample has been evaluated in accordance with the test procedures and has been in compliance with the applicable technical standards.

The test results in this report apply exclusively to the tested model / sample. Without written approval of SPORTON INTERNATIONAL INC., the test report shall not be reproduced except in full.

Reviewed by: Joseph Lin / Supervisor

Approved by: Jones Tsai / Manager



SPORTON INTERNATIONAL INC.

No. 52, Hwa Ya 1st Rd., Hwa Ya Technology Park, Kwei-Shan District, Tao Yuan City, Taiwan, R.O.C.



Table of Contents

SUMMARY OF THE TEST RESULT4

1. GENERAL INFORMATION.....5

1.1 Applicant 5

1.2 Manufacturer..... 5

1.3 Product Details..... 5

1.4 Modification of EUT..... 5

1.5 Testing Location 6

1.6 Applicable Standards 6

1.7 Test Modes..... 6

1.8 Test Configurations..... 7

1.9 Table for Supporting Units 8

2. CONDUCTED EMISSION TEST.....9

2.1 Measuring Instruments 9

2.2 Test setup 9

2.3 Test Result of Conducted Emission Test..... 9

2.4 AC Power Line Conducted Emissions Measurement 10

3. CONDUCTED TEST ITEMS11

3.1 Measuring Instruments 11

3.2 Test Setup 11

3.3 Test Result of Conducted Test Items..... 11

3.4 20dB and 99% OBW Spectrum Bandwidth Measurement..... 12

3.5 Frequency Stability Measurement 12

4. RADIATED TEST ITEMS.....13

4.1 Measuring Instruments 13

4.2 Test Setup 13

4.3 Test Result of Radiated Test Items 13

4.4 Field Strength of Fundamental Emissions and Mask Measurement 14

4.5 Radiated Emissions Measurement 15

5. LIST OF MEASURING EQUIPMENT17

APPENDIX A. SETUP PHOTOGRAPHS OF EUT

APPENDIX B. TEST RESULTS OF CONDUCTED EMISSION TEST

APPENDIX C. TEST RESULTS OF CONDUCTED TEST ITEMS

C.1. Test Result of 20dB Spectrum Bandwidth

C.2 Test Result of Frequency Stability

APPENDIX D. TEST RESULTS OF RADIATED TEST ITEMS

D.1 Test Result of Field Strength of Fundamental Emissions

D.2 Results of Radiated Emissions (9 kHz~30MHz)

D.3 Results of Radiated Emissions (30MHz~1GHz)



REVISION HISTORY

REPORT NO.	VERSION	DESCRIPTION	ISSUED DATE
FR630110-01D	Rev. 01	Initial issue of report	Jun. 06, 2016



SUMMARY OF THE TEST RESULT

Applied Standard: 47 CFR FCC Part 15 Subpart C				
Part	FCC Rule	Description of Test	Result	Under Limit
3.1	15.207	AC Power Line Conducted Emissions	Complies	12.60 dB at 2.262 MHz
3.2	15.225(a)(b)(c)	Field Strength of Fundamental Emissions	Complies	64.55 dB at 13.561 MHz
3.3	2.1049	20dB Spectrum Bandwidth	Complies	-
3.3	-	99% OBW Spectrum Bandwidth	Complies	-
3.4	15.225(d) 15.209	Radiated Emissions	Complies	6.74 dB at 40.800 MHz
3.5	15.225(e)	Frequency Stability	Complies	-
3.6	15.203	Antenna Requirements	Complies	-

Test Items	Uncertainty	Remark
AC Power Line Conducted Emissions	±2.26dB	Confidence levels of 95%
Radiated Emissions (30MHz~1000MHz)	±4.80dB	Confidence levels of 95%



1. GENERAL INFORMATION

1.1 Applicant

Bullitt Group

One Valpy, Valpy Street, Reading, Berkshire, RG1 1AR United Kingdom

1.2 Manufacturer

Compal Electronics, INC.

No. 385, Yangguang St. Neihu District, Taipei City 11491, Taiwan, R.O.C

1.3 Product Details

Items	Description
Tx/Rx Frequency Range	13.553 ~ 13.567MHz
Channel Number	1
20dBW	2.64 KHz
99%OBW	2.24 KHz
Sample 1	EUT with Dual SIM
Sample 2	EUT with Singal SIM
Antenna Type	Coil Antenna (Single Loop)
Type of Modulation	ASK

Remark: The above EUT's information was declared by manufacturer. Please refer to the specifications or user's manual for more detailed description.

1.4 Modification of EUT

No modifications are made to the EUT during all test items.



1.5 Testing Location

Sporton Lab is accredited to ISO 17025 by Taiwan Accreditation Foundation (TAF code : 1190) and the FCC designation No. TW1022 under the FCC 2.948(e) by Mutual Recognition Agreement (MRA) in FCC Test.

Test Site	SPORTON INTERNATIONAL INC.		
Test Site Location	No. 52, Hwa Ya 1 st Rd., Hwa Ya Technology Park, Kwei-Shan District, Tao Yuan City, Taiwan, R.O.C. TEL: +886-3-3273456 / FAX: +886-3-3284978		
Test Site No.	Sporton Site No.		
	TH03-HY	CO05-HY	03CH07-HY
Test Engineer	Tommy Lee	Kai-Chun Chu	James Chiu
Temperature	22~24°C	22~23°C	21~23°C
Relative Humidity	53~55%	42~43%	55~58%

Note: The test site complies with ANSI C63.4 2014 requirement.

1.6 Applicable Standards

According to the specifications of the manufacturer, the EUT must comply with the requirements of the following standards:

- ♦ FCC Part 15 Subpart C §15.225
- ♦ ANSI C63.10-2013

1.7 Test Modes

Investigation has been done on all the possible configurations for searching the worst cases. The following table is a list of the test modes shown in this test report.

Test Items	
AC Power Line Conducted Emissions	Field Strength of Fundamental Emissions
20dB Spectrum Bandwidth	Frequency Stability
Radiated Emissions 9kHz~30MHz	Radiated Emissions 30MHz~1GHz
Note:	
1. The EUT was programmed to be in continuously transmitting mode.	
2. The ancillary equipment, NFC card, is used to make the EUT (NFC) continuously transmit at 13.56MHz and is placed around 3 cm gap to the EUT.	

1.8 Test Configurations

<AC Conducted Emissions>

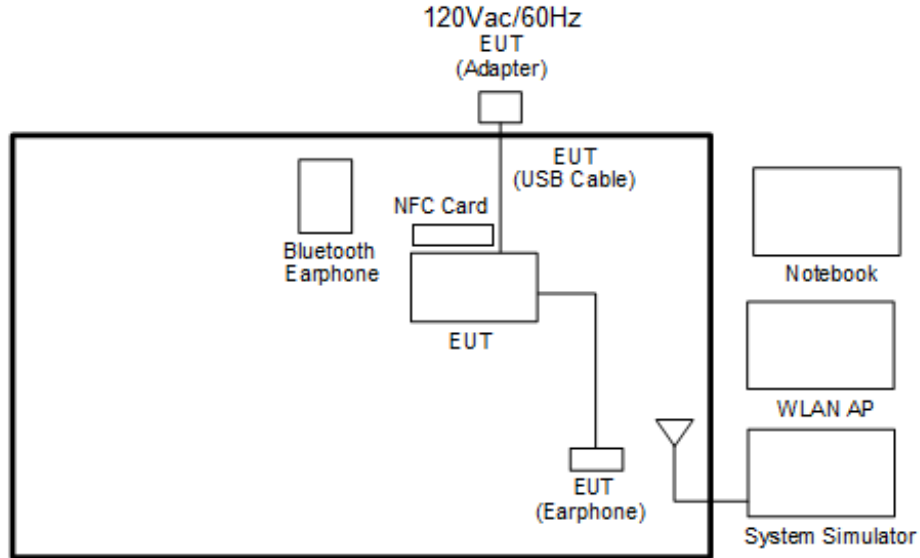

< For Fundamental Emissions and Mask and Radiated Emissions Measurement >

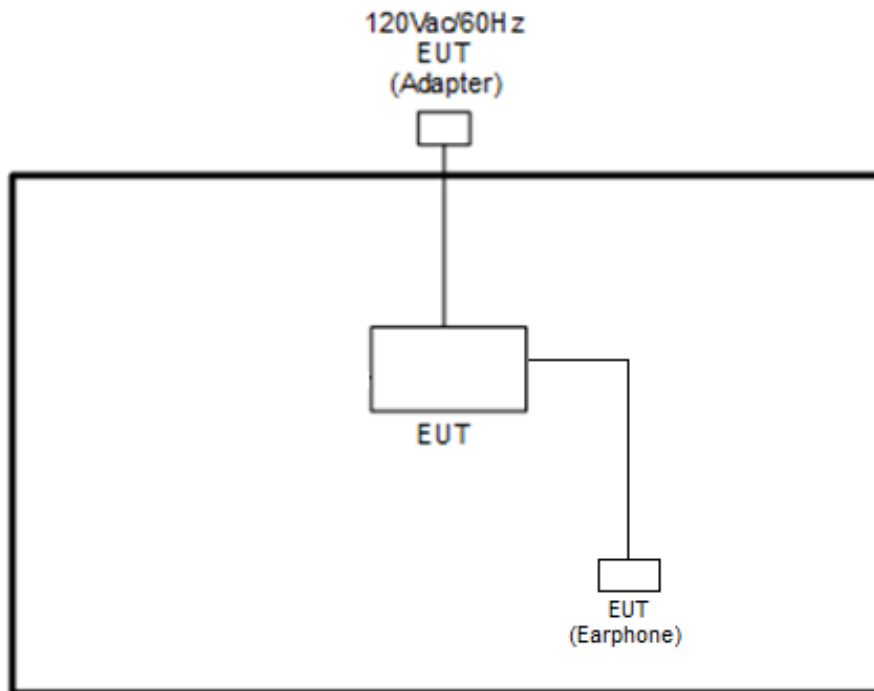



1.9 Table for Supporting Units

Support Unit	Manufacturer	Model	FCC ID
System Simulator	Anritsu	MT8820C	N/A
WLAN AP	D-Link	DIR-865L	KA2IR865LA1
Bluetooth Earphone	Sony Ericsson	MW600	PY7DDA-2029
Notebook	DELL	Latitude E6320	FCC DoC/ Contains FCC ID: QDS-BRCM1054
NFC Card	Metro Taipei	Easy Card	N/A
SD Card	SanDisk	MicroSD HC	FCC DoC

2. CONDUCTED EMISSION TEST

2.1 Measuring Instruments

See list of measuring instruments of this test report.

2.2 Test setup

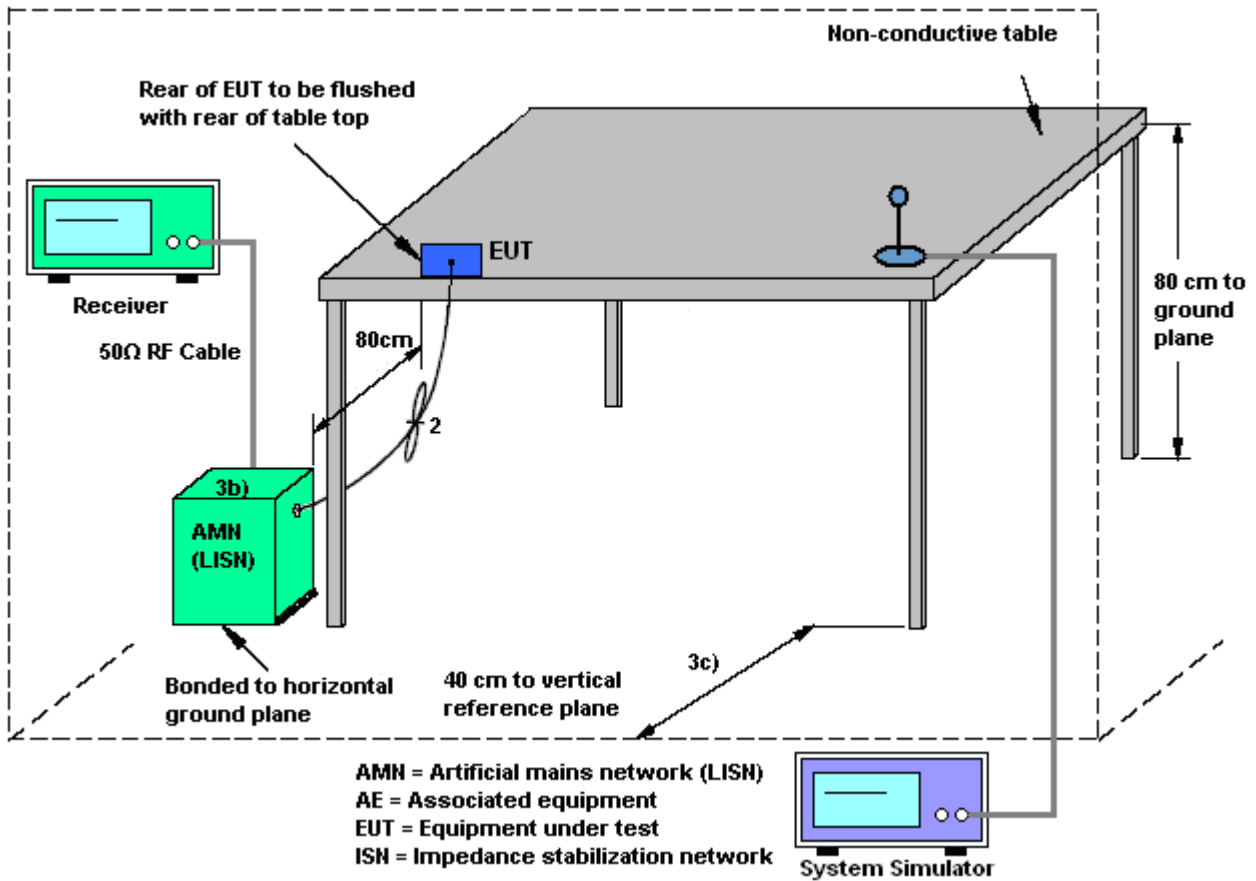

2.3 Test Result of Conducted Emission Test

Please refer to Appendix B.



2.4 AC Power Line Conducted Emissions Measurement

2.4.1 Limit

For equipment that is designed to be connected to the public utility (AC) power line, the radio frequency voltage that is conducted back onto the AC power line on any frequency or frequencies within the band 150 kHz to 30 MHz shall not exceed the limits in the following table.

Frequency of Emission (MHz)	Conducted Limit (dB μ V)	
	Quasi-Peak	Average
0.15-0.5	66 to 56*	56 to 46*
0.5-5	56	46
5-30	60	50

*Decreases with the logarithm of the frequency.

2.4.2 Test Procedures

1. The EUT was placed 0.4 meter from the conducting wall of the shielding room, and it was kept at least 80 centimeters from any other grounded conducting surface.
2. Connect EUT to the power mains through a line impedance stabilization network (LISN).
3. All the support units are connecting to the other LISN.
4. The LISN provides 50 ohm coupling impedance for the measuring instrument.
5. The FCC states that a 50 ohm, 50 microhenry LISN should be used.
6. Both sides of AC line were checked for maximum conducted interference.
7. The frequency range from 150 kHz to 30 MHz was searched.
8. Set the test-receiver system to Peak Detect Function and specified bandwidth (IF Bandwidth = 9kHz) with Maximum Hold Mode. Then measurement is also conducted by Average Detector and Quasi-Peak Detector Function respectively.

3. CONDUCTED TEST ITEMS

3.1 Measuring Instruments

See list of measuring instruments of this test report.

3.2 Test Setup

3.2.1 20dB and 99% OBW Spectrum Bandwidth

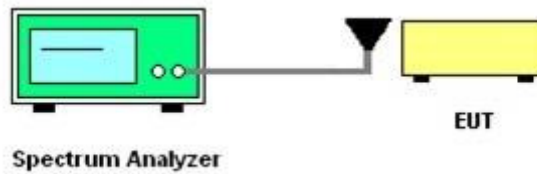

3.2.2 Frequency Stability

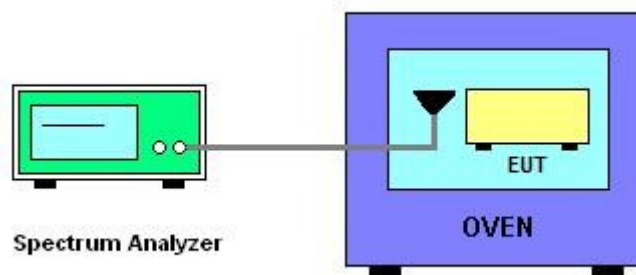

3.3 Test Result of Conducted Test Items

Please refer to Appendix C.



3.4 20dB and 99% OBW Spectrum Bandwidth Measurement

3.4.1 Limit

Intentional radiators must be designed to ensure that the 20dB and 99% emission bandwidth in the specific band 13.553~13.567MHz.

3.4.2 Test Procedures

1. The spectrum analyzer connected via a receive antenna placed near the EUT in peak Max hold mode.
2. The resolution bandwidth of 1 kHz and the video bandwidth of 3 kHz were used.
3. Measured the spectrum width with power higher than 20dB below carrier.
4. Measured the 99% OBW.

3.5 Frequency Stability Measurement

3.5.1 Limit

The frequency tolerance of the carrier signal shall be maintained within +/- 0.01% (100ppm) of the operating frequency over a temperature variation of -20 degrees to +50 degrees C at normal supply voltage, and for a variation in the primary supply voltage from 85% to 115% of the rated supply voltage at a temperature of 20 degrees C. For battery operated equipment, the equipment tests shall be performed using a new battery.

3.5.2 Test Procedures

1. The spectrum analyzer connected via a receive antenna placed near the EUT.
2. EUT have transmitted signal and fixed channelize.
3. Set the spectrum analyzer span to view the entire emissions bandwidth.
4. Set RBW = 1 kHz, VBW = 3 kHz with peak detector and maxhold settings.
5. The fc is declaring of channel frequency. Then the frequency error formula is $(f_c - f) / f_c \times 10^6$ ppm and the limit is less than ± 100 ppm.
6. Extreme temperature rule is -20°C~50°C.

4. RADIATED TEST ITEMS

4.1 Measuring Instruments

See list of measuring instruments of this test report.

4.2 Test Setup

4.2.1 For radiated emissions below 30MHz

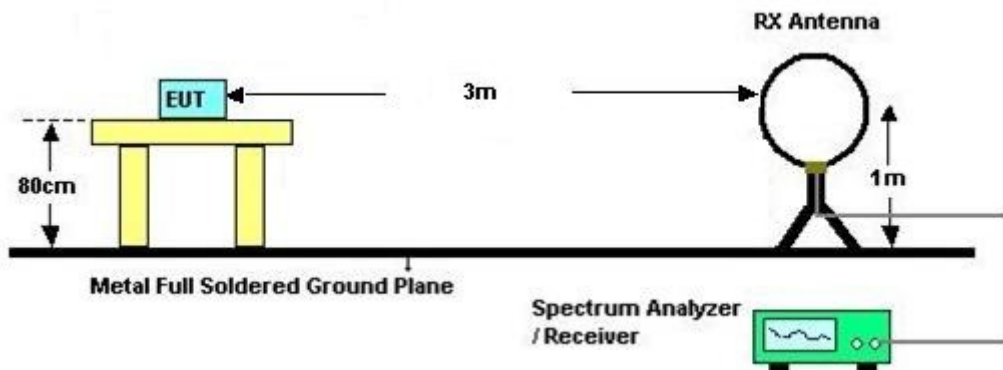

4.2.2 For radiated emissions above 30MHz

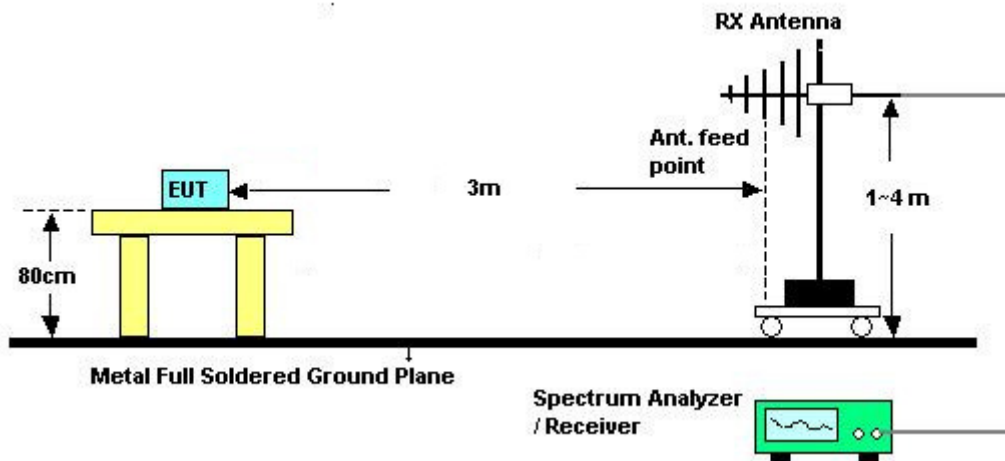

4.3 Test Result of Radiated Test Items

Please refer to Appendix D.



4.4 Field Strength of Fundamental Emissions and Mask Measurement

4.4.1 Limit

Rules and specifications	FCC CFR 47 Part 15 section 15.225 IC RSS-210 A2.6			
	Description			
Description	Compliance with the spectrum mask is tested with RBW set to 9kHz.			
Freq. of Emission (MHz)	Field Strength (μV/m) at 30m	Field Strength (dBμV/m) at 30m	Field Strength (dBμV/m) at 10m	Field Strength (dBμV/m) at 3m
1.705~13.110	30	29.5	48.58	69.5
13.110~13.410	106	40.5	59.58	80.5
13.410~13.553	334	50.5	69.58	90.5
13.553~13.567	15848	84.0	103.08	124.0
13.567~13.710	334	50.5	69.58	90.5
13.710~14.010	106	40.5	59.58	80.5
14.010~30.000	30	29.5	48.58	69.5

4.4.2 Test Procedures

1. Configure the EUT according to ANSI C63.10. The EUT was placed on the top of the turntable 0.8 meter above ground. The phase center of the loop receiving antenna mounted antenna tower was placed 3 meters far away from the turntable.
2. Power on the EUT and all the supporting units. The turntable was rotated by 360 degrees to determine the position of the highest radiation.
3. The height of the receiving antenna was fixed at one meter above ground to find the maximum emissions field strength.
4. For Fundamental emissions, use the receiver to measure QP reading.
5. When the radiated emissions limits are expressed in terms of the average value of the emissions, and pulsed operation is employed, the measurement field strength shall be determined by averaging over one complete pulse train, including blanking intervals, as long as the pulse train does not exceed 0.1 seconds. As an alternative (provided the transmitter operates for longer than 0.1 seconds) or in cases where the pulse train exceeds 0.1 seconds, the measured field strength shall be determined from the average absolute voltage during a 0.1 second interval during which the field strength is at its maximum value.
6. Compliance with the spectrum mask is tested with RBW set to 9kHz.

Note: Emission level (dBμV/m) = 20 log Emission level (μV/m).



4.5 Radiated Emissions Measurement

4.5.1 Limit

The field strength of any emissions which appear outside of 13.110 ~14.010MHz band shall not exceed the general radiated emissions limits.

Frequencies (MHz)	Field Strength (µV/m)	Measurement Distance (meters)
0.009~0.490	2400/F(kHz)	300
0.490~1.705	24000/F(kHz)	30
1.705~30.0	30	30
30~88	100	3
88~216	150	3
216~960	200	3
Above 960	500	3

4.5.2 Measuring Instrument Setting

The following table is the setting of receiver.

Receiver Parameter	Setting
Attenuation	Auto
Frequency Range: 9kHz~150kHz	RBW 200Hz for QP
Frequency Range: 150kHz~30MHz	RBW 9kHz for QP
Frequency Range: 30MHz~1000MHz	RBW 120kHz for Peak

Note: The emission limits shown in the above table are based on measurements employing a CISPR quasi-peak detector except for the frequency bands 9-90 kHz, 110-490 kHz. Radiated emission limits in these two bands are based on measurements employing an average detector.



4.5.3 Test Procedures

1. Configure the EUT according to ANSI C63.10. The EUT was placed on the top of the turntable 0.8 meter above ground. The phase center of the receiving antenna mounted on the top of a height-variable antenna tower was placed 3 meters far away from the turntable.
2. Power on the EUT and all the supporting units. The turntable was rotated by 360 degrees to determine the position of the highest radiation.
3. The height of the broadband receiving antenna was varied between one meter and four meters above ground to find the maximum emissions field strength of both horizontal and vertical polarization.
4. For each suspected emissions, the antenna tower was scan (from 1 M to 4 M) and then the turntable was rotated (from 0 degree to 360 degrees) to find the maximum reading.
5. Set the test-receiver system to Peak or CISPR quasi-peak Detect Function with specified bandwidth under Maximum Hold Mode.
6. When the radiated emissions limits are expressed in terms of the average value of the emissions, and pulsed operation is employed, the measurement field strength shall be determined by averaging over one complete pulse train, including blanking intervals, as long as the pulse train does not exceed 0.1 seconds. As an alternative (provided the transmitter operates for longer than 0.1 seconds) or in cases where the pulse train exceeds 0.1 seconds, the measured field strength shall be determined from the average absolute voltage during a 0.1 second interval during which the field strength is at its maximum value.
7. In case the emission is lower than 30MHz, loop antenna has to be used for measurement and the recorded data should be QP measured by receiver. Antenna Requirements

4.5.4 Limit

Except for special regulations, the Low-power Radio-frequency Devices must not be equipped with any jacket for installing an antenna with extension cable. An intentional radiator shall be designed to ensure that no antenna other than that furnished by the responsible party shall be used with the device. The use of a permanently attached antenna or of an antenna that uses a unique coupling to the intentional radiator shall be considered sufficient to comply with the provisions of this Section. The manufacturer may design the unit so that the user can replace a broken antenna, but the use of a standard antenna jack or electrical connector is prohibited.

4.5.5 Antenna Anti-Replacement Construction

An embedded-in antenna design is used.



5. LIST OF MEASURING EQUIPMENT

Instrument	Manufacturer	Model No.	Serial No.	Characteristics	Calibration Date	Test Date	Due Date	Remark
AC Power Source	AC POWER	AFC-500W	F104070011	50Hz~60Hz	Dec. 02, 2015	May 20, 2016	Dec. 01, 2016	Conducted (TH03-HY)
Spectrum Analyzer	Rohde & Schwarz	FSP30	101329	9kHz~30GHz	Jun. 24, 2015	May 20, 2016	Jun. 23, 2016	Conducted (TH03-HY)
Temperature Chamber	ESPEC	SU-641	92013721	-30℃ ~70℃	Nov. 20, 2015	May 20, 2016	Nov. 19, 2016	Conducted (TH03-HY)
AC Power Source	ChainTek	APC-1000W	N/A	N/A	N/A	May 12, 2016 ~ May 21, 2016	N/A	Conduction (CO05-HY)
EMI Test Receiver	Rohde & Schwarz	ESCI 7	100724	9kHz~7GHz	Aug. 26, 2015	May 12, 2016 ~ May 21, 2016	Aug. 25, 2016	Conduction (CO05-HY)
LISN	Rohde & Schwarz	ENV216	100080	9kHz~30MHz	Dec. 02, 2015	May 12, 2016 ~ May 21, 2016	Dec. 01, 2016	Conduction (CO05-HY)
Bilog Antenna	TESEQ	CBL 6111D	35419	30MHz to 1GHz	Jan. 13, 2016	May 15, 2016	Jan. 12, 2017	Radiation (03CH07-HY)
EMI Test Receiver	Keysight	N9038A (MXE)	MY54130085	20Hz ~ 8.4GHz	Nov. 04, 2015	May 15, 2016	Nov. 03, 2016	Radiation (03CH07-HY)
Loop Antenna	Rohde & Schwarz	HFH2-Z2	100315	9 kHz~30 MHz	Sep. 02, 2015	May 15, 2016	Sep. 01, 2016	Radiation (03CH07-HY)
Spectrum Analyzer	Agilent	N9010A	MY53470118	10Hz~44GHz	Feb. 27, 2016	May 15, 2016	Feb. 26, 2017	Radiation (03CH07-HY)
Antenna Mast	Max-Full	MFA520BS	N/A	1m~4m	N/A	May 15, 2016	N/A	Radiation (03CH07-HY)
Turn Table	ChainTek	Chaintek 3000	N/A	0~360 Degree	N/A	May 15, 2016	N/A	Radiation (03CH07-HY)
Preamplifier	COM-POWER	PA-103A	161241	10MHz~1GHz	Mar. 18, 2016	May 15, 2016	Mar. 17, 2017	Radiation (03CH07-HY)

Appendix B. Test Results of Conducted Emission Test

< Original Test Result >

Test Mode :	NFC Tx	Test Voltage :	120Vac / 60Hz
Function Type :	GSM850 Idle + Bluetooth Link + WLAN Link + USB Cable (Charging from Adapter) + NFC Tx		

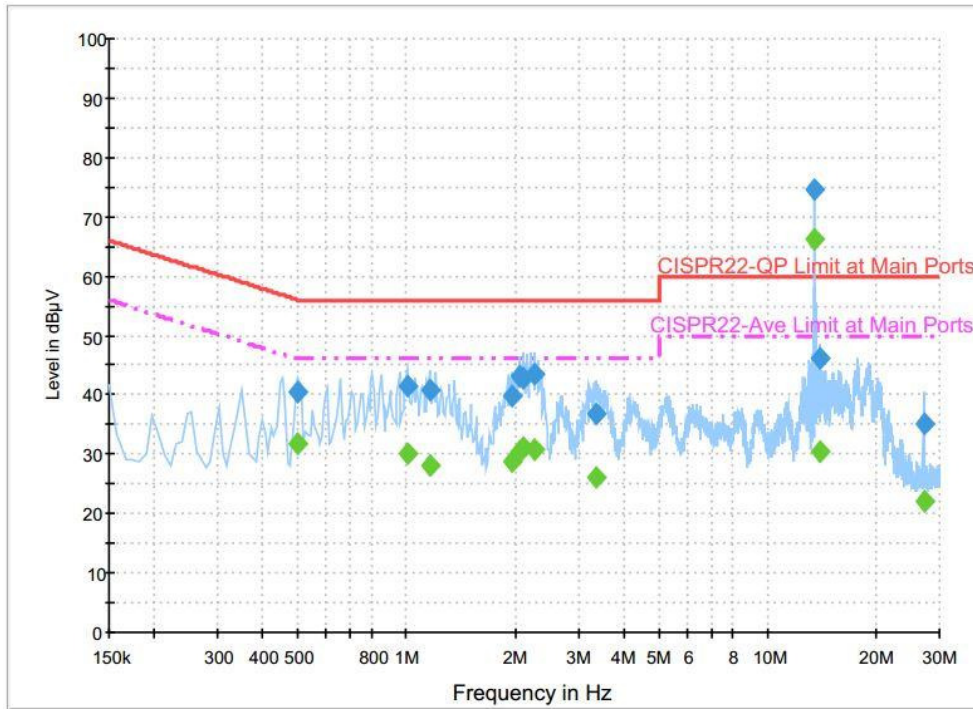

Final Result : Quasi-Peak

Frequency (MHz)	Quasi-Peak (dBµV)	Filter	Line	Corr. (dB)	Margin (dB)	Limit (dBµV)
0.502000	40.4	Off	L1	19.6	15.6	56.0
1.006000	41.6	Off	L1	19.7	14.4	56.0
1.158000	40.9	Off	L1	19.7	15.1	56.0
1.958000	39.8	Off	L1	19.7	16.2	56.0
2.062000	43.1	Off	L1	19.6	12.9	56.0
2.110000	42.9	Off	L1	19.6	13.1	56.0
2.262000	43.4	Off	L1	19.6	12.6	56.0
3.366000	36.8	Off	L1	19.7	19.2	56.0
13.558000	74.6	Off	L1	20.3	-14.6	60.0
14.014000	46.1	Off	L1	20.3	13.9	60.0
27.118000	35.1	Off	L1	21.0	24.9	60.0



Test Mode :	NFC Tx	Test Voltage :	120Vac / 60Hz
Function Type :	GSM850 Idle + Bluetooth Link + WLAN Link + USB Cable (Charging from Adapter) + NFC Tx		

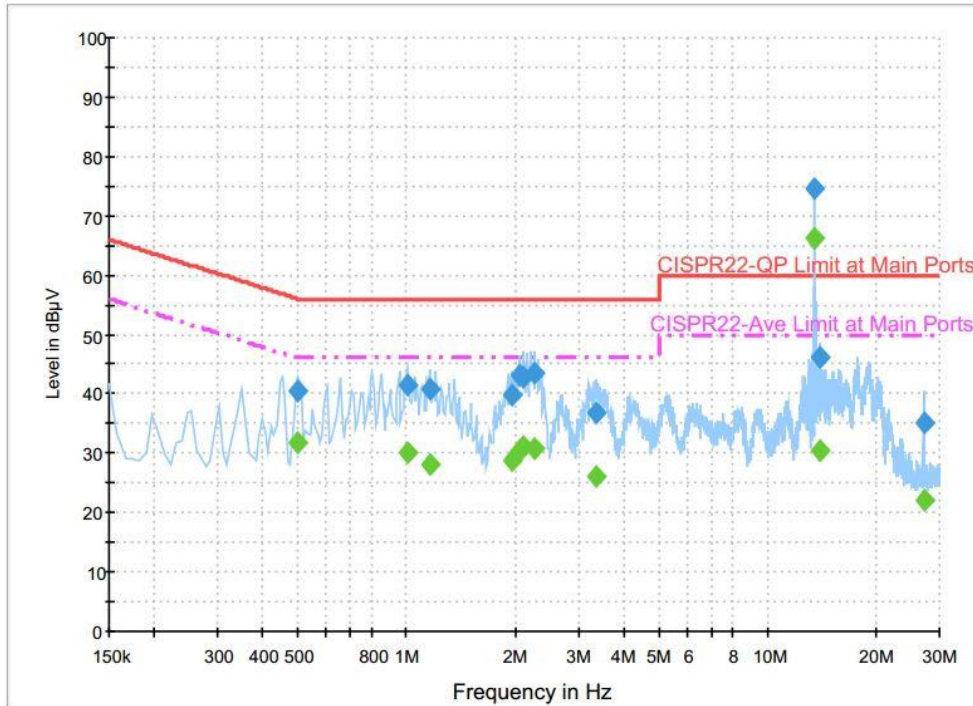

Final Result : Average

Frequency (MHz)	Average (dBµV)	Filter	Line	Corr. (dB)	Margin (dB)	Limit (dBµV)
0.502000	31.9	Off	L1	19.6	14.1	46.0
1.006000	30.0	Off	L1	19.7	16.0	46.0
1.158000	28.1	Off	L1	19.7	17.9	46.0
1.958000	28.9	Off	L1	19.7	17.1	46.0
2.062000	30.3	Off	L1	19.6	15.7	46.0
2.110000	31.1	Off	L1	19.6	14.9	46.0
2.262000	30.9	Off	L1	19.6	15.1	46.0
3.366000	26.1	Off	L1	19.7	19.9	46.0
13.558000	66.1	Off	L1	20.3	-16.1	50.0
14.014000	30.3	Off	L1	20.3	19.7	50.0
27.118000	22.2	Off	L1	21.0	27.8	50.0



Test Mode :	NFC Tx	Test Voltage :	120Vac / 60Hz
Function Type :	GSM850 Idle + Bluetooth Link + WLAN Link + USB Cable (Charging from Adapter) + NFC Tx		

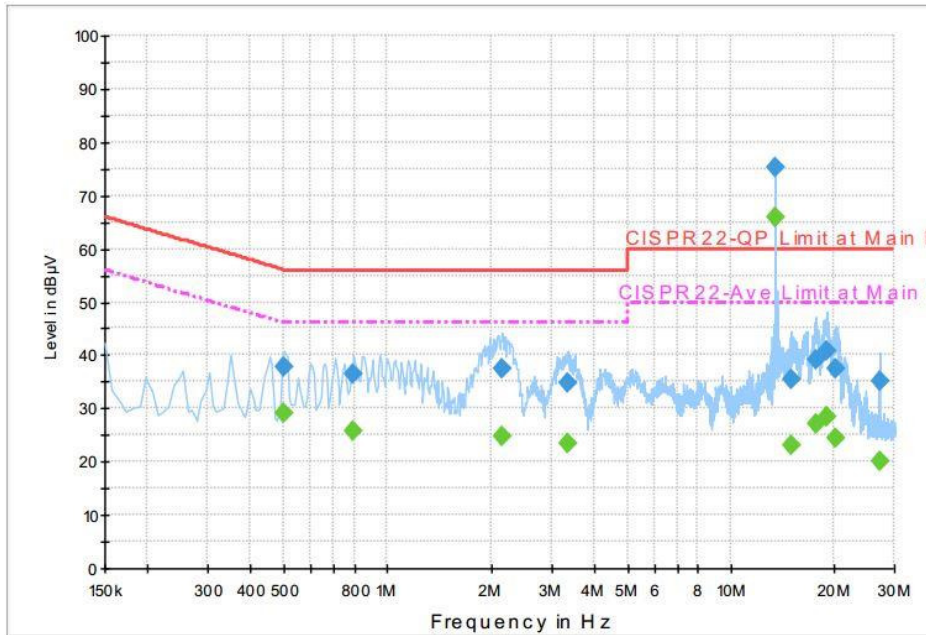

Final Result : Quasi-Peak

Frequency (MHz)	Quasi-Peak (dBµV)	Filter	Line	Corr. (dB)	Margin (dB)	Limit (dBµV)
0.502000	37.7	Off	N	19.6	18.3	56.0
0.798000	36.3	Off	N	19.6	19.7	56.0
2.166000	37.4	Off	N	19.6	18.6	56.0
3.374000	34.9	Off	N	19.7	21.1	56.0
13.558000	75.4	Off	N	20.3	-15.4	60.0
15.070000	35.6	Off	N	20.4	24.4	60.0
17.718000	39.0	Off	N	20.6	21.0	60.0
18.990000	40.7	Off	N	20.7	19.3	60.0
20.310000	37.4	Off	N	20.8	22.6	60.0
27.118000	35.1	Off	N	21.2	24.9	60.0



Test Mode :	NFC Tx	Test Voltage :	120Vac / 60Hz
Function Type :	GSM850 Idle + Bluetooth Link + WLAN Link + USB Cable (Charging from Adapter) + NFC Tx		

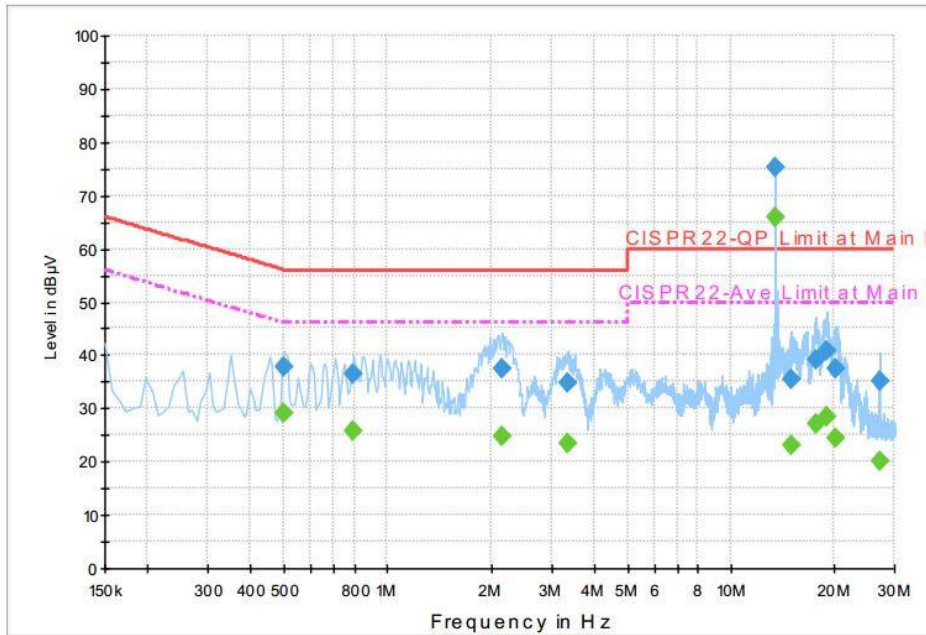

Final Result : Average

Frequency (MHz)	Average (dBµV)	Filter	Line	Corr. (dB)	Margin (dB)	Limit (dBµV)
0.502000	29.3	Off	N	19.6	16.7	46.0
0.798000	25.8	Off	N	19.6	20.2	46.0
2.166000	24.6	Off	N	19.6	21.4	46.0
3.374000	23.4	Off	N	19.7	22.6	46.0
13.558000	66.0	Off	N	20.3	-16.0	50.0
15.070000	22.9	Off	N	20.4	27.1	50.0
17.718000	27.2	Off	N	20.6	22.8	50.0
18.990000	28.3	Off	N	20.7	21.7	50.0
20.310000	24.5	Off	N	20.8	25.5	50.0
27.118000	20.1	Off	N	21.2	29.9	50.0



< Terminal Test Result >

Test Mode :	NFC Tx	Test Voltage :	120Vac / 60Hz
Function Type :	GSM850 Idle + Bluetooth Link + WLAN Link + USB Cable (Charging from Adapter) + NFC Tx		

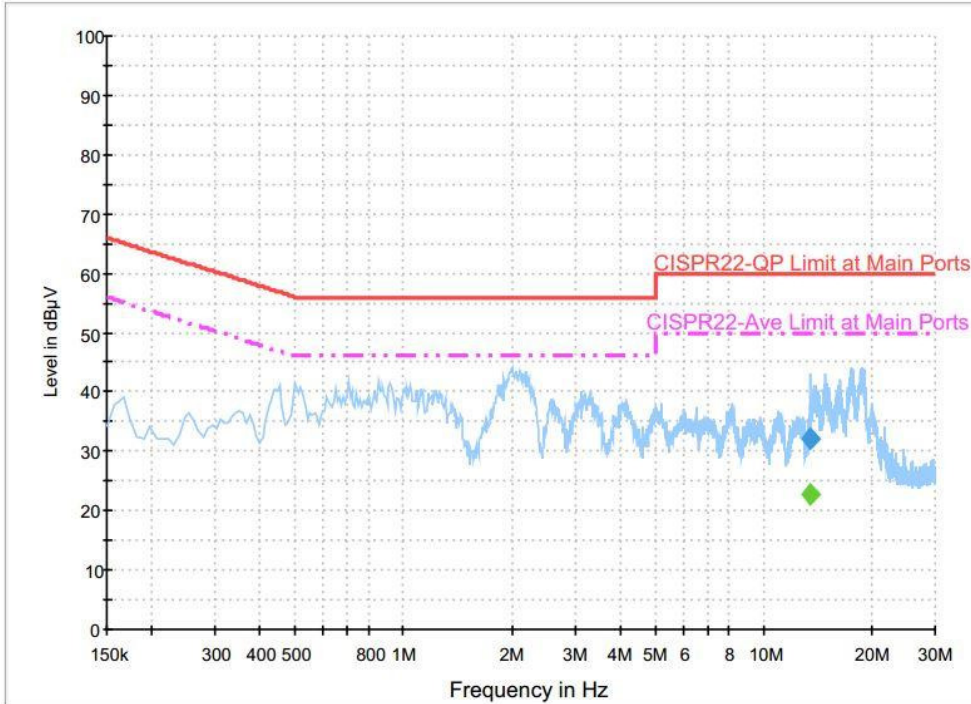

Final Result : Quasi-Peak

Frequency (MHz)	Quasi-Peak (dBµV)	Filter	Line	Corr. (dB)	Margin (dB)	Limit (dBµV)
13.558000	32.1	Off	L1	20.3	27.9	60.0

Final Result : Average

Frequency (MHz)	Average (dBµV)	Filter	Line	Corr. (dB)	Margin (dB)	Limit (dBµV)
13.558000	22.7	Off	L1	20.3	27.3	50.0



Test Mode :	NFC Tx	Test Voltage :	120Vac / 60Hz
Function Type :	GSM850 Idle + Bluetooth Link + WLAN Link + USB Cable (Charging from Adapter) + NFC Tx		

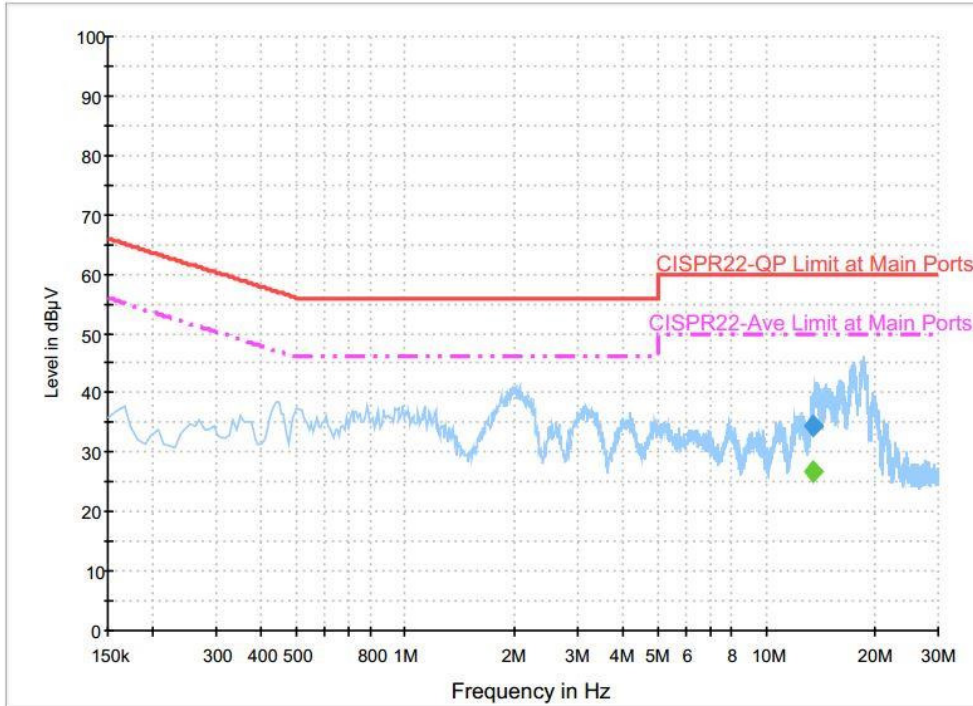

Final Result : Quasi-Peak

Frequency (MHz)	Quasi-Peak (dBµV)	Filter	Line	Corr. (dB)	Margin (dB)	Limit (dBµV)
13.558000	34.6	Off	N	20.3	25.4	60.0

Final Result : Average

Frequency (MHz)	Average (dBµV)	Filter	Line	Corr. (dB)	Margin (dB)	Limit (dBµV)
13.558000	26.6	Off	N	20.3	23.4	50.0

(1) with antenna

Remark: 13.558MHz is the NFC RF fundamental signal.

(2) with dummy load

Remark: Only the fundamental NFC signal needs to be retested per C63.4.



Appendix C. Test Results of Conducted Test Items

C.1 Test Result of 20dB Spectrum Bandwidth

Test mode	NFC Tx	Test Frequency (MHz)	13.56
Date: 20.MAY.2016 11:29:58		Date: 20.MAY.2016 11:42:11	
20dB Bandwidth (kHz)	2.64	99% OccupiedBW(kHz)	2.24
Frequency range (MHz)	$f_L > 13.553$	13.55924	Test Result
	$f_H < 13.567$	13.56188	Complies



C.2 Test Result of Frequency Stability

Voltage vs. Frequency Stability		Temperature vs. Frequency Stability		
Voltage (Vac)	Measurement Frequency (MHz)	Temperature (°C)	Time	Measurement Frequency (MHz)
120	13.560560	-20	0	13.560620
102	13.560560		2	13.560620
138	13.560560		5	13.560620
			10	13.560360
		-10	0	13.560620
			2	13.560600
			5	13.560600
			10	13.560600
		0	0	13.560640
			2	13.560620
			5	13.560620
			10	13.560600
		10	0	13.560600
			2	13.560600
			5	13.560580
			10	13.560580
		20	0	13.560600
			2	13.560580
			5	13.560570
			10	13.560560
		30	0	13.560560
			2	13.560560
			5	13.560560
			10	13.560560
		40	0	13.560540
			2	13.560550
			5	13.560560
			10	13.560560



Voltage vs. Frequency Stability		Temperature vs. Frequency Stability		
Voltage (Vac)	Measurement Frequency (MHz)	Temperature (°C)	Time	Measurement Frequency (MHz)
		50	0	13.560540
			2	13.560540
			5	13.560540
			10	13.560560
Max.Deviation (MHz)	0.000560	Max.Deviation (MHz)		0.000640
Max.Deviation (ppm)	41.2979	Max.Deviation (ppm)		47.1976
Limit	FS < ±100 ppm	Limit		FS < ±100 ppm
Test Result	PASS	Test Result		PASS



Appendix D. Test Results of Radiated Test Items

D.1 Test Result of Field Strength of Fundamental Emissions

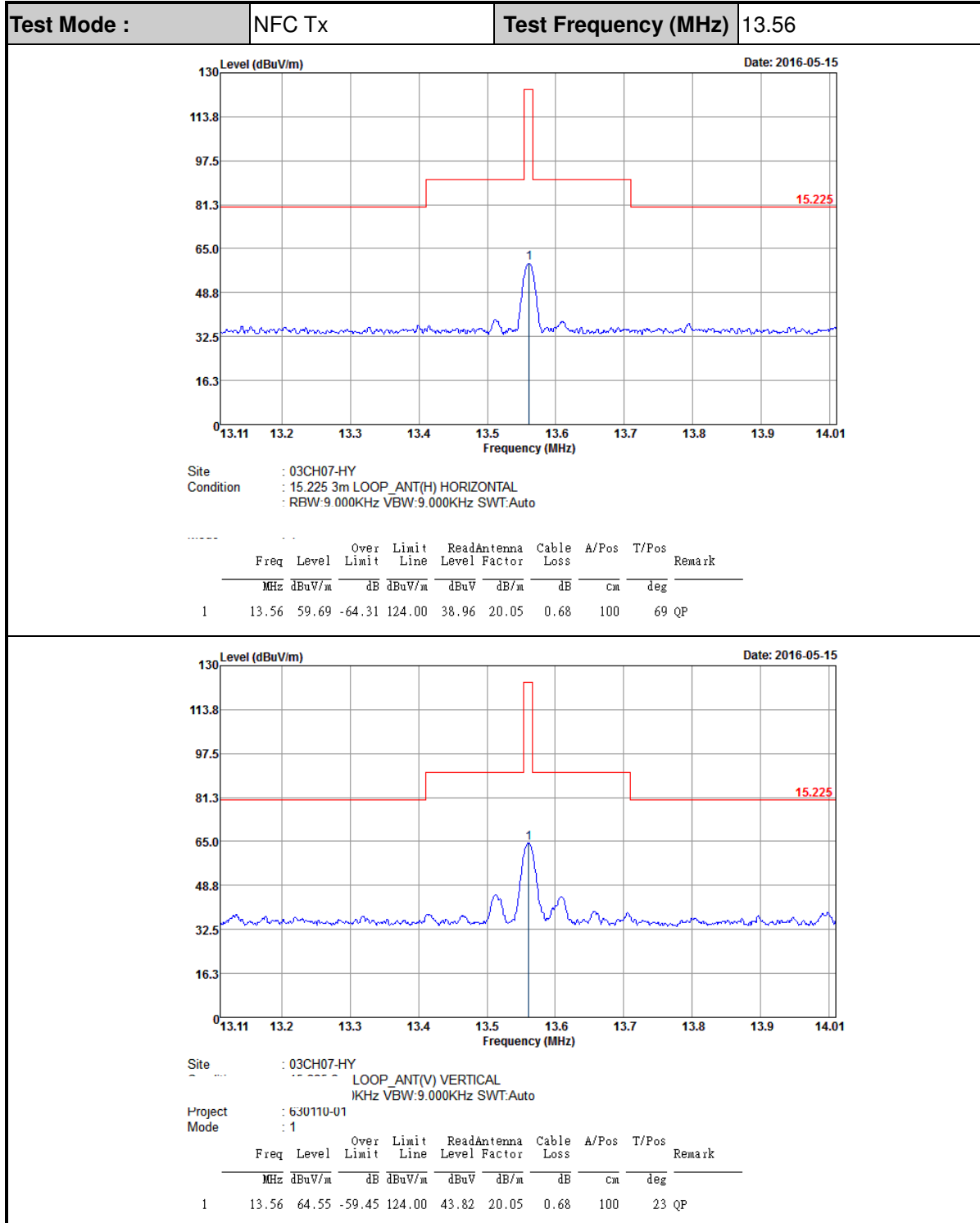

Note: All NFC's spurious emissions are below 20dB of limits.



D.2 Results of Radiated Emissions (9 kHz~30MHz)

Test Mode :		NFC Tx			Polarization :		Horizontal		
Frequency (MHz)	Level (dBμV/m)	Over Limit (dB)	Limit Line (dBμV/m)	Read Level (dBμV)	Antenna Factor (dB)	Cable Loss (dB)	Ant Pos (cm)	Table Pos (deg)	Remark
0.04786	51.94	-62.06	114	31.17	20.09	0.68	-	-	Average
0.06462	51.63	-59.77	111.4	30.91	20.04	0.68	-	-	Average
0.09278	44.18	-64.08	108.26	23.51	19.99	0.68	-	-	QP
0.12924	50.55	-54.83	105.38	29.9	19.97	0.68	-	-	Average
0.19284	40.44	-61.46	101.9	19.83	19.93	0.68	-	-	Average
0.50502	42.04	-31.5	73.54	21.46	19.9	0.68	-	-	QP
10.192	38.04	-31.46	69.5	17.33	20.03	0.68	100	0	QP
13.56	55.62	-13.88	69.5	34.89	20.05	0.68	-	-	QP
24.667	37.61	-31.89	69.5	15.96	20.58	1.07	-	-	QP
27.465	37.09	-32.41	69.5	15.4	20.62	1.07	-	-	QP

Test Mode :		NFC Tx			Polarization :		Vertical		
Frequency (MHz)	Level (dBμV/m)	Over Limit (dB)	Limit Line (dBμV/m)	Read Level (dBμV)	Antenna Factor (dB)	Cable Loss (dB)	Ant Pos (cm)	Table Pos (deg)	Remark
0.04853	44.22	-69.67	113.89	23.45	20.09	0.68	-	-	Average
0.07461	46.39	-63.76	110.15	25.67	20.04	0.68	-	-	Average
0.09734	48.14	-59.7	107.84	27.47	19.99	0.68	-	-	QP
0.14552	44.91	-59.44	104.35	24.28	19.95	0.68	-	-	Average
0.15102	44.94	-59.08	104.02	24.31	19.95	0.68	-	-	Average
0.49	42.63	-31.17	73.8	22.05	19.9	0.68	-	-	QP
12.584	37.53	-31.97	69.5	16.79	20.06	0.68	-	-	QP
13.56	64.28	-5.22	69.5	43.55	20.05	0.68	-	-	QP
18.25	39.37	-30.13	69.5	18.45	20.24	0.68	100	0	QP
25.655	38	-31.5	69.5	16.32	20.61	1.07	-	-	QP

Note:

1. 13.56 MHz is fundamental signal which can be ignored.
2. The amplitude of spurious emissions which are attenuated by more than 20dB below the permissible value has no need to be reported.
3. Distance extrapolation factor = 40 log (specific distance / test distance) (dB);
4. Limit line = specific limits (dBμV) + distance extrapolation factor.



D.3 Results of Radiated Emissions (30MHz~1GHz)

Test Mode :	NFC Tx	Polarization :	Horizontal
-------------	--------	----------------	------------

Frequency (MHz)	Level (dBμV/m)	Over Limit (dB)	Limit Line (dBμV/m)	Read Level (dBμV)	Antenna Factor (dB)	Cable Loss (dB)	Preamp Factor (dB)	Ant Pos (cm)	Table Pos (deg)	Remark
30.27	28.07	-11.93	40	32.35	26	1.07	31.35	-	-	Peak
94.8	36.28	-7.22	43.5	50.78	15.75	1.28	31.53	100	0	Peak
149.07	27.36	-16.14	43.5	39.35	17.73	1.78	31.5	-	-	Peak
321.7	26.03	-19.97	46	34.45	20.42	2.41	31.25	-	-	Peak
640.9	29.47	-16.53	46	30.87	25.81	3.57	30.78	-	-	Peak
979	33.81	-20.19	54	30	30.26	4.07	30.52	-	-	Peak

Test Mode :	NFC Tx	Polarization :	Vertical
-------------	--------	----------------	----------

Frequency (MHz)	Level (dBμV/m)	Over Limit (dB)	Limit Line (dBμV/m)	Read Level (dBμV)	Antenna Factor (dB)	Cable Loss (dB)	Preamp Factor (dB)	Ant Pos (cm)	Table Pos (deg)	Remark
40.8	33.26	-6.74	40	43.84	19.84	1.07	31.49	100	0	Peak
94.8	36.06	-7.44	43.5	50.56	15.75	1.28	31.53	-	-	Peak
149.07	27.5	-16	43.5	39.49	17.73	1.78	31.5	-	-	Peak
502.3	26.79	-19.21	46	30.45	24.22	3.14	31.02	-	-	Peak
678	30.14	-15.86	46	31.05	26.18	3.65	30.74	-	-	Peak
881	33.72	-12.28	46	31.22	28.88	4.17	30.55	-	-	Peak

Note:

1. The amplitude of spurious emissions which are attenuated by more than 20dB below the permissible value has no need to be reported.
2. Emission level (dBμV/m) = 20 log Emission level (μV/m).
3. Corrected Reading: Antenna Factor + Cable Loss + Read Level - Preamp Factor= Level.