



# FCC RF Test Report

APPLICANT : Bullitt Group  
EQUIPMENT : Rugged Smart Phone  
BRAND NAME : CAT  
MODEL NAME : S60  
MARKETING NAME : S60  
FCC ID : ZL5S60  
STANDARD : FCC 47 CFR Part 2, 22(H), 24(E), 27(L)  
CLASSIFICATION : PCS Licensed Transmitter Held to Ear (PCE)

The product was received on Mar. 03, 2016 and testing was completed on Jun. 02, 2016. We, SPORTON INTERNATIONAL INC., would like to declare that the tested sample has been evaluated in accordance with the test procedures given in ANSI / TIA / EIA-603-D-2010 and has been in compliance with the applicable technical standards.

The test results in this report apply exclusively to the tested model / sample. Without written approval of SPORTON INTERNATIONAL INC., the test report shall not be reproduced except in full.

Reviewed by: Joseph Lin / Supervisor

Approved by: Jones Tsai / Manager



## SPORTON INTERNATIONAL INC.

No. 52, Hwa Ya 1<sup>st</sup> Rd., Hwa Ya Technology Park, Kwei-Shan District, Tao Yuan City, Taiwan, R.O.C.

SPORTON INTERNATIONAL INC.

TEL : 886-3-327-3456

FAX : 886-3-328-4978

FCC ID : ZL5S60

Page Number : 1 of 24

Report Issued Date : Jun. 06, 2016

Report Version : Rev. 01

Report Template No.: BU5-FG22/24/27/90 Version 1.1



# TABLE OF CONTENTS

**REVISION HISTORY.....3**

**SUMMARY OF TEST RESULT .....4**

**1 GENERAL DESCRIPTION .....6**

1.1 Applicant.....6

1.2 Manufacturer .....6

1.3 Product Feature of Equipment Under Test .....6

1.4 Product Specification of Equipment Under Test .....7

1.5 Modification of EUT .....7

1.6 Maximum ERP/EIRP Power, Frequency Tolerance, and Emission Designator .....8

1.7 Testing Location .....8

1.8 Applicable Standards .....9

**2 TEST CONFIGURATION OF EQUIPMENT UNDER TEST .....10**

2.1 Test Mode.....10

2.2 Connection Diagram of Test System .....11

2.3 Support Unit used in test configuration .....11

2.4 Measurement Results Explanation Example .....11

**3 CONDUCTED TEST RESULT .....12**

3.1 Measuring Instruments.....12

3.2 Test Setup .....12

3.3 Test Result of Conducted Test.....12

3.4 Conducted Output Power .....13

3.5 Peak-to-Average Ratio .....14

3.6 99% Occupied Bandwidth and 26dB Bandwidth Measurement.....15

3.7 Conducted Band Edge .....16

3.8 Conducted Spurious Emission .....17

3.9 Frequency Stability.....18

**4 RADIATED TEST ITEMS .....19**

4.1 Measuring Instruments.....19

4.2 Test Setup .....19

4.3 Test Result of Radiated Test.....19

4.4 Effective Radiated Power and Effective Isotropic Radiated Power Measurement .....20

4.5 Field Strength of Spurious Radiation Measurement .....22

**5 LIST OF MEASURING EQUIPMENT .....23**

**6 UNCERTAINTY OF EVALUATION .....24**

**APPENDIX A. TEST RESULTS OF CONDUCTED TEST**

**APPENDIX B. TEST RESULTS OF RADIATED TEST**

**APPENDIX C. TEST SETUP PHOTOGRAPHS**



### REVISION HISTORY

REPORT NO.	VERSION	DESCRIPTION	ISSUED DATE
FG630110-01A	Rev. 01	Initial issue of report	Jun. 06, 2016



### SUMMARY OF TEST RESULT

Report Section	FCC Rule	Description	Limit	Result	Remark
3.4	§2.1046	Conducted Output Power	Reporting Only	PASS	-
3.4	§90.635	Conducted Output Power	<100W	PASS	-
3.5	§24.232(d)	Peak-to-Average Ratio	< 13 dB	PASS	-
3.6	§2.1049 §22.917(b) §24.238(b) §27.53(g)	Occupied Bandwidth	Reporting Only	PASS	-
3.7	§2.1051 §22.917(a) §24.238(a) §27.53(h)	Band Edge Measurement	< 43+10log10(P[Watts])	PASS	-
3.8	§2.1051 §22.917(a) §24.238(a) §27.53(h)	Conducted Emission	< 43+10log10(P[Watts])	PASS	-
3.9	§2.1055 §22.355	Frequency Stability for Temperature & Voltage	< 2.5 ppm for Part 22	PASS	-
	§2.1055 §24.235 §27.54		Within Authorized Band		



Report Section	FCC Rule	Description	Limit	Result	Remark
4.4	§22.913(a)(2)	Effective Radiated Power	< 7 Watts	PASS	-
	§24.232(c)	Equivalent Isotropic Radiated Power	< 2 Watts	PASS	-
	§27.50(d)(4)	Equivalent Isotropic Radiated Power	< 1 Watts	PASS	-
4.5	§2.1053 §22.917(a) §24.238(a) §27.53(h)	Field Strength of Spurious Radiation	< 43+10log10(P[Watts])	PASS	Under limit 15.13 dB at 2512.000 MHz



# 1 General Description

## 1.1 Applicant

**Bullitt Group**

One Valpy, Valpy Street, Reading, Berkshire, RG1 1AR United Kingdom

## 1.2 Manufacturer

**Compal Electronics, INC.**

No. 385, Yangguang St. Neihu District, Taipei City 11491, Taiwan, R.O.C

## 1.3 Product Feature of Equipment Under Test

Product Feature	
Equipment	Rugged Smart Phone
Brand Name	CAT
Model Name	S60
Marketing Name	S60
FCC ID	ZL5S60
Sample 1	EUT with Dual SIM
Sample 2	EUT with Sigle SIM
EUT supports Radios application	GSM/EGPRS/WCDMA/HSPA/LTE/NFC WLAN 11b/g/n HT20/HT40 Bluetooth v4.1 EDR/LE
EUT Stage	Identical Prototype

**Remark:**

1. The above EUT's information was declared by manufacturer. Please refer to the specifications or user's manual for more detailed description.
2. All test items are performed on sample 1.



### 1.4 Product Specification of Equipment Under Test

Standards-related Product Specification	
<b>Tx Frequency</b>	<b>GSM/GPRS/EDGE:</b> 850: 824.2 MHz ~ 848.8 MHz 1900: 1850.2 MHz ~ 1909.8MHz <b>WCDMA:</b> Band V: 826.4 MHz ~ 846.6 MHz Band II: 1852.4 MHz ~ 1907.6 MHz Band IV: 1712.4 MHz ~ 1752.6 MHz
<b>Rx Frequency</b>	<b>GSM/GPRS/EDGE:</b> 850: 869.2 MHz ~ 893.8 MHz 1900: 1930.2 MHz ~ 1989.8 MHz <b>WCDMA:</b> Band V: 871.4 MHz ~ 891.6 MHz Band II: 1932.4 MHz ~ 1987.6 MHz Band IV: 2112.4 MHz ~ 2152.6 MHz
<b>Maximum Output Power to Antenna</b>	<b>GSM/GPRS/EDGE:</b> 850: 33.00 dBm 1900: 29.62 dBm <b>WCDMA:</b> Band V: 23.40 dBm Band II: 22.94 dBm Band IV: 22.99 dBm
<b>Antenna Type</b>	PIFA + Coupling type (LDS) Antenna
<b>Type of Modulation</b>	GSM: GMSK GPRS: GMSK EDGE: GMSK / 8PSK WCDMA: QPSK (Uplink) HSDPA: 64QAM (Downlink) HSUPA: QPSK (Uplink)

### 1.5 Modification of EUT

No modifications are made to the EUT during all test items.



### 1.6 Maximum ERP/EIRP Power, Frequency Tolerance, and Emission Designator

FCC Rule	System	Type of Modulation	Maximum ERP/EIRP (W)	Frequency Tolerance (ppm)	Emission Designator
Part 22	GSM850 GPRS class 8	GMSK	0.8954	0.0060 ppm	245KGXW
Part 22	GSM850 EDGE class 8	8PSK	0.2661	0.0060 ppm	245KG7W
Part 22	WCDMA Band V RMC 12.2Kbps	QPSK	0.1225	0.0143 ppm	4M13F9W
Part 24	GSM1900 GPRS class 8	GMSK	0.5794	0.0021 ppm	243KGXW
Part 24	GSM1900 EDGE class 8	8PSK	0.1950	0.0048 ppm	245KG7W
Part 24	WCDMA Band II RMC 12.2Kbps	QPSK	0.1151	0.0069 ppm	4M12F9W
Part 27	WCDMA Band IV RMC 12.2Kbps	QPSK	0.1330	0.0017 ppm	4M30F9W

### 1.7 Testing Location

Sporton Lab is accredited to ISO 17025 by Taiwan Accreditation Foundation (TAF code : 1190) and the FCC designation No. TW1022 under the FCC 2.948(e) by Mutual Recognition Agreement (MRA) in FCC Test.

<b>Test Site</b>	SPORTON INTERNATIONAL INC.
<b>Test Site Location</b>	No. 52, Hwa Ya 1 <sup>st</sup> Rd., Hwa Ya Technology Park, Kwei-Shan District, Tao Yuan City, Taiwan, R.O.C. TEL: +886-3-327-3456 FAX: +886-3-328-4978
<b>Test Site No.</b>	<b>Sporton Site No.</b> TH02-HY

<b>Test Site</b>	SPORTON INTERNATIONAL INC.
<b>Test Site Location</b>	No.58, Aly. 75, Ln. 564, Wenhua 3rd Rd. Guishan Dist, Taoyuan City, Taiwan (R.O.C.) TEL: +886-3-327-0868 FAX: +886-3-327-0855
<b>Test Site No.</b>	<b>Sporton Site No.</b> 03CH12-HY





## 1.8 Applicable Standards

According to the specifications of the manufacturer, the EUT must comply with the requirements of the following standards:

- ♦ 47 CFR Part 2, 22(H), 24(E), 27(L)
- ♦ ANSI / TIA / EIA-603-D-2010
- ♦ FCC KDB 971168 D01 Power Meas. License Digital Systems v02r02

### **Remark:**

1. All test items were verified and recorded according to the standards and without any deviation during the test.
2. This EUT has also been tested and complied with the requirements of FCC Part 15, Subpart B, recorded in a separate test report.



## 2 Test Configuration of Equipment Under Test

### 2.1 Test Mode

Antenna port conducted and radiated test items were performed according to KDB 971168 D01 Power Meas. License Digital Systems v02r02 with maximum output power.

Radiated measurements were performed with rotating EUT in different three orthogonal test planes to find the maximum emission.

Radiated emissions were investigated as following frequency range:

1. 30 MHz to 9000 MHz for GSM850 and WCDMA Band V.
2. 30 MHz to 18000 MHz for WCDMA Band IV.
3. 30 MHz to 19000 MHz for GSM1900 and WCDMA Band II.

All modes and data rates and positions were investigated.

Test modes are chosen to be reported as the worst case configuration below:

Test Modes		
Band	Radiated TCs	Conducted TCs
GSM 850	<ul style="list-style-type: none"> <li>■ GPRS class 8 Link</li> <li>■ EDGE class 8 Link</li> </ul>	<ul style="list-style-type: none"> <li>■ GPRS class 8 Link</li> <li>■ EDGE class 8 Link</li> </ul>
GSM 1900	<ul style="list-style-type: none"> <li>■ GPRS class 8 Link</li> <li>■ EDGE class 8 Link</li> </ul>	<ul style="list-style-type: none"> <li>■ GPRS class 8 Link</li> <li>■ EDGE class 8 Link</li> </ul>
WCDMA Band V	<ul style="list-style-type: none"> <li>■ RMC 12.2Kbps Link</li> </ul>	<ul style="list-style-type: none"> <li>■ RMC 12.2Kbps Link</li> </ul>
WCDMA Band II	<ul style="list-style-type: none"> <li>■ RMC 12.2Kbps Link</li> </ul>	<ul style="list-style-type: none"> <li>■ RMC 12.2Kbps Link</li> </ul>
WCDMA Band IV	<ul style="list-style-type: none"> <li>■ RMC 12.2Kbps Link</li> </ul>	<ul style="list-style-type: none"> <li>■ RMC 12.2Kbps Link</li> </ul>

## 2.2 Connection Diagram of Test System

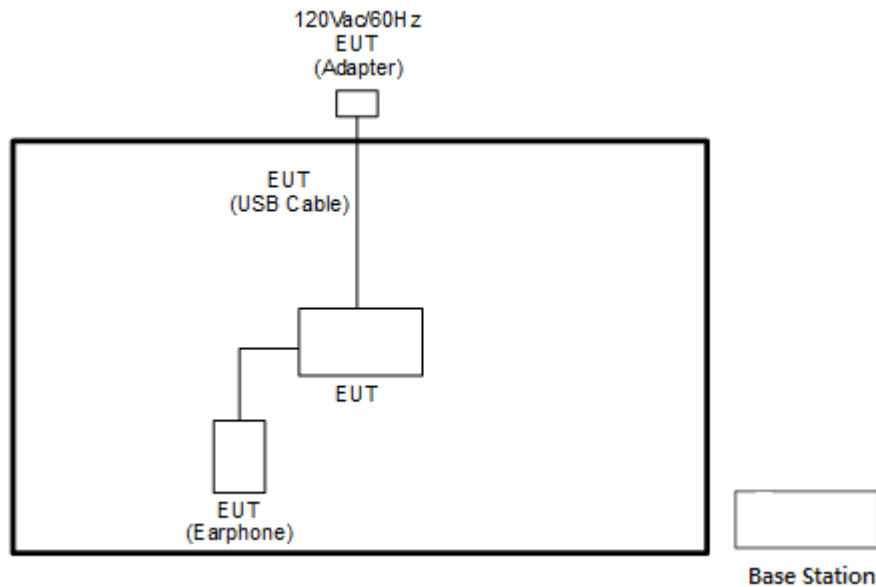

## 2.3 Support Unit used in test configuration

Item	Equipment	Trade Name	Model No.	FCC ID	Data Cable	Power Cord
1.	System Simulator	Anritsu	MT8820C	N/A	N/A	Unshielded, 1.8 m

## 2.4 Measurement Results Explanation Example

### For all conducted test items:

The offset level is set in the spectrum analyzer to compensate the RF cable loss and attenuator factor between RF conducted output port and spectrum analyzer. With the offset compensation, the spectrum analyzer reading level will be exactly the RF output level.

The spectrum analyzer offset is derived from RF cable loss and attenuator factor.

*Offset = RF cable loss + attenuator factor.*

The following shows an offset computation example with RF cable loss 4.2 dB and a 10dB attenuator.

Example :

$$\begin{aligned} \text{Offset(dB)} &= \text{RF cable loss(dB)} + \text{attenuator factor(dB)} \\ &= 4.2 + 10 = 14.2 \text{ (dB)} \end{aligned}$$

### 3 Conducted Test Result

#### 3.1 Measuring Instruments

See list of measuring instruments of this test report.

#### 3.2 Test Setup

##### 3.2.1 Conducted Output Power

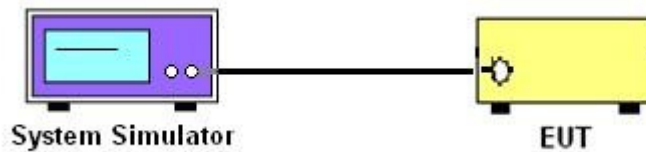

##### 3.2.2 Peak-to-Average Ratio, Occupied Bandwidth, Conducted Band-Edge and Conducted Spurious Emission

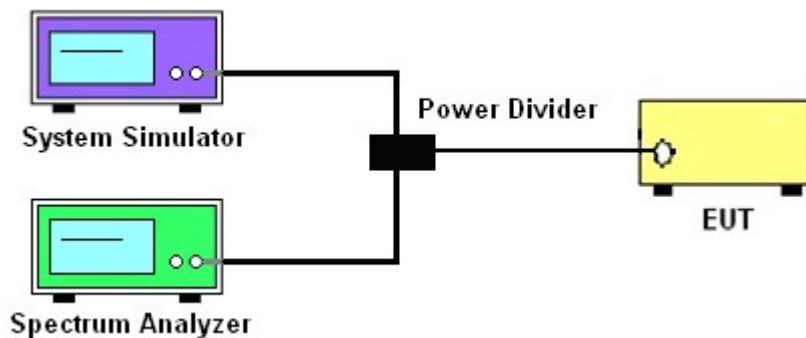

##### 3.2.3 Frequency Stability

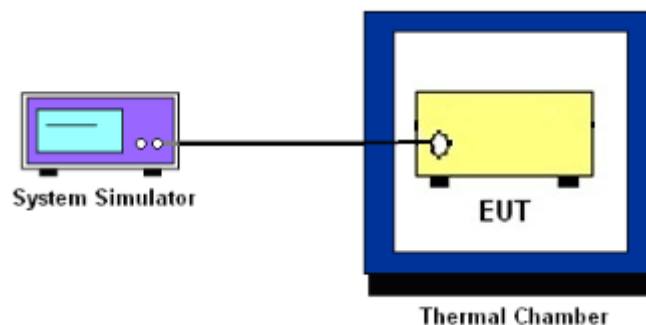

### 3.3 Test Result of Conducted Test

Please refer to Appendix A.



## **3.4 Conducted Output Power**

### **3.4.1 Description of the Conducted Output Power**

A system simulator was used to establish communication with the EUT. Its parameters were set to enforce EUT transmitting at the maximum power. The measured power in the radio frequency on the transmitter output terminals shall be reported.

### **3.4.2 Test Procedures**

1. The transmitter output port was connected to the system simulator.
2. Set EUT at maximum power through system simulator.
3. Select lowest, middle, and highest channels for each band and different modulation.
4. Measure the maximum burst average power for GSM and maximum average power for other modulation signal.



## **3.5 Peak-to-Average Ratio**

### **3.5.1 Description of the PAR Measurement**

The peak-to-average ratio (PAR) of the transmission may not exceed 13 dB.

### **3.5.2 Test Procedures**

1. The testing follows FCC KDB 971168 D01 v02r02 Section 5.7.1.
2. The EUT was connected to spectrum analyzer and system simulator via a power divider.
3. Set EUT to transmit at maximum output power.
4. When the duty cycle is less than 98%, then signal gating will be implemented on the spectrum analyzer by triggering from the system simulator.
5. Set the CCDF (Complementary Cumulative Distribution Function) option of the spectrum analyzer.  
Record the maximum PAPR level associated with a probability of 0.1%.



## 3.6 99% Occupied Bandwidth and 26dB Bandwidth Measurement

### 3.6.1 Description of 99% Occupied Bandwidth and 26dB Bandwidth Measurement

The occupied bandwidth is the width of a frequency band such that, below the lower and above the upper frequency limits, the mean powers emitted are each equal to a specified percentage 0.5% of the total mean transmitted power.

The 26 dB emission bandwidth is defined as the frequency range between two points, one above and one below the carrier frequency, at which the spectral density of the emission is attenuated 26 dB below the maximum in-band spectral density of the modulated signal. Spectral density (power per unit bandwidth) is to be measured with a detector of resolution bandwidth equal to approximately 1.0% of the emission bandwidth.

### 3.6.2 Test Procedures

1. The testing follows FCC KDB 971168 v02r02 Section 4.2.
2. The EUT was connected to spectrum analyzer and system simulator via a power divider.
3. The spectrum analyzer center frequency is set to the nominal EUT channel center frequency. The span range for the spectrum analyzer shall be between two and five times the anticipated OBW.
4. The nominal resolution bandwidth (RBW) shall be in the range of 1 to 5 % of the anticipated OBW, and the VBW shall be at least 3 times the RBW.
5. Set the detection mode to peak, and the trace mode to max hold.
6. Determine the reference value: Set the EUT to transmit a modulated signal. Allow the trace to stabilize. Set the spectrum analyzer marker to the highest level of the displayed trace.  
(this is the reference value)
7. Determine the “-26 dB down amplitude” as equal to (Reference Value – X).
8. Place two markers, one at the lowest and the other at the highest frequency of the envelope of the spectral display such that each marker is at or slightly below the “-X dB down amplitude” determined in step 6. If a marker is below this “-X dB down amplitude” value it shall be placed as close as possible to this value. The OBW is the positive frequency difference between the two markers.
9. Use the 99 % power bandwidth function of the spectrum analyzer and report the measured bandwidth.



### **3.7 Conducted Band Edge**

#### **3.7.1 Description of Conducted Band Edge Measurement**

The power of any emission outside of the authorized operating frequency ranges must be lower than the transmitter power (P) by a factor of at least  $43 + 10 \log (P)$  dB.

#### **3.7.2 Test Procedures**

1. The testing follows FCC KDB 971168 D01 v02r02 Section 6.0.
2. The EUT was connected to the spectrum analyzer and system simulator via a power divider.
3. The RF output of EUT was connected to the spectrum analyzer by an RF cable and attenuator. The path loss was compensated to the results for each measurement.
4. The band edges of low and high channels for the highest RF powers were measured.
5. The RF fundamental frequency should be excluded against the limit line in the operating frequency band.
6. The limit line is derived from  $43 + 10\log(P)$  dB below the transmitter power P(Watts)  
=  $P(W) - [43 + 10\log(P)]$  (dB)  
=  $[30 + 10\log(P)]$  (dBm) -  $[43 + 10\log(P)]$  (dB)  
= -13dBm.





### 3.8 Conducted Spurious Emission

#### 3.8.1 Description of Conducted Spurious Emission Measurement

The power of any emission outside of the authorized operating frequency ranges must be lower than the transmitter power (P) by a factor of at least  $43 + 10 \log (P)$  dB.

It is measured by means of a calibrated spectrum analyzer and scanned from 30 MHz up to a frequency including its 10<sup>th</sup> harmonic.

#### 3.8.2 Test Procedures

1. The testing follows FCC KDB 971168 D01 v02r02 Section 6.0.
2. The EUT was connected to the spectrum analyzer and system simulator via a power divider.
3. The RF output of EUT was connected to the spectrum analyzer by an RF cable and attenuator. The path loss was compensated to the results for each measurement.
4. The middle channel for the highest RF power within the transmitting frequency was measured.
5. The conducted spurious emission for the whole frequency range was taken.
6. The RF fundamental frequency should be excluded against the limit line in the operating frequency band.
7. The limit line is derived from  $43 + 10\log(P)$  dB below the transmitter power P(Watts)  
=  $P(W) - [43 + 10\log(P)]$  (dB)  
=  $[30 + 10\log(P)]$  (dBm) -  $[43 + 10\log(P)]$  (dB)  
= -13dBm.



### 3.9 Frequency Stability

#### 3.9.1 Description of Frequency Stability Measurement

The frequency stability shall be measured by variation of ambient temperature and variation of primary supply voltage to ensure that the fundamental emission stays within the authorized frequency block. The frequency stability of the transmitter shall be maintained within  $\pm 0.00025\%$  ( $\pm 2.5\text{ppm}$ ) of the center frequency.

#### 3.9.2 Test Procedures for Temperature Variation

1. The testing follows FCC KDB 971168 D01 v02r02 Section 9.0.
2. The EUT was set up in the thermal chamber and connected with the system simulator.
3. With power OFF, the temperature was decreased to  $-30^{\circ}\text{C}$  and the EUT was stabilized before testing. Power was applied and the maximum change in frequency was recorded within one minute.
4. With power OFF, the temperature was raised in  $10^{\circ}\text{C}$  steps up to  $50^{\circ}\text{C}$ . The EUT was stabilized at each step for at least half an hour. Power was applied and the maximum frequency change was recorded within one minute.

#### 3.9.3 Test Procedures for Voltage Variation

1. The testing follows FCC KDB 971168 D01 v02r02 Section 9.0.
2. The EUT was placed in a temperature chamber at  $25\pm 5^{\circ}\text{C}$  and connected with the system simulator.
3. The power supply voltage to the EUT was varied from 85% to 115% of the nominal value measured at the input to the EUT.
4. The variation in frequency was measured for the worst case.

## 4 Radiated Test Items

### 4.1 Measuring Instruments

See list of measuring instruments of this test report.

### 4.2 Test Setup

#### 4.2.1 For radiated test from 30MHz to 1GHz



#### 4.2.2 For radiated test above 1GHz

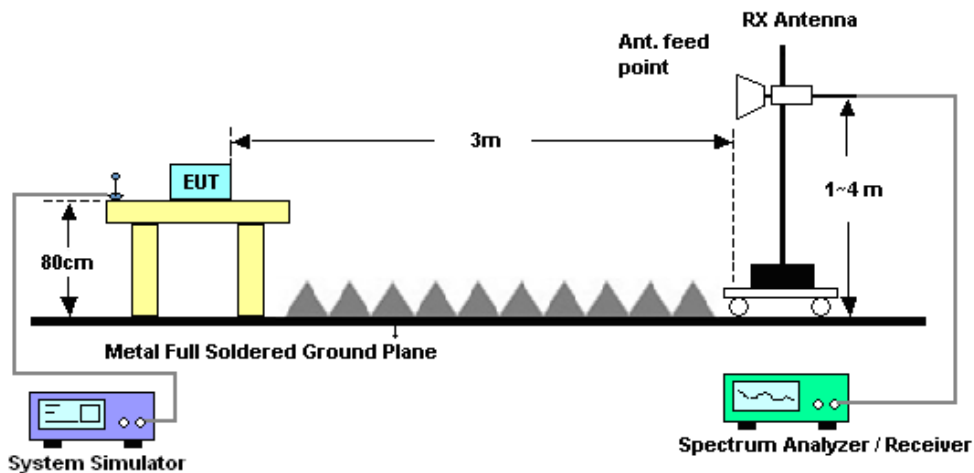

### 4.3 Test Result of Radiated Test

Please refer to Appendix B.



## **4.4 Effective Radiated Power and Effective Isotropic Radiated Power Measurement**

### **4.4.1 Description of the ERP/EIRP Measurement**

The substitution method, in ANSI / TIA / EIA-603-D-2010, was used for ERP/EIRP measurement, and the spectrum analyzer configuration follows KDB 971168 D01 Power Meas. License Digital Systems v02r02. The ERP of mobile transmitters must not exceed 7 Watts (Cellular Band) and the EIRP of mobile transmitters are limited to 2 Watts (PCS Band) and 1 Watts (AWS Band).

### **4.4.2 Test Procedures**

1. The testing follows FCC KDB 971168 D01 v02r02 Section 5.2.1. (for CDMA/WCDMA), Section 5.2.2.2 (for GSM/GPRS/EDGE) and ANSI / TIA-603-D-2010 Section 2.2.17.
2. The EUT was placed on a non-conductive rotating platform 0.8 meters high in a semi-anechoic chamber. The radiated emission at the fundamental frequency was measured at 3 m with a test antenna and a spectrum analyzer with RMS detector per section 5. of KDB 971168 D01.
3. During the measurement, the system simulator parameters were set to force the EUT transmitting at maximum output power. The maximum emission was recorded from analyzer power level (LVL) from the 360 degrees rotation of the turntable and the test antenna raised and lowered over a range from 1 to 4 meters in both horizontally and vertically polarized orientations.
4. Effective Isotropic Radiated Power (EIRP) was measured by substitution method according to TIA/EIA-603-D. The EUT was replaced by the substitution antenna at same location, and then a known power from S.G. was applied into the dipole antenna through a Tx cable, and then recorded the maximum Analyzer reading through raised and lowered the test antenna. The correction factor (in dB) = S.G. - Tx Cable loss + Substitution antenna gain - Analyzer reading. Then the EUT's EIRP was calculated with the correction factor,  $EIRP = LVL + \text{Correction factor}$  and  $ERP = EIRP - 2.15$ . Take the record of the output power at substitution antenna.



	GSM/GPRS/EDGE	WCDMA/HSPA
SPAN	500kHz	10MHz
RBW	10kHz	100kHz
VBW	30kHz	300kHz
Detector	RMS	RMS
Trace	Average	Average
Average Type	Power	Power
Sweep Count	100	100



## 4.5 Field Strength of Spurious Radiation Measurement

### 4.5.1 Description of Field Strength of Spurious Radiated Measurement

The power of any emission outside of the authorized operating frequency ranges must be attenuated below the transmitter power (P) by a factor of at least  $43 + 10 \log (P)$  dB. The spectrum is scanned from 30 MHz up to a frequency including its 10th harmonic.

### 4.5.2 Test Procedures

1. The testing follows FCC KDB 971168 D01 v02r02 Section 5.8 and ANSI / TIA-603-D-2010 Section 2.2.12.
2. The EUT was placed on a rotatable wooden table 0.8 meters above the ground.
3. The EUT was set 3 meters from the receiving antenna, which was mounted on the antenna tower.
4. The table was rotated 360 degrees to determine the position of the highest spurious emission.
5. The height of the receiving antenna is varied between one meter and four meters to search for the maximum spurious emission for both horizontal and vertical polarizations.
6. Make the measurement with the spectrum analyzer's RBW = 1MHz, VBW = 3MHz, taking record of maximum spurious emission.
7. A horn antenna was substituted in place of the EUT and was driven by a signal generator.
8. Tune the output power of signal generator to the same emission level with EUT maximum spurious emission.
9. Taking the record of output power at antenna port.
10. Repeat step 7 to step 8 for another polarization.
11.  $EIRP \text{ (dBm)} = S.G. \text{ Power} - Tx \text{ Cable Loss} + Tx \text{ Antenna Gain}$
12.  $ERP \text{ (dBm)} = EIRP - 2.15$
13. The RF fundamental frequency should be excluded against the limit line in the operating frequency band.
14. The limit line is derived from  $43 + 10\log(P)$  dB below the transmitter power P(Watts)  
=  $P(W) - [43 + 10\log(P)] \text{ (dB)}$   
=  $[30 + 10\log(P)] \text{ (dBm)} - [43 + 10\log(P)] \text{ (dB)}$   
= -13dBm.



## 5 List of Measuring Equipment

Instrument	Manufacturer	Model No.	Serial No.	Characteristics	Calibration Date	Test Date	Due Date	Remark
Spectrum Analyzer	Rohde & Schwarz	FSP30	101329	9kHz~30GHz	Jun. 24, 2015	May 07, 2016 ~ May 16, 2016	Jun. 23, 2016	Conducted (TH03-HY)
Temperature Chamber	ESPEC	SU-641	92013721	-30℃ ~70℃	Nov. 20, 2015	May 07, 2016 ~ May 16, 2016	Nov. 19, 2016	Conducted (TH03-HY)
Amplifier	SONOMA	310N	187312	9kHz~1GHz	Nov. 20, 2015	May 07, 2016 ~ Jun. 02, 2016	Nov. 19, 2016	Radiation (03CH12-HY)
Bilog Antenna	TESEQ	CBL 6111D	35414	30MHz~1GHz	Nov. 17, 2015	May 07, 2016 ~ Jun. 02, 2016	Nov. 16, 2016	Radiation (03CH12-HY)
Horn Antenna	SCHWARZBECK	BBHA 9120 D	9120D-1326	1GHz ~ 18GHz	Oct. 08, 2015	May 07, 2016 ~ Jun. 02, 2016	Oct. 07, 2016	Radiation (03CH12-HY)
Spectrum Analyzer	Keysight	N9010A	MY54200486	10Hz ~ 44GHZ	Sep. 24, 2015	May 07, 2016 ~ Jun. 02, 2016	Sep. 23, 2016	Radiation (03CH12-HY)
Bilog Antenna	TESEQ	CBL 6111D	37059	30MHz~1GHz	Dec. 29, 2015	May 07, 2016 ~ Jun. 02, 2016	Dec. 28, 2016	Radiation (03CH12-HY)
EMI Test Receiver	Rohde & Schwarz	ESU26	100390	20Hz~26.5GHz	Dec. 21, 2015	May 07, 2016 ~ Jun. 02, 2016	Dec. 20, 2016	Radiation (03CH12-HY)
Horn Antenna	SCHWARZBECK	BBHA 9120D	9120D-1328	1GHz ~ 18GHz	Nov. 02, 2015	May 07, 2016 ~ Jun. 02, 2016	Nov. 01, 2016	Radiation (03CH12-HY)
Preamplifier	MITEQ	AMF-7D-001 01800-30-10	1815698	1GHz~18GHz	Dec. 14, 2015	May 07, 2016 ~ Jun. 02, 2016	Dec. 13, 2016	Radiation (03CH12-HY)
Antenna Mast	EMEC	AM-BS-4500-B	N/A	1m~4m	N/A	May 07, 2016 ~ Jun. 02, 2016	N/A	Radiation (03CH12-HY)
Turn Table	EMEC	TT2000	N/A	0~360 Degree	N/A	May 07, 2016 ~ Jun. 02, 2016	N/A	Radiation (03CH12-HY)
SHF-EHF Horn Antenna	SCHWARZBECK	BBHA 9170	BBHA9170576	18GHz ~ 40GHz	Apr. 15, 2016	May 07, 2016 ~ Jun. 02, 2016	Apr. 14, 2017	Radiation (03CH12-HY)
Preamplifier	MITEQ	JS44-180040 00-33-8P	1840917	18GHz ~ 40GHz	Jun. 02, 2015	May 07, 2016 ~ Jun. 02, 2016	Jun. 01, 2016	Radiation (03CH12-HY)
SHF-EHF Horn Antenna	SCHWARZBECK	BBHA 9170	BBHA9170584	18GHz- 40GHz	Nov. 02, 2015	May 07, 2016 ~ Jun. 02, 2016	Nov. 01, 2016	Radiation (03CH12-HY)
Signal Generator	Rohde & Schwarz	SMF100A	101107	100kHz~40GHz	May 22, 2015	May 07, 2016 ~ May 18, 2016	May 21, 2016	Radiation (03CH12-HY)
Signal Generator	Rohde & Schwarz	SMF100A	101107	100kHz~40GHz	May 19, 2016	May 19, 2016 ~ Jun. 02, 2016	May 18, 2017	Radiation (03CH12-HY)



## 6 Uncertainty of Evaluation

### Uncertainty of Radiated Emission Measurement (30 MHz ~ 1000 MHz)

Measuring Uncertainty for a Level of Confidence of 95% ( $U = 2Uc(y)$ )	4.9
---	-----





## Appendix A. Test Results of Conducted Test

### Conducted Output Power(Average power)

Conducted Power (*Unit: dBm)						
Band	GSM850			GSM1900		
Channel	128	189	251	512	661	810
Frequency	824.2	836.4	848.8	1850.2	1880.0	1909.8
GSM	32.67	32.86	32.98	29.59	29.39	29.57
GPRS class 8	32.68	32.87	33.00	29.62	29.43	29.60
GPRS class 10	29.53	29.55	29.70	26.65	26.67	26.77
GPRS class 11	27.73	27.89	28.00	24.67	24.65	24.83
GPRS class 12	26.58	26.39	26.53	23.49	23.57	23.68
EGPRS class 8	26.45	26.42	26.48	25.47	25.47	25.55
EGPRS class 10	25.26	25.24	25.28	24.32	24.30	24.42
EGPRS class 11	25.60	25.56	25.58	24.69	24.72	24.78
EGPRS class 12	24.90	24.86	24.91	24.04	24.06	24.15

Conducted Power (*Unit: dBm)									
Band	WCDMA Band V			WCDMA Band II			WCDMA Band IV		
Channel	4132	4182	4233	9262	9400	9538	1312	1413	1513
Frequency	826.4	836.4	846.6	1852.4	1880	1907.6	1712.4	1732.6	1752.6
RMC 12.2K	23.40	23.32	23.29	22.80	22.72	22.94	22.95	22.84	22.99
HSDPA Subtest-1	22.45	22.33	22.36	21.84	21.77	21.99	22.05	21.82	22.09
HSDPA Subtest-2	22.53	22.37	22.40	21.98	21.78	22.08	22.16	21.85	22.18
HSDPA Subtest-3	21.96	21.80	21.82	21.50	21.28	21.59	21.77	21.38	21.78
HSDPA Subtest-4	21.90	21.82	21.82	21.53	21.29	21.58	21.71	21.38	21.76
HSUPA Subtest-1	22.29	22.21	22.19	21.91	21.81	22.00	22.12	21.88	22.02
HSUPA Subtest-2	20.32	20.34	20.26	19.89	19.80	20.07	20.13	19.85	19.99
HSUPA Subtest-3	21.26	21.18	21.28	21.00	20.83	21.10	21.19	20.95	21.16
HSUPA Subtest-4	20.25	20.34	20.26	19.96	19.79	20.14	20.17	19.87	20.09
HSUPA Subtest-5	22.44	22.39	22.34	21.81	21.76	21.99	22.06	21.88	22.02



## A1. GSM

### Peak-to-Average Ratio

Mode	GSM850		Limit: 13dB
Mod.	GPRS class 8	EDGE class 8	Result
Lowest CH	0.28	3.36	PASS
Middle CH	0.24	3.40	
Highest CH	0.28	3.36	

Mode	GSM1900		Limit: 13dB
Mod.	GPRS class 8	EDGE class 8	Result
Lowest CH	0.24	3.52	PASS
Middle CH	0.24	3.40	
Highest CH	0.24	3.44	

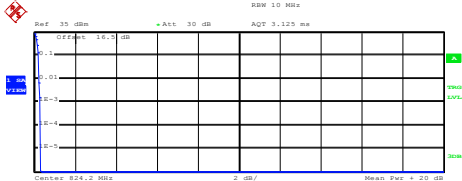
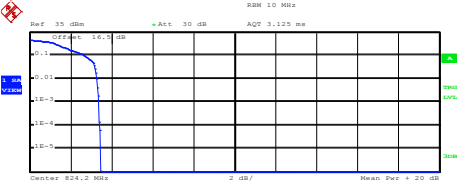
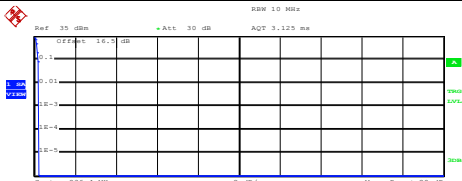
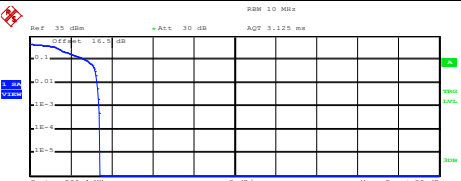
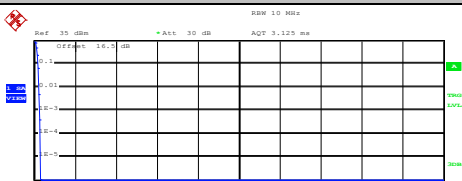
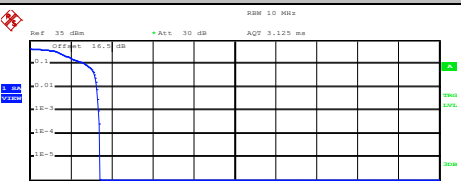

GSM850 (GPRS class 8)	GSM850 (EDGE class 8)
<p align="center"><b>Lowest Channel</b></p>  <p>Center 824.2 MHz      2 dB/      Mean Dev + 20 dB</p> <p>Complementary Cumulative Distribution Function (100000 samples)</p> <p>Trace 1</p> <p>Mean 34.02 dBm Peak 34.33 dBm Crest 0.31 dB</p> <p>10 % 0.20 dB 1 % 0.24 dB .1 % 0.28 dB .01 % 0.32 dB</p> <p>Date: 7.MAY.2016 16:01:54</p>	<p align="center"><b>Lowest Channel</b></p>  <p>Center 824.2 MHz      2 dB/      Mean Dev + 20 dB</p> <p>Complementary Cumulative Distribution Function (100000 samples)</p> <p>Trace 1</p> <p>Mean 27.49 dBm Peak 30.95 dBm Crest 3.46 dB</p> <p>10 % 2.68 dB 1 % 3.28 dB .1 % 3.36 dB .01 % 3.44 dB</p> <p>Date: 7.MAY.2016 16:29:04</p>
<p align="center"><b>Middle Channel</b></p>  <p>Center 836.4 MHz      2 dB/      Mean Dev + 20 dB</p> <p>Complementary Cumulative Distribution Function (100000 samples)</p> <p>Trace 1</p> <p>Mean 33.60 dBm Peak 33.84 dBm Crest 0.24 dB</p> <p>10 % 0.20 dB 1 % 0.24 dB .1 % 0.24 dB .01 % 0.24 dB</p> <p>Date: 7.MAY.2016 16:02:17</p>	<p align="center"><b>Middle Channel</b></p>  <p>Center 836.4 MHz      2 dB/      Mean Dev + 20 dB</p> <p>Complementary Cumulative Distribution Function (100000 samples)</p> <p>Trace 1</p> <p>Mean 27.68 dBm Peak 31.09 dBm Crest 3.41 dB</p> <p>10 % 2.72 dB 1 % 3.28 dB .1 % 3.40 dB .01 % 3.44 dB</p> <p>Date: 7.MAY.2016 16:29:21</p>
<p align="center"><b>Highest Channel</b></p>  <p>Center 848.8 MHz      2 dB/      Mean Dev + 20 dB</p> <p>Complementary Cumulative Distribution Function (100000 samples)</p> <p>Trace 1</p> <p>Mean 33.56 dBm Peak 33.84 dBm Crest 0.28 dB</p> <p>10 % 0.20 dB 1 % 0.24 dB .1 % 0.28 dB .01 % 0.32 dB</p> <p>Date: 7.MAY.2016 16:02:36</p>	<p align="center"><b>Highest Channel</b></p>  <p>Center 848.8 MHz      2 dB/      Mean Dev + 20 dB</p> <p>Complementary Cumulative Distribution Function (100000 samples)</p> <p>Trace 1</p> <p>Mean 27.45 dBm Peak 30.88 dBm Crest 3.43 dB</p> <p>10 % 2.68 dB 1 % 3.28 dB .1 % 3.36 dB .01 % 3.44 dB</p> <p>Date: 7.MAY.2016 16:29:44</p>



GSM1900 (GPRS class 8)	GSM1900 (EDGE class 8)
<p align="center"><b>Lowest Channel</b></p> <p align="center">Complementary Cumulative Distribution Function (100000 samples) Trace 1</p> <p>Mean 30.72 dBm Peak 31.02 dBm Crest 0.30 dB</p> <p>10 % 0.20 dB 1 % 0.24 dB .1 % 0.24 dB .01 % 0.28 dB</p> <p>Date: 7.MAY.2016 16:52:08</p>	<p align="center"><b>Lowest Channel</b></p> <p align="center">Complementary Cumulative Distribution Function (100000 samples) Trace 1</p> <p>Mean 26.03 dBm Peak 29.61 dBm Crest 3.58 dB</p> <p>10 % 2.76 dB 1 % 3.40 dB .1 % 3.52 dB .01 % 3.56 dB</p> <p>Date: 7.MAY.2016 17:25:06</p>
<p align="center"><b>Middle Channel</b></p> <p align="center">Complementary Cumulative Distribution Function (100000 samples) Trace 1</p> <p>Mean 30.22 dBm Peak 30.45 dBm Crest 0.23 dB</p> <p>10 % 0.16 dB 1 % 0.24 dB .1 % 0.24 dB .01 % 0.24 dB</p> <p>Date: 7.MAY.2016 16:52:26</p>	<p align="center"><b>Middle Channel</b></p> <p align="center">Complementary Cumulative Distribution Function (100000 samples) Trace 1</p> <p>Mean 25.93 dBm Peak 29.40 dBm Crest 3.47 dB</p> <p>10 % 2.72 dB 1 % 3.32 dB .1 % 3.40 dB .01 % 3.44 dB</p> <p>Date: 7.MAY.2016 17:25:22</p>
<p align="center"><b>Highest Channel</b></p> <p align="center">Complementary Cumulative Distribution Function (100000 samples) Trace 1</p> <p>Mean 30.38 dBm Peak 30.67 dBm Crest 0.28 dB</p> <p>10 % 0.20 dB 1 % 0.24 dB .1 % 0.24 dB .01 % 0.28 dB</p> <p>Date: 7.MAY.2016 16:52:45</p>	<p align="center"><b>Highest Channel</b></p> <p align="center">Complementary Cumulative Distribution Function (100000 samples) Trace 1</p> <p>Mean 26.20 dBm Peak 29.68 dBm Crest 3.48 dB</p> <p>10 % 2.96 dB 1 % 3.40 dB .1 % 3.44 dB .01 % 3.48 dB</p> <p>Date: 7.MAY.2016 17:25:38</p>



**26dB Bandwidth**

Mode	GSM850	
Mod.	GPRS class 8	EDGE class 8
Lowest CH	0.315	0.289
Middle CH	0.296	0.290
Highest CH	0.306	0.294

Mode	GSM1900	
Mod.	GPRS class 8	EDGE class 8
Lowest CH	0.300	0.301
Middle CH	0.295	0.307
Highest CH	0.308	0.303

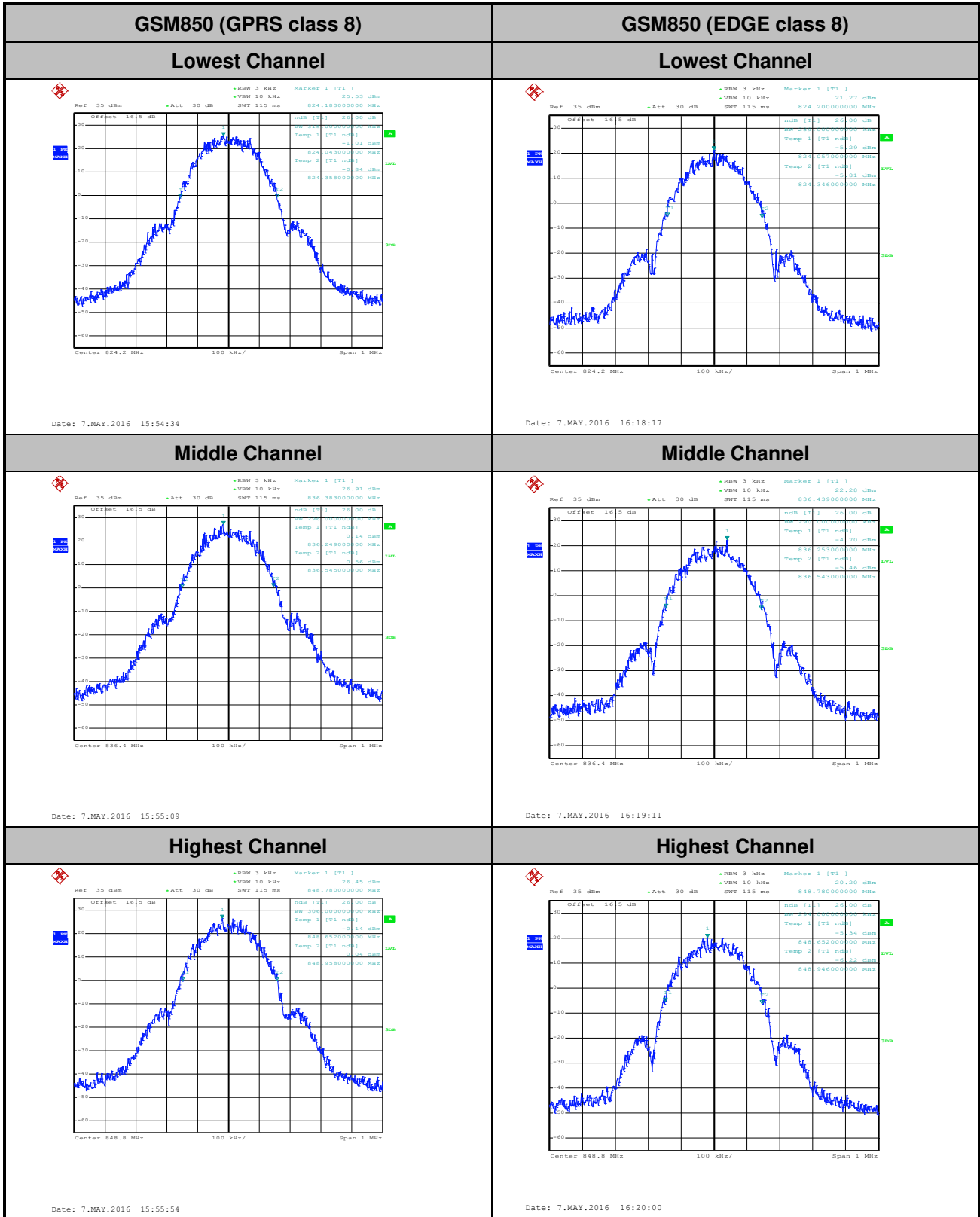

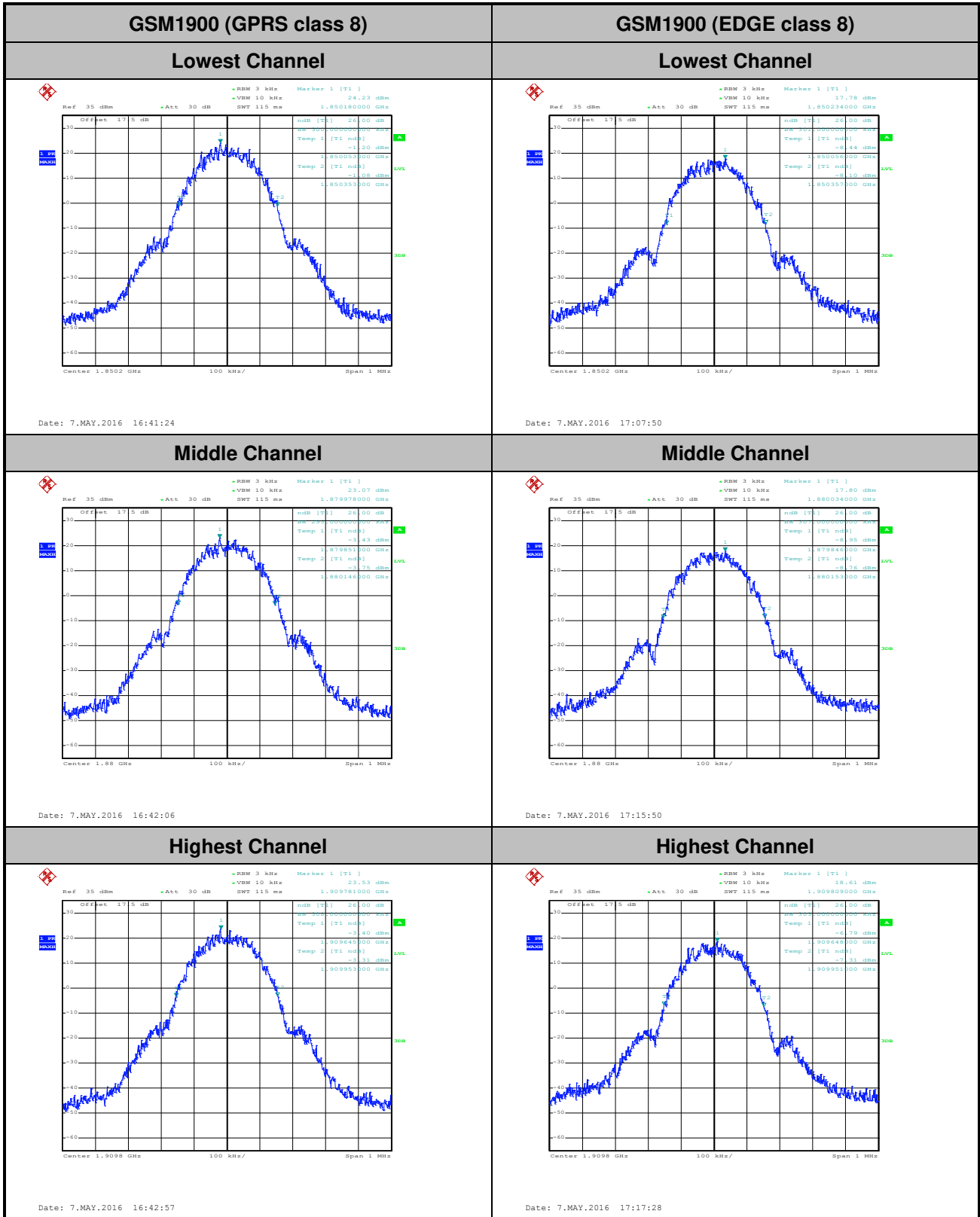



### Occupied Bandwidth

Mode	GSM850	
Mod.	GPRS class 8	EDGE class 8
Lowest CH	0.245	0.245
Middle CH	0.245	0.242
Highest CH	0.244	0.239

Mode	GSM1900	
Mod.	GPRS class 8	EDGE class 8
Lowest CH	0.243	0.243
Middle CH	0.243	0.245
Highest CH	0.243	0.245



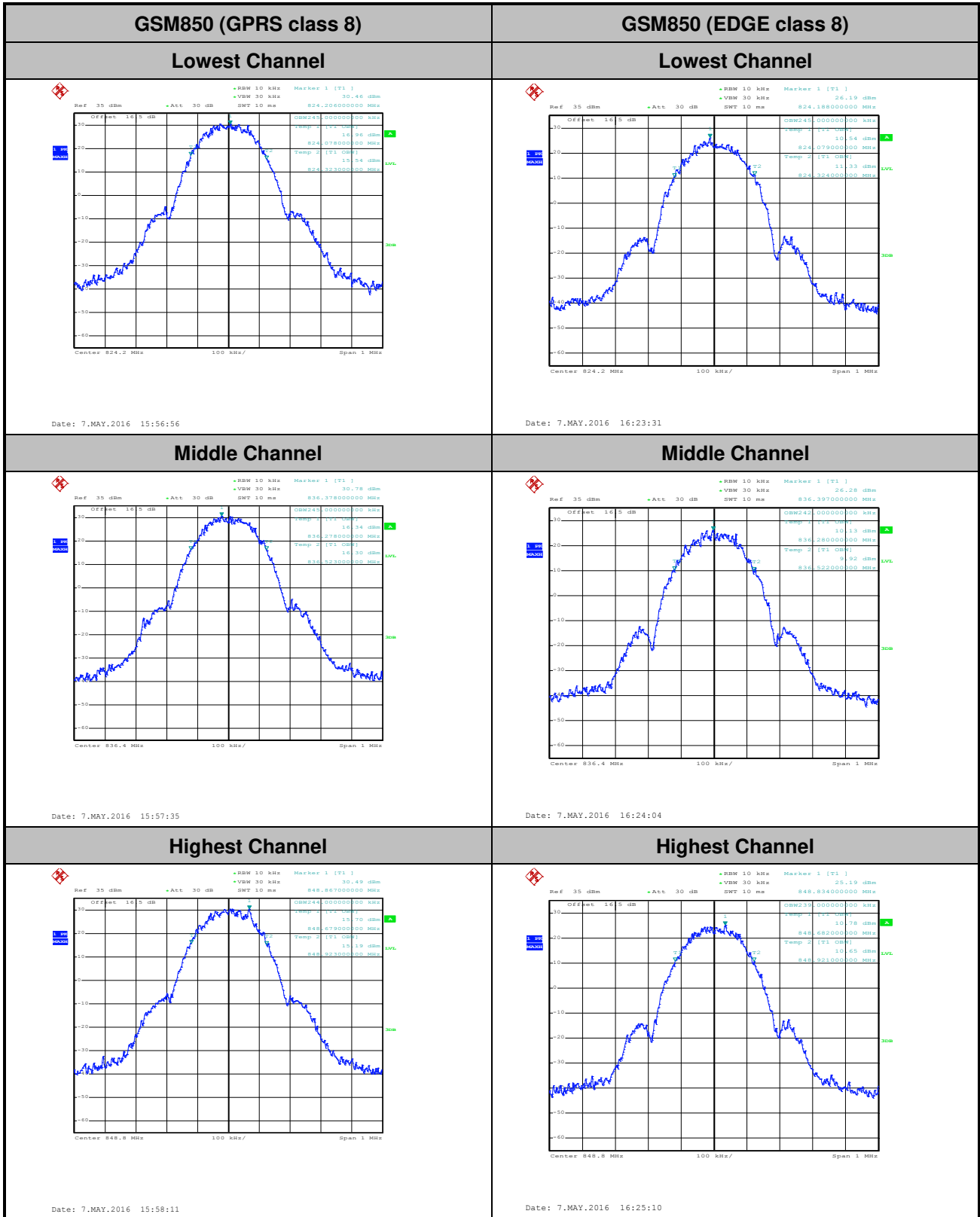



GSM1900 (GPRS class 8)

Lowest Channel

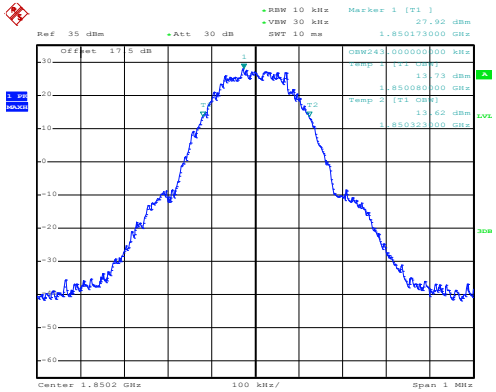

Date: 7.MAY.2016 16:46:28

GSM1900 (EDGE class 8)

Lowest Channel

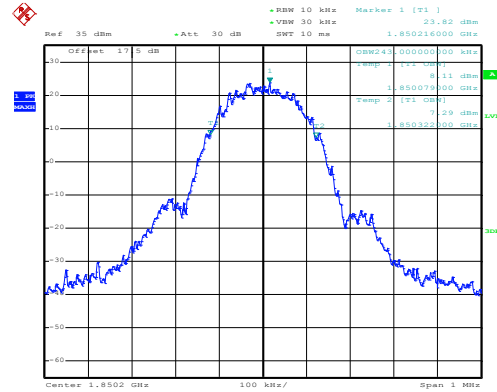

Date: 7.MAY.2016 17:18:36

Middle Channel

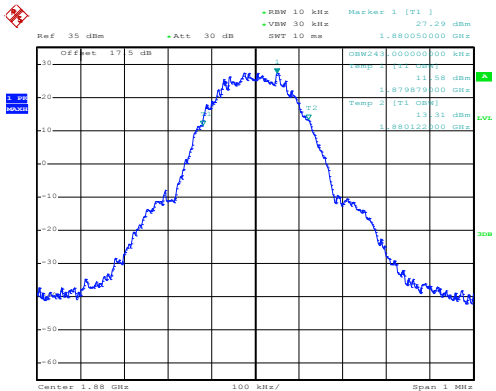

Date: 7.MAY.2016 16:47:05

Middle Channel

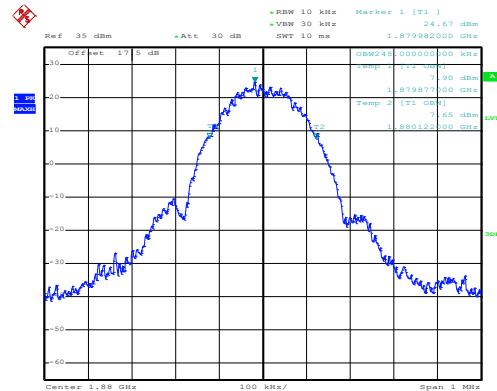

Date: 7.MAY.2016 17:19:13

Highest Channel

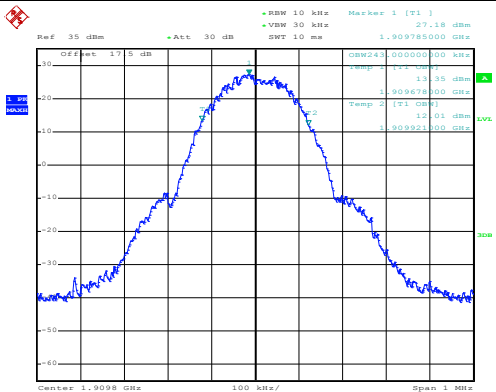

Date: 7.MAY.2016 16:48:06

Highest Channel

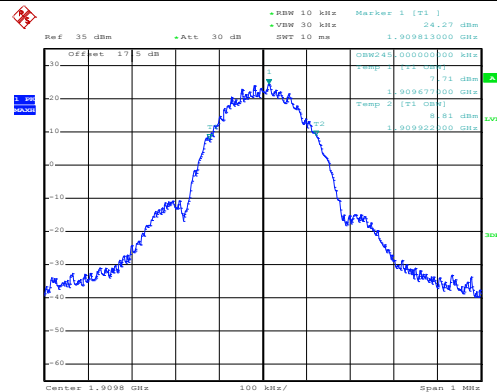

Date: 7.MAY.2016 17:19:51



**Conducted Band Edge**



**GSM850 (GPRS class 8)**

**Lowest Band Edge**

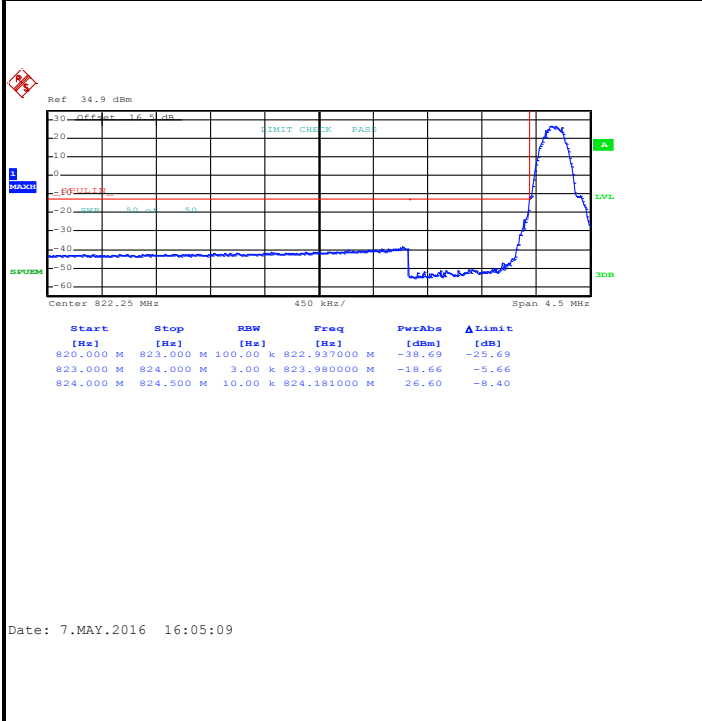

**Highest Band Edge**

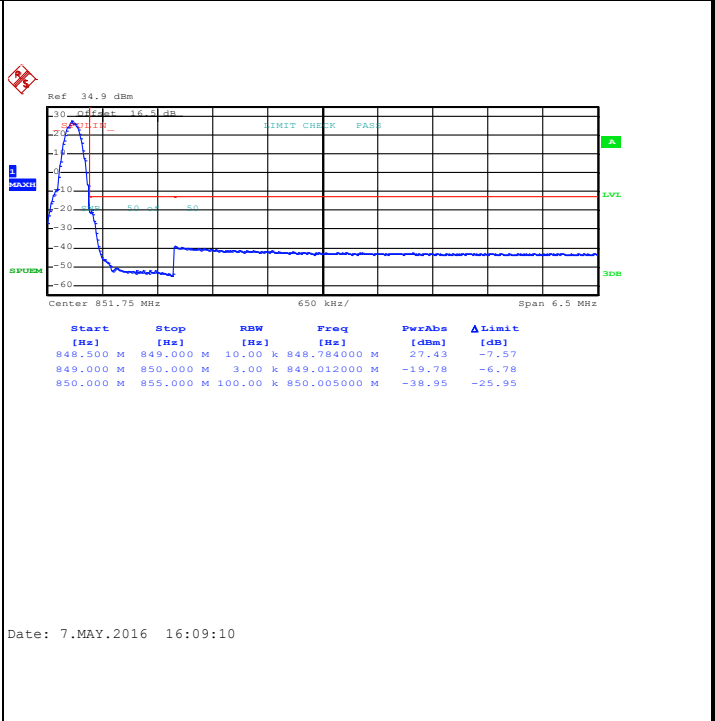

**GSM850 (EDGE class 8)**

**Lowest Band Edge**

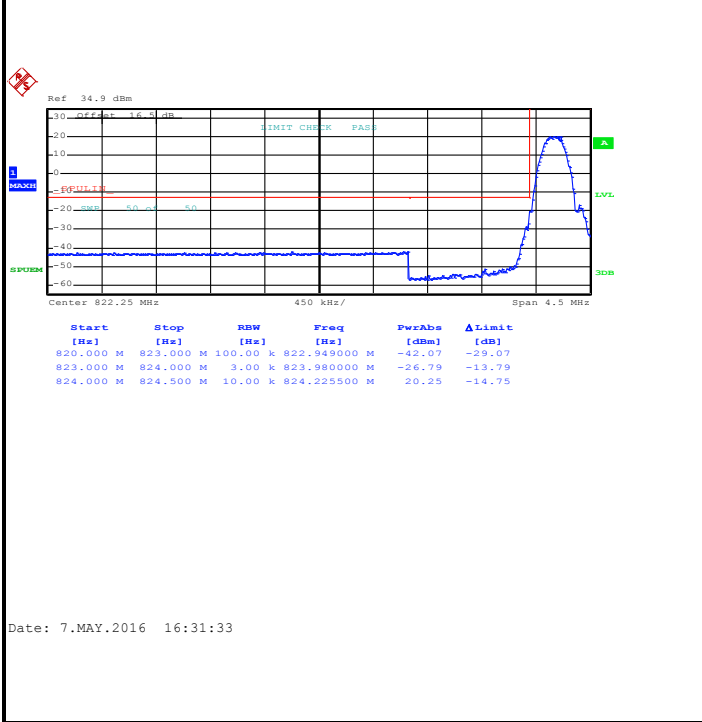

**Highest Band Edge**

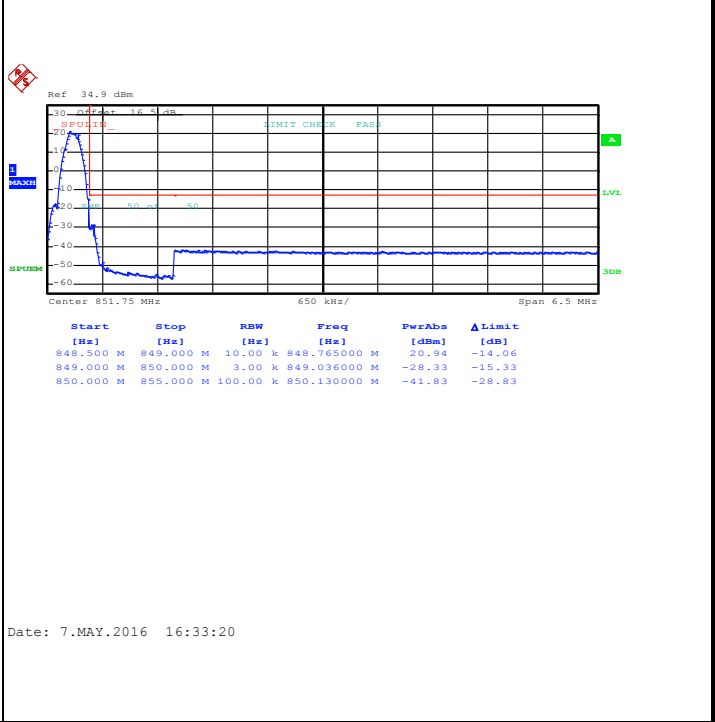



GSM1900 (GPRS class 8)

Lowest Band Edge

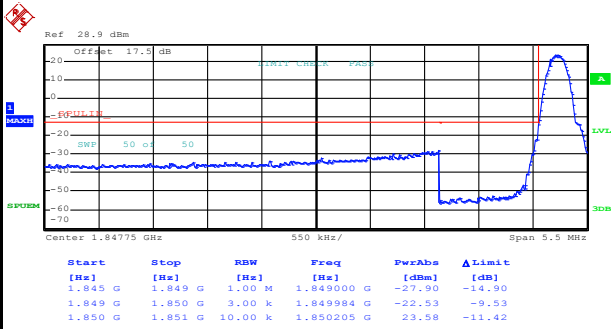

Date: 7.MAY.2016 16:54:30

Highest Band Edge

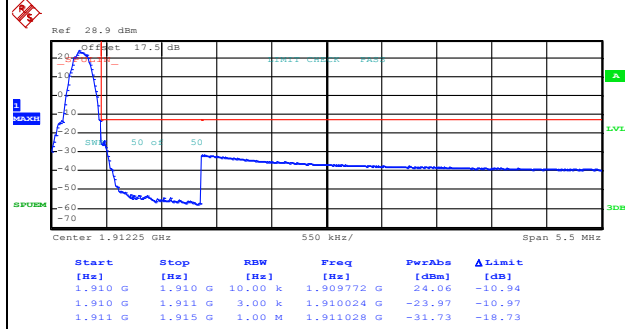

Date: 7.MAY.2016 16:56:04

GSM1900 (EDGE class 8)

Lowest Band Edge

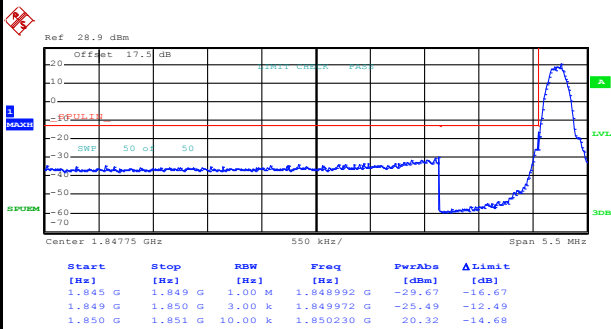

Date: 7.MAY.2016 17:27:28

Highest Band Edge

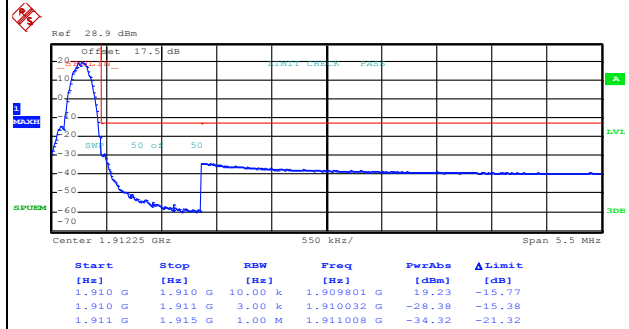

Date: 7.MAY.2016 17:29:13



**Conducted Spurious Emission**

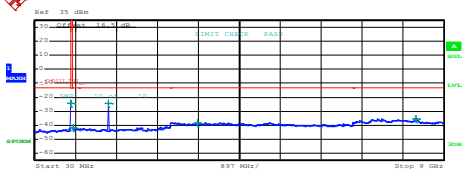
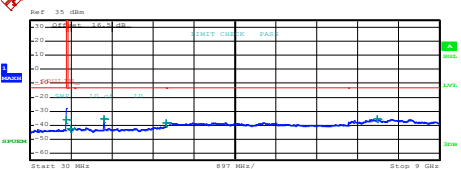
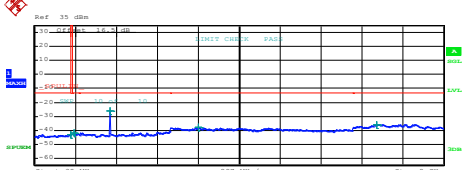
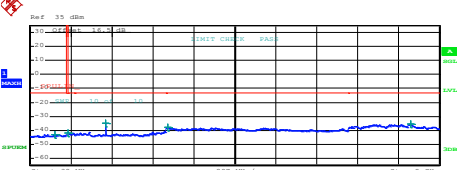
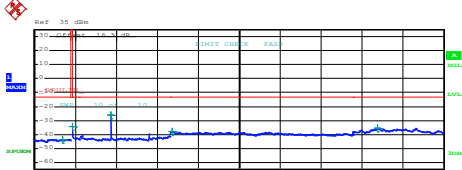
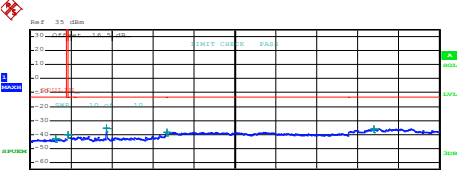

GSM850 (GPRS class 8)	GSM850 (EDGE class 8)																																																																								
Lowest Channel	Lowest Channel																																																																								
 <table border="1" data-bbox="239 616 638 705"> <thead> <tr> <th>Start [Hz]</th> <th>Stop [Hz]</th> <th>RBW [Hz]</th> <th>Freq [Hz]</th> <th>PwrAve [dBm]</th> <th>ΔLimit [dB]</th> </tr> </thead> <tbody> <tr> <td>30,000 M</td> <td>820,000 M</td> <td>1,000 M</td> <td>819,802500 M</td> <td>-24.50</td> <td>-21.50</td> </tr> <tr> <td>855,000 M</td> <td>1,000 G</td> <td>1,000 M</td> <td>870,696250 M</td> <td>-41.98</td> <td>-28.98</td> </tr> <tr> <td>1,000 G</td> <td>3,000 G</td> <td>1,000 M</td> <td>1,6488000 G</td> <td>-24.35</td> <td>-21.35</td> </tr> <tr> <td>3,000 G</td> <td>7,000 G</td> <td>1,000 M</td> <td>3,0020000 G</td> <td>-38.15</td> <td>-25.15</td> </tr> <tr> <td>7,000 G</td> <td>9,000 G</td> <td>1,000 M</td> <td>8,3890000 G</td> <td>-35.31</td> <td>-22.31</td> </tr> </tbody> </table> <p data-bbox="207 884 383 898">Date: 7.MAY.2016 15:59:46</p>	Start [Hz]	Stop [Hz]	RBW [Hz]	Freq [Hz]	PwrAve [dBm]	ΔLimit [dB]	30,000 M	820,000 M	1,000 M	819,802500 M	-24.50	-21.50	855,000 M	1,000 G	1,000 M	870,696250 M	-41.98	-28.98	1,000 G	3,000 G	1,000 M	1,6488000 G	-24.35	-21.35	3,000 G	7,000 G	1,000 M	3,0020000 G	-38.15	-25.15	7,000 G	9,000 G	1,000 M	8,3890000 G	-35.31	-22.31	 <table border="1" data-bbox="893 616 1292 705"> <thead> <tr> <th>Start [Hz]</th> <th>Stop [Hz]</th> <th>RBW [Hz]</th> <th>Freq [Hz]</th> <th>PwrAve [dBm]</th> <th>ΔLimit [dB]</th> </tr> </thead> <tbody> <tr> <td>30,000 M</td> <td>820,000 M</td> <td>1,000 M</td> <td>819,802500 M</td> <td>-24.17</td> <td>-21.17</td> </tr> <tr> <td>855,000 M</td> <td>1,000 G</td> <td>1,000 M</td> <td>906,547504 M</td> <td>-42.52</td> <td>-29.52</td> </tr> <tr> <td>1,000 G</td> <td>3,000 G</td> <td>1,000 M</td> <td>1,6488000 G</td> <td>-25.42</td> <td>-22.42</td> </tr> <tr> <td>3,000 G</td> <td>7,000 G</td> <td>1,000 M</td> <td>3,0030000 G</td> <td>-38.12</td> <td>-25.12</td> </tr> <tr> <td>7,000 G</td> <td>9,000 G</td> <td>1,000 M</td> <td>7,6410000 G</td> <td>-35.72</td> <td>-22.72</td> </tr> </tbody> </table> <p data-bbox="861 884 1037 898">Date: 7.MAY.2016 16:26:18</p>	Start [Hz]	Stop [Hz]	RBW [Hz]	Freq [Hz]	PwrAve [dBm]	ΔLimit [dB]	30,000 M	820,000 M	1,000 M	819,802500 M	-24.17	-21.17	855,000 M	1,000 G	1,000 M	906,547504 M	-42.52	-29.52	1,000 G	3,000 G	1,000 M	1,6488000 G	-25.42	-22.42	3,000 G	7,000 G	1,000 M	3,0030000 G	-38.12	-25.12	7,000 G	9,000 G	1,000 M	7,6410000 G	-35.72	-22.72
Start [Hz]	Stop [Hz]	RBW [Hz]	Freq [Hz]	PwrAve [dBm]	ΔLimit [dB]																																																																				
30,000 M	820,000 M	1,000 M	819,802500 M	-24.50	-21.50																																																																				
855,000 M	1,000 G	1,000 M	870,696250 M	-41.98	-28.98																																																																				
1,000 G	3,000 G	1,000 M	1,6488000 G	-24.35	-21.35																																																																				
3,000 G	7,000 G	1,000 M	3,0020000 G	-38.15	-25.15																																																																				
7,000 G	9,000 G	1,000 M	8,3890000 G	-35.31	-22.31																																																																				
Start [Hz]	Stop [Hz]	RBW [Hz]	Freq [Hz]	PwrAve [dBm]	ΔLimit [dB]																																																																				
30,000 M	820,000 M	1,000 M	819,802500 M	-24.17	-21.17																																																																				
855,000 M	1,000 G	1,000 M	906,547504 M	-42.52	-29.52																																																																				
1,000 G	3,000 G	1,000 M	1,6488000 G	-25.42	-22.42																																																																				
3,000 G	7,000 G	1,000 M	3,0030000 G	-38.12	-25.12																																																																				
7,000 G	9,000 G	1,000 M	7,6410000 G	-35.72	-22.72																																																																				
Middle Channel	Middle Channel																																																																								
 <table border="1" data-bbox="239 1131 638 1220"> <thead> <tr> <th>Start [Hz]</th> <th>Stop [Hz]</th> <th>RBW [Hz]</th> <th>Freq [Hz]</th> <th>PwrAve [dBm]</th> <th>ΔLimit [dB]</th> </tr> </thead> <tbody> <tr> <td>30,000 M</td> <td>820,000 M</td> <td>1,000 M</td> <td>812,492500 M</td> <td>-43.22</td> <td>-30.22</td> </tr> <tr> <td>855,000 M</td> <td>1,000 G</td> <td>1,000 M</td> <td>890,491253 M</td> <td>-42.73</td> <td>-29.73</td> </tr> <tr> <td>1,000 G</td> <td>3,000 G</td> <td>1,000 M</td> <td>1,6725000 G</td> <td>-25.88</td> <td>-12.88</td> </tr> <tr> <td>3,000 G</td> <td>7,000 G</td> <td>1,000 M</td> <td>3,0100000 G</td> <td>-37.77</td> <td>-24.77</td> </tr> <tr> <td>7,000 G</td> <td>9,000 G</td> <td>1,000 M</td> <td>7,0335000 G</td> <td>-35.78</td> <td>-22.78</td> </tr> </tbody> </table> <p data-bbox="207 1400 383 1413">Date: 7.MAY.2016 16:00:40</p>	Start [Hz]	Stop [Hz]	RBW [Hz]	Freq [Hz]	PwrAve [dBm]	ΔLimit [dB]	30,000 M	820,000 M	1,000 M	812,492500 M	-43.22	-30.22	855,000 M	1,000 G	1,000 M	890,491253 M	-42.73	-29.73	1,000 G	3,000 G	1,000 M	1,6725000 G	-25.88	-12.88	3,000 G	7,000 G	1,000 M	3,0100000 G	-37.77	-24.77	7,000 G	9,000 G	1,000 M	7,0335000 G	-35.78	-22.78	 <table border="1" data-bbox="893 1131 1292 1220"> <thead> <tr> <th>Start [Hz]</th> <th>Stop [Hz]</th> <th>RBW [Hz]</th> <th>Freq [Hz]</th> <th>PwrAve [dBm]</th> <th>ΔLimit [dB]</th> </tr> </thead> <tbody> <tr> <td>30,000 M</td> <td>820,000 M</td> <td>1,000 M</td> <td>870,750000 M</td> <td>-42.93</td> <td>-29.93</td> </tr> <tr> <td>855,000 M</td> <td>1,000 G</td> <td>1,000 M</td> <td>859,930000 M</td> <td>-42.10</td> <td>-29.10</td> </tr> <tr> <td>1,000 G</td> <td>3,000 G</td> <td>1,000 M</td> <td>1,6730000 G</td> <td>-34.87</td> <td>-21.87</td> </tr> <tr> <td>3,000 G</td> <td>7,000 G</td> <td>1,000 M</td> <td>3,0450000 G</td> <td>-37.91</td> <td>-24.91</td> </tr> <tr> <td>7,000 G</td> <td>9,000 G</td> <td>1,000 M</td> <td>8,3720000 G</td> <td>-35.42</td> <td>-22.42</td> </tr> </tbody> </table> <p data-bbox="861 1400 1037 1413">Date: 7.MAY.2016 16:27:12</p>	Start [Hz]	Stop [Hz]	RBW [Hz]	Freq [Hz]	PwrAve [dBm]	ΔLimit [dB]	30,000 M	820,000 M	1,000 M	870,750000 M	-42.93	-29.93	855,000 M	1,000 G	1,000 M	859,930000 M	-42.10	-29.10	1,000 G	3,000 G	1,000 M	1,6730000 G	-34.87	-21.87	3,000 G	7,000 G	1,000 M	3,0450000 G	-37.91	-24.91	7,000 G	9,000 G	1,000 M	8,3720000 G	-35.42	-22.42
Start [Hz]	Stop [Hz]	RBW [Hz]	Freq [Hz]	PwrAve [dBm]	ΔLimit [dB]																																																																				
30,000 M	820,000 M	1,000 M	812,492500 M	-43.22	-30.22																																																																				
855,000 M	1,000 G	1,000 M	890,491253 M	-42.73	-29.73																																																																				
1,000 G	3,000 G	1,000 M	1,6725000 G	-25.88	-12.88																																																																				
3,000 G	7,000 G	1,000 M	3,0100000 G	-37.77	-24.77																																																																				
7,000 G	9,000 G	1,000 M	7,0335000 G	-35.78	-22.78																																																																				
Start [Hz]	Stop [Hz]	RBW [Hz]	Freq [Hz]	PwrAve [dBm]	ΔLimit [dB]																																																																				
30,000 M	820,000 M	1,000 M	870,750000 M	-42.93	-29.93																																																																				
855,000 M	1,000 G	1,000 M	859,930000 M	-42.10	-29.10																																																																				
1,000 G	3,000 G	1,000 M	1,6730000 G	-34.87	-21.87																																																																				
3,000 G	7,000 G	1,000 M	3,0450000 G	-37.91	-24.91																																																																				
7,000 G	9,000 G	1,000 M	8,3720000 G	-35.42	-22.42																																																																				
Highest Channel	Highest Channel																																																																								
 <table border="1" data-bbox="239 1646 638 1736"> <thead> <tr> <th>Start [Hz]</th> <th>Stop [Hz]</th> <th>RBW [Hz]</th> <th>Freq [Hz]</th> <th>PwrAve [dBm]</th> <th>ΔLimit [dB]</th> </tr> </thead> <tbody> <tr> <td>30,000 M</td> <td>820,000 M</td> <td>1,000 M</td> <td>642,483000 M</td> <td>-43.44</td> <td>-30.44</td> </tr> <tr> <td>855,000 M</td> <td>1,000 G</td> <td>1,000 M</td> <td>850,072500 M</td> <td>-34.17</td> <td>-21.17</td> </tr> <tr> <td>1,000 G</td> <td>3,000 G</td> <td>1,000 M</td> <td>1,6975000 G</td> <td>-26.30</td> <td>-13.30</td> </tr> <tr> <td>3,000 G</td> <td>7,000 G</td> <td>1,000 M</td> <td>3,0360000 G</td> <td>-38.04</td> <td>-25.04</td> </tr> <tr> <td>7,000 G</td> <td>9,000 G</td> <td>1,000 M</td> <td>7,5440000 G</td> <td>-35.43</td> <td>-22.43</td> </tr> </tbody> </table> <p data-bbox="207 1915 383 1928">Date: 7.MAY.2016 16:01:32</p>	Start [Hz]	Stop [Hz]	RBW [Hz]	Freq [Hz]	PwrAve [dBm]	ΔLimit [dB]	30,000 M	820,000 M	1,000 M	642,483000 M	-43.44	-30.44	855,000 M	1,000 G	1,000 M	850,072500 M	-34.17	-21.17	1,000 G	3,000 G	1,000 M	1,6975000 G	-26.30	-13.30	3,000 G	7,000 G	1,000 M	3,0360000 G	-38.04	-25.04	7,000 G	9,000 G	1,000 M	7,5440000 G	-35.43	-22.43	 <table border="1" data-bbox="893 1646 1292 1736"> <thead> <tr> <th>Start [Hz]</th> <th>Stop [Hz]</th> <th>RBW [Hz]</th> <th>Freq [Hz]</th> <th>PwrAve [dBm]</th> <th>ΔLimit [dB]</th> </tr> </thead> <tbody> <tr> <td>30,000 M</td> <td>820,000 M</td> <td>1,000 M</td> <td>590,000000 M</td> <td>-43.22</td> <td>-30.22</td> </tr> <tr> <td>855,000 M</td> <td>1,000 G</td> <td>1,000 M</td> <td>853,217500 M</td> <td>-40.04</td> <td>-27.04</td> </tr> <tr> <td>1,000 G</td> <td>3,000 G</td> <td>1,000 M</td> <td>1,6980000 G</td> <td>-25.28</td> <td>-12.28</td> </tr> <tr> <td>3,000 G</td> <td>7,000 G</td> <td>1,000 M</td> <td>3,0210000 G</td> <td>-38.30</td> <td>-25.30</td> </tr> <tr> <td>7,000 G</td> <td>9,000 G</td> <td>1,000 M</td> <td>7,5660000 G</td> <td>-35.81</td> <td>-22.81</td> </tr> </tbody> </table> <p data-bbox="861 1915 1037 1928">Date: 7.MAY.2016 16:28:10</p>	Start [Hz]	Stop [Hz]	RBW [Hz]	Freq [Hz]	PwrAve [dBm]	ΔLimit [dB]	30,000 M	820,000 M	1,000 M	590,000000 M	-43.22	-30.22	855,000 M	1,000 G	1,000 M	853,217500 M	-40.04	-27.04	1,000 G	3,000 G	1,000 M	1,6980000 G	-25.28	-12.28	3,000 G	7,000 G	1,000 M	3,0210000 G	-38.30	-25.30	7,000 G	9,000 G	1,000 M	7,5660000 G	-35.81	-22.81
Start [Hz]	Stop [Hz]	RBW [Hz]	Freq [Hz]	PwrAve [dBm]	ΔLimit [dB]																																																																				
30,000 M	820,000 M	1,000 M	642,483000 M	-43.44	-30.44																																																																				
855,000 M	1,000 G	1,000 M	850,072500 M	-34.17	-21.17																																																																				
1,000 G	3,000 G	1,000 M	1,6975000 G	-26.30	-13.30																																																																				
3,000 G	7,000 G	1,000 M	3,0360000 G	-38.04	-25.04																																																																				
7,000 G	9,000 G	1,000 M	7,5440000 G	-35.43	-22.43																																																																				
Start [Hz]	Stop [Hz]	RBW [Hz]	Freq [Hz]	PwrAve [dBm]	ΔLimit [dB]																																																																				
30,000 M	820,000 M	1,000 M	590,000000 M	-43.22	-30.22																																																																				
855,000 M	1,000 G	1,000 M	853,217500 M	-40.04	-27.04																																																																				
1,000 G	3,000 G	1,000 M	1,6980000 G	-25.28	-12.28																																																																				
3,000 G	7,000 G	1,000 M	3,0210000 G	-38.30	-25.30																																																																				
7,000 G	9,000 G	1,000 M	7,5660000 G	-35.81	-22.81																																																																				

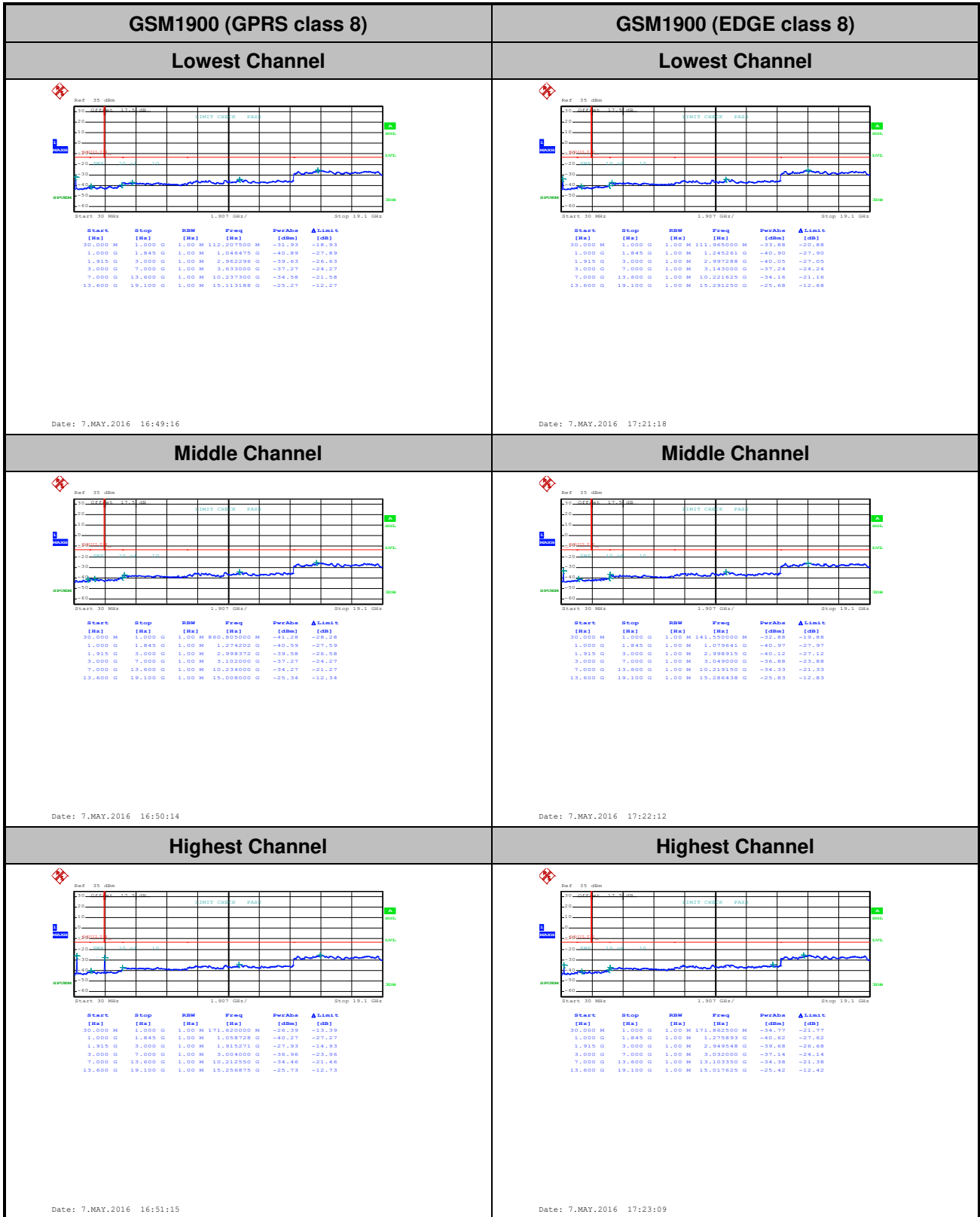





**Frequency Stability**

Test Conditions Temperature (°C)	Middle Channel Voltage (Volt)	GSM850 (GPRS class 8)	GSM850 (EDGE class 8)	Limit 2.5ppm
		Deviation (ppm)		Result
50	Normal Voltage	0.0012	0.0060	PASS
40	Normal Voltage	0.0012	0.0012	
30	Normal Voltage	0.0024	0.0012	
20(Ref.)	Normal Voltage	0.0000	0.0000	
10	Normal Voltage	0.0048	0.0024	
0	Normal Voltage	0.0012	0.0012	
-10	Normal Voltage	0.0060	0.0048	
-20	Normal Voltage	0.0036	0.0024	
-30	Normal Voltage	0.0000	0.0024	
20	Maximum Voltage	0.0048	0.0036	
20	Normal Voltage	0.0036	0.0012	
20	Battery End Point	0.0012	0.0048	

Test Conditions Temperature (°C)	Middle Channel Voltage (Volt)	GSM1900 (GPRS class 8)	GSM1900 (EDGE class 8)	Limit Note 2.
		Deviation (ppm)		Result
50	Normal Voltage	0.0011	0.0043	PASS
40	Normal Voltage	0.0005	0.0027	
30	Normal Voltage	0.0016	0.0021	
20(Ref.)	Normal Voltage	0.0000	0.0000	
10	Normal Voltage	0.0021	0.0032	
0	Normal Voltage	0.0005	0.0011	
-10	Normal Voltage	0.0005	0.0048	
-20	Normal Voltage	0.0016	0.0043	
-30	Normal Voltage	0.0000	0.0027	
20	Maximum Voltage	0.0005	0.0000	
20	Normal Voltage	0.0000	0.0021	
20	Battery End Point	0.0011	0.0043	

**Note:**

1. Normal Voltage = 4.0V. ; Battery End Point (BEP) = 3.6 V. ; Maximum Voltage =4.4 V
2. The frequency fundamental emissions stay within the authorized frequency block based on the frequency deviation measured is small.



## A2. WCDMA

### Peak-to-Average Ratio

Mode	WCDMA Band V	WCDMA Band II	WCDMA Band IV	Limit: 13dB
Mod.	RMC 12.2Kbps	RMC 12.2Kbps	RMC 12.2Kbps	Result
Lowest CH	2.88	3.48	3.24	PASS
Middle CH	2.96	3.36	3.28	
Highest CH	2.88	3.52	3.28	

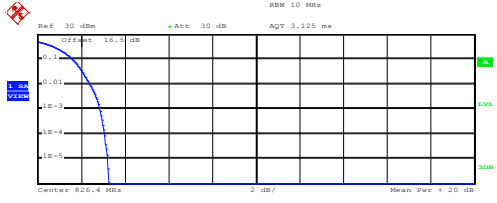
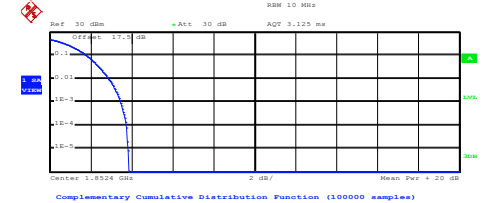
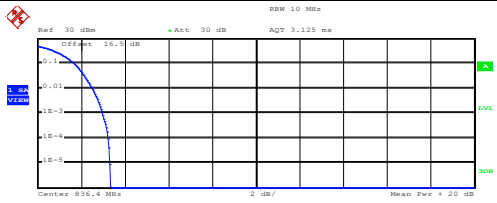
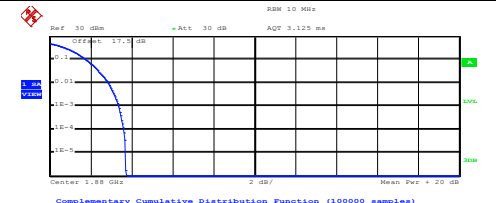
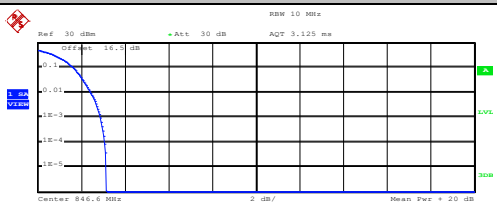
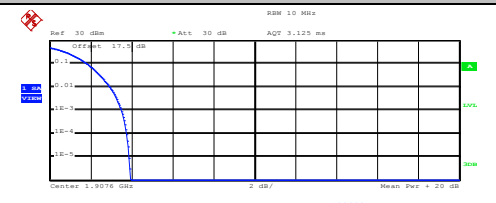

WCDMA Band V (RMC 12.2Kbps)	WCDMA Band II (RMC 12.2Kbps)
<p align="center"><b>Lowest Channel</b></p>  <p>Center 826.4 MHz      2 dB/      Mean Pwr + 20 dB</p> <p>Complementary Cumulative Distribution Function (100000 samples)</p> <p>Trace 1</p> <p>Mean 20.58 dBm Peak 23.83 dBm Crest 3.25 dB</p> <p>10 % 1.60 dB 1 % 2.40 dB .1 % 2.88 dB .01 % 3.08 dB</p> <p>Date: 7.MAY.2016 19:08:35</p>	<p align="center"><b>Lowest Channel</b></p>  <p>Center 1.8524 GHz      2 dB/      Mean Pwr + 20 dB</p> <p>Complementary Cumulative Distribution Function (100000 samples)</p> <p>Trace 1</p> <p>Mean 19.40 dBm Peak 23.27 dBm Crest 3.86 dB</p> <p>10 % 1.80 dB 1 % 2.88 dB .1 % 3.48 dB .01 % 3.76 dB</p> <p>Date: 7.MAY.2016 17:53:14</p>
<p align="center"><b>Middle Channel</b></p>  <p>Center 836.0 MHz      2 dB/      Mean Pwr + 20 dB</p> <p>Complementary Cumulative Distribution Function (100000 samples)</p> <p>Trace 1</p> <p>Mean 20.51 dBm Peak 23.83 dBm Crest 3.32 dB</p> <p>10 % 1.68 dB 1 % 2.52 dB .1 % 2.96 dB .01 % 3.24 dB</p> <p>Date: 7.MAY.2016 19:08:45</p>	<p align="center"><b>Middle Channel</b></p>  <p>Center 1.88 GHz      2 dB/      Mean Pwr + 20 dB</p> <p>Complementary Cumulative Distribution Function (100000 samples)</p> <p>Trace 1</p> <p>Mean 19.98 dBm Peak 23.69 dBm Crest 3.71 dB</p> <p>10 % 1.76 dB 1 % 2.84 dB .1 % 3.36 dB .01 % 3.64 dB</p> <p>Date: 7.MAY.2016 17:53:24</p>
<p align="center"><b>Highest Channel</b></p>  <p>Center 846.0 MHz      2 dB/      Mean Pwr + 20 dB</p> <p>Complementary Cumulative Distribution Function (100000 samples)</p> <p>Trace 1</p> <p>Mean 20.54 dBm Peak 23.69 dBm Crest 3.15 dB</p> <p>10 % 1.64 dB 1 % 2.44 dB .1 % 2.88 dB .01 % 3.08 dB</p> <p>Date: 7.MAY.2016 19:08:58</p>	<p align="center"><b>Highest Channel</b></p>  <p>Center 1.9076 GHz      2 dB/      Mean Pwr + 20 dB</p> <p>Complementary Cumulative Distribution Function (100000 samples)</p> <p>Trace 1</p> <p>Mean 19.40 dBm Peak 23.34 dBm Crest 3.93 dB</p> <p>10 % 1.84 dB 1 % 2.96 dB .1 % 3.52 dB .01 % 3.76 dB</p> <p>Date: 7.MAY.2016 17:53:33</p>



WCDMA Band IV (RMC 12.2Kbps)

Lowest Channel

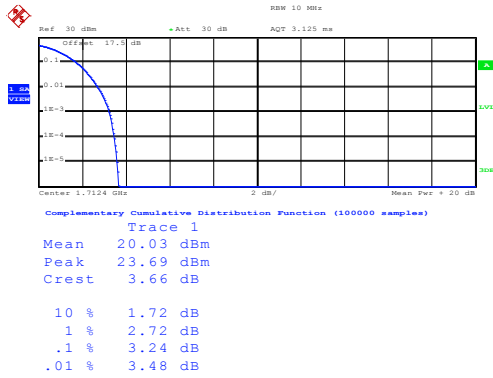

Date: 7.MAY.2016 18:38:22

Middle Channel

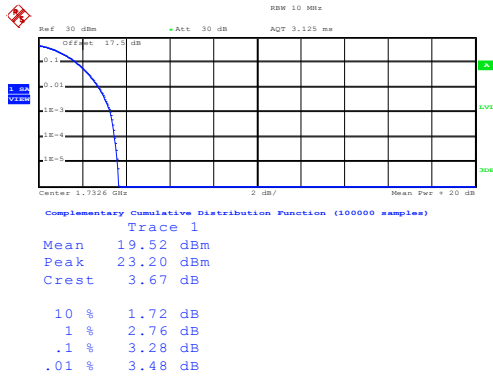

Date: 7.MAY.2016 18:38:32

Highest Channel

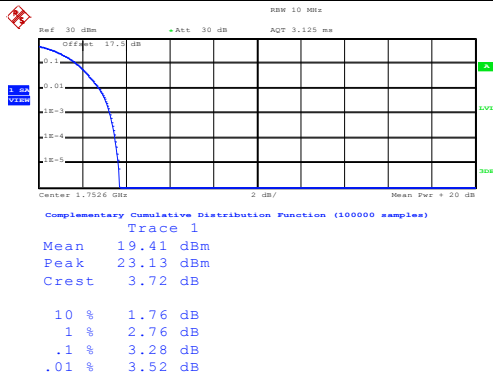

Date: 7.MAY.2016 18:38:41



**26dB Bandwidth**

Mode	WCDMA Band V	WCDMA Band II	WCDMA Band IV
Mod.	RMC 12.2Kbps	RMC 12.2Kbps	RMC 12.2Kbps
Lowest CH	4.73	4.68	4.69
Middle CH	4.73	4.68	4.70
Highest CH	4.74	4.68	4.70



WCDMA Band V (RMC 12.2Kbps)

Lowest Channel

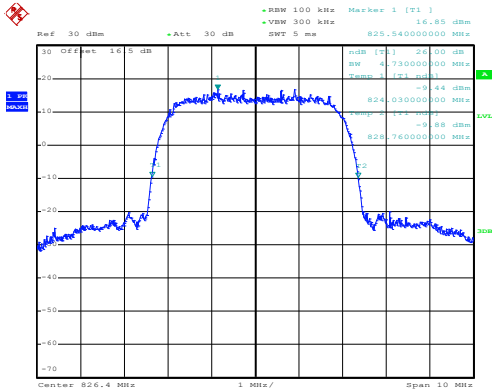

Date: 7.MAY.2016 18:51:35

WCDMA Band II (RMC 12.2Kbps)

Lowest Channel

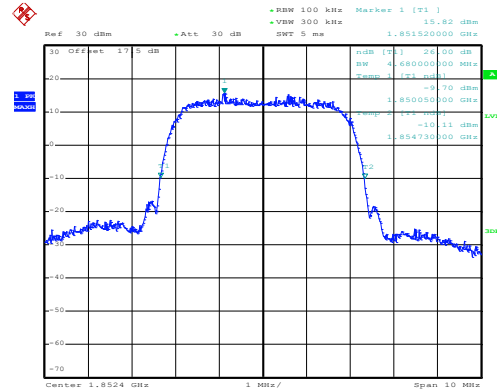

Date: 7.MAY.2016 17:44:46

Middle Channel

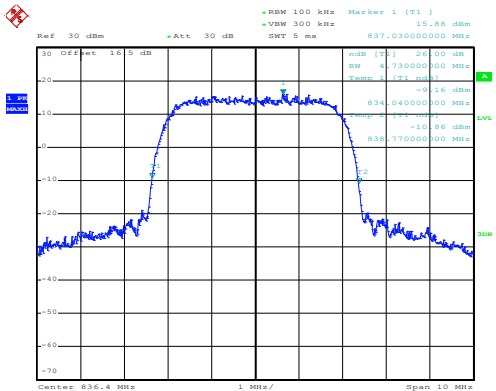

Date: 7.MAY.2016 18:52:03

Middle Channel

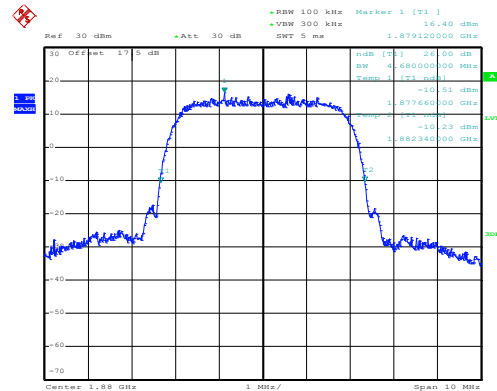

Date: 7.MAY.2016 17:45:20

Highest Channel

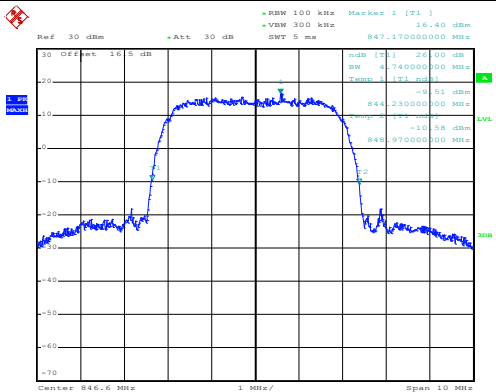

Date: 7.MAY.2016 18:52:31

Highest Channel

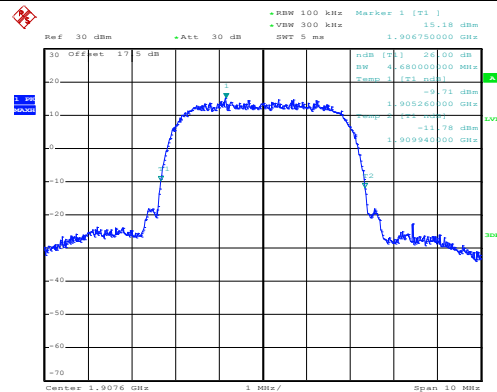

Date: 7.MAY.2016 17:45:48



WCDMA Band IV (RMC 12.2Kbps)

Lowest Channel

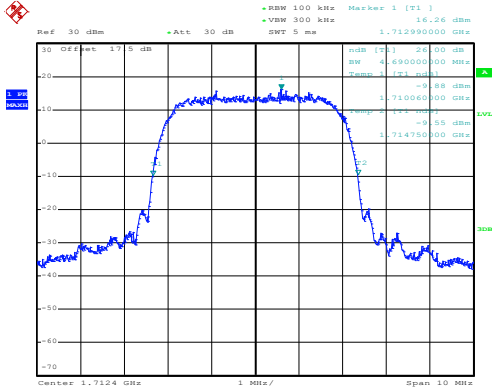

Date: 7.MAY.2016 18:22:29

Middle Channel

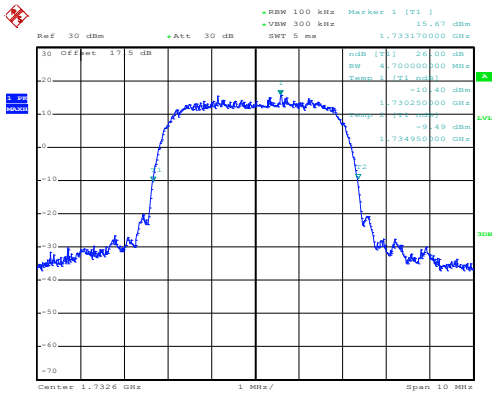

Date: 7.MAY.2016 18:22:57

Highest Channel

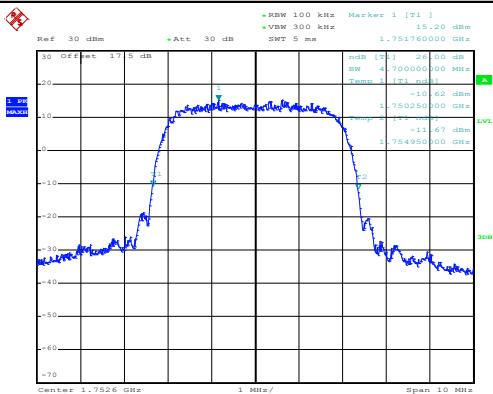

Date: 7.MAY.2016 18:23:25



**Occupied Bandwidth**

Mode	WCDMA Band V	WCDMA Band II	WCDMA Band IV
Mod.	RMC 12.2Kbps	RMC 12.2Kbps	RMC 12.2Kbps
Lowest CH	4.11	4.12	4.11
Middle CH	4.13	4.11	4.11
Highest CH	4.12	4.12	4.13





WCDMA Band V (RMC 12.2Kbps)

Lowest Channel

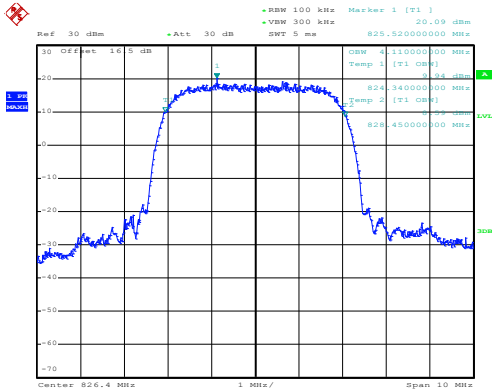

Date: 16.MAY.2016 15:22:15

WCDMA Band II (RMC 12.2Kbps)

Lowest Channel

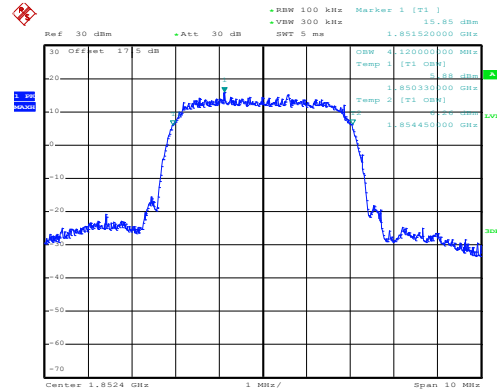

Date: 7.MAY.2016 17:46:59

Middle Channel

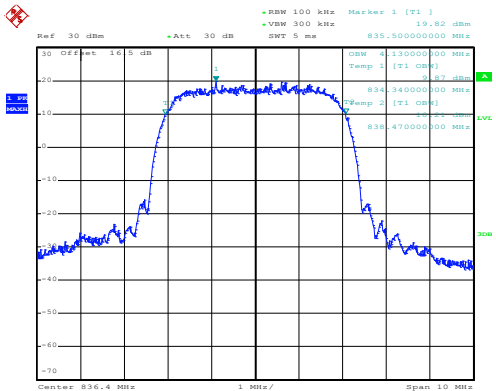

Date: 16.MAY.2016 15:24:13

Middle Channel

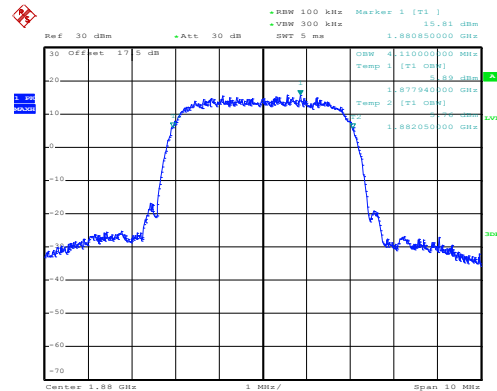

Date: 7.MAY.2016 17:47:27

Highest Channel

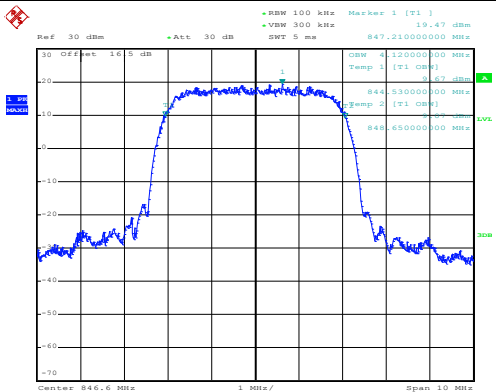

Date: 16.MAY.2016 15:25:18

Highest Channel

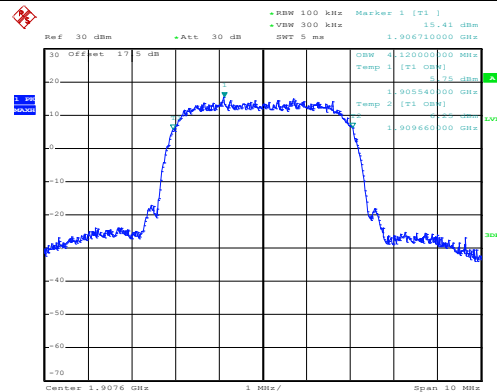

Date: 7.MAY.2016 17:47:55



WCDMA Band IV (RMC 12.2Kbps)

Lowest Channel

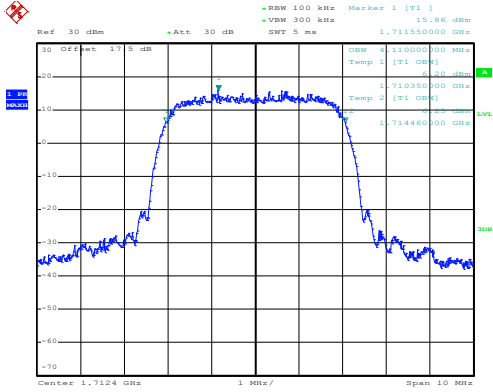

Date: 7.MAY.2016 18:27:07

Middle Channel

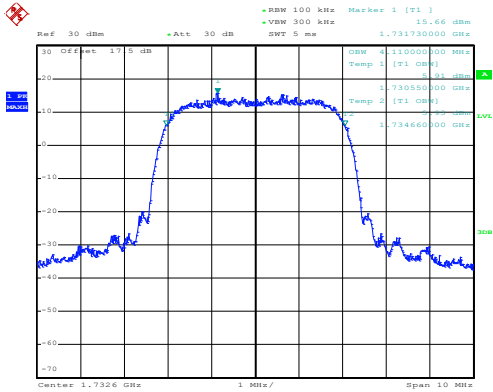

Date: 7.MAY.2016 18:27:35

Highest Channel

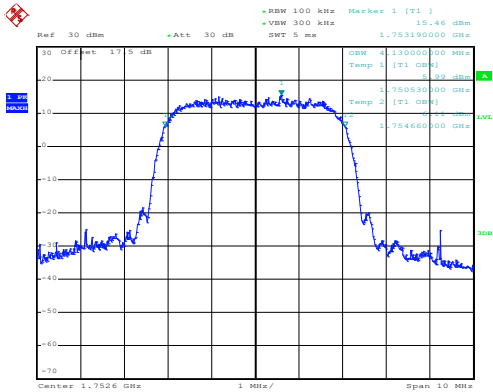

Date: 7.MAY.2016 18:28:03



## **Conducted Band Edge**



WCDMA Band V (RMC 12.2Kbps)

Lowest Band Edge

Highest Band Edge

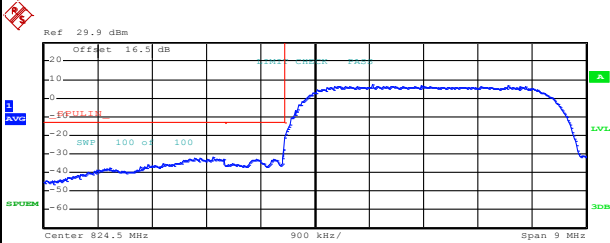

Start [Hz]	Stop [Hz]	RBW [Hz]	Freq [Hz]	PwrAbs [dBm]	ΔLimit [dB]
820.000 M	823.000 M	100.00 k	822.811000 M	-32.03	-19.05
823.000 M	824.000 M	50.00 k	823.896000 M	-28.34	-15.34
824.000 M	829.000 M	100.00 k	825.445000 M	7.22	-27.78

Date: 7.MAY.2016 19:00:49

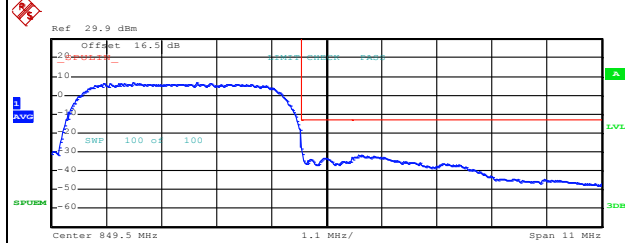

Start [Hz]	Stop [Hz]	RBW [Hz]	Freq [Hz]	PwrAbs [dBm]	ΔLimit [dB]
844.000 M	849.000 M	100.00 k	845.620000 M	6.87	-28.13
849.000 M	850.000 M	50.00 k	849.004000 M	-28.40	-15.40
850.000 M	855.000 M	100.00 k	850.190000 M	-31.88	-18.88

Date: 7.MAY.2016 19:03:32



WCDMA Band II (RMC 12.2Kbps)

Lowest Band Edge

Highest Band Edge

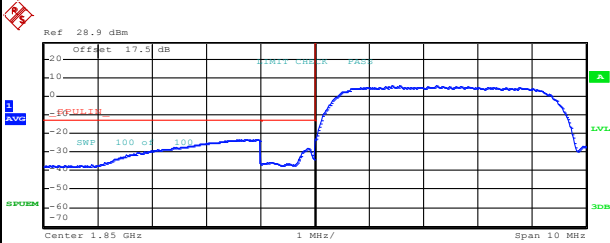

Start [Hz]	Stop [Hz]	RBW [Hz]	Freq [Hz]	PwrAbs [dBm]	ΔLimit [dB]
1.845 G	1.849 G	1.00 M	1.848644 G	-23.45	-10.46
1.849 G	1.850 G	50.00 k	1.849856 G	-28.19	-15.19
1.850 G	1.855 G	100.00 k	1.851565 G	6.03	-28.97

Date: 7.MAY.2016 17:57:26

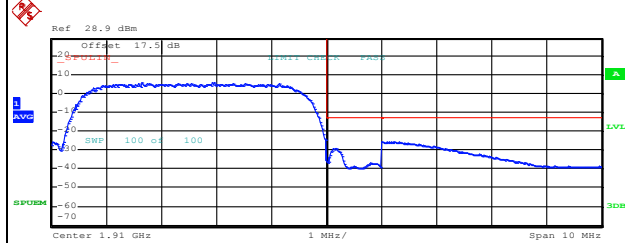

Start [Hz]	Stop [Hz]	RBW [Hz]	Freq [Hz]	PwrAbs [dBm]	ΔLimit [dB]
1.905 G	1.910 G	100.00 k	1.907960 G	5.70	-29.30
1.910 G	1.911 G	50.00 k	1.910116 G	-29.07	-16.07
1.911 G	1.915 G	1.00 M	1.911128 G	-25.84	-12.84

Date: 7.MAY.2016 18:00:09



WCDMA Band IV (RMC 12.2Kbps)

Lowest Band Edge

Highest Band Edge

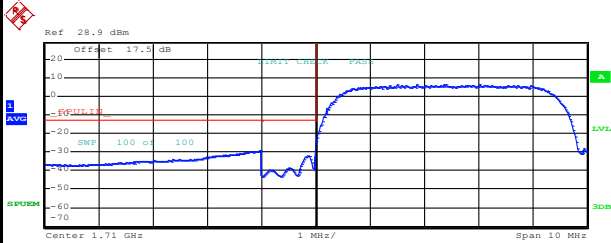

Start [Hz]	Stop [Hz]	RBW [Hz]	Freq [Hz]	PwrAbs [dBm]	ΔLimit [dB]
1.705 G	1.709 G	1.00 M	1.708952 G	-29.52	-16.52
1.709 G	1.710 G	50.00 k	1.709836 G	-31.92	-18.92
1.710 G	1.715 G	100.00 k	1.712360 G	6.37	-28.63

Date: 7.MAY.2016 18:35:08

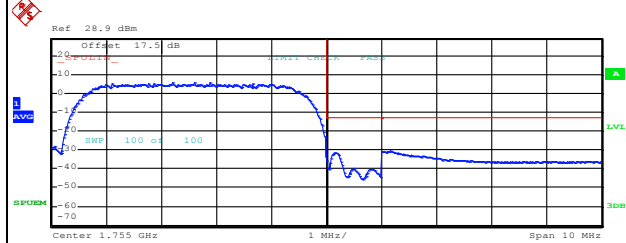

Start [Hz]	Stop [Hz]	RBW [Hz]	Freq [Hz]	PwrAbs [dBm]	ΔLimit [dB]
1.750 G	1.755 G	100.00 k	1.752590 G	5.60	-29.40
1.755 G	1.756 G	50.00 k	1.755144 G	-31.35	-18.35
1.756 G	1.760 G	1.00 M	1.756148 G	-30.74	-17.74

Date: 7.MAY.2016 18:37:51



**Conducted Spurious Emission**



WCDMA Band V (RMC 12.2Kbps)

WCDMA Band II (RMC 12.2Kbps)

Lowest Channel

Lowest Channel

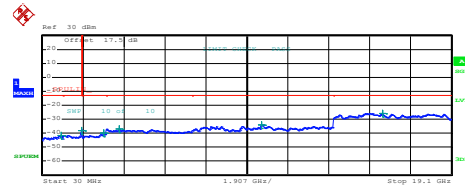
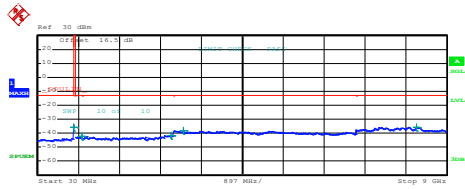

Date: 7.MAY.2016 18:56:02

Date: 7.MAY.2016 17:50:35

Middle Channel

Middle Channel

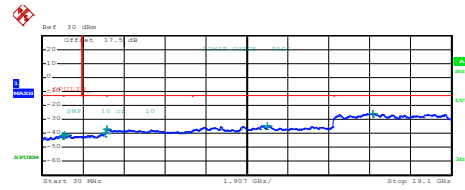
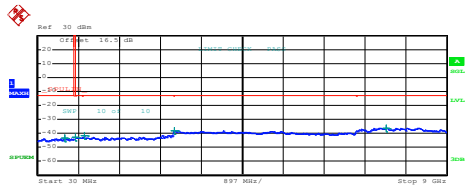

Date: 7.MAY.2016 18:56:48

Date: 7.MAY.2016 17:51:21

Highest Channel

Highest Channel

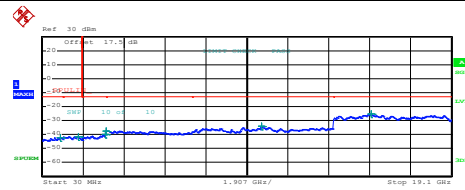
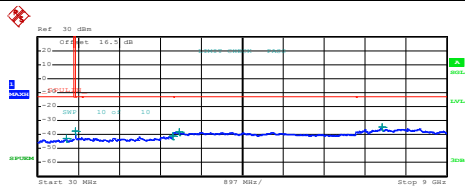

Date: 7.MAY.2016 18:57:33

Date: 7.MAY.2016 17:52:07





WCDMA Band IV (RMC 12.2Kbps)

Lowest Channel

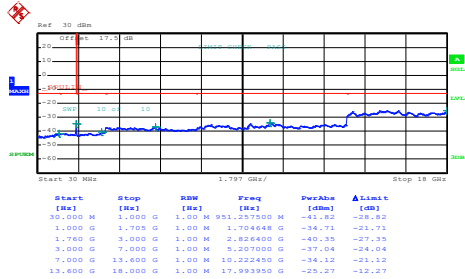

Date: 7.MAY.2016 18:30:00

Middle Channel

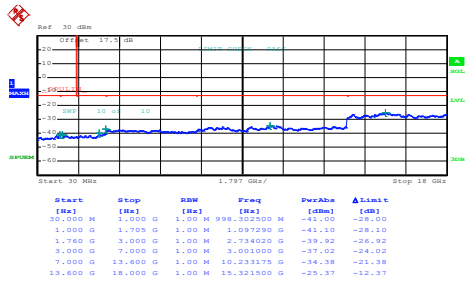

Date: 7.MAY.2016 18:30:46

Highest Channel

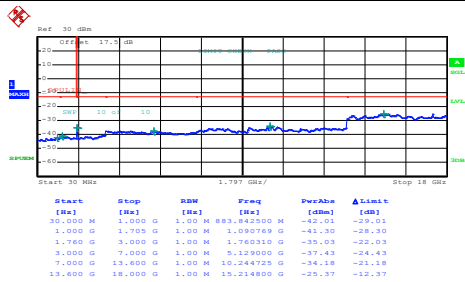

Date: 7.MAY.2016 18:31:32



**Frequency Stability**

Test Conditions Temperature (°C)	Middle Channel Voltage (Volt)	WCDMA Band V (RMC 12.2Kbps)	Limit 2.5ppm
		Deviation (ppm)	Result
50	Normal Voltage	0.0132	PASS
40	Normal Voltage	0.0143	
30	Normal Voltage	0.0012	
20(Ref.)	Normal Voltage	0.0000	
10	Normal Voltage	0.0120	
0	Normal Voltage	0.0143	
-10	Normal Voltage	0.0132	
-20	Normal Voltage	0.0012	
-30	Normal Voltage	0.0000	
20	Maximum Voltage	0.0012	
20	Normal Voltage	0.0143	
20	Battery End Point	0.0012	

Test Conditions Temperature (°C)	Middle Channel Voltage (Volt)	WCDMA Band II (RMC 12.2Kbps)	Limit Note 2.
		Deviation (ppm)	Result
50	Normal Voltage	0.0069	PASS
40	Normal Voltage	0.0059	
30	Normal Voltage	0.0048	
20(Ref.)	Normal Voltage	0.0000	
10	Normal Voltage	0.0064	
0	Normal Voltage	0.0005	
-10	Normal Voltage	0.0053	
-20	Normal Voltage	0.0059	
-30	Normal Voltage	0.0064	
20	Maximum Voltage	0.0005	
20	Normal Voltage	0.0053	
20	Battery End Point	0.0064	

**Note:**

1. Normal Voltage = 4.0V. ; Battery End Point (BEP) = 3.6 V. ; Maximum Voltage =4.4 V
2. The frequency fundamental emissions stay within the authorized frequency block based on the frequency deviation measured is small.



Test Conditions Temperature (°C)	Middle Channel Voltage (Volt)	WCDMA Band IV (RMC 12.2Kbps)	Limit Note 2.
		Deviation (ppm)	Result
50	Normal Voltage	0.0006	PASS
40	Normal Voltage	0.0017	
30	Normal Voltage	0.0012	
20(Ref.)	Normal Voltage	0.0000	
10	Normal Voltage	0.0006	
0	Normal Voltage	0.0012	
-10	Normal Voltage	0.0000	
-20	Normal Voltage	0.0006	
-30	Normal Voltage	0.0012	
20	Maximum Voltage	0.0006	
20	Normal Voltage	0.0000	
20	Battery End Point	0.0017	

**Note:**

- 1. Normal Voltage = 4.0V. ; Battery End Point (BEP) = 3.6 V. ; Maximum Voltage =4.4 V
- 2. The frequency fundamental emissions stay within the authorized frequency block based on the frequency deviation measured is small.



## Appendix B. Test Results of Radiated Test

### ERP/EIRP

Channel	Mode	Horizontal		Vertical	
		ERP(dBm)	ERP(W)	ERP(dBm)	ERP(W)
Lowest	GSM850 GPRS class 8	25.32	0.3404	29.52	0.8954
Middle		25.54	0.3581	28.88	0.7727
Highest		25.76	0.3767	28.36	0.6855
Lowest	GSM850 EDGE class 8	20.28	0.1067	24.25	0.2661
Middle		19.88	0.0973	23.02	0.2004
Highest		19.64	0.0920	21.89	0.1545
Lowest	WCDMA Band V RMC 12.2Kbps	17.13	0.0516	20.88	0.1225
Middle		17.32	0.0540	20.35	0.1084
Highest		17.30	0.0537	19.65	0.0923
Limit	ERP < 7W	Result		PASS	



Channel	Mode	Horizontal		Vertical	
		EIRP(dBm)	EIRP(W)	EIRP(dBm)	EIRP(W)
Lowest	GSM1900 GPRS class 8	25.66	0.3681	26.44	0.4406
Middle		26.48	0.4446	26.87	0.4864
Highest		26.84	0.4831	27.63	0.5794
Lowest	GSM1900 EDGE class 8	21.06	0.1276	21.48	0.1406
Middle		21.32	0.1355	21.70	0.1479
Highest		22.26	0.1683	22.90	0.1950
Lowest	WCDMA Band II RMC 12.2Kbps	19.17	0.0826	19.57	0.0906
Middle		19.38	0.0867	19.73	0.0940
Highest		19.88	0.0973	20.61	0.1151
Limit	EIRP < 2W	Result		PASS	

Channel	Mode	Horizontal		Vertical	
		EIRP(dBm)	EIRP(W)	EIRP(dBm)	EIRP(W)
Lowest	WCDMA Band IV RMC 12.2Kbps	20.72	0.1180	20.56	0.1138
Middle		20.75	0.1189	20.61	0.1151
Highest		21.24	0.1330	20.64	0.1159
Limit	EIRP < 1W	Result		PASS	



**Radiated Spurious Emission**

<Sample 1>

GSM850 (GPRS class 8)									
Channel	Frequency ( MHz )	ERP ( dBm )	Limit ( dBm )	Over Limit ( dB )	SPA Reading (dBm)	S.G. Power ( dBm )	TX Cable loss ( dB )	TX Antenna Gain (dBi)	Polarization (H/V)
Lowest	1648	-53.48	-13	-40.48	-40.26	-55.24	0.98	4.89	H
	2472	-35.10	-13	-22.10	-25.8	-36.98	1.28	5.32	H
	3296	-65.33	-13	-52.33	-58.47	-68.74	1.54	7.10	H
	4120	-58.46	-13	-45.46	-53.25	-63.10	1.83	8.62	H
	4944	-63.02	-13	-50.02	-61.92	-68.15	2.30	9.59	H
	5768	-52.03	-13	-39.03	-53.16	-56.91	2.78	9.81	H
	6592	-47.71	-13	-34.71	-51.06	-53.15	2.72	10.31	H
	7416	-53.79	-13	-40.79	-59.77	-60.82	2.46	11.63	H
	8240	-43.94	-13	-30.94	-51.68	-51.76	2.32	12.29	H
	1648	-51.80	-13	-38.80	-38.75	-53.56	0.98	4.89	V
	2472	-36.77	-13	-23.77	-27.49	-38.65	1.28	5.32	V
	3296	-65.11	-13	-52.11	-58.03	-68.52	1.54	7.10	V
	4120	-49.77	-13	-36.77	-44.37	-54.41	1.83	8.62	V
	4944	-60.36	-13	-47.36	-59.03	-65.49	2.30	9.59	V
	5768	-54.16	-13	-41.16	-55.22	-59.04	2.78	9.81	V
	6592	-43.94	-13	-30.94	-47.48	-49.38	2.72	10.31	V
7416	-58.39	-13	-45.39	-64.67	-65.42	2.46	11.63	V	
8240	-50.80	-13	-37.80	-58.44	-58.62	2.32	12.29	V	
Middle	1672	-52.54	-13	-39.54	-39.48	-54.22	0.99	4.82	H
	2512	-34.47	-13	-21.47	-25.31	-36.44	1.29	5.41	H
	4184	-63.26	-13	-50.26	-58.29	-67.88	1.87	8.64	H
	5016	-62.12	-13	-49.12	-61.34	-67.32	2.35	9.70	H
	5856	-55.58	-13	-42.58	-56.99	-60.44	2.83	9.84	H
	6688	-53.36	-13	-40.36	-57.1	-58.94	2.69	10.43	H
	7528	-53.36	-13	-40.36	-64.46	-60.61	2.42	11.82	H
	8360	-47.98	-13	-34.98	-65.9	-55.87	2.35	12.39	H
	1672	-49.91	-13	-36.91	-36.95	-51.59	0.99	4.82	V
	2512	-38.17	-13	-25.17	-29.05	-40.14	1.29	5.41	V
	4184	-64.29	-13	-51.29	-59.11	-68.91	1.87	8.64	V
	5016	-60.29	-13	-47.29	-59.29	-65.49	2.35	9.70	V
	5856	-53.54	-13	-40.54	-54.86	-58.40	2.83	9.84	V
	6688	-49.70	-13	-36.70	-53.66	-55.28	2.69	10.43	V
7528	-51.54	-13	-38.54	-58.08	-58.79	2.42	11.82	V	
8360	-49.78	-13	-36.78	-57.67	-57.67	2.35	12.39	V	



GSM850 (GPRS class 8)									
Channel	Frequency ( MHz )	ERP ( dBm )	Limit ( dBm )	Over Limit ( dB )	SPA Reading (dBm)	S.G. Power ( dBm )	TX Cable loss ( dB )	TX Antenna Gain (dBi)	Polarization (H/V)
Highest	1696	-52.54	-13	-39.54	-39.56	-54.14	1.00	4.75	H
	2544	-44.41	-13	-31.41	-35.37	-46.39	1.30	5.44	H
	5096	-60.95	-13	-47.95	-60.38	-66.11	2.39	9.70	H
	5944	-52.49	-13	-39.49	-54.14	-57.34	2.88	9.88	H
	6792	-52.16	-13	-39.16	-56.3	-57.90	2.66	10.55	H
	7640	-55.10	-13	-42.10	-61.56	-62.45	2.38	11.88	H
	8488	-45.32	-13	-32.32	-53.71	-53.29	2.37	12.49	H
	1696	-53.18	-13	-40.18	-40.27	-54.78	1.00	4.75	V
	2544	-48.13	-13	-35.13	-39.12	-50.11	1.30	5.44	V
	5096	-60.30	-13	-47.30	-59.54	-65.46	2.39	9.70	V
	5944	-52.10	-13	-39.10	-53.64	-56.95	2.88	9.88	V
	6792	-49.86	-13	-36.86	-54.24	-55.60	2.66	10.55	V
	7640	-55.02	-13	-42.02	-61.71	-62.37	2.38	11.88	V
	8488	-51.86	-13	-38.86	-60.01	-59.83	2.37	12.49	V

Remark: Spurious emissions within 30-1000MHz were found more than 20dB below limit line.



GSM850 (EDGE class 8)									
Channel	Frequency ( MHz )	ERP ( dBm )	Limit ( dBm )	Over Limit ( dB )	SPA Reading (dBm)	S.G. Power ( dBm )	TX Cable loss ( dB )	TX Antenna Gain (dBi)	Polarization (H/V)
Lowest	1648	-63.37	-13	-50.37	-50.15	-65.13	0.98	4.89	H
	2472	-56.92	-13	-43.92	-47.62	-58.80	1.28	5.32	H
	5768	-59.06	-13	-46.06	-60.19	-63.94	2.78	9.81	H
									H
									H
									H
	1648	-64.15	-13	-51.15	-51.1	-65.91	0.98	4.89	V
	2472	-60.50	-13	-47.50	-51.22	-62.38	1.28	5.32	V
	5768	-61.20	-13	-48.20	-62.26	-66.08	2.78	9.81	V
									V
									V
									V
Middle	1672	-65.22	-13	-52.22	-52.16	-66.90	0.99	4.82	H
	2512	-61.08	-13	-48.08	-51.92	-63.05	1.29	5.41	H
	5856	-59.78	-13	-46.78	-61.19	-64.64	2.83	9.84	H
	6688	-55.05	-13	-42.05	-58.79	-60.63	2.69	10.43	H
	8360	-54.93	-13	-41.93	-62.99	-62.82	2.35	12.39	H
									H
	1672	-64.22	-13	-51.22	-51.26	-65.90	0.99	4.82	V
	2512	-58.90	-13	-45.90	-49.78	-60.87	1.29	5.41	V
	5856	-61.11	-13	-48.11	-62.43	-65.97	2.83	9.84	V
									V
									V
									V
Highest	1696	-67.29	-13	-54.29	-54.31	-68.89	1.00	4.75	H
	2544	-54.60	-13	-41.60	-45.56	-56.58	1.30	5.44	H
	3392	-68.24	-13	-55.24	-61.59	-72.04	1.57	7.52	H
									H
									H
									H
	1696	-65.57	-13	-52.57	-52.66	-67.17	1.00	4.75	V
	2544	-59.60	-13	-46.60	-50.59	-61.58	1.30	5.44	V
	3392	-68.58	-13	-55.58	-61.67	-72.38	1.57	7.52	V
									V
									V
									V

Remark: Spurious emissions within 30-1000MHz were found more than 20dB below limit line.





GSM1900 (GPRS class 8)									
Channel	Frequency ( MHz )	EIRP ( dBm )	Limit ( dBm )	Over Limit ( dB )	SPA Reading (dBm)	S.G. Power ( dBm )	TX Cable loss ( dB )	TX Antenna Gain (dBi)	Polarization (H/V)
Lowest	3700	-60.96	-13	-47.96	-54.77	-67.53	1.67	8.24	H
	5548	-32.17	-13	-19.17	-32.74	-39.24	2.65	9.72	H
	7402	-58.68	-13	-45.68	-64.66	-67.82	2.46	11.60	H
	9251	-52.74	-13	-39.74	-62.74	-62.80	2.54	12.60	H
	12954	-48.31	-13	-35.31	-65.32	-58.34	2.92	12.94	H
									H
	3700	-58.39	-13	-45.39	-51.95	-64.96	1.67	8.24	V
	5548	-37.73	-13	-24.73	-38.26	-44.80	2.65	9.72	V
	7402	-56.47	-13	-43.47	-62.75	-65.61	2.46	11.60	V
	9251	-44.75	-13	-31.75	-53.32	-54.81	2.54	12.60	V
	12954	-47.38	-13	-34.38	-63.59	-57.41	2.92	12.94	V
								V	
Middle	3756	-53.96	-13	-40.96	-47.83	-60.58	1.68	8.31	H
	5639	-37.08	-13	-24.08	-37.89	-44.13	2.71	9.76	H
	7522	-55.77	-13	-42.77	-62.03	-65.16	2.42	11.81	H
	9398	-46.16	-13	-33.16	-56.67	-56.13	2.57	12.54	H
	13163	-48.24	-13	-35.24	-65.81	-58.50	2.97	13.23	H
									H
	3756	-63.28	-13	-50.28	-56.93	-69.90	1.68	8.31	V
	5639	-29.66	-13	-16.66	-30.41	-36.71	2.71	9.76	V
	7522	-51.10	-13	-38.10	-57.64	-60.49	2.42	11.81	V
	9398	-44.59	-13	-31.59	-53.45	-54.56	2.57	12.54	V
	13163	-48.01	-13	-35.01	-64.74	-58.27	2.97	13.23	V
15035	-49.22	-13	-36.22	-68.58	-59.26	3.61	13.65	V	
Highest	3819	-60.02	-13	-47.02	-53.98	-66.70	1.70	8.38	H
	5730	-36.62	-13	-23.62	-37.66	-43.65	2.76	9.79	H
	7641	-52.87	-13	-39.87	-59.33	-62.37	2.38	11.88	H
	9552	-48.73	-13	-35.73	-59.79	-58.60	2.60	12.47	H
	13372	-43.72	-13	-30.72	-61.84	-54.22	3.02	13.52	H
	15282	-49.67	-13	-36.67	-68.63	-59.95	3.72	13.99	H
	3819	-54.11	-13	-41.11	-47.87	-60.79	1.70	8.38	V
	5730	-32.85	-13	-19.85	-33.82	-39.88	2.76	9.79	V
	7641	-46.31	-13	-33.31	-53	-55.81	2.38	11.88	V
	9552	-45.91	-13	-32.91	-55.16	-55.78	2.60	12.47	V
	13372	-43.24	-13	-30.24	-60.5	-53.74	3.02	13.52	V
15282	-42.64	-13	-29.64	-62.06	-52.92	3.72	13.99	V	

Remark: Spurious emissions within 30-1000MHz were found more than 20dB below limit line.



GSM1900 (EDGE class 8)									
Channel	Frequency ( MHz )	EIRP ( dBm )	Limit ( dBm )	Over Limit ( dB )	SPA Reading (dBm)	S.G. Power ( dBm )	TX Cable loss ( dB )	TX Antenna Gain (dBi)	Polarization (H/V)
Lowest	3700	-68.18	-13	-55.18	-61.99	-74.75	1.67	8.24	H
	5548	-35.83	-13	-22.83	-36.4	-42.90	2.65	9.72	H
	7403	-60.08	-13	-47.08	-66.06	-69.23	2.46	11.61	H
	9251	-55.18	-13	-42.18	-65.16	-65.24	2.54	12.60	H
									H
									H
	3700	-67.34	-13	-54.34	-60.9	-73.91	1.67	8.24	V
	5548	-39.27	-13	-26.27	-39.8	-46.34	2.65	9.72	V
	7403	-58.04	-13	-45.04	-64.32	-67.19	2.46	11.61	V
	9251	-51.44	-13	-38.44	-60.01	-61.50	2.54	12.60	V
								V	
								V	
Middle	3756	-66.03	-13	-53.03	-59.9	-72.65	1.68	8.31	H
	5639	-41.85	-13	-28.85	-42.66	-48.90	2.71	9.76	H
	9398	-57.54	-13	-44.54	-68.05	-67.51	2.57	12.54	H
									H
									H
	3756	-66.17	-13	-53.17	-59.58	-72.79	1.68	8.31	V
	5639	-42.10	-13	-29.10	-42.85	-49.15	2.71	9.76	V
	9398	-55.43	-13	-42.43	-64.29	-65.40	2.57	12.54	V
									V
									V
Highest	3819	-64.78	-13	-51.78	-58.74	-71.46	1.70	8.38	H
	5730	-43.32	-13	-30.32	-44.36	-50.35	2.76	9.79	H
	7641	-59.51	-13	-46.51	-65.97	-69.01	2.38	11.88	H
	9552	-54.23	-13	-41.23	-65.29	-64.10	2.60	12.47	H
									H
									H
	3819	-63.33	-13	-50.33	-57.09	-70.01	1.70	8.38	V
	5730	-39.48	-13	-26.48	-40.45	-46.51	2.76	9.79	V
	7641	-57.87	-13	-44.87	-64.56	-67.37	2.38	11.88	V
	9552	-51.25	-13	-38.25	-60.5	-61.12	2.60	12.47	V
								V	
								V	

Remark: Spurious emissions within 30-1000MHz were found more than 20dB below limit line.



WCDMA Band V(RMC 12.2Kbps)									
Channel	Frequency ( MHz )	ERP ( dBm )	Limit ( dBm )	Over Limit ( dB )	SPA Reading (dBm)	S.G. Power ( dBm )	TX Cable loss ( dB )	TX Antenna Gain (dBi)	Polarization (H/V)
Lowest	1648	-67.80	-13	-54.80	-54.58	-69.56	0.98	4.89	H
	2480	-61.52	-13	-48.52	-52.22	-63.43	1.28	5.34	H
	3304	-68.44	-13	-55.44	-61.62	-71.88	1.54	7.14	H
									H
									H
									H
	1648	-70.90	-13	-57.90	-57.85	-72.66	0.98	4.89	V
	2480	-67.41	-13	-54.41	-58.13	-69.32	1.28	5.34	V
	3304	-68.72	-13	-55.72	-61.67	-72.16	1.54	7.14	V
									V
									V
									V
Middle	1672	-66.56	-13	-53.56	-53.5	-68.24	0.99	4.82	H
	2512	-60.44	-13	-47.44	-51.28	-62.41	1.29	5.41	H
	3344	-68.52	-13	-55.52	-61.77	-72.13	1.56	7.31	H
									H
									H
									H
	1672	-69.40	-13	-56.40	-56.44	-71.08	0.99	4.82	V
	2512	-64.59	-13	-51.59	-55.47	-66.56	1.29	5.41	V
	3344	-68.86	-13	-55.86	-61.86	-72.47	1.56	7.31	V
									V
									V
									V
Highest	1696	-66.95	-13	-53.95	-53.97	-68.55	1.00	4.75	H
	2544	-62.23	-13	-49.23	-53.19	-64.21	1.30	5.44	H
	3384	-68.20	-13	-55.20	-61.52	-71.97	1.57	7.49	H
									H
									H
									H
	1696	-66.33	-13	-53.33	-53.42	-67.93	1.00	4.75	V
	2544	-65.73	-13	-52.73	-56.72	-67.71	1.30	5.44	V
	3384	-68.64	-13	-55.64	-61.7	-72.41	1.57	7.49	V
									V
									V
									V

Remark: Spurious emissions within 30-1000MHz were found more than 20dB below limit line.



WCDMA Band II(RMC 12.2Kbps)									
Channel	Frequency ( MHz )	EIRP ( dBm )	Limit ( dBm )	Over Limit ( dB )	SPA Reading (dBm)	S.G. Power ( dBm )	TX Cable loss ( dB )	TX Antenna Gain (dBi)	Polarization (H/V)
Lowest	3700	-48.23	-13	-35.23	-42.07	-54.80	1.67	8.24	H
	5556	-54.93	-13	-41.93	-55.52	-62.00	2.66	9.72	H
	7417	-46.84	-13	-33.84	-52.82	-56.02	2.46	11.63	H
	9265	-56.90	-13	-43.90	-66.94	-66.95	2.54	12.59	H
									H
									H
	3700	-47.08	-13	-34.08	-40.67	-53.65	1.67	8.24	V
	5555	-51.13	-13	-38.13	-51.66	-58.20	2.66	9.72	V
	7410	-43.34	-13	-30.34	-49.64	-52.50	2.46	11.62	V
	9265	-53.80	-13	-40.80	-62.45	-63.85	2.54	12.59	V
								V	
								V	
Middle	3763	-55.55	-13	-42.55	-49.45	-62.18	1.69	8.32	H
	5639	-55.86	-13	-42.86	-56.67	-62.91	2.71	9.76	H
	7522	-53.01	-13	-40.01	-59.27	-62.40	2.42	11.81	H
	9405	-57.01	-13	-44.01	-67.52	-66.98	2.57	12.54	H
									H
									H
	3763	-54.75	-13	-41.75	-48.43	-61.38	1.69	8.32	V
	5639	-53.76	-13	-40.76	-54.51	-60.81	2.71	9.76	V
	7522	-48.56	-13	-35.56	-55.1	-57.95	2.42	11.81	V
	9405	-56.35	-13	-43.35	-65.21	-66.32	2.57	12.54	V
								V	
								V	
Highest	3812	-59.36	-13	-46.36	-53.32	-66.03	1.70	8.37	H
	5723	-56.60	-13	-43.60	-57.64	-63.64	2.75	9.79	H
	7634	-48.77	-13	-35.77	-55.22	-58.26	2.39	11.88	H
									H
									H
									H
	3812	-56.78	-13	-43.78	-50.57	-63.45	1.70	8.37	V
	5723	-51.88	-13	-38.88	-52.89	-58.92	2.75	9.79	V
	7627	-44.26	-13	-31.26	-50.98	-53.75	2.39	11.88	V
									V
								V	

Remark: Spurious emissions within 30-1000MHz were found more than 20dB below limit line.



WCDMA Band IV(RMC 12.2Kbps)									
Channel	Frequency ( MHz )	EIRP ( dBm )	Limit ( dBm )	Over Limit ( dB )	SPA Reading (dBm)	S.G. Power ( dBm )	TX Cable loss ( dB )	TX Antenna Gain (dBi)	Polarization (H/V)
Lowest	3424	-60.37	-13	-47.37	-53.79	-66.46	1.58	7.67	H
	5137	-54.10	-13	-41.10	-52.63	-61.38	2.42	9.70	H
	6850	-54.42	-13	-41.42	-58.73	-62.4	2.64	10.62	H
									H
									H
									H
	3424	-54.89	-13	-41.89	-48.03	-60.98	1.58	7.67	V
	5137	-51.89	-13	-38.89	-51.23	-59.17	2.42	9.70	V
	6850	-52.93	-13	-39.93	-57.51	-60.91	2.64	10.62	V
	8558	-58.26	-13	-45.26	-66.46	-68.4	2.39	12.52	V
								V	
								V	
Middle	3469	-57.23	-13	-44.23	-50.72	-63.5	1.59	7.86	H
	5198	-54.05	-13	-41.05	-53.71	-61.3	2.45	9.70	H
	6927	-58.23	-13	-45.23	-62.89	-66.33	2.61	10.71	H
									H
									H
									H
	3469	-49.66	-13	-36.66	-42.87	-55.93	1.59	7.86	V
	5198	-50.76	-13	-37.76	-50.29	-58.01	2.45	9.70	V
	6934	-56.52	-13	-43.52	-61.46	-64.63	2.61	10.72	V
									V
								V	
								V	
Highest	3504	-57.50	-13	-44.50	-51.05	-63.9	1.61	8.00	H
	5261	-51.64	-13	-38.64	-51.49	-58.85	2.49	9.70	H
	7011	-52.31	-13	-39.31	-57.26	-60.55	2.59	10.82	H
									H
									H
									H
	3504	-51.10	-13	-38.10	-44.35	-57.5	1.61	8.00	V
	5261	-47.80	-13	-34.80	-47.52	-55.01	2.49	9.70	V
	7011	-49.68	-13	-36.68	-54.94	-57.92	2.59	10.82	V
									V
								V	
								V	

Remark: Spurious emissions within 30-1000MHz were found more than 20dB below limit line.



<Sample 2>

GSM850 (GPRS class 8)									
Channel	Frequency ( MHz )	ERP ( dBm )	Limit ( dBm )	Over Limit ( dB )	SPA Reading (dBm)	S.G. Power ( dBm )	TX Cable loss ( dB )	TX Antenna Gain (dBi)	Polarization (H/V)
Lowest	1648	-51.24	-13	-38.24	-38.05	-53.00	0.98	4.89	H
	2472	-31.33	-13	-18.33	-22.06	-33.21	1.28	5.32	H
	5768	-51.45	-13	-38.45	-52.6	-56.33	2.78	9.81	H
	6592	-50.56	-13	-37.56	-54.57	-56.00	2.72	10.31	H
	7416	-46.42	-13	-33.42	-52.45	-53.45	2.46	11.63	H
	8240	-49.30	-13	-36.30	-57.1	-57.12	2.32	12.29	H
	1648	-66.03	-13	-53.03	-53	-67.79	0.98	4.89	V
	2472	-37.77	-13	-24.77	-28.5	-39.65	1.28	5.32	V
	5768	-59.02	-13	-46.02	-60.08	-63.90	2.78	9.81	V
	6592	-59.31	-13	-46.31	-62.86	-64.75	2.72	10.31	V
	7416	-46.51	-13	-33.51	-52.83	-53.54	2.46	11.63	V
8240	-49.30	-13	-36.30	-56.99	-57.12	2.32	12.29	V	
Middle	1672	-65.86	-13	-52.86	-52.81	-67.54	0.99	4.82	H
	2512	-28.13	-13	-15.13	-18.98	-30.10	1.29	5.41	H
	3344	-66.83	-13	-53.83	-60.09	-70.44	1.56	7.31	H
	4184	-66.24	-13	-53.24	-61.28	-70.86	1.87	8.64	H
	5016	-62.60	-13	-49.60	-61.83	-67.80	2.35	9.70	H
	5856	-50.43	-13	-37.43	-51.88	-55.29	2.83	9.84	H
	6688	-48.65	-13	-35.65	-52.42	-54.23	2.69	10.43	H
	7528	-48.10	-13	-35.10	-54.37	-55.35	2.42	11.82	H
	8368	-52.10	-13	-39.10	-60.25	-60.00	2.35	12.39	H
	1672	-66.71	-13	-53.71	-53.75	-68.39	0.99	4.82	V
	2512	-31.73	-13	-18.73	-22.61	-33.70	1.29	5.41	V
	3344	-66.70	-13	-53.70	-59.77	-70.31	1.56	7.31	V
	4184	-66.19	-13	-53.19	-61.01	-70.81	1.87	8.64	V
	5016	-63.91	-13	-50.91	-62.92	-69.11	2.35	9.70	V
	5856	-52.12	-13	-39.12	-53.44	-56.98	2.83	9.84	V
6688	-48.07	-13	-35.07	-52.06	-53.65	2.69	10.43	V	
7528	-46.42	-13	-33.42	-52.96	-53.67	2.42	11.82	V	
8368	-53.10	-13	-40.10	-61.05	-61.00	2.35	12.39	V	
Highest	1696	-59.25	-13	-46.25	-46.29	-60.85	1.00	4.75	H
	2544	-34.63	-13	-21.63	-25.59	-36.61	1.30	5.44	H
	5096	-56.49	-13	-43.49	-55.92	-61.65	2.39	9.70	H
	5944	-55.15	-13	-42.15	-56.85	-60.00	2.88	9.88	H
	6792	-48.83	-13	-35.83	-52.97	-54.57	2.66	10.55	H
	8488	-46.33	-13	-33.33	-54.75	-54.30	2.37	12.49	H
	1696	-61.71	-13	-48.71	-48.8	-63.31	1.00	4.75	V
	2544	-36.34	-13	-23.34	-27.36	-38.32	1.30	5.44	V
	5096	-61.40	-13	-48.40	-60.64	-66.56	2.39	9.70	V
	5944	-54.05	-13	-41.05	-55.6	-58.90	2.88	9.88	V
	6792	-50.76	-13	-37.76	-55.14	-56.50	2.66	10.55	V
8488	-46.92	-13	-33.92	-55.07	-54.89	2.37	12.49	V	

Remark: Spurious emissions within 30-1000MHz were found more than 20dB below limit line.



GSM1900 (GPRS class 8)									
Channel	Frequency ( MHz )	EIRP ( dBm )	Limit ( dBm )	Over Limit ( dB )	SPA Reading (dBm)	S.G. Power ( dBm )	TX Cable loss ( dB )	TX Antenna Gain (dBi)	Polarization (H/V)
Lowest	3700	-47.61	-13	-34.61	-41.42	-54.18	1.67	8.24	H
	5548	-34.88	-13	-21.88	-35.45	-41.95	2.65	9.72	H
	7403	-47.21	-13	-34.21	-53.19	-56.36	2.46	11.61	H
	9251	-45.71	-13	-32.71	-55.69	-55.77	2.54	12.60	H
	12954	-49.60	-13	-36.60	-66.61	-59.63	2.92	12.94	H
									H
	3700	-51.53	-13	-38.53	-45.09	-58.10	1.67	8.24	V
	5548	-42.55	-13	-29.55	-43.08	-49.62	2.65	9.72	V
	7403	-48.18	-13	-35.18	-54.46	-57.33	2.46	11.61	V
	9251	-49.35	-13	-36.35	-57.92	-59.41	2.54	12.60	V
	12954	-45.03	-13	-32.03	-61.24	-55.06	2.92	12.94	V
									V
Middle	3756	-49.24	-13	-36.24	-43.11	-55.86	1.68	8.31	H
	5639	-35.86	-13	-22.86	-36.67	-42.91	2.71	9.76	H
	7522	-47.68	-13	-34.68	-53.94	-57.07	2.42	11.81	H
	9398	-49.30	-13	-36.30	-59.81	-59.27	2.57	12.54	H
	13163	-47.87	-13	-34.87	-65.44	-58.13	2.97	13.23	H
	15040	-54.05	-13	-41.05	-71.81	-64.09	3.61	13.66	H
	3756	-54.93	-13	-41.93	-48.58	-61.55	1.68	8.31	V
	5639	-36.35	-13	-23.35	-37.1	-43.40	2.71	9.76	V
	7522	-46.16	-13	-33.16	-52.7	-55.55	2.42	11.81	V
	9398	-50.52	-13	-37.52	-59.38	-60.49	2.57	12.54	V
	13163	-48.28	-13	-35.28	-65.01	-58.54	2.97	13.23	V
	15040	-50.39	-13	-37.39	-69.75	-60.43	3.61	13.66	V
Highest	3819	-47.33	-13	-34.33	-41.29	-54.01	1.70	8.38	H
	5730	-37.40	-13	-24.40	-38.44	-44.43	2.76	9.79	H
	7641	-51.88	-13	-38.88	-58.34	-61.38	2.38	11.88	H
	9552	-50.08	-13	-37.08	-61.14	-59.95	2.60	12.47	H
	13372	-47.31	-13	-34.31	-65.43	-57.81	3.02	13.52	H
	15282	-51.40	-13	-38.40	-70.36	-61.68	3.72	13.99	H
	3819	-52.33	-13	-39.33	-46.09	-59.01	1.70	8.38	V
	5730	-37.94	-13	-24.94	-38.91	-44.97	2.76	9.79	V
	7641	-47.01	-13	-34.01	-53.7	-56.51	2.38	11.88	V
	9552	-50.44	-13	-37.44	-59.69	-60.31	2.60	12.47	V
	13372	-47.37	-13	-34.37	-64.63	-57.87	3.02	13.52	V
	15282	-49.05	-13	-36.05	-68.47	-59.33	3.72	13.99	V

Remark: Spurious emissions within 30-1000MHz were found more than 20dB below limit line.