

FCC Test Report

Report No.: RF190723C05

FCC ID: ZL5S52E

Test Model: S52

Received Date: Jul. 23, 2019

Test Date: Aug. 13 ~ Sep. 05, 2019

Issued Date: Oct. 05, 2019

Applicant: Bullitt Group

Address: One Valpy, Valpy Street, Reading, RG1 1AR, Berkshire, UK

Issued By: Bureau Veritas Consumer Products Services (H.K.) Ltd., Taoyuan Branch
Lin Kou Laboratories

Lab Address: No. 47-2, 14th Ling, Chia Pau Vil., Lin Kou Dist., New Taipei City, Taiwan

Test Location: No.19, Hwa Ya 2nd Rd., Wen Hwa Vil., Kwei Shan Dist., Taoyuan City
33383, Taiwan

**FCC Registration /
Designation Number:** 788550 / TW0003



This report is for your exclusive use. Any copying or replication of this report to or for any other person or entity, or use of our name or trademark, is permitted only with our prior written permission. This report sets forth our findings solely with respect to the test samples identified herein. The results set forth in this report are not indicative or representative of the quality or characteristics of the lot from which a test sample was taken or any similar or identical product unless specifically and expressly noted. Our report includes all of the tests requested by you and the results thereof based upon the information that you provided to us. You have 60 days from date of issuance of this report to notify us of any material error or omission caused by our negligence, provided, however, that such notice shall be in writing and shall specifically address the issue you wish to raise. A failure to raise such issue within the prescribed time shall constitute your unqualified acceptance of the completeness of this report, the tests conducted and the correctness of the report contents. Unless specific mention, the uncertainty of measurement has been explicitly taken into account to declare the compliance or non-compliance to the specification. The report must not be used by the client to claim product certification, approval, or endorsement by TAF or any government agencies.

Table of Contents

Release Control Record	4
1 Certificate of Conformity	5
2 Summary of Test Results	6
2.1 Measurement Uncertainty	6
2.2 Modification Record	6
3 General Information	7
3.1 General Description of EUT	7
3.2 Description of Test Modes	8
3.2.1 Test Mode Applicability and Tested Channel Detail	9
3.3 Duty Cycle of Test Signal	10
3.4 Description of Support Units	11
3.4.1 Configuration of System under Test	11
3.5 General Description of Applied Standards	11
4 Test Types and Results	12
4.1 Radiated Emission and Bandedge Measurement	12
4.1.1 Limits of Radiated Emission and Bandedge Measurement	12
4.1.2 Test Instruments	13
4.1.3 Test Procedures	14
4.1.4 Deviation from Test Standard	14
4.1.5 Test Set Up	15
4.1.6 EUT Operating Conditions	16
4.1.7 Test Results	17
4.2 Conducted Emission Measurement	25
4.2.1 Limits of Conducted Emission Measurement	25
4.2.2 Test Instruments	25
4.2.3 Test Procedures	26
4.2.4 Deviation from Test Standard	26
4.2.5 Test Setup	26
4.2.6 EUT Operating Condition	26
4.2.7 Test Results	27
4.3 Number of Hopping Frequency Used	29
4.3.1 Limits of Hopping Frequency Used Measurement	29
4.3.2 Test Setup	29
4.3.3 Test Instruments	29
4.3.4 Test Procedure	29
4.3.5 Deviation from Test Standard	29
4.3.6 Test Results	30
4.4 Dwell Time on Each Channel	31
4.4.1 Limits of Dwell Time on Each Channel Measurement	31
4.4.2 Test Setup	31
4.4.3 Test Instruments	31
4.4.4 Test Procedures	31
4.4.5 Deviation from Test Standard	31
4.4.6 Test Results	32
4.5 Channel Bandwidth	34
4.5.1 Limits of Channel Bandwidth Measurement	34
4.5.2 Test Setup	34
4.5.3 Test Instruments	34
4.5.4 Test Procedure	34
4.5.5 Deviation from Test Standard	34
4.5.6 EUT Operating Condition	34
4.5.7 Test Results	35
4.6 Occupied Bandwidth Measurement	36

4.6.1	Test Setup	36
4.6.2	Test Instruments	36
4.6.3	Test Procedure	36
4.6.4	Deviation from Test Standard	36
4.6.5	EUT Operating Conditions	36
4.6.6	Test Results	37
4.7	Hopping Channel Separation	38
4.7.1	Limits of Hopping Channel Separation Measurement	38
4.7.2	Test Setup	38
4.7.3	Test Instruments	38
4.7.4	Test Procedure	38
4.7.5	Deviation from Test Standard	38
4.7.6	Test Results	39
4.8	Maximum Output Power	40
4.8.1	Limits of Maximum Output Power Measurement	40
4.8.2	Test Setup	40
4.8.3	Test Instruments	40
4.8.4	Test Procedure	40
4.8.5	Deviation from Test Standard	40
4.8.6	EUT Operating Condition	40
4.8.7	Test Results	41
4.9	Conducted Out of Band Emission Measurement	42
4.9.1	Limits Of Conducted Out of Band Emission Measurement	42
4.9.2	Test Instruments	42
4.9.3	Test Procedure	42
4.9.4	Deviation from Test Standard	42
4.9.5	EUT Operating Condition	42
4.9.6	Test Results	42
5	Pictures of Test Arrangements	47
	Appendix – Information of the Testing Laboratories	48

Release Control Record

Issue No.	Description	Date Issued
RF190723C05	Original Release	Oct. 05, 2019

1 Certificate of Conformity

Product: Rugged Smart Phone

Brand: CAT

Test Model: S52

Sample Status: Identical Prototype

Applicant: Bullitt Group

Test Date: Aug. 13 ~ Sep. 05, 2019

Standards: 47 CFR FCC Part 15, Subpart C (Section 15.247)
ANSI C63.10:2013

The above equipment has been tested by **Bureau Veritas Consumer Products Services (H.K.) Ltd., Taoyuan Branch**, and found compliance with the requirement of the above standards. The test record, data evaluation & Equipment Under Test (EUT) configurations represented herein are true and accurate accounts of the measurements of the sample's RF characteristics under the conditions specified in this report.

Prepared by : Gina Liu, **Date:** Oct. 05, 2019
Gina Liu / Specialist

Approved by : Dylan Chiou, **Date:** Oct. 05, 2019
Dylan Chiou / Project Engineer

2 Summary of Test Results

47 CFR FCC Part 15, Subpart C (Section 15.247)			
FCC Clause	Test Item	Result	Remarks
15.207	AC Power Conducted Emission	Pass	Meet the requirement of limit. Minimum passing margin is -19.63 dB at 0.45097 MHz.
15.247(a)(1)(iii)	Number of Hopping Frequency Used	Pass	Meet the requirement of limit.
15.247(a)(1)(iii)	Dwell Time on Each Channel	Pass	Meet the requirement of limit.
15.247(a)(1)	1. Hopping Channel Separation 2. Spectrum Bandwidth of a Frequency Hopping Sequence Spread Spectrum System	Pass	Meet the requirement of limit.
15.247(a)(1)	Maximum Peak Output Power	Pass	Meet the requirement of limit.
---	Occupied Bandwidth Measurement	Pass	Reference only
15.205 & 209	Radiated Emissions	Pass	Meet the requirement of limit. Minimum passing margin is -5.96 dB at 77.53 MHz.
15.247(d)	Band Edge Measurement	Pass	Meet the requirement of limit.
15.247(d)	Antenna Port Emission	Pass	Meet the requirement of limit.
15.203	Antenna Requirement	Pass	No antenna connector is used.

Note:

1. If the Frequency Hopping System operating in 2400-2483.5 MHz band and the output power less than 125 mW. The hopping channel carrier frequencies separated by a minimum of 25 kHz or two-thirds of the 20 dB bandwidth of hopping channel whichever is greater.
2. Determining compliance based on the results of the compliance measurement, not taking into account measurement instrumentation uncertainty.

2.1 Measurement Uncertainty

Where relevant, the following measurement uncertainty levels have been estimated for tests performed on the EUT as specified in CISPR 16-4-2:

Measurement	Frequency	Expanded Uncertainty (k=2) (±)
Conducted Emissions at mains ports	150 kHz ~ 30 MHz	2.44 dB
Radiated Emissions up to 1 GHz	9 kHz ~ 30 MHz	3.04 dB
	30 MHz ~ 200 MHz	2.93 dB
	200 MHz ~ 1000 MHz	2.95 dB
Radiated Emissions above 1 GHz	1 GHz ~ 18 GHz	2.26 dB
	18 GHz ~ 40 GHz	1.94 dB

2.2 Modification Record

There were no modifications required for compliance.

3 General Information

3.1 General Description of EUT

Product	Rugged Smart Phone
Brand	CAT
Test Model	S52
Status of EUT	Identical Prototype
Power Supply Rating	5-8 Vdc / 8.5-10 Vdc / 10-12 Vdc (adapter 1) 5.0 Vdc / 9.0 Vdc / 12.0 Vdc (adapter 2) 3.8 Vdc (Li-ion battery)
Modulation Type	GFSK, $\pi/4$ -DQPSK, 8DPSK
Transfer Rate	1/2/3 Mbps
Operating Frequency	2402 ~ 2480 MHz
Number of Channel	79
Output Power	9.528 mW
Antenna Type	Loop antenna with -6.5 dBi gain
Antenna Connector	N/A
Accessory Device	Refer to Note as below
Data Cable Supplied	Refer to Note as below

Note:

- The EUT details of the sample are as follows.

Sample	Description
DS	Dual SIM
SS	Single SIM
* The samples have the same layout, circuit, and components, but different SIM tray.	

After pre-tested with the EUT, only the worst sample (Dual SIM) was chosen for the final test.

- The EUT contains following accessory devices.

Product	Manufacture	Model	Description
Adapter 1	Lucent Trans Electronics Co., LTD.	1M52	I/P: 100-240 Vac, 50-60 Hz, 500 mA O/P: 5Vdc-8Vdc, 2.0A / 8.5Vdc-10Vdc, 1.7A / 10Vdc-12Vdc, 1.5A
Adapter 2	Jiangsu Chenyang Electron Co., LTD.	CK18W02U	I/P: 100-240 Vac, 50-60 Hz, 500 mA O/P: 5 Vdc, 3.0A / 9Vdc, 2.0A / 12Vdc, 1.5A
Battery	Apack Technology Co., LTD.	APP00307	3.8 Vdc, 3000 mAh
Earphone	Ganet Global LTD.	HF-AC04D-03 HF	1.2m non-shielded cable with core
USB Cable	Saibao (Jiangxi) Communication Industrial Co., LTD.	SRB-A001A	1.2m shielded cable with core

- The above EUT information is declared by manufacturer and for more detailed features description, please refers to the manufacturer's specifications or User's Manual.

3.2 Description of Test Modes

79 channels are provided to this EUT:

Channel	Freq. (MHz)	Channel	Freq. (MHz)	Channel	Freq. (MHz)	Channel	Freq. (MHz)
0	2402	20	2422	40	2442	60	2462
1	2403	21	2423	41	2443	61	2463
2	2404	22	2424	42	2444	62	2464
3	2405	23	2425	43	2445	63	2465
4	2406	24	2426	44	2446	64	2466
5	2407	25	2427	45	2447	65	2467
6	2408	26	2428	46	2448	66	2468
7	2409	27	2429	47	2449	67	2469
8	2410	28	2430	48	2450	68	2470
9	2411	29	2431	49	2451	69	2471
10	2412	30	2432	50	2452	70	2472
11	2413	31	2433	51	2453	71	2473
12	2414	32	2434	52	2454	72	2474
13	2415	33	2435	53	2455	73	2475
14	2416	34	2436	54	2456	74	2476
15	2417	35	2437	55	2457	75	2477
16	2418	36	2438	56	2458	76	2478
17	2419	37	2439	57	2459	77	2479
18	2420	38	2440	58	2460	78	2480
19	2421	39	2441	59	2461		

3.2.1 Test Mode Applicability and Tested Channel Detail

EUT Configure Mode	Applicable To				Description
	RE \geq 1G	RE<1G	PLC	APCM	
-	√	√	√	√	-

Where **RE \geq 1G**: Radiated Emission above 1 GHz **RE<1G**: Radiated Emission below 1 GHz
PLC: Power Line Conducted Emission **APCM**: Antenna Port Conducted Measurement

Note:

1. For Radiated emission test, pre-tested GFSK, $\pi/4$ -DQPSK, 8DPSK modulation type and found GFSK was the worse, therefore chosen for the final test and presented in the test report.
2. The EUT had been pre-tested on the positioned of each 3 axis. The worst case was found when positioned on **X-plane**.

Radiated Emission Test (Above 1 GHz):

- Pre-Scan has been conducted to determine the worst-case mode from all possible combinations between available modulations, data rates and antenna ports (if EUT with antenna diversity architecture).
- Following channel(s) was (were) selected for the final test as listed below.

EUT Configure Mode	Available Channel	Tested Channel	Modulation Technology	Modulation Type	Packet Type
-	0 to 78	0, 39, 78	FHSS	GFSK	DH5
	0 to 78	0, 39, 78	FHSS	8DPSK	3DH5

Radiated Emission Test (Below 1 GHz):

- Pre-Scan has been conducted to determine the worst-case mode from all possible combinations between available modulations, data rates and antenna ports (if EUT with antenna diversity architecture).
- Following channel(s) was (were) selected for the final test as listed below.

EUT Configure Mode	Available Channel	Tested Channel	Modulation Technology	Modulation Type	Packet Type
-	0 to 78	78	FHSS	GFSK	DH5

Power Line Conducted Emission Test:

- Pre-Scan has been conducted to determine the worst-case mode from all possible combinations between available modulations, data rates and antenna ports (if EUT with antenna diversity architecture).
- Following channel(s) was (were) selected for the final test as listed below.

EUT Configure Mode	Available Channel	Tested Channel	Modulation Technology	Modulation Type	Packet Type
-	0 to 78	78	FHSS	GFSK	DH5

Antenna Port Conducted Measurement:

- This item includes all test value of each mode, but only includes spectrum plot of worst value of each mode.
- Pre-Scan has been conducted to determine the worst-case mode from all possible combinations between available modulations, data rates and antenna ports (if EUT with antenna diversity architecture).
- Following channel(s) was (were) selected for the final test as listed below.

EUT Configure Mode	Available Channel	Tested Channel	Modulation Technology	Modulation Type	Packet Type
-	0 to 78	0, 39, 78	FHSS	GFSK	DH5
-	0 to 78	0, 39, 78	FHSS	8DPSK	3DH5

Test Condition:

Applicable To	Environmental Conditions	Input Power	Tested by
RE≥1G	25 deg. C, 65 % RH	120 Vac, 60 Hz	Thomas Wei
RE<1G	25 deg. C, 65 % RH	120 Vac, 60 Hz	Thomas Wei
PLC	25 deg. C, 65 % RH	120 Vac, 60 Hz	Thomas Wei
APCM	25 deg. C, 65 % RH	3.8 Vdc	Gavin Wu

3.3 Duty Cycle of Test Signal

Duty cycle = 2.872/3.755 = 0.765, Duty factor = 10 * log(1/0.765) = 1.16

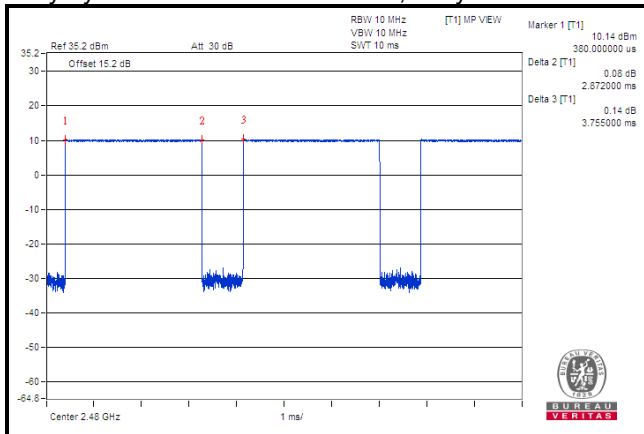

3.4 Description of Support Units

The EUT has been tested as an independent unit together with other necessary accessories or support units.

3.4.1 Configuration of System under Test

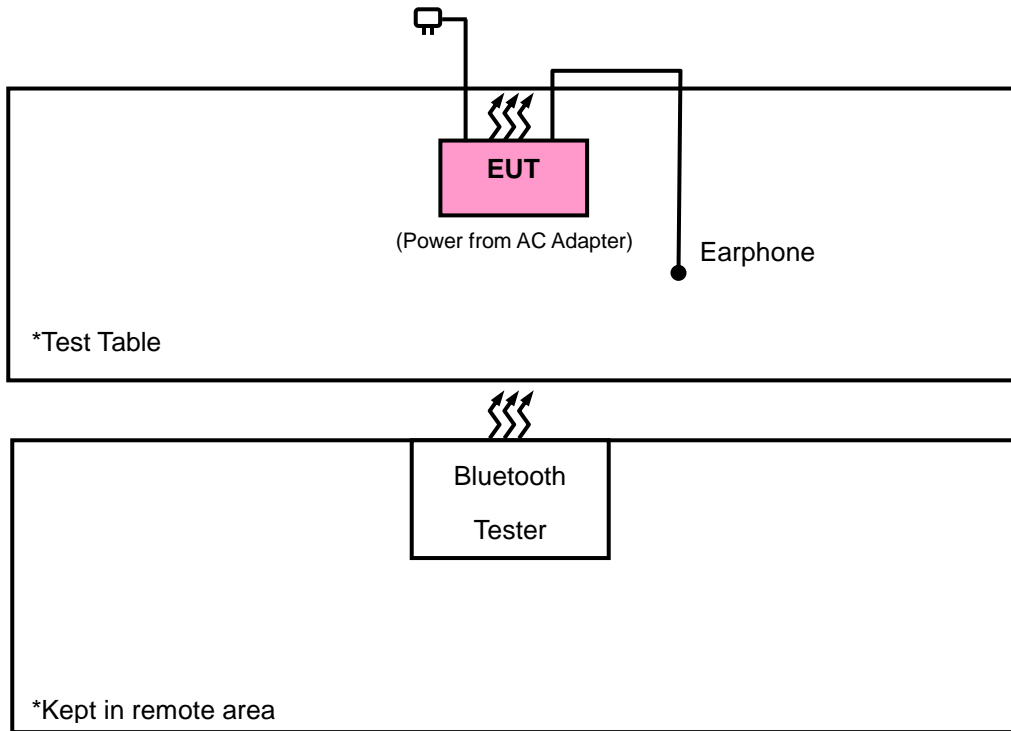

3.5 General Description of Applied Standards

The EUT is a RF Product. According to the specifications of the manufacturer, it must comply with the requirements of the following standards:

FCC Part 15, Subpart C (15.247)

KDB 558074 D01 15.247 Meas Guidance v05r02

ANSI C63.10-2013

All test items have been performed and recorded as per the above standards.

4 Test Types and Results

4.1 Radiated Emission and Bandedge Measurement

4.1.1 Limits of Radiated Emission and Bandedge Measurement

Radiated emissions which fall in the restricted bands must comply with the radiated emission limits specified as below table. Other emissions shall be at least 20 dB below the highest level of the desired power:

Frequencies (MHz)	Field Strength (microvolts/meter)	Measurement Distance (meters)
0.009 ~ 0.490	2400/F (kHz)	300
0.490 ~ 1.705	24000/F (kHz)	30
1.705 ~ 30.0	30	30
30 ~ 88	100	3
88 ~ 216	150	3
216 ~ 960	200	3
Above 960	500	3

Note:

- a. The lower limit shall apply at the transition frequencies.
- b. Emission level (dBuV/m) = 20 log Emission level (uV/m).
- c. For frequencies above 1000 MHz, the field strength limits are based on average detector, however, the peak field strength of any emission shall not exceed the maximum permitted average limits, specified above by more than 20 dB under any condition of modulation.

4.1.2 Test Instruments

Description & Manufacturer	Model No.	Serial No.	Date of Calibration	Due Date of Calibration
Test Receiver Agilent	N9038A	MY51210203	Mar. 18, 2019	Mar. 17, 2020
Spectrum Analyzer Agilent	N9010A	MY52220314	Dec. 13, 2018	Dec. 12, 2019
Spectrum Analyzer ROHDE & SCHWARZ	FSU43	101261	Apr. 15, 2019	Apr. 14, 2020
Broadband Horn Antenna SCHWARZBECK	BBHA 9170	148	Nov. 25, 2018	Nov. 24, 2019
HORN Antenna SCHWARZBECK	BBHA 9120D	9120D-969	Nov. 25, 2018	Nov. 24, 2019
BILOG Antenna SCHWARZBECK	VULB 9168	9168-472	Nov. 23, 2018	Nov. 22, 2019
Fixed Attenuator Mini-Circuits	MDCS18N-10	MDCS18N-10-01	Apr. 15, 2019	Apr. 14, 2020
Loop Antenna	HLA 6121	45745	Jul. 01, 2019	Jun. 30, 2020
Preamplifier EMCI	EMC001340	980201	Oct. 12, 2018	Oct. 11, 2019
Bluetooth Tester	CBT	100946	Aug. 09, 2018	Aug. 08, 2020
Preamplifier EMCI	EMC 012645	980115	Oct. 12, 2018	Oct. 11, 2019
Preamplifier EMCI	EMC 184045	980116	Oct. 12, 2018	Oct. 11, 2019
Preamplifier EMCI	EMC 330H	980112	Oct. 12, 2018	Oct. 11, 2019
Power Meter Anritsu	ML2495A	1012010	Sep. 05, 2018 Sep. 04, 2019	Sep. 04, 2019 Sep. 03, 2020
Power Sensor Anritsu	MA2411B	1315050	Sep. 04, 2018 Sep. 04, 2019	Sep. 03, 2019 Sep. 03, 2020
RF Coaxial Cable HUBER+SUHNNER	EMC104-SM-SM-8 000&3000	140811+170717	Oct. 12, 2018	Oct. 11, 2019
RF Coaxial Cable HUBER+SUHNNER	SUCOFLEX 104	EMC104-SM-SM-1 000(140807)	Oct. 12, 2018	Oct. 11, 2019
RF Coaxial Cable WOKEN	8D-FB	Cable-Ch10-01	Oct. 12, 2018	Oct. 11, 2019
Boresight Antenna Fixture	FBA-01	FBA-SIP01	NA	NA
Software BV ADT	E3 6.120103	NA	NA	NA
Antenna Tower MF	MFA-440H	NA	NA	NA
Turn Table MF	MFT-201SS	NA	NA	NA
Antenna Tower & Turn Table Controller MF	MF-7802	NA	NA	NA

Note: 1. The calibration interval of the above test instruments is 12 / 24 months and the calibrations are traceable to NML/ROC and NIST/USA.

2. The test was performed in HwaYa Chamber 10.

4.1.3 Test Procedures

For Radiated Emission below 30 MHz

- a. The EUT was placed on the top of a rotating table 0.8 meters above the ground at a 3 meter chamber room. The table was rotated 360 degrees to determine the position of the highest radiation.
- b. The EUT was set 3 meters away from the interference-receiving antenna, which was mounted on the top of a variable-height antenna tower.
- c. Both Parallel, perpendicular, and ground-parallel orientations of the antenna are set to make the measurement.
- d. For each suspected emission, the EUT was arranged to its worst case and the rotatable table was turned from 0 degrees to 360 degrees to find the maximum reading.
- e. The test-receiver system was set to Quasi-Peak Detect Function and Specified Bandwidth with Maximum Hold Mode.

Note:

1. The resolution bandwidth and video bandwidth of test receiver/spectrum analyzer is 9 kHz at frequency below 30 MHz.

For Radiated Emission above 30 MHz

- a. The EUT was placed on the top of a rotating table 0.8 meters (for 30 MHz ~ 1 GHz) / 1.5 meters (for above 1 GHz) above the ground at 3 meter chamber room for test. The table was rotated 360 degrees to determine the position of the highest radiation.
- b. The EUT was set 3 meters away from the interference-receiving antenna, which was mounted on the top of a variable-height antenna tower.
- c. The height of antenna is varied from one meter to four meters above the ground to determine the maximum value of the field strength. Both horizontal and vertical polarizations of the antenna are set to make the measurement.
- d. For each suspected emission, the EUT was arranged to its worst case and then the antenna was tuned to heights from 1 meter to 4 meters and the rotatable table was turned from 0 degrees to 360 degrees to find the maximum reading.
- e. The test-receiver system was set to quasi-peak detect function and specified bandwidth with maximum hold mode when the test frequency is below 1 GHz.
- f. The test-receiver system was set to peak and average detected function and specified bandwidth with maximum hold mode when the test frequency is above 1 GHz. If the peak reading value also meets average limit, measurement with the average detector is unnecessary.

Note:

1. The resolution bandwidth and video bandwidth of test receiver/spectrum analyzer is 120 kHz for Quasi-peak detection (QP) or Peak detection (PK) at frequency below 1 GHz.
2. The resolution bandwidth of test receiver/spectrum analyzer is 1 MHz and the video bandwidth is 3 MHz for Peak detection (PK) at frequency above 1 GHz.
3. The resolution bandwidth of test receiver/spectrum analyzer is 1 MHz and the video bandwidth is $\geq 1/T$ (Duty cycle < 98 %) or 10 Hz (Duty cycle ≥ 98 %) for Average detection (AV) at frequency above 1 GHz. (RBW = 1 MHz, VBW = 1 kHz)
4. All modes of operation were investigated and the worst-case emissions are reported.

4.1.4 Deviation from Test Standard

No deviation.

4.1.5 Test Set Up

<Radiated Emission below 30 MHz>

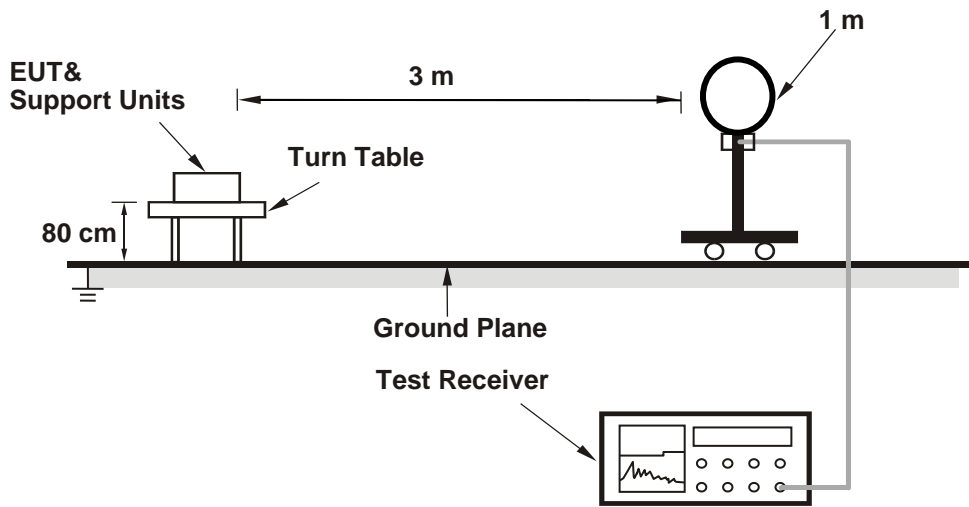

<Radiated Emission 30 MHz to 1 GHz>

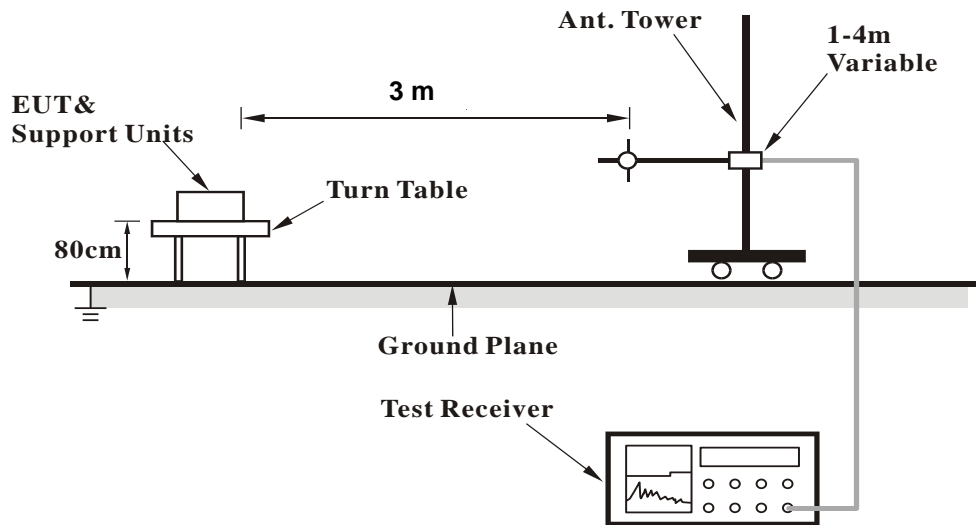

<Radiated Emission above 1 GHz>

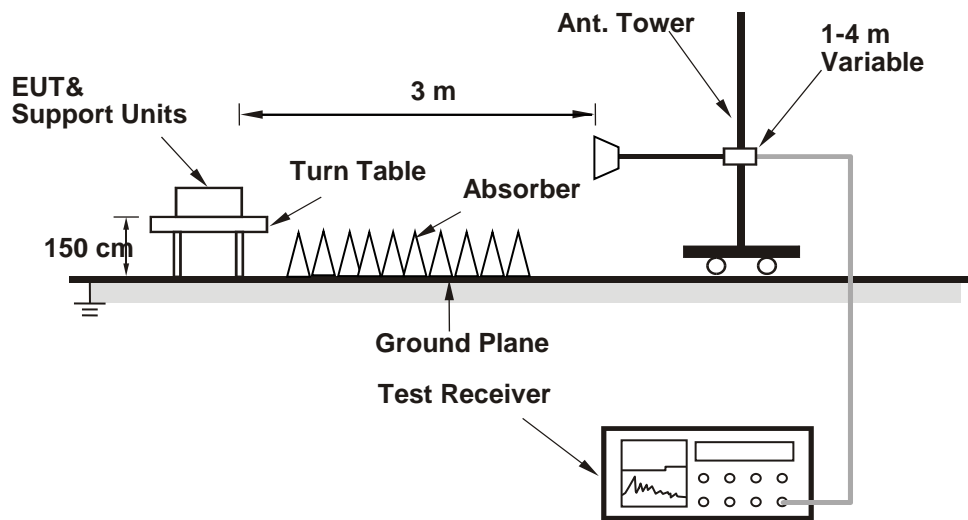

For the actual test configuration, please refer to the attached file (Test Setup Photo).

4.1.6 EUT Operating Conditions

Set the EUT under transmission condition continuously at specific channel frequency.

4.1.7 Test Results

Above 1 GHz Data:
GFSK

EUT Test Condition		Measurement Detail	
Channel	Channel 0	Frequency Range	1 GHz ~ 25 GHz
Input Power	120 Vac, 60 Hz	Detector Function	Peak (PK) Average (AV)
Environmental Conditions	25 deg. C, 65 % RH	Tested By	Thomas Wei

Antenna Polarity & Test Distance: Horizontal at 3 m								
Frequency (MHz)	Emission Level (dBuV/m)	Read Level (dBuV)	Factor (dB/m)	Limit (dBuV/m)	Margin (dB)	Antenna Height (cm)	Table Angle (Degree)	Remark
2356.48	37.11	41.92	-4.81	54	-16.89	104	237	Average
2356.48	47.11	51.92	-4.81	74	-26.89	104	237	Peak
2402	103.71	108.71	-5			104	237	Average
2402	104.15	109.15	-5			104	237	Peak
4804	39.76	54.23	-14.47	54	-14.24	130	329	Average
4804	44.76	59.23	-14.47	74	-29.24	130	329	Peak

Antenna Polarity & Test Distance: Vertical at 3 m								
Frequency (MHz)	Emission Level (dBuV/m)	Read Level (dBuV)	Factor (dB/m)	Limit (dBuV/m)	Margin (dB)	Antenna Height (cm)	Table Angle (Degree)	Remark
2351.3	37.06	41.79	-4.73	54	-16.94	268	252	Average
2351.3	46.9	51.63	-4.73	74	-27.1	268	252	Peak
2402	95.68	100.68	-5			268	252	Average
2402	96.09	101.09	-5			268	252	Peak
4804	38.05	52.52	-14.47	54	-15.95	100	247	Average
4804	44.97	59.44	-14.47	74	-29.03	100	247	Peak

Remarks:

- Emission Level = Read Level + Factor
Margin value = Emission level – Limit value
- 2402 MHz: Fundamental frequency.
- The emission levels of other frequencies were very low against the limit.

EUT Test Condition		Measurement Detail	
Channel	Channel 39	Frequency Range	1 GHz ~ 25 GHz
Input Power	120 Vac, 60 Hz	Detector Function	Peak (PK) Average (AV)
Environmental Conditions	25 deg. C, 65 % RH	Tested By	Thomas Wei

Antenna Polarity & Test Distance: Horizontal at 3 m								
Frequency (MHz)	Emission Level (dBuV/m)	Read Level (dBuV)	Factor (dB/m)	Limit (dBuV/m)	Margin (dB)	Antenna Height (cm)	Table Angle (Degree)	Remark
2441	103.63	108.54	-4.91			164	228	Average
2441	104.14	109.05	-4.91			164	228	Peak
4882	39.57	53.65	-14.08	54	-14.43	100	54	Average
4882	44.54	58.62	-14.08	74	-29.46	100	54	Peak
Antenna Polarity & Test Distance: Vertical at 3 m								
Frequency (MHz)	Emission Level (dBuV/m)	Read Level (dBuV)	Factor (dB/m)	Limit (dBuV/m)	Margin (dB)	Antenna Height (cm)	Table Angle (Degree)	Remark
2441	95.88	100.79	-4.91			100	253	Average
2441	96.33	101.24	-4.91			100	253	Peak
4882	39.71	53.79	-14.08	54	-14.29	100	262	Average
4882	44.47	58.55	-14.08	74	-29.53	100	262	Peak

Remarks:

- Emission Level = Read Level + Factor
Margin value = Emission level – Limit value
- 2441 MHz: Fundamental frequency.
- The emission levels of other frequencies were very low against the limit.

EUT Test Condition		Measurement Detail	
Channel	Channel 78	Frequency Range	1 GHz ~ 25 GHz
Input Power	120 Vac, 60 Hz	Detector Function	Peak (PK) Average (AV)
Environmental Conditions	25 deg. C, 65 % RH	Tested By	Thomas Wei

Antenna Polarity & Test Distance: Horizontal at 3 m								
Frequency (MHz)	Emission Level (dBuV/m)	Read Level (dBuV)	Factor (dB/m)	Limit (dBuV/m)	Margin (dB)	Antenna Height (cm)	Table Angle (Degree)	Remark
2480	102.2	107.05	-4.85			136	228	Average
2480	102.75	107.6	-4.85			136	228	Peak
2483.52	38.4	43.25	-4.85	54	-15.6	136	228	Average
2483.52	48.03	52.88	-4.85	74	-25.97	136	228	Peak
4960	39.82	53.71	-13.89	54	-14.18	100	260	Average
4960	43.33	57.22	-13.89	74	-30.67	100	260	Peak
Antenna Polarity & Test Distance: Vertical at 3 m								
Frequency (MHz)	Emission Level (dBuV/m)	Read Level (dBuV)	Factor (dB/m)	Limit (dBuV/m)	Margin (dB)	Antenna Height (cm)	Table Angle (Degree)	Remark
2480	95.37	100.22	-4.85			100	254	Average
2480	96.13	100.98	-4.85			100	254	Peak
2483.52	37.26	42.11	-4.85	54	-16.74	100	254	Average
2483.52	47.48	52.33	-4.85	74	-26.52	100	254	Peak
4960	39.39	53.28	-13.89	54	-14.61	100	233	Average
4960	44.38	58.27	-13.89	74	-29.62	100	233	Peak

Remarks:

- Emission Level = Read Level + Factor
Margin value = Emission level – Limit value
- 2480 MHz: Fundamental frequency.
- The emission levels of other frequencies were very low against the limit.

8DPSK

EUT Test Condition		Measurement Detail	
Channel	Channel 0	Frequency Range	1 GHz ~ 25 GHz
Input Power	120 Vac, 60 Hz	Detector Function	Peak (PK) Average (AV)
Environmental Conditions	25 deg. C, 65 % RH	Tested By	Thomas Wei

Antenna Polarity & Test Distance: Horizontal at 3 m								
Frequency (MHz)	Emission Level (dBuV/m)	Read Level (dBuV)	Factor (dB/m)	Limit (dBuV/m)	Margin (dB)	Antenna Height (cm)	Table Angle (Degree)	Remark
2319.24	37.03	41.62	-4.59	54	-16.97	149	216	Average
2319.24	48.22	52.81	-4.59	74	-25.78	149	216	Peak
2402	101.35	106.35	-5			149	216	Average
2402	104.07	109.07	-5			149	216	Peak
4804	39.3	53.77	-14.47	54	-14.7	119	304	Average
4804	43.42	57.89	-14.47	74	-30.58	119	304	Peak
Antenna Polarity & Test Distance: Vertical at 3 m								
Frequency (MHz)	Emission Level (dBuV/m)	Read Level (dBuV)	Factor (dB/m)	Limit (dBuV/m)	Margin (dB)	Antenna Height (cm)	Table Angle (Degree)	Remark
2320.78	36.85	41.44	-4.59	54	-17.15	268	251	Average
2320.78	47.19	51.78	-4.59	74	-26.81	268	251	Peak
2402	92.82	97.82	-5			268	251	Average
2402	95.01	100.01	-5			268	251	Peak
4804	37.94	52.41	-14.47	54	-16.06	100	244	Average
4804	43.35	57.82	-14.47	74	-30.65	100	244	Peak

Remarks:

- Emission Level = Read Level + Factor
Margin value = Emission level – Limit value
- 2402 MHz: Fundamental frequency.
- The emission levels of other frequencies were very low against the limit.

EUT Test Condition		Measurement Detail	
Channel	Channel 39	Frequency Range	1 GHz ~ 25 GHz
Input Power	120 Vac, 60 Hz	Detector Function	Peak (PK) Average (AV)
Environmental Conditions	25 deg. C, 65 % RH	Tested By	Thomas Wei

Antenna Polarity & Test Distance: Horizontal at 3 m								
Frequency (MHz)	Emission Level (dBuV/m)	Read Level (dBuV)	Factor (dB/m)	Limit (dBuV/m)	Margin (dB)	Antenna Height (cm)	Table Angle (Degree)	Remark
2441	100.87	105.78	-4.91			122	216	Average
2441	103.29	108.2	-4.91			122	216	Peak
4882	39.32	53.4	-14.08	54	-14.68	100	238	Average
4882	44.28	58.36	-14.08	74	-29.72	100	238	Peak
Antenna Polarity & Test Distance: Vertical at 3 m								
Frequency (MHz)	Emission Level (dBuV/m)	Read Level (dBuV)	Factor (dB/m)	Limit (dBuV/m)	Margin (dB)	Antenna Height (cm)	Table Angle (Degree)	Remark
2441	93.12	98.03	-4.91			100	253	Average
2441	95.33	100.24	-4.91			100	253	Peak
4882	38.11	52.19	-14.08	54	-15.89	100	264	Average
4882	43.74	57.82	-14.08	74	-30.26	100	264	Peak

Remarks:

- Emission Level = Read Level + Factor
Margin value = Emission level – Limit value
- 2441 MHz: Fundamental frequency.
- The emission levels of other frequencies were very low against the limit.

EUT Test Condition		Measurement Detail	
Channel	Channel 78	Frequency Range	1 GHz ~ 25 GHz
Input Power	120 Vac, 60 Hz	Detector Function	Peak (PK) Average (AV)
Environmental Conditions	25 deg. C, 65 % RH	Tested By	Thomas Wei

Antenna Polarity & Test Distance: Horizontal at 3 m								
Frequency (MHz)	Emission Level (dBuV/m)	Read Level (dBuV)	Factor (dB/m)	Limit (dBuV/m)	Margin (dB)	Antenna Height (cm)	Table Angle (Degree)	Remark
2480	99.07	103.92	-4.85			100	212	Average
2480	101.54	106.39	-4.85			100	212	Peak
2483.52	38.81	43.66	-4.85	54	-15.19	100	212	Average
2483.52	47.71	52.56	-4.85	74	-26.29	100	212	Peak
4960	39.2	53.09	-13.89	54	-14.8	102	243	Average
4960	44.19	58.08	-13.89	74	-29.81	102	243	Peak
Antenna Polarity & Test Distance: Vertical at 3 m								
Frequency (MHz)	Emission Level (dBuV/m)	Read Level (dBuV)	Factor (dB/m)	Limit (dBuV/m)	Margin (dB)	Antenna Height (cm)	Table Angle (Degree)	Remark
2480	92.88	97.73	-4.85			100	253	Average
2480	95.13	99.98	-4.85			100	253	Peak
2483.52	37.37	42.22	-4.85	54	-16.63	100	253	Average
2483.52	47.57	52.42	-4.85	74	-26.43	100	253	Peak
4960	38.46	52.35	-13.89	54	-15.54	100	257	Average
4960	43.8	57.69	-13.89	74	-30.2	100	257	Peak

Remarks:

- Emission Level = Read Level + Factor
Margin value = Emission level – Limit value
- 2480 MHz: Fundamental frequency.
- The emission levels of other frequencies were very low against the limit.

9 kHz ~ 30 MHz Data:

The amplitude of spurious emissions attenuated more than 20 dB below the permissible value is not required to be report.

30 MHz ~ 1 GHz Worst-Case Data:

EUT Test Condition		Measurement Detail	
Channel	Channel 78	Frequency Range	30 MHz ~ 1 GHz
Input Power	120 Vac, 60 Hz	Detector Function	Peak (PK) Quasi-peak (QP)
Environmental Conditions	25 deg. C, 65 % RH	Tested By	Thomas Wei

Horizontal

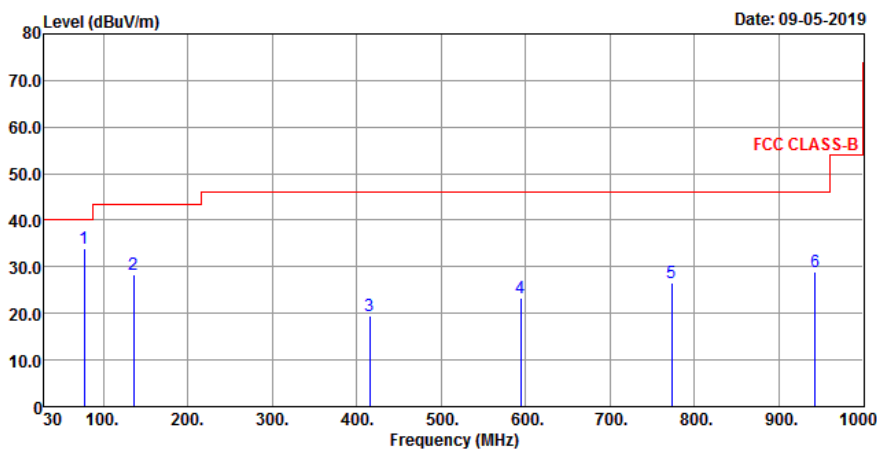

Vertical

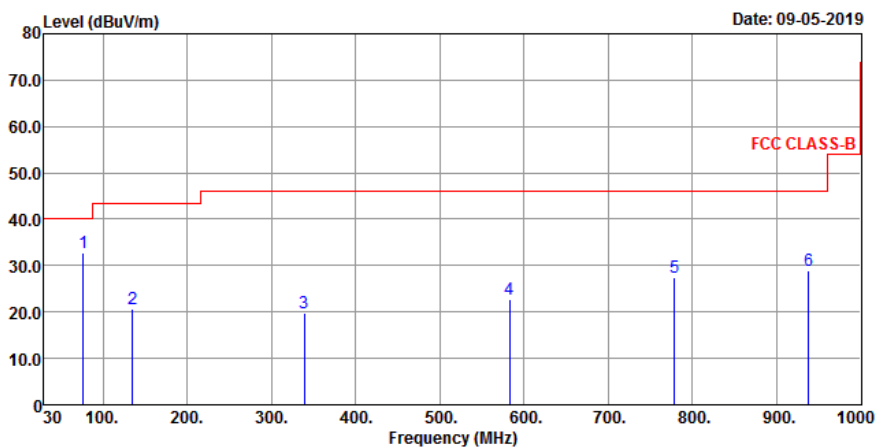

Antenna Polarity & Test Distance: Horizontal at 3 m

Frequency (MHz)	Emission Level (dBuV/m)	Read Level (dBuV)	Factor (dB/m)	Limit (dBuV/m)	Margin (dB)	Antenna Height (cm)	Table Angle (Degree)	Remark
77.53	34.04	55.28	-21.24	40	-5.96	125	141	Peak
135.73	28.22	46.58	-18.36	43.5	-15.28	148	167	Peak
415.09	19.52	32.61	-13.09	46	-26.48	189	206	Peak
594.54	23.22	31.64	-8.42	46	-22.78	216	233	Peak
773.02	26.59	31.07	-4.48	46	-19.41	258	271	Peak
942.77	28.96	31.7	-2.74	46	-17.04	299	317	Peak

Antenna Polarity & Test Distance: Vertical at 3 m

Frequency (MHz)	Emission Level (dBuV/m)	Read Level (dBuV)	Factor (dB/m)	Limit (dBuV/m)	Margin (dB)	Antenna Height (cm)	Table Angle (Degree)	Remark
76.56	32.67	53.75	-21.08	40	-7.33	135	146	Peak
134.76	20.6	38.85	-18.25	43.5	-22.9	156	167	Peak
339.43	19.64	34.54	-14.9	46	-26.36	199	216	Peak
582.9	22.67	31.65	-8.98	46	-23.33	237	248	Peak
778.84	27.55	32.08	-4.53	46	-18.45	255	261	Peak
937.92	28.83	31.61	-2.78	46	-17.17	288	293	Peak

Remarks:

- Emission Level = Read Level + Factor
Margin value = Emission level – Limit value
- The emission levels of other frequencies were very low against the limit.

4.2 Conducted Emission Measurement

4.2.1 Limits of Conducted Emission Measurement

Frequency (MHz)	Conducted Limit (dBuV)	
	Quasi-Peak	Average
0.15 - 0.5	66 - 56	56 - 46
0.50 - 5.0	56	46
5.0 - 30.0	60	50

- Note: 1. The lower limit shall apply at the transition frequencies.
 2. The limit decreases in line with the logarithm of the frequency in the range of 0.15 to 0.50 MHz.

4.2.2 Test Instruments

Description & Manufacturer	Model No.	Serial No.	Date of Calibration	Due Date of Calibration
Test Receiver ROHDE & SCHWARZ	ESCI	100613	Dec. 10, 2018	Dec. 09, 2019
RF signal cable Woken	5D-FB	Cable-cond1-01	Sep. 05, 2018	Sep. 04, 2019
LISN ROHDE & SCHWARZ (EUT)	ENV216	101826	Feb. 21, 2019	Feb. 20, 2020
LISN ROHDE & SCHWARZ (Peripheral)	ESH3-Z5	100311	Aug. 22, 2019	Aug. 21, 2020
Software ADT	BV ADT_Cond_ V7.3.7.4	NA	NA	NA

- Note: 1. The calibration interval of the above test instruments is 12 months and the calibrations are traceable to NML/ROC and NIST/USA.
 2. The test was performed in HwaYa Shielded Room 1.
 3. The VCCI Site Registration No. is C-12040.

4.2.3 Test Procedures

- The EUT was placed 0.4 meters from the conducting wall of the shielded room with EUT being connected to the power mains through a line impedance stabilization network (LISN). Other support units were connected to the power mains through another LISN. The two LISNs provide 50 ohm/ 50 uH of coupling impedance for the measuring instrument.
- Both lines of the power mains connected to the EUT were checked for maximum conducted interference.
- The frequency range from 150 kHz to 30 MHz was searched. Emission levels under (Limit – 20 dB) was not recorded.

Note: The resolution bandwidth and video bandwidth of test receiver is 9 kHz for quasi-peak detection (QP) and average detection (AV) at frequency 0.15 MHz - 30 MHz.

4.2.4 Deviation from Test Standard

No deviation.

4.2.5 Test Setup

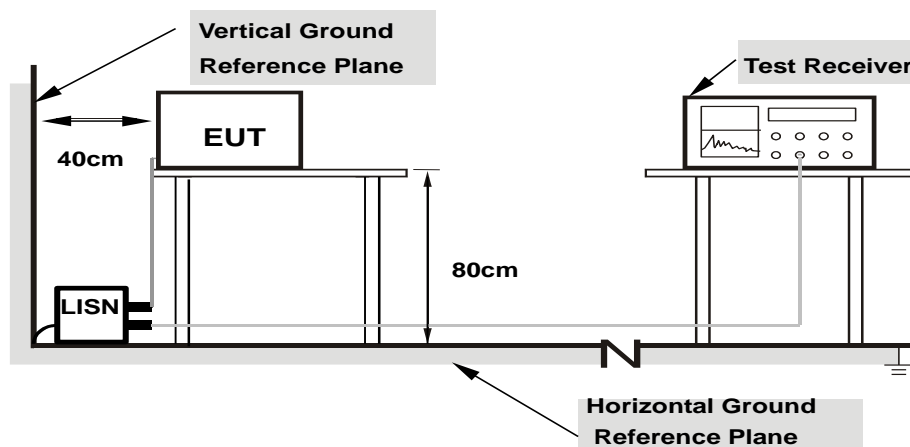

- Note:**
- Support units were connected to second LISN.
 - Both of LISNs (AMN) are 80 cm from EUT and at least 80 cm from other units and other metal planes

For the actual test configuration, please refer to the attached file (Test Setup Photo).

4.2.6 EUT Operating Condition

Set the EUT under transmission condition continuously at specific channel frequency.

4.2.7 Test Results

CONDUCTED WORST-CASE DATA : GFSK

Frequency Range	150kHz ~ 30MHz	Detector Function & Resolution Bandwidth	Quasi-Peak (QP) / Average (AV), 9kHz
Input Power	120Vac, 60Hz	Environmental Conditions	25°C, 65%RH
Tested by	Thomas Wei	Test Date	2019/9/4

Phase Of Power : Line (L)										
No	Frequency (MHz)	Correction Factor (dB)	Reading Value (dBuV)		Emission Level (dBuV)		Limit (dBuV)		Margin (dB)	
			Q.P.	AV.	Q.P.	AV.	Q.P.	AV.	Q.P.	AV.
1	0.17346	9.84	13.91	6.62	23.75	16.46	64.79	54.79	-41.04	-38.33
2	0.27918	9.86	12.53	7.23	22.39	17.09	60.84	50.84	-38.45	-33.75
3	0.36526	9.87	17.37	9.16	27.24	19.03	58.61	48.61	-31.37	-29.58
4	0.45097	9.88	23.44	17.35	33.32	27.23	56.86	46.86	-23.54	-19.63
5	0.83106	9.91	14.48	7.49	24.39	17.40	56.00	46.00	-31.61	-28.60
6	1.88995	9.95	12.31	3.49	22.26	13.44	56.00	46.00	-33.74	-32.56

Remarks:

1. Q.P. and AV. are abbreviations of quasi-peak and average individually.
2. The emission levels of other frequencies were very low against the limit.
3. Margin value = Emission level – Limit value
4. Correction factor = Insertion loss + Cable loss
5. Emission Level = Correction Factor + Reading Value

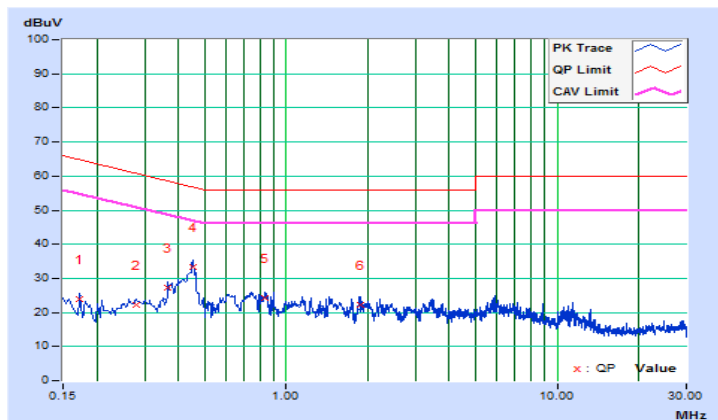

Frequency Range	150kHz ~ 30MHz	Detector Function & Resolution Bandwidth	Quasi-Peak (QP) / Average (AV), 9kHz
Input Power	120Vac, 60Hz	Environmental Conditions	25°C, 65%RH
Tested by	Thomas Wei	Test Date	2019/9/4

Phase Of Power : Neutral (N)										
No	Frequency (MHz)	Correction Factor (dB)	Reading Value (dBuV)		Emission Level (dBuV)		Limit (dBuV)		Margin (dB)	
			Q.P.	AV.	Q.P.	AV.	Q.P.	AV.	Q.P.	AV.
1	0.16181	9.82	14.52	5.22	24.34	15.04	65.37	55.37	-41.03	-40.33
2	0.24384	9.85	13.04	3.15	22.89	13.00	61.96	51.96	-39.07	-38.96
3	0.39242	9.87	16.29	9.10	26.16	18.97	58.01	48.01	-31.85	-29.04
4	0.44040	9.87	19.79	12.22	29.66	22.09	57.05	47.05	-27.39	-24.96
5	0.73650	9.88	14.18	6.11	24.06	15.99	56.00	46.00	-31.94	-30.01
6	2.64849	9.95	11.21	2.06	21.16	12.01	56.00	46.00	-34.84	-33.99

Remarks:

1. Q.P. and AV. are abbreviations of quasi-peak and average individually.
2. The emission levels of other frequencies were very low against the limit.
3. Margin value = Emission level – Limit value
4. Correction factor = Insertion loss + Cable loss
5. Emission Level = Correction Factor + Reading Value

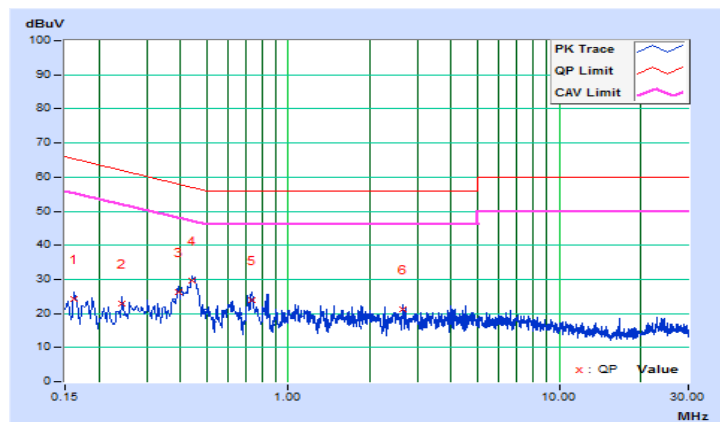

4.3 Number of Hopping Frequency Used

4.3.1 Limits of Hopping Frequency Used Measurement

At least 15 channels frequencies, and should be equally spaced.

4.3.2 Test Setup

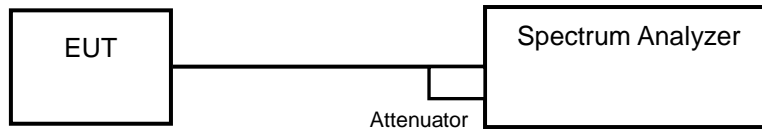

4.3.3 Test Instruments

Refer to section 4.1.2 to get information of above instrument.

4.3.4 Test Procedure

- a. Check the calibration of the measuring instrument (SA) using either an internal calibrator or a known signal from an external generator.
- b. Turn on the EUT and connect its antenna terminal to measurement via a low loss cable. Then set it to any one measured frequency within its operating range and make sure the instrument is operated in its linear range.
- c. Set the SA on MaxHold Mode, and then keep the EUT in hopping mode. Record all the signals from each channel until each one has been recorded.
- d. Set the SA on View mode and then plot the result on SA screen.
- e. Repeat above procedures until all frequencies measured were complete.

4.3.5 Deviation from Test Standard

No deviation.

4.3.6 Test Results

There are 79 hopping frequencies in the hopping mode. Please refer to the following test result. On the plots, it shows that the hopping frequencies are equally spaced.

<GFSK>

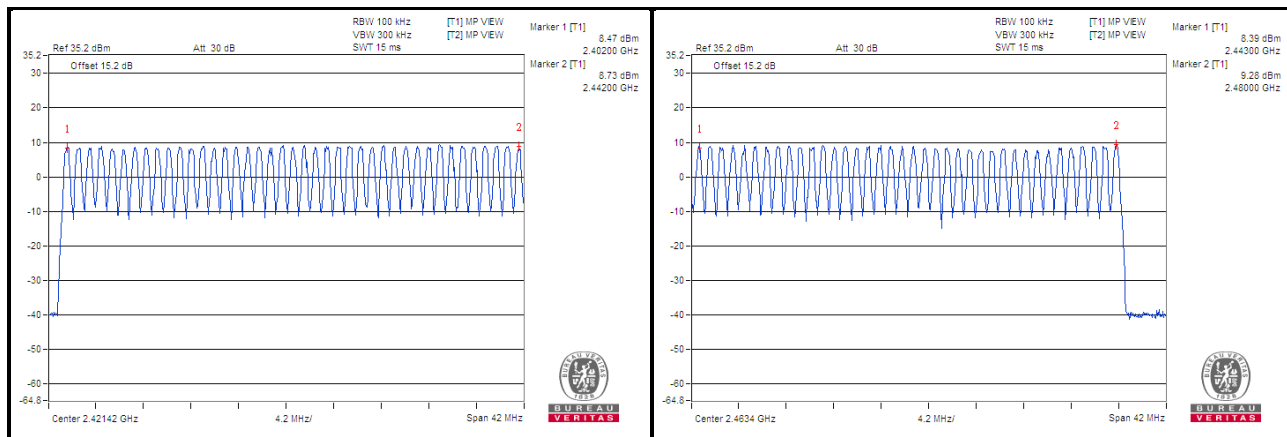

<8DPSK>

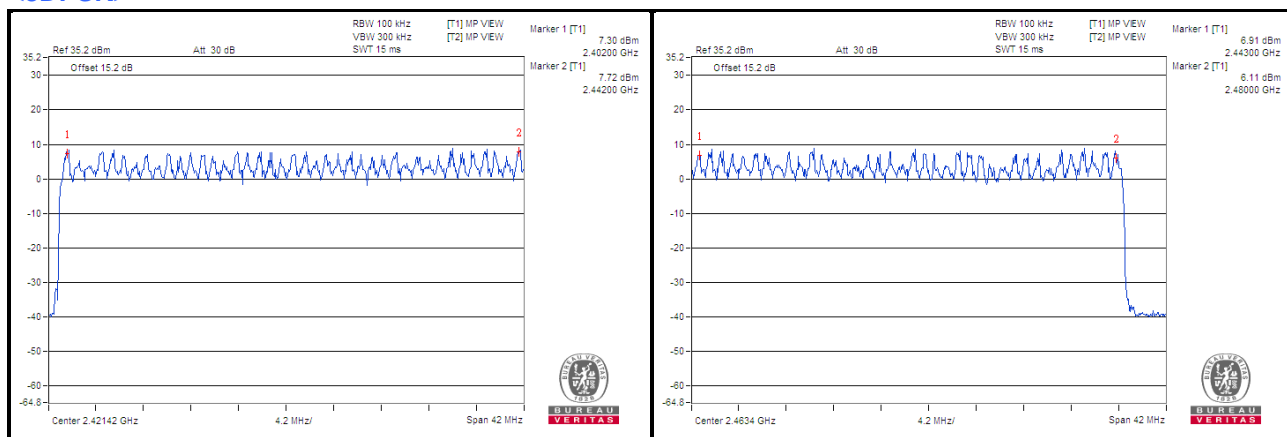

4.4 Dwell Time on Each Channel

4.4.1 Limits of Dwell Time on Each Channel Measurement

The average time of occupancy on any channel shall not be greater than 0.4 seconds within a period of 0.4 seconds multiplied by the number of hopping channels employed.

4.4.2 Test Setup

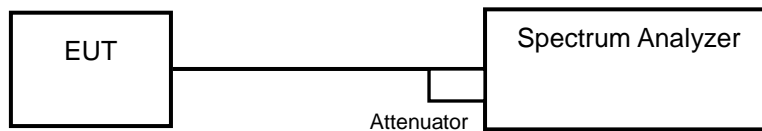

4.4.3 Test Instruments

Refer to section 4.1.2 to get information of above instrument.

4.4.4 Test Procedures

- a. Check the calibration of the measuring instrument (SA) using either an internal calibrator or a known signal from an external generator.
- b. Turn on the EUT and connect its antenna terminal to measurement via a low loss cable. Then set it to any one measured frequency within its operating range and make sure the instrument is operated in its linear range.
- c. Adjust the center frequency of SA on any frequency be measured and set SA to zero span mode. And then, set RBW and VBW of spectrum analyzer to proper value.
- d. Measure the time duration of one transmission on the measured frequency. And then plot the result with time difference of this time duration.
- e. Repeat above procedures until all different time-slot modes have been completed.

4.4.5 Deviation from Test Standard

No deviation.

4.4.6 Test Results

GFSK

Mode	Number of Transmission in a 31.6 (79 Hopping*0.4)	Length of Transmission Time (msec)	Result (msec)	Limit (msec)
DH1	50 (times / 5 sec) * 6.32 = 316 times	0.426	134.62	400
DH3	26 (times / 5 sec) * 6.32 = 164.32 times	1.68	276.06	400
DH5	18 (times / 5 sec) * 6.32 = 113.76 times	2.94	334.45	400

Note: Test plots of the transmitting time slot are shown as below.



8DPSK

Mode	Number of Transmission in a 31.6 (79 Hopping*0.4)	Length of Transmission Time (msec)	Result (msec)	Limit (msec)
3DH1	50 (times / 5 sec) * 6.32 = 316 times	0.426	134.62	400
3DH3	25 (times / 5 sec) * 6.32 = 158 times	1.71	270.18	400
3DH5	17 (times / 5 sec) * 6.32 = 107.44 times	2.94	315.87	400

Note: Test plots of the transmitting time slot are shown as below.

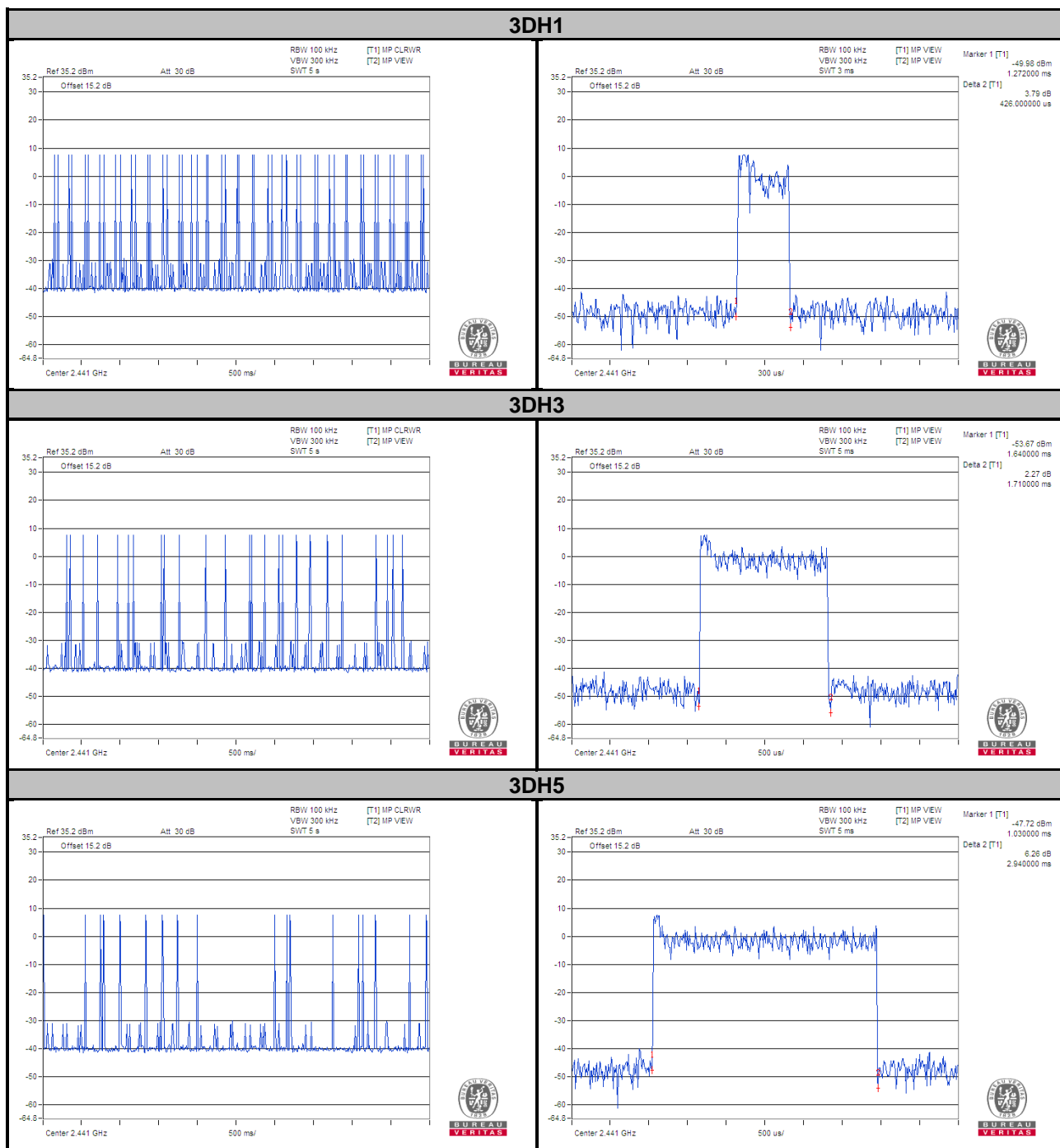

4.5 Channel Bandwidth

4.5.1 Limits of Channel Bandwidth Measurement

For frequency hopping system operating in the 2400-2483.5 MHz, if the 20 dB bandwidth of hopping channel is greater than 25 kHz, two-thirds 20 dB bandwidth of hopping channel shall be a minimum limit for the hopping channel separation.

4.5.2 Test Setup



4.5.3 Test Instruments

Refer to section 4.1.2 to get information of above instrument.

4.5.4 Test Procedure

- Check the calibration of the measuring instrument using either an internal calibrator or a known signal from an external generator.
- Turn on the EUT and connect it to measurement instrument. Then set it to any one convenient frequency within its operating range. Set a reference level on the measuring instrument equal to the highest peak value.
- Measure the frequency difference of two frequencies that were attenuated 20 dB from the reference level. Record the frequency difference as the emission bandwidth.
- Repeat above procedures until all frequencies measured were complete.

4.5.5 Deviation from Test Standard

No deviation.

4.5.6 EUT Operating Condition

The software provided by client enabled the EUT to transmit and receive data at lowest, middle and highest channel frequencies individually.

4.5.7 Test Results

Channel	Frequency (MHz)	20 dB Bandwidth (MHz)	
		GFSK	8DPSK
0	2402	0.88	1.27
39	2441	0.87	1.28
78	2480	0.89	1.28

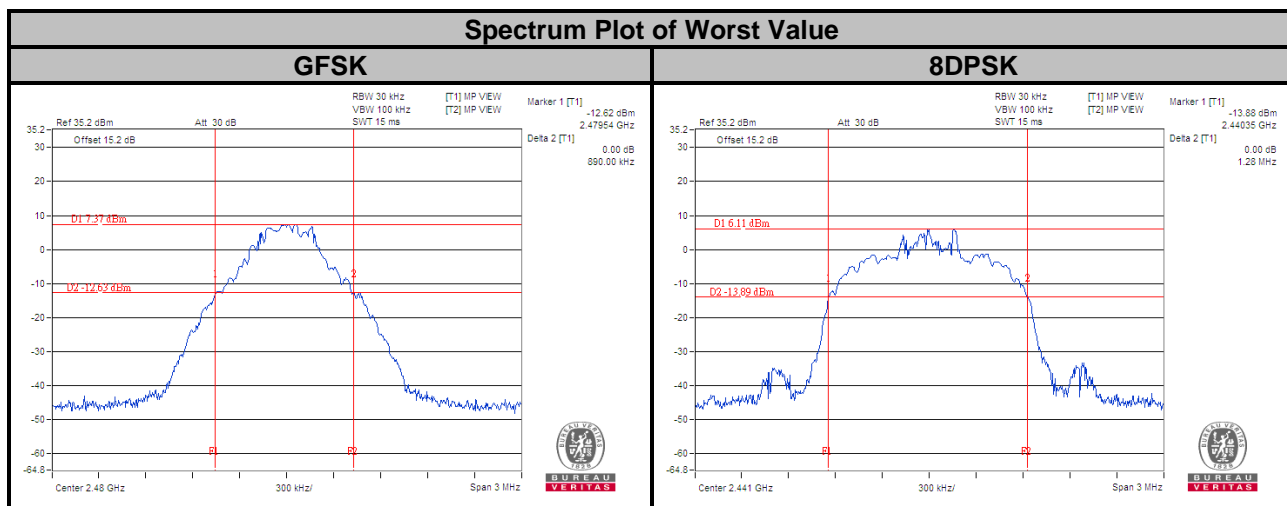

4.6 Occupied Bandwidth Measurement

4.6.1 Test Setup

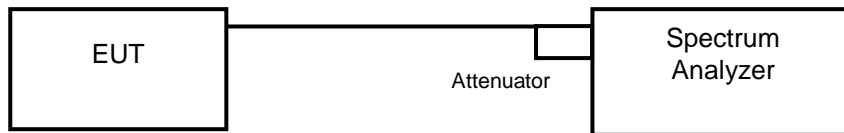

4.6.2 Test Instruments

Refer to section 4.1.2 to get information of above instrument

4.6.3 Test Procedure

The transmitter output was connected to the spectrum analyzer through an attenuator. The bandwidth of the fundamental frequency was measured by spectrum analyzer with resolution bandwidth in the range of 1 % to 5 % of the anticipated emission bandwidth, and a video bandwidth at least 3x the resolution bandwidth and set the detector to PEAK. The width of a frequency band such that, below the lower and above the upper frequency limits, the mean powers emitted are each equal to a specified percentage 0.5 % of the total mean power of a given emission.

4.6.4 Deviation from Test Standard

No deviation.

4.6.5 EUT Operating Conditions

The software provided by client to enable the EUT under transmission condition continuously at lowest, middle and highest channel frequencies individually.

4.6.6 Test Results

Channel	Frequency (MHz)	Occupied Bandwidth (MHz)	
		GFSK	8DPSK
0	2402	0.77	1.17
39	2441	0.76	1.17
78	2480	0.77	1.17

Spectrum Plot of Worst Value

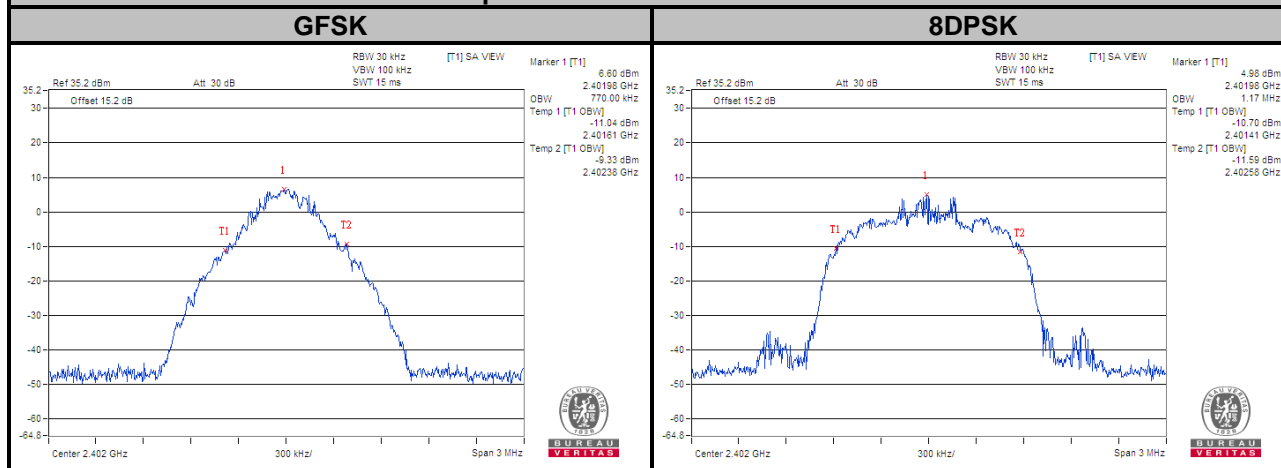

4.7 Hopping Channel Separation

4.7.1 Limits of Hopping Channel Separation Measurement

At least 25 kHz or two-third of 20 dB hopping channel bandwidth (whichever is greater).

4.7.2 Test Setup



4.7.3 Test Instruments

Refer to section 4.1.2 to get information of above instrument.

4.7.4 Test Procedure

Measurement Procedure REF

- Check the calibration of the measuring instrument using either an internal calibrator or a known signal from an external generator.
- Turn on the EUT and connect it to measurement instrument. Then set it to any one convenient frequency within its operating range.
- By using the MaxHold function record the separation of two adjacent channels.
- Measure the frequency difference of these two adjacent channels by SA MARK function. And then plot the result on SA screen.
- Repeat above procedures until all frequencies measured were complete.

4.7.5 Deviation from Test Standard

No deviation.

4.7.6 Test Results

Channel	Freq. (MHz)	Adjacent Channel Separation (MHz)		20 dB Bandwidth (MHz)		Minimum Limit (MHz)		Pass / Fail
		GFSK	8DPSK	GFSK	8DPSK	GFSK	8DPSK	
0	2402	1.00	1.00	0.88	1.27	0.59	1.17	Pass
39	2441	1.00	1.00	0.87	1.28	0.58	1.17	Pass
78	2480	1.00	1.00	0.89	1.28	0.60	1.17	Pass

Note:

- The minimum limit is two-third 20 dB bandwidth.

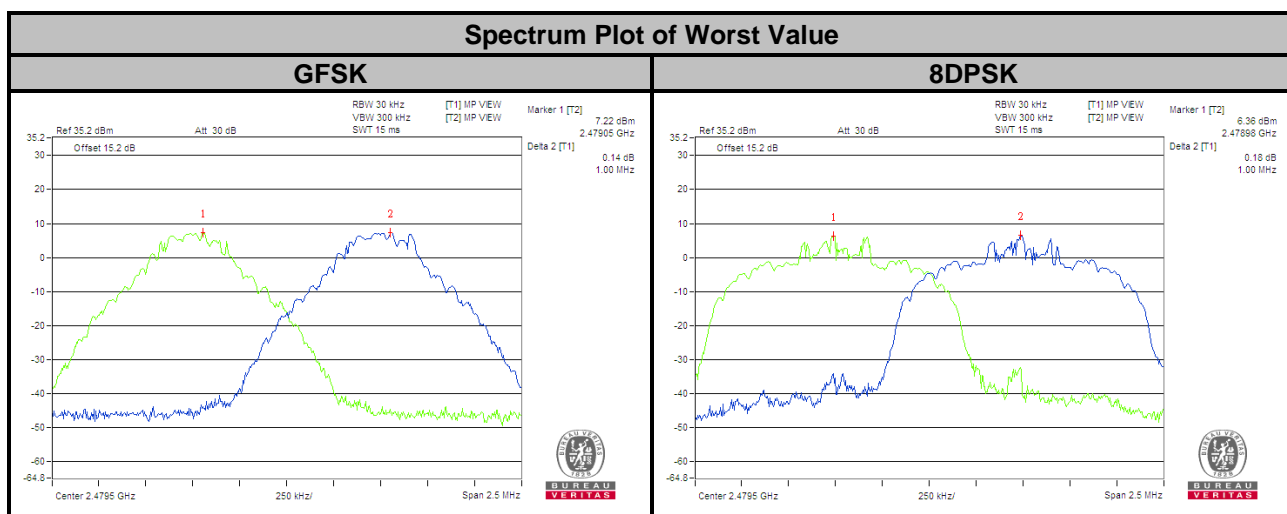

4.8 Maximum Output Power

4.8.1 Limits of Maximum Output Power Measurement

Refer to Regulation 15.247 (a)(1), the Maximum Output Power Measurement is 125 mW.

4.8.2 Test Setup

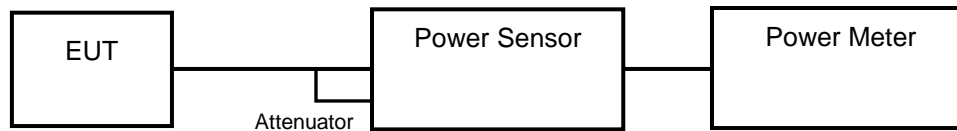

4.8.3 Test Instruments

Refer to section 4.1.2 to get information of above instrument.

4.8.4 Test Procedure

A peak power sensor was used on the output port of the EUT. A power meter was used to read the response of the peak power sensor. Record the power level.

4.8.5 Deviation from Test Standard

No deviation.

4.8.6 EUT Operating Condition

The software provided by client enabled the EUT to transmit and receive data at lowest, middle and highest channel frequencies individually.

4.8.7 Test Results

<GFSK>

Channel	Freq. (MHz)	Peak Power (mW)	Peak Power (dBm)	Power Limit (mW)	Pass / Fail
0	2402	8.472	9.28	125	Pass
39	2441	8.892	9.49	125	Pass
78	2480	9.528	9.79	125	Pass

<8DPSK>

Channel	Freq. (MHz)	Peak Power (mW)	Peak Power (dBm)	Power Limit (mW)	Pass / Fail
0	2402	7.161	8.55	125	Pass
39	2441	7.295	8.63	125	Pass
78	2480	7.816	8.93	125	Pass

4.9 Conducted Out of Band Emission Measurement

4.9.1 Limits Of Conducted Out of Band Emission Measurement

Below -20 dB of the highest emission level of operating band (in 100 kHz RBW).

4.9.2 Test Instruments

Refer to section 4.1.2 to get information of above instrument.

4.9.3 Test Procedure

The transmitter output was connected to the spectrum analyzer via a low lose cable. Set both RBW and VBW of spectrum analyzer to 100 kHz and 300 kHz with suitable frequency span including 100 MHz bandwidth from band edge. The band edges was measured and recorded.

4.9.4 Deviation from Test Standard

No deviation.

4.9.5 EUT Operating Condition

The software provided by client enabled the EUT to transmit and receive data at lowest, middle and highest channel frequencies individually.

4.9.6 Test Results

The spectrum plots are attached on the following images. D1 line indicates the highest level, D2 line indicates the 20 dB offset below D1. It shows compliance with the requirement.

GFSK

Hopping Disabled_Low Channel

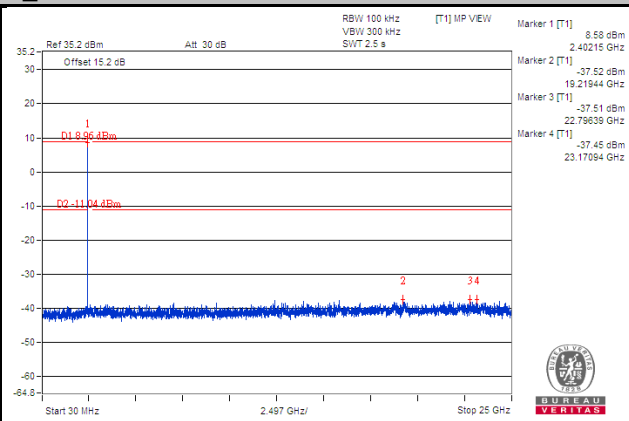
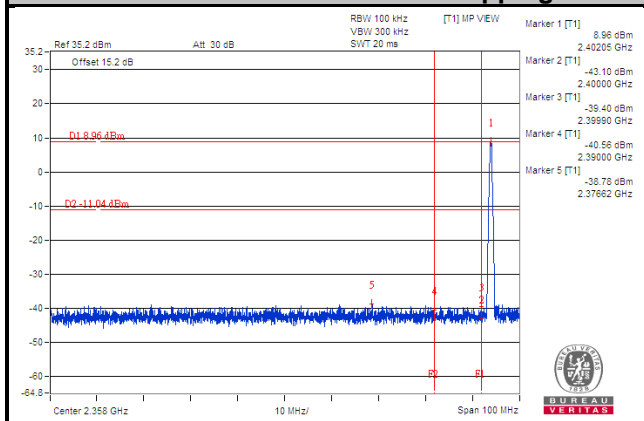

Hopping Disabled_Middle Channel

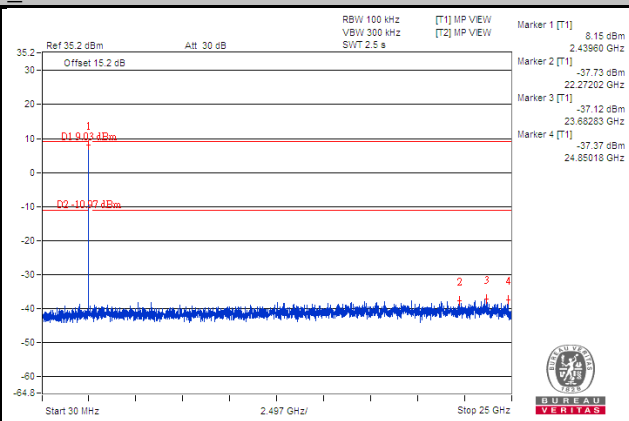
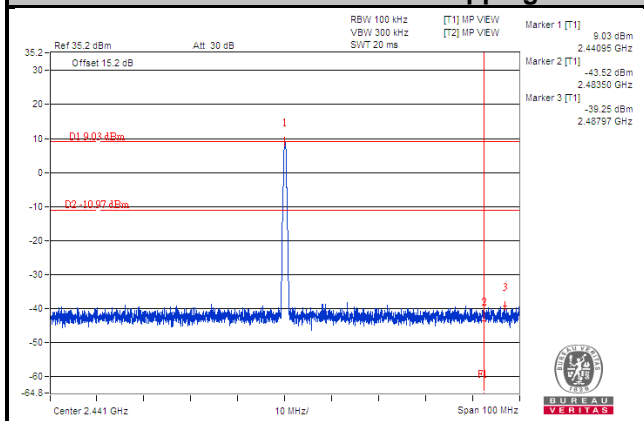

Hopping Disabled_High Channel

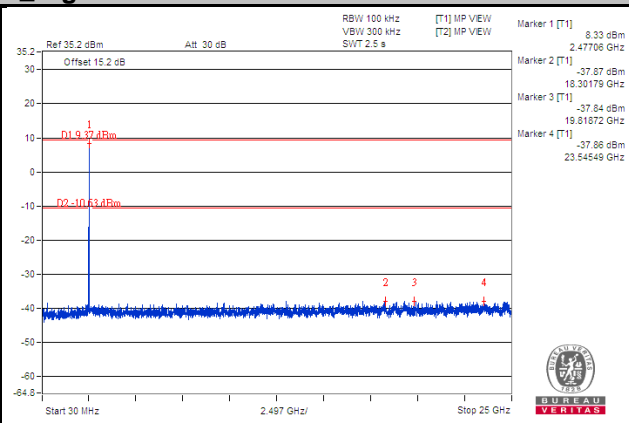
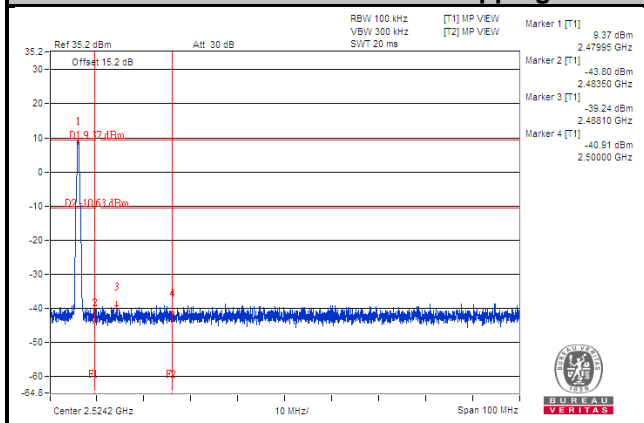



BUREAU VERITAS

Hopping Enabled_Low Channel

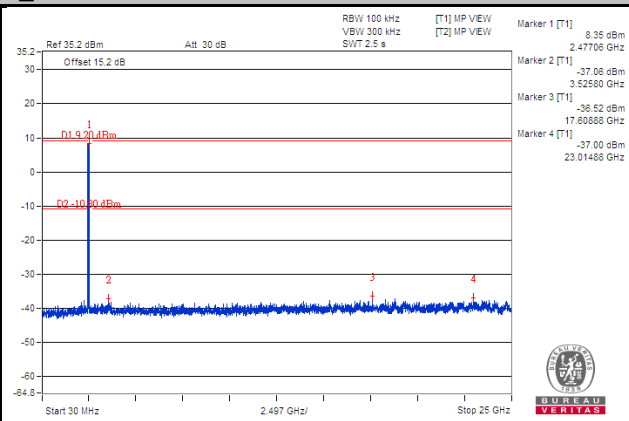
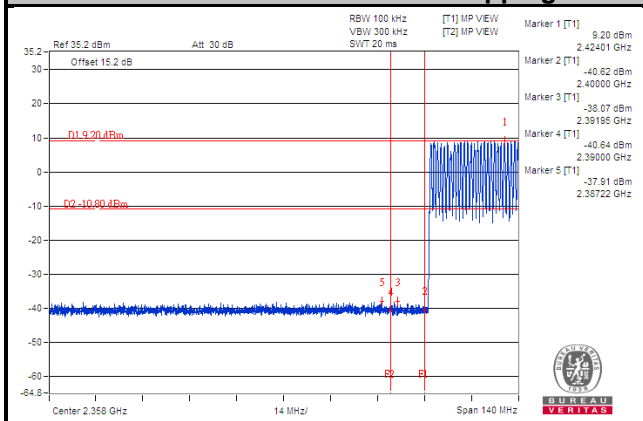

Hopping Enabled_High Channel

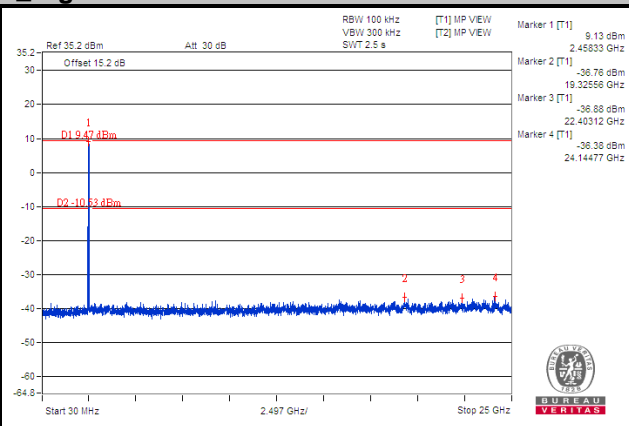
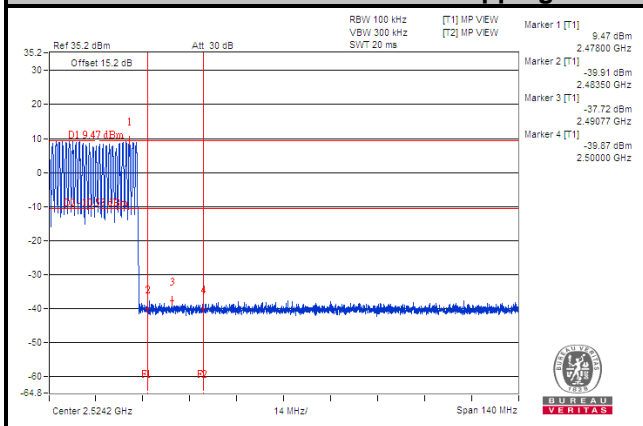

8DPSK

Hopping Disabled_Low Channel

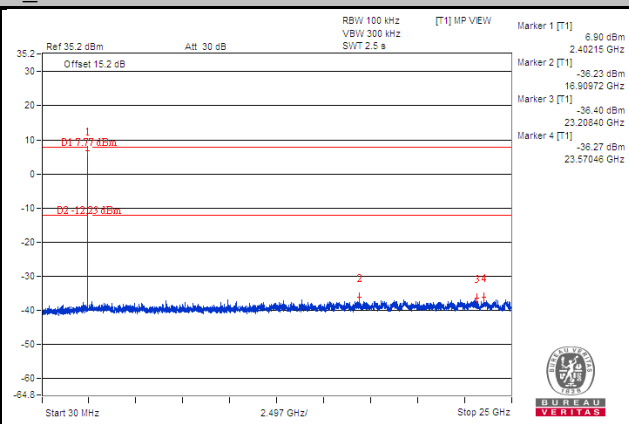
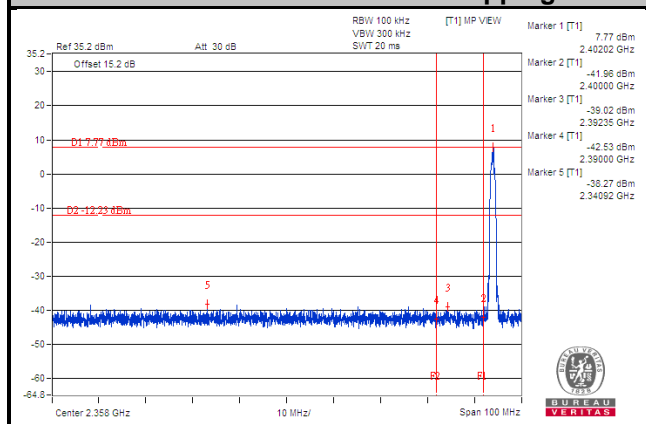

Hopping Disabled_Middle Channel

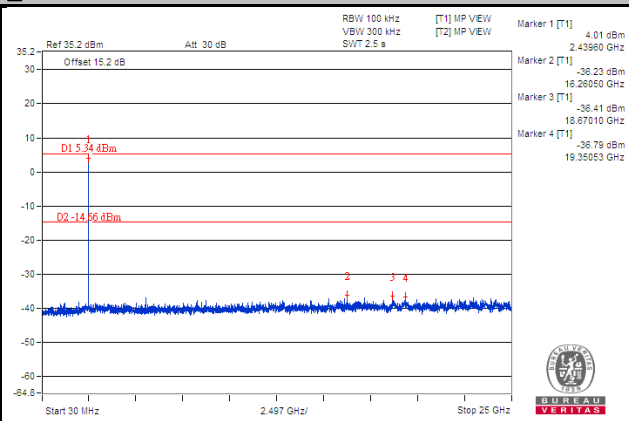
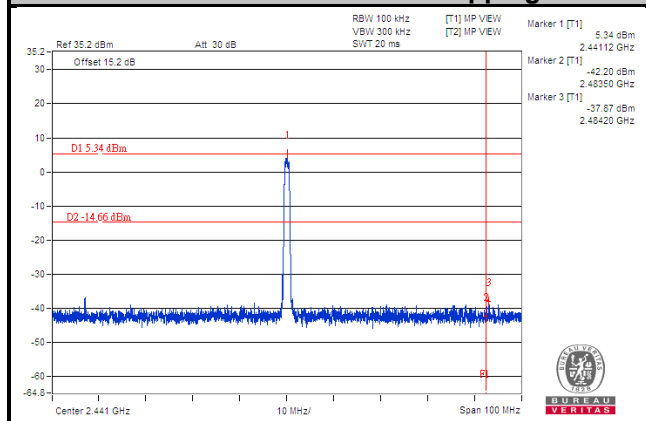

Hopping Disabled_High Channel

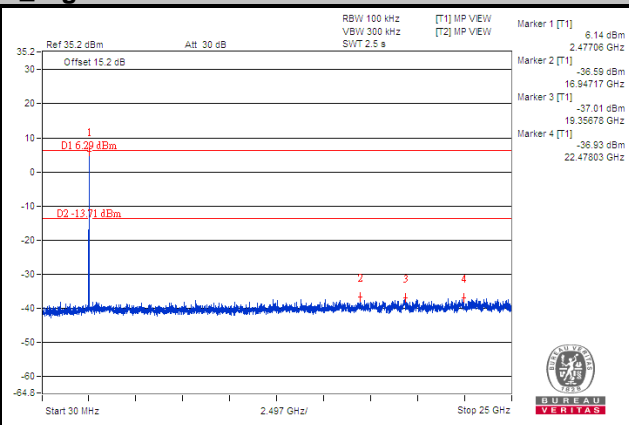
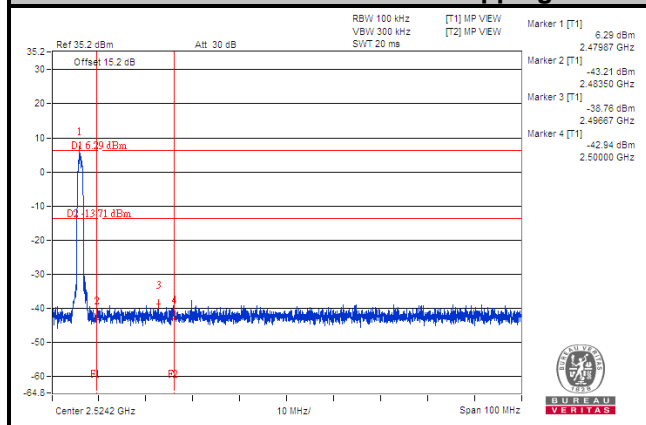

Hopping Enabled_Low Channel

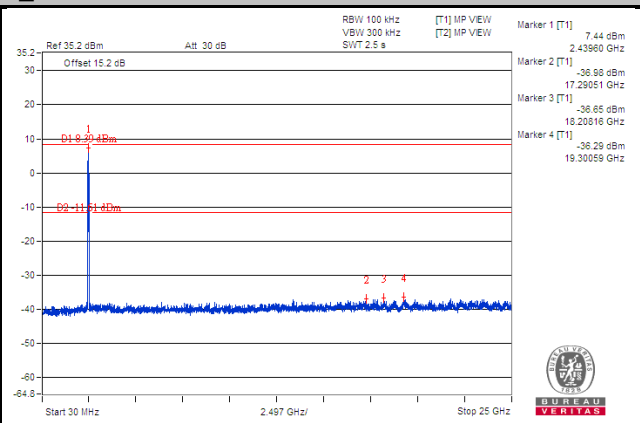
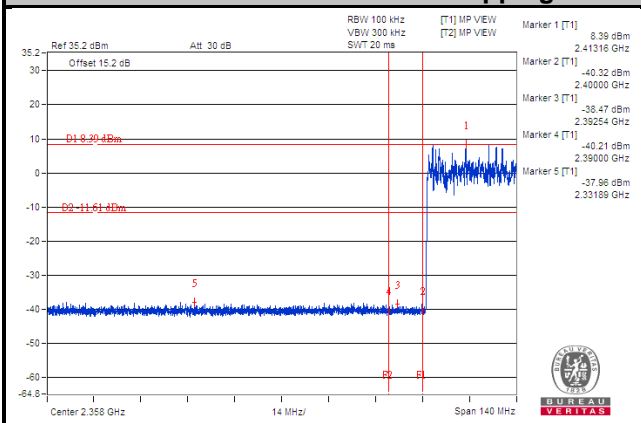

Hopping Enabled_High Channel

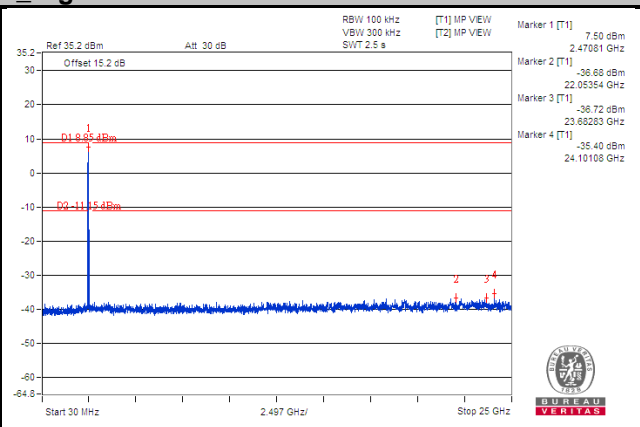
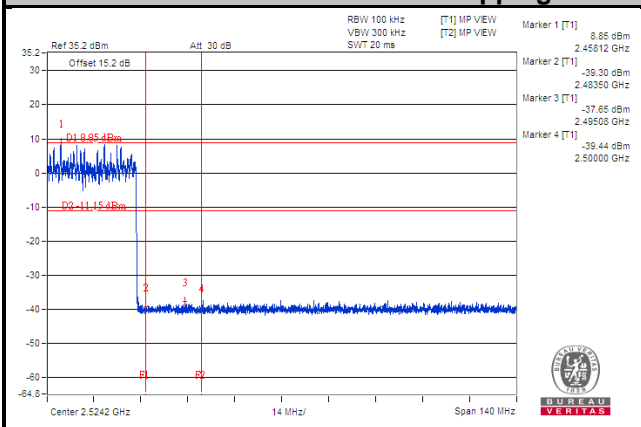

5 Pictures of Test Arrangements

Please refer to the attached file (Test Setup Photo).

Appendix – Information of the Testing Laboratories

We, Bureau Veritas Consumer Products Services (H.K.) Ltd., Taoyuan Branch, were founded in 1988 to provide our best service in EMC, Radio, Telecom and Safety consultation. Our laboratories are FCC recognized accredited test firms and accredited according to ISO/IEC 17025.

If you have any comments, please feel free to contact us at the following:

Lin Kou EMC/RF Lab

Tel: 886-2-26052180

Fax: 886-2-26051924

Hsin Chu EMC/RF/Telecom Lab

Tel: 886-3-6668565

Fax: 886-3-6668323

Hwa Ya EMC/RF/Safety Lab

Tel: 886-3-3183232

Fax: 886-3-3270892

Email: service.adt@tw.bureauveritas.com

Web Site: www.bureauveritas-adt.com

The address and road map of all our labs can be found in our web site also.

--- END ---