

FCC Test Report

Report No.: RF190723C05-3

FCC ID: ZL5S52E

Test Model: S52

Received Date: Jul. 23, 2019

Test Date: Aug. 13 ~ Sep. 23, 2019

Issued Date: Oct. 05, 2019

Applicant: Bullitt Group

Address: One Valpy, Valpy Street, Reading, RG1 1AR, Berkshire, UK

Issued By: Bureau Veritas Consumer Products Services (H.K.) Ltd., Taoyuan Branch
Lin Kou Laboratories

Lab Address: No. 47-2, 14th Ling, Chia Pau Vil., Lin Kou Dist., New Taipei City, Taiwan

Test Location: No.19, Hwa Ya 2nd Rd., Wen Hwa Vil., Kwei Shan Dist., Taoyuan City
33383, Taiwan

**FCC Registration /
Designation Number:** 788550 / TW0003



This report is for your exclusive use. Any copying or replication of this report to or for any other person or entity, or use of our name or trademark, is permitted only with our prior written permission. This report sets forth our findings solely with respect to the test samples identified herein. The results set forth in this report are not indicative or representative of the quality or characteristics of the lot from which a test sample was taken or any similar or identical product unless specifically and expressly noted. Our report includes all of the tests requested by you and the results thereof based upon the information that you provided to us. You have 60 days from date of issuance of this report to notify us of any material error or omission caused by our negligence, provided, however, that such notice shall be in writing and shall specifically address the issue you wish to raise. A failure to raise such issue within the prescribed time shall constitute your unqualified acceptance of the completeness of this report, the tests conducted and the correctness of the report contents. Unless specific mention, the uncertainty of measurement has been explicitly taken into account to declare the compliance or non-compliance to the specification. The report must not be used by the client to claim product certification, approval, or endorsement by TAF or any government agencies.

Table of Contents

Release Control Record	4
1 Certificate of Conformity	5
2 Summary of Test Results	6
2.1 Measurement Uncertainty	6
2.2 Modification Record	6
3 General Information	7
3.1 General Description of EUT	7
3.2 Description of Test Modes	9
3.2.1 Test Mode Applicability and Tested Channel Detail	11
3.3 Duty Cycle of Test Signal	13
3.4 Description of Support Units	14
3.4.1 Configuration of System under Test	14
3.5 General Description of Applied Standards	14
4 Test Types and Results	15
4.1 Radiated Emission and Bandedge Measurement	15
4.1.1 Limits of Radiated Emission and Bandedge Measurement	15
4.1.2 Limits of Unwanted Emission Out of the Restricted Bands	16
4.1.3 Test Instruments	17
4.1.4 Test Procedures	18
4.1.5 Deviation from Test Standard	19
4.1.6 Test Setup	19
4.1.7 EUT Operating Conditions	20
4.1.8 Test Results	21
4.2 Conducted Emission Measurement	61
4.2.1 Limits of Conducted Emission Measurement	61
4.2.2 Test Instruments	61
4.2.3 Test Procedures	62
4.2.4 Deviation from Test Standard	62
4.2.5 Test Setup	62
4.2.6 EUT Operating Conditions	62
4.2.7 Test Results	63
4.3 Transmit Power Measurement	65
4.3.1 Limits of Transmit Power Measurement	65
4.3.2 Test Setup	65
4.3.3 Test Instruments	66
4.3.4 Test Procedure	66
4.3.5 Deviation from Test Standard	66
4.3.6 EUT Operating Conditions	66
4.3.7 Test Results	67
4.4 Occupied Bandwidth Measurement	73
4.4.1 Test Setup	73
4.4.2 Test Instruments	73
4.4.3 Test Procedure	73
4.4.4 Test Results	74
4.5 Peak Power Spectral Density Measurement	77
4.5.1 Limits of Peak Power Spectral Density Measurement	77
4.5.2 Test Setup	77
4.5.3 Test Instruments	77
4.5.4 Test Procedures	77
4.5.5 Deviation from Test Standard	78
4.5.6 EUT Operating Conditions	78
4.5.7 Test Results	79
4.6 Frequency Stability	84

4.6.1	Limit of Frequency Stability Measurement	84
4.6.2	Test Setup	84
4.6.3	Test Instruments	84
4.6.4	Test Procedure	84
4.6.5	Deviation from Test Standard	84
4.6.6	EUT Operating Condition	84
4.6.7	Test Results	85
4.7	6 dB Bandwidth Measurement.....	86
4.7.1	Limits of 6 dB Bandwidth Measurement.....	86
4.7.2	Test Setup.....	86
4.7.3	Test Instruments	86
4.7.4	Test Procedure	86
4.7.5	Deviation from Test Standard	86
4.7.6	EUT Operating Condition	86
4.7.7	Test Results	87
5	Pictures of Test Arrangements.....	89
	Annex A- Radiated Out of Band Emission (OOBE) Measurement (For U-NII-3 band)	90
	Appendix – Information of the Testing Laboratories	93

Release Control Record

Issue No.	Description	Date Issued
RF190723C05-3	Original Release	Oct. 05, 2019

1 Certificate of Conformity

Product: Rugged Smart Phone

Brand: CAT

Test Model: S52

Sample Status: Identical Prototype

Applicant: Bullitt Group

Test Date: Aug. 13 ~ Sep. 23, 2019

Standards: 47 CFR FCC Part 15, Subpart E (Section 15.407)
ANSI C63.10:2013

The above equipment has been tested by **Bureau Veritas Consumer Products Services (H.K.) Ltd., Taoyuan Branch**, and found compliance with the requirement of the above standards. The test record, data evaluation & Equipment Under Test (EUT) configurations represented herein are true and accurate accounts of the measurements of the sample's RF characteristics under the conditions specified in this report.

Prepared by : Gina Liu , **Date:** Oct. 05, 2019
Gina Liu / Specialist

Approved by : Dylan Chiou , **Date:** Oct. 05, 2019
Dylan Chiou / Project Engineer

2 Summary of Test Results

47 CFR FCC Part 15, Subpart E (Section 15.407)			
FCC Clause	Test Item	Result	Remarks
15.407(b)(6)	AC Power Conducted Emissions	Pass	Meet the requirement of limit. Minimum passing margin is -18.64 dB at 0.44716 MHz.
15.407(b) (1/2/3/4(i/ii)/6)	Radiated Emissions & Band Edge Measurement	Pass	Meet the requirement of limit. Minimum passing margin is -0.19 dB at 16500 MHz.
15.407(a)(1/2/3)	Max Average Transmit Power	Pass	Meet the requirement of limit.
---	Occupied Bandwidth Measurement	-	Reference only
15.407(a)(1/2/3)	Peak Power Spectral Density	Pass	Meet the requirement of limit.
15.407(e)	6 dB Bandwidth	Pass	Meet the requirement of limit. (U-NII-3 Band only)
15.407(g)	Frequency Stability	Pass	Meet the requirement of limit.
15.203	Antenna Requirement	Pass	No antenna connector is used.

Note:

- For U-NII-3 band compliance with rule part 15.407(b)(4)(i), the OOB test plots were recorded in Annex A.
- Determining compliance based on the results of the compliance measurement, not taking into account measurement instrumentation uncertainty.

2.1 Measurement Uncertainty

Where relevant, the following measurement uncertainty levels have been estimated for tests performed on the EUT as specified in CISPR 16-4-2:

Measurement	Frequency	Expanded Uncertainty (k=2) (±)
Conducted Emissions at mains ports	150 kHz ~ 30 MHz	2.44 dB
Radiated Emissions up to 1 GHz	9 kHz ~ 30 MHz	3.04 dB
	30 MHz ~ 200 MHz	2.93 dB
	200 MHz ~ 1000 MHz	2.95 dB
Radiated Emissions above 1 GHz	1 GHz ~ 18 GHz	2.26 dB
	18 GHz ~ 40 GHz	1.94 dB

2.2 Modification Record

There were no modifications required for compliance.

3 General Information

3.1 General Description of EUT

Product	Rugged Smart Phone
Brand	CAT
Test Model	S52
Status of EUT	Identical Prototype
Power Supply Rating	5-8 Vdc / 8.5-10 Vdc / 10-12 Vdc (adapter 1) 5.0 Vdc / 9.0 Vdc / 12.0 Vdc (adapter 2) 3.8 Vdc (Li-ion battery)
Modulation Type	256QAM, 64QAM, 16QAM, QPSK, BPSK
Modulation Technology	OFDM
Transfer Rate	802.11a: 54.0/ 48.0/ 36.0/ 24.0/ 18.0/ 12.0/ 9.0/ 6.0 Mbps 802.11n: up to 200.0 Mbps 802.11ac: up to 433.3 Mbps
Operating Frequency	5180 ~ 5240 MHz, 5260 ~ 5320 MHz, 5500 ~ 5700 MHz, 5745 ~ 5825 MHz
Number of Channel	5180 ~ 5240 MHz: 4 for 802.11a, 802.11n (HT20) 2 for 802.11n (HT40) 1 for 802.11ac (VHT80) 5260 ~ 5320 MHz: 4 for 802.11a, 802.11n (HT20) 2 for 802.11n (HT40) 1 for 802.11ac (VHT80) 5500 ~ 5700 MHz: 11 for 802.11a, 802.11n (HT20) 5 for 802.11n (HT40) 2 for 802.11ac (VHT80) 5745 ~ 5825 MHz: 5 for 802.11a, 802.11n (HT20) 2 for 802.11n (HT40) 1 for 802.11ac (VHT80)
Output Power	24.774 mW for 5180 ~ 5240 MHz 24.322 mW for 5260 ~ 5320 MHz 24.889 mW for 5500 ~ 5700 MHz 25.061 mW for 5745 ~ 5825 MHz
Antenna Type	Loop antenna with -8.3 dBi gain
Antenna Connector	N/A
Accessory Device	Refer to Note as below
Data Cable Supplied	Refer to Note as below

Note:

- The EUT details of the sample are as follows.

Sample	Description
DS	Dual SIM
SS	Single SIM
* The samples have the same layout, circuit, and components, but different SIM tray.	

After pre-tested with the EUT, only the worst sample (Dual SIM) was chosen for the final test.

2. The EUT incorporates a SISO function. Physically, the EUT provides one completed transmitter and one receiver.

Modulation Mode	Tx Function
802.11a	1TX
802.11n (HT20)	1TX
802.11n (HT40)	1TX
802.11ac (VHT20)	1TX
802.11ac (VHT40)	1TX
802.11ac (VHT80)	1TX

* The modulation and bandwidth are similar for 802.11n mode for HT20 / HT40 and 802.11ac mode for VHT20 / VHT40, therefore investigated worst case to representative mode in test report. (Final test mode refer section 3.2.1)

3. The EUT contains following accessory devices.

Product	Manufacture	Model	Description
Adapter 1	Lucent Trans Electronics Co., LTD.	1M52	I/P: 100-240 Vac, 50-60 Hz, 500 mA O/P: 5Vdc-8Vdc, 2.0A / 8.5Vdc-10Vdc, 1.7A / 10Vdc-12Vdc, 1.5A
Adapter 2	Jiangsu Chenyang Electron Co., LTD.	CK18W02U	I/P: 100-240 Vac, 50-60 Hz, 500 mA O/P: 5 Vdc, 3.0A / 9Vdc, 2.0A / 12Vdc, 1.5A
Battery	Apack Technology Co., LTD.	APP00307	3.8 Vdc, 3000 mAh
Earphone	Ganet Global LTD.	HF-AC04D-03 HF	1.2m non-shielded cable with core
USB Cable	Saibao (Jiangxi) Communication Industrial Co., LTD.	SRB-A001A	1.2m shielded cable with core

4. The above EUT information is declared by manufacturer and for more detailed features description, please refers to the manufacturer's specifications or user's manual.

3.2 Description of Test Modes

For 5180 ~ 5240 MHz

4 channels are provided for 802.11a, 802.11n (HT20):

Channel	Frequency (MHz)	Channel	Frequency (MHz)
36	5180	44	5220
40	5200	48	5240

2 channels are provided for 802.11n (HT40):

Channel	Frequency (MHz)	Channel	Frequency (MHz)
38	5190	46	5230

1 channel is provided for 802.11ac (VHT80):

Channel	Frequency (MHz)
42	5210

For 5260 ~ 5320 MHz

4 channels are provided for 802.11a, 802.11n (HT20):

Channel	Frequency (MHz)	Channel	Frequency (MHz)
52	5260	60	5300
56	5280	64	5320

2 channels are provided for 802.11n (HT40):

Channel	Frequency (MHz)	Channel	Frequency (MHz)
54	5270	62	5310

1 channel is provided for 802.11ac (VHT80):

Channel	Frequency (MHz)
58	5290

For 5500 ~ 5700 MHz

11 channels are provided for 802.11a, 802.11n (HT20):

Channel	Frequency (MHz)	Channel	Frequency (MHz)
100	5500	124	5620
104	5520	128	5640
108	5540	132	5660
112	5560	136	5680
116	5580	140	5700
120	5600		

5 channels are provided for 802.11n (HT40):

Channel	Frequency (MHz)	Channel	Frequency (MHz)
102	5510	126	5630
110	5550	134	5670
118	5590		

2 channels are provided for 802.11ac (VHT80):

Channel	Frequency (MHz)	Channel	Frequency (MHz)
106	5530	122	5610

For 5745 ~ 5825 MHz:

5 channels are provided for 802.11a, 802.11n (HT20):

Channel	Frequency (MHz)	Channel	Frequency (MHz)
149	5745	161	5805
153	5765	165	5825
157	5785		

2 channels are provided for 802.11n (HT40):

Channel	Frequency (MHz)	Channel	Frequency (MHz)
151	5755	159	5795

1 channel is provided for 802.11ac (VHT80):

Channel	Frequency (MHz)
155	5775

3.2.1 Test Mode Applicability and Tested Channel Detail

EUT Configure Mode	Applicable To				Description
	RE \geq 1G	RE<1G	PLC	APCM	
-	√	√	√	√	-

Where **RE \geq 1G**: Radiated Emission above 1 GHz **RE<1G**: Radiated Emission below 1 GHz
PLC: Power Line Conducted Emission **APCM**: Antenna Port Conducted Measurement

Note:

1. The EUT had been pre-tested on the positioned of each 3 axis. The worst case was found when positioned on **Z-plane**.

Radiated Emission Test (Above 1 GHz):

- Pre-Scan has been conducted to determine the worst-case mode from all possible combinations between available modulations, data rates and antenna ports (if EUT with antenna diversity architecture).
- Following channel(s) was (were) selected for the final test as listed below.

EUT Configure Mode	Frequency Band (MHz)	Mode	Available Channel	Tested Channel	Modulation Technology	Modulation Type	Data Rate (Mbps)
-	5180-5240	802.11a	36 to 48	36, 40, 48	OFDM	BPSK	6.0
-		802.11n (HT20)	36 to 48	36, 40, 48	OFDM	BPSK	6.5
-		802.11n (HT40)	38 to 46	38, 46	OFDM	BPSK	13.5
-		802.11ac (VHT80)	42	42	OFDM	BPSK	29.3
-	5260-5320	802.11a	52 to 64	52, 60, 64	OFDM	BPSK	6.0
-		802.11n (HT20)	52 to 64	52, 60, 64	OFDM	BPSK	6.5
-		802.11n (HT40)	54 to 62	54, 62	OFDM	BPSK	13.5
-		802.11ac (VHT80)	58	58	OFDM	BPSK	29.3
-	5500-5700	802.11a	100 to 140	100, 116, 140	OFDM	BPSK	6.0
-		802.11n (HT20)	100 to 140	100, 116, 140	OFDM	BPSK	6.5
-		802.11n (HT40)	102 to 134	102, 110, 134	OFDM	BPSK	13.5
-		802.11ac (VHT80)	106 to 122	106, 122	OFDM	BPSK	29.3
-	5745-5825	802.11a	149 to 165	149, 157, 165	OFDM	BPSK	6.0
-		802.11n (HT20)	149 to 165	149, 157, 165	OFDM	BPSK	6.5
-		802.11n (HT40)	151 to 159	151, 159	OFDM	BPSK	13.5
-		802.11ac (VHT80)	155	155	OFDM	BPSK	29.3

Radiated Emission Test (Below 1 GHz):

- Pre-Scan has been conducted to determine the worst-case mode from all possible combinations between available modulations, data rates and antenna ports (if EUT with antenna diversity architecture).
- Following channel(s) was (were) selected for the final test as listed below.

EUT Configure Mode	Frequency Band (MHz)	Mode	Available Channel	Tested Channel	Modulation Technology	Modulation Type	Data Rate (Mbps)
-	5260-5320	802.11a	52 to 64	100	OFDM	BPSK	6.0

Power Line Conducted Emission Test:

- Pre-Scan has been conducted to determine the worst-case mode from all possible combinations between available modulations, data rates and antenna ports (if EUT with antenna diversity architecture).
- Following channel(s) was (were) selected for the final test as listed below.

EUT Configure Mode	Frequency Band (MHz)	Mode	Available Channel	Tested Channel	Modulation Technology	Modulation Type	Data Rate (Mbps)
-	5260-5320	802.11a	52 to 64	100	OFDM	BPSK	6.0

Antenna Port Conducted Measurement:

- This item includes all test value of each mode, but only includes spectrum plot of worst value of each mode.
- Pre-Scan has been conducted to determine the worst-case mode from all possible combinations between available modulations, data rates and antenna ports (if EUT with antenna diversity architecture).
- Following channel(s) was (were) selected for the final test as listed below.

EUT Configure Mode	Frequency Band (MHz)	Mode	Available Channel	Tested Channel	Modulation Technology	Modulation Type	Data Rate (Mbps)
-	5180-5240	802.11a	36 to 48	36, 40, 48	OFDM	BPSK	6.0
-		802.11n (HT20)	36 to 48	36, 40, 48	OFDM	BPSK	6.5
-		802.11n (HT40)	38 to 46	38, 46	OFDM	BPSK	13.5
-		802.11ac (VHT80)	42	42	OFDM	BPSK	29.3
-	5260-5320	802.11a	52 to 64	52, 60, 64	OFDM	BPSK	6.0
-		802.11n (HT20)	52 to 64	52, 60, 64	OFDM	BPSK	6.5
-		802.11n (HT40)	54 to 62	54, 62	OFDM	BPSK	13.5
-		802.11ac (VHT80)	58	58	OFDM	BPSK	29.3
-	5500-5700	802.11a	100 to 140	100, 116, 140	OFDM	BPSK	6.0
-		802.11n (HT20)	100 to 140	100, 116, 140	OFDM	BPSK	6.5
-		802.11n (HT40)	102 to 134	102, 110, 134	OFDM	BPSK	13.5
-		802.11ac (VHT80)	106 to 122	106, 122	OFDM	BPSK	29.3
-	5745-5825	802.11a	149 to 165	149, 157, 165	OFDM	BPSK	6.0
-		802.11n (HT20)	149 to 165	149, 157, 165	OFDM	BPSK	6.5
-		802.11n (HT40)	151 to 159	151, 159	OFDM	BPSK	13.5
-		802.11ac (VHT80)	155	155	OFDM	BPSK	29.3

Test Condition:

Applicable To	Environmental Conditions	Input Power	Tested by
RE≥1G	25 deg. C, 65 % RH	120 Vac, 60 Hz	Tim Chen, Thomas Wei
RE<1G	25 deg. C, 65 % RH	120 Vac, 60 Hz	Thomas Wei
PLC	25 deg. C, 65 % RH	120 Vac, 60 Hz	Thomas Wei
APCM	25 deg. C, 65 % RH	3.8 Vdc	Gavin Wu

3.3 Duty Cycle of Test Signal

MODULATION TYPE: BPSK

802.11a: Duty cycle = $1.39/1.437 = 0.967$, Duty factor = $10 * \log(1/0.967) = 0.14$

802.11n (HT20): Duty cycle = $1.286/1.333 = 0.965$, Duty factor = $10 * \log(1/0.965) = 0.16$

802.11n (HT40): Duty cycle = $0.633/0.688 = 0.920$, Duty factor = $10 * \log(1/0.920) = 0.36$

802.11ac (VHT80): Duty cycle = $0.323/0.368 = 0.878$, Duty factor = $10 * \log(1/0.878) = 0.57$

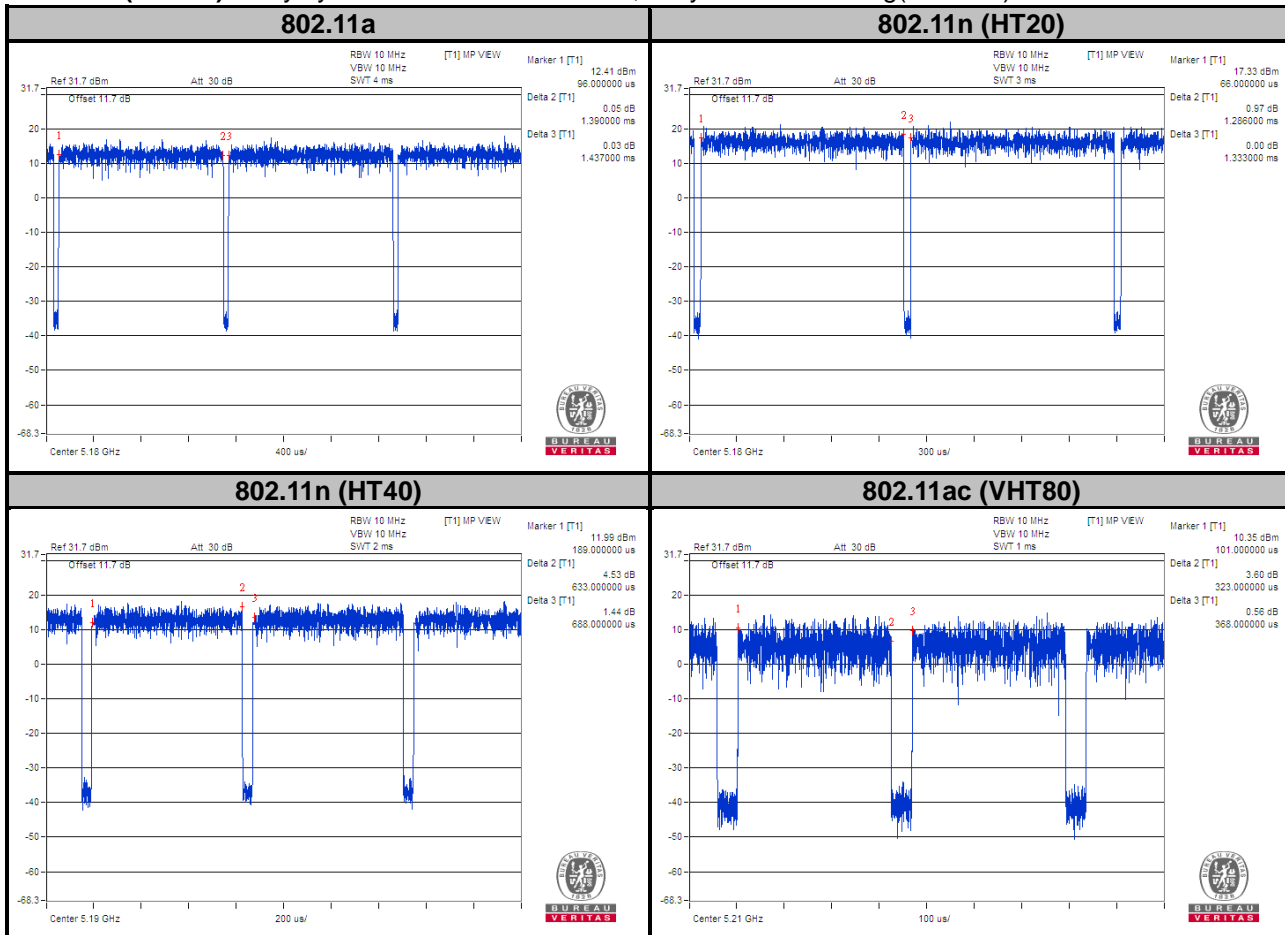

3.4 Description of Support Units

The EUT has been tested as an independent unit together with other necessary accessories or support units.

3.4.1 Configuration of System under Test

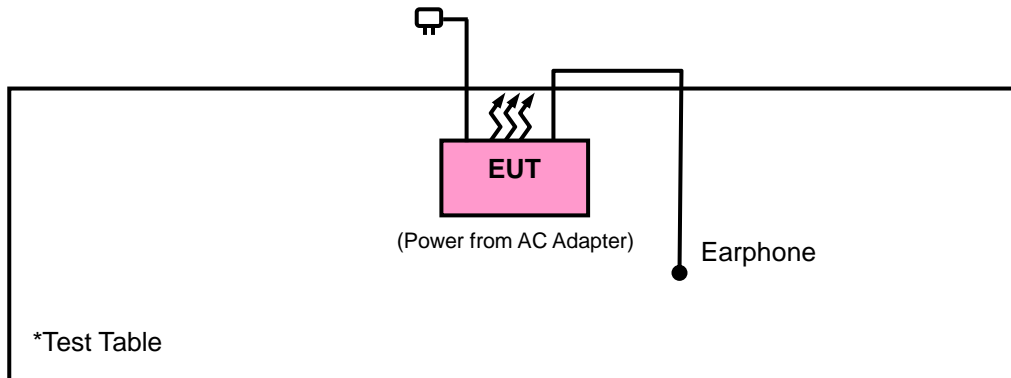

3.5 General Description of Applied Standards

The EUT is a RF Product. According to the specifications of the manufacturer, it must comply with the requirements of the following standards:

FCC Part 15, Subpart E (15.407)

KDB 789033 D02 General UNII Test Procedures New Rules v02r01

ANSI C63.10-2013

All test items have been performed and recorded as per the above standards.

4 Test Types and Results

4.1 Radiated Emission and Bandedge Measurement

4.1.1 Limits of Radiated Emission and Bandedge Measurement

Radiated emissions which fall in the restricted bands must comply with the radiated emission limits specified as below table.

Frequencies (MHz)	Field Strength (microvolts/meter)	Measurement Distance (meters)
0.009 ~ 0.490	2400/F (kHz)	300
0.490 ~ 1.705	24000/F (kHz)	30
1.705 ~ 30.0	30	30
30 ~ 88	100	3
88 ~ 216	150	3
216 ~ 960	200	3
Above 960	500	3

Note:

1. The lower limit shall apply at the transition frequencies.
2. Emission level (dBuV/m) = 20 log Emission level (uV/m).
3. For frequencies above 1000 MHz, the field strength limits are based on average detector, however, the peak field strength of any emission shall not exceed the maximum permitted average limits, specified above by more than 20 dB under any condition of modulation.

4.1.2 Limits of Unwanted Emission Out of the Restricted Bands

Applicable To		Limit	
789033 D02 General UNII Test Procedures New Rules v02r01		Field Strength at 3 m	
		PK: 74 (dBµV/m)	AV: 54 (dBµV/m)
Frequency Band	Applicable To	EIRP Limit	Equivalent Field Strength at 3 m
5150~5250 MHz	15.407(b)(1)	PK: -27 (dBm/MHz)	PK: 68.2 (dBµV/m)
5250~5350 MHz	15.407(b)(2)		
5470~5725 MHz	15.407(b)(3)		
5725~5850 MHz	<input checked="" type="checkbox"/> 15.407(b)(4)(i)	PK:-27 (dBm/MHz) ^{*1} PK:10 (dBm/MHz) ^{*2} PK:15.6 (dBm/MHz) ^{*3} PK:27 (dBm/MHz) ^{*4}	PK: 68.2 (dBµV/m) ^{*1} PK:105.2 (dBµV/m) ^{*2} PK: 110.8 (dBµV/m) ^{*3} PK:122.2 (dBµV/m) ^{*4}
	<input type="checkbox"/> 15.407(b)(4)(ii)	Emission limits in section 15.247(d)	

^{*1} beyond 75 MHz or more above of the band edge.

^{*2} below the band edge increasing linearly to 10 dBm/MHz at 25 MHz above.

^{*3} below the band edge increasing linearly to a level of 15.6 dBm/MHz at 5 MHz above.

^{*4} from 5 MHz above or below the band edge increasing linearly to a level of 27 dBm/MHz at the band edge.

Note:

The following formula is used to convert the equipment isotropic radiated power (eirp) to field strength:

$$E = \frac{1000000\sqrt{30P}}{3} \mu\text{V/m, where } P \text{ is the eirp (Watts).}$$

4.1.3 Test Instruments

Description & Manufacturer	Model No.	Serial No.	Date of Calibration	Due Date of Calibration
Test Receiver Agilent	N9038A	MY51210203	Mar. 18, 2019	Mar. 17, 2020
Spectrum Analyzer Agilent	N9010A	MY52220314	Dec. 13, 2018	Dec. 12, 2019
Spectrum Analyzer ROHDE & SCHWARZ	FSU43	101261	Apr. 15, 2019	Apr. 14, 2020
Broadband Horn Antenna SCHWARZBECK	BBHA 9170	148	Nov. 25, 2018	Nov. 24, 2019
HORN Antenna SCHWARZBECK	BBHA 9120D	9120D-969	Nov. 25, 2018	Nov. 24, 2019
BILOG Antenna SCHWARZBECK	VULB 9168	9168-472	Nov. 23, 2018	Nov. 22, 2019
Fixed Attenuator Mini-Circuits	MDCS18N-10	MDCS18N-10-01	Apr. 15, 2019	Apr. 14, 2020
Loop Antenna	HLA 6121	45745	Jul. 01, 2019	Jun. 30, 2020
Preamplifier EMCI	EMC001340	980201	Oct. 12, 2018	Oct. 11, 2019
Preamplifier EMCI	EMC 012645	980115	Oct. 12, 2018	Oct. 11, 2019
Preamplifier EMCI	EMC 184045	980116	Oct. 12, 2018	Oct. 11, 2019
Preamplifier EMCI	EMC 330H	980112	Oct. 12, 2018	Oct. 11, 2019
Power Meter Anritsu	ML2495A	1012010	Sep. 05, 2018	Sep. 04, 2019
			Sep. 04, 2019	Sep. 03, 2020
Power Sensor Anritsu	MA2411B	1315050	Sep. 04, 2018	Sep. 03, 2019
			Sep. 04, 2019	Sep. 03, 2020
RF Coaxial Cable HUBER+SUHNNER	EMC104-SM-SM-800 0&3000	140811+170717	Oct. 12, 2018	Oct. 11, 2019
RF Coaxial Cable HUBER+SUHNNER	SUCOFLEX 104	EMC104-SM-SM- 1000(140807)	Oct. 12, 2018	Oct. 11, 2019
RF Coaxial Cable WOKEN	8D-FB	Cable-Ch10-01	Oct. 12, 2018	Oct. 11, 2019
Boresight Antenna Fixture	FBA-01	FBA-SIP01	NA	NA
Software BV ADT	E3 6.120103	NA	NA	NA
Antenna Tower MF	MFA-440H	NA	NA	NA
Turn Table MF	MFT-201SS	NA	NA	NA
Antenna Tower & Turn Table Controller MF	MF-7802	NA	NA	NA
DC power supply Keysight	U8002A	MY56330015	NA	NA
Temperature & Humidity Chamber	GTH-120-40-CP-AR	MAA1205-006	Jul. 19, 2019	Jul. 18, 2020

Note: 1. The calibration interval of the above test instruments is 12 months and the calibrations are traceable to NML/ROC and NIST/USA.

2. The test was performed in HwaYa Chamber 10.

4.1.4 Test Procedures

For Radiated Emission below 30 MHz

- a. The EUT was placed on the top of a rotating table 0.8 meters above the ground at a 3 meter chamber room. The table was rotated 360 degrees to determine the position of the highest radiation.
- b. The EUT was set 3 meters away from the interference-receiving antenna, which was mounted on the top of a variable-height antenna tower.
- c. Both Parallel, perpendicular, and ground-parallel orientations of the antenna are set to make the measurement.
- d. For each suspected emission, the EUT was arranged to its worst case and the rotatable table was turned from 0 degrees to 360 degrees to find the maximum reading.
- e. The test-receiver system was set to Quasi-Peak Detect Function and Specified Bandwidth with Maximum Hold Mode.

Note:

1. The resolution bandwidth and video bandwidth of test receiver/spectrum analyzer is 9 kHz at frequency below 30 MHz.

For Radiated Emission above 30 MHz

- a. The EUT was placed on the top of a rotating table 0.8 meters (for 30 MHz ~ 1 GHz) / 1.5 meters (for above 1 GHz) above the ground at 3 meter chamber room for test. The table was rotated 360 degrees to determine the position of the highest radiation.
- b. The EUT was set 3 meters away from the interference-receiving antenna, which was mounted on the top of a variable-height antenna tower.
- c. The height of antenna is varied from one meter to four meters above the ground to determine the maximum value of the field strength. Both horizontal and vertical polarizations of the antenna are set to make the measurement.
- d. For each suspected emission, the EUT was arranged to its worst case and then the antenna was tuned to heights from 1 meter to 4 meters and the rotatable table was turned from 0 degrees to 360 degrees to find the maximum reading.
- e. The test-receiver system was set to quasi-peak detect function and specified bandwidth with maximum hold mode when the test frequency is below 1 GHz.
- f. The test-receiver system was set to peak and average detected function and specified bandwidth with maximum hold mode when the test frequency is above 1 GHz. If the peak reading value also meets average limit, measurement with the average detector is unnecessary.

Note:

1. The resolution bandwidth and video bandwidth of test receiver/spectrum analyzer is 120 kHz for Quasi-peak detection (QP) or Peak detection (PK) at frequency below 1 GHz.
2. The resolution bandwidth of test receiver/spectrum analyzer is 1 MHz and the video bandwidth is 3 MHz for Peak detection (PK) at frequency above 1 GHz.
3. The resolution bandwidth of test receiver/spectrum analyzer is 1 MHz and the video bandwidth is $\geq 1/T$ (Duty cycle < 98 %) or 10 Hz (Duty cycle \geq 98 %) for Average detection (AV) at frequency above 1 GHz.
(11a: RBW = 1 MHz, VBW = 1 kHz ; 11n (HT20): RBW = 1 MHz, VBW = 1 kHz ;
11n (HT40): RBW = 1 MHz, VBW = 3 kHz ; 11ac (VHT80): RBW = 1 MHz, VBW = 10 kHz)
4. All modes of operation were investigated and the worst-case emissions are reported.

4.1.5 Deviation from Test Standard

No deviation.

4.1.6 Test Setup

<Radiated Emission below 30 MHz>

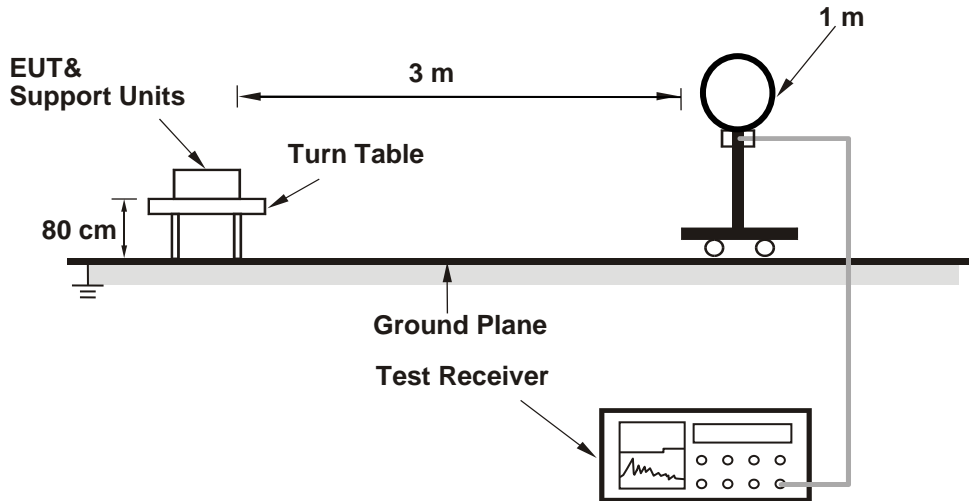

<Radiated Emission 30 MHz to 1 GHz>

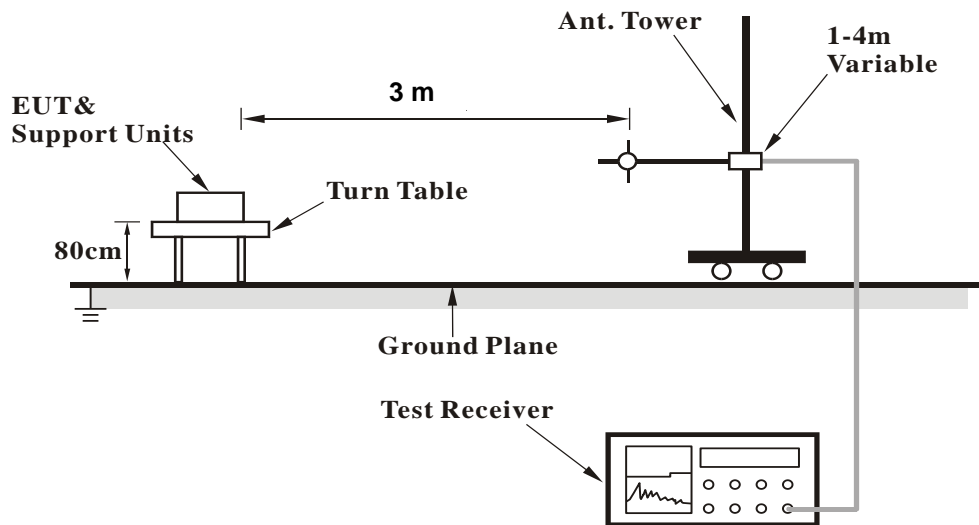

<Radiated Emission above 1 GHz>

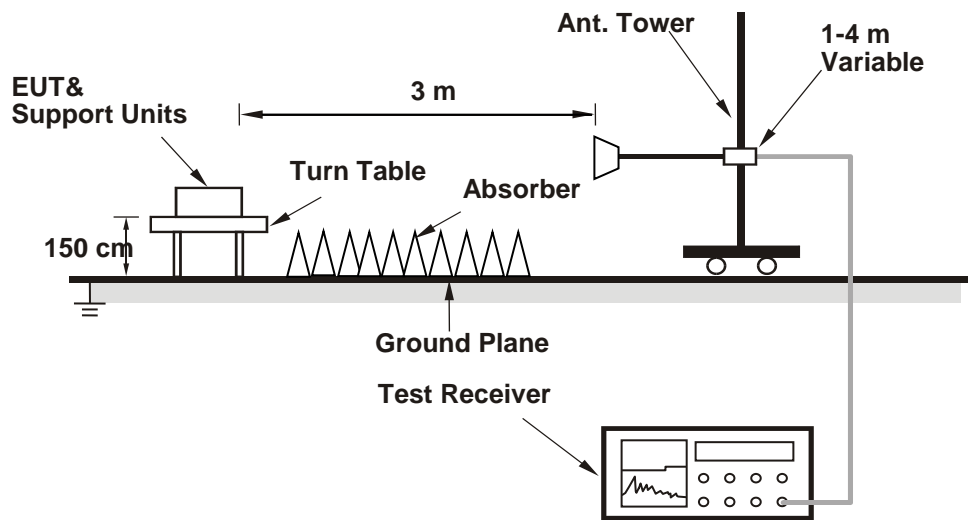

For the actual test configuration, please refer to the attached file (Test Setup Photo).

4.1.7 EUT Operating Conditions

Set the EUT under transmission condition continuously at specific channel frequency.

4.1.8 Test Results
Above 1 GHz Data :
802.11a

EUT Test Condition		Measurement Detail	
Channel	Channel 36	Frequency Range	1 GHz ~ 40 GHz
Input Power	120 Vac, 60 Hz	Detector Function	Peak (PK) Average (AV)
Environmental Conditions	25 deg. C, 65 % RH	Tested By	Tim Chen

Antenna Polarity & Test Distance: Horizontal at 3 m								
Frequency (MHz)	Emission Level (dBuV/m)	Read Level (dBuV)	Factor (dB/m)	Limit (dBuV/m)	Margin (dB)	Antenna Height (cm)	Table Angle (Degree)	Remark
5150	48.24	46.71	1.53	54	-5.76	181	243	Average
5150	61.29	59.76	1.53	74	-12.71	181	243	Peak
5180	94.84	93.31	1.53			181	243	Average
5180	100.37	98.84	1.53			181	243	Peak
*10360	53.75	56.59	-2.84	68.2	-14.45	158	221	Peak
Antenna Polarity & Test Distance: Vertical at 3 m								
Frequency (MHz)	Emission Level (dBuV/m)	Read Level (dBuV)	Factor (dB/m)	Limit (dBuV/m)	Margin (dB)	Antenna Height (cm)	Table Angle (Degree)	Remark
5150	49.47	47.94	1.53	54	-4.53	167	214	Average
5150	62.61	61.08	1.53	74	-11.39	167	214	Peak
5180	96.46	94.93	1.53			167	214	Average
5180	102.26	100.73	1.53			167	214	Peak
*10360	53.74	56.58	-2.84	68.2	-14.46	102	117	Peak

Remarks:

- Emission Level = Read Level + Factor
Margin value = Emission level – Limit value
- 5180 MHz: Fundamental Frequency
- *: Out of Restricted Band
- The emission levels of other frequencies were very low against the limit

EUT Test Condition		Measurement Detail	
Channel	Channel 40	Frequency Range	1 GHz ~ 40 GHz
Input Power	120 Vac, 60 Hz	Detector Function	Peak (PK) Average (AV)
Environmental Conditions	25 deg. C, 65 % RH	Tested By	Tim Chen

Antenna Polarity & Test Distance: Horizontal at 3 m								
Frequency (MHz)	Emission Level (dBuV/m)	Read Level (dBuV)	Factor (dB/m)	Limit (dBuV/m)	Margin (dB)	Antenna Height (cm)	Table Angle (Degree)	Remark
5150	42.49	40.96	1.53	54	-11.51	179	245	Average
5150	52.76	51.23	1.53	74	-21.24	179	245	Peak
5200	93.25	91.72	1.53			179	245	Average
5200	100.44	98.91	1.53			179	245	Peak
5350	40.94	39.48	1.46	54	-13.06	179	245	Average
5350	51.13	49.67	1.46	74	-22.87	179	245	Peak
*10400	54.71	57.6	-2.89	68.2	-13.49	173	206	Peak
Antenna Polarity & Test Distance: Vertical at 3 m								
Frequency (MHz)	Emission Level (dBuV/m)	Read Level (dBuV)	Factor (dB/m)	Limit (dBuV/m)	Margin (dB)	Antenna Height (cm)	Table Angle (Degree)	Remark
5150	42.35	40.82	1.53	54	-11.65	166	213	Average
5150	52.86	51.33	1.53	74	-21.14	166	213	Peak
5200	93.95	92.42	1.53			166	213	Average
5200	100.65	99.12	1.53			166	213	Peak
5350	41.09	39.63	1.46	54	-12.91	166	213	Average
5350	51.36	49.9	1.46	74	-22.64	166	213	Peak
*10400	54.81	57.7	-2.89	68.2	-13.39	108	167	Peak

Remarks:

- Emission Level = Read Level + Factor
Margin value = Emission level – Limit value
- 5200 MHz: Fundamental Frequency
- *: Out of Restricted Band
- The emission levels of other frequencies were very low against the limit

EUT Test Condition		Measurement Detail	
Channel	Channel 48	Frequency Range	1 GHz ~ 40 GHz
Input Power	120 Vac, 60 Hz	Detector Function	Peak (PK) Average (AV)
Environmental Conditions	25 deg. C, 65 % RH	Tested By	Tim Chen

Antenna Polarity & Test Distance: Horizontal at 3 m								
Frequency (MHz)	Emission Level (dBuV/m)	Read Level (dBuV)	Factor (dB/m)	Limit (dBuV/m)	Margin (dB)	Antenna Height (cm)	Table Angle (Degree)	Remark
5150	41.23	39.7	1.53	54	-12.77	174	238	Average
5150	50.69	49.16	1.53	74	-23.31	174	238	Peak
5240	93.86	92.48	1.38			174	238	Average
5240	100.9	99.52	1.38			174	238	Peak
5350	41.04	39.58	1.46	54	-12.96	174	238	Average
5350	50.68	49.22	1.46	74	-23.32	174	238	Peak
*10480	54.87	57.6	-2.73	68.2	-13.33	203	334	Peak

Antenna Polarity & Test Distance: Vertical at 3 m								
Frequency (MHz)	Emission Level (dBuV/m)	Read Level (dBuV)	Factor (dB/m)	Limit (dBuV/m)	Margin (dB)	Antenna Height (cm)	Table Angle (Degree)	Remark
5150	41.11	39.58	1.53	54	-12.89	192	221	Average
5150	50.28	48.75	1.53	74	-23.72	192	221	Peak
5240	94.83	93.45	1.38			192	221	Average
5240	101.35	99.97	1.38			192	221	Peak
5350	41.1	39.64	1.46	54	-12.9	192	221	Average
5350	50.68	49.22	1.46	74	-23.32	192	221	Peak
*10480	54.8	57.53	-2.73	68.2	-13.4	106	59	Peak

Remarks:

- Emission Level = Read Level + Factor
Margin value = Emission level – Limit value
- 5240 MHz: Fundamental Frequency
- *: Out of Restricted Band
- The emission levels of other frequencies were very low against the limit

EUT Test Condition		Measurement Detail	
Channel	Channel 52	Frequency Range	1 GHz ~ 40 GHz
Input Power	120 Vac, 60 Hz	Detector Function	Peak (PK) Average (AV)
Environmental Conditions	25 deg. C, 65 % RH	Tested By	Thomas Wei

Antenna Polarity & Test Distance: Horizontal at 3 m

Frequency (MHz)	Emission Level (dBuV/m)	Read Level (dBuV)	Factor (dB/m)	Limit (dBuV/m)	Margin (dB)	Antenna Height (cm)	Table Angle (Degree)	Remark
5137.7	40.71	39.22	1.49	54	-13.29	161	327	Average
5137.7	50.11	48.62	1.49	74	-23.89	161	327	Peak
5260	94.14	92.83	1.31			161	327	Average
5260	100.28	98.97	1.31			161	327	Peak
5445.7	40.84	39.02	1.82	54	-13.16	161	327	Average
5445.7	51.16	49.34	1.82	74	-22.84	161	327	Peak
*10520	55.62	58.34	-2.72	68.2	-12.58	142	235	Peak

Antenna Polarity & Test Distance: Vertical at 3 m

Frequency (MHz)	Emission Level (dBuV/m)	Read Level (dBuV)	Factor (dB/m)	Limit (dBuV/m)	Margin (dB)	Antenna Height (cm)	Table Angle (Degree)	Remark
5129.06	41.02	39.53	1.49	54	-12.98	171	232	Average
5129.06	51.53	50.04	1.49	74	-22.47	171	232	Peak
5260	97.18	95.87	1.31			171	232	Average
5260	103.37	102.06	1.31			171	232	Peak
5350.11	41.14	39.68	1.46	54	-12.86	171	232	Average
5350.11	50.93	49.47	1.46	74	-23.07	171	232	Peak
*10520	54.88	57.6	-2.72	68.2	-13.32	179	202	Peak
15780	51.42	53	-1.58	54	-2.58	181	205	Average
15780	60.92	62.5	-1.58	74	-13.08	181	205	Peak

Remarks:

- Emission Level = Read Level + Factor
Margin value = Emission level – Limit value
- 5260 MHz: Fundamental Frequency
- *: Out of Restricted Band
- The emission levels of other frequencies were very low against the limit

EUT Test Condition		Measurement Detail	
Channel	Channel 60	Frequency Range	1 GHz ~ 40 GHz
Input Power	120 Vac, 60 Hz	Detector Function	Peak (PK) Average (AV)
Environmental Conditions	25 deg. C, 65 % RH	Tested By	Thomas Wei

Antenna Polarity & Test Distance: Horizontal at 3 m								
Frequency (MHz)	Emission Level (dBuV/m)	Read Level (dBuV)	Factor (dB/m)	Limit (dBuV/m)	Margin (dB)	Antenna Height (cm)	Table Angle (Degree)	Remark
5300	93.33	92.02	1.31			183	14	Average
5300	99.59	98.28	1.31			183	14	Peak
5350.11	42.33	40.87	1.46	54	-11.67	183	14	Average
5350.11	53.17	51.71	1.46	74	-20.83	183	14	Peak
10600	45.86	48.77	-2.91	54	-8.14	172	239	Average
10600	54.79	57.7	-2.91	74	-19.21	172	239	Peak
Antenna Polarity & Test Distance: Vertical at 3 m								
Frequency (MHz)	Emission Level (dBuV/m)	Read Level (dBuV)	Factor (dB/m)	Limit (dBuV/m)	Margin (dB)	Antenna Height (cm)	Table Angle (Degree)	Remark
5300	96.75	95.44	1.31			170	233	Average
5300	102.71	101.4	1.31			170	233	Peak
5350.22	43.79	42.33	1.46	54	-10.21	170	233	Average
5350.22	52.88	51.42	1.46	74	-21.12	170	233	Peak
10600	44.65	47.56	-2.91	54	-9.35	185	204	Average
10600	55.05	57.96	-2.91	74	-18.95	185	204	Peak
15900	51.93	54.2	-2.27	54	-2.07	183	200	Average
15900	61.23	63.5	-2.27	74	-12.77	183	200	Peak

Remarks:

- Emission Level = Read Level + Factor
Margin value = Emission level – Limit value
- 5300 MHz: Fundamental Frequency
- *: Out of Restricted Band
- The emission levels of other frequencies were very low against the limit

EUT Test Condition		Measurement Detail	
Channel	Channel 64	Frequency Range	1 GHz ~ 40 GHz
Input Power	120 Vac, 60 Hz	Detector Function	Peak (PK) Average (AV)
Environmental Conditions	25 deg. C, 65 % RH	Tested By	Thomas Wei

Antenna Polarity & Test Distance: Horizontal at 3 m								
Frequency (MHz)	Emission Level (dBuV/m)	Read Level (dBuV)	Factor (dB/m)	Limit (dBuV/m)	Margin (dB)	Antenna Height (cm)	Table Angle (Degree)	Remark
5320	92.23	90.87	1.36			179	244	Average
5320	98.07	96.71	1.36			179	244	Peak
5350.11	48.72	47.26	1.46	54	-5.28	179	244	Average
5350.11	60.37	58.91	1.46	74	-13.63	179	244	Peak
10640	45.76	48.65	-2.89	54	-8.24	152	138	Average
10640	54.58	57.47	-2.89	74	-19.42	152	138	Peak
Antenna Polarity & Test Distance: Vertical at 3 m								
Frequency (MHz)	Emission Level (dBuV/m)	Read Level (dBuV)	Factor (dB/m)	Limit (dBuV/m)	Margin (dB)	Antenna Height (cm)	Table Angle (Degree)	Remark
5320	96.66	95.3	1.36			170	230	Average
5320	102.84	101.48	1.36			170	230	Peak
5350.11	51.98	50.52	1.46	54	-2.02	170	230	Average
5350.11	63.08	61.62	1.46	74	-10.92	170	230	Peak
15960	52.73	55.09	-2.36	54	-1.27	164	201	Average
15960	60.81	63.17	-2.36	74	-13.19	164	201	Peak

Remarks:

1. Emission Level = Read Level + Factor
Margin value = Emission level – Limit value
2. 5320 MHz: Fundamental Frequency
3. *: Out of Restricted Band
4. The emission levels of other frequencies were very low against the limit

EUT Test Condition		Measurement Detail	
Channel	Channel 100	Frequency Range	1 GHz ~ 40 GHz
Input Power	120 Vac, 60 Hz	Detector Function	Peak (PK) Average (AV)
Environmental Conditions	25 deg. C, 65 % RH	Tested By	Thomas Wei

Antenna Polarity & Test Distance: Horizontal at 3 m								
Frequency (MHz)	Emission Level (dBuV/m)	Read Level (dBuV)	Factor (dB/m)	Limit (dBuV/m)	Margin (dB)	Antenna Height (cm)	Table Angle (Degree)	Remark
5459.92	46.61	44.74	1.87	54	-7.39	157	54	Average
5459.92	55.85	53.98	1.87	74	-18.15	157	54	Peak
*5470	67.13	65.27	1.86	68.2	-1.07	157	54	Peak
5500	95.49	93.62	1.87			157	54	Average
5500	101.94	100.07	1.87			157	54	Peak
*5725	50.2	48.44	1.76	68.2	-18	157	54	Peak
11000	44.81	47.12	-2.31	54	-9.19	187	264	Average
11000	55.08	57.39	-2.31	74	-18.92	187	264	Peak
*16500	66.66	67.52	-0.86	68.2	-1.54	174	155	Peak
Antenna Polarity & Test Distance: Vertical at 3 m								
Frequency (MHz)	Emission Level (dBuV/m)	Read Level (dBuV)	Factor (dB/m)	Limit (dBuV/m)	Margin (dB)	Antenna Height (cm)	Table Angle (Degree)	Remark
5458.8	46.92	45.05	1.87	54	-7.08	178	230	Average
5458.8	57.65	55.78	1.87	74	-16.35	178	230	Peak
*5470	63.05	61.19	1.86	68.2	-5.15	178	230	Peak
5500	96.48	94.61	1.87			178	230	Average
5500	103.41	101.54	1.87			178	230	Peak
*5725	50.16	48.4	1.76	68.2	-18.04	178	230	Peak
11000	45.01	47.32	-2.31	54	-8.99	116	29	Average
11000	55.32	57.63	-2.31	74	-18.68	116	29	Peak
*16500	68.01	68.87	-0.86	68.2	-0.19	166	202	Peak

Remarks:

- Emission Level = Read Level + Factor
Margin value = Emission level – Limit value
- 5500 MHz: Fundamental Frequency
- *: Out of Restricted Band
- The emission levels of other frequencies were very low against the limit

EUT Test Condition		Measurement Detail	
Channel	Channel 116	Frequency Range	1 GHz ~ 40 GHz
Input Power	120 Vac, 60 Hz	Detector Function	Peak (PK) Average (AV)
Environmental Conditions	25 deg. C, 65 % RH	Tested By	Thomas Wei

Antenna Polarity & Test Distance: Horizontal at 3 m								
Frequency (MHz)	Emission Level (dBuV/m)	Read Level (dBuV)	Factor (dB/m)	Limit (dBuV/m)	Margin (dB)	Antenna Height (cm)	Table Angle (Degree)	Remark
5446.64	41.08	39.26	1.82	54	-12.92	178	44	Average
5446.64	50.98	49.16	1.82	74	-23.02	178	44	Peak
*5470	50.46	48.6	1.86	68.2	-17.74	178	44	Peak
5580	95.08	93.26	1.82			178	44	Average
5580	101.43	99.61	1.82			178	44	Peak
*5725	50.68	48.92	1.76	68.2	-17.52	178	44	Peak
11160	44.45	47	-2.55	54	-9.55	193	205	Average
11160	55.51	58.06	-2.55	74	-18.49	193	205	Peak
*16740	64.01	63.67	0.34	68.2	-4.19	175	156	Peak
Antenna Polarity & Test Distance: Vertical at 3 m								
Frequency (MHz)	Emission Level (dBuV/m)	Read Level (dBuV)	Factor (dB/m)	Limit (dBuV/m)	Margin (dB)	Antenna Height (cm)	Table Angle (Degree)	Remark
5448.08	40.95	39.13	1.82	54	-13.05	179	237	Average
5448.08	51.16	49.34	1.82	74	-22.84	179	237	Peak
*5470	50.68	48.82	1.86	68.2	-17.52	179	237	Peak
5580	96.41	94.59	1.82			179	237	Average
5580	103.14	101.32	1.82			179	237	Peak
*5725	50.33	48.57	1.76	68.2	-17.87	179	237	Peak
11160	44.18	46.73	-2.55	54	-9.82	116	308	Average
11160	54.94	57.49	-2.55	74	-19.06	116	308	Peak
*16740	66.4	66.06	0.34	68.2	-1.8	178	199	Peak

Remarks:

- Emission Level = Read Level + Factor
Margin value = Emission level – Limit value
- 5580 MHz: Fundamental Frequency
- *: Out of Restricted Band
- The emission levels of other frequencies were very low against the limit

EUT Test Condition		Measurement Detail	
Channel	Channel 140	Frequency Range	1 GHz ~ 40 GHz
Input Power	120 Vac, 60 Hz	Detector Function	Peak (PK) Average (AV)
Environmental Conditions	25 deg. C, 65 % RH	Tested By	Thomas Wei

Antenna Polarity & Test Distance: Horizontal at 3 m								
Frequency (MHz)	Emission Level (dBuV/m)	Read Level (dBuV)	Factor (dB/m)	Limit (dBuV/m)	Margin (dB)	Antenna Height (cm)	Table Angle (Degree)	Remark
5448.08	40.81	38.99	1.82	54	-13.19	178	246	Average
5448.08	50.57	48.75	1.82	74	-23.43	178	246	Peak
*5470	50.38	48.52	1.86	68.2	-17.82	178	246	Peak
5700	94.81	93.22	1.59			178	246	Average
5700	100.7	99.11	1.59			178	246	Peak
*5725	64.99	63.23	1.76	68.2	-3.21	178	246	Peak
11400	47.54	49.77	-2.23	54	-6.46	175	122	Average
11400	56.1	58.33	-2.23	74	-17.9	175	122	Peak

Antenna Polarity & Test Distance: Vertical at 3 m								
Frequency (MHz)	Emission Level (dBuV/m)	Read Level (dBuV)	Factor (dB/m)	Limit (dBuV/m)	Margin (dB)	Antenna Height (cm)	Table Angle (Degree)	Remark
5446.48	40.78	38.96	1.82	54	-13.22	180	241	Average
5446.48	49.76	47.94	1.82	74	-24.24	180	241	Peak
*5470	50.35	48.49	1.86	68.2	-17.85	180	241	Peak
5700	95.64	94.05	1.59			180	241	Average
5700	102.28	100.69	1.59			180	241	Peak
*5725	67.85	66.09	1.76	68.2	-0.35	180	241	Peak
11400	47.26	49.49	-2.23	54	-6.74	142	206	Average
11400	56.44	58.67	-2.23	74	-17.56	142	206	Peak

Remarks:

- Emission Level = Read Level + Factor
Margin value = Emission level – Limit value
- 5700 MHz: Fundamental Frequency
- *: Out of Restricted Band
- The emission levels of other frequencies were very low against the limit

EUT Test Condition		Measurement Detail	
Channel	Channel 149	Frequency Range	1 GHz ~ 40 GHz
Input Power	120 Vac, 60 Hz	Detector Function	Peak (PK) Average (AV)
Environmental Conditions	25 deg. C, 65 % RH	Tested By	Tim Chen

<Spurious Emission>

Antenna Polarity & Test Distance: Horizontal at 3 m								
Frequency (MHz)	Emission Level (dBuV/m)	Read Level (dBuV)	Factor (dB/m)	Limit (dBuV/m)	Margin (dB)	Antenna Height (cm)	Table Angle (Degree)	Remark
5745	97.93	96.11	1.82			167	8	Average
5745	105.39	103.57	1.82			167	8	Peak
11490	45.49	47.69	-2.2	54	-8.51	201	307	Average
11490	55.56	57.76	-2.2	74	-18.44	201	307	Peak

Antenna Polarity & Test Distance: Vertical at 3 m								
Frequency (MHz)	Emission Level (dBuV/m)	Read Level (dBuV)	Factor (dB/m)	Limit (dBuV/m)	Margin (dB)	Antenna Height (cm)	Table Angle (Degree)	Remark
5745	97.79	95.97	1.82			171	240	Average
5745	105.19	103.37	1.82			171	240	Peak
11490	45.11	47.31	-2.2	54	-8.89	106	211	Average
11490	55.24	57.44	-2.2	74	-18.76	106	211	Peak

<Out of Band Emission (OOBE)>

Antenna Polarity & Test Distance: Horizontal at 3 m								
Frequency (MHz)	Emission Level (dBuV/m)	Read Level (dBuV)	Factor (dB/m)	Limit (dBuV/m)	Margin (dB)	Antenna Height (cm)	Table Angle (Degree)	Remark
5641.675	50.77	48.89	1.88	68.2	-17.43	167	8	Peak
5658.3	50.34	48.49	1.85	74.36	-24.02	167	8	Peak
5923.35	51.06	48.76	2.3	69.42	-18.36	167	8	Peak
5976.55	51.52	49.19	2.33	68.2	-16.68	167	8	Peak

Antenna Polarity & Test Distance: Vertical at 3 m								
Frequency (MHz)	Emission Level (dBuV/m)	Read Level (dBuV)	Factor (dB/m)	Limit (dBuV/m)	Margin (dB)	Antenna Height (cm)	Table Angle (Degree)	Remark
5647.375	50.77	48.89	1.88	68.2	-17.43	171	240	Peak
5657.825	50.99	49.14	1.85	74.01	-23.02	171	240	Peak
5923.35	50.33	48.03	2.3	69.42	-19.09	171	240	Peak
5988.425	51.35	49.02	2.33	68.2	-16.85	171	240	Peak

Remarks:

- Emission Level = Read Level + Factor
Margin value = Emission level – Limit value
- 5745 MHz: Fundamental Frequency
- *: Out of Restricted Band
- The emission levels of other frequencies were very low against the limit

EUT Test Condition		Measurement Detail	
Channel	Channel 157	Frequency Range	1 GHz ~ 40 GHz
Input Power	120 Vac, 60 Hz	Detector Function	Peak (PK) Average (AV)
Environmental Conditions	25 deg. C, 65 % RH	Tested By	Tim Chen

<Spurious Emission>

Antenna Polarity & Test Distance: Horizontal at 3 m								
Frequency (MHz)	Emission Level (dBuV/m)	Read Level (dBuV)	Factor (dB/m)	Limit (dBuV/m)	Margin (dB)	Antenna Height (cm)	Table Angle (Degree)	Remark
5785	96.74	94.82	1.92			159	4	Average
5785	103.62	101.7	1.92			159	4	Peak
11570	45.04	47.24	-2.2	54	-8.96	189	234	Average
11570	55.18	57.38	-2.2	74	-18.82	189	234	Peak
Antenna Polarity & Test Distance: Vertical at 3 m								
Frequency (MHz)	Emission Level (dBuV/m)	Read Level (dBuV)	Factor (dB/m)	Limit (dBuV/m)	Margin (dB)	Antenna Height (cm)	Table Angle (Degree)	Remark
5785	97.25	95.33	1.92			184	241	Average
5785	104.39	102.47	1.92			184	241	Peak
11570	44.37	46.57	-2.2	54	-9.63	107	326	Average
11570	54.84	57.04	-2.2	74	-19.16	107	326	Peak

<Out of Band Emission (OOBE)>

Antenna Polarity & Test Distance: Horizontal at 3 m								
Frequency (MHz)	Emission Level (dBuV/m)	Read Level (dBuV)	Factor (dB/m)	Limit (dBuV/m)	Margin (dB)	Antenna Height (cm)	Table Angle (Degree)	Remark
5589.9	50.87	49	1.87	68.2	-17.33	159	4	Peak
5651.65	49.84	47.93	1.91	69.43	-19.59	159	4	Peak
5921.45	50.11	47.8	2.31	70.82	-20.71	159	4	Peak
5930	52.04	49.74	2.3	68.2	-16.16	159	4	Peak
Antenna Polarity & Test Distance: Vertical at 3 m								
Frequency (MHz)	Emission Level (dBuV/m)	Read Level (dBuV)	Factor (dB/m)	Limit (dBuV/m)	Margin (dB)	Antenna Height (cm)	Table Angle (Degree)	Remark
5639.775	51.5	49.62	1.88	68.2	-16.7	184	241	Peak
5658.3	49.72	47.87	1.85	74.36	-24.64	184	241	Peak
5919.55	50.4	48.09	2.31	72.22	-21.82	184	241	Peak
5945.2	51.58	49.29	2.29	68.2	-16.62	184	241	Peak

Remarks:

- Emission Level = Read Level + Factor
Margin value = Emission level – Limit value
- 5785 MHz: Fundamental Frequency
- *: Out of Restricted Band
- The emission levels of other frequencies were very low against the limit

EUT Test Condition		Measurement Detail	
Channel	Channel 165	Frequency Range	1 GHz ~ 40 GHz
Input Power	120 Vac, 60 Hz	Detector Function	Peak (PK) Average (AV)
Environmental Conditions	25 deg. C, 65 % RH	Tested By	Tim Chen

<Spurious Emission>

Antenna Polarity & Test Distance: Horizontal at 3 m								
Frequency (MHz)	Emission Level (dBuV/m)	Read Level (dBuV)	Factor (dB/m)	Limit (dBuV/m)	Margin (dB)	Antenna Height (cm)	Table Angle (Degree)	Remark
5825	97.06	94.98	2.08			400	8	Average
5825	104.14	102.06	2.08			400	8	Peak
11650	40.84	43.23	-2.39	54	-13.16	123	337	Average
11650	51.97	54.36	-2.39	74	-22.03	123	337	Peak
Antenna Polarity & Test Distance: Vertical at 3 m								
Frequency (MHz)	Emission Level (dBuV/m)	Read Level (dBuV)	Factor (dB/m)	Limit (dBuV/m)	Margin (dB)	Antenna Height (cm)	Table Angle (Degree)	Remark
5825	96	93.92	2.08			214	252	Average
5825	102.59	100.51	2.08			214	252	Peak
11650	41.29	43.68	-2.39	54	-12.71	142	262	Average
11650	52.27	54.66	-2.39	74	-21.73	142	262	Peak

<Out of Band Emission (OOBE)>

Antenna Polarity & Test Distance: Horizontal at 3 m								
Frequency (MHz)	Emission Level (dBuV/m)	Read Level (dBuV)	Factor (dB/m)	Limit (dBuV/m)	Margin (dB)	Antenna Height (cm)	Table Angle (Degree)	Remark
5608.9	49.82	47.95	1.87	68.2	-18.38	400	8	Peak
5652.125	49.38	47.47	1.91	69.78	-20.4	400	8	Peak
5923.825	51.01	48.71	2.3	69.07	-18.06	400	8	Peak
5993.175	51.38	49.02	2.36	68.2	-16.82	400	8	Peak
Antenna Polarity & Test Distance: Vertical at 3 m								
Frequency (MHz)	Emission Level (dBuV/m)	Read Level (dBuV)	Factor (dB/m)	Limit (dBuV/m)	Margin (dB)	Antenna Height (cm)	Table Angle (Degree)	Remark
5611.275	50.19	48.32	1.87	68.2	-18.01	214	252	Peak
5656.4	50.38	48.53	1.85	72.95	-22.57	214	252	Peak
5917.175	50.3	47.99	2.31	73.97	-23.67	214	252	Peak
5988.425	50.95	48.62	2.33	68.2	-17.25	214	252	Peak

Remarks:

- Emission Level = Read Level + Factor
Margin value = Emission level – Limit value
- 5825 MHz: Fundamental Frequency
- *: Out of Restricted Band
- The emission levels of other frequencies were very low against the limit

802.11n (HT20)

EUT Test Condition		Measurement Detail	
Channel	Channel 36	Frequency Range	1 GHz ~ 40 GHz
Input Power	120 Vac, 60 Hz	Detector Function	Peak (PK) Average (AV)
Environmental Conditions	25 deg. C, 65 % RH	Tested By	Tim Chen

Antenna Polarity & Test Distance: Horizontal at 3 m

Frequency (MHz)	Emission Level (dBuV/m)	Read Level (dBuV)	Factor (dB/m)	Limit (dBuV/m)	Margin (dB)	Antenna Height (cm)	Table Angle (Degree)	Remark
5150	51.22	49.69	1.53	54	-2.78	192	344	Average
5150	62.67	61.14	1.53	74	-11.33	192	344	Peak
5180	99.88	98.35	1.53			192	344	Average
5180	105.65	104.12	1.53			192	344	Peak
*10360	54.46	57.3	-2.84	68.2	-13.74	137	102	Peak

Antenna Polarity & Test Distance: Vertical at 3 m

Frequency (MHz)	Emission Level (dBuV/m)	Read Level (dBuV)	Factor (dB/m)	Limit (dBuV/m)	Margin (dB)	Antenna Height (cm)	Table Angle (Degree)	Remark
5150	48.98	62.37	-13.39	54	-5.02	185	106	Average
5150	62.44	75.83	-13.39	74	-11.56	185	106	Peak
5180	95.78	94.25	1.53			185	106	Average
5180	103.64	102.11	1.53			185	106	Peak
*10360	53.06	55.9	-2.84	68.2	-15.14	166	352	Peak

Remarks:

- Emission Level = Read Level + Factor
Margin value = Emission level – Limit value
- 5180 MHz: Fundamental Frequency
- *: Out of Restricted Band
- The emission levels of other frequencies were very low against the limit

EUT Test Condition		Measurement Detail	
Channel	Channel 40	Frequency Range	1 GHz ~ 40 GHz
Input Power	120 Vac, 60 Hz	Detector Function	Peak (PK) Average (AV)
Environmental Conditions	25 deg. C, 65 % RH	Tested By	Tim Chen

Antenna Polarity & Test Distance: Horizontal at 3 m								
Frequency (MHz)	Emission Level (dBuV/m)	Read Level (dBuV)	Factor (dB/m)	Limit (dBuV/m)	Margin (dB)	Antenna Height (cm)	Table Angle (Degree)	Remark
5150	41.3	39.77	1.53	54	-12.7	179	244	Average
5150	50.83	49.3	1.53	74	-23.17	179	244	Peak
5200	87.77	86.24	1.53			179	244	Average
5200	94.33	92.8	1.53			179	244	Peak
5350	41.02	39.56	1.46	54	-12.98	179	244	Average
5350	51.32	49.86	1.46	74	-22.68	179	244	Peak
*10400	54.13	57.02	-2.89	68.2	-14.07	195	206	Peak
Antenna Polarity & Test Distance: Vertical at 3 m								
Frequency (MHz)	Emission Level (dBuV/m)	Read Level (dBuV)	Factor (dB/m)	Limit (dBuV/m)	Margin (dB)	Antenna Height (cm)	Table Angle (Degree)	Remark
5150	41.22	39.69	1.53	54	-12.78	188	220	Average
5150	50.63	49.1	1.53	74	-23.37	188	220	Peak
5200	88.91	87.38	1.53			188	220	Average
5200	95.72	94.19	1.53			188	220	Peak
5350	41.02	39.56	1.46	54	-12.98	188	220	Average
5350	50.94	49.48	1.46	74	-23.06	188	220	Peak
*10400	53.86	56.75	-2.89	68.2	-14.34	103	99	Peak

Remarks:

- Emission Level = Read Level + Factor
Margin value = Emission level – Limit value
- 5200 MHz: Fundamental Frequency
- *: Out of Restricted Band
- The emission levels of other frequencies were very low against the limit

EUT Test Condition		Measurement Detail	
Channel	Channel 48	Frequency Range	1 GHz ~ 40 GHz
Input Power	120 Vac, 60 Hz	Detector Function	Peak (PK) Average (AV)
Environmental Conditions	25 deg. C, 65 % RH	Tested By	Tim Chen

Antenna Polarity & Test Distance: Horizontal at 3 m

Frequency (MHz)	Emission Level (dBuV/m)	Read Level (dBuV)	Factor (dB/m)	Limit (dBuV/m)	Margin (dB)	Antenna Height (cm)	Table Angle (Degree)	Remark
5150	41.12	39.59	1.53	54	-12.88	175	245	Average
5150	50.2	48.67	1.53	74	-23.8	175	245	Peak
5240	87.42	86.04	1.38			175	245	Average
5240	94	92.62	1.38			175	245	Peak
5350	41.11	39.65	1.46	54	-12.89	175	245	Average
5350	51.17	49.71	1.46	74	-22.83	175	245	Peak
*10480	55.63	58.36	-2.73	68.2	-12.57	213	316	Peak

Antenna Polarity & Test Distance: Vertical at 3 m

Frequency (MHz)	Emission Level (dBuV/m)	Read Level (dBuV)	Factor (dB/m)	Limit (dBuV/m)	Margin (dB)	Antenna Height (cm)	Table Angle (Degree)	Remark
5150	41.04	39.51	1.53	54	-12.96	175	222	Average
5150	50.67	49.14	1.53	74	-23.33	175	222	Peak
5240	88.99	87.61	1.38			175	222	Average
5240	95.61	94.23	1.38			175	222	Peak
5350	41.04	39.58	1.46	54	-12.96	175	222	Average
5350	50.65	49.19	1.46	74	-23.35	175	222	Peak
*10480	55.81	58.54	-2.73	68.2	-12.39	136	277	Peak

Remarks:

- Emission Level = Read Level + Factor
Margin value = Emission level – Limit value
- 5240 MHz: Fundamental Frequency
- *: Out of Restricted Band
- The emission levels of other frequencies were very low against the limit

EUT Test Condition		Measurement Detail	
Channel	Channel 52	Frequency Range	1 GHz ~ 40 GHz
Input Power	120 Vac, 60 Hz	Detector Function	Peak (PK) Average (AV)
Environmental Conditions	25 deg. C, 65 % RH	Tested By	Thomas Wei

Antenna Polarity & Test Distance: Horizontal at 3 m								
Frequency (MHz)	Emission Level (dBuV/m)	Read Level (dBuV)	Factor (dB/m)	Limit (dBuV/m)	Margin (dB)	Antenna Height (cm)	Table Angle (Degree)	Remark
5143.1	40.78	39.23	1.55	54	-13.22	168	15	Average
5143.1	51.18	49.63	1.55	74	-22.82	168	15	Peak
5260	86.91	85.6	1.31			168	15	Average
5260	93.56	92.25	1.31			168	15	Peak
5452.19	40.92	39.05	1.87	54	-13.08	168	15	Average
5452.19	49.94	48.07	1.87	74	-24.06	168	15	Peak
*10520	55.16	57.88	-2.72	68.2	-13.04	139	216	Peak
Antenna Polarity & Test Distance: Vertical at 3 m								
Frequency (MHz)	Emission Level (dBuV/m)	Read Level (dBuV)	Factor (dB/m)	Limit (dBuV/m)	Margin (dB)	Antenna Height (cm)	Table Angle (Degree)	Remark
5118.44	40.91	39.46	1.45	54	-13.09	170	237	Average
5118.44	50.21	48.76	1.45	74	-23.79	170	237	Peak
5260	89.96	88.65	1.31			170	237	Average
5260	96.55	95.24	1.31			170	237	Peak
5379.04	40.98	39.38	1.6	54	-13.02	170	237	Average
5379.04	50.08	48.48	1.6	74	-23.92	170	237	Peak
*10520	55.43	58.15	-2.72	68.2	-12.77	149	206	Peak

Remarks:

- Emission Level = Read Level + Factor
Margin value = Emission level – Limit value
- 5260 MHz: Fundamental Frequency
- *: Out of Restricted Band
- The emission levels of other frequencies were very low against the limit

EUT Test Condition		Measurement Detail	
Channel	Channel 60	Frequency Range	1 GHz ~ 40 GHz
Input Power	120 Vac, 60 Hz	Detector Function	Peak (PK) Average (AV)
Environmental Conditions	25 deg. C, 65 % RH	Tested By	Thomas Wei

Antenna Polarity & Test Distance: Horizontal at 3 m								
Frequency (MHz)	Emission Level (dBuV/m)	Read Level (dBuV)	Factor (dB/m)	Limit (dBuV/m)	Margin (dB)	Antenna Height (cm)	Table Angle (Degree)	Remark
5300	87.94	86.63	1.31			162	15	Average
5300	93.4	92.09	1.31			162	15	Peak
5447.35	40.82	39	1.82	54	-13.18	162	15	Average
5447.35	50.49	48.67	1.82	74	-23.51	162	15	Peak
10600	46.12	49.03	-2.91	54	-7.88	184	215	Average
10600	55.48	58.39	-2.91	74	-18.52	184	215	Peak
Antenna Polarity & Test Distance: Vertical at 3 m								
Frequency (MHz)	Emission Level (dBuV/m)	Read Level (dBuV)	Factor (dB/m)	Limit (dBuV/m)	Margin (dB)	Antenna Height (cm)	Table Angle (Degree)	Remark
5300	90.28	88.97	1.31			180	232	Average
5300	96.38	95.07	1.31			180	232	Peak
5376.84	41	39.47	1.53	54	-13	180	232	Average
5376.84	51.14	49.61	1.53	74	-22.86	180	232	Peak
10600	45.9	48.81	-2.91	54	-8.1	154	233	Average
10600	54.87	57.78	-2.91	74	-19.13	154	233	Peak

Remarks:

- Emission Level = Read Level + Factor
Margin value = Emission level – Limit value
- 5300 MHz: Fundamental Frequency
- *: Out of Restricted Band
- The emission levels of other frequencies were very low against the limit

EUT Test Condition		Measurement Detail	
Channel	Channel 64	Frequency Range	1 GHz ~ 40 GHz
Input Power	120 Vac, 60 Hz	Detector Function	Peak (PK) Average (AV)
Environmental Conditions	25 deg. C, 65 % RH	Tested By	Thomas Wei

Antenna Polarity & Test Distance: Horizontal at 3 m								
Frequency (MHz)	Emission Level (dBuV/m)	Read Level (dBuV)	Factor (dB/m)	Limit (dBuV/m)	Margin (dB)	Antenna Height (cm)	Table Angle (Degree)	Remark
5320	86.99	85.63	1.36			158	15	Average
5320	93.42	92.06	1.36			158	15	Peak
5427	41.06	39.3	1.76	54	-12.94	158	15	Average
5427	50.73	48.97	1.76	74	-23.27	158	15	Peak
10640	45.9	48.79	-2.89	54	-8.1	194	251	Average
10640	54.85	57.74	-2.89	74	-19.15	194	251	Peak
Antenna Polarity & Test Distance: Vertical at 3 m								
Frequency (MHz)	Emission Level (dBuV/m)	Read Level (dBuV)	Factor (dB/m)	Limit (dBuV/m)	Margin (dB)	Antenna Height (cm)	Table Angle (Degree)	Remark
5320	89.78	88.42	1.36			170	234	Average
5320	96	94.64	1.36			170	234	Peak
5350.11	41.26	39.8	1.46	54	-12.74	170	234	Average
5350.11	50.39	48.93	1.46	74	-23.61	170	234	Peak
10640	45.78	48.67	-2.89	54	-8.22	182	251	Average
10640	54.93	57.82	-2.89	74	-19.07	182	251	Peak

Remarks:

- Emission Level = Read Level + Factor
Margin value = Emission level – Limit value
- 5320 MHz: Fundamental Frequency
- *: Out of Restricted Band
- The emission levels of other frequencies were very low against the limit

EUT Test Condition		Measurement Detail	
Channel	Channel 100	Frequency Range	1 GHz ~ 40 GHz
Input Power	120 Vac, 60 Hz	Detector Function	Peak (PK) Average (AV)
Environmental Conditions	25 deg. C, 65 % RH	Tested By	Thomas Wei

Antenna Polarity & Test Distance: Horizontal at 3 m								
Frequency (MHz)	Emission Level (dBuV/m)	Read Level (dBuV)	Factor (dB/m)	Limit (dBuV/m)	Margin (dB)	Antenna Height (cm)	Table Angle (Degree)	Remark
5443.6	41.2	39.42	1.78	54	-12.8	182	44	Average
5443.6	51.05	49.27	1.78	74	-22.95	182	44	Peak
*5470	50.83	48.97	1.86	68.2	-17.37	182	44	Peak
5500	89.03	87.16	1.87			182	44	Average
5500	95.37	93.5	1.87			182	44	Peak
*5725	50.23	48.47	1.76	68.2	-17.97	182	44	Peak
11000	46.53	48.84	-2.31	54	-7.47	168	215	Average
11000	54.8	57.11	-2.31	74	-19.2	168	215	Peak

Antenna Polarity & Test Distance: Vertical at 3 m								
Frequency (MHz)	Emission Level (dBuV/m)	Read Level (dBuV)	Factor (dB/m)	Limit (dBuV/m)	Margin (dB)	Antenna Height (cm)	Table Angle (Degree)	Remark
5455.12	41.48	39.61	1.87	54	-12.52	172	234	Average
5455.12	50.7	48.83	1.87	74	-23.3	172	234	Peak
*5470	53	51.14	1.86	68.2	-15.2	172	234	Peak
5500	90.08	88.21	1.87			172	234	Average
5500	96.64	94.77	1.87			172	234	Peak
*5725	49.72	47.96	1.76	68.2	-18.48	172	234	Peak
11000	46.3	48.61	-2.31	54	-7.7	156	132	Average
11000	55.71	58.02	-2.31	74	-18.29	156	132	Peak

Remarks:

- Emission Level = Read Level + Factor
Margin value = Emission level – Limit value
- 5500 MHz: Fundamental Frequency
- *: Out of Restricted Band
- The emission levels of other frequencies were very low against the limit

EUT Test Condition		Measurement Detail	
Channel	Channel 116	Frequency Range	1 GHz ~ 40 GHz
Input Power	120 Vac, 60 Hz	Detector Function	Peak (PK) Average (AV)
Environmental Conditions	25 deg. C, 65 % RH	Tested By	Thomas Wei

Antenna Polarity & Test Distance: Horizontal at 3 m								
Frequency (MHz)	Emission Level (dBuV/m)	Read Level (dBuV)	Factor (dB/m)	Limit (dBuV/m)	Margin (dB)	Antenna Height (cm)	Table Angle (Degree)	Remark
5457.36	40.95	39.08	1.87	54	-13.05	181	44	Average
5457.36	50.44	48.57	1.87	74	-23.56	181	44	Peak
*5470	51.46	49.6	1.86	68.2	-16.74	181	44	Peak
5580	88.52	86.7	1.82			181	44	Average
5580	94.94	93.12	1.82			181	44	Peak
*5725	50.08	48.32	1.76	68.2	-18.12	181	44	Peak
11160	46.5	49.05	-2.55	54	-7.5	172	43	Average
11160	56.6	59.15	-2.55	74	-17.4	172	43	Peak

Antenna Polarity & Test Distance: Vertical at 3 m								
Frequency (MHz)	Emission Level (dBuV/m)	Read Level (dBuV)	Factor (dB/m)	Limit (dBuV/m)	Margin (dB)	Antenna Height (cm)	Table Angle (Degree)	Remark
5444.24	40.99	39.21	1.78	54	-13.01	180	235	Average
5444.24	50.64	48.86	1.78	74	-23.36	180	235	Peak
*5470	49.56	47.7	1.86	68.2	-18.64	180	235	Peak
5580	90.48	88.66	1.82			180	235	Average
5580	97.25	95.43	1.82			180	235	Peak
*5725	50.47	48.71	1.76	68.2	-17.73	180	235	Peak
11160	46.16	48.71	-2.55	54	-7.84	162	195	Average
11160	55.67	58.22	-2.55	74	-18.33	162	195	Peak

Remarks:

- Emission Level = Read Level + Factor
Margin value = Emission level – Limit value
- 5580 MHz: Fundamental Frequency
- *: Out of Restricted Band
- The emission levels of other frequencies were very low against the limit

EUT Test Condition		Measurement Detail	
Channel	Channel 140	Frequency Range	1 GHz ~ 40 GHz
Input Power	120 Vac, 60 Hz	Detector Function	Peak (PK) Average (AV)
Environmental Conditions	25 deg. C, 65 % RH	Tested By	Thomas Wei

Antenna Polarity & Test Distance: Horizontal at 3 m								
Frequency (MHz)	Emission Level (dBuV/m)	Read Level (dBuV)	Factor (dB/m)	Limit (dBuV/m)	Margin (dB)	Antenna Height (cm)	Table Angle (Degree)	Remark
5401.52	40.83	39.16	1.67	54	-13.17	223	62	Average
5401.52	50.34	48.67	1.67	74	-23.66	223	62	Peak
*5470	49.32	47.46	1.86	68.2	-18.88	223	62	Peak
5700	89.11	87.52	1.59			223	62	Average
5700	95.5	93.91	1.59			223	62	Peak
*5725	56.38	54.62	1.76	68.2	-11.82	223	62	Peak
11400	47.28	49.51	-2.23	54	-6.72	171	193	Average
11400	56.01	58.24	-2.23	74	-17.99	171	193	Peak

Antenna Polarity & Test Distance: Vertical at 3 m								
Frequency (MHz)	Emission Level (dBuV/m)	Read Level (dBuV)	Factor (dB/m)	Limit (dBuV/m)	Margin (dB)	Antenna Height (cm)	Table Angle (Degree)	Remark
5459.44	40.84	38.97	1.87	54	-13.16	178	239	Average
5459.44	50.49	48.62	1.87	74	-23.51	178	239	Peak
*5470	49.89	48.03	1.86	68.2	-18.31	178	239	Peak
5700	90.66	89.07	1.59			178	239	Average
5700	97.28	95.69	1.59			178	239	Peak
*5725	57.46	55.7	1.76	68.2	-10.74	178	239	Peak
11400	47.02	49.25	-2.23	54	-6.98	152	188	Average
11400	55.95	58.18	-2.23	74	-18.05	152	188	Peak

Remarks:

- Emission Level = Read Level + Factor
Margin value = Emission level – Limit value
- 5700 MHz: Fundamental Frequency
- *: Out of Restricted Band
- The emission levels of other frequencies were very low against the limit

EUT Test Condition		Measurement Detail	
Channel	Channel 149	Frequency Range	1 GHz ~ 40 GHz
Input Power	120 Vac, 60 Hz	Detector Function	Peak (PK) Average (AV)
Environmental Conditions	25 deg. C, 65 % RH	Tested By	Tim Chen

<Spurious Emission>

Antenna Polarity & Test Distance: Horizontal at 3 m								
Frequency (MHz)	Emission Level (dBuV/m)	Read Level (dBuV)	Factor (dB/m)	Limit (dBuV/m)	Margin (dB)	Antenna Height (cm)	Table Angle (Degree)	Remark
5745	88.11	86.29	1.82			171	249	Average
5745	95.02	93.2	1.82			171	249	Peak
11490	41.91	44.11	-2.2	54	-12.09	116	334	Average
11490	52.36	54.56	-2.2	74	-21.64	116	334	Peak
Antenna Polarity & Test Distance: Vertical at 3 m								
Frequency (MHz)	Emission Level (dBuV/m)	Read Level (dBuV)	Factor (dB/m)	Limit (dBuV/m)	Margin (dB)	Antenna Height (cm)	Table Angle (Degree)	Remark
5745	89.38	87.56	1.82			194	243	Average
5745	95.86	94.04	1.82			194	243	Peak
11490	43.57	45.77	-2.2	54	-10.43	193	127	Average
11490	54.42	56.62	-2.2	74	-19.58	193	127	Peak

<Out of Band Emission (OOBE)>

Antenna Polarity & Test Distance: Horizontal at 3 m								
Frequency (MHz)	Emission Level (dBuV/m)	Read Level (dBuV)	Factor (dB/m)	Limit (dBuV/m)	Margin (dB)	Antenna Height (cm)	Table Angle (Degree)	Remark
5609.375	50.5	48.63	1.87	68.2	-17.7	171	249	Peak
5653.55	49.55	47.64	1.91	70.84	-21.29	171	249	Peak
5920.5	49.49	47.18	2.31	71.52	-22.03	171	249	Peak
5935.7	51.23	48.93	2.3	68.2	-16.97	171	249	Peak
Antenna Polarity & Test Distance: Vertical at 3 m								
Frequency (MHz)	Emission Level (dBuV/m)	Read Level (dBuV)	Factor (dB/m)	Limit (dBuV/m)	Margin (dB)	Antenna Height (cm)	Table Angle (Degree)	Remark
5632.175	50.74	48.9	1.84	68.2	-17.46	194	243	Peak
5659.25	49.67	47.82	1.85	75.07	-25.4	194	243	Peak
5917.65	49.63	47.32	2.31	73.62	-23.99	194	243	Peak
6021.2	51.04	48.64	2.4	68.2	-17.16	194	243	Peak

Remarks:

- Emission Level = Read Level + Factor
Margin value = Emission level – Limit value
- 5745 MHz: Fundamental Frequency
- *: Out of Restricted Band
- The emission levels of other frequencies were very low against the limit

EUT Test Condition		Measurement Detail	
Channel	Channel 157	Frequency Range	1 GHz ~ 40 GHz
Input Power	120 Vac, 60 Hz	Detector Function	Peak (PK) Average (AV)
Environmental Conditions	25 deg. C, 65 % RH	Tested By	Tim Chen

<Spurious Emission>

Antenna Polarity & Test Distance: Horizontal at 3 m								
Frequency (MHz)	Emission Level (dBuV/m)	Read Level (dBuV)	Factor (dB/m)	Limit (dBuV/m)	Margin (dB)	Antenna Height (cm)	Table Angle (Degree)	Remark
5785	88.63	86.71	1.92			391	14	Average
5785	95.42	93.5	1.92			391	14	Peak
11570	42.47	44.67	-2.2	54	-11.53	143	226	Average
11570	52.88	55.08	-2.2	74	-21.12	143	226	Peak
Antenna Polarity & Test Distance: Vertical at 3 m								
Frequency (MHz)	Emission Level (dBuV/m)	Read Level (dBuV)	Factor (dB/m)	Limit (dBuV/m)	Margin (dB)	Antenna Height (cm)	Table Angle (Degree)	Remark
5785	89.24	87.32	1.92			193	244	Average
5785	95.87	93.95	1.92			193	244	Peak
11570	41.05	43.25	-2.2	54	-12.95	178	103	Average
11570	51.07	53.27	-2.2	74	-22.93	178	103	Peak

<Out of Band Emission (OOBE)>

Antenna Polarity & Test Distance: Horizontal at 3 m								
Frequency (MHz)	Emission Level (dBuV/m)	Read Level (dBuV)	Factor (dB/m)	Limit (dBuV/m)	Margin (dB)	Antenna Height (cm)	Table Angle (Degree)	Remark
5569.95	50.6	48.74	1.86	68.2	-17.6	391	14	Peak
5652.6	51.47	49.56	1.91	70.13	-18.66	391	14	Peak
5919.55	50.32	48.01	2.31	72.22	-21.9	391	14	Peak
5952.8	51.22	48.93	2.29	68.2	-16.98	391	14	Peak
Antenna Polarity & Test Distance: Vertical at 3 m								
Frequency (MHz)	Emission Level (dBuV/m)	Read Level (dBuV)	Factor (dB/m)	Limit (dBuV/m)	Margin (dB)	Antenna Height (cm)	Table Angle (Degree)	Remark
5618.4	50.87	48.97	1.9	68.2	-17.33	193	244	Peak
5655.925	49.64	47.79	1.85	72.6	-22.96	193	244	Peak
5915.275	49.67	47.36	2.31	75.37	-25.7	193	244	Peak
5989.85	51.34	48.98	2.36	68.2	-16.86	193	244	Peak

Remarks:

- Emission Level = Read Level + Factor
Margin value = Emission level – Limit value
- 5785 MHz: Fundamental Frequency
- *: Out of Restricted Band
- The emission levels of other frequencies were very low against the limit

EUT Test Condition		Measurement Detail	
Channel	Channel 165	Frequency Range	1 GHz ~ 40 GHz
Input Power	120 Vac, 60 Hz	Detector Function	Peak (PK) Average (AV)
Environmental Conditions	25 deg. C, 65 % RH	Tested By	Tim Chen

<Spurious Emission>

Antenna Polarity & Test Distance: Horizontal at 3 m								
Frequency (MHz)	Emission Level (dBuV/m)	Read Level (dBuV)	Factor (dB/m)	Limit (dBuV/m)	Margin (dB)	Antenna Height (cm)	Table Angle (Degree)	Remark
5825	89.55	87.47	2.08			400	14	Average
5825	96.19	94.11	2.08			400	14	Peak
11650	40.88	43.27	-2.39	54	-13.12	114	201	Average
11650	51.04	53.43	-2.39	74	-22.96	114	201	Peak
Antenna Polarity & Test Distance: Vertical at 3 m								
Frequency (MHz)	Emission Level (dBuV/m)	Read Level (dBuV)	Factor (dB/m)	Limit (dBuV/m)	Margin (dB)	Antenna Height (cm)	Table Angle (Degree)	Remark
5825	89.42	87.34	2.08			183	243	Average
5825	96.18	94.1	2.08			183	243	Peak
11650	40.38	42.77	-2.39	54	-13.62	183	269	Average
11650	51.2	53.59	-2.39	74	-22.8	183	269	Peak

<Out of Band Emission (OOBE)>

Antenna Polarity & Test Distance: Horizontal at 3 m								
Frequency (MHz)	Emission Level (dBuV/m)	Read Level (dBuV)	Factor (dB/m)	Limit (dBuV/m)	Margin (dB)	Antenna Height (cm)	Table Angle (Degree)	Remark
5644.525	50.65	48.77	1.88	68.2	-17.55	400	14	Peak
5660.2	48.66	46.81	1.85	75.77	-27.11	400	14	Peak
5915.75	50.12	47.81	2.31	75.02	-24.9	400	14	Peak
6019.3	51.64	49.24	2.4	68.2	-16.56	400	14	Peak
Antenna Polarity & Test Distance: Vertical at 3 m								
Frequency (MHz)	Emission Level (dBuV/m)	Read Level (dBuV)	Factor (dB/m)	Limit (dBuV/m)	Margin (dB)	Antenna Height (cm)	Table Angle (Degree)	Remark
5596.55	50.76	48.89	1.87	68.2	-17.44	183	243	Peak
5654.975	50.14	48.29	1.85	71.9	-21.76	183	243	Peak
5919.075	50.01	47.7	2.31	72.57	-22.56	183	243	Peak
6020.25	50.82	48.42	2.4	68.2	-17.38	183	243	Peak

Remarks:

- Emission Level = Read Level + Factor
Margin value = Emission level – Limit value
- 5825 MHz: Fundamental Frequency
- *: Out of Restricted Band
- The emission levels of other frequencies were very low against the limit

802.11n (HT40)

EUT Test Condition		Measurement Detail	
Channel	Channel 38	Frequency Range	1 GHz ~ 40 GHz
Input Power	120 Vac, 60 Hz	Detector Function	Peak (PK) Average (AV)
Environmental Conditions	25 deg. C, 65 % RH	Tested By	Thomas Wei

Antenna Polarity & Test Distance: Horizontal at 3 m

Frequency (MHz)	Emission Level (dBuV/m)	Read Level (dBuV)	Factor (dB/m)	Limit (dBuV/m)	Margin (dB)	Antenna Height (cm)	Table Angle (Degree)	Remark
5150	41.64	40.11	1.53	54	-12.36	192	242	Average
5150	51.17	49.64	1.53	74	-22.83	192	242	Peak
5190	84.65	83.12	1.53			192	242	Average
5190	90.61	89.08	1.53			192	242	Peak
5350	41.24	39.78	1.46	54	-12.76	192	242	Average
5350	50.74	49.28	1.46	74	-23.26	192	242	Peak
*10380	55.74	58.61	-2.87	68.2	-12.46	191	112	Peak

Antenna Polarity & Test Distance: Vertical at 3 m

Frequency (MHz)	Emission Level (dBuV/m)	Read Level (dBuV)	Factor (dB/m)	Limit (dBuV/m)	Margin (dB)	Antenna Height (cm)	Table Angle (Degree)	Remark
5150	41.98	40.45	1.53	54	-12.02	166	229	Average
5150	51.79	50.26	1.53	74	-22.21	166	229	Peak
5190	87.13	85.6	1.53			166	229	Average
5190	93.25	91.72	1.53			166	229	Peak
5350	41.36	39.9	1.46	54	-12.64	166	229	Average
5350	50.09	48.63	1.46	74	-23.91	166	229	Peak
*10380	55.03	57.9	-2.87	68.2	-13.17	136	208	Peak

Remarks:

- Emission Level = Read Level + Factor
Margin value = Emission level – Limit value
- 5190 MHz: Fundamental Frequency
- *: Out of Restricted Band
- The emission levels of other frequencies were very low against the limit

EUT Test Condition		Measurement Detail	
Channel	Channel 46	Frequency Range	1 GHz ~ 40 GHz
Input Power	120 Vac, 60 Hz	Detector Function	Peak (PK) Average (AV)
Environmental Conditions	25 deg. C, 65 % RH	Tested By	Tim Chen

Antenna Polarity & Test Distance: Horizontal at 3 m								
Frequency (MHz)	Emission Level (dBuV/m)	Read Level (dBuV)	Factor (dB/m)	Limit (dBuV/m)	Margin (dB)	Antenna Height (cm)	Table Angle (Degree)	Remark
5150	41.59	40.06	1.53	54	-12.41	169	245	Average
5150	50.92	49.39	1.53	74	-23.08	169	245	Peak
5230	84.87	83.49	1.38			169	245	Average
5230	91.63	90.25	1.38			169	245	Peak
5350	41.5	40.04	1.46	54	-12.5	169	245	Average
5350	50.63	49.17	1.46	74	-23.37	169	245	Peak
*10460	55.34	58.13	-2.79	68.2	-12.86	201	134	Peak
Antenna Polarity & Test Distance: Vertical at 3 m								
Frequency (MHz)	Emission Level (dBuV/m)	Read Level (dBuV)	Factor (dB/m)	Limit (dBuV/m)	Margin (dB)	Antenna Height (cm)	Table Angle (Degree)	Remark
5150	41.43	39.9	1.53	54	-12.57	174	217	Average
5150	50.77	49.24	1.53	74	-23.23	174	217	Peak
5230	86.37	84.99	1.38			174	217	Average
5230	93.36	91.98	1.38			174	217	Peak
5350	41.34	39.88	1.46	54	-12.66	174	217	Average
5350	50.36	48.9	1.46	74	-23.64	174	217	Peak
*10460	55.32	58.11	-2.79	68.2	-12.88	107	318	Peak

Remarks:

- Emission Level = Read Level + Factor
Margin value = Emission level – Limit value
- 5230 MHz: Fundamental Frequency
- *: Out of Restricted Band
- The emission levels of other frequencies were very low against the limit

EUT Test Condition		Measurement Detail	
Channel	Channel 54	Frequency Range	1 GHz ~ 40 GHz
Input Power	120 Vac, 60 Hz	Detector Function	Peak (PK) Average (AV)
Environmental Conditions	25 deg. C, 65 % RH	Tested By	Thomas Wei

Antenna Polarity & Test Distance: Horizontal at 3 m								
Frequency (MHz)	Emission Level (dBuV/m)	Read Level (dBuV)	Factor (dB/m)	Limit (dBuV/m)	Margin (dB)	Antenna Height (cm)	Table Angle (Degree)	Remark
5136.98	41.12	39.63	1.49	54	-12.88	154	16	Average
5136.98	50.1	48.61	1.49	74	-23.9	154	16	Peak
5270	84.58	83.27	1.31			154	16	Average
5270	90.97	89.66	1.31			154	16	Peak
5425.57	41.1	39.34	1.76	54	-12.9	154	16	Average
5425.57	51.03	49.27	1.76	74	-22.97	154	16	Peak
*10540	54.8	57.57	-2.77	68.2	-13.4	167	100	Peak

Antenna Polarity & Test Distance: Vertical at 3 m								
Frequency (MHz)	Emission Level (dBuV/m)	Read Level (dBuV)	Factor (dB/m)	Limit (dBuV/m)	Margin (dB)	Antenna Height (cm)	Table Angle (Degree)	Remark
5123.84	41.19	39.7	1.49	54	-12.81	165	233	Average
5123.84	51.08	49.59	1.49	74	-22.92	165	233	Peak
5270	87.61	86.3	1.31			165	233	Average
5270	93.91	92.6	1.31			165	233	Peak
5380.58	41.31	39.71	1.6	54	-12.69	165	233	Average
5380.58	52.98	51.38	1.6	74	-21.02	165	233	Peak
*10540	55.27	58.04	-2.77	68.2	-12.93	154	76	Peak

Remarks:

- Emission Level = Read Level + Factor
Margin value = Emission level – Limit value
- 5270 MHz: Fundamental Frequency
- *: Out of Restricted Band
- The emission levels of other frequencies were very low against the limit

EUT Test Condition		Measurement Detail	
Channel	Channel 62	Frequency Range	1 GHz ~ 40 GHz
Input Power	120 Vac, 60 Hz	Detector Function	Peak (PK) Average (AV)
Environmental Conditions	25 deg. C, 65 % RH	Tested By	Thomas Wei

Antenna Polarity & Test Distance: Horizontal at 3 m								
Frequency (MHz)	Emission Level (dBuV/m)	Read Level (dBuV)	Factor (dB/m)	Limit (dBuV/m)	Margin (dB)	Antenna Height (cm)	Table Angle (Degree)	Remark
5144	41.09	39.56	1.53	54	-12.91	179	242	Average
5144	50.32	48.79	1.53	74	-23.68	179	242	Peak
5310	85.32	83.96	1.36			179	242	Average
5310	91.48	90.12	1.36			179	242	Peak
5351.76	42.45	40.99	1.46	54	-11.55	179	242	Average
5351.76	53.58	52.12	1.46	74	-20.42	179	242	Peak
10620	45.97	48.86	-2.89	54	-8.03	185	136	Average
10620	54.96	57.85	-2.89	74	-19.04	185	136	Peak

Antenna Polarity & Test Distance: Vertical at 3 m								
Frequency (MHz)	Emission Level (dBuV/m)	Read Level (dBuV)	Factor (dB/m)	Limit (dBuV/m)	Margin (dB)	Antenna Height (cm)	Table Angle (Degree)	Remark
5142.2	41.24	39.69	1.55	54	-12.76	167	230	Average
5142.2	50.29	48.74	1.55	74	-23.71	167	230	Peak
5310	87.39	86.03	1.36			167	230	Average
5310	93.52	92.16	1.36			167	230	Peak
5351.21	43.6	42.14	1.46	54	-10.4	167	230	Average
5351.21	55.7	54.24	1.46	74	-18.3	167	230	Peak
10620	46.4	49.29	-2.89	54	-7.6	138	287	Average
10620	55.62	58.51	-2.89	74	-18.38	138	287	Peak

Remarks:

- Emission Level = Read Level + Factor
Margin value = Emission level – Limit value
- 5310 MHz: Fundamental Frequency
- *: Out of Restricted Band
- The emission levels of other frequencies were very low against the limit

EUT Test Condition		Measurement Detail	
Channel	Channel 102	Frequency Range	1 GHz ~ 40 GHz
Input Power	120 Vac, 60 Hz	Detector Function	Peak (PK) Average (AV)
Environmental Conditions	25 deg. C, 65 % RH	Tested By	Thomas Wei

Antenna Polarity & Test Distance: Horizontal at 3 m								
Frequency (MHz)	Emission Level (dBuV/m)	Read Level (dBuV)	Factor (dB/m)	Limit (dBuV/m)	Margin (dB)	Antenna Height (cm)	Table Angle (Degree)	Remark
5460	41.77	39.9	1.87	54	-12.23	128	23	Average
5460	52.32	50.45	1.87	74	-21.68	128	23	Peak
*5470	56.63	54.77	1.86	68.2	-11.57	128	23	Peak
5510	85.96	84.12	1.84			128	23	Average
5510	92.73	90.89	1.84			128	23	Peak
*5725	50.66	48.9	1.76	68.2	-17.54	128	23	Peak
11020	46.93	49.27	-2.34	54	-7.07	140	208	Average
11020	56.13	58.47	-2.34	74	-17.87	140	208	Peak

Antenna Polarity & Test Distance: Vertical at 3 m								
Frequency (MHz)	Emission Level (dBuV/m)	Read Level (dBuV)	Factor (dB/m)	Limit (dBuV/m)	Margin (dB)	Antenna Height (cm)	Table Angle (Degree)	Remark
5460	42.25	40.38	1.87	54	-11.75	183	242	Average
5460	53.21	51.34	1.87	74	-20.79	183	242	Peak
*5470	57.9	56.04	1.86	68.2	-10.3	183	242	Peak
5510	87.71	85.87	1.84			183	242	Average
5510	94.67	92.83	1.84			183	242	Peak
*5725	50.46	48.7	1.76	68.2	-17.74	183	242	Peak
11020	47.31	49.65	-2.34	54	-6.69	149	255	Average
11020	55.38	57.72	-2.34	74	-18.62	149	255	Peak

Remarks:

- Emission Level = Read Level + Factor
Margin value = Emission level – Limit value
- 5510 MHz: Fundamental Frequency
- *: Out of Restricted Band
- The emission levels of other frequencies were very low against the limit

EUT Test Condition		Measurement Detail	
Channel	Channel 110	Frequency Range	1 GHz ~ 40 GHz
Input Power	120 Vac, 60 Hz	Detector Function	Peak (PK) Average (AV)
Environmental Conditions	25 deg. C, 65 % RH	Tested By	Thomas Wei

Antenna Polarity & Test Distance: Horizontal at 3 m								
Frequency (MHz)	Emission Level (dBuV/m)	Read Level (dBuV)	Factor (dB/m)	Limit (dBuV/m)	Margin (dB)	Antenna Height (cm)	Table Angle (Degree)	Remark
5455.28	41.39	39.52	1.87	54	-12.61	185	44	Average
5455.28	50.38	48.51	1.87	74	-23.62	185	44	Peak
*5470	49.93	48.07	1.86	68.2	-18.27	185	44	Peak
5550	85.85	84.02	1.83			185	44	Average
5550	92.56	90.73	1.83			185	44	Peak
*5725	49.93	48.17	1.76	68.2	-18.27	185	44	Peak
11100	46.73	49.19	-2.46	54	-7.27	164	137	Average
11100	56.02	58.48	-2.46	74	-17.98	164	137	Peak

Antenna Polarity & Test Distance: Vertical at 3 m								
Frequency (MHz)	Emission Level (dBuV/m)	Read Level (dBuV)	Factor (dB/m)	Limit (dBuV/m)	Margin (dB)	Antenna Height (cm)	Table Angle (Degree)	Remark
5445.2	41.4	39.62	1.78	54	-12.6	179	228	Average
5445.2	51.49	49.71	1.78	74	-22.51	179	228	Peak
*5470	50.16	48.3	1.86	68.2	-18.04	179	228	Peak
5550	87.58	85.75	1.83			179	228	Average
5550	93.25	91.42	1.83			179	228	Peak
*5725	49.82	48.06	1.76	68.2	-18.38	179	228	Peak
11100	47.02	49.48	-2.46	54	-6.98	152	113	Average
11100	56.16	58.62	-2.46	74	-17.84	152	113	Peak

Remarks:

- Emission Level = Read Level + Factor
Margin value = Emission level – Limit value
- 5550 MHz: Fundamental Frequency
- *: Out of Restricted Band
- The emission levels of other frequencies were very low against the limit

EUT Test Condition		Measurement Detail	
Channel	Channel 134	Frequency Range	1 GHz ~ 40 GHz
Input Power	120 Vac, 60 Hz	Detector Function	Peak (PK) Average (AV)
Environmental Conditions	25 deg. C, 65 % RH	Tested By	Tim Chen

Antenna Polarity & Test Distance: Horizontal at 3 m								
Frequency (MHz)	Emission Level (dBuV/m)	Read Level (dBuV)	Factor (dB/m)	Limit (dBuV/m)	Margin (dB)	Antenna Height (cm)	Table Angle (Degree)	Remark
5460	41.32	39.45	1.87	54	-12.68	140	15	Average
5460	51.24	49.37	1.87	74	-22.76	140	15	Peak
*5470	50.19	48.33	1.86	68.2	-18.01	140	15	Peak
5670	86.7	84.94	1.76			140	15	Average
5670	93.52	91.76	1.76			140	15	Peak
*5725	51.3	49.54	1.76	68.2	-16.9	140	15	Peak
11340	46.71	49.07	-2.36	54	-7.29	155	94	Average
11340	56.74	59.1	-2.36	74	-17.26	155	94	Peak

Antenna Polarity & Test Distance: Vertical at 3 m								
Frequency (MHz)	Emission Level (dBuV/m)	Read Level (dBuV)	Factor (dB/m)	Limit (dBuV/m)	Margin (dB)	Antenna Height (cm)	Table Angle (Degree)	Remark
5446.48	41.42	39.6	1.82	54	-12.58	144	227	Average
5446.48	50.29	48.47	1.82	74	-23.71	144	227	Peak
*5470	49.42	47.56	1.86	68.2	-18.78	144	227	Peak
5670	88.14	86.38	1.76			144	227	Average
5670	94.44	92.68	1.76			144	227	Peak
*5725	54.07	52.31	1.76	68.2	-14.13	144	227	Peak
11340	46.96	49.32	-2.36	54	-7.04	166	274	Average
11340	56.39	58.75	-2.36	74	-17.61	166	274	Peak

Remarks:

- Emission Level = Read Level + Factor
Margin value = Emission level – Limit value
- 5670 MHz: Fundamental Frequency
- *: Out of Restricted Band
- The emission levels of other frequencies were very low against the limit

EUT Test Condition		Measurement Detail	
Channel	Channel 151	Frequency Range	1 GHz ~ 40 GHz
Input Power	120 Vac, 60 Hz	Detector Function	Peak (PK) Average (AV)
Environmental Conditions	25 deg. C, 65 % RH	Tested By	Thomas Wei

<Spurious Emission>

Antenna Polarity & Test Distance: Horizontal at 3 m								
Frequency (MHz)	Emission Level (dBuV/m)	Read Level (dBuV)	Factor (dB/m)	Limit (dBuV/m)	Margin (dB)	Antenna Height (cm)	Table Angle (Degree)	Remark
5755	87.52	85.62	1.9			187	62	Average
5755	94	92.1	1.9			187	62	Peak
11510	47.16	49.37	-2.21	54	-6.84	143	266	Average
11510	55.39	57.6	-2.21	74	-18.61	143	266	Peak

Antenna Polarity & Test Distance: Vertical at 3 m								
Frequency (MHz)	Emission Level (dBuV/m)	Read Level (dBuV)	Factor (dB/m)	Limit (dBuV/m)	Margin (dB)	Antenna Height (cm)	Table Angle (Degree)	Remark
5755	87.68	85.78	1.9			177	236	Average
5755	93.73	91.83	1.9			177	236	Peak
11510	47.34	49.55	-2.21	54	-6.66	149	41	Average
11510	55.68	57.89	-2.21	74	-18.32	149	41	Peak

<Out of Band Emission (OOBE)>

Antenna Polarity & Test Distance: Horizontal at 3 m								
Frequency (MHz)	Emission Level (dBuV/m)	Read Level (dBuV)	Factor (dB/m)	Limit (dBuV/m)	Margin (dB)	Antenna Height (cm)	Table Angle (Degree)	Remark
5643.1	50.64	48.76	1.88	68.2	-17.56	187	62	Peak
5653.075	50.45	48.54	1.91	70.49	-20.04	187	62	Peak
5920.975	50.89	48.58	2.31	71.17	-20.28	187	62	Peak
5992.7	51.17	48.81	2.36	68.2	-17.03	187	62	Peak

Antenna Polarity & Test Distance: Vertical at 3 m								
Frequency (MHz)	Emission Level (dBuV/m)	Read Level (dBuV)	Factor (dB/m)	Limit (dBuV/m)	Margin (dB)	Antenna Height (cm)	Table Angle (Degree)	Remark
5578.025	50.59	48.77	1.82	68.2	-17.61	177	236	Peak
5655.925	49.91	48.06	1.85	72.6	-22.69	177	236	Peak
5918.125	50.31	48	2.31	73.27	-22.96	177	236	Peak
5963.725	51.48	49.18	2.3	68.2	-16.72	177	236	Peak

Remarks:

- Emission Level = Read Level + Factor
Margin value = Emission level – Limit value
- 5755 MHz: Fundamental Frequency
- *: Out of Restricted Band
- The emission levels of other frequencies were very low against the limit

EUT Test Condition		Measurement Detail	
Channel	Channel 159	Frequency Range	1 GHz ~ 40 GHz
Input Power	120 Vac, 60 Hz	Detector Function	Peak (PK) Average (AV)
Environmental Conditions	25 deg. C, 65 % RH	Tested By	Thomas Wei

<Spurious Emission>

Antenna Polarity & Test Distance: Horizontal at 3 m								
Frequency (MHz)	Emission Level (dBuV/m)	Read Level (dBuV)	Factor (dB/m)	Limit (dBuV/m)	Margin (dB)	Antenna Height (cm)	Table Angle (Degree)	Remark
5795	88.24	86.24	2			182	63	Average
5795	94.33	92.33	2			182	63	Peak
11590	47.11	49.3	-2.19	54	-6.89	177	219	Average
11590	56.37	58.56	-2.19	74	-17.63	177	219	Peak

Antenna Polarity & Test Distance: Vertical at 3 m								
Frequency (MHz)	Emission Level (dBuV/m)	Read Level (dBuV)	Factor (dB/m)	Limit (dBuV/m)	Margin (dB)	Antenna Height (cm)	Table Angle (Degree)	Remark
5795	88.14	86.14	2			173	240	Average
5795	94.37	92.37	2			173	240	Peak
11590	47.32	49.51	-2.19	54	-6.68	167	166	Average
11590	56.98	59.17	-2.19	74	-17.02	167	166	Peak

<Out of Band Emission (OOBE)>

Antenna Polarity & Test Distance: Horizontal at 3 m								
Frequency (MHz)	Emission Level (dBuV/m)	Read Level (dBuV)	Factor (dB/m)	Limit (dBuV/m)	Margin (dB)	Antenna Height (cm)	Table Angle (Degree)	Remark
5623.15	51.85	49.95	1.9	68.2	-16.35	182	63	Peak
5657.35	50.18	48.33	1.85	73.66	-23.48	182	63	Peak
5918.6	50.55	48.24	2.31	72.92	-22.37	182	63	Peak
6010.275	51.22	48.83	2.39	68.2	-16.98	182	63	Peak

Antenna Polarity & Test Distance: Vertical at 3 m								
Frequency (MHz)	Emission Level (dBuV/m)	Read Level (dBuV)	Factor (dB/m)	Limit (dBuV/m)	Margin (dB)	Antenna Height (cm)	Table Angle (Degree)	Remark
5631.225	50.34	48.5	1.84	68.2	-17.86	173	240	Peak
5651.175	50.26	48.35	1.91	69.07	-18.81	173	240	Peak
5920.5	50.92	48.61	2.31	71.52	-20.6	173	240	Peak
5952.325	50.92	48.63	2.29	68.2	-17.28	173	240	Peak

Remarks:

- Emission Level = Read Level + Factor
Margin value = Emission level – Limit value
- 5795 MHz: Fundamental Frequency
- *: Out of Restricted Band
- The emission levels of other frequencies were very low against the limit

802.11ac (VHT80)

EUT Test Condition		Measurement Detail	
Channel	Channel 42	Frequency Range	1 GHz ~ 40 GHz
Input Power	120 Vac, 60 Hz	Detector Function	Peak (PK) Average (AV)
Environmental Conditions	25 deg. C, 65 % RH	Tested By	Tim Chen

Antenna Polarity & Test Distance: Horizontal at 3 m								
Frequency (MHz)	Emission Level (dBuV/m)	Read Level (dBuV)	Factor (dB/m)	Limit (dBuV/m)	Margin (dB)	Antenna Height (cm)	Table Angle (Degree)	Remark
5150	42.6	41.07	1.53	54	-11.4	183	243	Average
5150	50.45	48.92	1.53	74	-23.55	183	243	Peak
5210	81.84	80.4	1.44			183	243	Average
5210	87.84	86.4	1.44			183	243	Peak
5350	41.81	40.35	1.46	54	-12.19	183	243	Average
5350	50.52	49.06	1.46	74	-23.48	183	243	Peak
*10420	54.64	57.49	-2.85	68.2	-13.56	211	119	Peak

Antenna Polarity & Test Distance: Vertical at 3 m								
Frequency (MHz)	Emission Level (dBuV/m)	Read Level (dBuV)	Factor (dB/m)	Limit (dBuV/m)	Margin (dB)	Antenna Height (cm)	Table Angle (Degree)	Remark
5150	42.83	41.3	1.53	54	-11.17	161	227	Average
5150	51.19	49.66	1.53	74	-22.81	161	227	Peak
5210	83.92	82.48	1.44			161	227	Average
5210	91.07	89.63	1.44			161	227	Peak
5350	41.72	40.26	1.46	54	-12.28	161	227	Average
5350	50.64	49.18	1.46	74	-23.36	161	227	Peak
*10420	54.62	57.47	-2.85	68.2	-13.58	129	103	Peak

Remarks:

- Emission Level = Read Level + Factor
Margin value = Emission level – Limit value
- 5210 MHz: Fundamental Frequency
- *: Out of Restricted Band
- The emission levels of other frequencies were very low against the limit

EUT Test Condition		Measurement Detail	
Channel	Channel 58	Frequency Range	1 GHz ~ 40 GHz
Input Power	120 Vac, 60 Hz	Detector Function	Peak (PK) Average (AV)
Environmental Conditions	25 deg. C, 65 % RH	Tested By	Thomas Wei

Antenna Polarity & Test Distance: Horizontal at 3 m								
Frequency (MHz)	Emission Level (dBuV/m)	Read Level (dBuV)	Factor (dB/m)	Limit (dBuV/m)	Margin (dB)	Antenna Height (cm)	Table Angle (Degree)	Remark
5028.08	41.78	40.27	1.51	54	-12.22	197	13	Average
5028.08	50.97	49.46	1.51	74	-23.03	197	13	Peak
5290	80.87	79.56	1.31			197	13	Average
5290	86.6	85.29	1.31			197	13	Peak
5350.11	44.59	43.13	1.46	54	-9.41	197	13	Average
5350.11	52.75	51.29	1.46	74	-21.25	197	13	Peak
*10580	54.83	57.71	-2.88	68.2	-13.37	163	215	Peak
Antenna Polarity & Test Distance: Vertical at 3 m								
Frequency (MHz)	Emission Level (dBuV/m)	Read Level (dBuV)	Factor (dB/m)	Limit (dBuV/m)	Margin (dB)	Antenna Height (cm)	Table Angle (Degree)	Remark
5009.54	41.8	40.33	1.47	54	-12.2	152	228	Average
5009.54	50.29	48.82	1.47	74	-23.71	152	228	Peak
5290	83.49	82.18	1.31			152	228	Average
5290	89.93	88.62	1.31			152	228	Peak
5350	45.89	44.43	1.46	54	-8.11	152	228	Average
5350	53.81	52.35	1.46	74	-20.19	152	228	Peak
*10580	55.48	58.36	-2.88	68.2	-12.72	156	289	Peak

Remarks:

- Emission Level = Read Level + Factor
Margin value = Emission level – Limit value
- 5290 MHz: Fundamental Frequency
- *: Out of Restricted Band
- The emission levels of other frequencies were very low against the limit

EUT Test Condition		Measurement Detail	
Channel	Channel 106	Frequency Range	1 GHz ~ 40 GHz
Input Power	120 Vac, 60 Hz	Detector Function	Peak (PK) Average (AV)
Environmental Conditions	25 deg. C, 65 % RH	Tested By	Thomas Wei

Antenna Polarity & Test Distance: Horizontal at 3 m								
Frequency (MHz)	Emission Level (dBuV/m)	Read Level (dBuV)	Factor (dB/m)	Limit (dBuV/m)	Margin (dB)	Antenna Height (cm)	Table Angle (Degree)	Remark
5453.52	43.49	41.62	1.87	54	-10.51	177	44	Average
5453.52	55.44	53.57	1.87	74	-18.56	177	44	Peak
*5470	56.21	54.35	1.86	68.2	-11.99	177	44	Peak
5530	84.47	82.66	1.81			177	44	Average
5530	91.42	89.61	1.81			177	44	Peak
*5725	50.6	48.84	1.76	68.2	-17.6	177	44	Peak
11060	46.9	49.32	-2.42	54	-7.1	148	267	Average
11060	55.49	57.91	-2.42	74	-18.51	148	267	Peak

Antenna Polarity & Test Distance: Vertical at 3 m								
Frequency (MHz)	Emission Level (dBuV/m)	Read Level (dBuV)	Factor (dB/m)	Limit (dBuV/m)	Margin (dB)	Antenna Height (cm)	Table Angle (Degree)	Remark
5458.48	44.48	42.61	1.87	54	-9.52	148	225	Average
5458.48	56.02	54.15	1.87	74	-17.98	148	225	Peak
*5470	56.86	55	1.86	68.2	-11.34	148	225	Peak
5530	85.26	83.45	1.81			148	225	Average
5530	92.46	90.65	1.81			148	225	Peak
*5725	49.39	47.63	1.76	68.2	-18.81	148	225	Peak
11060	47.1	49.52	-2.42	54	-6.9	152	119	Average
11060	55.9	58.32	-2.42	74	-18.1	152	119	Peak

Remarks:

- Emission Level = Read Level + Factor
Margin value = Emission level – Limit value
- 5530 MHz: Fundamental Frequency
- *: Out of Restricted Band
- The emission levels of other frequencies were very low against the limit

EUT Test Condition		Measurement Detail	
Channel	Channel 122	Frequency Range	1 GHz ~ 40 GHz
Input Power	120 Vac, 60 Hz	Detector Function	Peak (PK) Average (AV)
Environmental Conditions	25 deg. C, 65 % RH	Tested By	Thomas Wei

Antenna Polarity & Test Distance: Horizontal at 3 m								
Frequency (MHz)	Emission Level (dBuV/m)	Read Level (dBuV)	Factor (dB/m)	Limit (dBuV/m)	Margin (dB)	Antenna Height (cm)	Table Angle (Degree)	Remark
5444.24	41.73	39.95	1.78	54	-12.27	176	242	Average
5444.24	51.55	49.77	1.78	74	-22.45	176	242	Peak
*5470	49.69	47.83	1.86	68.2	-18.51	176	242	Peak
5610	84.82	82.95	1.87			176	242	Average
5610	91.59	89.72	1.87			176	242	Peak
*5725	49.66	47.9	1.76	68.2	-18.54	176	242	Peak
11220	46.66	49.18	-2.52	54	-7.34	183	105	Average
11220	55.1	57.62	-2.52	74	-18.9	183	105	Peak

Antenna Polarity & Test Distance: Vertical at 3 m								
Frequency (MHz)	Emission Level (dBuV/m)	Read Level (dBuV)	Factor (dB/m)	Limit (dBuV/m)	Margin (dB)	Antenna Height (cm)	Table Angle (Degree)	Remark
5456.4	41.73	39.86	1.87	54	-12.27	136	225	Average
5456.4	50.51	48.64	1.87	74	-23.49	136	225	Peak
*5470	49.7	47.84	1.86	68.2	-18.5	136	225	Peak
5610	84.59	82.72	1.87			136	225	Average
5610	90.51	88.64	1.87			136	225	Peak
*5725	49.47	47.71	1.76	68.2	-18.73	136	225	Peak
11220	46.9	49.42	-2.52	54	-7.1	172	188	Average
11220	55.8	58.32	-2.52	74	-18.2	172	188	Peak

Remarks:

- Emission Level = Read Level + Factor
Margin value = Emission level – Limit value
- 5610 MHz: Fundamental Frequency
- *: Out of Restricted Band
- The emission levels of other frequencies were very low against the limit

EUT Test Condition		Measurement Detail	
Channel	Channel 155	Frequency Range	1 GHz ~ 40 GHz
Input Power	120 Vac, 60 Hz	Detector Function	Peak (PK) Average (AV)
Environmental Conditions	25 deg. C, 65 % RH	Tested By	Thomas Wei

<Spurious Emission>

Antenna Polarity & Test Distance: Horizontal at 3 m								
Frequency (MHz)	Emission Level (dBuV/m)	Read Level (dBuV)	Factor (dB/m)	Limit (dBuV/m)	Margin (dB)	Antenna Height (cm)	Table Angle (Degree)	Remark
5775	85.49	83.53	1.96			181	63	Average
5775	91.79	89.83	1.96			181	63	Peak
11550	47.41	49.61	-2.2	54	-6.59	168	250	Average
11550	56.24	58.44	-2.2	74	-17.76	168	250	Peak
Antenna Polarity & Test Distance: Vertical at 3 m								
Frequency (MHz)	Emission Level (dBuV/m)	Read Level (dBuV)	Factor (dB/m)	Limit (dBuV/m)	Margin (dB)	Antenna Height (cm)	Table Angle (Degree)	Remark
5775	86.1	84.14	1.96			175	239	Average
5775	93.31	91.35	1.96			175	239	Peak
11550	47.64	49.84	-2.2	54	-6.36	156	221	Average
11550	56.64	58.84	-2.2	74	-17.36	156	221	Peak

<Out of Band Emission (OOBE)>

Antenna Polarity & Test Distance: Horizontal at 3 m								
Frequency (MHz)	Emission Level (dBuV/m)	Read Level (dBuV)	Factor (dB/m)	Limit (dBuV/m)	Margin (dB)	Antenna Height (cm)	Table Angle (Degree)	Remark
5608.9	50.86	48.99	1.87	68.2	-17.34	181	63	Peak
5655.925	50.74	48.89	1.85	72.6	-21.86	181	63	Peak
5923.825	50.44	48.14	2.3	69.07	-18.63	181	63	Peak
5952.325	51.79	49.5	2.29	68.2	-16.41	181	63	Peak
Antenna Polarity & Test Distance: Vertical at 3 m								
Frequency (MHz)	Emission Level (dBuV/m)	Read Level (dBuV)	Factor (dB/m)	Limit (dBuV/m)	Margin (dB)	Antenna Height (cm)	Table Angle (Degree)	Remark
5586.575	50.28	48.41	1.87	68.2	-17.92	175	239	Peak
5654.025	50.86	49.01	1.85	71.19	-20.33	175	239	Peak
5916.7	50.43	48.12	2.31	74.32	-23.89	175	239	Peak
5942.35	51.15	48.86	2.29	68.2	-17.05	175	239	Peak

Remarks:

- Emission Level = Read Level + Factor
Margin value = Emission level – Limit value
- 5775 MHz: Fundamental Frequency
- *: Out of Restricted Band
- The emission levels of other frequencies were very low against the limit

9 kHz ~ 30 MHz Data:

The amplitude of spurious emissions attenuated more than 20 dB below the permissible value is not required to be report.

30 MHz ~ 1 GHz Worst-Case Data:

802.11a

EUT Test Condition		Measurement Detail	
Channel	Channel 100	Frequency Range	30 MHz ~ 1 GHz
Input Power	120 Vac, 60 Hz	Detector Function	Peak (PK) Quasi-peak (QP)
Environmental Conditions	25 deg. C, 65 % RH	Tested By	Thomas Wei

Horizontal

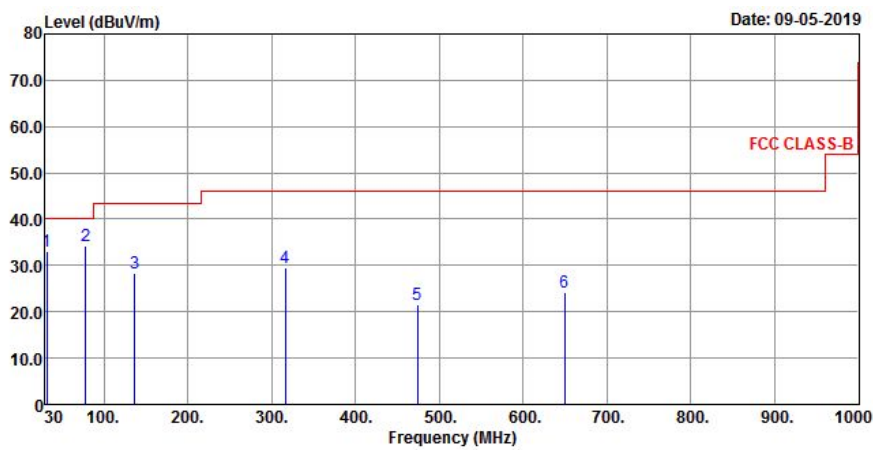

Vertical

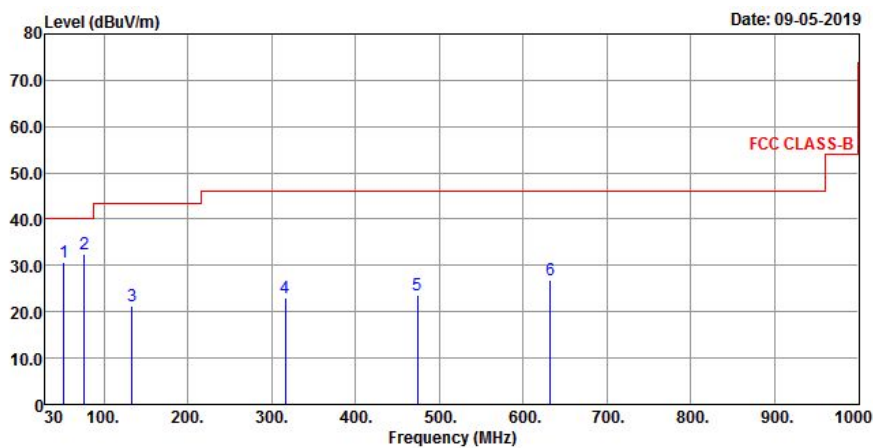

Antenna Polarity & Test Distance: Horizontal at 3 m

Frequency (MHz)	Emission Level (dBuV/m)	Read Level (dBuV)	Factor (dB/m)	Limit (dBuV/m)	Margin (dB)	Antenna Height (cm)	Table Angle (Degree)	Remark
31.94	32.95	50.16	-17.21	40	-7.05	135	146	Peak
78.5	34.38	55.69	-21.31	40	-5.62	155	167	Peak
136.7	28.49	46.61	-18.12	43.5	-15.01	198	211	Peak
316.15	29.49	45.43	-15.94	46	-16.51	245	256	Peak
474.26	21.56	33.64	-12.08	46	-24.44	264	284	Peak
649.83	24.31	32.52	-8.21	46	-21.69	299	315	Peak

Antenna Polarity & Test Distance: Vertical at 3 m

Frequency (MHz)	Emission Level (dBuV/m)	Read Level (dBuV)	Factor (dB/m)	Limit (dBuV/m)	Margin (dB)	Antenna Height (cm)	Table Angle (Degree)	Remark
52.31	30.74	48.41	-17.67	40	-9.26	135	142	Peak
76.56	32.33	53.41	-21.08	40	-7.67	155	167	Peak
133.79	21.37	39.94	-18.57	43.5	-22.13	211	228	Peak
316.15	22.92	38.86	-15.94	46	-23.08	235	248	Peak
474.26	23.47	35.55	-12.08	46	-22.53	267	284	Peak
632.37	26.95	35.57	-8.62	46	-19.05	305	311	Peak

Remarks:

- Emission Level = Read Level + Factor
Margin value = Emission level – Limit value
- The emission levels of other frequencies were very low against the limit

4.2 Conducted Emission Measurement

4.2.1 Limits of Conducted Emission Measurement

Frequency (MHz)	Conducted Limit (dBuV)	
	Quasi-Peak	Average
0.15 - 0.5	66 - 56	56 - 46
0.50 - 5.0	56	46
5.0 - 30.0	60	50

- Note: 1. The lower limit shall apply at the transition frequencies.
 2. The limit decreases in line with the logarithm of the frequency in the range of 0.15 to 0.50 MHz.

4.2.2 Test Instruments

Description & Manufacturer	Model No.	Serial No.	Date of Calibration	Due Date of Calibration
Test Receiver ROHDE & SCHWARZ	ESCI	100613	Dec. 10, 2018	Dec. 09, 2019
RF signal cable Woken	5D-FB	Cable-cond1-01	Sep. 05, 2018	Sep. 04, 2019
LISN ROHDE & SCHWARZ (EUT)	ENV216	101826	Feb. 21, 2019	Feb. 20, 2020
LISN ROHDE & SCHWARZ (Peripheral)	ESH3-Z5	100311	Aug. 22, 2019	Aug. 21, 2020
Software ADT	BV ADT_Cond_ V7.3.7.4	NA	NA	NA

- Note: 1. The calibration interval of the above test instruments is 12 months and the calibrations are traceable to NML/ROC and NIST/USA.
 2. The test was performed in HwaYa Shielded Room 1.
 3. The VCCI Site Registration No. is C-12040.

4.2.3 Test Procedures

- a. The EUT was placed 0.4 meters from the conducting wall of the shielded room with EUT being connected to the power mains through a line impedance stabilization network (LISN). Other support units were connected to the power mains through another LISN. The two LISNs provide 50 ohm/ 50uH of coupling impedance for the measuring instrument.
- b. Both lines of the power mains connected to the EUT were checked for maximum conducted interference.
- c. The frequency range from 150 kHz to 30 MHz was searched. Emission levels under (Limit -20 dB) was not recorded.

Note: All modes of operation were investigated and the worst-case emissions are reported.

4.2.4 Deviation from Test Standard

No deviation.

4.2.5 Test Setup

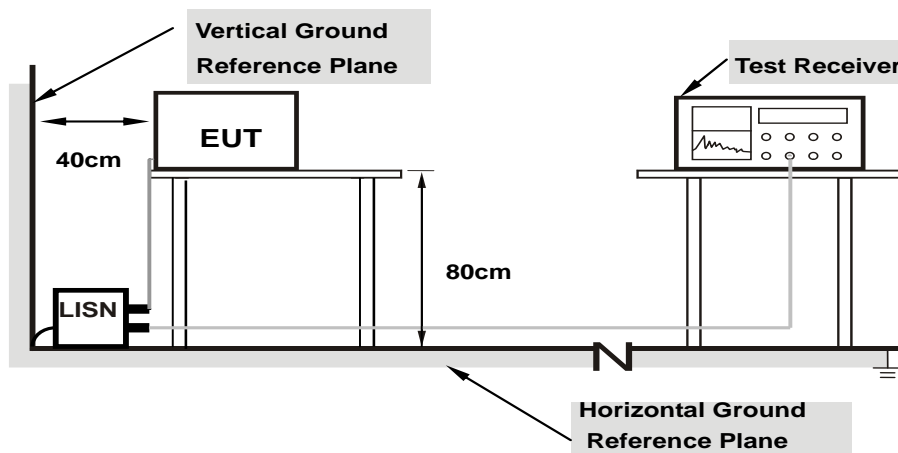

- Note:**
1. Support units were connected to second LISN.
 2. Both of LISNs (AMN) are 80 cm from EUT and at least 80 from other units and other metal planes

For the actual test configuration, please refer to the attached file (Test Setup Photo).

4.2.6 EUT Operating Conditions

Set the EUT under transmission condition continuously at specific channel frequency.

4.2.7 Test Results

Frequency Range	150kHz ~ 30MHz	Detector Function & Resolution Bandwidth	Quasi-Peak (QP) / Average (AV), 9kHz
Input Power	120Vac, 60Hz	Environmental Conditions	25°C, 65%RH
Tested by	Thomas Wei	Test Date	2019/9/4

Phase Of Power : Line (L)										
No	Frequency (MHz)	Correction Factor (dB)	Reading Value (dBuV)		Emission Level (dBuV)		Limit (dBuV)		Margin (dB)	
			Q.P.	AV.	Q.P.	AV.	Q.P.	AV.	Q.P.	AV.
1	0.16569	9.84	13.22	6.34	23.06	16.18	65.17	55.17	-42.11	-38.99
2	0.28288	9.86	13.01	7.92	22.87	17.78	60.73	50.73	-37.86	-32.95
3	0.44716	9.88	23.17	18.41	33.05	28.29	56.93	46.93	-23.88	-18.64
4	0.78342	9.91	15.20	4.37	25.11	14.28	56.00	46.00	-30.89	-31.72
5	1.36601	9.93	14.19	4.72	24.12	14.65	56.00	46.00	-31.88	-31.35
6	2.87136	9.98	12.15	6.03	22.13	16.01	56.00	46.00	-33.87	-29.99

Remarks:

1. Q.P. and AV. are abbreviations of quasi-peak and average individually.
2. The emission levels of other frequencies were very low against the limit.
3. Margin value = Emission level – Limit value
4. Correction factor = Insertion loss + Cable loss
5. Emission Level = Correction Factor + Reading Value

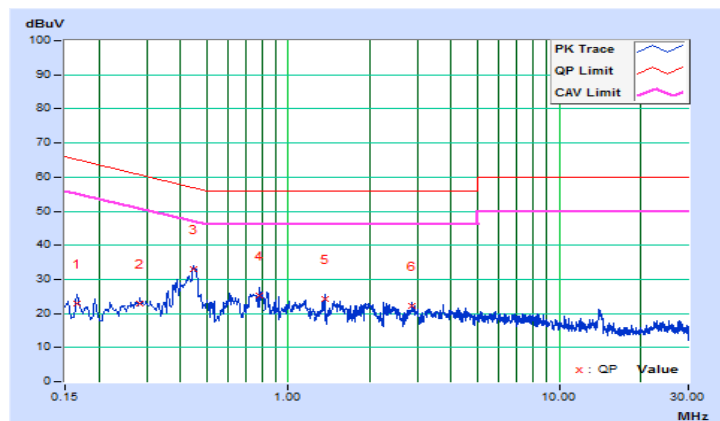

Frequency Range	150kHz ~ 30MHz	Detector Function & Resolution Bandwidth	Quasi-Peak (QP) / Average (AV), 9kHz
Input Power	120Vac, 60Hz	Environmental Conditions	25°C, 65%RH
Tested by	Thomas Wei	Test Date	2019/9/4

Phase Of Power : Neutral (N)										
No	Frequency (MHz)	Correction Factor (dB)	Reading Value (dBuV)		Emission Level (dBuV)		Limit (dBuV)		Margin (dB)	
			Q.P.	AV.	Q.P.	AV.	Q.P.	AV.	Q.P.	AV.
1	0.44716	9.87	22.96	17.18	32.83	27.05	56.93	46.93	-24.10	-19.88
2	0.78342	9.88	17.39	7.84	27.27	17.72	56.00	46.00	-28.73	-28.28
3	1.09231	9.88	13.49	8.00	23.37	17.88	56.00	46.00	-32.63	-28.12
4	14.75385	10.24	12.49	3.82	22.73	14.06	60.00	50.00	-37.27	-35.94
5	21.60417	10.32	14.80	1.27	25.12	11.59	60.00	50.00	-34.88	-38.41
6	25.21701	10.34	14.80	2.66	25.14	13.00	60.00	50.00	-34.86	-37.00

Remarks:

1. Q.P. and AV. are abbreviations of quasi-peak and average individually.
2. The emission levels of other frequencies were very low against the limit.
3. Margin value = Emission level – Limit value
4. Correction factor = Insertion loss + Cable loss
5. Emission Level = Correction Factor + Reading Value

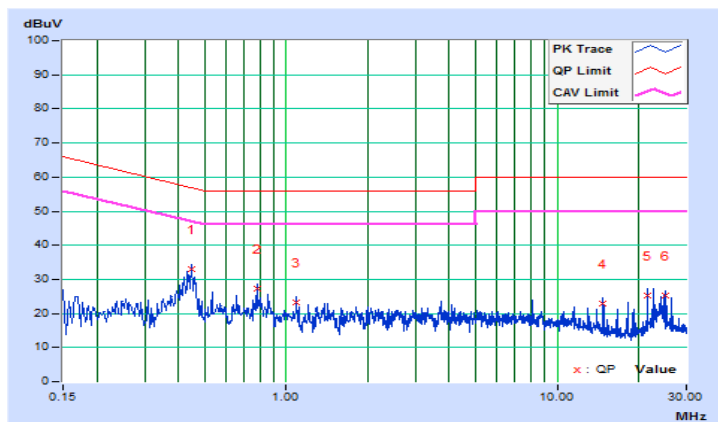

4.3 Transmit Power Measurement

4.3.1 Limits of Transmit Power Measurement

Operation Band	EUT Category	Limit
U-NII-1	Outdoor Access Point	1 Watt (30 dBm) (Max. e.i.r.p \leq 125 mW (21 dBm) at any elevation angle above 30 degrees as measured from the horizon)
	Fixed point-to-point Access Point	1 Watt (30 dBm)
	Indoor Access Point	1 Watt (30 dBm)
	√ Mobile and Portable client device	250 mW (24 dBm)
U-NII-2A	√	250 mW (24 dBm) or 11 dBm + 10 log B*
U-NII-2C	√	250 mW (24 dBm) or 11 dBm + 10 log B*
U-NII-3	√	1 Watt (30 dBm)

*B is the 26 dB emission bandwidth in megahertz

Per KDB 662911 Method of conducted output power measurement on IEEE 802.11 devices,

Array Gain = 0 dB (i.e., no array gain) for $N_{ANT} \leq 4$;

Array Gain = 0 dB (i.e., no array gain) for channel widths ≥ 40 MHz for any N_{ANT} ;

Array Gain = $5 \log(N_{ANT}/N_{SS})$ dB or 3 dB, whichever is less for 20 MHz channel widths with $N_{ANT} \geq 5$.

For power measurements on all other devices: Array Gain = $10 \log(N_{ANT}/N_{SS})$ dB.

4.3.2 Test Setup

<Power Output Measurement>

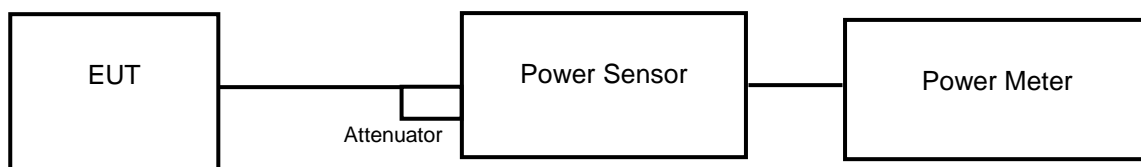

or

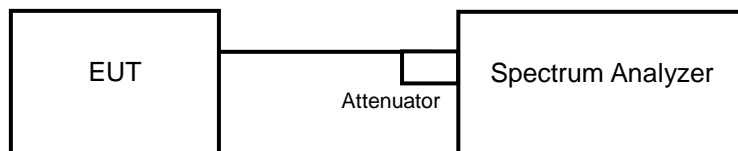

<26 dB Bandwidth>

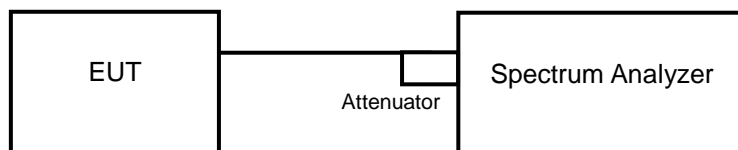

4.3.3 Test Instruments

Refer to section 4.1.2 to get information of above instrument.

4.3.4 Test Procedure

Average Power Measurement

<802.11a, 802.11n (HT20), 802.11n (HT40)>

Method PM is used to perform output power measurement, trigger and gating function of wide band power meter is enabled to measure max output power of TX on burst. Duty factor is not added to measured value.

<802.11ac (VHT80)>

- a. Set span to encompass the entire 26 dB EBW (or, alternatively, the entire 99 % occupied bandwidth) of the signal.
- b. Set sweep trigger to "free run".
- c. Set RBW = 1 MHz.
- d. Set VBW \geq 3 MHz
- e. Number of points in sweep \geq 2 Span / RBW.
- f. Sweep time \leq (number of points in sweep) * T
- g. Using emission bandwidth to determine the frequency span for integration the channel bandwidth.
- h. Detector = RMS.
- i. Trace mode = max hold.
- j. Allow max hold to run for at least 60 seconds, or longer as needed to allow the trace to stabilize.

26 dB Bandwidth

- a. Set RBW = approximately 1 % of the emission bandwidth.
- b. Set the VBW > RBW.
- c. Detector = Peak.
- d. Trace mode = max hold.
- e. Measure the maximum width of the emission that is 26 dB down from the peak of the emission. Compare this with the RBW setting of the analyzer. Readjust RBW and repeat measurement as needed until the RBW/EBW ratio is approximately 1 %.

4.3.5 Deviation from Test Standard

No deviation.

4.3.6 EUT Operating Conditions

The software provided by client to enable the EUT under transmission condition continuously at lowest, middle and highest channel frequencies individually.

4.3.7 Test Results

Power Output:

802.11a

Channel	Frequency (MHz)	Maximum Conducted Power (mW)	Maximum Conducted Power (dBm)	Power Limit (dBm)	Pass / Fail
36	5180	24.378	13.87	24	Pass
40	5200	24.774	13.94	24	Pass
48	5240	23.878	13.78	24	Pass
52	5260	24.044	13.81	24	Pass
60	5300	24.322	13.86	24	Pass
64	5320	23.227	13.66	24	Pass
100	5500	24.21	13.84	24	Pass
116	5580	23.988	13.80	24	Pass
140	5700	24.889	13.96	24	Pass
149	5745	24.774	13.94	30	Pass
157	5785	25.061	13.99	30	Pass
165	5825	24.946	13.97	30	Pass

Note:

For U-NII-2A, U-NII-2C Band:

1. $11 \text{ dBm} + 10\log (20.16) = 24.04 \text{ dBm} > 24 \text{ dBm}$.
2. $11 \text{ dBm} + 10\log (20.26) = 24.07 \text{ dBm} > 24 \text{ dBm}$.
3. $11 \text{ dBm} + 10\log (20.16) = 24.04 \text{ dBm} > 24 \text{ dBm}$.
4. $11 \text{ dBm} + 10\log (20.37) = 24.09 \text{ dBm} > 24 \text{ dBm}$.
5. $11 \text{ dBm} + 10\log (20.08) = 24.03 \text{ dBm} > 24 \text{ dBm}$.
6. $11 \text{ dBm} + 10\log (20.36) = 24.09 \text{ dBm} > 24 \text{ dBm}$.

802.11n (HT20)

Channel	Frequency (MHz)	Maximum Conducted Power (mW)	Maximum Conducted Power (dBm)	Power Limit (dBm)	Pass / Fail
36	5180	19.815	12.97	24	Pass
40	5200	19.77	12.96	24	Pass
48	5240	19.724	12.95	24	Pass
52	5260	19.861	12.98	24	Pass
60	5300	19.143	12.82	24	Pass
64	5320	19.011	12.79	24	Pass
100	5500	19.679	12.94	24	Pass
116	5580	19.634	12.93	24	Pass
140	5700	19.275	12.85	24	Pass
149	5745	19.77	12.96	30	Pass
157	5785	19.588	12.92	30	Pass
165	5825	19.861	12.98	30	Pass

Note:

For U-NII-2A, U-NII-2C Band:

1. $11 \text{ dBm} + 10\log(20.60) = 24.14 \text{ dBm} > 24 \text{ dBm}$.
2. $11 \text{ dBm} + 10\log(20.51) = 24.12 \text{ dBm} > 24 \text{ dBm}$.
3. $11 \text{ dBm} + 10\log(20.68) = 24.16 \text{ dBm} > 24 \text{ dBm}$.
4. $11 \text{ dBm} + 10\log(20.68) = 24.16 \text{ dBm} > 24 \text{ dBm}$.
5. $11 \text{ dBm} + 10\log(20.59) = 24.14 \text{ dBm} > 24 \text{ dBm}$.
6. $11 \text{ dBm} + 10\log(20.52) = 24.12 \text{ dBm} > 24 \text{ dBm}$.

802.11n (HT40)

Channel	Frequency (MHz)	Maximum Conducted Power (mW)	Maximum Conducted Power (dBm)	Power Limit (dBm)	Pass / Fail
38	5190	19.724	12.95	24	Pass
46	5230	19.543	12.91	24	Pass
54	5270	19.634	12.93	24	Pass
62	5310	18.836	12.75	24	Pass
102	5510	19.454	12.89	24	Pass
110	5550	19.275	12.85	24	Pass
134	5670	19.724	12.95	24	Pass
151	5755	18.793	12.74	30	Pass
159	5795	19.861	12.98	30	Pass

Note:

For U-NII-2A, U-NII-2C Band:

- $11 \text{ dBm} + 10\log (40.17) = 27.04 \text{ dBm} > 24 \text{ dBm}$.
- $11 \text{ dBm} + 10\log (40.28) = 27.05 \text{ dBm} > 24 \text{ dBm}$.
- $11 \text{ dBm} + 10\log (40.54) = 27.08 \text{ dBm} > 24 \text{ dBm}$.
- $11 \text{ dBm} + 10\log (40.30) = 27.05 \text{ dBm} > 24 \text{ dBm}$.
- $11 \text{ dBm} + 10\log (40.18) = 27.04 \text{ dBm} > 24 \text{ dBm}$.

802.11ac (VHT80)

Channel	Frequency (MHz)	Maximum Conducted Power (mW)	Maximum Conducted Power (dBm)	Power Limit (dBm)	Pass / Fail
42	5210	19.275	12.85	24	Pass
58	5290	19.187	12.83	24	Pass
106	5530	19.77	12.96	24	Pass
122	5610	19.588	12.92	24	Pass
155	5775	19.634	12.93	30	Pass

Note:

For U-NII-2A, U-NII-2C Band:

- $11 \text{ dBm} + 10\log (81.54) = 30.11 \text{ dBm} > 24 \text{ dBm}$.
- $11 \text{ dBm} + 10\log (81.36) = 30.10 \text{ dBm} > 24 \text{ dBm}$.
- $11 \text{ dBm} + 10\log (81.11) = 30.09 \text{ dBm} > 24 \text{ dBm}$.

26 dB Bandwidth:

802.11a

Channel	Frequency (MHz)	26 dBc Bandwidth (MHz)
36	5180	20.26
40	5200	20.36
48	5240	20.37
52	5260	20.16
60	5300	20.26
64	5320	20.16
100	5500	20.37
116	5580	20.08
140	5700	20.36

802.11n (HT20)

Channel	Frequency (MHz)	26 dBc Bandwidth (MHz)
36	5180	20.42
40	5200	20.63
48	5240	20.59
52	5260	20.60
60	5300	20.51
64	5320	20.68
100	5500	20.68
116	5580	20.59
140	5700	20.52

802.11n (HT40)

Channel	Frequency (MHz)	26 dBc Bandwidth (MHz)
38	5190	40.28
46	5230	40.48
54	5270	40.17
62	5310	40.28
102	5510	40.54
110	5550	40.30
134	5670	40.18

802.11ac (VHT80)

Channel	Frequency (MHz)	26 dBc Bandwidth (MHz)
42	5210	81.39
58	5290	81.54
106	5530	81.36
122	5610	81.11

Spectrum Plot of Worst Value

802.11a

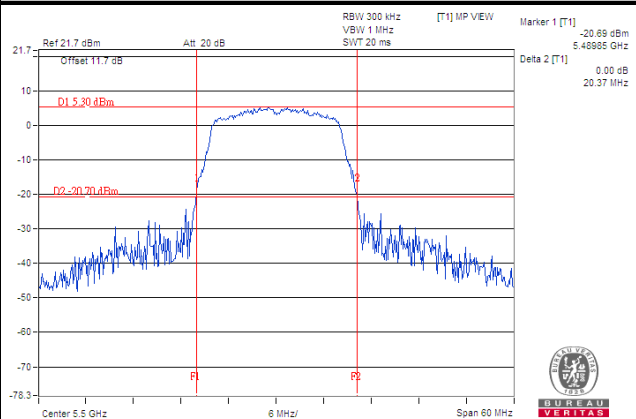

802.11n (HT20)

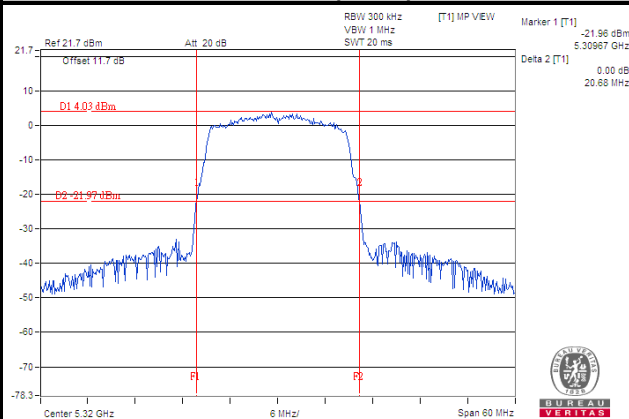

802.11n (HT40)

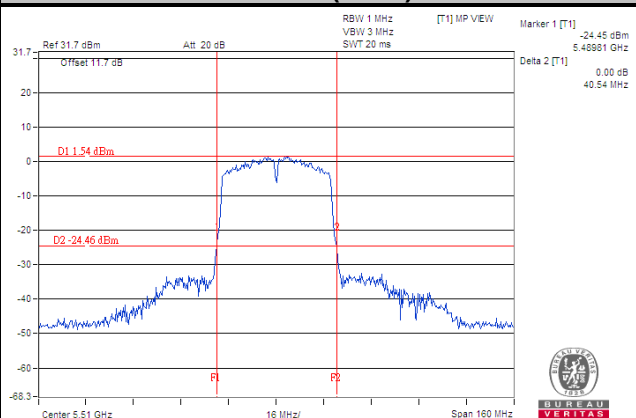

802.11ac (VHT80)

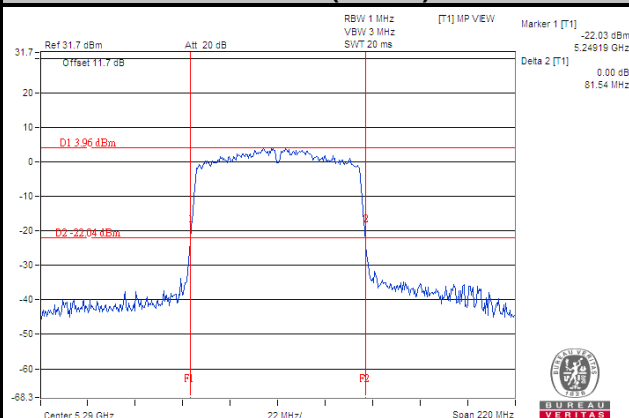

4.4 Occupied Bandwidth Measurement

4.4.1 Test Setup

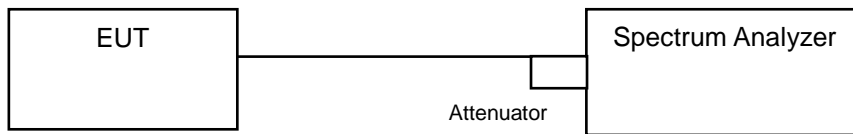

4.4.2 Test Instruments

Refer to section 4.1.2 to get information of above instrument.

4.4.3 Test Procedure

The transmitter output was connected to the spectrum analyzer through an attenuator. The bandwidth of the fundamental frequency was measured by spectrum analyzer with resolution bandwidth in the range of 1 % to 5 % of the anticipated emission bandwidth, and a video bandwidth at least 3x the resolution bandwidth and set the detector to SAMPLE. The width of a frequency band such that, below the lower and above the upper frequency limits, the mean powers emitted are each equal to a specified percentage 0.5 % of the total mean power of a given emission.

4.4.4 Test Results

802.11a

Channel	Channel Frequency (MHz)	Occupied Bandwidth (MHz)
36	5180	16.68
40	5200	16.44
48	5240	16.56
52	5260	16.44
60	5300	16.56
64	5320	16.44
100	5500	16.56
116	5580	16.44
140	5700	16.56
149	5745	16.44
157	5785	16.54
165	5825	16.54

802.11n (HT20)

Channel	Channel Frequency (MHz)	Occupied Bandwidth (MHz)
36	5180	17.64
40	5200	17.64
48	5240	17.64
52	5260	17.64
60	5300	17.64
64	5320	17.64
100	5500	17.64
116	5580	17.64
140	5700	17.64
149	5745	17.79
157	5785	17.60
165	5825	17.60

802.11n (HT40)

Channel	Channel Frequency (MHz)	Occupied Bandwidth (MHz)
38	5190	36.24
46	5230	36.24
54	5270	36.24
62	5310	36.12
102	5510	36.36
110	5550	36.00
134	5670	36.24
151	5755	36.36
159	5795	36.24

802.11ac (VHT80)

Channel	Channel Frequency (MHz)	Occupied Bandwidth (MHz)
42	5210	75.36
58	5290	75.36
106	5530	75.60
122	5610	75.36
155	5775	75.38

Spectrum Plot of Worst Value

802.11a

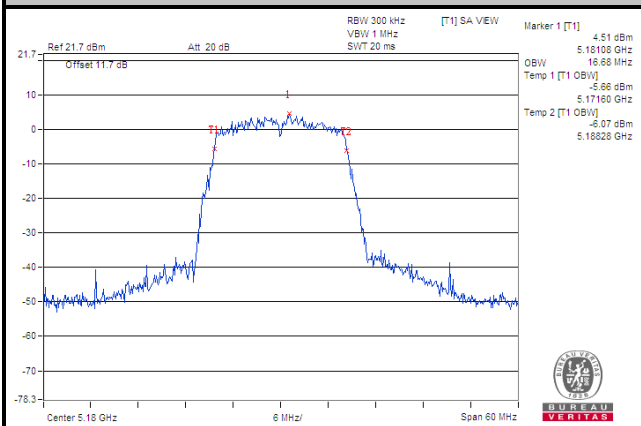

802.11n (HT20)

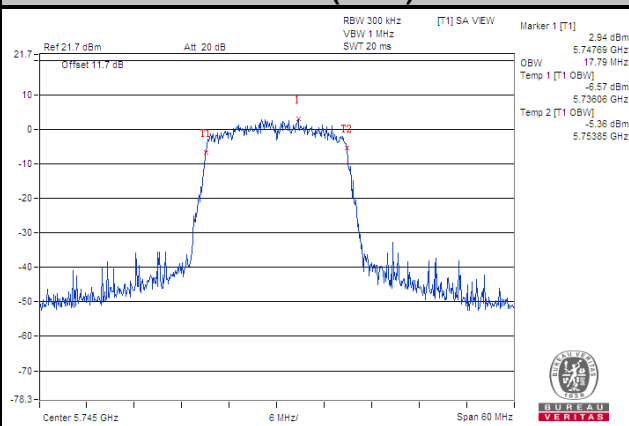

802.11n (HT40)

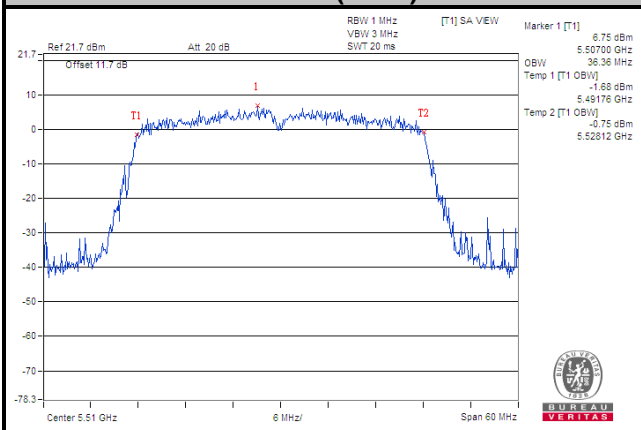

802.11ac (VHT80)

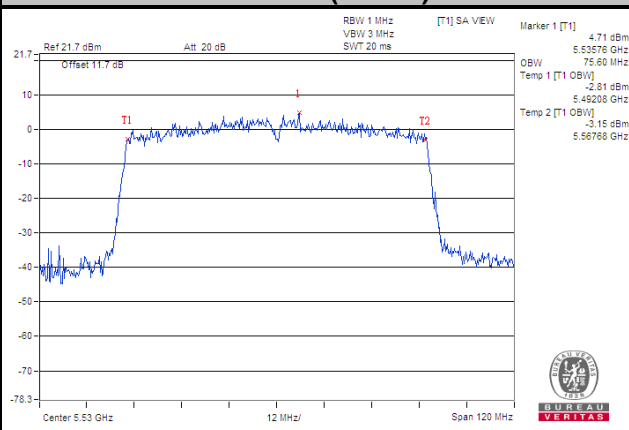

4.5 Peak Power Spectral Density Measurement

4.5.1 Limits of Peak Power Spectral Density Measurement

Operation Band	EUT Category		Limit
U-NII-1		Outdoor Access Point	17 dBm/MHz
		Fixed point-to-point Access Point	
		Indoor Access Point	
	√	Mobile and Portable client device	11 dBm/MHz
U-NII-2A		√	11 dBm/MHz
U-NII-2C		√	11 dBm/MHz
U-NII-3		√	30 dBm/500 kHz

4.5.2 Test Setup

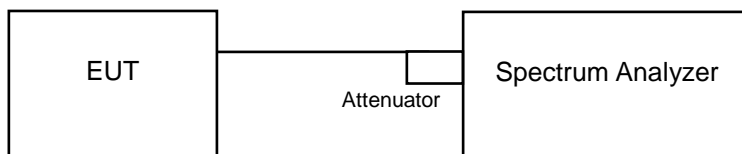

4.5.3 Test Instruments

Refer to section 4.1.3 to get information of above instrument.

4.5.4 Test Procedures

For U-NII-1, U-NII-2A, U-NII-2C band:

Using method SA-2 Duty cycle <98%

1. Set span to encompass the entire emission bandwidth (EBW) of the signal.
2. Set RBW = 1 MHz, Set VBW ≥ 3 RBW, Detector = RMS
3. Sweep time = auto, trigger set to “free run”.
4. Trace average at least 100 traces in power averaging mode.
5. Record the max value and add 10 log (1/duty cycle)

※ For U-NII-3: with duty cycle & Duty cycle <98 %

1. Set span to encompass the entire emission bandwidth (EBW) of the signal.
2. Set RBW = 300 kHz, Set VBW ≥ 1 RBW, Detector = RMS
3. Use the peak marker function to determine the maximum power level in any 300 kHz band segment within the fundamental EBW.
4. Scale the observed power level to an equivalent value in 500 kHz by adjusting (reducing) the measured power by a bandwidth correction factor (BWCF) where $BWCF = 10\log(500 \text{ kHz} / 300 \text{ kHz})$.
5. Sweep time = auto, trigger set to “free run”.
6. Trace average at least 100 traces in power averaging mode.
7. Record the max value and add 10 log (1/duty cycle)

4.5.5 Deviation from Test Standard

No deviation.

4.5.6 EUT Operating Conditions

The software provided by client to enable the EUT under transmission condition continuously at lowest, middle and highest channel frequencies individually.

4.5.7 Test Results

802.11a

Channel	Frequency (MHz)	PSD w/o Duty Factor (dBm/MHz)	Duty Factor (dB)	PSD with Duty Factor (dBm/MHz)	Maximum Limit (dBm/MHz)	Pass / Fail
36	5180	0.60	0.14	0.74	11	Pass
40	5200	0.05	0.14	0.19	11	Pass
48	5240	-0.34	0.14	-0.20	11	Pass
52	5260	-0.14	0.14	0.00	11	Pass
60	5300	-0.02	0.14	0.12	11	Pass
64	5320	-0.11	0.14	0.03	11	Pass
100	5500	0.67	0.14	0.81	11	Pass
116	5580	0.91	0.14	1.05	11	Pass
140	5700	1.01	0.14	1.15	11	Pass

Note: Refer to section 3.3 for duty cycle spectrum plot.

802.11n (HT20)

Channel	Frequency (MHz)	PSD w/o Duty Factor (dBm/MHz)	Duty Factor (dB)	PSD with Duty Factor (dBm/MHz)	Maximum Limit (dBm/MHz)	Pass / Fail
36	5180	-1.10	0.16	-0.94	11	Pass
40	5200	-1.04	0.16	-0.88	11	Pass
48	5240	-1.46	0.16	-1.30	11	Pass
52	5260	-1.16	0.16	-1.00	11	Pass
60	5300	-1.34	0.16	-1.18	11	Pass
64	5320	-1.44	0.16	-1.28	11	Pass
100	5500	-0.55	0.16	-0.39	11	Pass
116	5580	-0.41	0.16	-0.25	11	Pass
140	5700	-0.97	0.16	-0.81	11	Pass

Note: Refer to section 3.3 for duty cycle spectrum plot.

802.11n (HT40)

Channel	Frequency (MHz)	PSD w/o Duty Factor (dBm/MHz)	Duty Factor (dB)	PSD with Duty Factor (dBm/MHz)	Maximum Limit (dBm/MHz)	Pass / Fail
38	5190	-4.22	0.36	-3.86	11	Pass
46	5230	-4.64	0.36	-4.28	11	Pass
54	5270	-4.21	0.36	-3.85	11	Pass
62	5310	-3.99	0.36	-3.63	11	Pass
102	5510	-3.70	0.36	-3.34	11	Pass
110	5550	-3.68	0.36	-3.32	11	Pass
134	5670	-3.41	0.36	-3.05	11	Pass

Note: Refer to section 3.3 for duty cycle spectrum plot.

802.11ac (VHT80)

Channel	Frequency (MHz)	PSD w/o Duty Factor (dBm/MHz)	Duty Factor (dB)	PSD with Duty Factor (dBm/MHz)	Maximum Limit (dBm/MHz)	Pass / Fail
42	5210	-7.38	0.57	-6.81	11	Pass
58	5290	-7.45	0.57	-6.88	11	Pass
106	5530	-6.56	0.57	-5.99	11	Pass
122	5610	-6.58	0.57	-6.01	11	Pass

Note: Refer to section 3.3 for duty cycle spectrum plot.

Spectrum Plot of Worst Value

802.11a

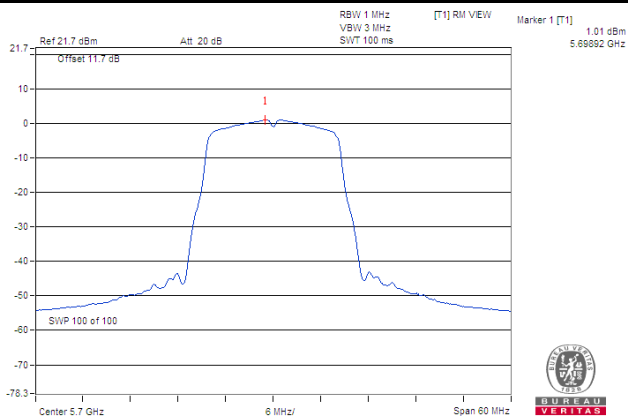

802.11n (HT20)

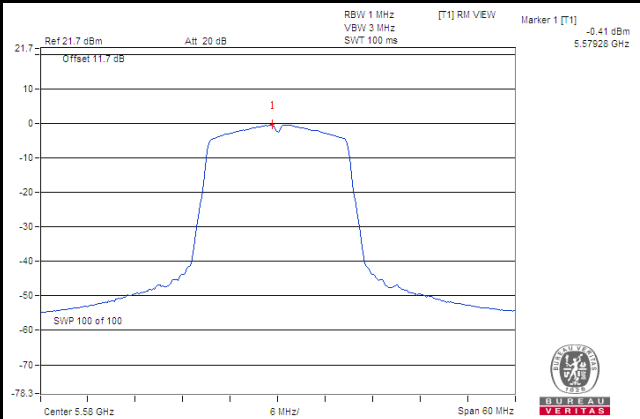

802.11n (HT40)

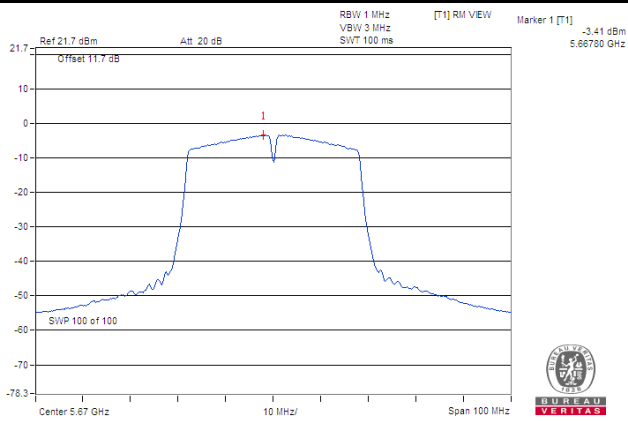

802.11ac (VHT80)

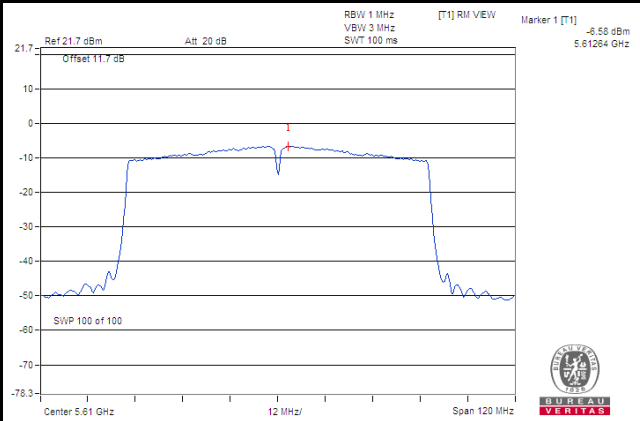

For U-NII-3 Band

802.11a

Channel	Frequency (MHz)	PSD w/o Duty Factor		Duty Factor (dB)	PSD with Duty Factor (dBm/500 kHz)	Limit (dBm/500 kHz)	Pass / Fail
		(dBm/300 kHz)	(dBm/500 kHz)				
149	5745	-7.68	-5.46	0.14	-5.32	30	Pass
157	5785	-7.68	-5.46	0.14	-5.32	30	Pass
165	5825	-7.91	-5.69	0.14	-5.55	30	Pass

Note: Refer to section 3.3 for duty cycle spectrum plot.

802.11n (HT20)

Channel	Frequency (MHz)	PSD w/o Duty Factor		Duty Factor (dB)	PSD with Duty Factor (dBm/500 kHz)	Limit (dBm/500 kHz)	Pass / Fail
		(dBm/300 kHz)	(dBm/500 kHz)				
149	5745	-8.82	-6.60	0.16	-6.44	30	Pass
157	5785	-9.07	-6.85	0.16	-6.69	30	Pass
165	5825	-9.14	-6.92	0.16	-6.76	30	Pass

Note: Refer to section 3.3 for duty cycle spectrum plot.

802.11n (HT40)

Channel	Frequency (MHz)	PSD w/o Duty Factor		Duty Factor (dB)	PSD with Duty Factor (dBm/500 kHz)	Limit (dBm/500 kHz)	Pass / Fail
		(dBm/300 kHz)	(dBm/500 kHz)				
151	5755	-12.47	-10.25	0.36	-9.89	30	Pass
159	5795	-12.62	-10.40	0.36	-10.04	30	Pass

Note: Refer to section 3.3 for duty cycle spectrum plot.

802.11ac (VHT80)

Channel	Frequency (MHz)	PSD w/o Duty Factor		Duty Factor (dB)	PSD with Duty Factor (dBm/500 kHz)	Limit (dBm/500 kHz)	Pass / Fail
		(dBm/300 kHz)	(dBm/500 kHz)				
155	5775	-15.53	-13.31	0.57	-12.74	30	Pass

Note: Refer to section 3.3 for duty cycle spectrum plot.

Spectrum Plot of Worst Value

802.11a

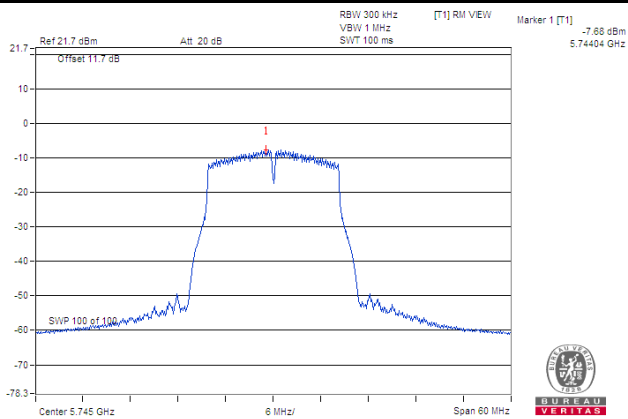

802.11n (HT20)

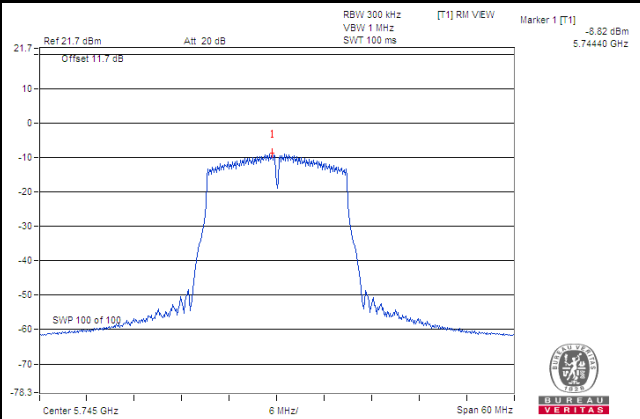

802.11n (HT40)

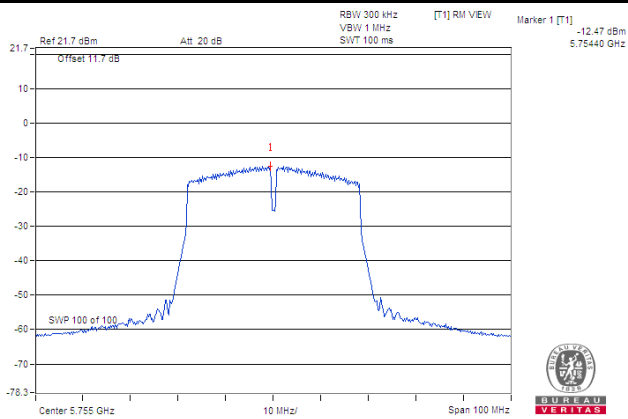

802.11ac (VHT80)

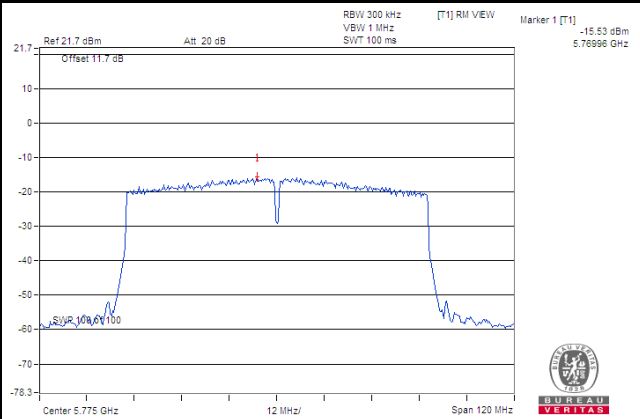

4.6 Frequency Stability

4.6.1 Limit of Frequency Stability Measurement

The frequency of the carrier signal shall be maintained within band of operation.

4.6.2 Test Setup

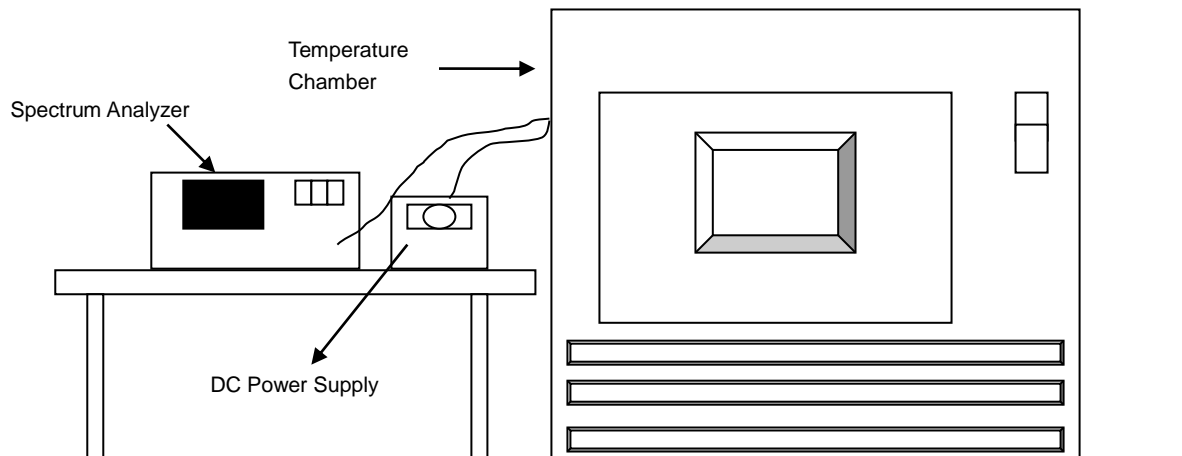

4.6.3 Test Instruments

Refer to section 4.1.3 to get information of above instrument.

4.6.4 Test Procedure

- The EUT was placed inside the environmental test chamber and powered by nominal DC voltage.
- Turn the EUT on and couple its output to a spectrum analyzer.
- Turn the EUT off and set the chamber to the highest temperature specified.
- Allow sufficient time (approximately 30 min) for the temperature of the chamber to stabilize, turn the EUT on and measure the operating frequency after 2, 5, and 10 Minutes.
- Repeat step c and d with every 10 degrees reduction until the lowest temperature achieved.
- The test chamber was allowed to stabilize at +20 degree C for a minimum of 30 Minutes. The supply voltage was then adjusted on the EUT from 85% to 115% and the frequency record.

4.6.5 Deviation from Test Standard

No deviation.

4.6.6 EUT Operating Condition

Set the EUT transmit at un-modulation mode to test frequency stability.

4.6.7 Test Results

Frequency Stability Versus Temp.									
Operating Frequency: 5180 MHz									
Temp. (°C)	Power Supply (Vdc)	0 Minute		2 Minute		5 Minute		10 Minute	
		Measured Frequency (MHz)	Frequency Drift (ppm)	Measured Frequency (MHz)	Frequency Drift (ppm)	Measured Frequency (MHz)	Frequency Drift (ppm)	Measured Frequency (MHz)	Frequency Drift (ppm)
55	3.8	5180.024	PASS	5180.0219	PASS	5180.0241	PASS	5180.023	PASS
50	3.8	5180.0219	PASS	5180.0221	PASS	5180.0224	PASS	5180.0183	PASS
40	3.8	5179.9944	PASS	5179.9973	PASS	5179.9971	PASS	5179.9937	PASS
30	3.8	5180.0215	PASS	5180.0211	PASS	5180.024	PASS	5180.0228	PASS
20	3.8	5180.0076	PASS	5180.0049	PASS	5180.0067	PASS	5180.0084	PASS
10	3.8	5180.0156	PASS	5180.0156	PASS	5180.0132	PASS	5180.0114	PASS
0	3.8	5180.0087	PASS	5180.006	PASS	5180.0039	PASS	5180.005	PASS
-10	3.8	5179.9821	PASS	5179.9796	PASS	5179.9819	PASS	5179.9773	PASS
-20	3.8	5180.0235	PASS	5180.0279	PASS	5180.0239	PASS	5180.0279	PASS
-25	3.8	5179.987	PASS	5179.9862	PASS	5179.9857	PASS	5179.9853	PASS

Frequency Stability Versus Voltage									
Operating Frequency: 5180 MHz									
Temp. (°C)	Power Supply (Vdc)	0 Minute		2 Minute		5 Minute		10 Minute	
		Measured Frequency (MHz)	Frequency Drift (ppm)	Measured Frequency (MHz)	Frequency Drift (ppm)	Measured Frequency (MHz)	Frequency Drift (ppm)	Measured Frequency (MHz)	Frequency Drift (ppm)
20	4.37	5180.0071	PASS	5180.0056	PASS	5180.0062	PASS	5180.0089	PASS
	3.8	5180.0076	PASS	5180.0049	PASS	5180.0067	PASS	5180.0084	PASS
	3.23	5180.0076	PASS	5180.005	PASS	5180.0058	PASS	5180.0085	PASS

4.7 6 dB Bandwidth Measurement

4.7.1 Limits of 6 dB Bandwidth Measurement

The minimum of 6 dB Bandwidth Measurement is 0.5 MHz.

4.7.2 Test Setup

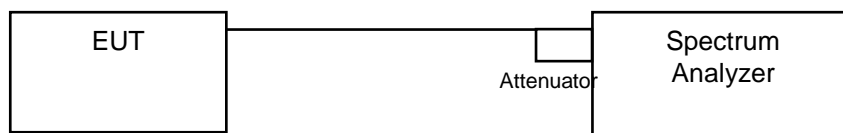

4.7.3 Test Instruments

Refer to section 4.1.3 to get information of above instrument.

4.7.4 Test Procedure

MEASUREMENT PROCEDURE REF

- Set resolution bandwidth (RBW) = 100 kHz
- Set the video bandwidth (VBW) $\geq 3 \times$ RBW, Detector = Peak.
- Trace mode = max hold.
- Sweep = auto couple.
- Measure the maximum width of the emission that is constrained by the frequencies associated with the two amplitude points (upper and lower) that are attenuated by 6 dB relative to the maximum level measured in the fundamental emission

4.7.5 Deviation from Test Standard

No deviation.

4.7.6 EUT Operating Condition

The software provided by client to enable the EUT under transmission condition continuously at lowest, middle and highest channel frequencies individually.

4.7.7 Test Results

802.11a

Channel	Frequency (MHz)	6 dB Bandwidth (MHz)	Minimum Limit (MHz)	Pass / Fail
149	5745	15.12	0.5	Pass
157	5785	15.15	0.5	Pass
165	5825	15.16	0.5	Pass

802.11n (HT20)

Channel	Frequency (MHz)	6 dB Bandwidth (MHz)	Minimum Limit (MHz)	Pass / Fail
149	5745	15.14	0.5	Pass
157	5785	15.17	0.5	Pass
165	5825	15.17	0.5	Pass

802.11n (HT40)

Channel	Frequency (MHz)	6 dB Bandwidth (MHz)	Minimum Limit (MHz)	Pass / Fail
151	5755	35.24	0.5	Pass
159	5795	35.27	0.5	Pass

802.11ac (VHT80)

Channel	Frequency (MHz)	6 dB Bandwidth (MHz)	Minimum Limit (MHz)	Pass / Fail
155	5775	75.45	0.5	Pass

Spectrum Plot of Worst Value

802.11a

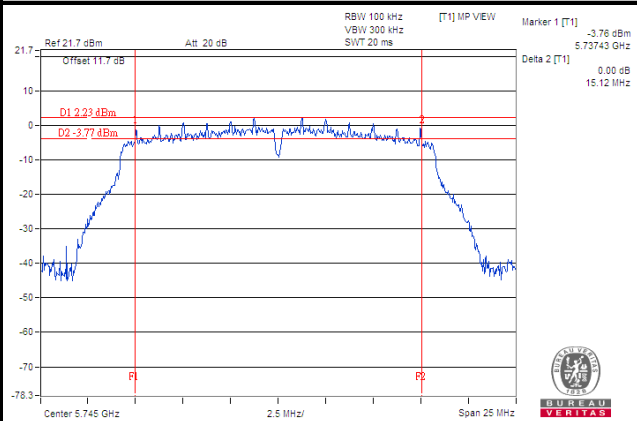

802.11n (HT20)

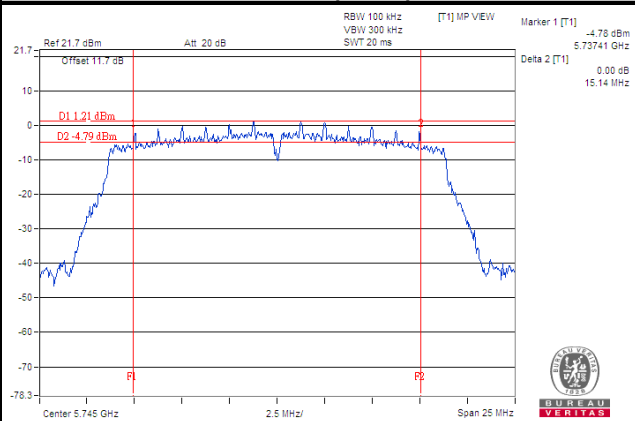

802.11n (HT40)

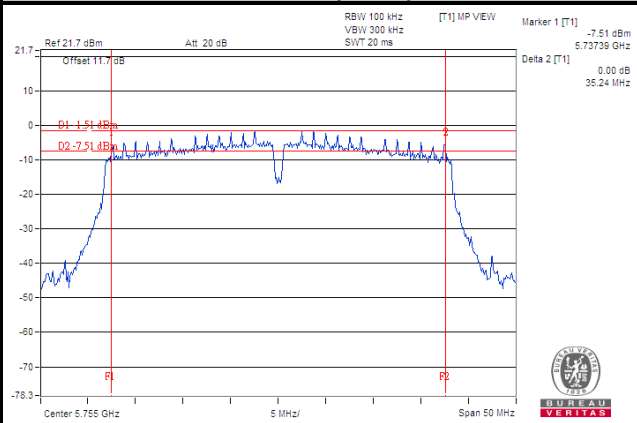

802.11ac (VHT80)

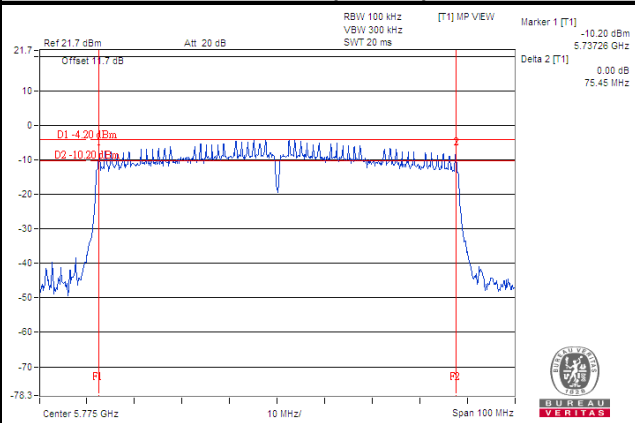

5 Pictures of Test Arrangements

Please refer to the attached file (Test Setup Photo).

Annex A- Radiated Out of Band Emission (OOBE) Measurement (For U-NII-3 band)

802.11a

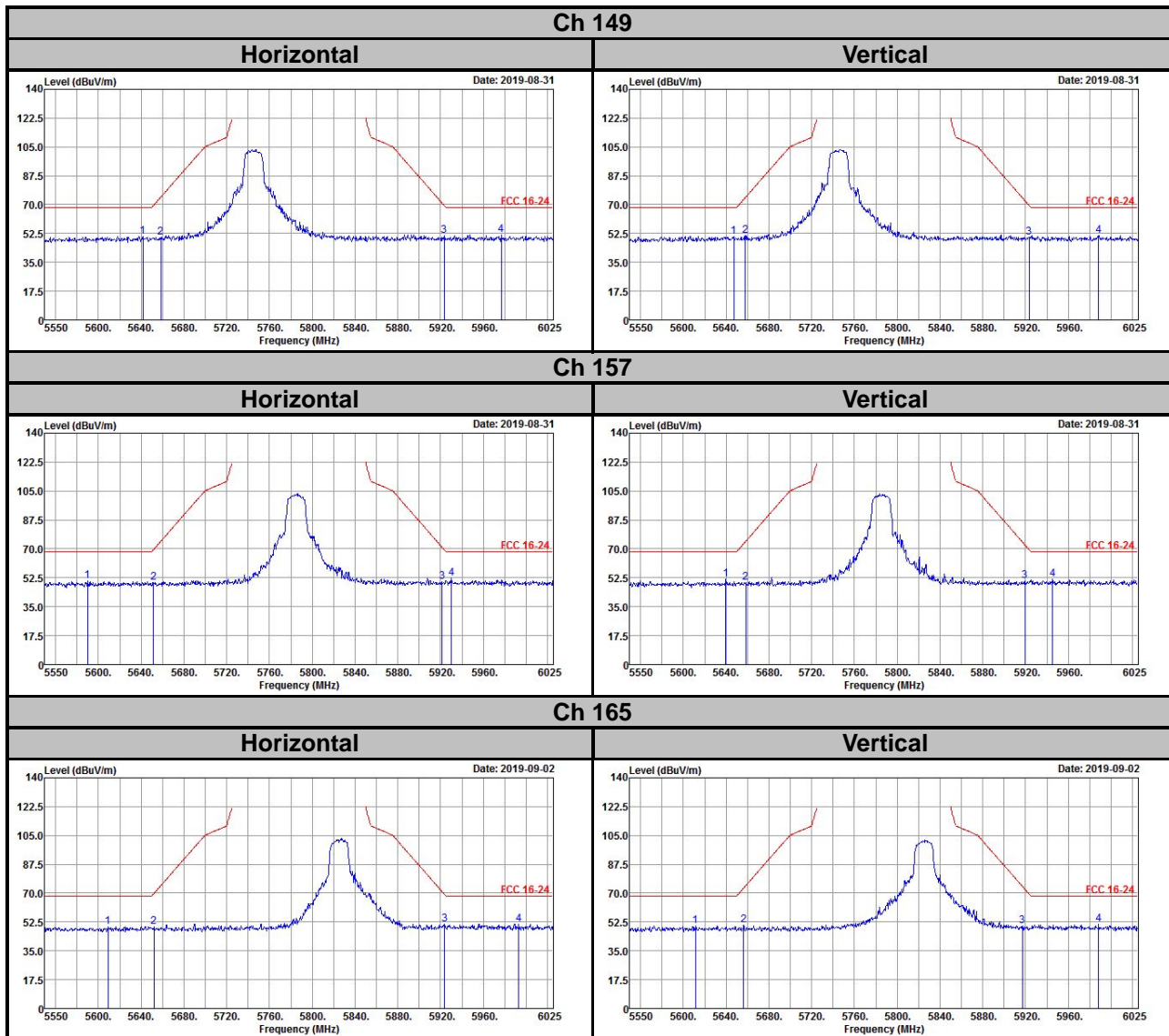

802.11n (HT20)

Ch 149

Horizontal

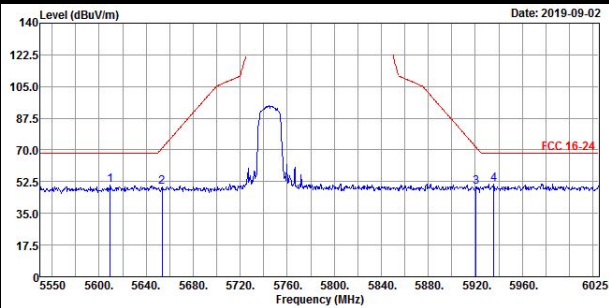

Vertical

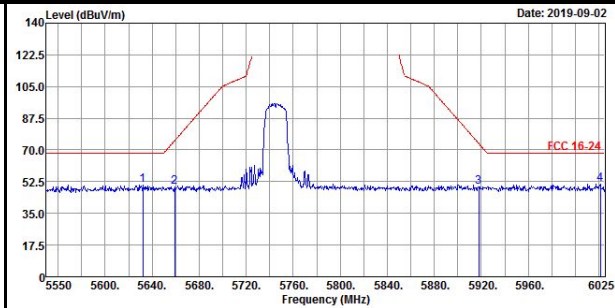

Ch 157

Horizontal

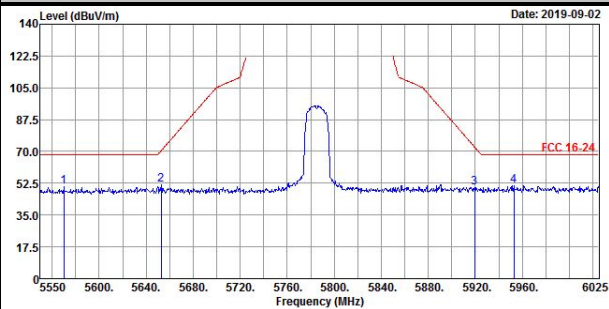

Vertical

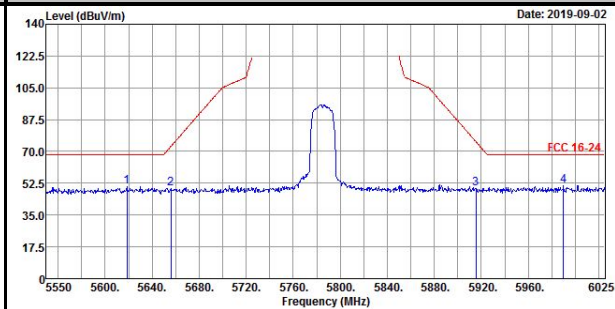

Ch 165

Horizontal

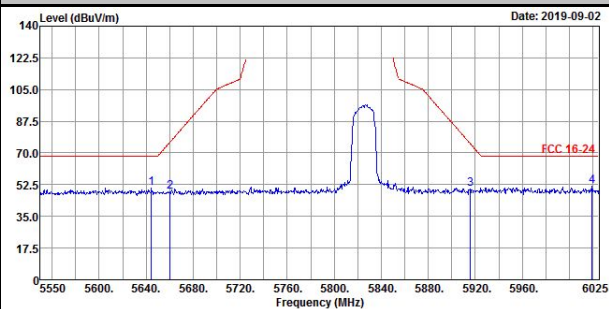

Vertical

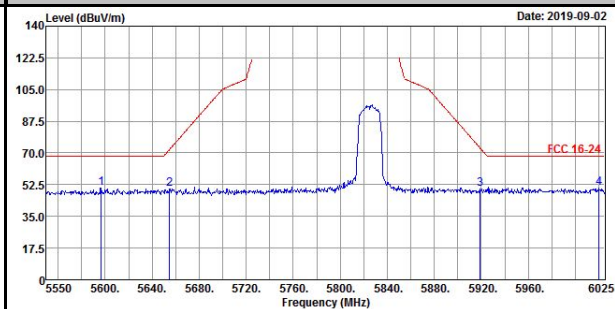

802.11n (HT40)

Ch 151

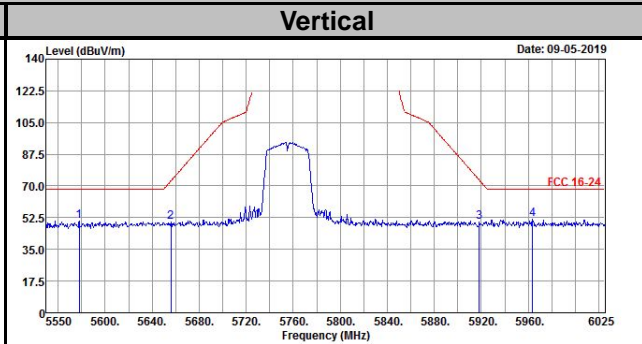
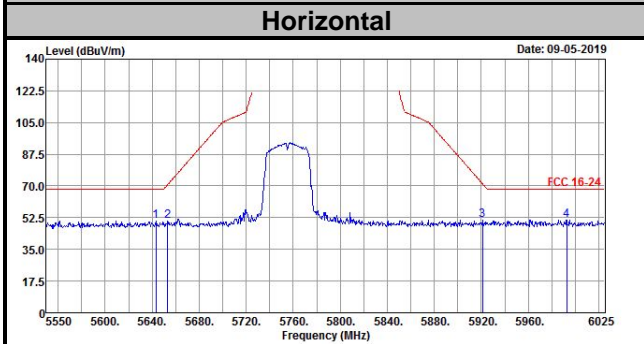

Ch 159

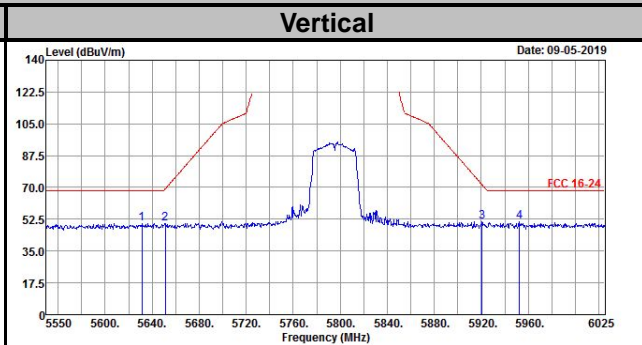
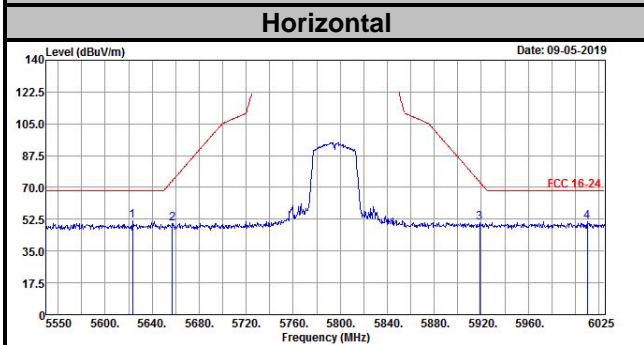

802.11ac (VHT80)

Ch 155

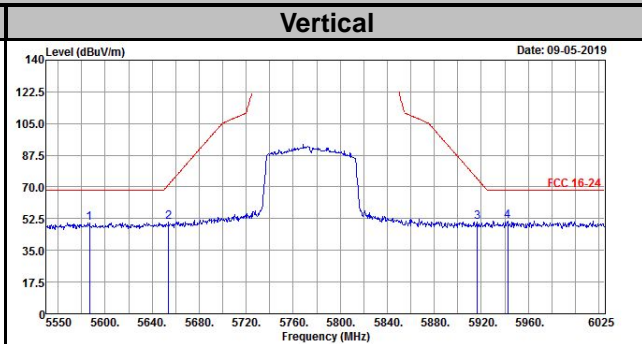
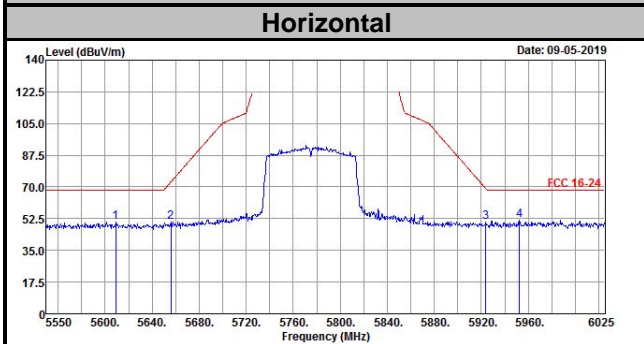

Appendix – Information of the Testing Laboratories

We, Bureau Veritas Consumer Products Services (H.K.) Ltd., Taoyuan Branch, were founded in 1988 to provide our best service in EMC, Radio, Telecom and Safety consultation. Our laboratories are FCC recognized accredited test firms and accredited according to ISO/IEC 17025.

If you have any comments, please feel free to contact us at the following:

Lin Kou EMC/RF Lab

Tel: 886-2-26052180

Fax: 886-2-26051924

Hsin Chu EMC/RF/Telecom Lab

Tel: 886-3-6668565

Fax: 886-3-6668323

Hwa Ya EMC/RF/Safety Lab

Tel: 886-3-3183232

Fax: 886-3-3270892

Email: service.adt@tw.bureauveritas.com

Web Site: www.bureauveritas-adt.com

The address and road map of all our labs can be found in our web site also.

--- END ---