

FCC SAR Test Report

Report No. : SA190723C05
Applicant : Bullitt Group
Address : One Valpy, Valpy Street, Reading, RG1 1AR, Berkshire, UK
Product : Rugged Smart Phone
FCC ID : ZL5S52E
Brand : CAT
Model No. : S52
Standards : FCC 47 CFR Part 2 (2.1093), IEEE C95.1:1992, IEEE Std 1528:2013
KDB 865664 D01 v01r04, KDB 865664 D02 v01r02, KDB 248227 D01 v02r02,
KDB 447498 D01 v06, KDB 648474 D04 v01r03, KDB 941225 D01 v03r01,
KDB 941225 D05 v02r05, KDB 941225 D05A v01r02, KDB 941225 D06 v02r01,
Sample Received Date : Jul. 23, 2019
Date of Testing : Aug. 16, 2019 ~ Oct. 11, 2019
Lab Address : No. 47-2, 14th Ling, Chia Pau Vil., Lin Kou Dist., New Taipei City, Taiwan
Test Location : No. 19, Hwa Ya 2nd Rd., Wen Hwa Vil., Kwei Shan Dist., Taoyuan City, Taiwan

CERTIFICATION: The above equipment have been tested by **Bureau Veritas Consumer Products Services (H.K.) Ltd., Taoyuan Branch–Lin Kou Laboratories**, and found compliance with the requirement of the above standards. The test record, data evaluation & Equipment Under Test (EUT) configurations represented herein are true and accurate accounts of the measurements of the sample's SAR characteristics under the conditions specified in this report. It should not be reproduced except in full, without the written approval of our laboratory. The client should not use it to claim product certification, approval, or endorsement by TAF or any government agencies.

Prepared By :



Rona Chen / Specialist

Approved By :



Gordon Lin / Manager



FCC Accredited No.: TW0003

This report is for your exclusive use. Any copying or replication of this report to or for any other person or entity, or use of our name or trademark, is permitted only with our prior written permission. This report sets forth our findings solely with respect to the test samples identified herein. The results set forth in this report are not indicative or representative of the quality or characteristics of the lot from which a test sample was taken or any similar or identical product unless specifically and expressly noted. Our report includes all of the tests requested by you and the results thereof based upon the information that you provided to us. You have 60 days from date of issuance of this report to notify us of any material error or omission caused by our negligence, provided, however, that such notice shall be in writing and shall specifically address the issue you wish to raise. A failure to raise such issue within the prescribed time shall constitute your unqualified acceptance of the completeness of this report, the tests conducted and the correctness of the report contents. Unless specific mention, the uncertainty of measurement has been explicitly taken into account to declare the compliance or non-compliance to the specification.

Table of Contents

Release Control Record	3
1. Summary of Maximum SAR Value	4
2. Description of Equipment Under Test	5
3. SAR Measurement System	7
3.1 Definition of Specific Absorption Rate (SAR)	7
3.2 SPEAG DASY6 System	7
3.2.1 Robot	8
3.2.2 Probes	9
3.2.3 Data Acquisition Electronics (DAE)	9
3.2.4 Phantoms	9
3.2.5 Device Holder	10
3.2.6 System Validation Dipoles	10
3.2.7 Tissue Simulating Liquids	11
3.3 SAR System Verification	13
3.4 SAR Measurement Procedure	14
3.4.1 Area & Zoom Scan Procedure	14
3.4.2 Volume Scan Procedure	14
3.4.3 Power Drift Monitoring	15
3.4.4 Spatial Peak SAR Evaluation	15
3.4.5 SAR Averaged Methods	15
4. SAR Measurement Evaluation	16
4.1 EUT Configuration and Setting	16
4.2 EUT Testing Position	27
4.2.1 Head Exposure Conditions	27
4.2.2 Body-worn Accessory Exposure Conditions	29
4.2.3 Hotspot Mode Exposure Conditions	30
4.2.4 Product Specific (Phablet) Exposure Conditions	31
4.3 Tissue Verification	32
4.4 System Validation	33
4.5 System Verification	34
4.6 Maximum Output Power	35
4.6.1 Maximum Target Conducted Power	35
4.6.2 Measured Conducted Power Result	41
4.7 SAR Testing Results	55
4.7.1 SAR Test Reduction Considerations	55
4.7.2 SAR Results for Head Exposure Condition	59
4.7.3 SAR Results for Body-worn Exposure Condition (Test Separation Distance is 10 mm)	63
4.7.4 SAR Results for Hotspot Exposure Condition (Test Separation Distance is 10 mm)	66
4.7.5 SAR Results for Product Specific (Phablet) Exposure Condition (Test Separation Distance is 0 mm)	71
4.7.6 SAR Measurement Variability	74
4.7.7 Simultaneous Multi-band Transmission Evaluation	75
5. Calibration of Test Equipment	81
6. Measurement Uncertainty	82
7. Information of the Testing Laboratories	83
Appendix A. SAR Plots of System Verification	
Appendix B. SAR Plots of SAR Measurement	
Appendix C. Calibration Certificate for Probe and Dipole	
Appendix D. Photographs of EUT and Setup	

1. Summary of Maximum SAR Value

Equipment Class	Mode	Highest SAR-1g Head (W/kg)	Highest SAR-1g Body-worn Tested at 10 mm (W/kg)	Highest SAR-1g Hotspot Tested at 10 mm (W/kg)	Highest SAR-10g Product Specific Tested at 0 mm (W/kg)
PCE	GSM850	1.09	0.88	0.88	N/A
	GSM1900	0.02	0.57	0.82	N/A
	WCDMA II	0.05	0.68	0.94	2.59
	WCDMA IV	0.00	0.64	1.02	2.23
	WCDMA V	1.06	0.54	0.54	N/A
	LTE 2	0.07	0.66	1.14	3.39
	LTE 4	0.01	0.69	0.85	2.02
	LTE 5	1.08	0.44	0.44	N/A
	LTE 7	0.15	0.80	0.80	N/A
LTE 38	0.10	0.53	0.53	N/A	
DTS	2.4G WLAN	0.73	0.14	0.14	N/A
NII	5.2G WLAN	N/A	N/A	0.23	N/A
	5.3G WLAN	0.74	0.18	N/A	0.44
	5.6G WLAN	0.55	0.11	N/A	0.50
	5.8G WLAN	0.58	0.08	0.08	N/A
DSS	Bluetooth	0.18	0.05	0.05	N/A
DXX	NFC	N/A	N/A	N/A	N/A

Highest Simultaneous Transmission SAR	Highest SAR-1g Head (W/kg)	Highest SAR-1g Body-worn Tested at 10 mm (W/kg)	Highest SAR-1g Hotspot Tested at 10 mm (W/kg)	Highest SAR-10g Product Specific Tested at 0 mm (W/kg)
	1.59	1.06	1.14	3.89

Note:

- The SAR criteria (**Head & Body: SAR-1g 1.6 W/kg, and Extremity: SAR-10g 4.0 W/kg**) for general population/uncontrolled exposure is specified in FCC 47 CFR part 2 (2.1093) and ANSI/IEEE C95.1-1992.

2. Description of Equipment Under Test

EUT Type	Rugged Smart Phone
FCC ID	ZL5S52E
Brand Name	CAT
Model Name	S52
EUT Configurations	EUT 1 : EUT with Dual SIM EUT 2 : EUT with Single SIM
Tx Frequency Bands (Unit: MHz)	GSM850 : 824.2 ~ 848.8 GSM1900 : 1850.2 ~ 1909.8 WCDMA Band II : 1852.4 ~ 1907.6 WCDMA Band IV : 1712.4 ~ 1752.6 WCDMA Band V : 826.4 ~ 846.6 LTE Band 2 : 1850.7 ~ 1909.3 (BW: 1.4M, 3M, 5M, 10M, 15M, 20M) LTE Band 4 : 1710.7 ~ 1754.3 (BW: 1.4M, 3M, 5M, 10M, 15M, 20M) LTE Band 5 : 824.7 ~ 848.3 (BW: 1.4M, 3M, 5M, 10M) LTE Band 7 : 2502.5 ~ 2567.5 (BW: 5M, 10M, 15M, 20M) LTE Band 38 : 2572.5 ~ 2617.5 (BW: 5M, 10M, 15M, 20M) WLAN : 2412 ~ 2462, 5180 ~ 5240, 5260 ~ 5320, 5500 ~ 5720, 5745 ~ 5825 Bluetooth : 2402 ~ 2480 NFC : 13.56
Uplink Modulations	GSM & GPRS : GMSK EDGE : 8PSK WCDMA : QPSK LTE : QPSK, 16QAM, 64QAM 802.11b : DSSS 802.11a/g/n/ac : OFDM Bluetooth : GFSK, $\pi/4$ -DQPSK, 8-DPSK NFC : ASK
Maximum Tune-up Conducted Power (Unit: dBm)	Please refer to section 4.6.1 of this report
Antenna Type	Fixed Internal Antenna
EUT Stage	Engineering Sample

Note:

- The EUT contains two samples listed as below.

Sample	Configuration	Description
1	EUT with Dual SIM	The difference between these two samples is SIM Tray.
2	EUT with Single SIM	

- Antenna supported band information.

Antenna	Support Band
WWAN Ant-1	GSM850 / 1900, WCDMA II / IV / V, LTE B2 / 4 / 5
WWAN Ant-2	LTE B7 / 38
WWAN Ant-3	GSM850, WCDMA V, LTE B5
WLAN/BT	WLAN 2.4G / 5G / BT

FCC SAR Test Report

3. WWAN Operating mode

Power Table	Test Scenario	Antenna	Receiver	Hotspot	G Sensor	WiFi
Full	Stable (No test required)	Ant 1/2/3	NA	NA	NA	NA
Full	Head Standalone/Combine	Ant 1/2	on	off	on	on
Down	Head standalone	Ant 3	on	off	on	off
Down	Head combine	Ant 3	on	off	on	on
Down	Body-worn / Extremity Standalone / Combine	Ant 1/2	off	off	on	off
Down	Body-worn / Extremity Standalone / Combine	Ant 3	off	off	on	off
Down	Hotspot Standalone / Combine	Ant 1/2	NA	on	NA	NA
Down	Hotspot Standalone / Combine	Ant 3	NA	on	NA	NA

4. The above EUT information is declared by manufacturer and for more detailed features description please refers to the manufacturer's specifications or User's Manual.

List of Accessory:

Battery	Model Name	APP00307
	Manufacturer	APack Technology Co., LTD.
	Power Rating	3.8Vdc, 3000mAh
	Type	Li-ion

3. SAR Measurement System

3.1 Definition of Specific Absorption Rate (SAR)

SAR is related to the rate at which energy is absorbed per unit mass in an object exposed to a radio field. The SAR distribution in a biological body is complicated and is usually carried out by experimental techniques or numerical modeling. The standard recommends limits for two tiers of groups, occupational/controlled and general population/uncontrolled, based on a person's awareness and ability to exercise control over his or her exposure. In general, occupational/controlled exposure limits are higher than the limits for general population/uncontrolled.

The SAR definition is the time derivative (rate) of the incremental energy (dW) absorbed by (dissipated in) an incremental mass (dm) contained in a volume element (dv) of a given density (ρ). The equation description is as below:

$$\text{SAR} = \frac{d}{dt} \left(\frac{dW}{dm} \right) = \frac{d}{dt} \left(\frac{dW}{\rho dv} \right)$$

SAR is expressed in units of Watts per kilogram (W/kg)

SAR measurement can be related to the electrical field in the tissue by

$$\text{SAR} = \frac{\sigma |E|^2}{\rho}$$

Where: σ is the conductivity of the tissue, ρ is the mass density of the tissue and E is the RMS electrical field strength.

3.2 SPEAG DASY6 System

DASY6 system consists of high precision robot, probe alignment sensor, phantom, robot controller, controlled measurement server and near-field probe. The robot includes six axes that can move to the precision position of the DASY6 software defined. The DASY6 software can define the area that is detected by the probe. The robot is connected to controlled box. Controlled measurement server is connected to the controlled robot box. The DAE includes amplifier, signal multiplexing, AD converter, offset measurement and surface detection. It is connected to the Electro-optical coupler (ECO). The ECO performs the conversion from the optical into digital electric signal of the DAE and transfers data to the PC.

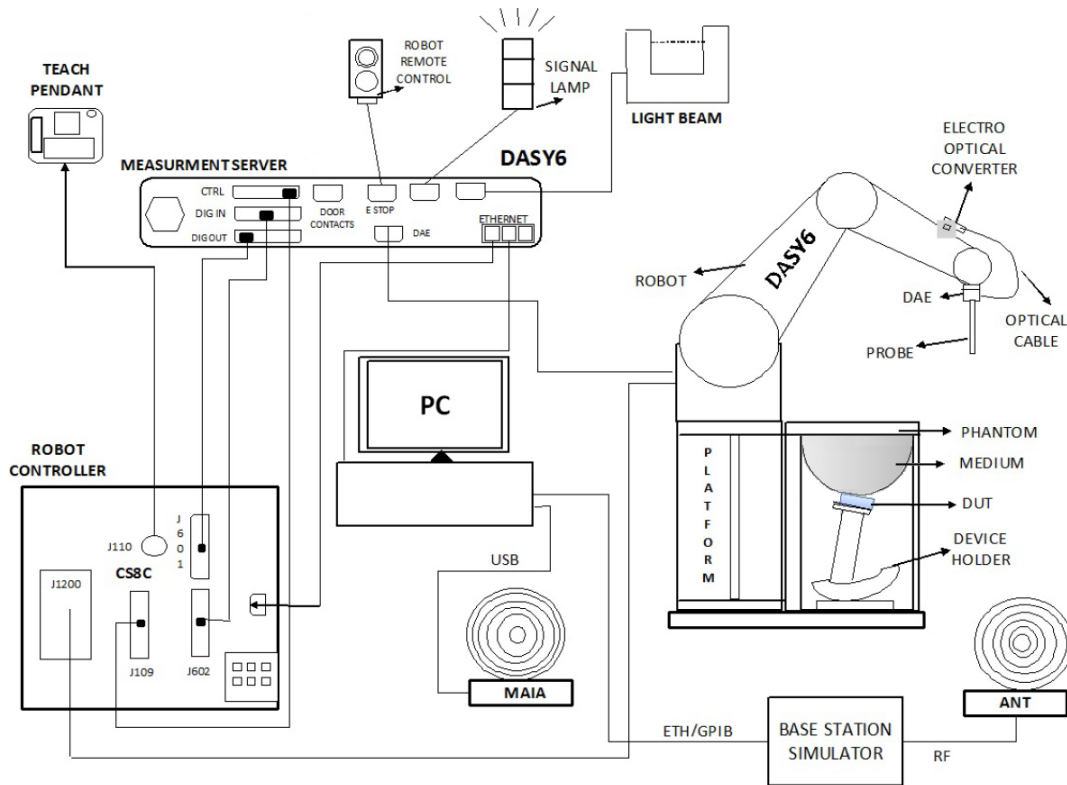

Fig-3.1 SPEAG DASY6 System Setup

3.2.1 Robot

The DASY6 systems use the high precision robots from Stäubli SA (France). For the 6-axis controller system, the robot controller version of CS8c from Stäubli is used. The Stäubli robot series have many features that are important for our application:

- High precision (repeatability ± 0.035 mm)
- High reliability (industrial design)
- Jerk-free straight movements
- Low ELF interference (the closed metallic construction shields against motor control fields)

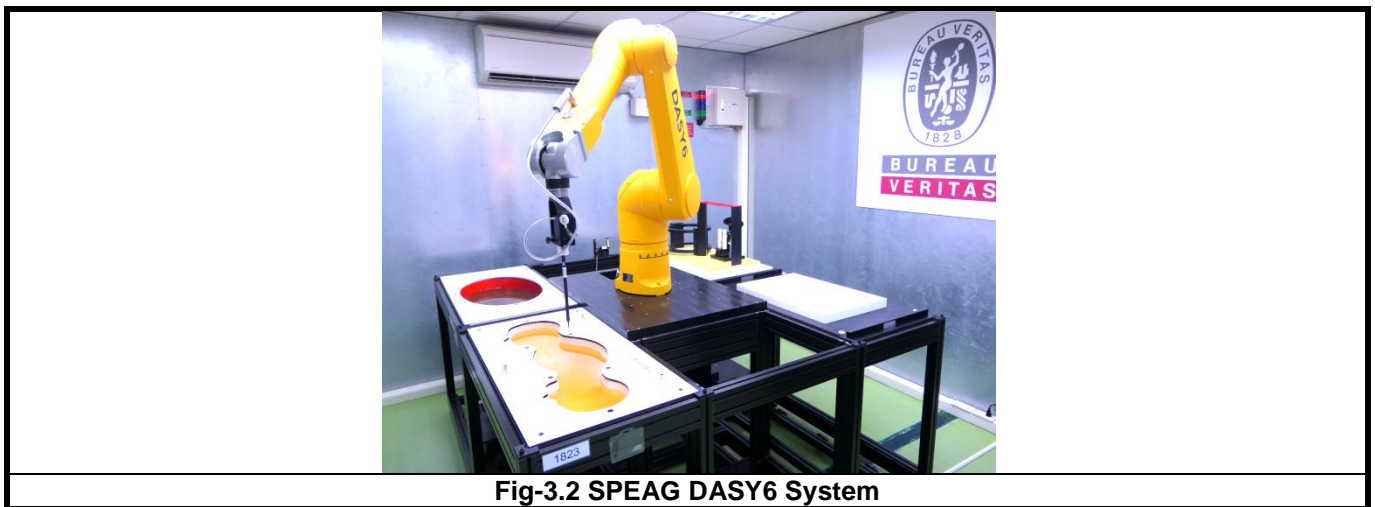



Fig-3.2 SPEAG DASY6 System

FCC SAR Test Report

3.2.2 Probes

The SAR measurement is conducted with the dosimetric probe. The probe is specially designed and calibrated for use in liquid with high permittivity. The dosimetric probe has special calibration in liquid at different frequency.

Model	EX3DV4	
Construction	Symmetrical design with triangular core. Built-in shielding against static charges. PEEK enclosure material (resistant to organic solvents, e.g., DGBE).	
Frequency	4 MHz to 10 GHz Linearity: ± 0.2 dB	
Directivity	± 0.1 dB in TSL (rotation around probe axis) ± 0.3 dB in TSL (rotation normal to probe axis)	
Dynamic Range	10 μ W/g to 100 mW/g Linearity: ± 0.2 dB (noise: typically < 1 μ W/g)	
Dimensions	Overall length: 337 mm (Tip: 20 mm) Tip diameter: 2.5 mm (Body: 12 mm) Typical distance from probe tip to dipole centers: 1 mm	

3.2.3 Data Acquisition Electronics (DAE)

Model	DAE3, DAE4	
Construction	Signal amplifier, multiplexer, A/D converter and control logic. Serial optical link for communication with DASY embedded system (fully remote controlled). Two step probe touch detector for mechanical surface detection and emergency robot stop.	
Measurement Range	-100 to +300 mV (16 bit resolution and two range settings: 4mV, 400mV)	
Input Offset Voltage	< 5 μ V (with auto zero)	
Input Bias Current	< 50 fA	
Dimensions	60 x 60 x 68 mm	

3.2.4 Phantoms

Model	Twin SAM	
Construction	The shell corresponds to the specifications of the Specific Anthropomorphic Mannequin (SAM) phantom defined in IEEE 1528 and IEC 62209-1. It enables the dosimetric evaluation of left and right hand phone usage as well as body mounted usage at the flat phantom region. A cover prevents evaporation of the liquid. Reference markings on the phantom allow the complete setup of all predefined phantom positions and measurement grids by teaching three points with the robot.	
Material	Vinylester, glass fiber reinforced (VE-GF)	
Shell Thickness	2 ± 0.2 mm (6 ± 0.2 mm at ear point)	
Dimensions	Length: 1000 mm Width: 500 mm Height: adjustable feet	
Filling Volume	approx. 25 liters	

FCC SAR Test Report

Model	ELI	
Construction	Phantom for compliance testing of handheld and body-mounted wireless devices in the frequency range of 30 MHz to 6 GHz. ELI is fully compatible with the IEC 62209-2 standard and all known tissue simulating liquids. ELI has been optimized regarding its performance and can be integrated into our standard phantom tables. A cover prevents evaporation of the liquid. Reference markings on the phantom allow installation of the complete setup, including all predefined phantom positions and measurement grids, by teaching three points. The phantom is compatible with all SPEAG dosimetric probes and dipoles.	
Material	Vinylester, glass fiber reinforced (VE-GF)	
Shell Thickness	2.0 ± 0.2 mm (bottom plate)	
Dimensions	Major axis: 600 mm Minor axis: 400 mm	
Filling Volume	approx. 30 liters	

3.2.5 Device Holder

Model	Mounting Device	
Construction	In combination with the Twin SAM Phantom or ELI4, the Mounting Device enables the rotation of the mounted transmitter device in spherical coordinates. Rotation point is the ear opening point. Transmitter devices can be easily and accurately positioned according to IEC, IEEE, FCC or other specifications. The device holder can be locked for positioning at different phantom sections (left head, right head, flat).	
Material	POM	

Model	Laptop Extensions Kit	
Construction	Simple but effective and easy-to-use extension for Mounting Device that facilitates the testing of larger devices according to IEC 62209-2 (e.g., laptops, cameras, etc.). It is lightweight and fits easily on the upper part of the Mounting Device in place of the phone positioner.	
Material	POM, Acrylic glass, Foam	

3.2.6 System Validation Dipoles

Model	D-Serial	
Construction	Symmetrical dipole with 1/4 balun. Enables measurement of feedpoint impedance with NWA. Matched for use near flat phantoms filled with tissue simulating solutions.	
Frequency	750 MHz to 5800 MHz	
Return Loss	> 20 dB	
Power Capability	> 100 W (f < 1GHz), > 40 W (f > 1GHz)	

3.2.7 Tissue Simulating Liquids

For SAR measurement of the field distribution inside the phantom, the phantom must be filled with homogeneous tissue simulating liquid to a depth of at least 15 cm. For head SAR testing, the liquid height from the ear reference point (ERP) of the phantom to the liquid top surface is larger than 15 cm. For body SAR testing, the liquid height from the center of the flat phantom to the liquid top surface is larger than 15 cm. The nominal dielectric values of the tissue simulating liquids in the phantom and the tolerance of 5% are listed in Table-3.1.

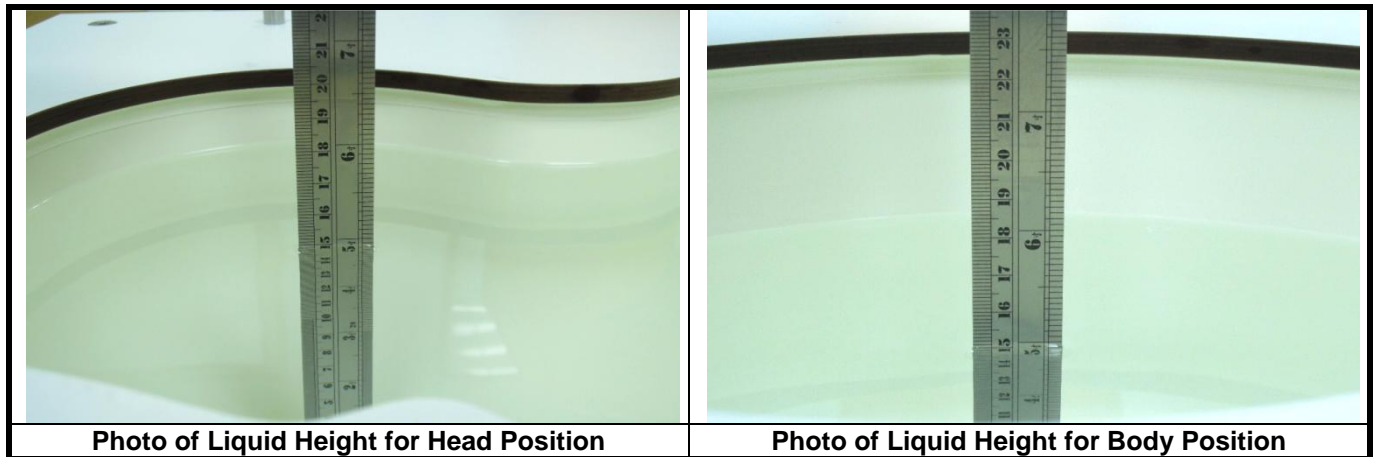

The dielectric properties of the head tissue simulating liquids are defined in IEEE1528, and KDB 865664 D01 Appendix A. For the body tissue simulating liquids, the dielectric properties are defined in KDB 865664 D01 Appendix A. The dielectric properties of the tissue simulating liquids were verified prior to the SAR evaluation using a dielectric assessment kit and a network analyzer.

Table-3.1 Targets of Tissue Simulating Liquid

Frequency (MHz)	Target Permittivity	Range of $\pm 5\%$	Target Conductivity	Range of $\pm 5\%$
750	41.9	39.8 ~ 44.0	0.89	0.85 ~ 0.93
835	41.5	39.4 ~ 43.6	0.90	0.86 ~ 0.95
900	41.5	39.4 ~ 43.6	0.97	0.92 ~ 1.02
1450	40.5	38.5 ~ 42.5	1.20	1.14 ~ 1.26
1640	40.3	38.3 ~ 42.3	1.29	1.23 ~ 1.35
1750	40.1	38.1 ~ 42.1	1.37	1.30 ~ 1.44
1800	40.0	38.0 ~ 42.0	1.40	1.33 ~ 1.47
1900	40.0	38.0 ~ 42.0	1.40	1.33 ~ 1.47
2000	40.0	38.0 ~ 42.0	1.40	1.33 ~ 1.47
2300	39.5	37.5 ~ 41.5	1.67	1.59 ~ 1.75
2450	39.2	37.2 ~ 41.2	1.80	1.71 ~ 1.89
2600	39.0	37.1 ~ 41.0	1.96	1.86 ~ 2.06
3500	37.9	36.0 ~ 39.8	2.91	2.76 ~ 3.06
5200	36.0	34.2 ~ 37.8	4.66	4.43 ~ 4.89
5300	35.9	34.1 ~ 37.7	4.76	4.52 ~ 5.00
5500	35.6	33.8 ~ 37.4	4.96	4.71 ~ 5.21
5600	35.5	33.7 ~ 37.3	5.07	4.82 ~ 5.32
5800	35.3	33.5 ~ 37.1	5.27	5.01 ~ 5.53

The following table gives the recipes for tissue simulating liquids.

Table-3.2 Recipes of Tissue Simulating Liquid

Tissue Type	Bactericide	DGBE	HEC	NaCl	Sucrose	Triton X-100	Water	Diethylene Glycol Mono-hexylether
H750	0.2	-	0.2	1.5	56.0	-	42.1	-
H835	0.2	-	0.2	1.5	57.0	-	41.1	-
H900	0.2	-	0.2	1.4	58.0	-	40.2	-
H1450	-	43.3	-	0.6	-	-	56.1	-
H1640	-	45.8	-	0.5	-	-	53.7	-
H1750	-	47.0	-	0.4	-	-	52.6	-
H1800	-	44.5	-	0.3	-	-	55.2	-
H1900	-	44.5	-	0.2	-	-	55.3	-
H2000	-	44.5	-	0.1	-	-	55.4	-
H2300	-	44.9	-	0.1	-	-	55.0	-
H2450	-	45.0	-	0.1	-	-	54.9	-
H2600	-	45.1	-	0.1	-	-	54.8	-
H3500	-	8.0	-	0.2	-	20.0	71.8	-
H5G	-	-	-	-	-	17.2	65.5	17.3

3.3 SAR System Verification

The system check verifies that the system operates within its specifications. It is performed daily or before every SAR measurement. The system check uses normal SAR measurements in the flat section of the phantom with a matched dipole at a specified distance. The system verification setup is shown as below.

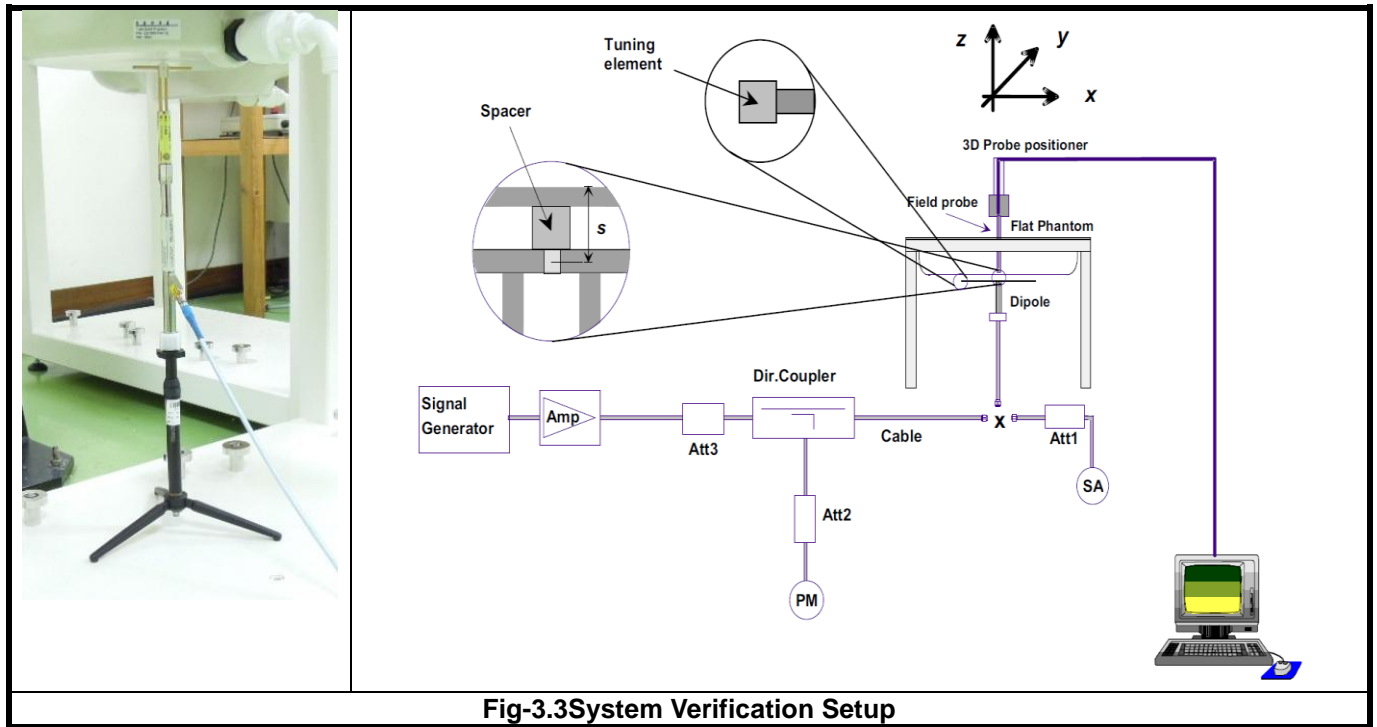

Fig-3.3 System Verification Setup

The validation dipole is placed beneath the flat phantom with the specific spacer in place. The distance spacer is touch the phantom surface with a light pressure at the reference marking and be oriented parallel to the long side of the phantom. The spectrum analyzer measures the forward power at the location of the system check dipole connector. The signal generator is adjusted for the desired forward power (250 mW is used for 700 MHz to 3 GHz, 100 mW is used for 3.5 GHz to 6 GHz) at the dipole connector and the power meter is read at that level. After connecting the cable to the dipole, the signal generator is readjusted for the same reading at power meter.

After system check testing, the SAR result will be normalized to 1W forward input power and compared with the reference SAR value derived from validation dipole certificate report. The deviation of system check should be within 10 %.

3.4 SAR Measurement Procedure

According to the SAR test standard, the recommended procedure for assessing the peak spatial-average SAR value consists of the following steps:

- (a) Power reference measurement
- (b) Area scan
- (c) Zoom scan
- (d) Power drift measurement

The SAR measurement procedures for each of test conditions are as follows:

- (a) Make EUT to transmit maximum output power
- (b) Measure conducted output power through RF cable
- (c) Place the EUT in the specific position of phantom
- (d) Perform SAR testing steps on the DASY system
- (e) Record the SAR value

3.4.1 Area & Zoom Scan Procedure

First Area Scan is used to locate the approximate location(s) of the local peak SAR value(s). The measurement grid within an Area Scan is defined by the grid extent, grid step size and grid offset. Next, in order to determine the EM field distribution in a three-dimensional spatial extension, Zoom Scan is required. The Zoom Scan is performed around the highest E-field value to determine the averaged SAR-distribution over 10 g. According to KDB 865664D01, the resolution for Area and Zoom scan is specified in the table below.

Items	<= 2 GHz	2-3 GHz	3-4 GHz	4-5 GHz	5-6 GHz
Area Scan ($\Delta x, \Delta y$)	<= 15 mm	<= 12 mm	<= 12 mm	<= 10 mm	<= 10 mm
Zoom Scan ($\Delta x, \Delta y$)	<= 8 mm	<= 5 mm	<= 5 mm	<= 4 mm	<= 4 mm
Zoom Scan (Δz)	<= 5 mm	<= 5 mm	<= 4 mm	<= 3 mm	<= 2 mm
Zoom Scan Volume	>= 30 mm	>= 30 mm	>= 28 mm	>= 25 mm	>= 22 mm

Note:

When zoom scan is required and report SAR is <=1.4 W/kg, the zoom scan resolution of $\Delta x / \Delta y$ (2-3GHz: <= 8 mm, 3-4GHz: <= 7 mm, 4-6GHz: <= 5 mm) may be applied.

3.4.2 Volume Scan Procedure

The volume scan is used for assess overlapping SAR distributions for antennas transmitting in different frequency bands. It is equivalent to an oversized zoom scan used in standalone measurements. The measurement volume will be used to enclose all the simultaneous transmitting antennas. For antennas transmitting simultaneously in different frequency bands, the volume scan is measured separately in each frequency band. In order to sum correctly to compute the 1g aggregate SAR, the EUT remain in the same test position for all measurements and all volume scan use the same spatial resolution and grid spacing. When all volume scan were completed, the software, SEMCAD postprocessor can combine and subsequently superpose these measurement data to calculating the multiband SAR.

3.4.3 Power Drift Monitoring

All SAR testing is under the EUT install full charged battery and transmit maximum output power. In DASY measurement software, the power reference measurement and power drift measurement procedures are used for monitoring the power drift of EUT during SAR test. Both these procedures measure the field at a specified reference position before and after the SAR testing. The software will calculate the field difference in dB. If the power drift more than 5%, the SAR will be retested.

3.4.4 Spatial Peak SAR Evaluation

The procedure for spatial peak SAR evaluation has been implemented according to the test standard. It can be conducted for 1g and 10g, as well as for user-specific masses. The DASY software includes all numerical procedures necessary to evaluate the spatial peak SAR value.

The base for the evaluation is a "cube" measurement. The measured volume must include the 1g and 10g cubes with the highest averaged SAR values. For that purpose, the center of the measured volume is aligned to the interpolated peak SAR value of a previously performed area scan.

The entire evaluation of the spatial peak values is performed within the post-processing engine (SEMCAD). The system always gives the maximum values for the 1g and 10g cubes. The algorithm to find the cube with highest averaged SAR is divided into the following stages:

- (a) Extraction of the measured data (grid and values) from the Zoom Scan
- (b) Calculation of the SAR value at every measurement point based on all stored data (A/D values and measurement parameters)
- (c) Generation of a high-resolution mesh within the measured volume
- (d) Interpolation of all measured values from the measurement grid to the high-resolution grid
- (e) Extrapolation of the entire 3-D field distribution to the phantom surface over the distance from sensor to surface
- (f) Calculation of the averaged SAR within masses of 1g and 10g

3.4.5 SAR Averaged Methods

In DASY, the interpolation and extrapolation are both based on the modified Quadratic Shepard's method. The interpolation scheme combines a least-square fitted function method and a weighted average method which are the two basic types of computational interpolation and approximation.

Extrapolation routines are used to obtain SAR values between the lowest measurement points and the inner phantom surface. The extrapolation distance is determined by the surface detection distance and the probe sensor offset. The uncertainty increases with the extrapolation distance. To keep the uncertainty within 1% for the 1 g and 10 g cubes, the extrapolation distance should not be larger than 5 mm.

4. SAR Measurement Evaluation

4.1 EUT Configuration and Setting

<Connections between EUT and System Simulator>

For WWAN SAR testing, the EUT was linked and controlled by base station emulator. Communication between the EUT and the emulator was established by air link. The distance between the EUT and the communicating antenna of the emulator is larger than 50 cm and the output power radiated from the emulator antenna is at least 30 dB smaller than the output power of EUT. The EUT was set from the emulator to radiate maximum output power during SAR testing.

<Considerations Related to GSM / GPRS / EDGE for Setup and Testing>

The maximum multi-slot capability supported by this device is as below.

1. This EUT is class B device
2. This EUT supports GPRS multi-slot class 12 (max. uplink: 4, max. downlink: 4, total timeslots: 5)
3. This EUT supports EDGE multi-slot class 12 (max. uplink: 4, max. downlink: 4, total timeslots: 5)

For GSM850 frequency band, the power control level is set to 5 for GSM mode and GPRS (GMSK: CS1), and set to 8 for EDGE (GMSK: MCS1, 8PSK: MCS9). For GSM1900 frequency band, the power control level is set to 0 for GSM mode and GPRS (GMSK: CS1), and set to 2 for EDGE (GMSK: MCS1, 8PSK: MCS9).

SAR test reduction for GPRS and EDGE modes is determined by the source-based time-averaged output power specified for production units, including tune-up tolerance. The data mode with highest specified time-averaged output power should be tested for SAR compliance in the applicable exposure conditions. For modes with the same specified maximum output power and tolerance, the higher number time-slot configuration should be tested.

<Considerations Related to WCDMA for Setup and Testing>

WCDMA Handsets Head SAR

SAR for next to the ear head exposure is measured using a 12.2 kbps RMC with TPC bits configured to all "1's". The 3G SAR test reduction procedure is applied to AMR configurations with 12.2 kbps RMC as the primary mode.

WCDMA Handsets Body-worn SAR

SAR for body-worn configurations is measured using a 12.2 kbps RMC with TPC bits configured to all "1's". The 3G SAR test reduction procedure is applied to other spreading codes and multiple DPDCH_n configurations supported by the handset with 12.2 kbps RMC as the primary mode.

Handsets with Release 5 HSDPA

The 3G SAR test reduction procedure is applied to HSDPA body-worn configurations with 12.2 kbps RMC as the primary mode. Otherwise, SAR is measured for HSDPA using the HSDPA body SAR procedures in the "Release 5 HSDPA Data Devices", for the highest reported SAR body-worn exposure configuration in 12.2 kbps RMC. Handsets with both HSDPA and HSUPA are tested according to Release 6 HSPA test procedures.

Handsets with Release 6 HSUPA

The 3G SAR test reduction procedure is applied to HSPA (HSUPA/HSDPA with RMC) body-worn configurations with 12.2 kbps RMC as the primary mode. Otherwise, SAR is measured for HSPA using the HSPA body SAR procedures in the "Release 6 HSPA Data Devices", for the highest reported body-worn exposure SAR configuration in 12.2 kbps RMC. When VOIP is applicable for next to the ear head exposure in HSPA, the 3G SAR test reduction procedure is applied to HSPA with 12.2 kbps RMC as the primary mode; otherwise, the same HSPA configuration used for body-worn measurements is tested for next to the ear head exposure.

Release 5 HSDPA Data Devices

The 3G SAR test reduction procedure is applied to body SAR with 12.2 kbps RMC as the primary mode. Otherwise, body SAR for HSDPA is measured using an FRC with H-Set 1 in Sub-test 1 and a 12.2 kbps RMC configured in Test Loop Mode 1, for the highest reported SAR configuration in 12.2 kbps RMC without HSDPA. HSDPA is configured according to the applicable UE category of a test device. The number of HS-DSCH/HS-PDSCHs, HARQ processes, minimum inter-TTI interval, transport block sizes and RV coding sequence are defined by the H-set. To maintain a consistent test configuration and stable transmission conditions, QPSK is used in the H-set for SAR testing. HS-DPCCH should be configured with a CQI feedback cycle of 4 ms and a CQI repetition factor of 2 to maintain a constant rate of active CQI slots. DPCCH and DPDCH gain factors (β_c , β_d), and HS-DPCCH power offset parameters (Δ_{ACK} , Δ_{NACK} , Δ_{CQI}) are set according to values indicated in below. The CQI value is determined by the UE category, transport block size, number of HS-PDSCHs and modulation used in the H-set.

FCC SAR Test Report

Sub-test	β_c	β_d	β_d (SF)	β_c/β_d	$\beta_{HS}^{(1)(2)}$	CM ⁽³⁾ (dB)	MPR ⁽³⁾ (dB)
1	2/15	15/15	64	2/15	4/15	0.0	0.0
2	12/15 ⁽⁴⁾	15/15 ⁽⁴⁾	64	12/15 ⁽⁴⁾	24/15	1.0	0.0
3	15/15	8/15	64	15/8	30/15	1.5	0.5
4	15/15	4/15	64	15/4	30/15	1.5	0.5

Note 1: Δ_{ACK} , Δ_{NACK} and $\Delta_{CQI} = 30/15$ with $\beta_{HS} = 30/15 * \beta_c$.
 Note 2: For the HS-DPCCH power mask requirement test in clause 5.2C, 5.7A, and the Error Vector Magnitude (EVM) with HS-DPCCH test in clause 5.13.1A, and HSDPA EVM with phase discontinuity in clause 5.13.1AA, Δ_{ACK} and $\Delta_{NACK} = 30/15$ with $\beta_{HS} = 30/15 * \beta_c$, and $\Delta_{CQI} = 24/15$ with $\beta_{HS} = 24/15 * \beta_c$.
 Note 3: CM = 1 for $\beta_c/\beta_d = 12/15, \beta_{HS}/\beta_c = 24/15$. For all other combinations of DPDCH, DPCCH and HS-DPCCH the MPR is based on the relative CM difference. This is applicable for only UEs that support HSDPA in release 6 and later releases.
 Note 4: For subtest 2 the β_c/β_d ratio of 12/15 for the TFC during the measurement period (TF1, TF0) is achieved by setting the signalled gain factors for the reference TFC (TF1, TF1) to $\beta_c = 11/15$ and $\beta_d = 15/15$.

Release 6 HSPA Data Devices

The 3G SAR test reduction procedure is applied to body SAR with 12.2 kbps RMC as the primary mode. Otherwise, body SAR for HSPA is measured with E-DCH Sub-test 5, using H-Set 1 and QPSK for FRC and a 12.2 kbps RMC configured in Test Loop Mode 1 and power control algorithm 2, according to the highest reported body SAR configuration in 12.2 kbps RMC without HSPA. When VOIP applies to head exposure, the 3G SAR test reduction procedure is applied with 12.2 kbps RMC as the primary mode. Otherwise, the same HSPA configuration used for body SAR measurements are applied to head exposure testing. Due to inner loop power control requirements in HSPA, a communication test set is required for output power and SAR tests. The 12.2 kbps RMC, FRC H-set 1 and E-DCH configurations for HSPA are configured according to the β values indicated in below.

Sub-test	β_c	β_d	β_d (SF)	β_c/β_d	$\beta_{HS}^{(1)}$	β_{ec}	$\beta_{ed}^{(4)(5)}$	β_{ed} (SF)	β_{ed} (Codes)	CM ⁽²⁾ (dB)	MPR ⁽²⁾⁽⁶⁾ (dB)	AG ⁽⁵⁾ Index	E-TFCI
1	11/15 ⁽³⁾	15/15 ⁽³⁾	64	11/15 ⁽³⁾	22/15	209/225	1309/225	4	1	1.0	0.0	20	75
2	6/15	15/15	64	6/15	12/15	12/15	94/75	4	1	3.0	2.0	12	67
3	15/15	9/15	64	15/9	30/15	30/15	$\beta_{ed1}: 47/15$ $\beta_{ed2}: 47/15$	4 4	2	2.0	1.0	15	92
4	2/15	15/15	64	2/15	4/15	2/15	56/75	4	1	3.0	2.0	17	71
5	15/15	0	-	-	5/15	5/15	47/15	4	1	1.0	0.0	12	67

Note 1: For sub-test 1 to 4, Δ_{ACK} , Δ_{NACK} and $\Delta_{CQI} = 30/15$ with $\beta_{HS} = 30/15 * \beta_c$. For sub-test 5, Δ_{ACK} , Δ_{NACK} and $\Delta_{CQI} = 5/15$ with $\beta_{HS} = 5/15 * \beta_c$.
 Note 2: CM = 1 for $\beta_c/\beta_d = 12/15, \beta_{HS}/\beta_c = 24/15$. For all other combinations of DPDCH, DPCCH, HS-DPCCH, E-DPCCH and E-DPCCH the MPR is based on the relative CM difference.
 Note 3: For subtest 1 the β_c/β_d ratio of 11/15 for the TFC during the measurement period (TF1, TF0) is achieved by setting the signalled gain factors for the reference TFC (TF1, TF1) to $\beta_c = 10/15$ and $\beta_d = 15/15$.
 Note 4: In case of testing by UE using E-DPDCH Physical Layer category 1, Sub-test 3 is omitted according to TS25.306 Table 5.1g.
 Note 5: β_{ed} can not be set directly; it is set by Absolute Grant Value.
 Note 6: For subtests 2, 3 and 4, UE may perform E-DPDCH power scaling at max power which could result in slightly smaller MPR values.

DC-HSDPA SAR Guidance

The 3G SAR test reduction procedure is applied to DC-HSDPA with 12.2 kbps RMC as the primary mode. Otherwise, when SAR is required for Rel. 5 HSDPA, SAR is required for Rel. 8 DC-HSDPA. Power is measured for DC-HSDPA according to the H-Set 12, FRC configuration in Table C.8.1.12 of 3GPP TS 34.121-1 to determine SAR test reduction. A primary and a secondary serving HS-DSCH Cell are required to perform the power measurement and for the results to be acceptable.

<Considerations Related to LTE for Setup and Testing>

This device contains LTE transmitter which follows 3GPP standards, is category 3, supports both QPSK and QAM modulations, and supported LTE band and channel bandwidth is listed in below. The output power was tested per 3GPP TS 36.521-1 maximum transmit procedures for both QPSK and QAM modulation. The results please refer to section 4.6 of this report.

EUT Supported LTE Band and Channel Bandwidth						
LTE Band	BW 1.4 MHz	BW 3 MHz	BW 5 MHz	BW 10 MHz	BW 15 MHz	BW 20 MHz
2	V	V	V	V	V	V
4	V	V	V	V	V	V
5	V	V	V	V		
7			V	V	V	V
38			V	V	V	V

The LTE maximum power reduction (MPR) in accordance with 3GPP TS 36.101 is active all times during LTE operation. The allowed MPR for the maximum output power is specified in below.

Modulation	Channel Bandwidth / RB Configurations						LTE MPR Setting (dB)
	BW 1.4 MHz	BW 3 MHz	BW 5 MHz	BW 10 MHz	BW 15 MHz	BW 20 MHz	
QPSK	> 5	> 4	> 8	> 12	> 16	> 18	1
16QAM	<= 5	<= 4	<= 8	<= 12	<= 16	<= 18	1
16QAM	> 5	> 4	> 8	> 12	> 16	> 18	2
64QAM	<= 5	<= 4	<= 8	<= 12	<= 16	<= 18	2
64QAM	> 5	> 4	> 8	> 12	> 16	> 18	3

Note: MPR is according to the standard and implemented in the circuit (mandatory).

In addition, the device is compliant with additional maximum power reduction (A-MPR) requirements defined in 3GPP TS 36.101 section 6.2.4 that was disabled for all FCC compliance testing.

During LTE SAR testing, the related parameters of operating band, channel bandwidth, uplink channel number, modulation type, and RB was set in base station simulator. When the EUT has registered and communicated to base station simulator, the simulator set to make EUT transmitting the maximum radiated power.

TDD-LTE Setup Configurations

According to KDB 941225 D05, SAR testing for TDD-LTE device must be tested using a fixed periodic duty factor according to the highest transmission duty factor implemented for the device and supported by the defined 3GPP TDD-LTE configurations. The TDD-LTE of this device supports frame structure type 2 defined in 3GPP TS 36.211 section 4.2, and the frame structure configuration can be referred to below.

FCC SAR Test Report

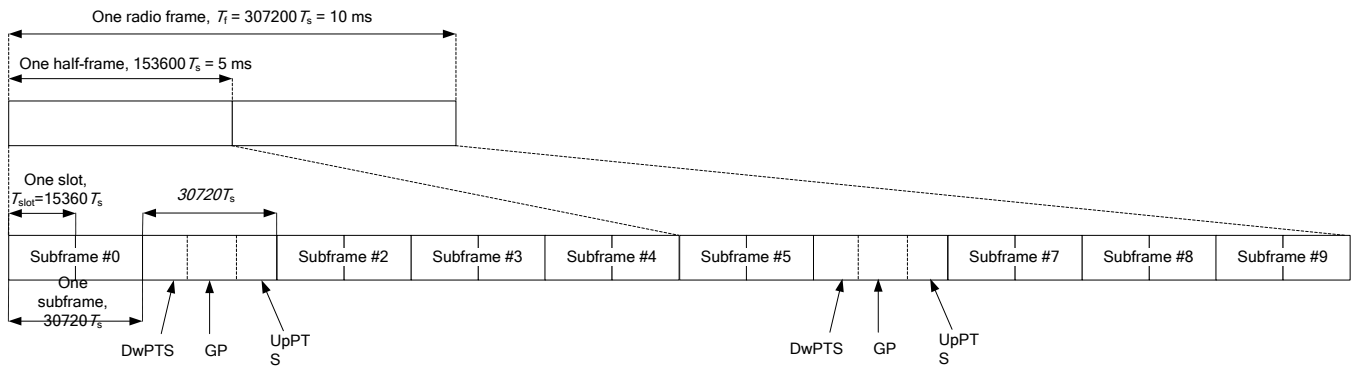

3GPP TS 36.211 Figure 4.2-1: Frame Structure Type 2

Special Subframe Configuration	Normal Cyclic Prefix in Downlink			Extended Cyclic Prefix in Downlink		
	DwPTS	UpPTS		DwPTS	UpPTS	
		Normal Cyclic Prefix in Uplink	Extended Cyclic Prefix in Uplink		Normal Cyclic Prefix in Uplink	Extended Cyclic Prefix in Uplink
0	6592 · Ts	2192 · Ts	2560 · Ts	7680 · Ts	2192 · Ts	2560 · Ts
1	19760 · Ts			20480 · Ts		
2	21952 · Ts			23040 · Ts		
3	24144 · Ts			25600 · Ts		
4	26336 · Ts			7680 · Ts		
5	6592 · Ts	4384 · Ts	5120 · Ts	20480 · Ts	4384 · Ts	5120 · Ts
6	19760 · Ts			23040 · Ts		
7	21952 · Ts			12800 · Ts		
8	24144 · Ts			-		
9	13168 · Ts	-	-	-	-	-

3GPP TS 36.211 Table 4.2-1: Configuration of Special Subframe

Uplink-Downlink Configuration	Downlink-to-Uplink Switch-Point Periodicity	Subframe Number										
		0	1	2	3	4	5	6	7	8	9	
0	5 ms	D	S	U	U	U	D	S	U	U	U	
1	5 ms	D	S	U	U	D	D	S	U	U	D	
2	5 ms	D	S	U	D	D	D	S	U	D	D	
3	10 ms	D	S	U	U	U	D	D	D	D	D	
4	10 ms	D	S	U	U	D	D	D	D	D	D	
5	10 ms	D	S	U	D	D	D	D	D	D	D	
6	5 ms	D	S	U	U	U	D	S	U	U	D	

3GPP TS 36.211 Table 4.2-2: Uplink-Downlink Configurations

The variety of different TD-LTE uplink-downlink configurations allows a network operator to allocate the network's capacity between uplink and downlink traffic to meet the needs of the network. The uplink duty cycle of these seven configurations can readily be computed and shown in below.

UL-DL Configuration	0	1	2	3	4	5	6
Highest Duty-Cycle	63.33%	43.33%	23.33%	31.67%	21.67%	11.67%	53.33%

Considering the highest transmission duty cycle, TDD-LTE was tested using Uplink-Downlink Configuration 0 with 6 uplink subframe and 2 special subframe. The special subframe was set to special subframe configuration 7 using extended cyclic prefix uplink. Therefore, SAR testing for TDD-LTE was performed at the maximum output power with highest transmission duty cycle of 63.33%.

LTE Downlink Carrier Aggregation(CA)Setup Configurations

LTE Carrier Aggregation (CA) was defined in 3GPP release 10 and higher. The LTE device in CA mode has one Primary Component Carrier (PCC) and one or more Secondary Component Carriers (SCC). PCC acts as the anchor carrier and can optionally cross-schedule data transmission on SCC. The RRC connection is only handled by one cell, the PCC for downlink and uplink communications. After making a data connection to the PCC, the LTE device adds the SCC on the downlink only. All uplink communications and acknowledgements remain identical to release 8 specifications on the PCC. The combinations of downlink carrier aggregation supported by this device are listed in below.

LTE CA Configurations and Bandwidth Combination Sets defined for Intra-Band Contiguous CA

Downlink CA Configuration	Component carriers in order of increasing carrier frequency		Maximum Aggregated Bandwidth (MHz)	Bandwidth Combination Set
	Channel bandwidths for carrier-1 (MHz)	Channel bandwidths for carrier-2 (MHz)		
CA_2C	5	20	40	0
	10	15, 20		
	15	10, 15, 20		
	20	5, 10, 15, 20		
CA_5B	5, 10	10	20	0
	10	5	8	1
	3	5		
CA_7B	5	3	20	0
	15	5		
CA_7C	15	15	40	0
	20	20		
	10	20	40	1
	15	15, 20		
	20	10, 15, 20		
	CA_38C	15	10, 15	40
20		15, 20	40	0
15		15		
	20	20		

LTE CA Configurations and Bandwidth Combination Sets defined for Intra-Band Non-Contiguous CA

Downlink CA Configuration	Component Carriers in order of Increasing Carrier Frequency		Maximum Aggregated Bandwidth (MHz)	Bandwidth Combination Set
	Channel Bandwidths for Carrier-1 (MHz)	Channel Bandwidths for Carrier-2 (MHz)		
CA_2A-2A	5, 10, 15, 20	5, 10, 15, 20	40	0
CA_5A-5A	5,10	5,10	20	0
	3	5	8	1
CA_7A-7A	5	15	40	0
	10	10, 15		
	15	15, 20		
	20	20	40	1
	5, 10, 15, 20	5, 10, 15, 20	30	2
	10, 15, 20	10, 15, 20	40	3

LTE CA Configurations and Bandwidth Combination Sets defined for Inter-Band CA (Two Bands)

Downlink CA Configuration	LTE Bands	Channel Bandwidths for Carrier (MHz)	Maximum Aggregated Bandwidth (MHz)	Bandwidth Combination Set
CA_2A-5A	2	5, 10, 15, 20	30	0
	5	5, 10		
	2	5, 10	20	1
	5	5, 10		
CA_5A-7A	5	1.4, 3, 5, 10	30	0
	7	10, 15, 20		
	5	5, 10	30	1
	7	10, 15, 20		

FCC SAR Test Report

<SAR Test Exclusion Evaluations for LTE Downlink CA>

According to Nov 2017 TCB Workshop, SAR test exclusion for LTE downlink Carrier Aggregation is determined by power measurements according to the number of component carriers (CCs) supported by the product implementation. The downlink Carrier Aggregation configurations are tabulated in separate columns. DL CA would be listed in the columns corresponding to Intra Band contiguous, Intra Band Non-contiguous. The CA/CC combinations in each columns are sorted so that frequency bands listed in subsequent columns on each row are ascending subsets, as following LTE Downlink CA table and LTE Downlink CA table ; i.e., columns to the right correspond to increasing number of frequency bands and CCs.

LTE Downlink CA-Configure	Intra Band		Inter Band
	Contiguous	2CC Non-Contiguous	2 Bands / 2CC
			CA_2A-5A
			CA_5A-7A
		CA_2A-2A	
		CA_5A-5A	
		CA_7A-7A	
	CA_7B		
	CA_2C		
	CA_5B		
	CA_7C		
	CA_38C		

- Only yellow highlighted cells need power measurement.

LTE Uplink Carrier Aggregation (CA) Setup Configurations

This device supports LTE uplink CA for band 7 and 38 with a maximum of two 20 MHz carrier components in the uplink. The maximum output power for uplink intra-band contiguous CA specified in Table 6.2.2A-1 of 3GPP TS 36.101 is the same as single carrier specified in Table 6.2.2-1 of 3GPP TS 36.101. In Table 6.2.3A-1 of 3GPP TS 36.101, the MPR (maximum power reduction) for several dB is allowed due to modulation and contiguously aggregated transmit bandwidth configuration. All the RF parameters in this device have followed above 3GPP criteria.

Uplink CA Configuration	Component carriers in order of increasing carrier frequency		Maximum Aggregated Bandwidth (MHz)	Bandwidth Combination Set
	Channel bandwidths for carrier-1 (MHz)	Channel bandwidths for carrier-2 (MHz)		
CA_7C	15	15	40	0
	20	20		
	10	20	40	1
	15	15, 20		
	20	10, 15, 20	40	2
	15	10, 15		
CA_38C	20	15, 20	40	0
	15	15		
	20	20		

<Considerations Related to WLAN for Setup and Testing>

In general, various vendor specific external test software and chipset based internal test modes are typically used for SAR measurement. These chipset based test mode utilities are generally hardware and manufacturer dependent, and often include substantial flexibility to reconfigure or reprogram a device. A Wi-Fi device must be configured to transmit continuously at the required data rate, channel bandwidth and signal modulation, using the highest transmission duty factor supported by the test mode tools for SAR measurement. The test frequencies established using test mode must correspond to the actual channel frequencies. When 802.11 frame gaps are accounted for in the transmission, a maximum transmission duty factor of 92 - 96% is typically achievable in most test mode configurations. A minimum transmission duty factor of 85% is required to avoid certain hardware and device implementation issues related to wide range SAR scaling. In addition, a periodic transmission duty factor is required for current generation SAR systems to measure SAR correctly. The reported SAR must be scaled to 100% transmission duty factor to determine compliance at the maximum tune-up tolerance limit.

According to KDB 248227 D01, this device has installed WLAN engineering testing software which can provide continuous transmitting RF signal. During WLAN SAR testing, this device was operated to transmit continuously at the maximum transmission duty with specified transmission mode, operating frequency, lowest data rate, and maximum output power.

Initial Test Configuration

An initial test configuration is determined for OFDM transmission modes in 2.4 GHz and 5 GHz bands according to the channel bandwidth, modulation and data rate combination(s) with the highest maximum output power specified for production units in each standalone and aggregated frequency band. When the same maximum power is specified for multiple transmission modes in a frequency band, the largest channel bandwidth, lowest order modulation, lowest data rate and lowest order 802.11a/g/n/ac mode is used for SAR measurement, on the highest measured output power channel in the initial test configuration, for each frequency band.

Subsequent Test Configuration

SAR measurement requirements for the remaining 802.11 transmission mode configurations that have not been tested in the initial test configuration are determined separately for each standalone and aggregated frequency band, in each exposure condition, according to the maximum output power specified for production units. Additional power measurements may be required to determine if SAR measurements are required for subsequent highest output power channels in a subsequent test configuration. When the highest reported SAR for the initial test configuration according to the initial test position or fixed exposure position requirements, is adjusted by the ratio of the subsequent test configuration to initial test configuration specified maximum output power and the adjusted SAR is ≤ 1.2 W/kg, SAR is not required for that subsequent test configuration.

SAR Test Configuration and Channel Selection

When multiple channel bandwidth configurations in a frequency band have the same specified maximum output power, the initial test configuration is using largest channel bandwidth, lowest order modulation, lowest data rate, and lowest order 802.11 mode (i.e., 802.11a is chosen over 802.11n then 802.11ac or 802.11g is chosen over 802.11n). After an initial test configuration is determined, if multiple test channels have the same measured maximum output power, the channel chosen for SAR measurement is determined according to the following.

- 1) The channel closest to mid-band frequency is selected for SAR measurement.
- 2) For channels with equal separation from mid-band frequency; for example, high and low channels or two mid-band channels, the higher frequency (number) channel is selected for SAR measurement.

Test Reduction for U-NII-1 (5.2 GHz) and U-NII-2A (5.3 GHz) Bands

For devices that operate in both U-NII bands using the same transmitter and antenna(s), SAR test reduction is determined according to the following.

- 1) When the same maximum output power is specified for both bands, begin SAR measurement in U-NII-2A band by applying the OFDM SAR requirements. If the highest reported SAR for a test configuration is ≤ 1.2 W/kg, SAR is not required for U-NII-1 band for that configuration (802.11 mode and exposure condition).
- 2) When different maximum output power is specified for the bands, begin SAR measurement in the band with higher specified maximum output power. The highest reported SAR for the tested configuration is adjusted by the ratio of lower to higher specified maximum output power for the two bands. When the adjusted SAR is ≤ 1.2 W/kg, SAR is not required for the band with lower maximum output power in that test configuration.

<Considerations Related to Bluetooth for Setup and Testing>

This device has installed Bluetooth engineering testing software which can provide continuous transmitting RF signal. During Bluetooth SAR testing, this device was operated to transmit continuously at the maximum transmission duty with specified transmission mode, operating frequency, lowest data rate, and maximum output power.

FCC SAR Test Report

The Bluetooth call box has been used during SAR measurement and the EUT was set to DH5 mode at the maximum output power. Its duty factor was calculated as below and the measured SAR for Bluetooth would be scaled to the 100% transmission duty factor to determine compliance.

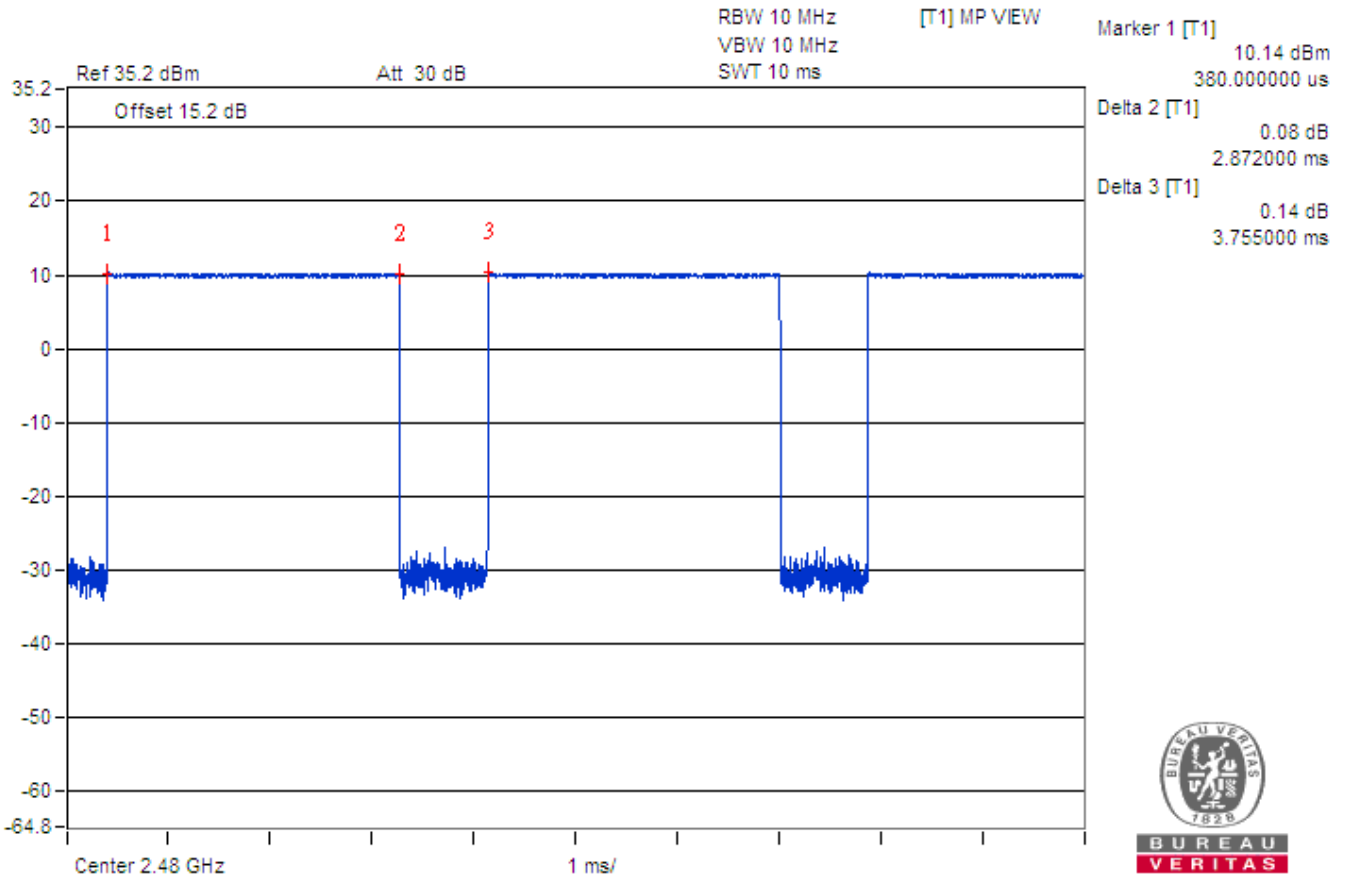

Time-domain plot for Bluetooth transmission signal

The duty factor of Bluetooth signal has been calculated as following.

$$\text{Duty Factor} = \text{Pulse Width} / \text{Total Period} = 2.872 / 3.755 = 76.48 \%$$

4.2 EUT Testing Position

According to KDB 648474 D04, handsets are tested for SAR compliance in head, body-worn accessory and other use configurations described in the following subsections.

4.2.1 Head Exposure Conditions

Head exposure is limited to next to the ear voice mode operations. Head SAR compliance is tested according to the test positions defined in IEEE Std 1528-2003 using the SAM phantom illustrated as below.

1. Define two imaginary lines on the handset
 - (a) The vertical centerline passes through two points on the front side of the handset - the midpoint of the width w_t of the handset at the level of the acoustic output, and the midpoint of the width w_b of the bottom of the handset.
 - (b) The horizontal line is perpendicular to the vertical centerline and passes through the center of the acoustic output. The horizontal line is also tangential to the face of the handset at point A.
 - (c) The two lines intersect at point A. Note that for many handsets, point A coincides with the center of the acoustic output; however, the acoustic output may be located elsewhere on the horizontal line. Also note that the vertical centerline is not necessarily parallel to the front face of the handset, especially for clamshell handsets, handsets with flip covers, and other irregularly shaped handsets.

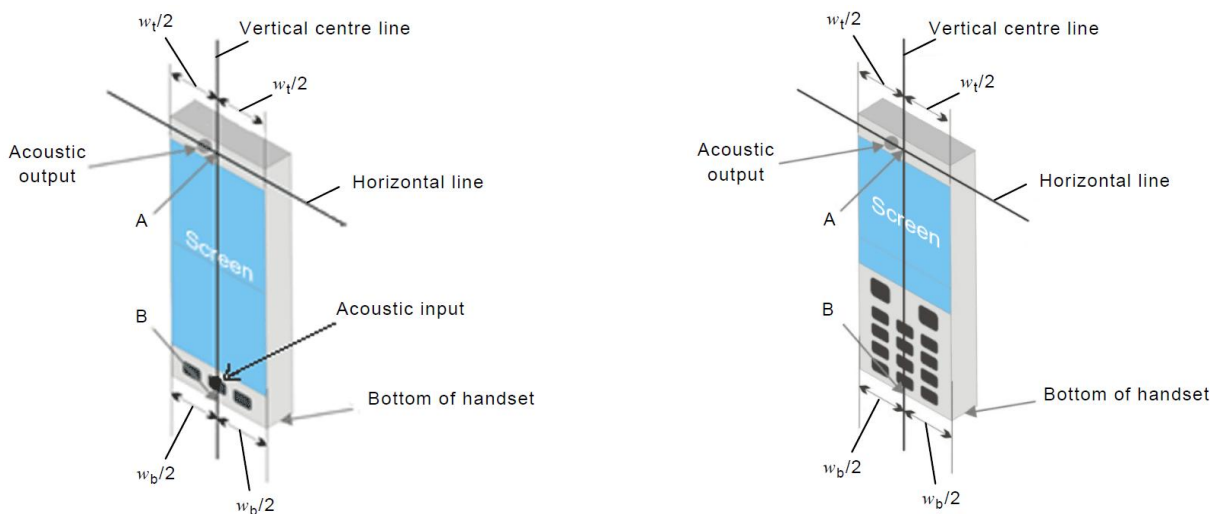

Fig-4.1 Illustration for Handset Vertical and Horizontal Reference Lines

2. Cheek Position

- (a) To position the device with the vertical center line of the body of the device and the horizontal line crossing the center piece in a plane parallel to the sagittal plane of the phantom. While maintaining the device in this plane, align the vertical center line with the reference plane containing the three ear and mouth reference point (M: Mouth, RE: Right Ear, and LE: Left Ear) and align the center of the ear piece with the line RE-LE.
- (b) To move the device towards the phantom with the ear piece aligned with the line LE-RE until the phone touched the ear. While maintaining the device in the reference plane and maintaining the phone contact with the ear, move the bottom of the phone until any point on the front side is in contact with the cheek of the phantom or until contact with the ear is lost (see Fig-4.2).

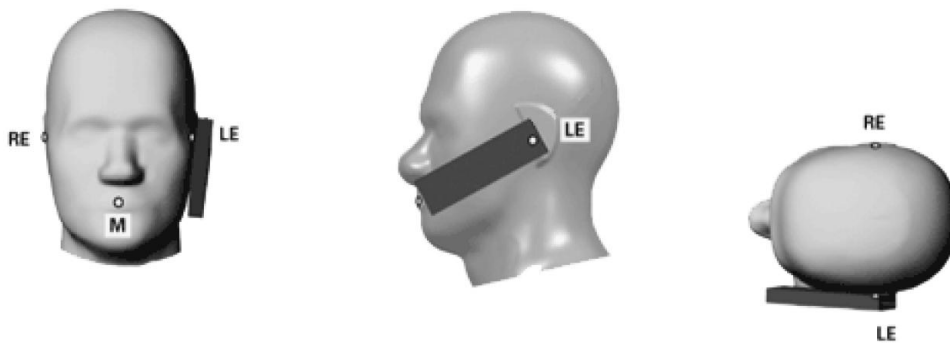

Fig-4.2 Illustration for Cheek Position

3. Tilted Position

- (a) To position the device in the “cheek” position described above.
- (b) While maintaining the device the reference plane described above and pivoting against the ear, moves it outward away from the mouth by an angle of 15 degrees or until contact with the ear is lost (see Fig-4.3).

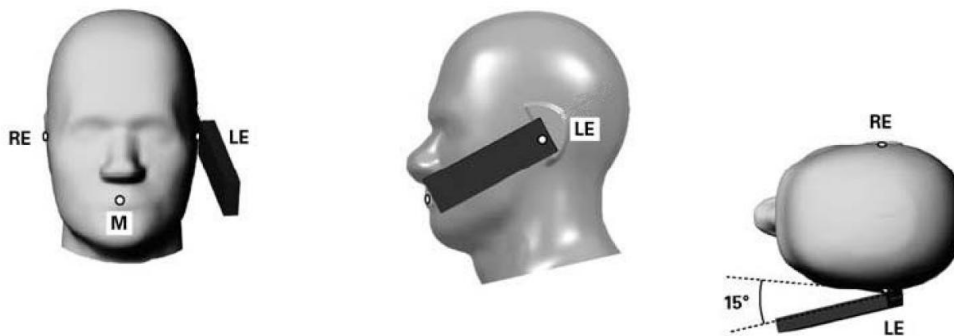

Fig-4.3 Illustration for Tilted Position

4.2.2 Body-worn Accessory Exposure Conditions

Body-worn accessory exposure is typically related to voice mode operations when handsets are carried in body-worn accessories. The body-worn accessory procedures in KDB 447498 D01 are used to test for body-worn accessory SAR compliance, without a headset connected to it. This enables the test results for such configuration to be compatible with that required for hotspot mode when the body-worn accessory test separation distance is greater than or equal to that required for hotspot mode. When the reported SAR for a body-worn accessory, measured without a headset connected to the handset, is $> 1.2 \text{ W/kg}$, the highest reported SAR configuration for that wireless mode and frequency band should be repeated for that body-worn accessory with a headset attached to the handset.

Body-worn accessories that do not contain metallic or conductive components may be tested according to worst-case exposure configurations, typically according to the smallest test separation distance required for the group of body-worn accessories with similar operating and exposure characteristics. All body-worn accessories containing metallic components are tested in conjunction with the host device.

Body-worn accessory SAR compliance is based on a single minimum test separation distance for all wireless and operating modes applicable to each body-worn accessory used by the host, and according to the relevant voice and/or data mode transmissions and operations. If a body-worn accessory supports voice only operations in its normal and expected use conditions, testing of data mode for body-worn compliance is not required.

A conservative minimum test separation distance for supporting off-the-shelf body-worn accessories that may be acquired by users of consumer handsets is used to test for body-worn accessory SAR compliance. This distance is determined by the handset manufacturer, according to the requirements of Supplement C 01-01. Devices that are designed to operate on the body of users using lanyards and straps, or without requiring additional body-worn accessories, will be tested using a conservative minimum test separation distance $\leq 5 \text{ mm}$ to support compliance.

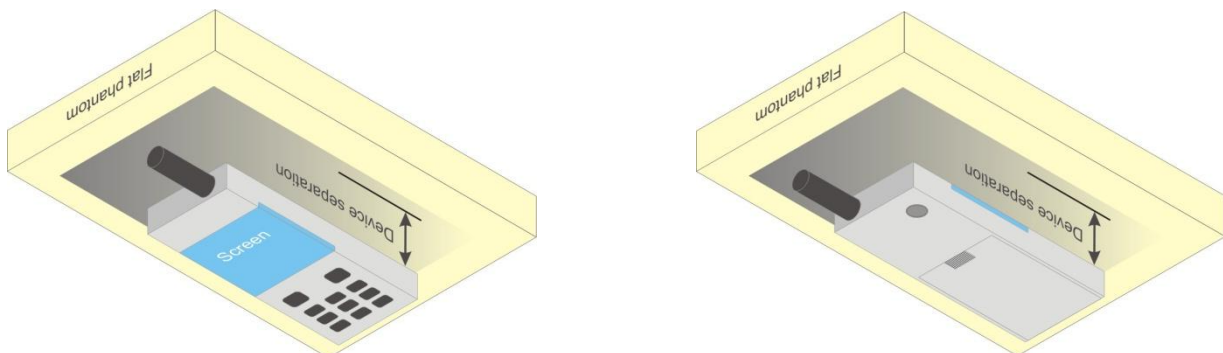
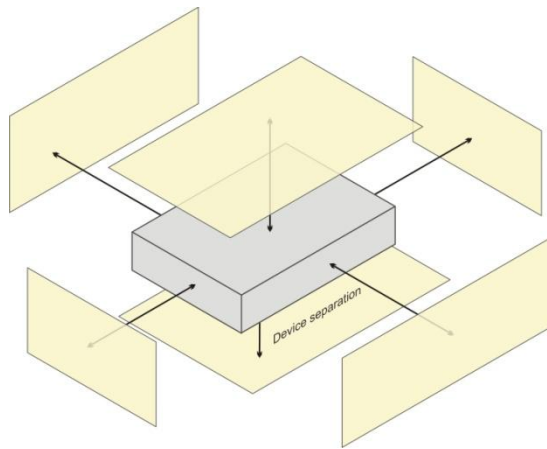

Fig-4.4 Illustration for Body Worn Position

4.2.3 Hotspot Mode Exposure Conditions

For handsets that support hotspot mode operations, with wireless router capabilities and various web browsing functions, the relevant hand and body exposure conditions are tested according to the hotspot SAR procedures in KDB 941225 D06. A test separation distance of 10 mm is required between the phantom and all surfaces and edges with a transmitting antenna located within 25 mm from that surface or edge. When the form factor of a handset is smaller than 9 cm x 5 cm, a test separation distance of 5 mm (instead of 10 mm) is required for testing hotspot mode. When the separation distance required for body-worn accessory testing is larger than or equal to that tested for hotspot mode, in the same wireless mode and for the same surface of the phone, the hotspot mode SAR data may be used to support body-worn accessory SAR compliance for that particular configuration (surface).



Based on the antenna location shown on appendix D of this report, the SAR testing required for hotspot mode is listed as below.

Antenna	Front Face	Rear Face	Left Side	Right Side	Top Side	Bottom Side
WWAN Ant-1	✓	✓	✓	✓		✓
WWAN Ant-2	✓	✓		✓		✓
WWAN Ant-3	✓	✓	✓	✓	✓	
WLAN/BT	✓	✓		✓	✓	

4.2.4 Product Specific (Phablet) Exposure Conditions

For smart phones with a display diagonal dimension > 15 cm or an overall diagonal dimension > 16 cm that provide similar mobile web access and multimedia support found in mini-tablets or UMPC mini-tablets that support voice calls next to the ear, the following Phablet procedures should be applied to evaluate SAR compliance for each applicable wireless mode and frequency band. Devices marketed as Phablets, regardless of form factors and operating characteristics must be tested as a Phablet to determine SAR compliance.

1. The normally required head and body-worn accessory SAR test procedures for handsets, including hotspot mode, must be applied.
2. The UMPC mini-tablet procedures must also be applied to test the SAR of all surfaces and edges with an antenna located at ≤ 25 mm from that surface or edge, in direct contact with a flat phantom, for 10-g extremity SAR according to the body-equivalent tissue dielectric parameters in KDB 865664 to address interactive hand use exposure conditions. The UMPC mini-tablet 1-g SAR at 5 mm is not required. When hotspot mode applies, 10-g extremity SAR is required only for the surfaces and edges with hotspot mode 1-g SAR > 1.2 W/kg. The normal tablet procedures in KDB 616217 are required when the over diagonal dimension of the device is > 20 cm. Hotspot mode SAR is not required when normal tablet procedures are applied. Extremity 10-g SAR is also not required for the front (top) surface of large form factor full size tablets. The more conservative tablet SAR results can be used to support the 10-g extremity SAR for Phablet mode.
3. The simultaneous transmission operating configurations applicable to voice and data transmissions for both phone and mini-tablet modes must be taken into consideration separately for 1-g and 10-g SAR to determine the simultaneous transmission SAR test exclusion and measurement requirements for the relevant wireless mode and exposure conditions.

4.3 Tissue Verification

The measuring results for tissue simulating liquid are shown as below.

<Head / Body>

Test Date	Frequency (MHz)	Liquid Temp. (°C)	Measured Conductivity (σ)	Measured Permittivity (ε _r)	Target Conductivity (σ)	Target Permittivity (ε _r)	Conductivity Deviation (%)	Permittivity Deviation (%)
Aug. 28, 2019	835	23.1	0.913	42.597	0.9	41.5	1.44	2.64
Aug. 31, 2019	835	23.3	0.908	42.279	0.9	41.5	0.89	1.88
Sep. 06, 2019	835	23.2	0.919	41.759	0.9	41.5	2.11	0.62
Sep. 07, 2019	835	23.1	0.905	41.821	0.9	41.5	0.56	0.77
Oct. 07, 2019	835	23.2	0.928	42.015	0.9	41.5	3.11	1.24
Oct. 08, 2019	835	23.2	0.921	41.866	0.9	41.5	2.33	0.88
Aug. 27, 2019	1750	23.1	1.322	41.001	1.37	40.1	-3.50	2.25
Aug. 29, 2019	1750	23.1	1.329	39.118	1.37	40.1	-2.99	-2.45
Oct. 07, 2019	1750	23.2	1.323	41.044	1.37	40.1	-3.43	2.35
Oct. 08, 2019	1750	23.2	1.311	41.03	1.37	40.1	-4.31	2.32
Aug. 27, 2019	1900	23.1	1.454	40.457	1.4	40	3.86	1.14
Aug. 29, 2019	1900	23.3	1.459	38.542	1.4	40	4.21	-3.65
Aug. 29, 2019	1900	23.1	1.459	38.542	1.4	40	4.21	-3.65
Sep. 06, 2019	1900	23.2	1.348	41.894	1.4	40	-3.71	4.74
Sep. 07, 2019	1900	23.1	1.443	38.307	1.4	40	3.07	-4.23
Sep. 16, 2019	1900	23.2	1.464	38.114	1.4	40	4.57	-4.72
Oct. 07, 2019	1900	23.2	1.455	40.502	1.4	40	3.93	1.26
Oct. 09, 2019	1900	23.3	1.426	40.478	1.4	40	1.86	1.20
Aug. 21, 2019	2450	23.3	1.873	38.701	1.8	39.2	4.06	-1.27
Aug. 27, 2019	2450	23.1	1.868	37.896	1.8	39.2	3.78	-3.33
Sep. 06, 2019	2450	23.2	1.869	39.986	1.8	39.2	3.83	2.01
Sep. 09, 2019	2450	23.1	1.827	38.941	1.8	39.2	1.50	-0.66
Sep. 16, 2019	2450	23.2	1.864	38.085	1.8	39.2	3.56	-2.84
Aug. 16, 2019	2600	23.2	2.043	37.822	1.96	39	4.23	-3.02
Sep. 09, 2019	2600	23.1	2.04	38.305	1.96	39	4.08	-1.78
Sep. 10, 2019	2600	23.3	1.975	38.417	1.96	39	0.77	-1.49
Sep. 06, 2019	5250	23.2	4.795	35.269	4.71	35.9	1.80	-1.76
Sep. 09, 2019	5250	23.1	4.692	37.651	4.71	35.9	-0.38	4.88
Sep. 16, 2019	5250	23.2	4.606	35.721	4.71	35.9	-2.21	-0.50
Sep. 06, 2019	5600	23.2	5.178	34.66	5.07	35.5	2.13	-2.37
Sep. 16, 2019	5600	23.2	4.972	35.216	5.07	35.5	-1.93	-0.80
Sep. 06, 2019	5750	23.2	5.34	34.366	5.22	35.4	2.30	-2.92
Sep. 08, 2019	5750	23.1	5.282	33.95	5.22	35.4	1.19	-4.10

<Extremity>

Test Date	Frequency (MHz)	Liquid Temp. (°C)	Measured Conductivity (σ)	Measured Permittivity (ε _r)	Target Conductivity (σ)	Target Permittivity (ε _r)	Conductivity Deviation (%)	Permittivity Deviation (%)
Oct. 08, 2019	1750	23.2	1.329	39.815	1.37	40.1	-2.99	-0.71
Oct. 11, 2019	1750	23.2	1.328	39.811	1.37	40.1	-3.07	-0.72
Aug. 29, 2019	1900	23.3	1.459	38.542	1.4	40	4.21	-3.65
Sep. 07, 2019	1900	23.1	1.443	38.307	1.4	40	3.07	-4.23
Aug. 22, 2019	2450	23.5	1.881	38.819	1.8	39.2	4.50	-0.97
Sep. 08, 2019	5250	23.1	4.741	34.837	4.71	35.9	0.66	-2.96
Sep. 08, 2019	5600	23.1	5.12	34.235	5.07	35.5	0.99	-3.56
Sep. 08, 2019	5750	23.1	5.282	33.95	5.22	35.4	1.19	-4.10

Note:

The dielectric properties of the tissue simulating liquid must be measured within 24 hours before the SAR testing and within ±5% of the target values. Liquid temperature during the SAR testing must be within ±2 °C.

FCC SAR Test Report

4.4 System Validation

The SAR measurement system was validated according to procedures in KDB 865664 D01. The validation status in tabulated summary is as below.

<Head / Body>

Test Date	Probe S/N	Calibration Point	Measured Conductivity (σ)	Measured Permittivity (ϵ_r)	Validation for CW			Validation for Modulation		
					Sensitivity Range	Probe Linearity	Probe Isotropy	Modulation Type	Duty Factor	PAR
Aug. 28, 2019	7537	835	0.913	42.597	Pass	Pass	Pass	N/A	N/A	N/A
Aug. 31, 2019	3971	835	0.908	42.279	Pass	Pass	Pass	GMSK	Pass	N/A
Sep. 06, 2019	3650	835	0.919	41.759	Pass	Pass	Pass	GMSK	Pass	N/A
Sep. 07, 2019	3650	835	0.905	41.821	Pass	Pass	Pass	N/A	N/A	N/A
Oct. 07, 2019	7537	835	0.928	42.015	Pass	Pass	Pass	GMSK	Pass	N/A
Oct. 08, 2019	7537	835	0.921	41.866	Pass	Pass	Pass	GMSK	Pass	N/A
Aug. 27, 2019	7537	1750	1.322	41.001	Pass	Pass	Pass	N/A	N/A	N/A
Aug. 29, 2019	3898	1750	1.329	39.118	Pass	Pass	Pass	N/A	N/A	N/A
Oct. 07, 2019	7537	1750	1.323	41.044	Pass	Pass	Pass	N/A	N/A	N/A
Oct. 08, 2019	7537	1750	1.311	41.03	Pass	Pass	Pass	N/A	N/A	N/A
Aug. 27, 2019	7537	1900	1.454	40.457	Pass	Pass	Pass	GMSK	Pass	N/A
Aug. 29, 2019	7537	1900	1.459	38.542	Pass	Pass	Pass	GMSK	Pass	N/A
Aug. 29, 2019	3898	1900	1.459	38.542	Pass	Pass	Pass	GMSK	Pass	N/A
Sep. 06, 2019	3650	1900	1.348	41.894	Pass	Pass	Pass	N/A	N/A	N/A
Sep. 07, 2019	3650	1900	1.443	38.307	Pass	Pass	Pass	N/A	N/A	N/A
Sep. 16, 2019	3650	1900	1.464	38.114	Pass	Pass	Pass	N/A	N/A	N/A
Oct. 07, 2019	7537	1900	1.455	40.502	Pass	Pass	Pass	N/A	N/A	N/A
Oct. 09, 2019	7537	1900	1.426	40.478	Pass	Pass	Pass	N/A	N/A	N/A
Aug. 21, 2019	7537	2450	1.873	38.701	Pass	Pass	Pass	OFDM	N/A	Pass
Aug. 27, 2019	7537	2450	1.868	37.896	Pass	Pass	Pass	OFDM	N/A	Pass
Sep. 06, 2019	3650	2450	1.869	39.986	Pass	Pass	Pass	OFDM	N/A	Pass
Sep. 09, 2019	3650	2450	1.827	38.941	Pass	Pass	Pass	OFDM	N/A	Pass
Sep. 16, 2019	3650	2450	1.864	38.085	Pass	Pass	Pass	OFDM	N/A	Pass
Aug. 16, 2019	3971	2600	2.043	37.822	Pass	Pass	Pass	N/A	N/A	N/A
Sep. 09, 2019	7537	2600	2.04	38.305	Pass	Pass	Pass	N/A	N/A	N/A
Sep. 10, 2019	3650	2600	1.975	38.417	Pass	Pass	Pass	N/A	N/A	N/A
Sep. 06, 2019	3650	5250	4.795	35.269	Pass	Pass	Pass	OFDM	N/A	Pass
Sep. 09, 2019	3650	5250	4.692	37.651	Pass	Pass	Pass	OFDM	N/A	Pass
Sep. 16, 2019	3650	5250	4.606	35.721	Pass	Pass	Pass	OFDM	N/A	Pass
Sep. 06, 2019	3650	5600	5.178	34.66	Pass	Pass	Pass	OFDM	N/A	Pass
Sep. 16, 2019	3650	5600	4.972	35.216	Pass	Pass	Pass	OFDM	N/A	Pass
Sep. 06, 2019	3650	5750	5.34	34.366	Pass	Pass	Pass	OFDM	N/A	Pass
Sep. 08, 2019	3650	5750	5.282	33.95	Pass	Pass	Pass	OFDM	N/A	Pass

<Extremity>

Test Date	Probe S/N	Calibration Point	Measured Conductivity (σ)	Measured Permittivity (ϵ_r)	Validation for CW			Validation for Modulation		
					Sensitivity Range	Probe Linearity	Probe Isotropy	Modulation Type	Duty Factor	PAR
Oct. 08, 2019	7537	1750	1.329	39.815	Pass	Pass	Pass	N/A	N/A	N/A
Oct. 11, 2019	7537	1750	1.328	39.811	Pass	Pass	Pass	N/A	N/A	N/A
Aug. 29, 2019	7537	1900	1.459	38.542	Pass	Pass	Pass	N/A	N/A	N/A
Sep. 07, 2019	3650	1900	1.443	38.307	Pass	Pass	Pass	N/A	N/A	N/A
Aug. 22, 2019	7537	2450	1.881	38.819	Pass	Pass	Pass	OFDM	N/A	Pass
Sep. 08, 2019	3650	5250	4.741	34.837	Pass	Pass	Pass	OFDM	N/A	Pass
Sep. 08, 2019	3650	5600	5.12	34.235	Pass	Pass	Pass	OFDM	N/A	Pass
Sep. 08, 2019	3650	5750	5.282	33.95	Pass	Pass	Pass	OFDM	N/A	Pass

FCC SAR Test Report

4.5 System Verification

The measuring result for system verification is tabulated as below.

<Head / Body>

Test Date	Frequency (MHz)	1W Target SAR-1g (W/kg)	Measured SAR-1g (W/kg)	Normalized to 1W SAR-1g (W/kg)	Deviation (%)	Dipole S/N	Probe S/N	DAE S/N
Aug. 28, 2019	835	9.50	2.37	9.48	-0.21	4d092	7537	1585
Aug. 31, 2019	835	9.50	2.38	9.52	0.21	4d092	3971	1431
Sep. 06, 2019	835	9.50	2.25	9.00	-5.26	4d092	3650	861
Sep. 07, 2019	835	9.50	2.32	9.28	-2.32	4d092	3650	861
Oct. 07, 2019	835	9.50	2.53	10.12	6.53	4d092	7537	1585
Oct. 08, 2019	835	9.50	2.49	9.96	4.84	4d092	7537	1585
Aug. 27, 2019	1750	36.10	8.75	35.00	-3.05	1023	7537	1585
Aug. 29, 2019	1750	36.10	8.71	34.84	-3.49	1023	3898	916
Oct. 07, 2019	1750	36.10	8.84	35.36	-2.05	1023	7537	1585
Oct. 08, 2019	1750	36.10	8.91	35.64	-1.27	1023	7537	1585
Aug. 27, 2019	1900	40.20	9.93	39.72	-1.19	5d036	7537	1585
Aug. 29, 2019	1900	40.20	10.7	42.80	6.47	5d036	7537	1585
Aug. 29, 2019	1900	40.20	9.74	38.96	-3.08	5d036	3898	916
Sep. 06, 2019	1900	40.20	9.51	38.04	-5.37	5d036	3650	861
Sep. 07, 2019	1900	40.20	9.99	39.96	-0.60	5d036	3650	861
Sep. 16, 2019	1900	40.20	10.6	42.40	5.47	5d036	3650	861
Oct. 07, 2019	1900	40.20	10.6	42.40	5.47	5d036	7537	1585
Oct. 09, 2019	1900	40.20	10.5	42.00	4.48	5d036	7537	1585
Aug. 21, 2019	2450	53.10	12.8	51.20	-3.58	835	7537	1585
Aug. 27, 2019	2450	53.10	13.1	52.40	-1.32	835	7537	1585
Sep. 06, 2019	2450	53.10	12.7	50.80	-4.33	835	3650	861
Sep. 09, 2019	2450	53.10	12.5	50.00	-5.84	835	3650	861
Sep. 16, 2019	2450	53.10	12.9	51.60	-2.82	835	3650	861
Aug. 16, 2019	2600	58.10	13.6	54.40	-6.37	1058	3971	1431
Sep. 09, 2019	2600	58.10	13.8	55.20	-4.99	1058	7537	1585
Sep. 10, 2019	2600	58.10	13.9	55.60	-4.30	1058	3650	861
Sep. 06, 2019	5250	80.70	8.3	83.00	2.85	1019	3650	861
Sep. 09, 2019	5250	80.70	8.12	81.20	0.62	1019	3650	861
Sep. 16, 2019	5250	80.70	7.83	78.30	-2.97	1019	3650	861
Sep. 06, 2019	5600	85.80	8.44	84.40	-1.63	1019	3650	861
Sep. 16, 2019	5600	85.80	8.46	84.60	-1.40	1019	3650	861
Sep. 06, 2019	5750	81.50	7.79	77.90	-4.42	1019	3650	861
Sep. 08, 2019	5750	81.50	7.7	77.00	-5.52	1019	3650	861

<Extremity>

Test Date	Frequency (MHz)	1W Target SAR-10g (W/kg)	Measured SAR-10g (W/kg)	Normalized to 1W SAR-1g (W/kg)	Deviation (%)	Dipole S/N	Probe S/N	DAE S/N
Oct. 08, 2019	1750	18.90	4.76	19.04	0.74	1023	7537	1585
Oct. 11, 2019	1750	18.90	4.66	18.64	-1.38	1023	7537	1585
Aug. 29, 2019	1900	20.90	5.58	22.32	6.79	5d036	7537	1585
Sep. 07, 2019	1900	20.90	5.15	20.60	-1.44	5d036	3650	861
Aug. 22, 2019	2450	24.90	6.13	24.52	-1.53	835	7537	1585
Sep. 08, 2019	5250	23.20	2.35	23.50	1.29	1019	3650	861
Sep. 08, 2019	5600	24.50	2.42	24.20	-1.22	1019	3650	861
Sep. 08, 2019	5750	23.20	2.21	22.10	-4.74	1019	3650	861

Note:

Comparing to the reference SAR value provided by SPEAG, the validation data should be within its specification of 10 %. The result indicates the system check can meet the variation criterion and the plots can be referred to Appendix A of this report.

4.6 Maximum Output Power

4.6.1 Maximum Target Conducted Power

The maximum conducted average power (Unit: dBm) including tune-up tolerance is shown as below.

Band		Stable Maximum	Head Mode		Body-Worn / Hotspot		Extremity	
			Max. Burst-Averaged Output Power	Max. Frame-Averaged Output Power	Max. Burst-Averaged Output Power	Max. Frame-Averaged Output Power	Max. Burst-Averaged Output Power	Max. Frame-Averaged Output Power
			Tune up Power	Ant-1	Ant-1	Ant-1	Ant-1	Ant-1
GSM850	GSM (GMSK, 1Tx-slot)	33.00	33.00	24.00	33.00	24.00	33.00	24.00
	GPRS (GMSK, 1Tx-slot)	33.00	33.00	24.00	33.00	24.00	33.00	24.00
	GPRS (GMSK, 2Tx-slot)	30.00	30.00	24.00	30.00	24.00	30.00	24.00
	GPRS (GMSK, 3Tx-slot)	28.00	28.00	23.74	28.00	23.74	28.00	23.74
	GPRS (GMSK, 4Tx-slot)	27.00	27.00	24.00	27.00	24.00	27.00	24.00
	EDGE (8PSK, 1Tx-slot)	27.00	27.00	18.00	27.00	18.00	27.00	18.00
	EDGE (8PSK, 2Tx-slot)	27.00	27.00	21.00	27.00	21.00	27.00	21.00
	EDGE (8PSK, 3Tx-slot)	27.00	27.00	22.74	27.00	22.74	27.00	22.74
EDGE (8PSK, 4Tx-slot)	27.00	27.00	24.00	27.00	24.00	27.00	24.00	

Band		Stable Maximum	Head Mode		Body-Worn / Hotspot		Extremity	
			Max. Burst-Averaged Output Power	Max. Frame-Averaged Output Power	Max. Burst-Averaged Output Power	Max. Frame-Averaged Output Power	Max. Burst-Averaged Output Power	Max. Frame-Averaged Output Power
			Tune up Power	Ant-3	Ant-3	Ant-3	Ant-3	Ant-3
GSM850	GSM (GMSK, 1Tx-slot)	31.00	28.00	19.00	31.00	22.00	31.00	22.00
	GPRS (GMSK, 1Tx-slot)	31.00	28.00	19.00	31.00	22.00	31.00	22.00
	GPRS (GMSK, 2Tx-slot)	29.00	27.00	21.00	29.00	23.00	29.00	23.00
	GPRS (GMSK, 3Tx-slot)	27.00	25.00	20.74	27.00	22.74	27.00	22.74
	GPRS (GMSK, 4Tx-slot)	26.00	24.00	21.00	26.00	23.00	26.00	23.00
	EDGE (8PSK, 1Tx-slot)	25.00	22.00	13.00	25.00	16.00	25.00	16.00
	EDGE (8PSK, 2Tx-slot)	25.00	22.00	16.00	25.00	19.00	25.00	19.00
	EDGE (8PSK, 3Tx-slot)	25.00	22.00	17.74	25.00	20.74	25.00	20.74
EDGE (8PSK, 4Tx-slot)	25.00	22.00	19.00	25.00	22.00	25.00	22.00	

FCC SAR Test Report

Band		Stable Maximum	Head Mode		Body-Worn / Hotspot		Extremity	
			Max. Burst-Averaged Output Power	Max. Frame-Averaged Output Power	Max. Burst-Averaged Output Power	Max. Frame-Averaged Output Power	Max. Burst-Averaged Output Power	Max. Frame-Averaged Output Power
			Ant-1	Ant-1	Ant-1	Ant-1	Ant-1	Ant-1
Tune up Power								
GSM1900	GSM (GMSK, 1Tx-slot)	30.00	30.00	21.00	30.00	21.00	30.00	21.00
	GPRS (GMSK, 1Tx-slot)	30.00	30.00	21.00	30.00	21.00	30.00	21.00
	GPRS (GMSK, 2Tx-slot)	27.00	27.00	21.00	27.00	21.00	27.00	21.00
	GPRS (GMSK, 3Tx-slot)	25.00	25.00	20.74	25.00	20.74	25.00	20.74
	GPRS (GMSK, 4Tx-slot)	24.00	24.00	21.00	24.00	21.00	24.00	21.00
	EDGE (8PSK, 1Tx-slot)	26.00	26.00	17.00	26.00	17.00	26.00	17.00
	EDGE (8PSK, 2Tx-slot)	26.00	26.00	20.00	26.00	20.00	26.00	20.00
	EDGE (8PSK, 3Tx-slot)	26.00	26.00	21.74	26.00	21.74	26.00	21.74
EDGE (8PSK, 4Tx-slot)	26.00	26.00	23.00	26.00	23.00	26.00	23.00	

Note:

- SAR testing was performed on the maximum frame-averaged power mode.
- The frame-averaged power is linearly proportion to the slot number configured and it is linearly scaled the maximum burst-averaged power based on time slots. The calculated method is shown as below:

$$\text{Frame-averaged power} = 10 \times \log (\text{Burst-averaged power mW} \times \text{Slot used} / 8)$$

FCC SAR Test Report

Band	Stable Maximum	Head Power Mode	Body-Worn / Hotspot	Extremity
	Tune up Power	Ant-1	Ant-1	Ant-1
WCDMA Band II	24.0	24.0	21.0	21.0
WCDMA Band IV	24.0	24.0	21.0	21.0
WCDMA Band V	24.0	24.0	24.0	24.0
LTE 2	24.0	24.0	18.5	23.0
LTE 4	24.0	24.0	21.0	21.0
LTE 5	24.0	24.0	24.0	24.0

Band	Stable Maximum	Head Power Mode	Body-Worn / Hotspot	Extremity
	Tune up Power	Ant-3	Ant-3	Ant-3
WCDMA Band II	-	-	-	-
WCDMA Band IV	-	-	-	-
WCDMA Band V	22.0	21.0	22.0	22.0
LTE 2	-	-	-	-
LTE 4	-	-	-	-
LTE 5	22.0	22.0	22.0	22.0

Band	Stable Maximum	Head Power Mode	Body-Worn / Hotspot	Extremity
	Tune up Power	Ant-2	Ant-2	Ant-2
LTE 7	24.5	24.5	24.5	24.5
LTE 38	24.5	24.5	24.5	24.5

<WLAN 2.4G>

Mode	Channel	Frequency (MHz)	Tune-up Power
802.11b	1	2412	15.0
	6	2437	15.0
	11	2462	15.0
802.11g	1	2412	15.0
	6	2437	15.0
	11	2462	15.0
802.11n (HT20)	1	2412	15.0
	6	2437	15.0
	11	2462	15.0
802.11n (HT40)	3	2422	13.0
	6	2437	13.0
	9	2452	13.0
802.11ac (VHT20)	1	2412	13.0
	6	2437	13.0
	11	2462	13.0
802.11ac (VHT40)	3	2422	13.0
	6	2437	13.0
	9	2452	13.0

FCC SAR Test Report

<WLAN 5.2G>

Mode	Channel	Frequency (MHz)	Tune-up Power
802.11a	36	5180	14.0
	40	5200	14.0
	44	5220	14.0
	48	5240	14.0
802.11n (HT20)	36	5180	13.0
	40	5200	13.0
	44	5220	13.0
	48	5240	13.0
802.11n (HT40)	38	5190	13.0
	46	5230	13.0
802.11ac (VHT20)	36	5180	13.0
	40	5200	13.0
	44	5220	13.0
	48	5240	13.0
802.11ac (VHT40)	38	5190	13.0
	46	5230	13.0
802.11ac (VHT80)	42	5210	13.0

<WLAN 5.3G>

Mode	Channel	Frequency (MHz)	Tune-up Power
802.11a	52	5260	14.0
	56	5280	14.0
	60	5300	14.0
	64	5320	14.0
802.11n (HT20)	52	5260	13.0
	56	5280	13.0
	60	5300	13.0
	64	5320	13.0
802.11n (HT40)	54	5270	13.0
	62	5310	13.0
802.11ac (VHT20)	52	5260	13.0
	56	5280	13.0
	60	5300	13.0
	64	5320	13.0
802.11ac (VHT40)	54	5270	13.0
	62	5310	13.0
802.11ac (VHT80)	58	5290	13.0

FCC SAR Test Report

<WLAN 5.6G>

Mode	Channel	Frequency (MHz)	Tune-up Power
802.11a	100	5500	14.0
	116	5580	14.0
	120	5600	14.0
	124	5620	14.0
	132	5660	14.0
	140	5700	14.0
	144	5720	14.0
802.11n (HT20)	100	5500	13.0
	116	5580	13.0
	120	5600	13.0
	124	5620	13.0
	132	5660	13.0
	140	5700	13.0
	144	5720	13.0
802.11n (HT40)	102	5510	13.0
	110	5550	13.0
	118	5590	13.0
	126	5630	13.0
	134	5670	13.0
	142	5710	13.0
802.11ac (VHT20)	100	5500	13.0
	116	5580	13.0
	120	5600	13.0
	124	5620	13.0
	132	5660	13.0
	140	5700	13.0
	144	5720	13.0
802.11ac (VHT40)	102	5510	13.0
	110	5550	13.0
	118	5590	13.0
	126	5630	13.0
	134	5670	13.0
	142	5710	13.0
802.11ac (VHT80)	106	5530	13.0
	122	5610	13.0
	138	5690	13.0

FCC SAR Test Report

<WLAN 5.8G>

Mode	Channel	Frequency (MHz)	Tune-up Power
802.11a	149	5745	14.0
	153	5765	14.0
	157	5785	14.0
	161	5805	14.0
	165	5825	14.0
802.11n (HT20)	149	5745	13.0
	153	5765	13.0
	157	5785	13.0
	161	5805	13.0
	165	5825	13.0
802.11n (HT40)	151	5755	13.0
	159	5795	13.0
802.11ac (VHT20)	149	5745	13.0
	153	5765	13.0
	157	5785	13.0
	161	5805	13.0
	165	5825	13.0
802.11ac (VHT40)	151	5755	13.0
	159	5795	13.0
802.11ac (VHT80)	155	5775	13.0

<Bluetooth>

Mode	Channel	Frequency (MHz)	Tune-up Power
Bluetooth EDR	0	2402	9.5
	39	2441	9.5
	78	2480	9.5
Bluetooth LE	0	2402	-2
	19	2440	-2
	39	2480	-2

FCC SAR Test Report

4.6.2 Measured Conducted Power Result

The measuring conducted average power (Unit: dBm) is shown as below.

Mode	Tx Antenna	Band	GSM850		
		Channel	128	189	251
		Frequency (MHz)	824.2	836.4	848.8
Maximum Burst-Averaged Output Power					
Head / Body-worn / Hotspot / Extremity	Ant-1	GSM (GMSK, 1Tx-slot)	32.12	32.16	32.17
		GPRS (GMSK, 1Tx-slot)	32.20	32.21	32.23
		GPRS (GMSK, 2Tx-slot)	29.93	29.98	29.99
		GPRS (GMSK, 3Tx-slot)	27.85	27.92	27.93
		GPRS (GMSK, 4Tx-slot)	26.89	26.96	26.98
		EDGE (8PSK, 1Tx-slot)	26.80	26.77	26.71
		EDGE (8PSK, 2Tx-slot)	25.67	25.62	25.55
		EDGE (8PSK, 3Tx-slot)	26.10	26.01	25.98
		EDGE (8PSK, 4Tx-slot)	25.54	25.56	25.55
Maximum Burst-Averaged Output Power					
Head	Ant-3	GSM (GMSK, 1Tx-slot)	27.81	27.83	27.85
		GPRS (GMSK, 1Tx-slot)	27.79	27.81	27.83
		GPRS (GMSK, 2Tx-slot)	26.43	26.45	26.47
		GPRS (GMSK, 3Tx-slot)	24.85	24.87	24.89
		GPRS (GMSK, 4Tx-slot)	23.78	23.84	23.91
		EDGE (8PSK, 1Tx-slot)	21.94	21.96	21.98
		EDGE (8PSK, 2Tx-slot)	21.96	21.98	22.00
		EDGE (8PSK, 3Tx-slot)	21.41	21.43	21.45
		EDGE (8PSK, 4Tx-slot)	21.20	21.22	21.24
Maximum Burst-Averaged Output Power					
Body-worn / Hotspot / Extremity	Ant-3	GSM (GMSK, 1Tx-slot)	30.47	30.51	30.55
		GPRS (GMSK, 1Tx-slot)	30.43	30.48	30.53
		GPRS (GMSK, 2Tx-slot)	28.13	28.18	28.22
		GPRS (GMSK, 3Tx-slot)	26.06	26.08	26.13
		GPRS (GMSK, 4Tx-slot)	25.09	25.12	25.18
		EDGE (8PSK, 1Tx-slot)	24.67	24.71	24.77
		EDGE (8PSK, 2Tx-slot)	23.54	23.57	23.62
		EDGE (8PSK, 3Tx-slot)	24.17	24.21	24.26
		EDGE (8PSK, 4Tx-slot)	23.76	23.79	23.84

Mode	Tx Antenna	Band	GSM1900		
		Channel	512	661	810
		Frequency (MHz)	1850.2	1880.0	1909.8
Maximum Burst-Averaged Output Power					
Head / Body-worn / Hotspot / Extremity	Ant-1	GSM (GMSK, 1Tx-slot)	29.31	29.54	29.65
		GPRS (GMSK, 1Tx-slot)	29.37	29.61	29.72
		GPRS (GMSK, 2Tx-slot)	26.33	26.64	26.83
		GPRS (GMSK, 3Tx-slot)	24.36	24.65	24.88
		GPRS (GMSK, 4Tx-slot)	23.31	23.61	23.85
		EDGE (8PSK, 1Tx-slot)	25.71	25.69	25.80
		EDGE (8PSK, 2Tx-slot)	24.55	24.61	24.71
		EDGE (8PSK, 3Tx-slot)	25.05	25.02	25.07
		EDGE (8PSK, 4Tx-slot)	24.50	24.54	24.63

FCC SAR Test Report

Mode	Tx Antenna	Band	WCDMA Band II			3GPP MPR (dB)
		Channel	9262	9400	9538	
		Frequency (MHz)	1852.4	1880.0	1907.6	
Head	Ant-1	RMC 12.2K	23.21	23.24	23.41	-
		HSDPA Subtest-1	22.09	22.12	22.29	0
		HSDPA Subtest-2	22.13	22.14	22.31	0
		HSDPA Subtest-3	21.68	21.68	21.87	0.5
		HSDPA Subtest-4	21.66	21.69	21.86	0.5
		DC-HSDPA Subtest-1	22.06	22.06	22.23	0
		DC-HSDPA Subtest-2	22.07	22.09	22.26	0
		DC-HSDPA Subtest-3	21.62	21.62	21.79	0.5
		DC-HSDPA Subtest-4	21.60	21.58	21.76	0.5
		HSUPA Subtest-1	21.69	21.72	21.89	0
		HSUPA Subtest-2	20.13	20.15	20.33	2
		HSUPA Subtest-3	21.14	21.17	21.34	1
		HSUPA Subtest-4	19.69	19.71	19.88	2
		HSUPA Subtest-5	21.19	21.22	21.39	0
Body-worn / Hotspot / Extremity	Ant-1	RMC 12.2K	20.49	20.54	20.56	-
		HSDPA Subtest-1	20.43	20.48	20.46	0
		HSDPA Subtest-2	20.47	20.52	20.50	0
		HSDPA Subtest-3	20.41	20.46	20.44	0.5
		HSDPA Subtest-4	20.36	20.41	20.39	0.5
		DC-HSDPA Subtest-1	20.41	20.46	20.44	0
		DC-HSDPA Subtest-2	20.38	20.43	20.41	0
		DC-HSDPA Subtest-3	20.01	20.05	20.03	0.5
		DC-HSDPA Subtest-4	19.98	20.03	20.01	0.5
		HSUPA Subtest-1	19.59	19.64	19.62	0
		HSUPA Subtest-2	18.67	18.72	18.70	2
		HSUPA Subtest-3	19.54	19.59	19.57	1
		HSUPA Subtest-4	18.15	18.20	18.18	2
		HSUPA Subtest-5	19.70	19.75	19.73	0

FCC SAR Test Report

Mode	Tx Antenna	Band	WCDMA Band IV			3GPP MPR (dB)
		Channel	1312	1413	1513	
		Frequency (MHz)	1712.4	1732.6	1752.6	
Head	Ant-1	RMC 12.2K	23.21	23.27	23.25	-
		HSDPA Subtest-1	21.85	21.90	21.88	0
		HSDPA Subtest-2	21.83	21.89	21.85	0
		HSDPA Subtest-3	21.39	21.44	21.42	0.5
		HSDPA Subtest-4	20.95	21.01	20.99	0.5
		DC-HSDPA Subtest-1	21.78	21.83	21.81	0
		DC-HSDPA Subtest-2	21.76	21.82	21.78	0
		DC-HSDPA Subtest-3	21.32	21.37	21.36	0.5
		DC-HSDPA Subtest-4	20.89	20.94	20.92	0.5
		HSUPA Subtest-1	21.42	21.48	21.46	0
		HSUPA Subtest-2	19.96	20.02	20.01	2
		HSUPA Subtest-3	20.93	20.98	20.96	1
		HSUPA Subtest-4	19.42	19.48	19.47	2
		HSUPA Subtest-5	21.02	21.01	21.03	0
Body-worn / Hotspot / Extremity	Ant-1	RMC 12.2K	20.58	20.62	20.59	-
		HSDPA Subtest-1	20.02	20.18	20.13	0
		HSDPA Subtest-2	20.00	20.16	20.11	0
		HSDPA Subtest-3	19.71	19.87	19.82	0.5
		HSDPA Subtest-4	19.67	19.83	19.78	0.5
		DC-HSDPA Subtest-1	20.11	20.27	20.22	0
		DC-HSDPA Subtest-2	20.09	20.25	20.20	0
		DC-HSDPA Subtest-3	19.66	19.82	19.77	0.5
		DC-HSDPA Subtest-4	19.62	19.78	19.73	0.5
		HSUPA Subtest-1	19.21	19.37	19.32	0
		HSUPA Subtest-2	18.30	18.46	18.41	2
		HSUPA Subtest-3	19.29	19.45	19.40	1
		HSUPA Subtest-4	17.80	17.96	17.91	2
		HSUPA Subtest-5	19.30	19.46	19.41	0

FCC SAR Test Report

Mode	Tx Antenna	Band	WCDMA Band V			3GPP MPR (dB)
		Channel	4132	4182	4233	
		Frequency (MHz)	826.4	836.4	846.6	
Head / Body-worn / Hotspot / Extremity	Ant-1	RMC 12.2K	23.29	23.33	23.28	-
		HSDPA Subtest-1	22.17	22.19	22.13	0
		HSDPA Subtest-2	22.10	22.13	22.07	0
		HSDPA Subtest-3	21.69	21.71	21.65	0.5
		HSDPA Subtest-4	21.70	21.73	21.67	0.5
		DC-HSDPA Subtest-1	22.14	22.16	22.10	0
		DC-HSDPA Subtest-2	22.09	22.10	22.04	0
		DC-HSDPA Subtest-3	21.66	21.68	21.62	0.5
		DC-HSDPA Subtest-4	21.68	21.70	21.65	0.5
		HSUPA Subtest-1	21.67	21.71	21.68	0
		HSUPA Subtest-2	20.16	20.18	20.12	2
		HSUPA Subtest-3	21.19	21.22	21.16	1
		HSUPA Subtest-4	19.69	19.72	19.66	2
HSUPA Subtest-5	21.08	21.13	21.07	0		
Head	Ant-3	RMC 12.2K	20.92	20.96	20.85	-
		HSDPA Subtest-1	20.89	20.90	20.81	0
		HSDPA Subtest-2	20.85	20.93	20.85	0
		HSDPA Subtest-3	20.42	20.46	20.39	0.5
		HSDPA Subtest-4	20.38	20.46	20.33	0.5
		DC-HSDPA Subtest-1	20.88	20.93	20.80	0
		DC-HSDPA Subtest-2	20.82	20.91	20.83	0
		DC-HSDPA Subtest-3	20.40	20.47	20.40	0.5
		DC-HSDPA Subtest-4	20.36	20.41	20.30	0.5
		HSUPA Subtest-1	19.22	19.32	19.27	0
		HSUPA Subtest-2	18.76	18.86	18.75	2
		HSUPA Subtest-3	19.85	19.96	19.87	1
		HSUPA Subtest-4	18.48	18.48	18.47	2
HSUPA Subtest-5	20.00	20.00	19.90	0		
Body-worn / Hotspot / Extremity	Ant-3	RMC 12.2K	21.33	21.47	21.45	-
		HSDPA Subtest-1	20.27	20.41	20.39	0
		HSDPA Subtest-2	20.25	20.38	20.37	0
		HSDPA Subtest-3	19.77	19.91	19.89	0.5
		HSDPA Subtest-4	19.75	19.88	19.86	0.5
		DC-HSDPA Subtest-1	20.21	20.36	20.35	0
		DC-HSDPA Subtest-2	20.22	20.33	20.32	0
		DC-HSDPA Subtest-3	19.73	19.86	19.84	0.5
		DC-HSDPA Subtest-4	19.70	19.83	19.82	0.5
		HSUPA Subtest-1	19.27	19.39	19.36	0
		HSUPA Subtest-2	18.32	18.43	18.41	2
		HSUPA Subtest-3	19.33	19.45	19.42	1
		HSUPA Subtest-4	17.75	17.87	17.85	2
HSUPA Subtest-5	19.29	19.41	19.37	0		

FCC SAR Test Report

LTE Band 2																	
Head Ant-1																	
BW	MCS Index	RB Size	RB Offset	Low	Mid	High	3GPP MPR (dB)	BW	MCS Index	RB Size	RB Offset	Low	Mid	High	3GPP MPR (dB)		
		Channel		18700	18900	19100				Channel		18675	18900	19125			
		Frequency (MHz)		1860.0	1880.0	1900.0				Frequency (MHz)		1857.5	1880.0	1902.5			
20M	QPSK	1	0	23.38	23.43	23.36	0	15M	QPSK	1	0	23.35	23.37	23.36	0		
		1	50	23.34	23.39	23.32	0			1	37	23.33	23.32	23.31	0		
		1	99	23.31	23.36	23.29	0			1	74	23.26	23.36	23.21	0		
		50	0	22.73	22.78	22.71	1			36	0	22.64	22.71	22.70	1		
		50	25	22.65	22.70	22.63	1			36	19	22.65	22.64	22.62	1		
		50	50	22.63	22.68	22.61	1			36	39	22.60	22.60	22.53	1		
	100	0	22.66	22.71	22.64	1	75		0	22.64	22.66	22.63	1				
	16QAM	1	0	22.71	22.76	22.69	1		16QAM	1	0	22.61	22.69	22.64	1		
		1	50	22.67	22.72	22.65	1			1	37	22.57	22.67	22.55	1		
		1	99	22.65	22.70	22.63	1			1	74	22.63	22.64	22.60	1		
		50	0	21.74	21.79	21.72	2			36	0	21.64	21.72	21.66	2		
		50	25	21.65	21.70	21.63	2			36	19	21.64	21.65	21.54	2		
		50	50	21.62	21.67	21.60	2			36	39	21.52	21.60	21.58	2		
	100	0	21.71	21.76	21.69	2	75		0	21.65	21.67	21.65	2				
	64QAM	1	0	21.73	21.78	21.71	2		64QAM	1	0	21.66	21.75	21.68	2		
		1	50	21.69	21.74	21.67	2			1	37	21.62	21.66	21.60	2		
		1	99	21.62	21.67	21.60	2			1	74	21.59	21.66	21.50	2		
		50	0	20.68	20.73	20.66	3			36	0	20.58	20.72	20.57	3		
		50	25	20.63	20.68	20.61	3			36	19	20.56	20.67	20.53	3		
		50	50	20.57	20.62	20.55	3			36	39	20.55	20.61	20.53	3		
	100	0	20.59	20.64	20.57	3	75		0	20.56	20.56	20.50	3				
	10M	QPSK	1	0	23.31	23.30	23.26		0	5M	QPSK	1	0	23.24	23.25	23.15	0
			1	24	23.30	23.24	23.28		0			1	12	23.26	23.19	23.04	0
			1	49	23.12	23.28	23.25		0			1	24	23.08	23.17	23.10	0
25			0	22.63	22.68	22.67	1	12	0			22.51	22.71	22.52	1		
25			12	22.45	22.58	22.49	1	12	6			22.47	22.60	22.47	1		
25			25	22.57	22.59	22.44	1	12	13			22.54	22.52	22.40	1		
50		0	22.47	22.61	22.50	1	25	0	22.51		22.66	22.46	1				
16QAM		1	0	22.52	22.58	22.59	1	16QAM	1		0	22.58	22.61	22.63	1		
		1	24	22.56	22.55	22.65	1		1		12	22.48	22.62	22.44	1		
		1	49	22.48	22.52	22.43	1		1		24	22.46	22.54	22.49	1		
		25	0	21.66	21.68	21.67	2		12		0	21.61	21.67	21.56	2		
		25	12	21.53	21.62	21.51	2		12		6	21.50	21.62	21.44	2		
		25	25	21.42	21.58	21.46	2		12		13	21.43	21.62	21.36	2		
50		0	21.49	21.68	21.51	2	25	0	21.63		21.65	21.62	2				
64QAM		1	0	21.60	21.63	21.54	2	64QAM	1		0	21.64	21.69	21.49	2		
		1	24	21.53	21.63	21.56	2		1		12	21.59	21.60	21.50	2		
		1	49	21.52	21.51	21.42	2		1		24	21.48	21.63	21.44	2		
		25	0	20.55	20.52	20.60	3		12		0	20.64	20.56	20.58	3		
		25	12	20.42	20.48	20.57	3		12		6	20.62	20.58	20.49	3		
		25	25	20.45	20.58	20.47	3		12		13	20.46	20.48	20.44	3		
50		0	20.49	20.51	20.48	3	25	0	20.42		20.47	20.39	3				
3M		QPSK	1	0	23.19	23.24	23.23	0	1.4M		QPSK	1	0	23.30	23.40	23.17	0
			1	7	23.16	23.19	23.13	0				1	2	23.23	23.38	23.29	0
			1	14	23.09	23.21	23.21	0				1	5	23.15	23.16	23.15	0
	8		0	22.61	22.76	22.54	1	3		0		23.25	23.26	23.24	0		
	8		3	22.44	22.61	22.51	1	3		1		23.27	23.22	23.25	0		
	8		7	22.58	22.54	22.54	1	3		3		23.31	23.33	23.28	0		
	15	0	22.59	22.64	22.60	1	6	0		22.56	22.57	22.50	1				
	16QAM	1	0	22.62	22.57	22.56	1	16QAM		1	0	22.65	22.60	22.63	1		
		1	7	22.51	22.58	22.52	1			1	2	22.51	22.55	22.52	1		
		1	14	22.59	22.54	22.48	1			1	5	22.43	22.57	22.52	1		
		8	0	21.53	21.65	21.62	2			3	0	22.67	22.60	22.60	1		
		8	3	21.60	21.60	21.54	2			3	1	22.51	22.66	22.43	1		
		8	7	21.49	21.67	21.43	2			3	3	22.50	22.55	22.38	1		
	15	0	21.60	21.67	21.52	2	6	0		21.57	21.61	21.53	2				
	64QAM	1	0	21.56	21.68	21.55	2	64QAM		1	0	21.57	21.70	21.66	2		
		1	7	21.63	21.63	21.61	2			1	2	21.53	21.56	21.53	2		
		1	14	21.50	21.52	21.40	2			1	5	21.52	21.54	21.45	2		
		8	0	20.60	20.70	20.53	3			3	0	21.66	21.53	21.54	2		
		8	3	20.60	20.60	20.49	3			3	1	21.57	21.57	21.54	2		
		8	7	20.50	20.62	20.46	3			3	3	21.40	21.56	21.41	2		
	15	0	20.42	20.45	20.39	3	6	0		20.37	20.56	20.42	3				

FCC SAR Test Report

LTE Band 2															
Body-worn / Hotspot_Ant-1															
BW	MCS Index	RB Size	RB Offset	Low	Mid	High	3GPP MPR (dB)	BW	MCS Index	RB Size	RB Offset	Low	Mid	High	3GPP MPR (dB)
		Channel		18700	18900	19100				Channel		18675	18900	19125	
		Frequency (MHz)		1860.0	1880.0	1900.0				Frequency (MHz)		1857.5	1880.0	1902.5	
20M	QPSK	1	0	17.99	18.13	18.04	0	15M	QPSK	1	0	17.96	18.10	18.02	0
		1	50	17.81	17.94	17.86	0			1	37	17.72	17.92	17.86	0
		1	99	17.57	17.70	17.62	0			1	74	17.55	17.69	17.57	0
		50	0	17.46	17.48	17.42	1			36	0	17.45	17.41	17.39	1
		50	25	17.47	17.47	17.41	1			36	19	17.38	17.38	17.41	1
		50	50	17.41	17.45	17.46	1			36	39	17.39	17.36	17.39	1
	100	0	17.45	17.46	17.42	1	75		0	17.37	17.44	17.33	1		
	16QAM	1	0	17.39	17.49	17.44	1		16QAM	1	0	17.36	17.41	17.44	1
		1	50	17.44	17.48	17.49	1			1	37	17.41	17.46	17.41	1
		1	99	17.45	17.46	17.49	1			1	74	17.39	17.37	17.48	1
		50	0	16.45	16.48	16.49	2			36	0	16.35	16.43	16.39	2
		50	25	16.29	16.43	16.35	2			36	19	16.23	16.39	16.29	2
		50	50	16.28	16.41	16.33	2			36	39	16.20	16.31	16.24	2
	100	0	16.36	16.50	16.42	2	75		0	16.32	16.41	16.33	2		
	64QAM	1	0	16.18	16.32	16.23	2		64QAM	1	0	16.11	16.25	16.19	2
		1	50	16.43	16.47	16.49	2			1	37	16.39	16.42	16.42	2
		1	99	16.16	16.30	16.23	2			1	74	16.10	16.30	16.14	2
		50	0	15.25	15.38	15.30	3			36	0	15.24	15.32	15.28	3
50		25	15.12	15.26	15.18	3	36	19		15.08	15.16	15.14	3		
50		50	15.11	15.24	15.16	3	36	39		15.04	15.24	15.08	3		
100	0	15.19	15.34	15.23	3	75	0	15.09	15.34	15.21	3				
10M	QPSK	1	0	17.91	17.93	17.90	0	5M	QPSK	1	0	17.85	17.90	17.87	0
		1	24	17.57	17.72	17.70	0			1	12	17.71	17.76	17.74	0
		1	49	17.38	17.56	17.41	0			1	24	17.43	17.62	17.49	0
		25	0	17.39	17.26	17.26	1			12	0	17.29	17.40	17.26	1
		25	12	17.47	17.37	17.30	1			12	6	17.34	17.36	17.30	1
		25	25	17.35	17.26	17.23	1			12	13	17.22	17.31	17.31	1
	50	0	17.27	17.24	17.28	1	25		0	17.31	17.42	17.21	1		
	16QAM	1	0	17.24	17.34	17.34	1		16QAM	1	0	17.32	17.47	17.22	1
		1	24	17.32	17.29	17.43	1			1	12	17.35	17.36	17.38	1
		1	49	17.31	17.33	17.37	1			1	24	17.30	17.27	17.40	1
		25	0	16.35	16.40	16.34	2			12	0	16.31	16.31	16.39	2
		25	12	16.14	16.25	16.29	2			12	6	16.10	16.35	16.11	2
		25	25	16.07	16.25	16.20	2			12	13	16.11	16.27	16.17	2
	50	0	16.17	16.45	16.31	2	25		0	16.14	16.49	16.27	2		
	64QAM	1	0	16.07	16.22	16.09	2		64QAM	1	0	16.00	16.15	16.14	2
		1	24	16.25	16.33	16.30	2			1	12	16.31	16.40	16.24	2
		1	49	16.00	16.12	16.11	2			1	24	16.02	16.24	16.10	2
		25	0	15.17	15.31	15.23	3			12	0	15.13	15.22	15.20	3
25		12	14.98	15.17	15.07	3	12	6		14.96	15.14	15.03	3		
25		25	15.02	15.14	15.04	3	12	13		14.95	15.17	15.02	3		
50	0	15.02	15.10	15.16	3	25	0	15.17	15.31	15.09	3				
3M	QPSK	1	0	17.85	17.90	17.93	0	1.4M	QPSK	1	0	17.87	17.97	17.94	0
		1	7	17.67	17.88	17.74	0			1	2	17.73	17.87	17.65	0
		1	14	17.43	17.63	17.44	0			1	5	17.57	17.61	17.42	0
		8	0	17.40	17.29	17.29	1			3	0	17.97	18.03	17.86	0
		8	3	17.30	17.35	17.30	1			3	1	18.01	17.96	17.97	0
		8	7	17.27	17.35	17.28	1			3	3	17.89	17.87	17.86	0
	15	0	17.36	17.30	17.25	1	6		0	16.94	16.93	16.78	1		
	16QAM	1	0	17.29	17.36	17.26	1		16QAM	1	0	16.80	16.87	16.90	1
		1	7	17.33	17.36	17.43	1			1	2	16.94	16.96	17.04	1
		1	14	17.36	17.45	17.48	1			1	5	16.97	16.92	16.86	1
		8	0	16.44	16.35	16.31	2			3	0	16.98	17.02	17.03	1
		8	3	16.13	16.20	16.32	2			3	1	16.87	16.84	16.73	1
		8	7	16.20	16.41	16.25	2			3	3	16.80	16.92	16.90	1
	15	0	16.16	16.37	16.33	2	6		0	15.79	15.94	15.84	2		
	64QAM	1	0	16.06	16.11	16.18	2		64QAM	1	0	15.67	15.73	15.67	2
		1	7	16.28	16.43	16.35	2			1	2	15.88	15.84	15.87	2
		1	14	15.99	16.19	16.13	2			1	5	15.76	15.87	15.65	2
		8	0	15.09	15.29	15.16	3			3	0	15.82	15.85	15.82	2
8		3	15.09	15.12	15.06	3	3	1		15.63	15.82	15.70	2		
8		7	15.11	15.01	15.01	3	3	3		15.58	15.67	15.66	2		
15	0	15.05	15.26	15.09	3	6	0	14.56	14.87	14.62	3				

FCC SAR Test Report

LTE Band 2															
Extremity_Ant-1															
BW	MCS Index	RB Size	RB Offset	Low	Mid	High	3GPP MPR (dB)	BW	MCS Index	RB Size	RB Offset	Low	Mid	High	3GPP MPR (dB)
		Channel		18700	18900	19100				Channel		18675	18900	19125	
		Frequency (MHz)		1860.0	1880.0	1900.0				Frequency (MHz)		1857.5	1880.0	1902.5	
20M	QPSK	1	0	22.46	22.51	22.41	0	15M	QPSK	1	0	22.33	22.36	22.31	0
		1	50	22.24	22.28	22.16	0			1	37	22.18	22.28	22.06	0
		1	99	22.02	22.06	21.95	0			1	74	21.99	21.97	21.89	0
		50	0	21.88	21.92	21.83	1			36	0	21.84	21.87	21.80	1
		50	25	21.72	21.75	21.66	1			36	19	21.64	21.72	21.57	1
		50	50	21.70	21.76	21.65	1			36	39	21.69	21.72	21.60	1
	100	0	21.80	21.87	21.74	1	75		0	21.77	21.80	21.70	1		
	16QAM	1	0	21.84	21.84	21.75	1		16QAM	1	0	21.82	21.84	21.66	1
		1	50	21.97	21.99	21.92	1			1	37	21.94	21.89	21.88	1
		1	99	21.87	21.93	21.83	1			1	74	21.79	21.89	21.80	1
		50	0	20.92	20.97	20.87	2			36	0	20.85	20.96	20.81	2
		50	25	20.78	20.85	20.73	2			36	19	20.75	20.79	20.65	2
		50	50	20.75	20.80	20.75	2			36	39	20.73	20.77	20.73	2
	100	0	20.83	20.89	20.74	2	75		0	20.80	20.81	20.74	2		
	64QAM	1	0	20.81	20.87	20.76	2		64QAM	1	0	20.74	20.78	20.70	2
		1	50	20.93	20.98	20.88	2			1	37	20.92	20.93	20.83	2
		1	99	20.83	20.89	20.76	2			1	74	20.77	20.86	20.68	2
		50	0	19.91	19.96	19.86	3			36	0	19.84	19.89	19.81	3
50		25	19.77	19.84	19.71	3	36	19		19.67	19.82	19.71	3		
50		50	19.78	19.83	19.74	3	36	39		19.68	19.80	19.64	3		
100	0	19.83	19.87	19.76	3	75	0	19.82	19.85	19.76	3				
10M	QPSK	1	0	22.17	22.34	22.17	0	5M	QPSK	1	0	22.22	22.26	22.23	0
		1	24	22.08	22.17	22.01	0			1	12	22.22	22.09	21.95	0
		1	49	21.90	21.92	21.85	0			1	24	21.79	21.90	21.83	0
		25	0	21.70	21.73	21.68	1			12	0	21.75	21.82	21.55	1
		25	12	21.56	21.55	21.50	1			12	6	21.63	21.63	21.53	1
		25	25	21.56	21.59	21.54	1			12	13	21.61	21.65	21.53	1
	50	0	21.69	21.71	21.57	1	25		0	21.76	21.74	21.59	1		
	16QAM	1	0	21.71	21.61	21.62	1		16QAM	1	0	21.82	21.71	21.65	1
		1	24	21.76	21.83	21.79	1			1	12	21.89	21.88	21.89	1
		1	49	21.70	21.82	21.62	1			1	24	21.70	21.74	21.69	1
		25	0	20.74	20.78	20.67	2			12	0	20.84	20.77	20.75	2
		25	12	20.65	20.63	20.67	2			12	6	20.60	20.75	20.61	2
		25	25	20.61	20.66	20.62	2			12	13	20.61	20.66	20.55	2
	50	0	20.79	20.72	20.58	2	25		0	20.72	20.69	20.57	2		
	64QAM	1	0	20.58	20.82	20.69	2		64QAM	1	0	20.72	20.69	20.65	2
		1	24	20.68	20.86	20.78	2			1	12	20.84	20.85	20.79	2
		1	49	20.76	20.81	20.73	2			1	24	20.76	20.74	20.63	2
		25	0	19.90	19.81	19.69	3			12	0	19.70	19.91	19.72	3
25		12	19.69	19.66	19.60	3	12	6		19.63	19.65	19.60	3		
25		25	19.62	19.69	19.62	3	12	13		19.74	19.60	19.56	3		
50	0	19.77	19.71	19.61	3	25	0	19.70	19.81	19.67	3				
3M	QPSK	1	0	22.34	22.29	22.17	0	1.4M	QPSK	1	0	21.92	22.01	21.81	0
		1	7	22.04	22.20	22.03	0			1	2	21.63	21.78	21.72	0
		1	14	21.85	21.83	21.81	0			1	5	21.45	21.52	21.38	0
		8	0	21.67	21.69	21.64	1			3	0	22.40	22.33	22.29	0
		8	3	21.62	21.73	21.56	1			3	1	22.21	22.19	22.20	0
		8	7	21.64	21.59	21.47	1			3	3	22.26	22.13	22.09	0
	15	0	21.69	21.81	21.61	1	6		0	21.17	21.37	21.27	1		
	16QAM	1	0	21.71	21.76	21.65	1		16QAM	1	0	21.33	21.22	21.23	1
		1	7	21.91	21.94	21.81	1			1	2	21.37	21.47	21.36	1
		1	14	21.85	21.88	21.77	1			1	5	21.38	21.49	21.36	1
		8	0	20.85	20.75	20.71	2			3	0	21.33	21.48	21.24	1
		8	3	20.68	20.76	20.63	2			3	1	21.26	21.39	21.18	1
		8	7	20.56	20.72	20.65	2			3	3	21.25	21.30	21.16	1
	15	0	20.70	20.81	20.58	2	6		0	20.29	20.33	20.25	2		
	64QAM	1	0	20.70	20.74	20.60	2		64QAM	1	0	20.35	20.29	20.17	2
		1	7	20.90	20.93	20.73	2			1	2	20.36	20.53	20.37	2
		1	14	20.65	20.70	20.60	2			1	5	20.28	20.27	20.24	2
		8	0	19.88	19.81	19.71	3			3	0	20.28	20.46	20.32	2
8		3	19.59	19.78	19.59	3	3	1		20.24	20.28	20.28	2		
8		7	19.64	19.77	19.51	3	3	3		20.33	20.28	20.20	2		
15	0	19.61	19.73	19.67	3	6	0	19.32	19.37	19.32	3				

FCC SAR Test Report

LTE Band 4																	
Head Ant-1																	
BW	MCS Index	RB Size	RB Offset	Low	Mid	High	3GPP MPR (dB)	BW	MCS Index	RB Size	RB Offset	Low	Mid	High	3GPP MPR (dB)		
		Channel		20050	20175	20300				Channel		20025	20175	20325			
		Frequency (MHz)		1720.0	1732.5	1745.0				Frequency (MHz)		1717.5	1732.5	1747.5			
20M	QPSK	1	0	22.67	22.73	22.74	0	15M	QPSK	1	0	22.65	22.65	22.74	0		
		1	50	23.01	23.09	23.11	0			1	37	22.94	23.05	23.09	0		
		1	99	22.75	22.80	22.82	0			1	74	22.70	22.70	22.77	0		
		50	0	22.12	22.18	22.20	1			36	0	22.02	22.12	22.18	1		
		50	25	22.06	22.09	22.12	1			36	19	22.00	22.03	22.09	1		
		50	50	22.03	22.06	22.08	1			36	39	21.99	21.96	22.00	1		
	100	0	22.09	22.18	22.19	1	75		0	22.04	22.18	22.13	1				
	16QAM	1	0	22.18	22.27	22.28	1		16QAM	1	0	22.14	22.22	22.28	1		
		1	50	22.41	22.47	22.50	1			1	37	22.40	22.42	22.49	1		
		1	99	22.17	22.21	22.22	1			1	74	22.09	22.16	22.17	1		
		50	0	21.24	21.30	21.33	2			36	0	21.18	21.22	21.33	2		
		50	25	21.18	21.22	21.24	2			36	19	21.09	21.20	21.15	2		
		50	50	21.11	21.16	21.17	2			36	39	21.02	21.08	21.14	2		
	100	0	21.17	21.21	21.26	2	75		0	21.10	21.21	21.21	2				
	64QAM	1	0	20.87	20.93	20.94	2		64QAM	1	0	20.79	20.88	20.89	2		
		1	50	21.25	21.32	21.35	2			1	37	21.15	21.31	21.29	2		
		1	99	20.96	21.05	21.06	2			1	74	20.93	21.02	21.06	2		
		50	0	20.17	20.27	20.30	3			36	0	20.16	20.18	20.27	3		
		50	25	20.12	20.18	20.22	3			36	19	20.06	20.13	20.14	3		
		50	50	20.10	20.14	20.17	3			36	39	20.01	20.06	20.15	3		
	100	0	20.15	20.25	20.28	3	75		0	20.11	20.22	20.28	3				
	10M	QPSK	1	0	22.61	22.72	22.67		0	5M	QPSK	1	0	22.60	22.48	22.42	0
			1	24	22.93	22.99	22.98		0			1	12	22.88	23.01	22.97	0
			1	49	22.55	22.69	22.63		0			1	24	22.60	22.62	22.50	0
25			0	21.97	22.13	22.01	1	12	0			21.98	22.07	22.04	1		
25			12	22.01	21.94	22.05	1	12	6			21.95	21.92	21.77	1		
25			25	21.93	21.98	21.94	1	12	13			21.95	21.87	21.91	1		
50		0	21.92	22.00	22.05	1	25	0	21.89		22.07	22.05	1				
16QAM		1	0	22.01	22.13	22.09	1	16QAM	1		0	22.06	22.19	22.13	1		
		1	24	22.26	22.25	22.45	1		1		12	22.26	22.33	22.36	1		
		1	49	22.09	22.13	22.06	1		1		24	22.04	22.10	22.22	1		
		25	0	21.05	21.24	21.27	2		12		0	21.04	21.21	21.10	2		
		25	12	21.09	21.13	21.10	2		12		6	21.06	21.09	21.11	2		
		25	25	21.01	21.10	21.08	2		12		13	20.98	21.07	21.13	2		
50		0	21.04	21.16	21.25	2	25	0	21.07		21.06	21.19	2				
64QAM		1	0	20.78	20.74	20.86	2	64QAM	1		0	20.66	20.72	20.86	2		
		1	24	21.10	21.16	21.22	2		1		12	21.11	21.19	21.26	2		
		1	49	20.76	20.90	20.86	2		1		24	20.79	20.93	21.01	2		
		25	0	20.08	20.10	20.10	3		12		0	20.13	20.17	20.18	3		
		25	12	20.04	20.06	20.07	3		12		6	20.06	20.01	20.09	3		
		25	25	19.95	19.90	20.01	3		12		13	20.09	20.03	20.08	3		
50		0	20.02	20.20	20.16	3	25	0	20.03		20.14	20.06	3				
3M		QPSK	1	0	22.55	22.69	22.55	0	1.4M		QPSK	1	0	22.60	22.57	22.66	0
			1	7	22.99	23.02	22.96	0				1	2	22.94	22.95	22.94	0
			1	14	22.63	22.64	22.67	0				1	5	22.67	22.64	22.68	0
	8		0	22.03	21.99	22.10	1	3		0		22.94	23.08	23.08	0		
	8		3	22.03	21.94	21.95	1	3		1		22.95	22.92	22.92	0		
	8		7	21.89	22.00	21.87	1	3		3		22.90	22.89	23.02	0		
	15	0	21.97	22.06	22.01	1	6	0		21.98	22.13	22.11	1				
	16QAM	1	0	22.04	22.05	22.09	1	16QAM		1	0	21.97	22.20	22.11	1		
		1	7	22.35	22.42	22.45	1			1	2	22.29	22.26	22.36	1		
		1	14	22.00	22.13	22.13	1			1	5	22.01	22.09	22.03	1		
		8	0	21.14	21.28	21.24	2			3	0	22.16	22.23	22.13	1		
		8	3	21.16	21.14	21.08	2			3	1	21.99	22.21	22.08	1		
		8	7	20.92	21.13	21.07	2			3	3	21.98	22.03	22.00	1		
	15	0	20.99	21.08	21.20	2	6	0		21.07	21.11	21.11	2				
	64QAM	1	0	20.73	20.79	20.86	2	64QAM		1	0	20.79	20.84	20.83	2		
		1	7	21.11	21.24	21.21	2			1	2	21.17	21.17	21.16	2		
		1	14	20.83	21.03	20.84	2			1	5	20.85	20.91	20.86	2		
		8	0	20.03	20.16	20.13	3			3	0	21.10	21.12	21.17	2		
		8	3	19.92	20.02	20.08	3			3	1	21.04	21.04	21.10	2		
		8	7	19.93	20.03	20.09	3			3	3	20.98	21.02	20.99	2		
	15	0	20.08	20.05	20.15	3	6	0		19.93	20.02	20.19	3				

FCC SAR Test Report

LTE Band 4															
Body-worn / Hotspot / Extremity Ant-1															
BW	MCS Index	RB Size	RB Offset	Low	Mid	High	3GPP MPR (dB)	BW	MCS Index	RB Size	RB Offset	Low	Mid	High	3GPP MPR (dB)
				20050	20175	20300						20025	20175	20325	
				Channel	Channel	Channel						Channel	Channel	Channel	
		Frequency (MHz)		1720.0	1732.5	1745.0			Frequency (MHz)		1717.5	1732.5	1747.5		
20M	QPSK	1	0	20.62	20.64	20.67	0	15M	QPSK	1	0	20.57	20.64	20.64	0
		1	50	20.71	20.73	20.76	0			1	37	20.69	20.67	20.66	0
		1	99	20.69	20.71	20.74	0			1	74	20.61	20.65	20.64	0
		50	0	19.64	19.66	19.69	1			36	0	19.55	19.57	19.64	1
		50	25	19.60	19.62	19.65	1			36	19	19.57	19.62	19.64	1
		50	50	19.57	19.59	19.62	1			36	39	19.55	19.59	19.57	1
		100	0	19.59	19.61	19.64	1			75	0	19.56	19.61	19.60	1
	16QAM	1	0	19.63	19.65	19.68	1		16QAM	1	0	19.56	19.62	19.64	1
		1	50	19.70	19.72	19.75	1			1	37	19.64	19.72	19.67	1
		1	99	19.66	19.68	19.71	1			1	74	19.64	19.58	19.67	1
		50	0	18.63	18.65	18.68	2			36	0	18.62	18.55	18.62	2
		50	25	18.60	18.62	18.65	2			36	19	18.56	18.56	18.56	2
		50	50	18.57	18.59	18.62	2			36	39	18.57	18.49	18.60	2
	64QAM	100	0	18.59	18.61	18.64	2		64QAM	75	0	18.57	18.51	18.59	2
		1	0	18.61	18.63	18.66	2			1	0	18.52	18.54	18.59	2
		1	50	18.67	18.69	18.72	2			1	37	18.63	18.63	18.65	2
		1	99	18.59	18.61	18.64	2			1	74	18.59	18.60	18.60	2
		50	0	17.66	17.68	17.71	3			36	0	17.63	17.66	17.65	3
		50	25	17.62	17.64	17.67	3			36	19	17.59	17.60	17.59	3
	50	50	17.59	17.61	17.64	3	36		39	17.54	17.56	17.63	3		
	100	0	17.61	17.63	17.66	3	75		0	17.57	17.62	17.56	3		
10M	QPSK	1	0	20.56	20.57	20.58	0	5M	QPSK	1	0	20.53	20.60	20.42	0
		1	24	20.64	20.63	20.69	0			1	12	20.67	20.65	20.58	0
		1	49	20.54	20.60	20.69	0			1	24	20.59	20.54	20.42	0
		25	0	19.51	19.53	19.61	1			12	0	19.54	19.57	19.52	1
		25	12	19.43	19.52	19.46	1			12	6	19.50	19.56	19.39	1
		25	25	19.43	19.46	19.50	1			12	13	19.48	19.51	19.40	1
		50	0	19.47	19.51	19.47	1			25	0	19.41	19.46	19.49	1
	16QAM	1	0	19.40	19.41	19.46	1		16QAM	1	0	19.45	19.57	19.55	1
		1	24	19.53	19.68	19.56	1			1	12	19.51	19.60	19.53	1
		1	49	19.49	19.61	19.51	1			1	24	19.48	19.46	19.63	1
		25	0	18.41	18.48	18.55	2			12	0	18.53	18.59	18.63	2
		25	12	18.44	18.44	18.55	2			12	6	18.56	18.43	18.47	2
		25	25	18.46	18.40	18.57	2			12	13	18.47	18.49	18.55	2
	64QAM	50	0	18.50	18.47	18.45	2		64QAM	25	0	18.39	18.45	18.45	2
		1	0	18.53	18.40	18.50	2			1	0	18.38	18.43	18.62	2
		1	24	18.61	18.56	18.51	2			1	12	18.50	18.46	18.72	2
		1	49	18.48	18.38	18.51	2			1	24	18.42	18.44	18.50	2
		25	0	17.59	17.58	17.60	3			12	0	17.51	17.58	17.54	3
		25	12	17.42	17.43	17.57	3			12	6	17.47	17.58	17.53	3
	25	25	17.38	17.38	17.64	3	12		13	17.46	17.55	17.58	3		
	50	0	17.44	17.52	17.56	3	25		0	17.46	17.56	17.42	3		
3M	QPSK	1	0	20.52	20.53	20.58	0	1.4M	QPSK	1	0	20.48	20.54	20.56	0
		1	7	20.64	20.59	20.75	0			1	2	20.50	20.57	20.74	0
		1	14	20.50	20.64	20.61	0			1	5	20.50	20.55	20.58	0
		8	0	19.46	19.54	19.46	1			3	0	20.42	20.51	20.55	0
		8	3	19.39	19.49	19.51	1			3	1	20.49	20.59	20.41	0
		8	7	19.51	19.43	19.42	1			3	3	20.47	20.48	20.41	0
		15	0	19.42	19.45	19.47	1			6	0	19.42	19.48	19.49	1
	16QAM	1	0	19.50	19.46	19.67	1		16QAM	1	0	19.47	19.42	19.48	1
		1	7	19.57	19.59	19.56	1			1	2	19.70	19.52	19.65	1
		1	14	19.51	19.55	19.63	1			1	5	19.60	19.50	19.64	1
		8	0	18.53	18.45	18.62	2			3	0	19.52	19.57	19.45	1
		8	3	18.39	18.47	18.51	2			3	1	19.55	19.51	19.48	1
		8	7	18.34	18.40	18.57	2			3	3	19.48	19.54	19.56	1
	64QAM	15	0	18.48	18.51	18.42	2		64QAM	6	0	18.39	18.49	18.55	2
		1	0	18.39	18.47	18.50	2			1	0	18.50	18.57	18.50	2
		1	7	18.48	18.55	18.62	2			1	2	18.56	18.64	18.64	2
		1	14	18.47	18.44	18.54	2			1	5	18.47	18.48	18.61	2
		8	0	17.49	17.60	17.52	3			3	0	18.60	18.57	18.65	2
		8	3	17.45	17.51	17.50	3			3	1	18.51	18.59	18.52	2
	8	7	17.54	17.44	17.55	3	3		3	18.36	18.50	18.60	2		
	15	0	17.54	17.54	17.53	3	6		0	17.57	17.39	17.59	3		

FCC SAR Test Report

LTE Band 5																	
Head / Body-worn / Hotspot / Extremity Ant-1																	
BW	MCS Index	RB Size	RB Offset	Low	Mid	High	3GPP MPR (dB)	BW	MCS Index	RB Size	RB Offset	Low	Mid	High	3GPP MPR (dB)		
		Channel		20450	20525	20600				Channel		20425	20525	20625			
		Frequency (MHz)		829.0	836.5	844.0				Frequency (MHz)		826.5	836.5	846.5			
10M	QPSK	1	0	23.50	23.56	23.53	0	5M	QPSK	1	0	23.33	23.38	23.38	0		
		1	24	23.43	23.49	23.46	0			1	12	23.26	23.45	23.24	0		
		1	49	23.40	23.46	23.43	0			1	24	23.19	23.45	23.31	0		
		25	0	22.43	22.49	22.46	1			12	0	22.38	22.39	22.19	1		
		25	12	22.40	22.46	22.43	1			12	6	22.21	22.25	22.16	1		
		25	25	22.36	22.42	22.39	1			12	13	22.27	22.23	22.30	1		
		50	0	22.45	22.51	22.48	1			25	0	22.34	22.39	22.33	1		
	16QAM	1	0	22.44	22.50	22.47	1		16QAM	1	0	22.42	22.46	22.29	1		
		1	24	22.41	22.47	22.44	1			1	12	22.32	22.26	22.35	1		
		1	49	22.30	22.36	22.33	1			1	24	22.12	22.28	22.19	1		
		25	0	21.46	21.52	21.49	2			12	0	21.31	21.40	21.35	2		
		25	12	21.37	21.43	21.40	2			12	6	21.23	21.29	21.35	2		
		25	25	21.31	21.37	21.34	2			12	13	21.22	21.24	21.32	2		
		50	0	21.46	21.52	21.49	2			25	0	21.28	21.39	21.29	2		
	64QAM	1	0	21.48	21.54	21.51	2		64QAM	1	0	21.28	21.43	21.50	2		
		1	24	21.44	21.50	21.47	2			1	12	21.23	21.47	21.38	2		
		1	49	21.40	21.46	21.43	2			1	24	21.24	21.40	21.25	2		
		25	0	20.51	20.57	20.54	3			12	0	20.29	20.41	20.43	3		
		25	12	20.47	20.53	20.50	3			12	6	20.43	20.46	20.41	3		
		25	25	20.43	20.49	20.46	3			12	13	20.27	20.29	20.35	3		
		50	0	20.42	20.48	20.45	3			25	0	20.30	20.40	20.29	3		
3M	QPSK	1	0	23.31	23.47	23.44	0	1.4M	QPSK	1	0	23.43	23.46	23.47	0		
		1	7	23.26	23.34	23.29	0			1	2	23.22	23.42	23.40	0		
		1	14	23.34	23.34	23.19	0			1	5	23.34	23.37	23.25	0		
		8	0	22.31	22.44	22.27	1			3	0	23.29	23.44	23.33	0		
		8	3	22.22	22.32	22.28	1			3	1	23.27	23.41	23.34	0		
		8	7	22.27	22.24	22.31	1			3	3	23.24	23.27	23.39	0		
		15	0	22.29	22.40	22.37	1			6	0	22.32	22.38	22.40	1		
		16QAM	1	0	22.30	22.45	22.38			1	16QAM	1	0	22.26	22.42	22.40	1
			1	7	22.27	22.30	22.30			1		1	2	22.35	22.42	22.28	1
	1		14	22.16	22.29	22.16	1		1	5		22.10	22.24	22.10	1		
	8		0	21.26	21.33	21.38	2		3	0		22.23	22.44	22.30	1		
	8		3	21.26	21.36	21.23	2		3	1		22.36	22.23	22.36	1		
	8		7	21.22	21.20	21.19	2		3	3		22.23	22.28	22.28	1		
	15		0	21.45	21.33	21.49	2		6	0		21.31	21.46	21.29	2		
	64QAM	1	0	21.44	21.40	21.39	2		64QAM	1	0	21.44	21.43	21.39	2		
		1	7	21.43	21.47	21.28	2			1	2	21.30	21.37	21.39	2		
		1	14	21.25	21.33	21.28	2			1	5	21.20	21.38	21.22	2		
		8	0	20.39	20.48	20.37	3			3	0	21.45	21.38	21.34	2		
		8	3	20.32	20.50	20.40	3			3	1	21.35	21.46	21.27	2		
		8	7	20.31	20.33	20.32	3			3	3	21.41	21.26	21.43	2		
		15	0	20.37	20.30	20.21	3			6	0	20.29	20.36	20.34	3		

FCC SAR Test Report

LTE Band 5																	
Head / Body-worn / Hotspot / Extremity Ant-3																	
BW	MCS Index	RB Size	RB Offset	Low	Mid	High	3GPP MPR (dB)	BW	MCS Index	RB Size	RB Offset	Low	Mid	High	3GPP MPR (dB)		
		Channel		20450	20525	20600				Channel		20425	20525	20625			
		Frequency (MHz)		829.0	836.5	844.0				Frequency (MHz)		826.5	836.5	846.5			
10M	QPSK	1	0	21.69	21.77	21.74	0	5M	QPSK	1	0	21.69	21.72	21.70	0		
		1	24	21.67	21.75	21.72	0			1	12	21.65	21.72	21.67	0		
		1	49	21.59	21.67	21.64	0			1	24	21.53	21.58	21.62	0		
		25	0	20.67	20.75	20.72	1			12	0	20.66	20.69	20.70	1		
		25	12	20.63	20.71	20.68	1			12	6	20.63	20.62	20.66	1		
		25	25	20.61	20.69	20.66	1			12	13	20.60	20.68	20.63	1		
		50	0	20.66	20.74	20.71	1			25	0	20.57	20.64	20.68	1		
	16QAM	1	0	20.90	20.98	20.95	1		16QAM	1	0	20.82	20.97	20.92	1		
		1	24	20.84	20.92	20.89	1			1	12	20.78	20.91	20.81	1		
		1	49	20.79	20.87	20.84	1			1	24	20.71	20.79	20.74	1		
		25	0	19.74	19.82	19.79	2			12	0	19.65	19.80	19.71	2		
		25	12	18.68	18.76	18.73	2			12	6	18.59	18.69	18.68	2		
		25	25	19.66	19.74	19.71	2			12	13	19.59	19.70	19.67	2		
		50	0	19.67	19.75	19.72	2			25	0	19.61	19.70	19.69	2		
	64QAM	1	0	19.89	19.97	19.94	2		64QAM	1	0	19.80	19.95	19.86	2		
		1	24	19.87	19.95	19.92	2			1	12	19.86	19.94	19.88	2		
		1	49	19.80	19.88	19.85	2			1	24	19.80	19.85	19.79	2		
		25	0	18.69	18.77	18.74	3			12	0	18.65	18.70	18.73	3		
		25	12	18.67	18.75	18.72	3			12	6	18.59	18.73	18.63	3		
		25	25	18.64	18.72	18.69	3			12	13	18.55	18.63	18.61	3		
		50	0	18.73	18.81	18.78	3			25	0	18.65	18.77	18.70	3		
	3M	QPSK	1	0	21.53	21.68	21.62		0	1.4M	QPSK	1	0	21.57	21.66	21.58	0
			1	7	21.50	21.63	21.54		0			1	2	21.53	21.66	21.66	0
			1	14	21.42	21.57	21.48		0			1	5	21.45	21.61	21.55	0
8			0	20.50	20.66	20.65	1	3	0			21.52	21.50	21.69	0		
8			3	20.46	20.56	20.48	1	3	1			21.49	21.56	21.53	0		
8			7	20.43	20.51	20.57	1	3	3			21.46	21.57	21.50	0		
15			0	20.60	20.59	20.59	1	6	0			20.64	20.61	20.50	1		
16QAM			1	0	20.78	20.78	20.73	1	16QAM			1	0	20.82	20.81	20.81	1
			1	7	20.79	20.73	20.80	1				1	2	20.63	20.75	20.67	1
		1	14	20.68	20.76	20.61	1	1			5	20.72	20.78	20.66	1		
		8	0	19.61	19.72	19.58	2	3			0	20.56	20.63	20.68	1		
		8	3	18.49	18.64	18.59	2	3			1	19.66	19.65	19.66	1		
		8	7	19.56	19.63	19.58	2	3			3	20.64	20.61	20.51	1		
15		0	19.56	19.63	19.65	2	6	0	19.50		19.62	19.69	2				
64QAM		1	0	19.74	19.88	19.78	2	64QAM	1		0	19.78	19.85	19.81	2		
		1	7	19.77	19.83	19.74	2		1		2	19.73	19.88	19.86	2		
		1	14	19.71	19.75	19.63	2		1		5	19.77	19.84	19.69	2		
		8	0	18.66	18.54	18.69	3		3		0	19.66	19.63	19.58	2		
		8	3	18.54	18.69	18.67	3		3		1	19.59	19.63	19.59	2		
		8	7	18.52	18.58	18.61	3		3		3	19.51	19.71	19.62	2		
		15	0	18.67	18.72	18.65	3		6		0	18.70	18.77	18.63	3		

FCC SAR Test Report

LTE Band 7																	
Head / Body-worn / Hotspot / Extremity Ant-2																	
BW	MCS Index	RB Size	RB Offset	Low	Mid	High	3GPP MPR (dB)	BW	MCS Index	RB Size	RB Offset	Low	Mid	High	3GPP MPR (dB)		
		Channel		20850	21100	21350				Channel		20825	21100	21375			
		Frequency (MHz)		2510.0	2535.0	2560.0				Frequency (MHz)		2507.5	2535.0	2562.5			
20M	QPSK	1	0	23.27	23.31	23.45	0	15M	QPSK	1	0	23.26	23.27	23.44	0		
		1	50	23.42	23.46	23.60	0			1	37	23.41	23.36	23.54	0		
		1	99	23.23	23.27	23.41	0			1	74	23.19	23.22	23.34	0		
		50	0	22.34	22.38	22.52	1			36	0	22.29	22.28	22.47	1		
		50	25	22.31	22.35	22.49	1			36	19	22.23	22.34	22.42	1		
		50	50	22.25	22.29	22.43	1			36	39	22.15	22.28	22.43	1		
	100	0	22.30	22.34	22.48	1	75		0	22.21	22.31	22.45	1				
	16QAM	1	0	22.33	22.37	22.51	1		16QAM	1	0	22.26	22.30	22.49	1		
		1	50	22.72	22.76	22.90	1			1	37	22.66	22.76	22.89	1		
		1	99	22.69	22.73	22.87	1			1	74	22.67	22.64	22.83	1		
		50	0	21.31	21.35	21.49	2			36	0	21.21	21.33	21.47	2		
		50	25	21.33	21.37	21.51	2			36	19	21.31	21.27	21.43	2		
		50	50	21.26	21.30	21.44	2			36	39	21.18	21.25	21.36	2		
		100	0	21.27	21.31	21.45	2			75	0	21.23	21.26	21.45	2		
		64QAM	1	0	21.22	21.26	21.40			2	64QAM	1	0	21.20	21.24	21.34	2
			1	50	21.53	21.57	21.71			2		1	37	21.44	21.49	21.62	2
			1	99	21.42	21.46	21.60			2		1	74	21.32	21.45	21.52	2
			50	0	20.29	20.33	20.47			3		36	0	20.26	20.33	20.37	3
			50	25	20.27	20.31	20.45			3		36	19	20.19	20.31	20.38	3
	50		50	20.18	20.22	20.36	3		36	39		20.14	20.13	20.32	3		
	100	0	20.30	20.34	20.48	3	75		0	20.26	20.31	20.45	3				
	BW	MCS Index	RB Size	RB Offset	Low	Mid	High		3GPP MPR (dB)	BW	MCS Index	RB Size	RB Offset	Low	Mid	High	3GPP MPR (dB)
			Channel		20800	21100	21400					Channel		20775	21100	21425	
			Frequency (MHz)		2505.0	2535.0	2565.0					Frequency (MHz)		2502.5	2535.0	2567.5	
10M	QPSK	1	0	23.05	23.18	23.41	0	5M	QPSK	1	0	23.13	23.17	23.06	0		
		1	24	23.28	23.39	23.57	0			1	12	23.28	23.32	23.41	0		
		1	49	23.11	23.12	23.36	0			1	24	23.02	23.06	23.20	0		
		25	0	22.17	22.24	22.35	1			12	0	22.25	22.18	22.40	1		
		25	12	22.11	22.26	22.33	1			12	6	22.15	22.14	22.20	1		
		25	25	22.17	22.19	22.34	1			12	13	22.07	22.05	22.29	1		
	50	0	22.24	22.25	22.37	1	25		0	22.19	22.12	22.28	1				
	16QAM	1	0	22.29	22.17	22.38	1		16QAM	1	0	22.14	22.32	22.34	1		
		1	24	22.58	22.64	22.77	1			1	12	22.65	22.68	22.80	1		
		1	49	22.65	22.66	22.80	1			1	24	22.63	22.70	22.68	1		
		25	0	21.12	21.26	21.39	2			12	0	21.18	21.25	21.34	2		
		25	12	21.27	21.22	21.46	2			12	6	21.27	21.29	21.44	2		
		25	25	21.16	21.16	21.37	2			12	13	21.03	21.16	21.33	2		
	50	0	21.10	21.25	21.32	2	25		0	21.16	21.11	21.29	2				
	64QAM	1	0	21.07	21.13	21.26	2		64QAM	1	0	21.10	21.23	21.29	2		
		1	24	21.29	21.43	21.46	2			1	12	21.36	21.49	21.56	2		
		1	49	21.26	21.28	21.37	2			1	24	21.37	21.40	21.46	2		
		25	0	20.27	20.21	20.42	3			12	0	20.10	20.29	20.40	3		
		25	12	20.19	20.11	20.33	3			12	6	20.15	20.28	20.33	3		
		25	25	20.12	20.08	20.31	3			12	13	20.00	20.11	20.24	3		
	50	0	20.15	20.24	20.29	3	25		0	20.19	20.25	20.41	3				

FCC SAR Test Report

LTE Band 38															
Head / Body-worn / Hotspot / Extremity Ant-2															
BW	MCS Index	RB Size	RB Offset	Low	Mid	High	3GPP MPR (dB)	BW	MCS Index	RB Size	RB Offset	Low	Mid	High	3GPP MPR (dB)
		Channel		37850	38000	38150				Channel		37825	38000	38175	
		Frequency (MHz)		2580	2595	2610				Frequency (MHz)		2577.5	2595	2612.5	
20M	QPSK	1	0	23.27	23.32	23.42	0	15M	QPSK	1	0	23.21	23.31	23.39	0
		1	50	23.51	23.56	23.66	0			1	37	23.47	23.52	23.60	0
		1	99	23.30	23.35	23.45	0			1	74	23.28	23.25	23.35	0
		50	0	22.42	22.47	22.57	1			36	0	22.33	22.38	22.48	1
		50	25	22.46	22.51	22.61	1			36	19	22.43	22.49	22.58	1
		50	50	22.20	22.25	22.35	1			36	39	22.14	22.19	22.30	1
		100	0	22.44	22.49	22.59	1			75	0	22.43	22.41	22.51	1
	16QAM	1	0	22.37	22.42	22.52	1		16QAM	1	0	22.29	22.42	22.45	1
		1	50	22.59	22.64	22.74	1			1	37	22.59	22.61	22.67	1
		1	99	22.42	22.47	22.57	1			1	74	22.39	22.44	22.54	1
		50	0	21.50	21.55	21.65	2			36	0	21.50	21.50	21.56	2
		50	25	21.62	21.67	21.77	2			36	19	21.54	21.59	21.74	2
		50	50	21.43	21.48	21.58	2			36	39	21.35	21.44	21.54	2
		100	0	21.47	21.52	21.62	2			75	0	21.47	21.45	21.57	2
	64QAM	1	0	21.14	21.19	21.29	2		64QAM	1	0	21.08	21.12	21.24	2
		1	50	21.32	21.37	21.47	2			1	37	21.24	21.37	21.37	2
		1	99	21.06	21.11	21.21	2			1	74	21.01	21.10	21.19	2
		50	0	20.46	20.51	20.61	3			36	0	20.42	20.50	20.60	3
		50	25	20.51	20.56	20.66	3			36	19	20.47	20.48	20.61	3
		50	50	20.43	20.48	20.58	3			36	39	20.35	20.41	20.57	3
		100	0	20.48	20.53	20.63	3			75	0	20.42	20.46	20.55	3
10M	QPSK	1	0	23.25	23.30	23.38	0	5M	QPSK	1	0	23.18	23.22	23.22	0
		1	24	23.42	23.56	23.59	0			1	12	23.30	23.40	23.54	0
		1	49	23.30	23.32	23.45	0			1	24	23.16	23.12	23.33	0
		25	0	22.33	22.44	22.50	1			12	0	22.33	22.39	22.38	1
		25	12	22.44	22.43	22.58	1			12	6	22.31	22.40	22.43	1
		25	25	22.13	22.17	22.25	1			12	13	22.08	22.11	22.33	1
		50	0	22.39	22.40	22.54	1			25	0	22.26	22.33	22.51	1
	16QAM	1	0	22.28	22.41	22.45	1		16QAM	1	0	22.19	22.32	22.38	1
		1	24	22.57	22.60	22.72	1			1	12	22.56	22.53	22.57	1
		1	49	22.39	22.38	22.57	1			1	24	22.32	22.35	22.46	1
		25	0	21.50	21.46	21.57	2			12	0	21.34	21.44	21.51	2
		25	12	21.60	21.64	21.74	2			12	6	21.41	21.46	21.63	2
		25	25	21.37	21.46	21.57	2			12	13	21.19	21.44	21.44	2
		50	0	21.43	21.48	21.58	2			25	0	21.37	21.44	21.51	2
	64QAM	1	0	21.12	21.18	21.21	2		64QAM	1	0	21.08	21.01	21.15	2
		1	24	21.24	21.36	21.41	2			1	12	21.17	21.25	21.39	2
		1	49	20.98	21.03	21.19	2			1	24	20.96	21.03	21.13	2
		25	0	20.41	20.46	20.57	3			12	0	20.44	20.41	20.59	3
		25	12	20.42	20.56	20.63	3			12	6	20.44	20.44	20.56	3
		25	25	20.34	20.38	20.52	3			12	13	20.34	20.34	20.39	3
		50	0	20.40	20.51	20.58	3			25	0	20.37	20.36	20.58	3

FCC SAR Test Report

<WLAN 2.4G>

Mode	Channel	Frequency (MHz)	Average Power
802.11b	1	2412	14.95
	6	2437	14.92
	11	2462	14.96

<WLAN 5.2G>

Mode	Channel	Frequency (MHz)	Average Power
802.11a	36	5180	13.87
	40	5200	13.94
	44	5220	13.73
	48	5240	13.78

<WLAN 5.3G>

Mode	Channel	Frequency (MHz)	Average Power
802.11a	52	5260	13.81
	56	5280	13.65
	60	5300	13.86
	64	5320	13.66

<WLAN 5.6G>

Mode	Channel	Frequency (MHz)	Average Power
802.11a	100	5500	13.84
	116	5580	13.80
	120	5600	13.77
	124	5620	13.72
	132	5660	13.69
	140	5700	13.96
	144	5720	13.93

<WLAN 5.8G>

Mode	Channel	Frequency (MHz)	Average Power
802.11a	149	5745	13.94
	153	5765	13.91
	157	5785	13.99
	161	5805	13.95
	165	5825	13.97

<Bluetooth>

Mode	Channel	Frequency (MHz)	Average Power
Bluetooth EDR	0	2402	8.85
	39	2441	9.07
	78	2480	9.30

4.7 SAR Testing Results

4.7.1 SAR Test Reduction Considerations

<KDB 447498 D01, General RF Exposure Guidance>

Testing of other required channels within the operating mode of a frequency band is not required when the reported SAR for the mid-band or highest output power channel is:

- (1) ≤ 0.8 W/kg or 2.0 W/kg, for 1-g or 10-g respectively, when the transmission band is ≤ 100 MHz
- (2) ≤ 0.6 W/kg or 1.5 W/kg, for 1-g or 10-g respectively, when the transmission band is between 100 MHz and 200 MHz
- (3) ≤ 0.4 W/kg or 1.0 W/kg, for 1-g or 10-g respectively, when the transmission band is ≥ 200 MHz

When SAR is not measured at the maximum power level allowed for production units, the measured SAR will be scaled to the maximum tune-up tolerance limit to determine compliance. The scaling factor for the tune-up power is defined as maximum tune-up limit (mW) / measured conducted power (mW). The reported SAR would be calculated by measured SAR x tune-up power scaling factor.

The SAR has been measured with highest transmission duty factor supported by the test mode tools for WLAN and/or Bluetooth. When the transmission duty factor could not achieve 100%, the reported SAR will be scaled to 100% transmission duty factor to determine compliance at the maximum tune-up power. The scaling factor for the duty factor is defined as 100% / transmission duty cycle (%). The reported SAR would be calculated by measured SAR x tune-up power scaling factor x duty cycle scaling factor.

<KDB 941225 D01, 3G SAR Measurement Procedures>

The mode tested for SAR is referred to as the primary mode. The equivalent modes considered for SAR test reduction are denoted as secondary modes. Both primary and secondary modes must be in the same frequency band. When the maximum output power and tune-up tolerance specified for production units in a secondary mode is $\leq 1/4$ dB higher than the primary mode or when the highest reported SAR of the primary mode is scaled by the ratio of specified maximum output power and tune-up tolerance of secondary to primary mode and the adjusted SAR is ≤ 1.2 W/kg, SAR measurement is not required for the secondary mode.

<KDB 941225 D05, SAR Evaluation Considerations for LTE Devices>

- (1) QPSK with 1 RB and 50% RB allocation

Start with the largest channel bandwidth and measure SAR, using the RB offset and required test channel combination with the highest maximum output power among RB offsets at the upper edge, middle and lower edge of each required test channel. When the reported SAR is ≤ 0.8 W/kg, testing of the remaining RB offset configurations and required test channels is not required; otherwise, SAR is required for the remaining required test channels and only for the RB offset configuration with the highest output power for that channel. When the reported SAR of a required test channel is > 1.45 W/kg, SAR is required for all three RB offset configurations for that required test channel.

FCC SAR Test Report

(2) QPSK with 100% RB allocation

SAR is not required when the highest maximum output power for 100% RB allocation is less than the highest maximum output power in 50% and 1 RB allocations and the highest reported SAR for 1 RB and 50% RB allocation are ≤ 0.8 W/kg. Otherwise, SAR is measured for the highest output power channel; and if the reported SAR is > 1.45 W/kg, the remaining required test channels must also be tested.

(3) Higher order modulations

SAR is required only when the highest maximum output power for the configuration in the higher order modulation is $> 1/2$ dB higher than the same configuration in QPSK or when the reported SAR for the QPSK configuration is > 1.45 W/kg.

(4) Other channel bandwidth

SAR is required when the highest maximum output power of the smaller channel bandwidth is $> 1/2$ dB higher than the equivalent channel configurations in the largest channel bandwidth configuration or the reported SAR of a configuration for the largest channel bandwidth is > 1.45 W/kg.

<Power Confirmation for SAR Test Exclusion for LTE Downlink CA>

According to KDB 941225 D05A, the uplink maximum output power below was measured with downlink CA active on the channel with highest measured maximum output power when downlink CA is inactive. The downlink SCC channel was paired with the uplink channel as normal operation. For intra-band contiguous CA, the downlink channel spacing between the component carriers was set to multiple of 300 kHz less than the nominal channel spacing per section 5.4.1A of 3GPP TS36.521. For intra-band non-contiguous CA, the downlink channel spacing between the component carriers was set to maximum separation from PCC and remain fully within the downlink transmission band. For Inter-band CA, the SCC downlink channel was set to near the middle of its transmission band.

Power Measurements for Intra-Band Contiguous Downlink CA

CA Combination	PCC								SCC1				Power	
	LTE Band	BW (MHz)	UL Channel	UL Freq. (MHz)	RB Size	RB Offset	DL Channel	DL Freq. (MHz)	LTE Band	BW (MHz)	DL Channel	DL Freq. (MHz)	Single Carrier Tx Power (dBm)	Tx Power with DL-CA Active (dBm)
CA_2C	2	20	18801	1870.1	1	0	801	1950.1	2	20	999	1969.9	23.43	23.17
CA_7B	7	15	21375	2562.5	1	37	3375	2682.5	7	5	3282	2673.2	23.54	23.16
CA_7C	7	20	21350	2560	1	50	3350	2680	7	20	3152	2660.2	23.60	23.33
CA_38C	38	20	37952	2590.2	1	50	37952	2590.2	38	20	38150	2610	23.66	23.63

CA Combination	PCC								SCC1				Power	
	LTE Band	BW (MHz)	UL Channel	UL Freq. (MHz)	RB Size	RB Offset	DL Channel	DL Freq. (MHz)	LTE Band	BW (MHz)	DL Channel	DL Freq. (MHz)	Single Carrier Tx Power (dBm)	Tx Power with DL-CA Active (dBm)
CA_5A-5A	5	10	20600	844	1	0	2600	889	5	10	2450	874	21.74	21.70
CA_5B	5	10	20476	831.6	1	0	2476	876.6	5	10	2575	886.5	21.77	21.75

FCC SAR Test Report

Power Measurements for Intra-Band Non-Contiguous Downlink CA

CA Combination	PCC								SCC1				Power	
	LTE Band	BW (MHz)	UL Channel	UL Freq. (MHz)	RB Size	RB Offset	DL Channel	DL Freq. (MHz)	LTE Band	BW (MHz)	DL Channel	DL Freq. (MHz)	Single Carrier Tx Power (dBm)	Tx Power with DL-CA Active (dBm)
CA_2A-2A	2	20	18700	1860	1	0	700	1940	2	20	900	1960	23.43	23.34
CA_5A-5A	5	10	20600	844	1	0	2600	889	5	10	2450	874	23.53	23.44
CA_7A-7A	7	20	21350	2560	1	50	3350	2680	7	20	2850	2630	23.60	23.29

Power Measurements for Inter-Band Downlink CA

CA Combination	PCC								SCC1				Power	
	LTE Band	BW (MHz)	UL Channel	UL Freq. (MHz)	RB Size	RB Offset	DL Channel	DL Freq. (MHz)	LTE Band	BW (MHz)	DL Channel	DL Freq. (MHz)	Single Carrier Tx Power (dBm)	Tx Power with DL-CA Active (dBm)
CA_2A-5A	2	20	18900	1880	1	0	900	1960	5	10	2525	881.5	23.43	23.19
CA_5A-7A	5	10	20525	836.5	1	0	2525	881.5	7	20	3100	2655	23.56	23.12

Summary for SAR Test Exclusion for LTE Downlink CA

Per power confirmation results in above, the uplink maximum output power with downlink CA active remains within the specified tune-up tolerance and not more than 0.25 dB higher than the maximum output power with downlink CA inactive. According to KDB 941225 D05A, the SAR test exclusion applies to LTE downlink CA operation.

<Power Confirmation for SAR Testing for LTE Uplink CA>

The conducted power for uplink CA active was measured on the highest reported SAR configuration for each exposure condition with both two carrier components was set to largest channel bandwidth.

PCC							SCC							Power	
Band	BW (MHz)	Modulation	RB Size	RB Offset	UL Channel	UL Frequency (MHz)	Band	BW (MHz)	Modulation	RB Size	RB Offset	UL Channel	UL Frequency (MHz)	Single Carrier Tx Power (dBm)	Tx Power with UL-CA Active (dBm)
7	20	QPSK	1	0	20850	2510	7	20	QPSK	1	99	21048	2529.8	23.27	14.57
			1	99						23.23	23.17				
7	20	QPSK	1	0	21001	2525.1	7	20	QPSK	1	99	21199	2544.9	23.31	14.70
			1	99						23.27	23.23				
7	20	QPSK	1	0	21152	2540.2	7	20	QPSK	1	99	21350	2560	23.45	15.84
			1	99						23.41	23.32				
38	20	QPSK	1	0	37850	2580	38	20	QPSK	1	99	38048	2599.8	23.27	14.83
			1	99						23.30	23.29				
38	20	QPSK	1	0	37901	2585.1	38	20	QPSK	1	99	38099	2604.9	23.32	14.89
			1	99						23.35	23.33				
38	20	QPSK	1	0	37952	2590.2	38	20	QPSK	1	99	38150	2610	23.42	14.95
			1	99						23.45	23.39				

SAR Measurements for Intra-Band Contiguous CA

The SAR testing was performed with the single carrier (uplink CA is inactive) for all test positions for each exposure condition. The LTE uplink CA active was verified with maximum output power on the highest SAR configuration of single carrier for each exposure condition. For intra-band contiguous CA, the SCC channel was set to closest available contiguous channel.

<KDB 248227 D01, SAR Guidance for Wi-Fi Transmitters>

- (1) For handsets operating next to ear, hotspot mode or mini-tablet configurations, the initial test position procedures were applied. The test position with the highest extrapolated peak SAR will be used as the initial test position. When the reported SAR of initial test position is ≤ 0.4 W/kg, SAR testing for remaining test positions is not required. Otherwise, SAR is evaluated at the subsequent highest peak SAR positions until the reported SAR result is ≤ 0.8 W/kg or all test positions are measured.
- (2) For WLAN 2.4 GHz, the highest measured maximum output power channel for DSSS was selected for SAR measurement. When the reported SAR is ≤ 0.8 W/kg, no further SAR testing is required. Otherwise, SAR is evaluated at the next highest measured output power channel. When any reported SAR is >1.2 W/kg, SAR is required for the third channel. For OFDM modes (802.11g/n), SAR is not required when the highest reported SAR for DSSS is adjusted by the ratio of OFDM to DSSS specified maximum output power and it is ≤ 1.2 W/kg.
- (3) For WLAN 5GHz, the initial test configuration was selected according to the transmission mode with the highest maximum output power. When the reported SAR of initial test configuration is > 0.8 W/kg, SAR is required for the subsequent highest measured output power channel until the reported SAR result is ≤ 1.2 W/kg or all required channels are measured. For other transmission modes, SAR is not required when the highest reported SAR for initial test configuration is adjusted by the ratio of subsequent test configuration to initial test configuration specified maximum output power and it is ≤ 1.2 W/kg.

FCC SAR Test Report

4.7.2 SAR Results for Head Exposure Condition

Plot No.	Band	Mode	Test Position	Ch.	Sample	Tx Antenna	Max. Tune-up Power (dBm)	Measured Conducted Power (dBm)	Scaling Factor	Power Drift (dB)	Measured SAR-1g (W/kg)	Scaled SAR-1g (W/kg)
	GSM850	GPRS12	Right Cheek	251	1	Ant 1	27.0	26.98	1.00	0.00	0.250	0.25
	GSM850	GPRS12	Right Tilted	251	1	Ant 1	27.0	26.98	1.00	0.13	0.151	0.15
	GSM850	GPRS12	Left Cheek	251	1	Ant 1	27.0	26.98	1.00	0.06	0.236	0.24
	GSM850	GPRS12	Left Tilted	251	1	Ant 1	27.0	26.98	1.00	0.06	0.171	0.17
01	GSM850	GPRS12	Right Cheek	251	1	Ant 3	24.0	23.91	1.02	0.11	1.07	1.09
	GSM850	GPRS12	Right Tilted	251	1	Ant 3	24.0	23.91	1.02	0.03	0.703	0.72
	GSM850	GPRS12	Left Cheek	251	1	Ant 3	24.0	23.91	1.02	-0.11	0.792	0.81
	GSM850	GPRS12	Left Tilted	251	1	Ant 3	24.0	23.91	1.02	0.02	0.493	0.50
	GSM850	GPRS12	Right Cheek	128	1	Ant 3	24.0	23.78	1.05	-0.07	0.937	0.98
	GSM850	GPRS12	Right Cheek	189	1	Ant 3	24.0	23.84	1.04	0.05	0.974	1.01
	GSM850	GPRS12	Left Cheek	128	1	Ant 3	24.0	23.78	1.05	-0.06	0.769	0.81
	GSM850	GPRS12	Left Cheek	189	1	Ant 3	24.0	23.84	1.04	-0.07	0.777	0.81
	GSM850	GPRS12	Right Cheek	251	2	Ant 3	24.0	23.91	1.02	0.11	0.946	0.96
	GSM850	GPRS12	Right Cheek	128	2	Ant 3	24.0	23.78	1.05	-0.02	0.911	0.96
	GSM850	GPRS12	Right Cheek	189	2	Ant 3	24.0	23.84	1.04	0.09	0.914	0.95
	GSM850	GPRS12	Right Cheek	251	1	Ant 3	24.0	23.91	1.02	0.05	1.02	1.04
02	GSM1900	EDGE12	Right Cheek	810	1	Ant 1	26.0	24.63	1.37	0.03	0.018	0.02
	GSM1900	EDGE12	Right Tilted	810	1	Ant 1	26.0	24.63	1.37	0.00	<0.001	0.00
	GSM1900	EDGE12	Left Cheek	810	1	Ant 1	26.0	24.63	1.37	0.07	0.010	0.01
	GSM1900	EDGE12	Left Tilted	810	1	Ant 1	26.0	24.63	1.37	0.00	<0.001	0.00
	GSM1900	EDGE12	Right Cheek	512	1	Ant 1	26.0	24.50	1.41	-0.16	0.011	0.02
	GSM1900	EDGE12	Right Cheek	661	1	Ant 1	26.0	24.54	1.40	0.02	0.00503	0.01
	GSM1900	EDGE12	Right Cheek	810	2	Ant 1	26.0	24.63	1.37	-0.03	0.016	0.02
03	WCDMA II	RMC12.2K	Right Cheek	9538	1	Ant 1	24.0	23.41	1.15	-0.17	0.047	0.05
	WCDMA II	RMC12.2K	Right Tilted	9538	1	Ant 1	24.0	23.41	1.15	0.00	<0.001	0.00
	WCDMA II	RMC12.2K	Left Cheek	9538	1	Ant 1	24.0	23.41	1.15	0.09	0.00926	0.01
	WCDMA II	RMC12.2K	Left Tilted	9538	1	Ant 1	24.0	23.41	1.15	0.00	<0.001	0.00
	WCDMA II	RMC12.2K	Right Cheek	9262	1	Ant 1	24.0	23.21	1.20	-0.01	0.039	0.05
	WCDMA II	RMC12.2K	Right Cheek	9400	1	Ant 1	24.0	23.24	1.19	0.06	0.033	0.04
	WCDMA II	RMC12.2K	Right Cheek	9538	2	Ant 1	24.0	23.41	1.15	0.02	0.019	0.02
	WCDMA IV	RMC12.2K	Right Cheek	1413	1	Ant 1	24.0	23.27	1.18	0.00	<0.001	0.00
	WCDMA IV	RMC12.2K	Right Tilted	1413	1	Ant 1	24.0	23.27	1.18	0.00	<0.001	0.00
	WCDMA IV	RMC12.2K	Left Cheek	1413	1	Ant 1	24.0	23.27	1.18	0.00	<0.001	0.00
	WCDMA IV	RMC12.2K	Left Tilted	1413	1	Ant 1	24.0	23.27	1.18	0.00	<0.001	0.00
	WCDMA IV	RMC12.2K	Right Cheek	1312	1	Ant 1	24.0	23.21	1.20	0.00	<0.001	0.00
	WCDMA IV	RMC12.2K	Right Cheek	1513	1	Ant 1	24.0	23.25	1.19	0.00	<0.001	0.00
	WCDMA IV	RMC12.2K	Right Cheek	1413	2	Ant 1	24.0	23.27	1.18	0.00	<0.001	0.00
	WCDMA V	RMC12.2K	Right Cheek	4182	1	Ant 1	24.0	23.33	1.17	0.02	0.196	0.23
	WCDMA V	RMC12.2K	Right Tilted	4182	1	Ant 1	24.0	23.33	1.17	-0.13	0.117	0.14
	WCDMA V	RMC12.2K	Left Cheek	4182	1	Ant 1	24.0	23.33	1.17	0.09	0.218	0.26
	WCDMA V	RMC12.2K	Left Tilted	4182	1	Ant 1	24.0	23.33	1.17	0.06	0.140	0.16
04	WCDMA V	RMC12.2K	Right Cheek	4182	1	Ant 3	21.0	20.96	1.01	0.01	1.05	1.06
	WCDMA V	RMC12.2K	Right Tilted	4182	1	Ant 3	21.0	20.96	1.01	-0.11	0.652	0.66
	WCDMA V	RMC12.2K	Left Cheek	4182	1	Ant 3	21.0	20.96	1.01	0.03	0.793	0.80
	WCDMA V	RMC12.2K	Left Tilted	4182	1	Ant 3	21.0	20.96	1.01	-0.07	0.394	0.40
	WCDMA V	RMC12.2K	Right Cheek	4132	1	Ant 3	21.0	20.92	1.02	0.12	0.982	1.00
	WCDMA V	RMC12.2K	Right Cheek	4233	1	Ant 3	21.0	20.85	1.04	0.05	0.964	1.00
	WCDMA V	RMC12.2K	Left Cheek	4132	1	Ant 3	21.0	20.92	1.02	0.09	0.771	0.79
	WCDMA V	RMC12.2K	Left Cheek	4233	1	Ant 3	21.0	20.85	1.04	-0.10	0.782	0.81
	WCDMA V	RMC12.2K	Right Cheek	4182	2	Ant 3	21.0	20.96	1.01	0.03	1.01	1.02
	WCDMA V	RMC12.2K	Right Cheek	4132	2	Ant 3	21.0	20.92	1.02	-0.04	0.962	0.98
	WCDMA V	RMC12.2K	Right Cheek	4233	2	Ant 3	21.0	20.85	1.04	0.12	0.948	0.99
	WCDMA V	RMC12.2K	Right Cheek	4182	1	Ant 3	21.0	20.96	1.01	0.01	1.02	1.03

Note: The "< 0.001" means there is no SAR value or the SAR is too low to be measured.

FCC SAR Test Report

Plot No.	Band	Mode	Test Position	Ch.	RB#	RB Offset	Sample	Tx Antenna	Max. Tune-up Power (dBm)	Measured Conducted Power (dBm)	Scaling Factor	Power Drift (dB)	Measured SAR-1g (W/kg)	Scaled SAR-1g (W/kg)
05	LTE 2	QPSK20M	Right Cheek	18900	1	0	1	Ant 1	24.0	23.43	1.14	0.06	0.059	0.07
	LTE 2	QPSK20M	Right Tilted	18900	1	0	1	Ant 1	24.0	23.43	1.14	-0.13	0.019	0.02
	LTE 2	QPSK20M	Left Cheek	18900	1	0	1	Ant 1	24.0	23.43	1.14	0.04	0.032	0.04
	LTE 2	QPSK20M	Left Tilted	18900	1	0	1	Ant 1	24.0	23.43	1.14	-0.04	<0.001	0.00
	LTE 2	QPSK20M	Right Cheek	18900	50	0	1	Ant 1	23.0	22.78	1.05	0.01	0.045	0.05
	LTE 2	QPSK20M	Right Tilted	18900	50	0	1	Ant 1	23.0	22.78	1.05	0.03	<0.001	0.00
	LTE 2	QPSK20M	Left Cheek	18900	50	0	1	Ant 1	23.0	22.78	1.05	-0.01	0.023	0.02
	LTE 2	QPSK20M	Left Tilted	18900	50	0	1	Ant 1	23.0	22.78	1.05	0.08	<0.001	0.00
	LTE 2	QPSK20M	Right Cheek	18700	1	0	1	Ant 1	24.0	23.38	1.15	0.07	0.052	0.06
	LTE 2	QPSK20M	Right Cheek	19100	1	0	1	Ant 1	24.0	23.36	1.16	0.04	0.047	0.05
	LTE 2	QPSK20M	Right Cheek	18900	1	0	2	Ant 1	24.0	23.43	1.14	-0.01	0.051	0.06
06	LTE 4	QPSK20M	Right Cheek	20300	1	50	1	Ant 1	24.0	23.11	1.23	-0.09	0.00476	0.01
	LTE 4	QPSK20M	Right Tilted	20300	1	50	1	Ant 1	24.0	23.11	1.23	0.00	<0.001	0.00
	LTE 4	QPSK20M	Left Cheek	20300	1	50	1	Ant 1	24.0	23.11	1.23	0.00	<0.001	0.00
	LTE 4	QPSK20M	Left Tilted	20300	1	50	1	Ant 1	24.0	23.11	1.23	0.00	<0.001	0.00
	LTE 4	QPSK20M	Right Cheek	20300	50	0	1	Ant 1	23.0	22.20	1.20	0.00	<0.001	0.00
	LTE 4	QPSK20M	Right Tilted	20300	50	0	1	Ant 1	23.0	22.20	1.20	0.00	<0.001	0.00
	LTE 4	QPSK20M	Left Cheek	20300	50	0	1	Ant 1	23.0	22.20	1.20	0.00	<0.001	0.00
	LTE 4	QPSK20M	Left Tilted	20300	50	0	1	Ant 1	23.0	22.20	1.20	0.00	<0.001	0.00
	LTE 4	QPSK20M	Right Cheek	20050	1	50	1	Ant 1	24.0	23.01	1.26	-0.09	0.00415	0.01
	LTE 4	QPSK20M	Right Cheek	20175	1	50	1	Ant 1	24.0	23.09	1.23	0.05	0.00393	0.00
	LTE 4	QPSK20M	Right Cheek	20300	1	50	2	Ant 1	24.0	23.11	1.23	0.07	0.00404	0.00
	LTE 5	QPSK10M	Right Cheek	20525	1	0	1	Ant 1	24.0	23.56	1.11	-0.06	0.228	0.25
	LTE 5	QPSK10M	Right Tilted	20525	1	0	1	Ant 1	24.0	23.56	1.11	0.05	0.140	0.16
	LTE 5	QPSK10M	Left Cheek	20525	1	0	1	Ant 1	24.0	23.56	1.11	0.03	0.219	0.24
	LTE 5	QPSK10M	Left Tilted	20525	1	0	1	Ant 1	24.0	23.56	1.11	-0.02	0.128	0.14
	LTE 5	QPSK10M	Right Cheek	20525	25	0	1	Ant 1	23.0	22.49	1.12	-0.01	0.181	0.20
	LTE 5	QPSK10M	Right Tilted	20525	25	0	1	Ant 1	23.0	22.49	1.12	0.11	0.111	0.12
	LTE 5	QPSK10M	Left Cheek	20525	25	0	1	Ant 1	23.0	22.49	1.12	-0.04	0.171	0.19
	LTE 5	QPSK10M	Left Tilted	20525	25	0	1	Ant 1	23.0	22.49	1.12	-0.07	0.113	0.13
	LTE 5	QPSK10M	Right Cheek	20525	1	0	1	Ant 3	22.0	21.77	1.05	0.02	0.978	1.03
	LTE 5	QPSK10M	Right Tilted	20525	1	0	1	Ant 3	22.0	21.77	1.05	0.11	0.736	0.77
	LTE 5	QPSK10M	Left Cheek	20525	1	0	1	Ant 3	22.0	21.77	1.05	0.09	0.805	0.85
	LTE 5	QPSK10M	Left Tilted	20525	1	0	1	Ant 3	22.0	21.77	1.05	-0.15	0.618	0.65
	LTE 5	QPSK10M	Right Cheek	20525	25	0	1	Ant 3	21.0	20.75	1.06	0.02	0.797	0.84
	LTE 5	QPSK10M	Right Tilted	20525	25	0	1	Ant 3	21.0	20.75	1.06	0.01	0.608	0.64
	LTE 5	QPSK10M	Left Cheek	20525	25	0	1	Ant 3	21.0	20.75	1.06	0.11	0.663	0.70
	LTE 5	QPSK10M	Left Tilted	20525	25	0	1	Ant 3	21.0	20.75	1.06	0.09	0.481	0.51
07	LTE 5	QPSK10M	Right Cheek	20450	1	0	1	Ant 3	22.0	21.69	1.07	-0.01	1.01	1.08
	LTE 5	QPSK10M	Right Cheek	20600	1	0	1	Ant 3	22.0	21.74	1.06	0.10	0.955	1.01
	LTE 5	QPSK10M	Left Cheek	20450	1	0	1	Ant 3	22.0	21.69	1.07	-0.04	0.789	0.84
	LTE 5	QPSK10M	Left Cheek	20600	1	0	1	Ant 3	22.0	21.74	1.06	0.18	0.771	0.82
	LTE 5	QPSK10M	Right Cheek	20450	25	0	1	Ant 3	21.0	20.67	1.08	-0.13	0.781	0.84
	LTE 5	QPSK10M	Right Cheek	20600	25	0	1	Ant 3	21.0	20.72	1.07	-0.09	0.762	0.82
	LTE 5	QPSK10M	Right Cheek	20525	50	0	1	Ant 3	21.0	20.74	1.06	-0.06	0.751	0.80
	LTE 5	QPSK10M	Left Cheek	20525	50	0	1	Ant 3	21.0	20.74	1.06	0.06	0.645	0.68
	LTE 5	QPSK10M	Right Cheek	20450	1	0	2	Ant 3	22.0	21.69	1.07	0.18	0.994	1.06
	LTE 5	QPSK10M	Right Cheek	20525	1	0	2	Ant 3	22.0	21.77	1.05	0.08	0.963	1.01
	LTE 5	QPSK10M	Right Cheek	20600	1	0	2	Ant 3	22.0	21.74	1.06	0.15	0.955	1.01
	LTE 5	QPSK10M	Right Cheek	20450	1	0	1	Ant 3	22.0	21.69	1.07	0.02	0.980	1.05

Note: The "< 0.001" means there is no SAR value or the SAR is too low to be measured.

FCC SAR Test Report

Plot No.	Uplink Mode	Band	Mode	Test Position	Ch.	RB#	RB Offset	Sample	Tx Antenna	Max. Tune-up Power (dBm)	Measured Conducted Power (dBm)	Scaling Factor	Power Drift (dB)	Measured SAR-1g (W/kg)	Scaled SAR-1g (W/kg)
08	Single Carrier (CA inactive)	LTE 7	QPSK20M	Right Cheek	21350	1	50	1	Ant 2	24.5	23.60	1.23	-0.09	0.124	0.15
		LTE 7	QPSK20M	Right Tilted	21350	1	50	1	Ant 2	24.5	23.60	1.23	0.01	0.049	0.06
		LTE 7	QPSK20M	Left Cheek	21350	1	50	1	Ant 2	24.5	23.60	1.23	-0.03	0.097	0.12
		LTE 7	QPSK20M	Left Tilted	21350	1	50	1	Ant 2	24.5	23.60	1.23	0.04	0.052	0.06
		LTE 7	QPSK20M	Right Cheek	21350	50	0	1	Ant 2	23.5	22.52	1.25	-0.05	0.096	0.12
		LTE 7	QPSK20M	Right Tilted	21350	50	0	1	Ant 2	23.5	22.52	1.25	-0.03	0.035	0.04
		LTE 7	QPSK20M	Left Cheek	21350	50	0	1	Ant 2	23.5	22.52	1.25	-0.13	0.071	0.09
		LTE 7	QPSK20M	Left Tilted	21350	50	0	1	Ant 2	23.5	22.52	1.25	0.04	0.043	0.05
		LTE 7	QPSK20M	Right Cheek	20850	1	50	1	Ant 2	24.5	23.42	1.28	-0.09	0.116	0.15
		LTE 7	QPSK20M	Right Cheek	21100	1	50	1	Ant 2	24.5	23.46	1.27	0.02	0.111	0.14
		LTE 7	QPSK20M	Right Cheek	21350	1	50	2	Ant 2	24.5	23.60	1.23	0.01	0.114	0.14
	2 CC (CA active)	LTE 7	QPSK20M	Right Cheek	PCC : 21152 SCC : 21350	PCC : 1 SCC : 1	PCC : 99 SCC : 0	1	Ant 2	24.5	23.32	1.31	-0.17	0.048	0.06
09	Single Carrier (CA inactive)	LTE 38	QPSK20M	Right Cheek	38150	1	50	1	Ant 2	24.5	23.66	1.21	-0.01	0.081	0.10
		LTE 38	QPSK20M	Right Tilted	38150	1	50	1	Ant 2	24.5	23.66	1.21	0.08	0.024	0.03
		LTE 38	QPSK20M	Left Cheek	38150	1	50	1	Ant 2	24.5	23.66	1.21	0.07	0.038	0.05
		LTE 38	QPSK20M	Left Tilted	38150	1	50	1	Ant 2	24.5	23.66	1.21	-0.07	0.030	0.04
		LTE 38	QPSK20M	Right Cheek	38150	50	25	1	Ant 2	23.5	22.61	1.23	-0.09	0.063	0.08
		LTE 38	QPSK20M	Right Tilted	38150	50	25	1	Ant 2	23.5	22.61	1.23	-0.04	0.019	0.02
		LTE 38	QPSK20M	Left Cheek	38150	50	25	1	Ant 2	23.5	22.61	1.23	0.03	0.030	0.04
		LTE 38	QPSK20M	Left Tilted	38150	50	25	1	Ant 2	23.5	22.61	1.23	0.12	0.023	0.03
		LTE 38	QPSK20M	Right Cheek	37850	1	50	1	Ant 2	24.5	23.51	1.26	-0.09	0.068	0.09
		LTE 38	QPSK20M	Right Cheek	38000	1	50	1	Ant 2	24.5	23.56	1.24	0.07	0.076	0.09
		LTE 38	QPSK20M	Right Cheek	38150	1	50	2	Ant 2	24.5	23.66	1.21	0.04	0.075	0.09
	2 CC (CA active)	LTE 38	QPSK20M	Right Cheek	PCC : 37952 SCC : 38150	PCC : 1 SCC : 1	PCC : 99 SCC : 0	1	Ant 2	24.5	23.39	1.29	0.11	0.047	0.06

FCC SAR Test Report

Plot No.	Band	Mode	Test Position	Ch.	Sample	Duty Cycle	Crest Factor	Max. Tune-up Power (dBm)	Measured Conducted Power (dBm)	Scaling Factor	Power Drift (dB)	Measured SAR-1g (W/kg)	Scaled SAR-1g (W/kg)
	WLAN2.4G	802.11b	Right Cheek	11	1	99.40	1.01	15.0	14.96	1.01	0.02	0.481	0.49
	WLAN2.4G	802.11b	Right Tilted	11	1	99.40	1.01	15.0	14.96	1.01	0.02	0.384	0.39
10	WLAN2.4G	802.11b	Left Cheek	11	1	99.40	1.01	15.0	14.96	1.01	0.07	0.719	0.73
	WLAN2.4G	802.11b	Left Tilted	11	1	99.40	1.01	15.0	14.96	1.01	0.13	0.556	0.57
	WLAN2.4G	802.11b	Left Cheek	1	1	99.40	1.01	15.0	14.95	1.01	0.15	0.701	0.72
	WLAN2.4G	802.11b	Left Cheek	6	1	99.40	1.01	15.0	14.92	1.02	0.09	0.703	0.72
	WLAN2.4G	802.11b	Left Cheek	11	2	99.40	1.01	15.0	14.96	1.01	0.11	0.696	0.71
	WLAN5.3G	802.11a	Right Cheek	60	1	96.72	1.03	14.0	13.86	1.03	0.02	0.313	0.33
	WLAN5.3G	802.11a	Right Tilted	60	1	96.72	1.03	14.0	13.86	1.03	-0.16	0.236	0.25
11	WLAN5.3G	802.11a	Left Cheek	60	1	96.72	1.03	14.0	13.86	1.03	-0.11	0.702	0.74
	WLAN5.3G	802.11a	Left Tilted	60	1	96.72	1.03	14.0	13.86	1.03	0.02	0.445	0.47
	WLAN5.3G	802.11a	Left Cheek	52	1	96.72	1.03	14.0	13.81	1.04	0.09	0.680	0.73
	WLAN5.3G	802.11a	Left Cheek	56	1	96.72	1.03	14.0	13.65	1.08	0.01	0.660	0.73
	WLAN5.3G	802.11a	Left Cheek	64	1	96.72	1.03	14.0	13.66	1.08	0.01	0.595	0.66
	WLAN5.3G	802.11a	Left Cheek	60	2	96.72	1.03	14.0	13.86	1.03	0.06	0.643	0.68
	WLAN5.6G	802.11a	Right Cheek	140	1	96.72	1.03	14.0	13.96	1.01	0.16	0.196	0.20
	WLAN5.6G	802.11a	Right Tilted	140	1	96.72	1.03	14.0	13.96	1.01	0.14	0.191	0.20
12	WLAN5.6G	802.11a	Left Cheek	140	1	96.72	1.03	14.0	13.96	1.01	0.16	0.529	0.55
	WLAN5.6G	802.11a	Left Tilted	140	1	96.72	1.03	14.0	13.96	1.01	0.16	0.403	0.42
	WLAN5.6G	802.11a	Left Cheek	100	1	96.72	1.03	14.0	13.84	1.04	-0.13	0.344	0.37
	WLAN5.6G	802.11a	Left Cheek	116	1	96.72	1.03	14.0	13.80	1.05	0.05	0.381	0.41
	WLAN5.6G	802.11a	Left Cheek	120	1	96.72	1.03	14.0	13.77	1.05	-0.11	0.351	0.38
	WLAN5.6G	802.11a	Left Cheek	124	1	96.72	1.03	14.0	13.72	1.07	0.02	0.373	0.41
	WLAN5.6G	802.11a	Left Cheek	132	1	96.72	1.03	14.0	13.69	1.07	0.09	0.469	0.52
	WLAN5.6G	802.11a	Left Cheek	144	1	96.72	1.03	14.0	13.93	1.02	0.04	0.509	0.53
	WLAN5.6G	802.11a	Left Cheek	140	2	96.72	1.03	14.0	13.96	1.01	-0.16	0.504	0.52
	WLAN5.8G	802.11a	Right Cheek	157	1	96.72	1.03	14.0	13.99	1.00	0.03	0.208	0.21
	WLAN5.8G	802.11a	Right Tilted	157	1	96.72	1.03	14.0	13.99	1.00	0.02	0.191	0.20
13	WLAN5.8G	802.11a	Left Cheek	157	1	96.72	1.03	14.0	13.99	1.00	0.16	0.559	0.58
	WLAN5.8G	802.11a	Left Tilted	157	1	96.72	1.03	14.0	13.99	1.00	0.09	0.440	0.45
	WLAN5.8G	802.11a	Left Cheek	149	1	96.72	1.03	14.0	13.94	1.01	-0.16	0.489	0.51
	WLAN5.8G	802.11a	Left Cheek	153	1	96.72	1.03	14.0	13.91	1.02	0.02	0.400	0.42
	WLAN5.8G	802.11a	Left Cheek	161	1	96.72	1.03	14.0	13.95	1.01	-0.16	0.548	0.57
	WLAN5.8G	802.11a	Left Cheek	165	1	96.72	1.03	14.0	13.97	1.01	-0.15	0.492	0.51
	WLAN5.8G	802.11a	Left Cheek	157	2	96.72	1.03	14.0	13.99	1.00	0.01	0.536	0.55
	BT	BDR	Right Cheek	78	1	76.48	1.31	9.5	9.30	1.05	0.08	0.098	0.13
	BT	BDR	Right Tilted	78	1	76.48	1.31	9.5	9.30	1.05	0.11	0.079	0.11
14	BT	BDR	Left Cheek	78	1	76.48	1.31	9.5	9.30	1.05	-0.07	0.128	0.18
	BT	BDR	Left Tilted	78	1	76.48	1.31	9.5	9.30	1.05	0.05	0.095	0.13
	BT	BDR	Left Cheek	0	1	76.48	1.31	9.5	8.85	1.16	-0.02	0.121	0.18
	BT	BDR	Left Cheek	39	1	76.48	1.31	9.5	9.07	1.10	0.06	0.116	0.17
	BT	BDR	Left Cheek	78	2	76.48	1.31	9.5	9.30	1.05	-0.01	0.121	0.17

FCC SAR Test Report

4.7.3 SAR Results for Body-worn Exposure Condition (Test Separation Distance is 10 mm)

Plot No.	Band	Mode	Test Position	Ch.	Sample	Tx Antenna	Max. Tune-up Power (dBm)	Measured Conducted Power (dBm)	Scaling Factor	Power Drift (dB)	Measured SAR-1g (W/kg)	Scaled SAR-1g (W/kg)
	GSM850	GPRS12	Front Face	251	1	Ant 1	27.0	26.98	1.00	0.05	0.207	0.21
	GSM850	GPRS12	Rear Face	251	1	Ant 1	27.0	26.98	1.00	-0.07	0.26	0.26
	GSM850	GPRS12	Front Face	251	1	Ant 3	26.0	25.18	1.21	0.03	0.621	0.75
15	GSM850	GPRS12	Rear Face	251	1	Ant 3	26.0	25.18	1.21	-0.05	0.731	0.88
	GSM850	GPRS12	Rear Face	128	1	Ant 3	26.0	25.09	1.23	0.12	0.715	0.88
	GSM850	GPRS12	Rear Face	189	1	Ant 3	26.0	25.12	1.22	0.05	0.722	0.88
	GSM850	GPRS12	Rear Face	251	2	Ant 3	26.0	25.18	1.21	-0.03	0.726	0.88
	GSM850	GPRS12	Rear Face	128	2	Ant 3	26.0	25.09	1.23	0.01	0.710	0.87
	GSM850	GPRS12	Rear Face	189	2	Ant 3	26.0	25.12	1.22	0.11	0.700	0.85
	GSM1900	EDGE12	Front Face	810	1	Ant 1	26.0	24.63	1.37	-0.04	0.241	0.33
16	GSM1900	EDGE12	Rear Face	810	1	Ant 1	26.0	24.63	1.37	-0.02	0.417	0.57
	GSM1900	EDGE12	Rear Face	512	1	Ant 1	26.0	24.50	1.41	0.07	0.382	0.54
	GSM1900	EDGE12	Rear Face	661	1	Ant 1	26.0	24.54	1.40	0.11	0.401	0.56
	GSM1900	EDGE12	Rear Face	810	2	Ant 1	26.0	24.63	1.37	-0.02	0.403	0.55
	WCDMA II	RMC12.2K	Front Face	9538	1	Ant 1	21.0	20.56	1.11	0.12	0.501	0.56
17	WCDMA II	RMC12.2K	Rear Face	9538	1	Ant 1	21.0	20.56	1.11	-0.04	0.611	0.68
	WCDMA II	RMC12.2K	Rear Face	9262	1	Ant 1	21.0	20.49	1.12	0.11	0.602	0.67
	WCDMA II	RMC12.2K	Rear Face	9400	1	Ant 1	21.0	20.54	1.11	0.03	0.596	0.66
	WCDMA II	RMC12.2K	Rear Face	9538	2	Ant 1	21.0	20.56	1.11	-0.15	0.605	0.67
	WCDMA IV	RMC12.2K	Front Face	1413	1	Ant 1	21.0	20.62	1.09	0.04	0.354	0.39
18	WCDMA IV	RMC12.2K	Rear Face	1413	1	Ant 1	21.0	20.62	1.09	-0.05	0.586	0.64
	WCDMA IV	RMC12.2K	Rear Face	1312	1	Ant 1	21.0	20.58	1.10	0.05	0.392	0.43
	WCDMA IV	RMC12.2K	Rear Face	1513	1	Ant 1	21.0	20.59	1.10	0.07	0.395	0.43
	WCDMA IV	RMC12.2K	Rear Face	1413	2	Ant 1	21.0	20.62	1.09	-0.12	0.403	0.44
	WCDMA V	RMC12.2K	Front Face	4182	1	Ant 1	24.0	23.33	1.17	0.03	0.208	0.24
	WCDMA V	RMC12.2K	Rear Face	4182	1	Ant 1	24.0	23.33	1.17	-0.02	0.219	0.26
19	WCDMA V	RMC12.2K	Front Face	4182	1	Ant 3	22.0	21.47	1.13	-0.09	0.478	0.54
	WCDMA V	RMC12.2K	Rear Face	4182	1	Ant 3	22.0	21.47	1.13	-0.11	0.454	0.51
	WCDMA V	RMC12.2K	Front Face	4132	1	Ant 3	22.0	21.33	1.17	-0.03	0.448	0.52
	WCDMA V	RMC12.2K	Front Face	4233	1	Ant 3	22.0	21.45	1.14	0.03	0.456	0.52
	WCDMA V	RMC12.2K	Front Face	4182	2	Ant 3	22.0	21.47	1.13	-0.11	0.459	0.52

FCC SAR Test Report

Plot No.	Band	Mode	Test Position	Ch.	RB#	RB Offset	Sample	Tx Antenna	Max. Tune-up Power (dBm)	Measured Conducted Power (dBm)	Scaling Factor	Power Drift (dB)	Measured SAR-1g (W/kg)	Scaled SAR-1g (W/kg)
20	LTE 2	QPSK20M	Front Face	18900	1	0	1	Ant 1	18.5	18.13	1.09	0.07	0.409	0.45
	LTE 2	QPSK20M	Rear Face	18900	1	0	1	Ant 1	18.5	18.13	1.09	-0.04	0.605	0.66
	LTE 2	QPSK20M	Front Face	18900	50	0	1	Ant 1	17.5	17.48	1.00	-0.11	0.325	0.33
	LTE 2	QPSK20M	Rear Face	18900	50	0	1	Ant 1	17.5	17.48	1.00	0.05	0.528	0.53
	LTE 2	QPSK20M	Rear Face	18700	1	0	1	Ant 1	18.5	17.99	1.12	-0.12	0.548	0.61
	LTE 2	QPSK20M	Rear Face	19100	1	0	1	Ant 1	18.5	18.04	1.11	0.03	0.561	0.62
21	LTE 2	QPSK20M	Rear Face	18900	1	0	2	Ant 1	18.5	18.13	1.09	-0.09	0.598	0.65
	LTE 4	QPSK20M	Front Face	20300	1	50	1	Ant 1	21.0	20.76	1.06	-0.03	0.338	0.36
	LTE 4	QPSK20M	Rear Face	20300	1	50	1	Ant 1	21.0	20.76	1.06	0.15	0.651	0.69
	LTE 4	QPSK20M	Front Face	20300	50	0	1	Ant 1	20.0	19.69	1.07	-0.05	0.207	0.22
	LTE 4	QPSK20M	Rear Face	20300	50	0	1	Ant 1	20.0	19.69	1.07	0.05	0.232	0.25
	LTE 4	QPSK20M	Rear Face	20050	1	50	1	Ant 1	21.0	20.71	1.07	0.03	0.464	0.50
	LTE 4	QPSK20M	Rear Face	20175	1	50	1	Ant 1	21.0	20.73	1.06	0.07	0.469	0.50
22	LTE 4	QPSK20M	Rear Face	20300	1	50	2	Ant 1	21.0	20.76	1.06	-0.11	0.472	0.50
	LTE 5	QPSK10M	Front Face	20525	1	0	1	Ant 1	24.0	23.56	1.11	-0.08	0.235	0.26
	LTE 5	QPSK10M	Rear Face	20525	1	0	1	Ant 1	24.0	23.56	1.11	0.01	0.280	0.31
	LTE 5	QPSK10M	Front Face	20525	25	0	1	Ant 1	23.0	22.49	1.12	0.05	0.183	0.20
	LTE 5	QPSK10M	Rear Face	20525	25	0	1	Ant 1	23.0	22.49	1.12	0.11	0.193	0.22
	LTE 5	QPSK10M	Front Face	20525	1	0	1	Ant 3	22.0	21.77	1.05	0.05	0.348	0.37
	LTE 5	QPSK10M	Rear Face	20525	1	0	1	Ant 3	22.0	21.77	1.05	-0.06	0.416	0.44
	LTE 5	QPSK10M	Front Face	20525	25	0	1	Ant 3	21.0	20.75	1.06	-0.07	0.259	0.27
	LTE 5	QPSK10M	Rear Face	20525	25	0	1	Ant 3	21.0	20.75	1.06	0.12	0.341	0.36
	LTE 5	QPSK10M	Rear Face	20450	1	0	1	Ant 3	22.0	21.69	1.07	0.11	0.403	0.43
LTE 5	QPSK10M	Rear Face	20600	1	0	1	Ant 3	22.0	21.74	1.06	-0.05	0.398	0.42	
LTE 5	QPSK10M	Rear Face	20525	1	0	2	Ant 3	22.0	21.77	1.05	0.03	0.376	0.39	

Plot No.	Uplink Mode	Band	Mode	Test Position	Ch.	RB#	RB Offset	Sample	Tx Antenna	Max. Tune-up Power (dBm)	Measured Conducted Power (dBm)	Scaling Factor	Power Drift (dB)	Measured SAR-1g (W/kg)	Scaled SAR-1g (W/kg)
23	Single Carrier (CA inactive)	LTE 7	QPSK20M	Front Face	21350	1	50	1	Ant 2	24.5	23.60	1.23	-0.04	0.647	0.80
		LTE 7	QPSK20M	Rear Face	21350	1	50	1	Ant 2	24.5	23.60	1.23	0.06	0.602	0.74
		LTE 7	QPSK20M	Front Face	21350	50	0	1	Ant 2	23.5	22.52	1.25	-0.09	0.534	0.67
		LTE 7	QPSK20M	Rear Face	21350	50	0	1	Ant 2	23.5	22.52	1.25	-0.13	0.416	0.52
		LTE 7	QPSK20M	Front Face	20850	1	50	1	Ant 2	24.5	23.42	1.28	0.01	0.528	0.68
		LTE 7	QPSK20M	Front Face	21100	1	50	1	Ant 2	24.5	23.46	1.27	-0.04	0.568	0.72
		LTE 7	QPSK20M	Front Face	21350	100	0	1	Ant 2	23.5	22.48	1.26	0.16	0.619	0.78
	LTE 7	QPSK20M	Front Face	21350	1	50	2	Ant 2	24.5	23.60	1.23	-0.05	0.638	0.78	
24	2 CC (CA active)	LTE 7	QPSK20M	Front Face	PCC : 21152 SCC : 21350	PCC : 1 SCC : 1	PCC : 99 SCC : 0	1	Ant 2	24.5	23.32	1.31	-0.14	0.341	0.45
	Single Carrier (CA inactive)	LTE 38	QPSK20M	Front Face	38150	1	50	1	Ant 2	24.5	23.66	1.21	-0.09	0.436	0.53
		LTE 38	QPSK20M	Rear Face	38150	1	50	1	Ant 2	24.5	23.66	1.21	0.07	0.310	0.38
		LTE 38	QPSK20M	Front Face	38150	50	25	1	Ant 2	23.5	22.61	1.23	-0.09	0.326	0.40
		LTE 38	QPSK20M	Rear Face	38150	50	25	1	Ant 2	23.5	22.61	1.23	-0.13	0.237	0.29
		LTE 38	QPSK20M	Front Face	37850	1	50	1	Ant 2	24.5	23.51	1.26	0.04	0.389	0.49
		LTE 38	QPSK20M	Front Face	38000	1	50	1	Ant 2	24.5	23.56	1.24	0.03	0.418	0.52
		LTE 38	QPSK20M	Front Face	38150	1	50	2	Ant 2	24.5	23.66	1.21	-0.06	0.427	0.52
	2 CC (CA active)	LTE 38	QPSK20M	Front Face	PCC : 37952 SCC : 38150	PCC : 1 SCC : 1	PCC : 99 SCC : 0	1	Ant 2	24.5	23.39	1.29	-0.14	0.270	0.35

FCC SAR Test Report

Plot No.	Band	Mode	Test Position	Ch.	Sample	Tx Antenna	Duty Cycle	Crest Factor	Max. Tune-up Power (dBm)	Measured Conducted Power (dBm)	Scaling Factor	Power Drift (dB)	Measured SAR-1g (W/kg)	Scaled SAR-1g (W/kg)
25	WLAN2.4G	802.11b	Front Face	11	1	Ant 0	99.40	1.01	15.0	14.96	1.01	-0.06	0.121	0.12
	WLAN2.4G	802.11b	Rear Face	11	1	Ant 0	99.40	1.01	15.0	14.96	1.01	-0.03	0.135	0.14
	WLAN2.4G	802.11b	Rear Face	1	1	Ant 0	99.40	1.01	15.0	14.95	1.01	0.02	0.126	0.13
	WLAN2.4G	802.11b	Rear Face	6	1	Ant 0	99.40	1.01	15.0	14.92	1.02	0.05	0.129	0.13
	WLAN2.4G	802.11b	Rear Face	11	2	Ant 0	99.40	1.01	15.0	14.96	1.01	-0.08	0.127	0.13
27	WLAN5.3G	802.11a	Front Face	60	1	Ant 0	96.72	1.03	14.0	13.86	1.03	-0.11	0.076	0.08
	WLAN5.3G	802.11a	Rear Face	60	1	Ant 0	96.72	1.03	14.0	13.86	1.03	0.16	0.166	0.18
	WLAN5.3G	802.11a	Rear Face	52	1	Ant 0	96.72	1.03	14.0	13.81	1.04	0.03	0.091	0.10
	WLAN5.3G	802.11a	Rear Face	56	1	Ant 0	96.72	1.03	14.0	13.65	1.08	-0.05	0.081	0.09
	WLAN5.3G	802.11a	Rear Face	64	1	Ant 0	96.72	1.03	14.0	13.66	1.08	-0.12	0.091	0.10
28	WLAN5.6G	802.11a	Front Face	140	1	Ant 0	96.72	1.03	14.0	13.96	1.01	-0.11	0.043	0.04
	WLAN5.6G	802.11a	Rear Face	140	1	Ant 0	96.72	1.03	14.0	13.96	1.01	0.17	0.106	0.11
	WLAN5.6G	802.11a	Rear Face	100	1	Ant 0	96.72	1.03	14.0	13.84	1.04	0.03	0.104	0.11
	WLAN5.6G	802.11a	Rear Face	116	1	Ant 0	96.72	1.03	14.0	13.80	1.05	-0.05	0.079	0.09
	WLAN5.6G	802.11a	Rear Face	120	1	Ant 0	96.72	1.03	14.0	13.77	1.05	0.07	0.077	0.08
	WLAN5.6G	802.11a	Rear Face	124	1	Ant 0	96.72	1.03	14.0	13.72	1.07	0.12	0.076	0.08
	WLAN5.6G	802.11a	Rear Face	132	1	Ant 0	96.72	1.03	14.0	13.69	1.07	0.06	0.073	0.08
	WLAN5.6G	802.11a	Rear Face	144	1	Ant 0	96.72	1.03	14.0	13.93	1.02	-0.08	0.099	0.10
	WLAN5.6G	802.11a	Rear Face	140	2	Ant 0	96.72	1.03	14.0	13.96	1.01	-0.05	0.095	0.10
	WLAN5.8G	802.11a	Front Face	157	1	Ant 0	96.72	1.03	14.0	13.99	1.00	0.01	0.069	0.07
29	WLAN5.8G	802.11a	Rear Face	157	1	Ant 0	96.72	1.03	14.0	13.99	1.00	-0.01	0.077	0.08
	WLAN5.8G	802.11a	Rear Face	149	1	Ant 0	96.72	1.03	14.0	13.94	1.01	-0.05	0.064	0.07
	WLAN5.8G	802.11a	Rear Face	153	1	Ant 0	96.72	1.03	14.0	13.91	1.02	0.08	0.071	0.07
	WLAN5.8G	802.11a	Rear Face	161	1	Ant 0	96.72	1.03	14.0	13.95	1.01	-0.16	0.052	0.05
	WLAN5.8G	802.11a	Rear Face	165	1	Ant 0	96.72	1.03	14.0	13.97	1.01	0.09	0.046	0.05
	WLAN5.8G	802.11a	Rear Face	157	2	Ant 0	96.72	1.03	14.0	13.99	1.00	0.02	0.066	0.07
	WLAN5.8G	802.11a	Rear Face	157	1	Ant 0	96.72	1.03	14.0	13.99	1.00	0.01	0.069	0.07
30	BT	BDR	Front Face	78	1	Ant 0	76.48	1.31	9.5	9.30	1.05	0.00	<0.001	0.00
	BT	BDR	Rear Face	78	1	Ant 0	76.48	1.31	9.5	9.30	1.05	-0.16	0.034	0.05
	BT	BDR	Rear Face	0	1	Ant 0	76.48	1.31	9.5	8.85	1.16	0.11	0.028	0.04
	BT	BDR	Rear Face	39	1	Ant 0	76.48	1.31	9.5	9.07	1.10	0.03	0.028	0.04
	BT	BDR	Rear Face	78	2	Ant 0	76.48	1.31	9.5	9.30	1.05	-0.07	0.031	0.04

Note: The "< 0.001" means there is no SAR value or the SAR is too low to be measured.

FCC SAR Test Report

4.7.4 SAR Results for Hotspot Exposure Condition (Test Separation Distance is 10 mm)

Plot No.	Band	Mode	Test Position	Ch.	Sample	Tx Antenna	Max. Tune-up Power (dBm)	Measured Conducted Power (dBm)	Scaling Factor	Power Drift (dB)	Measured SAR-1g (W/kg)	Scaled SAR-1g (W/kg)
	GSM850	GPRS12	Front Face	251	1	Ant 1	27.0	26.98	1.00	0.05	0.207	0.21
	GSM850	GPRS12	Rear Face	251	1	Ant 1	27.0	26.98	1.00	-0.07	0.260	0.26
	GSM850	GPRS12	Left Side	251	1	Ant 1	27.0	26.98	1.00	0.07	0.181	0.18
	GSM850	GPRS12	Right Side	251	1	Ant 1	27.0	26.98	1.00	-0.11	0.193	0.19
	GSM850	GPRS12	Bottom Side	251	1	Ant 1	27.0	26.98	1.00	0.03	0.172	0.17
	GSM850	GPRS12	Front Face	251	1	Ant 3	26.0	25.18	1.21	0.03	0.621	0.75
15	GSM850	GPRS12	Rear Face	251	1	Ant 3	26.0	25.18	1.21	-0.05	0.731	0.88
	GSM850	GPRS12	Left Side	251	1	Ant 3	26.0	25.18	1.21	0.09	0.367	0.44
	GSM850	GPRS12	Right Side	251	1	Ant 3	26.0	25.18	1.21	0.15	0.417	0.50
	GSM850	GPRS12	Top Side	251	1	Ant 3	26.0	25.18	1.21	0.06	0.402	0.49
	GSM850	GPRS12	Rear Face	128	1	Ant 3	26.0	25.09	1.23	0.12	0.715	0.88
	GSM850	GPRS12	Rear Face	189	1	Ant 3	26.0	25.12	1.22	0.05	0.722	0.88
	GSM850	GPRS12	Rear Face	251	2	Ant 3	26.0	25.18	1.21	-0.03	0.726	0.88
	GSM850	GPRS12	Rear Face	128	2	Ant 3	26.0	25.09	1.23	0.01	0.710	0.87
	GSM850	GPRS12	Rear Face	189	2	Ant 3	26.0	25.12	1.22	0.11	0.700	0.85
	GSM1900	EDGE12	Front Face	810	1	Ant 1	26.0	24.63	1.37	-0.04	0.241	0.33
	GSM1900	EDGE12	Rear Face	810	1	Ant 1	26.0	24.63	1.37	-0.02	0.417	0.57
	GSM1900	EDGE12	Left Side	810	1	Ant 1	26.0	24.63	1.37	0.03	0.022	0.03
	GSM1900	EDGE12	Right Side	810	1	Ant 1	26.0	24.63	1.37	-0.12	0.075	0.10
31	GSM1900	EDGE12	Bottom Side	810	1	Ant 1	26.0	24.63	1.37	-0.16	0.601	0.82
	GSM1900	EDGE12	Bottom Side	512	1	Ant 1	26.0	24.50	1.41	0.11	0.476	0.67
	GSM1900	EDGE12	Bottom Side	661	1	Ant 1	26.0	24.54	1.40	-0.09	0.480	0.67
	GSM1900	EDGE12	Bottom Side	810	2	Ant 1	26.0	24.63	1.37	-0.13	0.570	0.78
	WCDMA II	RMC12.2K	Front Face	9538	1	Ant 1	21.0	20.56	1.11	0.12	0.501	0.56
	WCDMA II	RMC12.2K	Rear Face	9538	1	Ant 1	21.0	20.56	1.11	-0.04	0.611	0.68
	WCDMA II	RMC12.2K	Left Side	9538	1	Ant 1	21.0	20.56	1.11	0.03	0.022	0.02
	WCDMA II	RMC12.2K	Right Side	9538	1	Ant 1	21.0	20.56	1.11	-0.07	0.076	0.08
32	WCDMA II	RMC12.2K	Bottom Side	9538	1	Ant 1	21.0	20.56	1.11	-0.01	0.843	0.94
	WCDMA II	RMC12.2K	Bottom Side	9262	1	Ant 1	21.0	20.49	1.12	-0.05	0.827	0.93
	WCDMA II	RMC12.2K	Bottom Side	9400	1	Ant 1	21.0	20.54	1.11	0.12	0.821	0.91
	WCDMA II	RMC12.2K	Bottom Side	9538	2	Ant 1	21.0	20.56	1.11	0.07	0.834	0.93
	WCDMA II	RMC12.2K	Bottom Side	9262	2	Ant 1	21.0	20.49	1.12	-0.08	0.821	0.92
	WCDMA II	RMC12.2K	Bottom Side	9400	2	Ant 1	21.0	20.54	1.11	0.06	0.808	0.90
	WCDMA II	RMC12.2K	Bottom Side	9538	1	Ant 1	21.0	20.56	1.11	0.05	0.834	0.93
	WCDMA IV	RMC12.2K	Front Face	1413	1	Ant 1	21.0	20.62	1.09	0.04	0.354	0.39
	WCDMA IV	RMC12.2K	Rear Face	1413	1	Ant 1	21.0	20.62	1.09	-0.12	0.586	0.64
	WCDMA IV	RMC12.2K	Left Side	1413	1	Ant 1	21.0	20.62	1.09	-0.11	0.043	0.05
	WCDMA IV	RMC12.2K	Right Side	1413	1	Ant 1	21.0	20.62	1.09	0.06	0.021	0.02
	WCDMA IV	RMC12.2K	Bottom Side	1413	1	Ant 1	21.0	20.62	1.09	0.12	0.841	0.92
	WCDMA IV	RMC12.2K	Bottom Side	1312	1	Ant 1	21.0	20.58	1.10	-0.09	0.849	0.93
33	WCDMA IV	RMC12.2K	Bottom Side	1513	1	Ant 1	21.0	20.59	1.10	-0.04	0.924	1.02
	WCDMA IV	RMC12.2K	Bottom Side	1513	2	Ant 1	21.0	20.59	1.10	0.07	0.916	1.01
	WCDMA IV	RMC12.2K	Bottom Side	1312	2	Ant 1	21.0	20.58	1.10	0.02	0.827	0.91
	WCDMA IV	RMC12.2K	Bottom Side	1413	2	Ant 1	21.0	20.62	1.09	-0.14	0.822	0.90
	WCDMA IV	RMC12.2K	Bottom Side	1513	1	Ant 1	21.0	20.59	1.10	-0.04	0.919	1.01

FCC SAR Test Report

Plot No.	Band	Mode	Test Position	Ch.	Sample	Tx Antenna	Max. Tune-up Power (dBm)	Measured Conducted Power (dBm)	Scaling Factor	Power Drift (dB)	Measured SAR-1g (W/kg)	Scaled SAR-1g (W/kg)
	WCDMA V	RMC12.2K	Front Face	4182	1	Ant 1	24.0	23.33	1.17	0.03	0.208	0.24
	WCDMA V	RMC12.2K	Rear Face	4182	1	Ant 1	24.0	23.33	1.17	-0.02	0.219	0.26
	WCDMA V	RMC12.2K	Left Side	4182	1	Ant 1	24.0	23.33	1.17	-0.13	0.037	0.04
	WCDMA V	RMC12.2K	Right Side	4182	1	Ant 1	24.0	23.33	1.17	0.05	0.173	0.20
	WCDMA V	RMC12.2K	Bottom Side	4182	1	Ant 1	24.0	23.33	1.17	-0.12	0.159	0.19
19	WCDMA V	RMC12.2K	Front Face	4182	1	Ant 3	22.0	21.47	1.13	-0.09	0.478	0.54
	WCDMA V	RMC12.2K	Rear Face	4182	1	Ant 3	22.0	21.47	1.13	-0.11	0.454	0.51
	WCDMA V	RMC12.2K	Left Side	4182	1	Ant 3	22.0	21.47	1.13	0.04	0.197	0.22
	WCDMA V	RMC12.2K	Right Side	4182	1	Ant 3	22.0	21.47	1.13	0.12	0.231	0.26
	WCDMA V	RMC12.2K	Top Side	4182	1	Ant 3	22.0	21.47	1.13	-0.07	0.368	0.42
	WCDMA V	RMC12.2K	Front Face	4132	1	Ant 3	22.0	21.33	1.17	-0.03	0.448	0.52
	WCDMA V	RMC12.2K	Front Face	4233	1	Ant 3	22.0	21.45	1.14	0.03	0.456	0.52
	WCDMA V	RMC12.2K	Front Face	4182	2	Ant 3	22.0	21.47	1.13	-0.11	0.459	0.52

Plot No.	Band	Mode	Test Position	Ch.	RB#	RB Offset	Sample	Tx Antenna	Max. Tune-up Power (dBm)	Measured Conducted Power (dBm)	Scaling Factor	Power Drift (dB)	Measured SAR-1g (W/kg)	Scaled SAR-1g (W/kg)
	LTE 2	QPSK20M	Front Face	18900	1	0	1	Ant 1	18.5	18.13	1.09	0.07	0.409	0.45
	LTE 2	QPSK20M	Rear Face	18900	1	0	1	Ant 1	18.5	18.13	1.09	-0.04	0.605	0.66
	LTE 2	QPSK20M	Left Side	18900	1	0	1	Ant 1	18.5	18.13	1.09	0.05	0.113	0.12
	LTE 2	QPSK20M	Right Side	18900	1	0	1	Ant 1	18.5	18.13	1.09	0.12	0.111	0.12
	LTE 2	QPSK20M	Bottom Side	18900	1	0	1	Ant 1	18.5	18.13	1.09	0.05	0.981	1.07
	LTE 2	QPSK20M	Front Face	18900	50	0	1	Ant 1	17.5	17.48	1.00	-0.11	0.325	0.33
	LTE 2	QPSK20M	Rear Face	18900	50	0	1	Ant 1	17.5	17.48	1.00	0.05	0.528	0.53
	LTE 2	QPSK20M	Left Side	18900	50	0	1	Ant 1	17.5	17.48	1.00	0.05	0.036	0.04
	LTE 2	QPSK20M	Right Side	18900	50	0	1	Ant 1	17.5	17.48	1.00	-0.03	0.073	0.07
	LTE 2	QPSK20M	Bottom Side	18900	50	0	1	Ant 1	17.5	17.48	1.00	-0.11	0.761	0.76
	LTE 2	QPSK20M	Bottom Side	18700	1	0	1	Ant 1	18.5	17.99	1.12	0.02	0.963	1.08
34	LTE 2	QPSK20M	Bottom Side	19100	1	0	1	Ant 1	18.5	18.04	1.11	-0.10	1.03	1.14
	LTE 2	QPSK20M	Bottom Side	18900	100	0	1	Ant 1	17.5	17.46	1.01	0.11	0.867	0.88
	LTE 2	QPSK20M	Bottom Side	19100	1	0	2	Ant 1	18.5	18.04	1.11	0.15	0.981	1.09
	LTE 2	QPSK20M	Bottom Side	18700	1	0	2	Ant 1	18.5	17.99	1.12	0.14	0.956	1.07
	LTE 2	QPSK20M	Bottom Side	18900	1	0	2	Ant 1	18.5	18.13	1.09	0.03	0.947	1.03
	LTE 2	QPSK20M	Bottom Side	19100	1	0	1	Ant 1	18.5	18.04	1.11	0.03	0.996	1.11

FCC SAR Test Report

Plot No.	Band	Mode	Test Position	Ch.	RB#	RB Offset	Sample	Tx Antenna	Max. Tune-up Power (dBm)	Measured Conducted Power (dBm)	Scaling Factor	Power Drift (dB)	Measured SAR-1g (W/kg)	Scaled SAR-1g (W/kg)
	LTE 4	QPSK20M	Front Face	20300	1	50	1	Ant 1	21.0	20.76	1.06	-0.03	0.338	0.36
	LTE 4	QPSK20M	Rear Face	20300	1	50	1	Ant 1	21.0	20.76	1.06	0.15	0.651	0.69
	LTE 4	QPSK20M	Left Side	20300	1	50	1	Ant 1	21.0	20.76	1.06	0.12	0.025	0.03
	LTE 4	QPSK20M	Right Side	20300	1	50	1	Ant 1	21.0	20.76	1.06	0.03	0.011	0.01
35	LTE 4	QPSK20M	Bottom Side	20300	1	50	1	Ant 1	21.0	20.76	1.06	0.02	0.805	0.85
	LTE 4	QPSK20M	Front Face	20300	50	0	1	Ant 1	20.0	19.69	1.07	-0.05	0.207	0.22
	LTE 4	QPSK20M	Rear Face	20300	50	0	1	Ant 1	20.0	19.69	1.07	0.05	0.232	0.25
	LTE 4	QPSK20M	Left Side	20300	50	0	1	Ant 1	20.0	19.69	1.07	0.11	0.01	0.01
	LTE 4	QPSK20M	Right Side	20300	50	0	1	Ant 1	20.0	19.69	1.07	0	0.001	0.00
	LTE 4	QPSK20M	Bottom Side	20300	50	0	1	Ant 1	20.0	19.69	1.07	-0.13	0.408	0.44
	LTE 4	QPSK20M	Bottom Side	20050	1	50	1	Ant 1	21.0	20.71	1.07	-0.05	0.473	0.51
	LTE 4	QPSK20M	Bottom Side	20175	1	50	1	Ant 1	21.0	20.73	1.06	0.06	0.458	0.49
	LTE 4	QPSK20M	Bottom Side	20300	100	0	1	Ant 1	20.0	19.64	1.09	0.02	0.741	0.81
	LTE 4	QPSK20M	Bottom Side	20300	1	50	2	Ant 1	21.0	20.76	1.06	-0.13	0.499	0.53
	LTE 4	QPSK20M	Bottom Side	20300	1	50	1	Ant 1	21.0	20.76	1.06	0.02	0.796	0.84
	LTE 5	QPSK10M	Front Face	20525	1	0	1	Ant 1	24.0	23.56	1.11	-0.08	0.235	0.26
	LTE 5	QPSK10M	Rear Face	20525	1	0	1	Ant 1	24.0	23.56	1.11	0.01	0.28	0.31
	LTE 5	QPSK10M	Left Side	20525	1	0	1	Ant 1	24.0	23.56	1.11	-0.06	0.092	0.10
	LTE 5	QPSK10M	Right Side	20525	1	0	1	Ant 1	24.0	23.56	1.11	0.11	0.108	0.12
	LTE 5	QPSK10M	Bottom Side	20525	1	0	1	Ant 1	24.0	23.56	1.11	-0.03	0.128	0.14
	LTE 5	QPSK10M	Front Face	20525	25	0	1	Ant 1	23.0	22.49	1.12	0.05	0.183	0.20
	LTE 5	QPSK10M	Rear Face	20525	25	0	1	Ant 1	23.0	22.49	1.12	0.11	0.193	0.22
	LTE 5	QPSK10M	Left Side	20525	25	0	1	Ant 1	23.0	22.49	1.12	-0.07	0.149	0.17
	LTE 5	QPSK10M	Right Side	20525	25	0	1	Ant 1	23.0	22.49	1.12	0.12	0.095	0.11
	LTE 5	QPSK10M	Bottom Side	20525	25	0	1	Ant 1	23.0	22.49	1.12	-0.06	0.107	0.12
	LTE 5	QPSK10M	Front Face	20525	1	0	1	Ant 3	22.0	21.77	1.05	0.05	0.348	0.37
22	LTE 5	QPSK10M	Rear Face	20525	1	0	1	Ant 3	22.0	21.77	1.05	-0.06	0.416	0.44
	LTE 5	QPSK10M	Left Side	20525	1	0	1	Ant 3	22.0	21.77	1.05	-0.11	0.195	0.20
	LTE 5	QPSK10M	Right Side	20525	1	0	1	Ant 3	22.0	21.77	1.05	0.03	0.144	0.15
	LTE 5	QPSK10M	Top Side	20525	1	0	1	Ant 3	22.0	21.77	1.05	-0.05	0.312	0.33
	LTE 5	QPSK10M	Front Face	20525	25	0	1	Ant 3	21.0	20.75	1.06	-0.07	0.259	0.27
	LTE 5	QPSK10M	Rear Face	20525	25	0	1	Ant 3	21.0	20.75	1.06	0.12	0.341	0.36
	LTE 5	QPSK10M	Left Side	20525	25	0	1	Ant 3	21.0	20.75	1.06	0.08	0.175	0.19
	LTE 5	QPSK10M	Right Side	20525	25	0	1	Ant 3	21.0	20.75	1.06	0.06	0.107	0.11
	LTE 5	QPSK10M	Top Side	20525	25	0	1	Ant 3	21.0	20.75	1.06	-0.09	0.248	0.26
	LTE 5	QPSK10M	Rear Face	20450	1	0	1	Ant 3	22.0	21.69	1.07	0.11	0.405	0.43
	LTE 5	QPSK10M	Rear Face	20600	1	0	1	Ant 3	22.0	21.74	1.06	-0.05	0.398	0.42
	LTE 5	QPSK10M	Rear Face	20525	1	0	2	Ant 3	22.0	21.77	1.05	0.03	0.376	0.39

Note: The "< 0.001" means there is no SAR value or the SAR is too low to be measured.

FCC SAR Test Report

Plot No.	Uplink Mode	Band	Mode	Test Position	Ch.	RB#	RB Offset	Sample	Tx Antenna	Max. Tune-up Power (dBm)	Measured Conducted Power (dBm)	Scaling Factor	Power Drift (dB)	Measured SAR-1g (W/kg)	Scaled SAR-1g (W/kg)
23	Single Carrier (CA inactive)	LTE 7	QPSK20M	Front Face	21350	1	50	1	Ant 2	24.5	23.60	1.23	-0.04	0.647	0.80
		LTE 7	QPSK20M	Rear Face	21350	1	50	1	Ant 2	24.5	23.60	1.23	0.06	0.602	0.74
		LTE 7	QPSK20M	Right Side	21350	1	50	1	Ant 2	24.5	23.60	1.23	0.04	0.140	0.17
		LTE 7	QPSK20M	Bottom Side	21350	1	50	1	Ant 2	24.5	23.60	1.23	-0.11	0.352	0.43
		LTE 7	QPSK20M	Front Face	21350	50	0	1	Ant 2	23.5	22.52	1.25	-0.09	0.534	0.67
		LTE 7	QPSK20M	Rear Face	21350	50	0	1	Ant 2	23.5	22.52	1.25	-0.13	0.416	0.52
		LTE 7	QPSK20M	Right Side	21350	50	0	1	Ant 2	23.5	22.52	1.25	0.06	0.093	0.12
		LTE 7	QPSK20M	Bottom Side	21350	50	0	1	Ant 2	23.5	22.52	1.25	0.07	0.274	0.34
		LTE 7	QPSK20M	Front Face	20850	1	50	1	Ant 2	24.5	23.42	1.28	0.011	0.528	0.68
		LTE 7	QPSK20M	Front Face	21100	1	50	1	Ant 2	24.5	23.46	1.27	-0.04	0.568	0.72
		LTE 7	QPSK20M	Front Face	21350	100	0	1	Ant 2	23.5	22.48	1.26	0.16	0.619	0.78
		LTE 7	QPSK20M	Front Face	21350	1	50	2	Ant 2	24.5	23.60	1.23	-0.05	0.638	0.78
	2 CC (CA active)	LTE 7	QPSK20M	Front Face	PCC : 21152 SCC : 21350	PCC : 1 SCC : 1	PCC : 99 SCC : 0	1	Ant 2	24.5	23.32	1.31	-0.14	0.341	0.45
24	Single Carrier (CA inactive)	LTE 38	QPSK20M	Front Face	38150	1	50	1	Ant 2	24.5	23.66	1.21	-0.09	0.436	0.53
		LTE 38	QPSK20M	Rear Face	38150	1	50	1	Ant 2	24.5	23.66	1.21	0.07	0.310	0.38
		LTE 38	QPSK20M	Right Side	38150	1	50	1	Ant 2	24.5	23.66	1.21	0.03	0.179	0.22
		LTE 38	QPSK20M	Bottom Side	38150	1	50	1	Ant 2	24.5	23.66	1.21	-0.07	0.263	0.32
		LTE 38	QPSK20M	Front Face	38150	50	25	1	Ant 2	23.5	22.61	1.23	-0.09	0.326	0.40
		LTE 38	QPSK20M	Rear Face	38150	50	25	1	Ant 2	23.5	22.61	1.23	-0.13	0.237	0.29
		LTE 38	QPSK20M	Right Side	38150	50	25	1	Ant 2	23.5	22.61	1.23	0.11	0.134	0.16
		LTE 38	QPSK20M	Bottom Side	38150	50	25	1	Ant 2	23.5	22.61	1.23	0.07	0.179	0.22
		LTE 38	QPSK20M	Front Face	37850	1	50	1	Ant 2	24.5	23.51	1.26	0.04	0.389	0.49
		LTE 38	QPSK20M	Front Face	38000	1	50	1	Ant 2	24.5	23.56	1.24	0.03	0.418	0.52
		LTE 38	QPSK20M	Front Face	38150	1	50	2	Ant 2	24.5	23.66	1.21	-0.06	0.427	0.52
			2 CC (CA active)	LTE 38	QPSK20M	Front Face	PCC : 37952 SCC : 38150	PCC : 1 SCC : 1	PCC : 99 SCC : 0	1	Ant 2	24.5	23.39	1.29	-0.14

FCC SAR Test Report

Plot No.	Band	Mode	Test Position	Ch.	Sample	Tx Antenna	Duty Cycle	Crest Factor	Max. Tune-up Power (dBm)	Measured Conducted Power (dBm)	Scaling Factor	Power Drift (dB)	Measured SAR-1g (W/kg)	Scaled SAR-1g (W/kg)
25	WLAN2.4G	802.11b	Front Face	11	1	Ant 0	99.40	1.01	15.0	14.96	1.01	-0.06	0.121	0.12
	WLAN2.4G	802.11b	Rear Face	11	1	Ant 0	99.40	1.01	15.0	14.96	1.01	-0.03	0.135	0.14
	WLAN2.4G	802.11b	Right Side	11	1	Ant 0	99.40	1.01	15.0	14.96	1.01	0.00	<0.001	0.00
	WLAN2.4G	802.11b	Top Side	11	1	Ant 0	99.40	1.01	15.0	14.96	1.01	-0.11	0.123	0.13
	WLAN2.4G	802.11b	Rear Face	1	1	Ant 0	99.40	1.01	15.0	14.95	1.01	0.02	0.126	0.13
	WLAN2.4G	802.11b	Rear Face	6	1	Ant 0	99.40	1.01	15.0	14.92	1.02	0.05	0.129	0.13
26	WLAN2.4G	802.11b	Rear Face	11	2	Ant 0	99.40	1.01	15.0	14.96	1.01	-0.08	0.127	0.13
	WLAN5.2G	802.11a	Front Face	40	1	Ant 0	96.72	1.03	14.0	13.94	1.01	-0.12	0.078	0.08
	WLAN5.2G	802.11a	Rear Face	40	1	Ant 0	96.72	1.03	14.0	13.94	1.01	-0.09	0.221	0.23
	WLAN5.2G	802.11a	Right Side	40	1	Ant 0	96.72	1.03	14.0	13.94	1.01	0.00	<0.001	0.00
	WLAN5.2G	802.11a	Top Side	40	1	Ant 0	96.72	1.03	14.0	13.94	1.01	0.09	0.063	0.07
	WLAN5.2G	802.11a	Rear Face	36	1	Ant 0	96.72	1.03	14.0	13.87	1.03	-0.10	0.202	0.21
	WLAN5.2G	802.11a	Rear Face	44	1	Ant 0	96.72	1.03	14.0	13.73	1.06	0.03	0.199	0.22
	WLAN5.2G	802.11a	Rear Face	48	1	Ant 0	96.72	1.03	14.0	13.78	1.05	0.05	0.205	0.22
29	WLAN5.2G	802.11a	Rear Face	40	2	Ant 0	96.72	1.03	14.0	13.94	1.01	-0.04	0.208	0.22
	WLAN5.8G	802.11a	Front Face	157	1	Ant 0	96.72	1.03	14.0	13.99	1.00	0.01	0.069	0.07
	WLAN5.8G	802.11a	Rear Face	157	1	Ant 0	96.72	1.03	14.0	13.99	1.00	-0.01	0.077	0.08
	WLAN5.8G	802.11a	Right Side	157	1	Ant 0	96.72	1.03	14.0	13.99	1.00	-0.05	0.045	0.05
	WLAN5.8G	802.11a	Top Side	157	1	Ant 0	96.72	1.03	14.0	13.99	1.00	-0.04	0.051	0.05
	WLAN5.8G	802.11a	Rear Face	149	1	Ant 0	96.72	1.03	14.0	13.94	1.01	-0.05	0.064	0.07
	WLAN5.8G	802.11a	Rear Face	153	1	Ant 0	96.72	1.03	14.0	13.91	1.02	0.08	0.071	0.07
	WLAN5.8G	802.11a	Rear Face	161	1	Ant 0	96.72	1.03	14.0	13.95	1.01	-0.16	0.052	0.05
36	WLAN5.8G	802.11a	Rear Face	165	1	Ant 0	96.72	1.03	14.0	13.97	1.01	0.09	0.046	0.05
	WLAN5.8G	802.11a	Rear Face	157	2	Ant 0	96.72	1.03	14.0	13.99	1.00	0.02	0.066	0.07
	BT	BDR	Front Face	78	1	Ant 0	76.48	1.31	9.5	9.30	1.05	0.00	<0.001	0.00
	BT	BDR	Rear Face	78	1	Ant 0	76.48	1.31	9.5	9.30	1.05	-0.16	0.034	0.05
	BT	BDR	Right Side	78	1	Ant 0	76.48	1.31	9.5	9.30	1.05	0.00	<0.001	0.00
	BT	BDR	Top Side	78	1	Ant 0	76.48	1.31	9.5	9.30	1.05	-0.15	0.036	0.05
	BT	BDR	Top Side	0	1	Ant 0	76.48	1.31	9.5	8.85	1.16	0.02	0.027	0.04
	BT	BDR	Top Side	39	1	Ant 0	76.48	1.31	9.5	9.07	1.10	0.01	0.028	0.04
BT	BDR	Top Side	78	2	Ant 0	76.48	1.31	9.5	9.30	1.05	-0.07	0.026	0.04	

Note: The "< 0.001" means there is no SAR value or the SAR is too low to be measured.

FCC SAR Test Report

4.7.5 SAR Results for Product Specific (Phablet) Exposure Condition (Test Separation Distance is 0 mm)

Plot No.	Band	Mode	Test Position	Ch.	Sample	Tx Antenna	Max. Tune-up Power (dBm)	Measured Conducted Power (dBm)	Scaling Factor	Power Drift (dB)	Measured SAR-10g (W/kg)	Scaled SAR-10g (W/kg)
37	WCDMA II	RMC12.2K	Front Face	9538	1	Ant 1	21.0	20.56	1.11	0.12	0.955	1.06
	WCDMA II	RMC12.2K	Rear Face	9538	1	Ant 1	21.0	20.56	1.11	0.01	2.33	2.59
	WCDMA II	RMC12.2K	Left Side	9538	1	Ant 1	21.0	20.56	1.11	0.05	0.022	0.02
	WCDMA II	RMC12.2K	Right Side	9538	1	Ant 1	21.0	20.56	1.11	0.06	0.134	0.15
	WCDMA II	RMC12.2K	Bottom Side	9538	1	Ant 1	21.0	20.56	1.11	0.02	1.64	1.82
	WCDMA II	RMC12.2K	Rear Face	9262	1	Ant 1	21.0	20.49	1.12	0.11	2.26	2.53
	WCDMA II	RMC12.2K	Rear Face	9400	1	Ant 1	21.0	20.54	1.11	-0.02	2.30	2.55
	WCDMA II	RMC12.2K	Bottom Side	9262	1	Ant 1	21.0	20.49	1.12	0.14	1.62	1.81
	WCDMA II	RMC12.2K	Bottom Side	9400	1	Ant 1	21.0	20.54	1.11	-0.05	1.69	1.88
	WCDMA II	RMC12.2K	Rear Face	9538	2	Ant 1	21.0	20.56	1.11	-0.03	2.28	2.53
	WCDMA II	RMC12.2K	Rear Face	9262	2	Ant 1	21.0	20.49	1.12	0.14	2.29	2.56
	WCDMA II	RMC12.2K	Rear Face	9400	2	Ant 1	21.0	20.54	1.11	0.02	2.25	2.50
	WCDMA II	RMC12.2K	Rear Face	9538	1	Ant 1	21.0	20.56	1.11	0.01	2.28	2.53
	38	WCDMA IV	RMC12.2K	Front Face	1413	1	Ant 1	21.0	20.62	1.09	0.11	1.08
WCDMA IV		RMC12.2K	Rear Face	1413	1	Ant 1	21.0	20.62	1.09	0.07	2.01	2.19
WCDMA IV		RMC12.2K	Left Side	1413	1	Ant 1	21.0	20.62	1.09	-0.12	0.093	0.10
WCDMA IV		RMC12.2K	Right Side	1413	1	Ant 1	21.0	20.62	1.09	0.03	0.049	0.05
WCDMA IV		RMC12.2K	Bottom Side	1413	1	Ant 1	21.0	20.62	1.09	0.05	0.742	0.81
WCDMA IV		RMC12.2K	Rear Face	1312	1	Ant 1	21.0	20.58	1.10	-0.07	2.03	2.23
WCDMA IV		RMC12.2K	Rear Face	1513	1	Ant 1	21.0	20.59	1.10	0.11	1.97	2.17
WCDMA IV		RMC12.2K	Rear Face	1312	2	Ant 1	21.0	20.58	1.10	0.05	1.97	2.17
WCDMA IV		RMC12.2K	Rear Face	1413	2	Ant 1	21.0	20.62	1.09	0.02	1.84	2.01
WCDMA IV		RMC12.2K	Rear Face	1513	2	Ant 1	21.0	20.59	1.10	0.07	1.79	1.97
WCDMA IV	RMC12.2K	Rear Face	1312	1	Ant 1	21.0	20.58	1.10	-0.07	1.98	2.18	

Note: The “< 0.001” means there is no SAR value or the SAR is too low to be measured.

FCC SAR Test Report

Plot No.	Band	Mode	Test Position	Ch.	RB#	RB Offset	Sample	Tx Antenna	Max. Tune-up Power (dBm)	Measured Conducted Power (dBm)	Scaling Factor	Power Drift (dB)	Measured SAR-10g (W/kg)	Scaled SAR-10g (W/kg)
	LTE 2	QPSK20M	Front Face	18900	1	0	1	Ant 1	23.0	22.51	1.12	-0.02	1.55	1.74
	LTE 2	QPSK20M	Rear Face	18900	1	0	1	Ant 1	23.0	22.51	1.12	0.11	2.79	3.12
	LTE 2	QPSK20M	Left Side	18900	1	0	1	Ant 1	23.0	22.51	1.12	-0.03	0.101	0.11
	LTE 2	QPSK20M	Right Side	18900	1	0	1	Ant 1	23.0	22.51	1.12	-0.03	0.112	0.13
	LTE 2	QPSK20M	Bottom Side	18900	1	0	1	Ant 1	23.0	22.51	1.12	0.11	2.09	2.34
	LTE 2	QPSK20M	Front Face	18900	50	0	1	Ant 1	22.0	21.92	1.02	0.14	1.33	1.36
	LTE 2	QPSK20M	Rear Face	18900	50	0	1	Ant 1	22.0	21.92	1.02	0.14	2.37	2.42
	LTE 2	QPSK20M	Left Side	18900	50	0	1	Ant 1	22.0	21.92	1.02	0.02	0.084	0.09
	LTE 2	QPSK20M	Right Side	18900	50	0	1	Ant 1	22.0	21.92	1.02	0.03	0.107	0.11
	LTE 2	QPSK20M	Bottom Side	18900	50	0	1	Ant 1	22.0	21.92	1.02	0.06	1.72	1.75
	LTE 2	QPSK20M	Rear Face	18700	1	0	1	Ant 1	23.0	22.46	1.13	0.14	2.75	3.11
39	LTE 2	QPSK20M	Rear Face	19100	1	0	1	Ant 1	23.0	22.41	1.15	0.14	2.95	3.39
	LTE 2	QPSK20M	Bottom Side	18700	1	0	1	Ant 1	23.0	22.46	1.13	0.09	2.07	2.34
	LTE 2	QPSK20M	Bottom Side	19100	1	0	1	Ant 1	23.0	22.41	1.15	-0.13	2.13	2.45
	LTE 2	QPSK20M	Rear Face	18700	50	0	1	Ant 1	22.0	21.88	1.03	0.14	2.36	2.43
	LTE 2	QPSK20M	Rear Face	19100	50	0	1	Ant 1	22.0	21.83	1.04	-0.02	2.39	2.49
	LTE 2	QPSK20M	Rear Face	18900	100	0	1	Ant 1	22.0	21.87	1.03	0.06	2.58	2.66
	LTE 2	QPSK20M	Bottom Side	18900	100	0	1	Ant 1	22.0	21.87	1.03	0.11	1.83	1.88
	LTE 2	QPSK20M	Rear Face	19100	1	0	2	Ant 1	23.0	22.41	1.15	0.03	2.83	3.25
	LTE 2	QPSK20M	Rear Face	18700	1	0	2	Ant 1	23.0	22.46	1.13	0.03	2.77	3.13
	LTE 2	QPSK20M	Rear Face	18900	1	0	2	Ant 1	23.0	22.51	1.12	0.04	2.65	2.97
	LTE 2	QPSK20M	Rear Face	19100	1	0	1	Ant 1	23.0	22.41	1.15	0.14	2.91	3.35
	LTE 4	QPSK20M	Front Face	20300	1	50	1	Ant 1	21.0	20.76	1.06	0.01	1.08	1.14
	LTE 4	QPSK20M	Rear Face	20300	1	50	1	Ant 1	21.0	20.76	1.06	-0.03	1.83	1.94
	LTE 4	QPSK20M	Left Side	20300	1	50	1	Ant 1	21.0	20.76	1.06	0.12	0.121	0.13
	LTE 4	QPSK20M	Right Side	20300	1	50	1	Ant 1	21.0	20.76	1.06	-0.07	0.048	0.05
	LTE 4	QPSK20M	Bottom Side	20300	1	50	1	Ant 1	21.0	20.76	1.06	0.15	1.86	1.97
	LTE 4	QPSK20M	Front Face	20300	50	0	1	Ant 1	20.0	19.69	1.07	0.06	0.951	1.02
	LTE 4	QPSK20M	Rear Face	20300	50	0	1	Ant 1	20.0	19.69	1.07	-0.07	1.62	1.73
	LTE 4	QPSK20M	Left Side	20300	50	0	1	Ant 1	20.0	19.69	1.07	0.12	0.102	0.11
	LTE 4	QPSK20M	Right Side	20300	50	0	1	Ant 1	20.0	19.69	1.07	-0.03	0.041	0.04
	LTE 4	QPSK20M	Bottom Side	20300	50	0	1	Ant 1	20.0	19.69	1.07	0.11	1.74	1.86
40	LTE 4	QPSK20M	Rear Face	20050	1	50	1	Ant 1	21.0	20.71	1.07	-0.07	1.89	2.02
	LTE 4	QPSK20M	Rear Face	20175	1	50	1	Ant 1	21.0	20.73	1.06	0.05	1.86	1.97
	LTE 4	QPSK20M	Rear Face	20300	100	0	1	Ant 1	20.0	19.64	1.09	-0.08	1.48	1.61

Note: The “< 0.001” means there is no SAR value or the SAR is too low to be measured.

FCC SAR Test Report

Plot No.	Band	Mode	Test Position	Ch.	Sample	Tx Antenna	Duty Cycle	Crest Factor	Max. Tune-up Power (dBm)	Measured Conducted Power (dBm)	Scaling Factor	Power Drift (dB)	Measured SAR-10g (W/kg)	Scaled SAR-10g (W/kg)
41	WLAN5.3G	802.11a	Front Face	60	1	Ant 0	96.72	1.03	14.0	13.86	1.03	-0.06	0.157	0.17
	WLAN5.3G	802.11a	Rear Face	60	1	Ant 0	96.72	1.03	14.0	13.86	1.03	0.03	0.411	0.44
	WLAN5.3G	802.11a	Right Side	60	1	Ant 0	96.72	1.03	14.0	13.86	1.03	0.11	0.089	0.09
	WLAN5.3G	802.11a	Top Side	60	1	Ant 0	96.72	1.03	14.0	13.86	1.03	0.03	0.153	0.16
	WLAN5.3G	802.11a	Rear Face	52	1	Ant 0	96.72	1.03	14.0	13.81	1.04	-0.04	0.386	0.41
	WLAN5.3G	802.11a	Rear Face	56	1	Ant 0	96.72	1.03	14.0	13.65	1.08	0.01	0.384	0.43
42	WLAN5.3G	802.11a	Rear Face	64	1	Ant 0	96.72	1.03	14.0	13.66	1.08	-0.18	0.385	0.43
	WLAN5.3G	802.11a	Rear Face	60	2	Ant 0	96.72	1.03	14.0	13.86	1.03	-0.12	0.402	0.43
	WLAN5.6G	802.11a	Front Face	140	1	Ant 0	96.72	1.03	14.0	13.96	1.01	-0.09	0.206	0.21
	WLAN5.6G	802.11a	Rear Face	140	1	Ant 0	96.72	1.03	14.0	13.96	1.01	0.09	0.476	0.50
	WLAN5.6G	802.11a	Right Side	140	1	Ant 0	96.72	1.03	14.0	13.96	1.01	0.05	0.194	0.20
	WLAN5.6G	802.11a	Top Side	140	1	Ant 0	96.72	1.03	14.0	13.96	1.01	0.02	0.168	0.17
	WLAN5.6G	802.11a	Rear Face	100	1	Ant 0	96.72	1.03	14.0	13.84	1.04	-0.11	0.444	0.48
	WLAN5.6G	802.11a	Rear Face	116	1	Ant 0	96.72	1.03	14.0	13.80	1.05	0.03	0.436	0.47
	WLAN5.6G	802.11a	Rear Face	120	1	Ant 0	96.72	1.03	14.0	13.77	1.05	0.15	0.408	0.44
	WLAN5.6G	802.11a	Rear Face	124	1	Ant 0	96.72	1.03	14.0	13.72	1.07	-0.17	0.406	0.45
WLAN5.6G	802.11a	Rear Face	132	1	Ant 0	96.72	1.03	14.0	13.69	1.07	0.02	0.436	0.48	
WLAN5.6G	802.11a	Rear Face	144	1	Ant 0	96.72	1.03	14.0	13.93	1.02	0.04	0.429	0.45	
WLAN5.6G	802.11a	Rear Face	140	2	Ant 0	96.72	1.03	14.0	13.96	1.01	0.05	0.453	0.47	

Note: The "< 0.001" means there is no SAR value or the SAR is too low to be measured.

4.7.6 SAR Measurement Variability

According to KDB 865664 D01, SAR measurement variability was assessed for each frequency band, which is determined by the SAR probe calibration point and tissue-equivalent medium used for the device measurements. When both head and body tissue-equivalent media are required for SAR measurements in a frequency band, the variability measurement procedures should be applied to the tissue medium with the highest measured SAR, using the highest measured SAR configuration for that tissue-equivalent medium. Alternatively, if the highest measured SAR for both head and body tissue-equivalent media are ≤ 1.45 W/kg and the ratio of these highest SAR values, i.e., largest divided by smallest value, is ≤ 1.10 , the highest SAR configuration for either head or body tissue-equivalent medium maybe used to perform the repeated measurement. These additional measurements are repeated after the completion of all measurements requiring the same head or body tissue-equivalent medium in a frequency band. The test device should be returned to ambient conditions (normal room temperature) with the battery fully charged before it is re-mounted on the device holder for the repeated measurement(s) to minimize any unexpected variations in the repeated results.

SAR repeated measurement procedure:

1. When the highest measured SAR is < 0.80 W/kg, repeated measurement is not required.
2. When the highest measured SAR is ≥ 0.80 W/kg, repeat that measurement once.
3. If the ratio of largest to smallest SAR for the original and first repeated measurements is > 1.20 , or when the original or repeated measurement is ≥ 1.45 W/kg, perform a second repeated measurement.
4. If the ratio of largest to smallest SAR for the original, first and second repeated measurements is > 1.20 , and the original, first or second repeated measurement is ≥ 1.5 W/kg, perform a third repeated measurement.

<Head>

Band	Mode	Test Position	Ch.	Original Measured SAR-1g (W/kg)	1st Repeated SAR-1g (W/kg)	L/S Ratio	2nd Repeated SAR-1g (W/kg)	L/S Ratio	3rd Repeated SAR-1g (W/kg)	L/S Ratio
GSM850	GPRS12	Right Cheek	251	1.07	1.02	1.05	N/A	N/A	N/A	N/A
WCDMA V	RMC12.2K	Right Cheek	4182	1.05	1.02	1.03	N/A	N/A	N/A	N/A
LTE 5	QPSK10M	Right Check	20450	1.01	0.98	1.03	N/A	N/A	N/A	N/A

<Hotspot>

Band	Mode	Test Position	Ch.	Original Measured SAR-1g (W/kg)	1st Repeated SAR-1g (W/kg)	L/S Ratio	2nd Repeated SAR-1g (W/kg)	L/S Ratio	3rd Repeated SAR-1g (W/kg)	L/S Ratio
WCDMA II	RMC12.2K	Bottom Side	9538	0.843	0.834	1.01	N/A	N/A	N/A	N/A
WCDMA IV	RMC12.2K	Bottom Side	1513	0.924	0.919	1.01	N/A	N/A	N/A	N/A
LTE 2	QPSK20M	Bottom Side	19100	1.03	0.996	1.03	N/A	N/A	N/A	N/A
LTE 4	QPSK20M	Bottom Side	20300	0.805	0.796	1.01	N/A	N/A	N/A	N/A

FCC SAR Test Report

<Extremity>

Band	Mode	Test Position	Ch.	Original Measured SAR-10g (W/kg)	1st Repeated SAR-10g (W/kg)	L/S Ratio	2nd Repeated SAR-1g (W/kg)	L/S Ratio	3rd Repeated SAR-1g (W/kg)	L/S Ratio
WCDMA II	RMC12.2K	Rear Face	9538	2.33	2.28	1.02	N/A	N/A	N/A	N/A
WCDMA IV	RMC12.2K	Rear Face	1312	2.03	1.98	1.03	N/A	N/A	N/A	N/A
LTE 2	QPSK20M	Rear Face	19100	2.95	2.91	1.01	N/A	N/A	N/A	N/A

4.7.7 Simultaneous Multi-band Transmission Evaluation

<Possibilities of Simultaneous Transmission>

The simultaneous transmission possibilities for this device are listed as below.

Simultaneous TX Combination	Capable Transmit Configurations	Head Exposure Condition	Body-worn Exposure Condition	Hotspot Exposure Condition
1	WWAN + WLAN 2.4G	Yes	Yes	Yes
2	WWAN + WLAN 5G	Yes	Yes	Yes
3	WWAN + BT	Yes	Yes	Yes

Note :

1. The WLAN 2.4G and WLAN 5G cannot transmit simultaneously.
2. The WLAN and Bluetooth cannot transmit simultaneously.

FCC SAR Test Report

<SAR Summation Analysis>

Simultaneous transmission SAR test exclusion is determined for each operating configuration and exposure condition according to the reported standalone SAR of each applicable simultaneous transmitting antenna. When the sum of SAR_{1g} of all simultaneously transmitting antennas in an operating mode and exposure condition combination is within the SAR limit(SAR_{1g} 1.6 W/kg), the simultaneous transmission SAR is not required. When the sum of SAR_{1g} is greater than the SAR limit (SAR_{1g} 1.6 W/kg), SAR test exclusion is determined by the SPLSR.

Band	Mode	Position	1g SAR W/kg				Summing result 1g SAR W/kg		
			1	2	3	4	1+2	1+3	1+4
			Max WWAN	Max WLAN 2.4GHz	Max WLAN 5GHz	BT			
GSM850	Head	Right Cheek	1.09	0.49	0.33	0.13	1.58	1.42	1.22
		Right Tilted	0.72	0.39	0.25	0.11	1.11	0.97	0.83
		Left Cheek	0.81	0.73	0.74	0.18	1.54	1.55	0.99
		Left Tilted	0.50	0.57	0.47	0.13	1.07	0.97	0.63
GSM1900	Head	Right Cheek	0.02	0.49	0.33	0.13	0.51	0.35	0.15
		Right Tilted	0.00	0.39	0.25	0.11	0.39	0.25	0.11
		Left Cheek	0.01	0.73	0.74	0.18	0.74	0.75	0.19
		Left Tilted	0.00	0.57	0.47	0.13	0.57	0.47	0.13
WCDMA II	Head	Right Cheek	0.05	0.49	0.33	0.13	0.54	0.38	0.18
		Right Tilted	0.00	0.39	0.25	0.11	0.39	0.25	0.11
		Left Cheek	0.01	0.73	0.74	0.18	0.74	0.75	0.19
		Left Tilted	0.00	0.57	0.47	0.13	0.57	0.47	0.13
WCDMA IV	Head	Right Cheek	0.00	0.49	0.33	0.13	0.49	0.33	0.13
		Right Tilted	0.00	0.39	0.25	0.11	0.39	0.25	0.11
		Left Cheek	0.00	0.73	0.74	0.18	0.73	0.74	0.18
		Left Tilted	0.00	0.57	0.47	0.13	0.57	0.47	0.13
WCDMA V	Head	Right Cheek	1.06	0.49	0.33	0.13	1.55	1.39	1.19
		Right Tilted	0.66	0.39	0.25	0.11	1.05	0.91	0.77
		Left Cheek	0.81	0.73	0.74	0.18	1.54	1.55	0.99
		Left Tilted	0.40	0.57	0.47	0.13	0.97	0.87	0.53
LTE 2	Head	Right Cheek	0.07	0.49	0.33	0.13	0.56	0.40	0.20
		Right Tilted	0.02	0.39	0.25	0.11	0.41	0.27	0.13
		Left Cheek	0.04	0.73	0.74	0.18	0.77	0.78	0.22
		Left Tilted	0.00	0.57	0.47	0.13	0.57	0.47	0.13
LTE 4	Head	Right Cheek	0.01	0.49	0.33	0.13	0.50	0.34	0.14
		Right Tilted	0.00	0.39	0.25	0.11	0.39	0.25	0.11
		Left Cheek	0.00	0.73	0.74	0.18	0.73	0.74	0.18
		Left Tilted	0.00	0.57	0.47	0.13	0.57	0.47	0.13
LTE 5	Head	Right Cheek	1.08	0.49	0.33	0.13	1.57	1.41	1.21
		Right Tilted	0.77	0.39	0.25	0.11	1.16	1.02	0.88
		Left Cheek	0.85	0.73	0.74	0.18	1.58	1.59	1.03
		Left Tilted	0.65	0.57	0.47	0.13	1.22	1.12	0.78

FCC SAR Test Report

Band	Mode	Position	1g SAR W/kg				Summing result 1g SAR W/kg		
			1	2	3	4	1+2	1+3	1+4
			Max WWAN	Max WLAN 2.4GHz	Max WLAN 5GHz	BT			
LTE 7	Head	Right Cheek	0.15	0.49	0.33	0.13	0.64	0.48	0.28
		Right Tilted	0.06	0.39	0.25	0.11	0.45	0.31	0.17
		Left Cheek	0.12	0.73	0.74	0.18	0.85	0.86	0.30
		Left Tilted	0.06	0.57	0.47	0.13	0.63	0.53	0.19
LTE 38	Head	Right Cheek	0.10	0.49	0.33	0.13	0.59	0.43	0.23
		Right Tilted	0.03	0.39	0.25	0.11	0.42	0.28	0.14
		Left Cheek	0.05	0.73	0.74	0.18	0.78	0.79	0.23
		Left Tilted	0.04	0.57	0.47	0.13	0.61	0.51	0.17

Band	Mode	Position	1g SAR W/kg				Summing result 1g SAR W/kg		
			1	2	3	4	1+2	1+3	1+4
			Max WWAN	Max WLAN 2.4GHz	Max WLAN 5GHz	BT			
GSM850	Body-worn	Front Face	0.75	0.12	0.08	0.00	0.87	0.83	0.75
		Rear Face	0.88	0.14	0.18	0.05	1.02	1.06	0.93
GSM1900	Body-worn	Front Face	0.33	0.12	0.08	0.00	0.45	0.41	0.33
		Rear Face	0.57	0.14	0.18	0.05	0.71	0.75	0.62
WCDMA II	Body-worn	Front Face	0.56	0.12	0.08	0.00	0.68	0.64	0.56
		Rear Face	0.68	0.14	0.18	0.05	0.82	0.86	0.73
WCDMA IV	Body-worn	Front Face	0.39	0.12	0.08	0.00	0.51	0.47	0.39
		Rear Face	0.64	0.14	0.18	0.05	0.78	0.82	0.69
WCDMA V	Body-worn	Front Face	0.54	0.12	0.08	0.00	0.66	0.62	0.54
		Rear Face	0.51	0.14	0.18	0.05	0.65	0.69	0.56
LTE 2	Body-worn	Front Face	0.45	0.12	0.08	0.00	0.57	0.53	0.45
		Rear Face	0.66	0.14	0.18	0.05	0.80	0.84	0.71
LTE 4	Body-worn	Front Face	0.36	0.12	0.08	0.00	0.48	0.44	0.36
		Rear Face	0.69	0.14	0.18	0.05	0.83	0.87	0.74
LTE 5	Body-worn	Front Face	0.37	0.12	0.08	0.00	0.49	0.45	0.37
		Rear Face	0.44	0.14	0.18	0.05	0.58	0.62	0.49
LTE 7	Body-worn	Front Face	0.80	0.12	0.08	0.00	0.92	0.88	0.80
		Rear Face	0.74	0.14	0.18	0.05	0.88	0.92	0.79
LTE 38	Body-worn	Front Face	0.53	0.12	0.08	0.00	0.65	0.61	0.53
		Rear Face	0.38	0.14	0.18	0.05	0.52	0.56	0.43

FCC SAR Test Report

Band	Mode	Position	1g SAR W/kg				Summing result 1g SAR W/kg		
			1	2	3	4	1+2	1+3	1+4
			Max WWAN	Max WLAN 2.4GHz	Max WLAN 5GHz	BT			
GSM850	Hotspot	Front Face	0.75	0.12	0.08	0.00	0.87	0.83	0.75
		Rear Face	0.88	0.14	0.23	0.05	1.02	1.11	0.93
		Left Side	0.44	0.00	0.00	0.00	0.44	0.44	0.44
		Right Side	0.50	0.00	0.05	0.00	0.50	0.55	0.50
		Top Side	0.49	0.13	0.07	0.05	0.62	0.56	0.54
		Bottom Side	0.17	0.00	0.00	0.00	0.17	0.17	0.17
GSM1900	Hotspot	Front Face	0.33	0.12	0.08	0.00	0.45	0.41	0.33
		Rear Face	0.57	0.14	0.23	0.05	0.71	0.80	0.62
		Left Side	0.03	0.00	0.00	0.00	0.03	0.03	0.03
		Right Side	0.10	0.00	0.05	0.00	0.10	0.15	0.10
		Top Side	0.00	0.13	0.07	0.05	0.13	0.07	0.05
		Bottom Side	0.82	0.00	0.00	0.00	0.82	0.82	0.82
WCDMA II	Hotspot	Front Face	0.56	0.12	0.08	0.00	0.68	0.64	0.56
		Rear Face	0.68	0.14	0.23	0.05	0.82	0.91	0.73
		Left Side	0.02	0.00	0.00	0.00	0.02	0.02	0.02
		Right Side	0.08	0.00	0.05	0.00	0.08	0.13	0.08
		Top Side	0.00	0.13	0.07	0.05	0.13	0.07	0.05
		Bottom Side	0.94	0.00	0.00	0.00	0.94	0.94	0.94
WCDMA IV	Hotspot	Front Face	0.39	0.12	0.08	0.00	0.51	0.47	0.39
		Rear Face	0.64	0.14	0.23	0.05	0.78	0.87	0.69
		Left Side	0.05	0.00	0.00	0.00	0.05	0.05	0.05
		Right Side	0.02	0.00	0.05	0.00	0.02	0.07	0.02
		Top Side	0.00	0.13	0.07	0.05	0.13	0.07	0.05
		Bottom Side	1.02	0.00	0.00	0.00	1.02	1.02	1.02
WCDMA V	Hotspot	Front Face	0.54	0.12	0.08	0.00	0.66	0.62	0.54
		Rear Face	0.51	0.14	0.23	0.05	0.65	0.74	0.56
		Left Side	0.22	0.00	0.00	0.00	0.22	0.22	0.22
		Right Side	0.26	0.00	0.05	0.00	0.26	0.31	0.26
		Top Side	0.42	0.13	0.07	0.05	0.55	0.49	0.47
		Bottom Side	0.19	0.00	0.00	0.00	0.19	0.19	0.19
LTE 2	Hotspot	Front Face	0.45	0.12	0.08	0.00	0.57	0.53	0.45
		Rear Face	0.66	0.14	0.23	0.05	0.80	0.89	0.71
		Left Side	0.12	0.00	0.00	0.00	0.12	0.12	0.12
		Right Side	0.12	0.00	0.05	0.00	0.12	0.17	0.12
		Top Side	0.00	0.13	0.07	0.05	0.13	0.07	0.05
		Bottom Side	1.14	0.00	0.00	0.00	1.14	1.14	1.14

FCC SAR Test Report

Band	Mode	Position	1g SAR W/kg				Summing result 1g SAR W/kg		
			1	2	3	4	1+2	1+3	1+4
			Max WWAN	Max WLAN 2.4GHz	Max WLAN 5GHz	BT			
LTE 4	Hotspot	Front Face	0.36	0.12	0.08	0.00	0.48	0.44	0.36
		Rear Face	0.69	0.14	0.23	0.05	0.83	0.92	0.74
		Left Side	0.03	0.00	0.00	0.00	0.03	0.03	0.03
		Right Side	0.01	0.00	0.05	0.00	0.01	0.06	0.01
		Top Side	0.00	0.13	0.07	0.05	0.13	0.07	0.05
		Bottom Side	0.85	0.00	0.00	0.00	0.85	0.85	0.85
LTE 5	Hotspot	Front Face	0.37	0.12	0.08	0.00	0.49	0.45	0.37
		Rear Face	0.44	0.14	0.23	0.05	0.58	0.67	0.49
		Left Side	0.20	0.00	0.00	0.00	0.20	0.20	0.20
		Right Side	0.15	0.00	0.05	0.00	0.15	0.20	0.15
		Top Side	0.33	0.13	0.07	0.05	0.46	0.40	0.38
		Bottom Side	0.14	0.00	0.00	0.00	0.14	0.14	0.14
LTE 7	Hotspot	Front Face	0.80	0.12	0.08	0.00	0.92	0.88	0.80
		Rear Face	0.74	0.14	0.23	0.05	0.88	0.97	0.79
		Left Side	0.00	0.00	0.00	0.00	0.00	0.00	0.00
		Right Side	0.17	0.00	0.05	0.00	0.17	0.22	0.17
		Top Side	0.00	0.13	0.07	0.05	0.13	0.07	0.05
		Bottom Side	0.43	0.00	0.00	0.00	0.43	0.43	0.43
LTE 38	Hotspot	Front Face	0.53	0.12	0.08	0.00	0.65	0.61	0.53
		Rear Face	0.38	0.14	0.23	0.05	0.52	0.61	0.43
		Left Side	0.00	0.00	0.00	0.00	0.00	0.00	0.00
		Right Side	0.22	0.00	0.05	0.00	0.22	0.27	0.22
		Top Side	0.00	0.13	0.07	0.05	0.13	0.07	0.05
		Bottom Side	0.32	0.00	0.00	0.00	0.32	0.32	0.32

FCC SAR Test Report

Band	Mode	Position	10g SAR W/kg		Summing result
			1	2	10g SAR W/kg
			Max WWAN	Max WLAN 5GHz	1+2
WCDMA II	Product Specific	Front Face	1.06	0.21	1.27
		Rear Face	2.59	0.50	3.09
		Left Side	0.02	0.00	0.02
		Right Side	0.15	0.20	0.35
		Top Side	0.00	0.17	0.17
		Bottom Side	1.88	0.00	1.88
WCDMA IV	Product Specific	Front Face	1.18	0.21	1.39
		Rear Face	2.23	0.50	2.73
		Left Side	0.10	0.00	0.10
		Right Side	0.05	0.20	0.25
		Top Side	0.00	0.17	0.17
		Bottom Side	0.81	0.00	0.81
LTE 2	Product Specific	Front Face	1.74	0.21	1.95
		Rear Face	3.39	0.50	3.89
		Left Side	0.11	0.00	0.11
		Right Side	0.13	0.20	0.33
		Top Side	0.00	0.17	0.17
		Bottom Side	2.45	0.00	2.45
LTE 4	Product Specific	Front Face	1.14	0.21	1.35
		Rear Face	2.02	0.50	2.52
		Left Side	0.13	0.00	0.13
		Right Side	0.05	0.20	0.25
		Top Side	0.00	0.17	0.17
		Bottom Side	1.97	0.00	1.97

Test Engineer : Willy Chang, and James Chu

5. Calibration of Test Equipment

Equipment	Manufacturer	Model	SN	Cal. Date	Cal. Interval
System Validation Dipole	SPEAG	D835V2	4d092	Jun. 20, 2019	1 Year
System Validation Dipole	SPEAG	D1750V2	1023	Jun. 20, 2019	1 Year
System Validation Dipole	SPEAG	D1900V2	5d036	Jan. 25, 2019	1 Year
System Validation Dipole	SPEAG	D2450V2	835	Jun. 27, 2019	1 Year
System Validation Dipole	SPEAG	D2600V2	1058	Jun. 27, 2019	1 Year
System Validation Dipole	SPEAG	D5GHzV2	1019	Mar. 21, 2019	1 Year
Dosimetric E-Field Probe	SPEAG	EX3DV4	3650	May. 20, 2019	1 Year
Dosimetric E-Field Probe	SPEAG	EX3DV4	3971	Mar. 29, 2019	1 Year
Dosimetric E-Field Probe	SPEAG	EX3DV4	3898	Jun. 27, 2019	1 Year
Dosimetric E-Field Probe	SPEAG	EX3DV4	7537	Jun. 18, 2019	1 Year
Data Acquisition Electronics	SPEAG	DAE4	1431	Mar. 25, 2019	1 Year
Data Acquisition Electronics	SPEAG	DAE4	861	May. 08, 2019	1 Year
Data Acquisition Electronics	SPEAG	DAE4	1585	Jun. 07, 2019	1 Year
Data Acquisition Electronics	SPEAG	DAE4	916	Dec. 12, 2018	1 Year
Radio Communication Analyzer	Anritsu	MT8820C	6201300638	Jun. 27, 2019	1 Year
Radio Communication Analyzer	Anritsu	MT8820C	6201010285	Aug. 05, 2019	1 Year
Radio Communication Analyzer	Anritsu	MT8821C	6201381727	Jun. 14, 2019	1 Year
Spectrum Analyzer	R&S	FSL6	102006	Mar. 26, 2019	1 Year
ENA Series Network Analyzer	Agilent	E5071C	MY46214281	Jun. 17, 2019	1 Year
MXG Analog Signal Generator	Agilent	N5181A	MY50143868	Jun. 27, 2019	1 Year
Power Meter	Anritsu	ML2495A	1218009	Jun. 28, 2019	1 Year
Power Sensor	Anritsu	MA2411B	1207252	Jun. 28, 2019	1 Year
Thermometer	YFE	YF-160A	130504591	Mar. 22, 2019	1 Year

6. Measurement Uncertainty

According to KDB 865664 D01, SAR measurement uncertainty analysis is required in SAR reports only when the highest measured SAR in a frequency band is ≥ 1.5 W/kg for 1-g SAR, and ≥ 3.75 W/kg for 10-g SAR. The procedures described in IEEE Std 1528-2013 should be applied. The expanded SAR measurement uncertainty must be $\leq 30\%$, for a confidence interval of $k = 2$. When the highest measured SAR within a frequency band is < 1.5 W/kg for 1-g and < 3.75 W/kg for 10-g, the extensive SAR measurement uncertainty analysis described in IEEE Std 1528-2013 is not required in SAR reports submitted for equipment approval. Hence, the measurement uncertainty analysis is not required in this SAR report because the test result met the condition.

7. Information of the Testing Laboratories

We, Bureau Veritas Consumer Products Services (H.K.) Ltd., Taoyuan Branch, were founded in 1988 to provide our best service in EMC, Radio, Telecom and Safety consultation. Our laboratories are accredited and approved according to ISO/IEC 17025.

If you have any comments, please feel free to contact us at the following:

Taiwan Huaya Lab:

Add: No. 19, Huaya 2nd Rd., Guishan Dist., Taoyuan City 333, Taiwan

Tel: +886-(0)3-318-3232

Fax: +886-(0)3-211-5834

Taiwan Linkou Lab:

Add: No. 47-2, Baodoucuokeng, Linkou Dist., New Taipei City 244, Taiwan

Tel: +886-(0)2-2605-2180

Fax: +886-(0)2-2605-2943

Taiwan Hsinchu Lab1:

Add: E-2, No. 1, Lixing 1st Rd., East Dist., Hsinchu City 300, Taiwan

Tel: +886-(0)3-666-8565

Fax: +886-(0)3-666-8323

Taiwan Hsinchu Lab2:

Add: No. 49, Ln. 206, Wende Rd., Qionglin Township, Hsinchu County 307, Taiwan

Tel: +886-(0)3-512-0595

Fax: +886-(0)3-512-0568

Taiwan Xindian Lab:

Add: B2F., No. 215, Sec. 3, Beixin Rd., Xindian Dist., New Taipei City 231, Taiwan

Tel: +886-(0)2-8914-5882

Fax: +886-(0)2-8914-5840

Email: service.adt@tw.bureauveritas.com

Web Site: <https://ee.bureauveritas.com.tw/BVInternet/Default>

The road map of all our labs can be found in our web site also.

---END---



Appendix A. SAR Plots of System Verification

The plots for system verification with largest deviation for each SAR system combination are shown as follows.

System Check_H835_191007

DUT: Dipole 835 MHz; Type: D835V2; SN: 4d092

Communication System: CW; Frequency: 835 MHz; Duty Cycle: 1:1

Medium: H07T10N3_1007 Medium parameters used: $f = 835$ MHz; $\sigma = 0.928$ S/m; $\epsilon_r = 42.015$; $\rho = 1000$ kg/m³

Ambient Temperature : 23.5 °C ; Liquid Temperature : 23.2 °C

DASY5 Configuration:

- Probe: EX3DV4 - SN7537; ConvF(10.48, 10.48, 10.48); Calibrated: 2019/06/18
- Sensor-Surface: 1.4mm (Mechanical Surface Detection)
- Electronics: DAE4 Sn1585; Calibrated: 2019/06/07
- Phantom: SAM Phantom_1982; Type: QD 000 P41 Ax; Serial: 1982
- Measurement SW: DASY52, Version 52.10 (2); SEMCAD X Version 14.6.12 (7470)

Pin=250mW/Area Scan (61x61x1): Interpolated grid: dx=1.500 mm, dy=1.500 mm
Maximum value of SAR (interpolated) = 3.42 W/kg

Pin=250mW/Zoom Scan (5x5x7)/Cube 0: Measurement grid: dx=8mm, dy=8mm, dz=5mm
Reference Value = 63.18 V/m; Power Drift = 0.01 dB
Peak SAR (extrapolated) = 3.93 W/kg
SAR(1 g) = 2.53 W/kg; SAR(10 g) = 1.63 W/kg
Maximum value of SAR (measured) = 3.45 W/kg

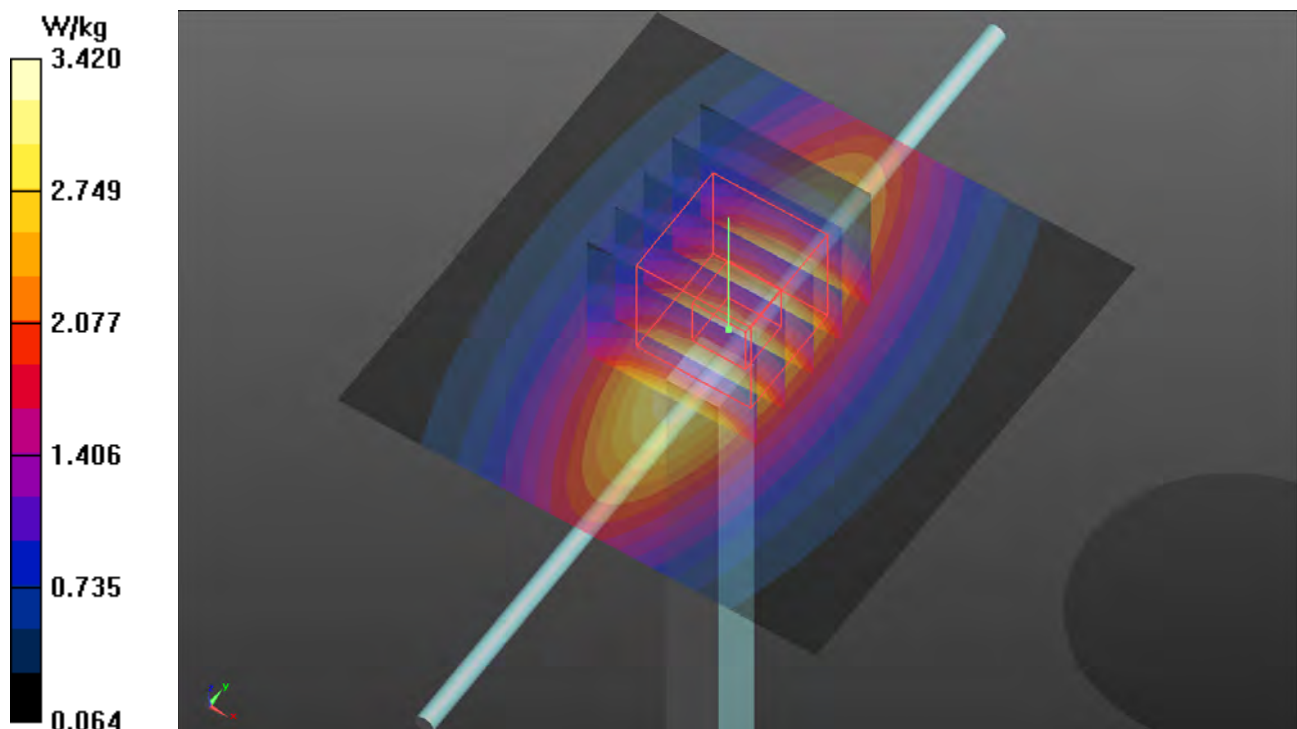

System Check_H1750_190829

DUT: Dipole 1750 MHz; Type: D1750V2; SN: 1023

Communication System: CW; Frequency: 1750 MHz; Duty Cycle: 1:1

Medium: H16T20N1_0829 Medium parameters used: $f = 1750$ MHz; $\sigma = 1.329$ S/m; $\epsilon_r = 39.118$; $\rho = 1000$ kg/m³

Ambient Temperature : 23.7 °C ; Liquid Temperature : 23.3 °C

DASY5 Configuration:

- Probe: EX3DV4 - SN3898; ConvF(8.72, 8.72, 8.72); Calibrated: 2019/06/27
- Sensor-Surface: 1.4mm (Mechanical Surface Detection)
- Electronics: DAE4 Sn916; Calibrated: 2018/12/12
- Phantom: Twin SAM Phantom_1496; Type: QD000P40
- Measurement SW: DASY52, Version 52.10 (2); SEMCAD X Version 14.6.12 (7470)

Pin=250mW/Area Scan (61x61x1): Interpolated grid: dx=1.500 mm, dy=1.500 mm
Maximum value of SAR (interpolated) = 13.8 W/kg

Pin=250mW/Zoom Scan (5x5x7)/Cube 0: Measurement grid: dx=8mm, dy=8mm, dz=5mm
Reference Value = 101.1 V/m; Power Drift = 0.08 dB
Peak SAR (extrapolated) = 16.7 W/kg
SAR(1 g) = 8.71 W/kg; SAR(10 g) = 4.61 W/kg
Maximum value of SAR (measured) = 13.6 W/kg

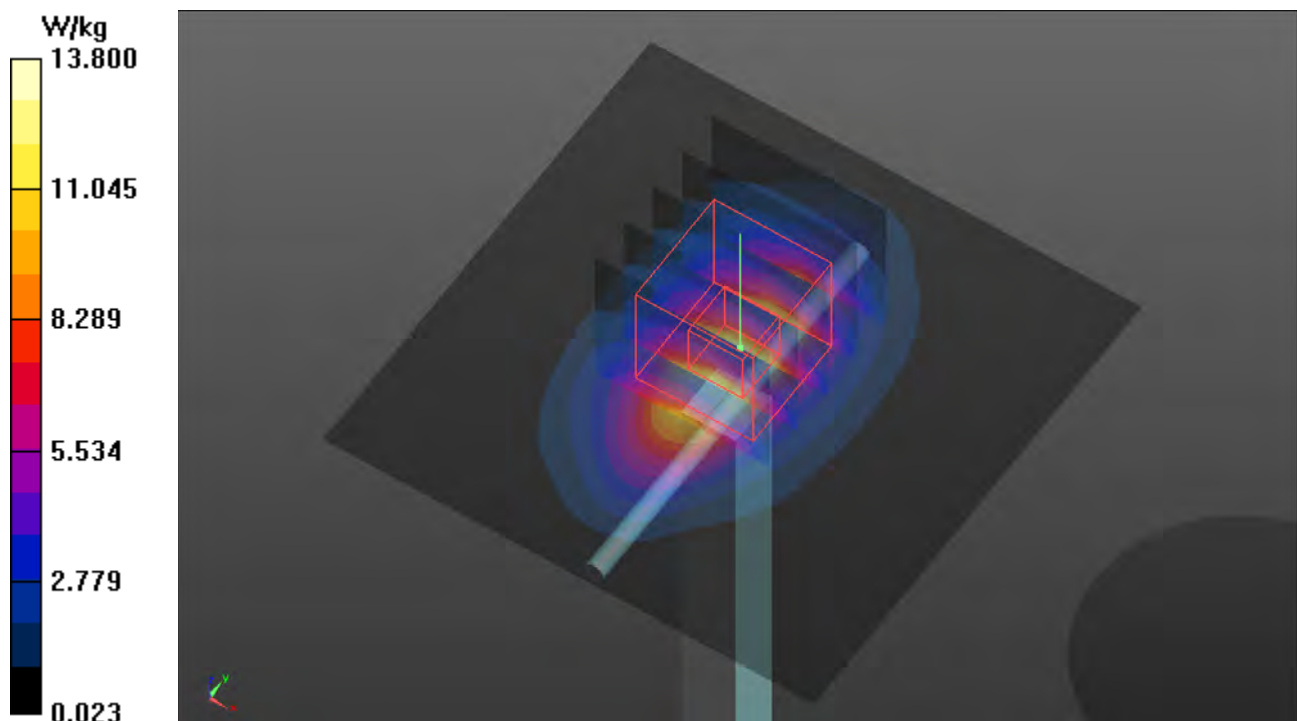

System Check_H1900_190829

DUT: Dipole 1900 MHz; Type: D1900V2; SN: 5d036

Communication System: CW; Frequency: 1900 MHz; Duty Cycle: 1:1

Medium: H16T20N1_0829 Medium parameters used: $f = 1900$ MHz; $\sigma = 1.459$ S/m; $\epsilon_r = 38.542$; $\rho = 1000$ kg/m³

Ambient Temperature : 23.7 °C ; Liquid Temperature : 23.3 °C

DASY5 Configuration:

- Probe: EX3DV4 - SN7537; ConvF(8.13, 8.13, 8.13); Calibrated: 2019/06/18
- Sensor-Surface: 1.4mm (Mechanical Surface Detection)
- Electronics: DAE4 Sn1585; Calibrated: 2019/06/07
- Phantom: SAM Phantom_1982; Type: QD000P41Ax;
- Measurement SW: DASY52, Version 52.10 (2); SEMCAD X Version 14.6.12 (7470)

Pin=250mW/Area Scan (61x61x1): Interpolated grid: dx=1.500 mm, dy=1.500 mm
Maximum value of SAR (interpolated) = 17.0 W/kg

Pin=250mW/Zoom Scan (5x5x7)/Cube 0: Measurement grid: dx=8mm, dy=8mm, dz=5mm
Reference Value = 110.7 V/m; Power Drift = -0.05 dB
Peak SAR (extrapolated) = 20.3 W/kg
SAR(1 g) = 10.7 W/kg; SAR(10 g) = 5.58 W/kg
Maximum value of SAR (measured) = 16.9 W/kg

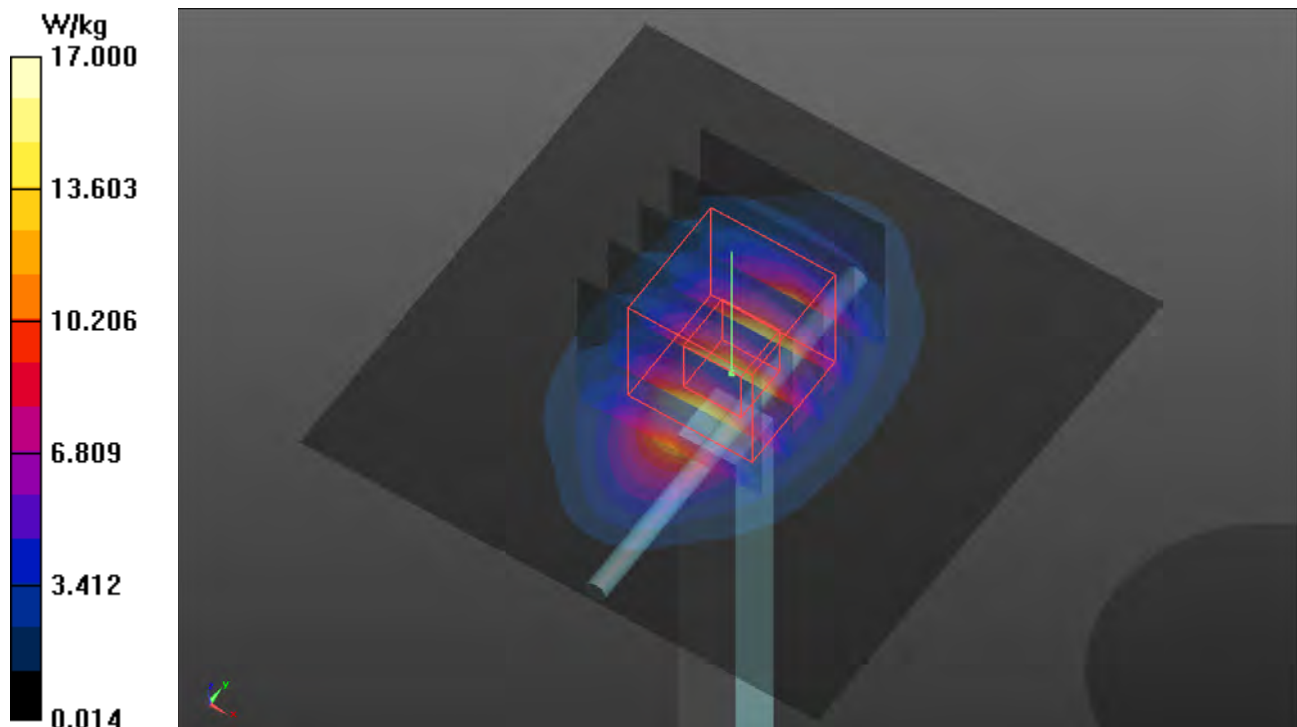

System Check_H2450_190909

DUT: Dipole 2450 MHz; Type: D2450V2; SN: 835

Communication System: CW; Frequency: 2450 MHz; Duty Cycle: 1:1

Medium: H19T27N3_0909 Medium parameters used: $f = 2450$ MHz; $\sigma = 1.827$ S/m; $\epsilon_r = 38.941$; $\rho = 1000$ kg/m³

Ambient Temperature : 23.4 °C ; Liquid Temperature : 23.1 °C

DASY5 Configuration:

- Probe: EX3DV4 - SN3650; ConvF(7.63, 7.63, 7.63); Calibrated: 2019/05/20
- Sensor-Surface: 1.4mm (Mechanical Surface Detection)
- Electronics: DAE4 Sn861; Calibrated: 2019/05/08
- Phantom: Twin SAM Phantom_1653; Type: QD000P40CD;
- Measurement SW: DASY52, Version 52.10 (2); SEMCAD X Version 14.6.12 (7470)

Pin=250mW/Area Scan (81x81x1): Interpolated grid: dx=1.200 mm, dy=1.200 mm

Maximum value of SAR (interpolated) = 21.3 W/kg

Pin=250mW/Zoom Scan (7x7x7)/Cube 0: Measurement grid: dx=5mm, dy=5mm, dz=5mm

Reference Value = 105.1 V/m; Power Drift = -0.02 dB

Peak SAR (extrapolated) = 26.4 W/kg

SAR(1 g) = 12.5 W/kg; SAR(10 g) = 5.72 W/kg

Maximum value of SAR (measured) = 21.3 W/kg

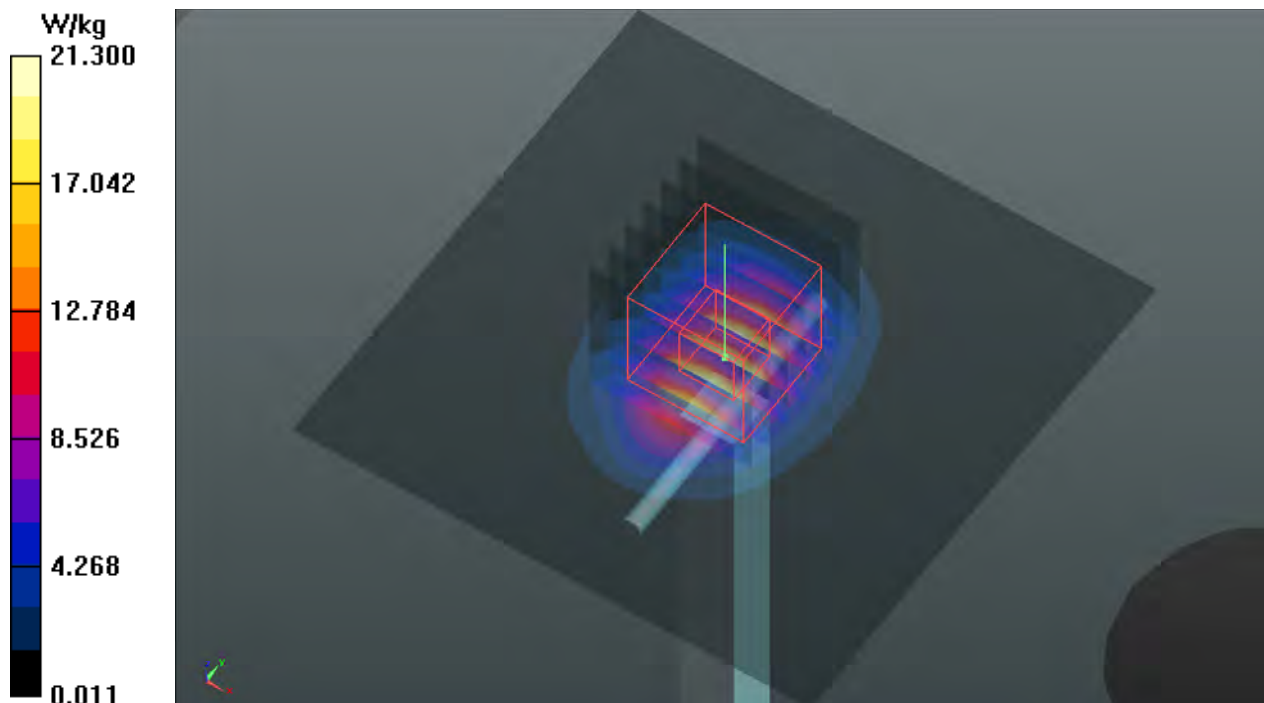

System Check_H2600_190816

DUT: Dipole 2600 MHz; Type: D2600V2; SN: 1058

Communication System: CW; Frequency: 2600 MHz; Duty Cycle: 1:1

Medium: H19T27N3_0816 Medium parameters used: $f = 2600$ MHz; $\sigma = 2.043$ S/m; $\epsilon_r = 37.822$; $\rho = 1000$ kg/m³

Ambient Temperature : 23.7 °C ; Liquid Temperature : 23.2 °C

DASY5 Configuration:

- Probe: EX3DV4 - SN3971; ConvF(7.48, 7.48, 7.48); Calibrated: 2019/03/29
- Sensor-Surface: 1.4mm (Mechanical Surface Detection)
- Electronics: DAE4 Sn1431; Calibrated: 2019/03/25
- Phantom: Twin SAM Phantom_1496; Type: QD000P40CB;
- Measurement SW: DASY52, Version 52.10 (2); SEMCAD X Version 14.6.12 (7470)

Pin=250mW/Area Scan (81x81x1): Interpolated grid: dx=1.200 mm, dy=1.200 mm
Maximum value of SAR (interpolated) = 23.6 W/kg

Pin=250mW/Zoom Scan (7x7x7)/Cube 0: Measurement grid: dx=5mm, dy=5mm, dz=5mm
Reference Value = 103.0 V/m; Power Drift = -0.01 dB
Peak SAR (extrapolated) = 29.7 W/kg
SAR(1 g) = 13.6 W/kg; SAR(10 g) = 6.09 W/kg
Maximum value of SAR (measured) = 23.5 W/kg

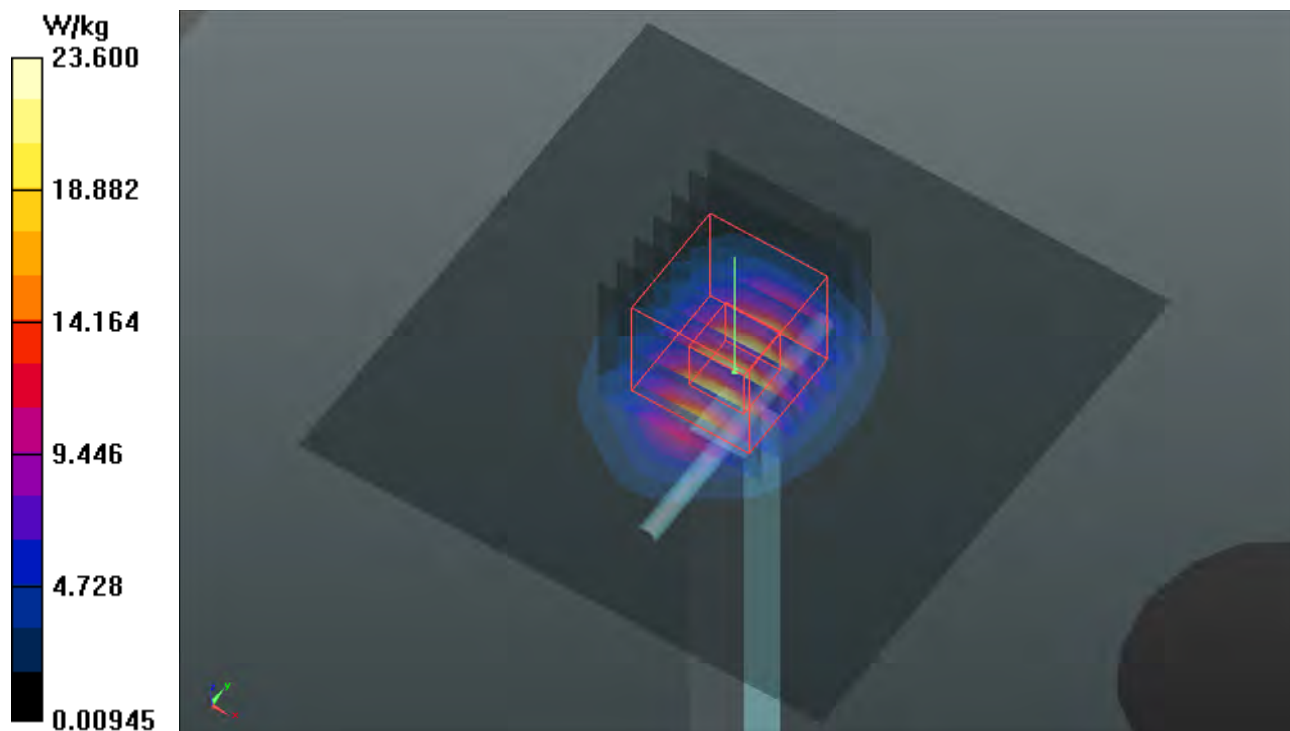

System Check_H5250_190916

DUT: Dipole 5 GHz; Type: D5GHzV2; SN: 1019

Communication System: CW; Frequency: 5250 MHz; Duty Cycle: 1:1

Medium: H34T60N1_0916 Medium parameters used: $f = 5250$ MHz; $\sigma = 4.606$ S/m; $\epsilon_r = 35.721$; $\rho = 1000$ kg/m³

Ambient Temperature : 23.6 °C ; Liquid Temperature : 23.2 °C

DASY5 Configuration:

- Probe: EX3DV4 - SN3650; ConvF(5.4, 5.4, 5.4); Calibrated: 2019/05/20
- Sensor-Surface: 1.4mm (Mechanical Surface Detection)
- Electronics: DAE4 Sn861; Calibrated: 2019/05/08
- Phantom: Twin SAM Phantom_1653; Type: QD000P40CD;
- Measurement SW: DASY52, Version 52.10 (2); SEMCAD X Version 14.6.12 (7470)

Pin=100mW/Area Scan (91x91x1): Interpolated grid: dx=1.000 mm, dy=1.000 mm
Maximum value of SAR (interpolated) = 18.0 W/kg

Pin=100mW/Zoom Scan (7x7x12)/Cube 0: Measurement grid: dx=4mm, dy=4mm, dz=2mm
Reference Value = 71.22 V/m; Power Drift = 0.04 dB
Peak SAR (extrapolated) = 33.9 W/kg
SAR(1 g) = 7.83 W/kg; SAR(10 g) = 2.25 W/kg
Maximum value of SAR (measured) = 20.0 W/kg

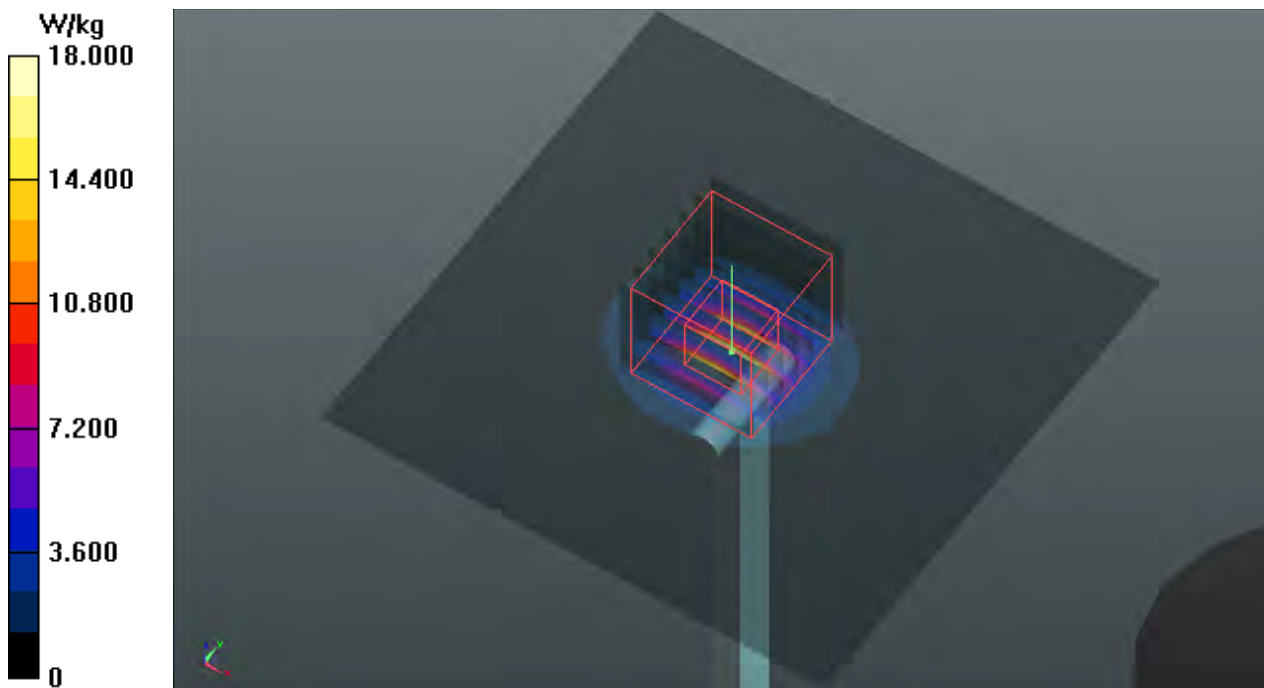

System Check_H5600_190906

DUT: Dipole 5 GHz; Type: D5GHzV2; SN: 1019

Communication System: CW; Frequency: 5600 MHz; Duty Cycle: 1:1

Medium: H34T60N1_0906 Medium parameters used: $f = 5600$ MHz; $\sigma = 5.178$ S/m; $\epsilon_r = 34.66$; $\rho = 1000$ kg/m³

Ambient Temperature : 23.6 °C ; Liquid Temperature : 23.2 °C

DASY5 Configuration:

- Probe: EX3DV4 - SN3650; ConvF(4.9, 4.9, 4.9); Calibrated: 2019/05/20
- Sensor-Surface: 1.4mm (Mechanical Surface Detection)
- Electronics: DAE4 Sn861; Calibrated: 2019/05/08
- Phantom: Twin SAM Phantom_1653; Type: QD000P40CD;
- Measurement SW: DASY52, Version 52.10 (2); SEMCAD X Version 14.6.12 (7470)

Pin=100mW/Area Scan (91x91x1): Interpolated grid: dx=1.000 mm, dy=1.000 mm

Maximum value of SAR (interpolated) = 20.6 W/kg

Pin=100mW/Zoom Scan (7x7x12)/Cube 0: Measurement grid: dx=4mm, dy=4mm, dz=2mm

Reference Value = 72.50 V/m; Power Drift = -0.18 dB

Peak SAR (extrapolated) = 35.7 W/kg

SAR(1 g) = 8.44 W/kg; SAR(10 g) = 2.44 W/kg

Maximum value of SAR (measured) = 21.6 W/kg

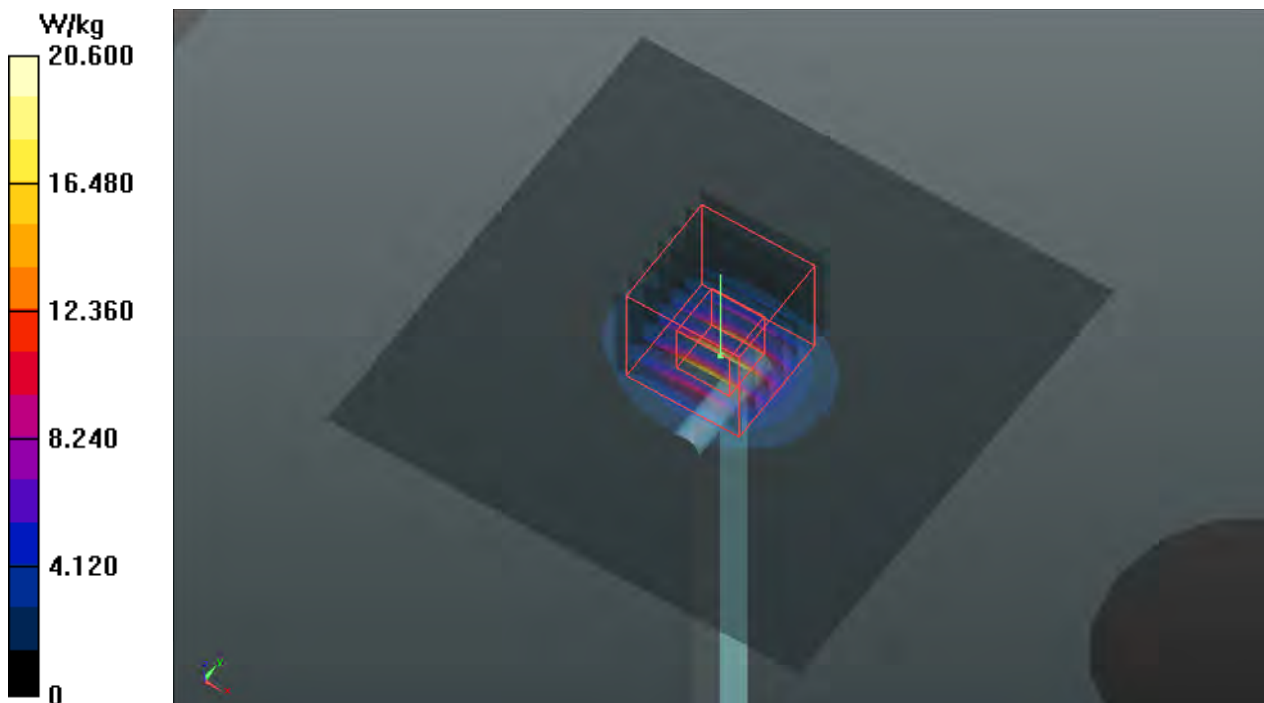

System Check_H5750_190908

DUT: Dipole 5 GHz; Type: D5GHzV2; SN: 1019

Communication System: CW; Frequency: 5750 MHz; Duty Cycle: 1:1

Medium: H34T60N1_0908 Medium parameters used: $f = 5750$ MHz; $\sigma = 5.282$ S/m; $\epsilon_r = 33.95$; $\rho = 1000$ kg/m³

Ambient Temperature : 23.4 °C ; Liquid Temperature : 23.1 °C

DASY5 Configuration:

- Probe: EX3DV4 - SN3650; ConvF(5.17, 5.17, 5.17); Calibrated: 2019/05/20
- Sensor-Surface: 1.4mm (Mechanical Surface Detection)
- Electronics: DAE4 Sn861; Calibrated: 2019/05/08
- Phantom: Twin SAM Phantom_1653; Type: QD000P40CD;
- Measurement SW: DASY52, Version 52.10 (2); SEMCAD X Version 14.6.12 (7470)

Pin=100mW/Area Scan (91x91x1): Interpolated grid: dx=1.000 mm, dy=1.000 mm
Maximum value of SAR (interpolated) = 19.1 W/kg

Pin=100mW/Zoom Scan (7x7x12)/Cube 0: Measurement grid: dx=4mm, dy=4mm, dz=2mm
Reference Value = 56.47 V/m; Power Drift = 0.19 dB
Peak SAR (extrapolated) = 35.8 W/kg
SAR(1 g) = 7.7 W/kg; SAR(10 g) = 2.21 W/kg
Maximum value of SAR (measured) = 20.2 W/kg

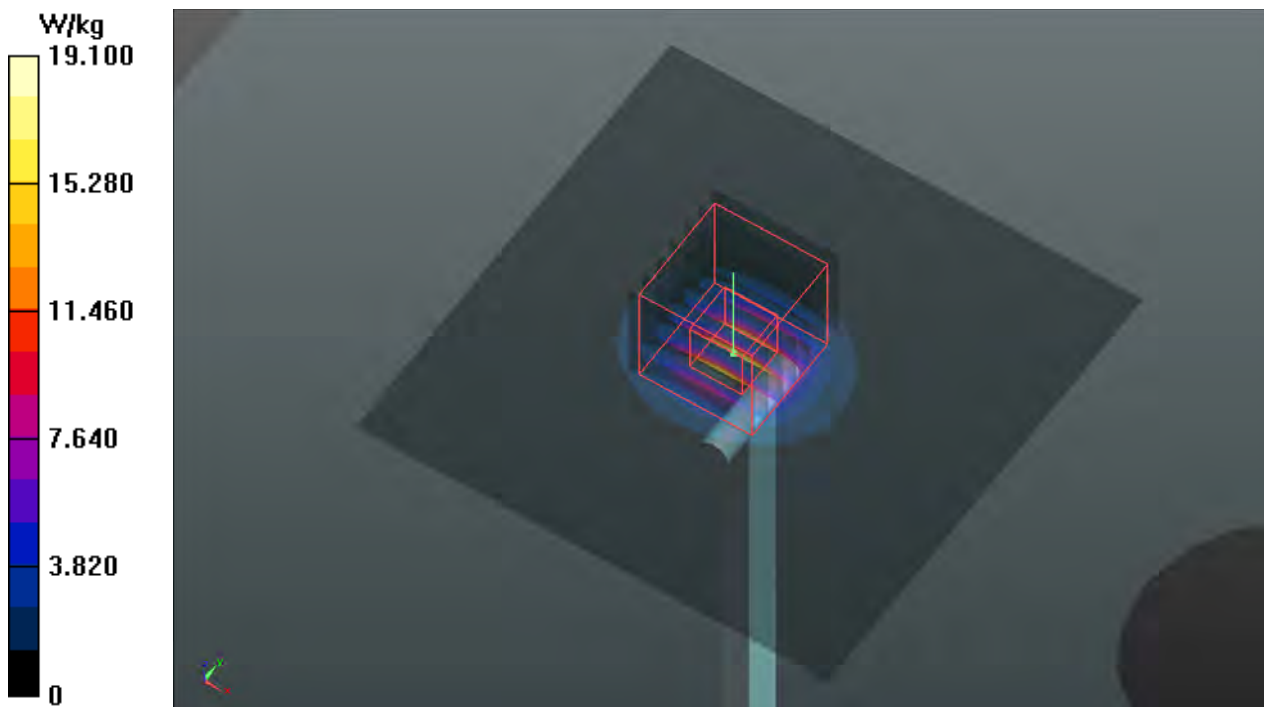

System Check_H1750_191011

DUT: Dipole 1750 MHz; Type: D1750V2; SN: 1023

Communication System: CW; Frequency: 1750 MHz; Duty Cycle: 1:1

Medium: H16T20N1_1011 Medium parameters used: $f = 1750$ MHz; $\sigma = 1.328$ S/m; $\epsilon_r = 39.811$; $\rho = 1000$ kg/m³

Ambient Temperature : 23.5 °C ; Liquid Temperature : 23.2 °C

DASY5 Configuration:

- Probe: EX3DV4 - SN7537; ConvF(8.44, 8.44, 8.44); Calibrated: 2019/06/18
- Sensor-Surface: 1.4mm (Mechanical Surface Detection)
- Electronics: DAE4 Sn1585; Calibrated: 2019/06/07
- Phantom: SAM Phantom_1982; Type: QD 000 P41 Ax; Serial: 1982
- Measurement SW: DASY52, Version 52.10 (2); SEMCAD X Version 14.6.12 (7470)

Pin=250mW/Area Scan (61x61x1): Interpolated grid: dx=1.500 mm, dy=1.500 mm
Maximum value of SAR (interpolated) = 14.0 W/kg

Pin=250mW/Zoom Scan (5x5x7)/Cube 0: Measurement grid: dx=8mm, dy=8mm, dz=5mm
Reference Value = 101.7 V/m; Power Drift = 0.08 dB
Peak SAR (extrapolated) = 17.0 W/kg
SAR(1 g) = 8.82 W/kg; SAR(10 g) = 4.66 W/kg
Maximum value of SAR (measured) = 13.9 W/kg

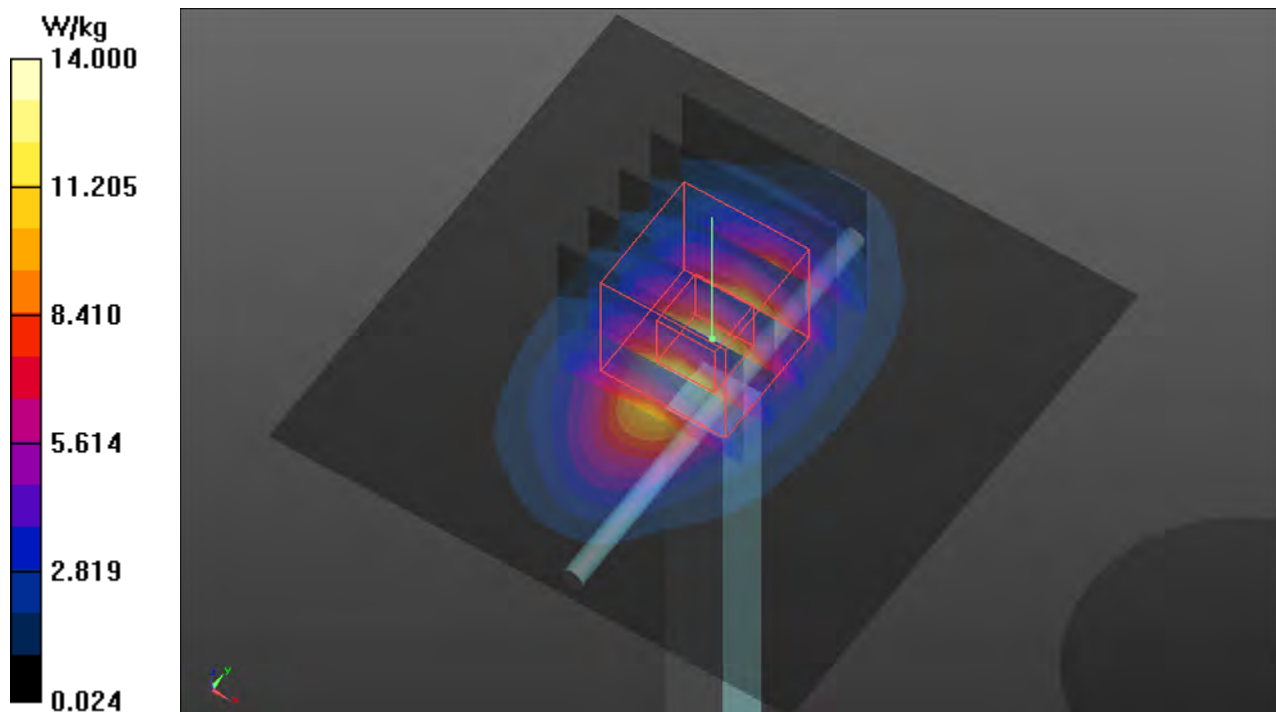

System Check_H1900_190829

DUT: Dipole 1900 MHz; Type: D1900V2; SN: 5d036

Communication System: CW; Frequency: 1900 MHz; Duty Cycle: 1:1

Medium: H16T20N1_0829 Medium parameters used: $f = 1900$ MHz; $\sigma = 1.459$ S/m; $\epsilon_r = 38.542$; $\rho = 1000$ kg/m³

Ambient Temperature : 23.7 °C ; Liquid Temperature : 23.3 °C

DASY5 Configuration:

- Probe: EX3DV4 - SN7537; ConvF(8.13, 8.13, 8.13); Calibrated: 2019/06/18
- Sensor-Surface: 1.4mm (Mechanical Surface Detection)
- Electronics: DAE4 Sn1585; Calibrated: 2019/06/07
- Phantom: SAM Phantom_1982; Type: QD000P41Ax;
- Measurement SW: DASY52, Version 52.10 (2); SEMCAD X Version 14.6.12 (7470)

Pin=250mW/Area Scan (61x61x1): Interpolated grid: dx=1.500 mm, dy=1.500 mm
Maximum value of SAR (interpolated) = 17.0 W/kg

Pin=250mW/Zoom Scan (5x5x7)/Cube 0: Measurement grid: dx=8mm, dy=8mm, dz=5mm
Reference Value = 110.7 V/m; Power Drift = -0.05 dB
Peak SAR (extrapolated) = 20.3 W/kg
SAR(1 g) = 10.7 W/kg; SAR(10 g) = 5.58 W/kg
Maximum value of SAR (measured) = 16.9 W/kg

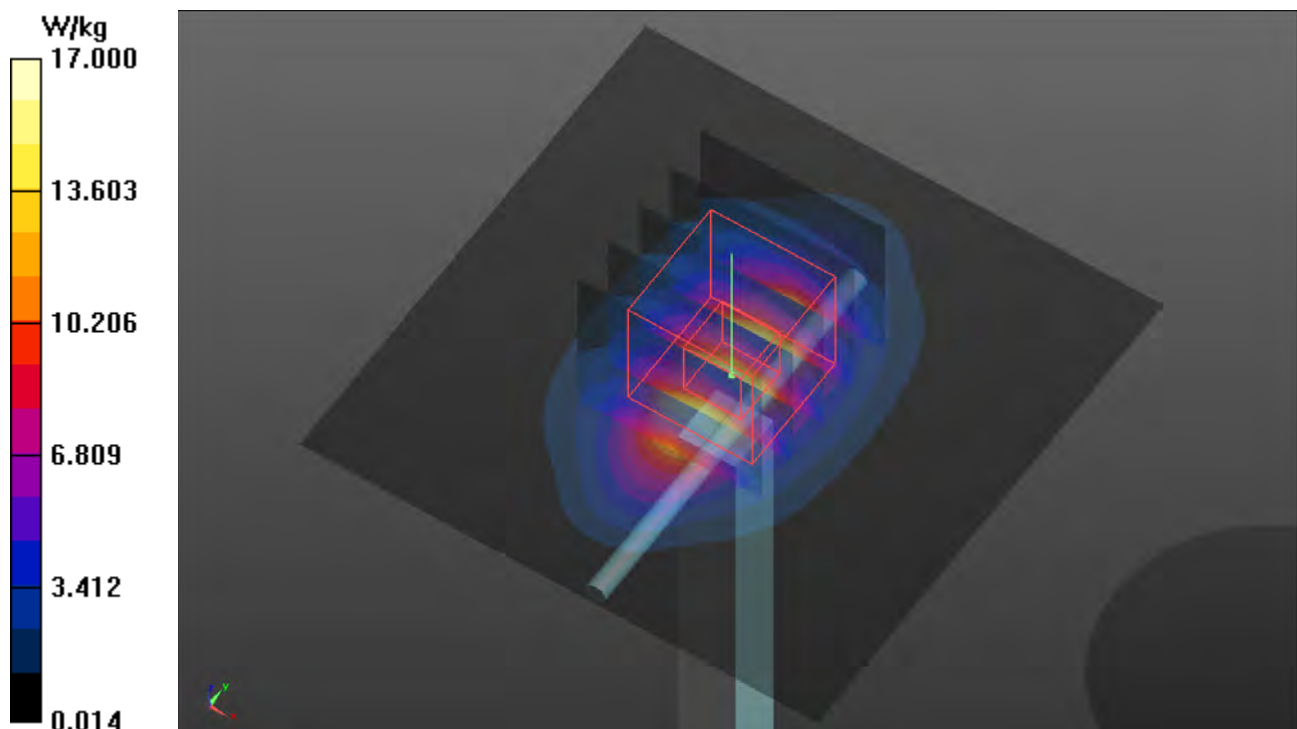

System Check_H2450_190822

DUT: Dipole 2450 MHz; Type: D2450V2; SN: : 57

Communication System: CW; Frequency: 2450 MHz; Duty Cycle: 1:1

Medium: H19T27N1_0824 Medium parameters used: $f = 2450$ MHz; $\sigma = 1.881$ S/m; $\epsilon_r = 38.819$; $\rho = 1000$ kg/m³

Ambient Temperature : 23.8 °C ; Liquid Temperature : 23.5 °C

DASY5 Configuration:

- Probe: EX3DV4 - SN7537; ConvF(7.39, 7.39, 7.39); Calibrated: 2019/06/18
- Sensor-Surface: 1.4mm (Mechanical Surface Detection)
- Electronics: DAE4 Sn1585; Calibrated: 2019/06/07
- Phantom: SAM Phantom_1982; Type: S F 222R63Cz=
- Measurement SW: DASY52, Version 52.10 (2); SEMCAD X Version 14.6.12 (7470)

Pin=250mW/Area Scan (81x81x1): Interpolated grid: dx=1.200 mm, dy=1.200 mm
Maximum value of SAR (interpolated) = 22.0 W/kg

Pin=250mW/Zoom Scan (7x7x7)/Cube 0: Measurement grid: dx=5mm, dy=5mm, dz=5mm
Reference Value = 109.6 V/m; Power Drift = -0.09 dB
Peak SAR (extrapolated) = 27.2 W/kg
SAR(1 g) = 13.2 W/kg; SAR(10 g) = 6.13 W/kg
Maximum value of SAR (measured) = 22.0 W/kg

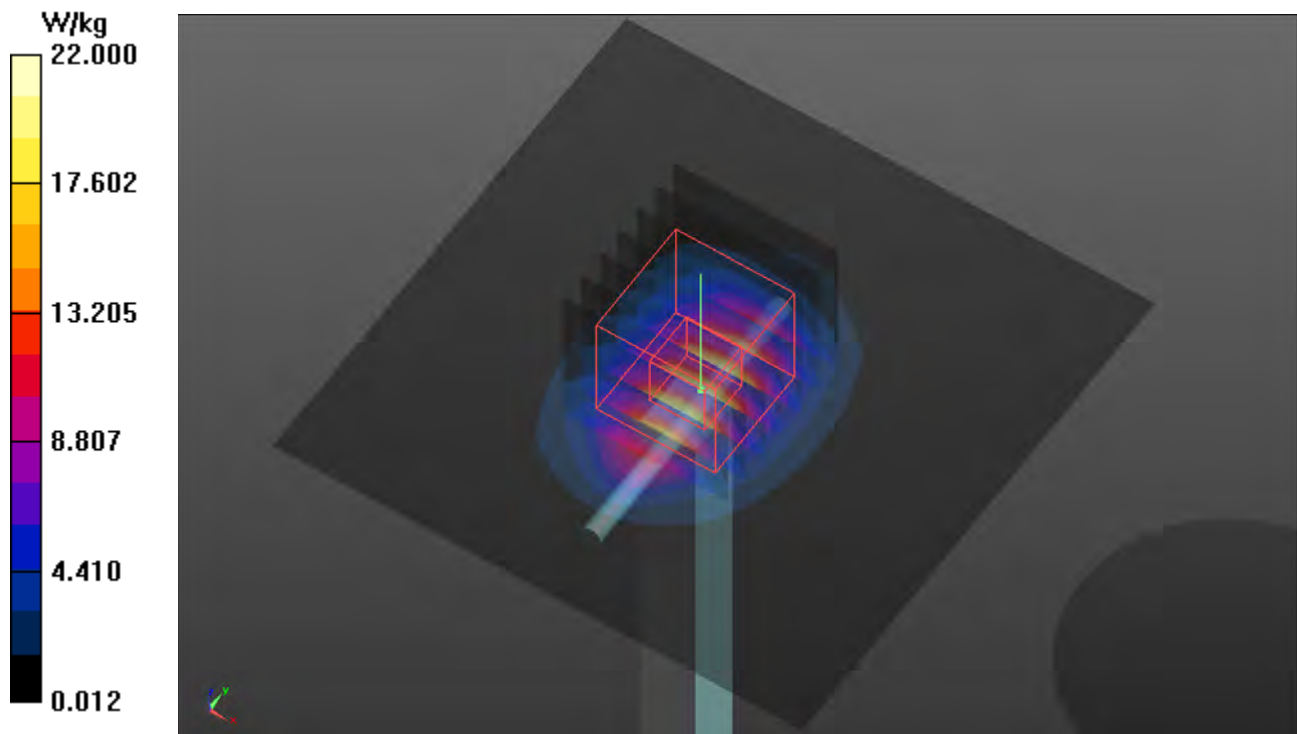

System Check_H5250_190908

DUT: Dipole 5 GHz; Type: D5GHzV2; SN: 1019

Communication System: CW; Frequency: 5250 MHz; Duty Cycle: 1:1

Medium: H34T60N1_0908 Medium parameters used: $f = 5250$ MHz; $\sigma = 4.741$ S/m; $\epsilon_r = 34.837$; $\rho = 1000$ kg/m³

Ambient Temperature : 23.4 °C ; Liquid Temperature : 23.1 °C

DASY5 Configuration:

- Probe: EX3DV4 - SN3650; ConvF(5.4, 5.4, 5.4); Calibrated: 2019/05/20
- Sensor-Surface: 1.4mm (Mechanical Surface Detection)
- Electronics: DAE4 Sn861; Calibrated: 2019/05/08
- Phantom: Twin SAM Phantom_1653; Type: QD000P40CD;
- Measurement SW: DASY52, Version 52.10 (2); SEMCAD X Version 14.6.12 (7470)

Pin=100mW/Area Scan (91x91x1): Interpolated grid: dx=1.000 mm, dy=1.000 mm
Maximum value of SAR (interpolated) = 18.9 W/kg

Pin=100mW/Zoom Scan (7x7x12)/Cube 0: Measurement grid: dx=4mm, dy=4mm, dz=2mm
Reference Value = 71.65 V/m; Power Drift = 0.05 dB
Peak SAR (extrapolated) = 35.4 W/kg
SAR(1 g) = 8.2 W/kg; SAR(10 g) = 2.35 W/kg
Maximum value of SAR (measured) = 20.8 W/kg

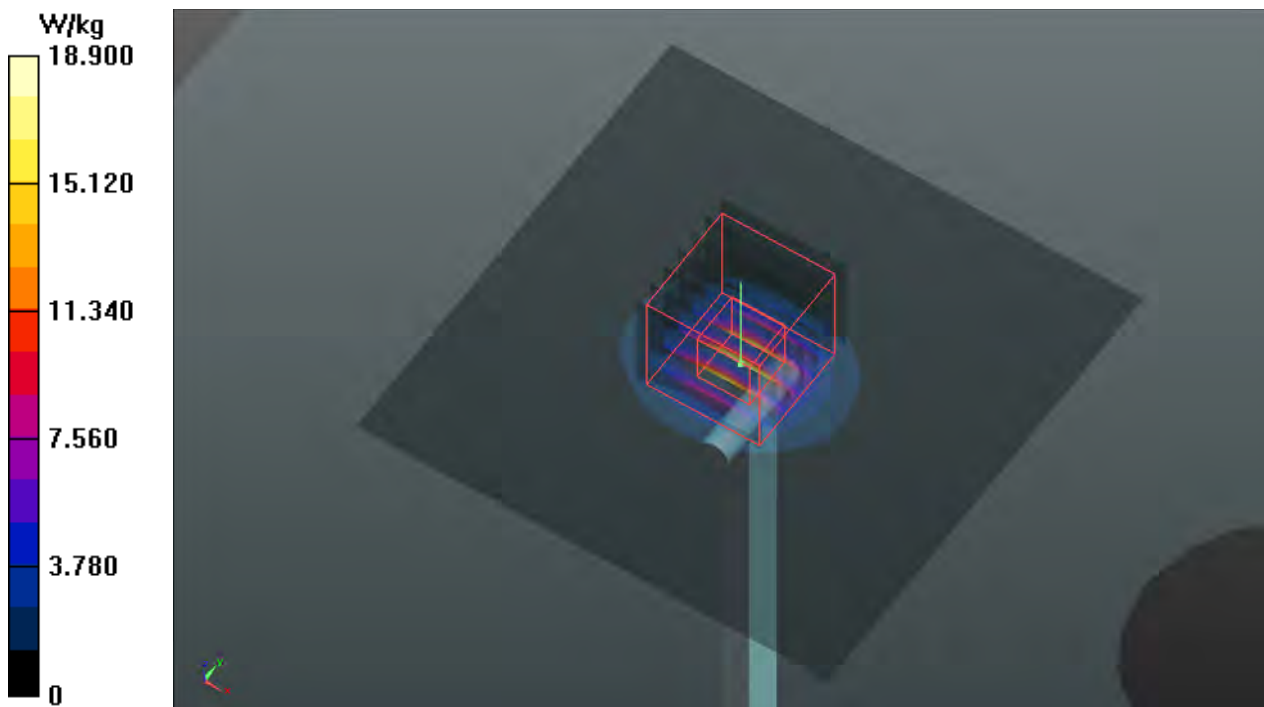

System Check_H5600_190908

DUT: Dipole 5 GHz; Type: D5GHzV2; SN: 1019

Communication System: CW; Frequency: 5600 MHz; Duty Cycle: 1:1

Medium: H34T60N1_0908 Medium parameters used: $f = 5600$ MHz; $\sigma = 5.12$ S/m; $\epsilon_r = 34.235$; $\rho = 1000$ kg/m³

Ambient Temperature : 23.4 °C ; Liquid Temperature : 23.1 °C

DASY5 Configuration:

- Probe: EX3DV4 - SN3650; ConvF(4.9, 4.9, 4.9); Calibrated: 2019/05/20
- Sensor-Surface: 1.4mm (Mechanical Surface Detection)
- Electronics: DAE4 Sn861; Calibrated: 2019/05/08
- Phantom: Twin SAM Phantom_1653; Type: QD000P40CD;
- Measurement SW: DASY52, Version 52.10 (2); SEMCAD X Version 14.6.12 (7470)

Pin=100mW/Area Scan (91x91x1): Interpolated grid: dx=1.000 mm, dy=1.000 mm
Maximum value of SAR (interpolated) = 20.8 W/kg

Pin=100mW/Zoom Scan (7x7x12)/Cube 0: Measurement grid: dx=4mm, dy=4mm, dz=2mm
Reference Value = 73.33 V/m; Power Drift = -0.10 dB
Peak SAR (extrapolated) = 39.7 W/kg
SAR(1 g) = 8.52 W/kg; SAR(10 g) = 2.42 W/kg
Maximum value of SAR (measured) = 22.3 W/kg

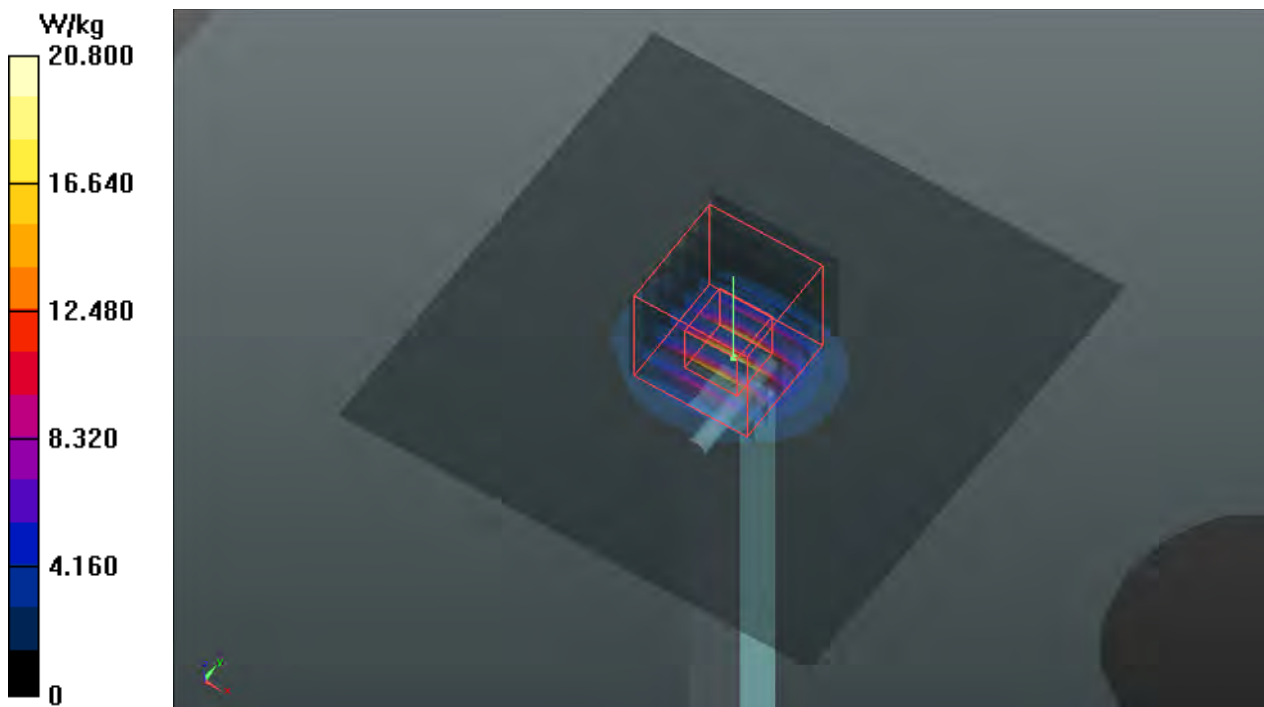

System Check_H5750_190908

DUT: Dipole 5 GHz; Type: D5GHzV2; SN: 1019

Communication System: CW; Frequency: 5750 MHz; Duty Cycle: 1:1

Medium: H34T60N1_0908 Medium parameters used: $f = 5750$ MHz; $\sigma = 5.282$ S/m; $\epsilon_r = 33.95$; $\rho = 1000$ kg/m³

Ambient Temperature : 23.4 °C ; Liquid Temperature : 23.1 °C

DASY5 Configuration:

- Probe: EX3DV4 - SN3650; ConvF(5.17, 5.17, 5.17); Calibrated: 2019/05/20
- Sensor-Surface: 1.4mm (Mechanical Surface Detection)
- Electronics: DAE4 Sn861; Calibrated: 2019/05/08
- Phantom: Twin SAM Phantom_1653; Type: QD000P40CD;
- Measurement SW: DASY52, Version 52.10 (2); SEMCAD X Version 14.6.12 (7470)

Pin=100mW/Area Scan (91x91x1): Interpolated grid: dx=1.000 mm, dy=1.000 mm

Maximum value of SAR (interpolated) = 19.1 W/kg

Pin=100mW/Zoom Scan (7x7x12)/Cube 0: Measurement grid: dx=4mm, dy=4mm, dz=2mm

Reference Value = 56.47 V/m; Power Drift = 0.19 dB

Peak SAR (extrapolated) = 35.8 W/kg

SAR(1 g) = 7.7 W/kg; SAR(10 g) = 2.21 W/kg

Maximum value of SAR (measured) = 20.2 W/kg

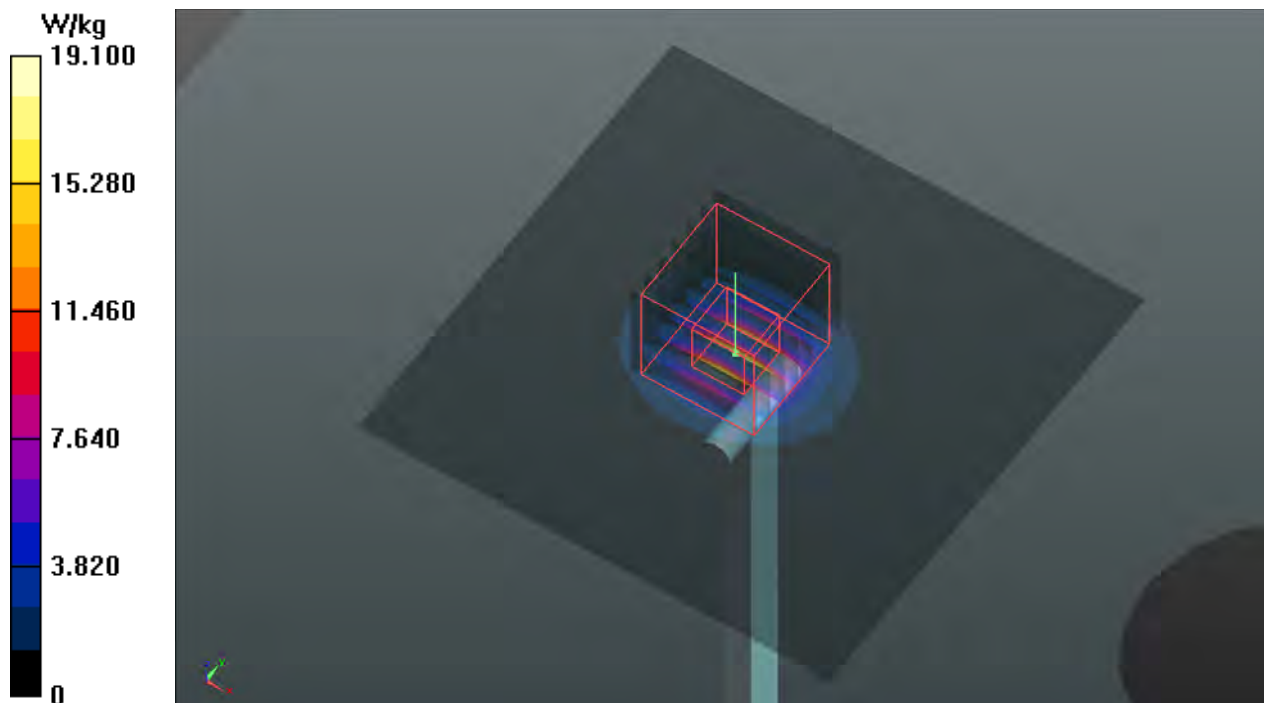



Appendix B. SAR Plots of SAR Measurement

The SAR plots for highest measured SAR in each exposure configuration, wireless mode and frequency band combination, and measured SAR > 1.5 W/kg are shown as follows.

P01 GSM850_GPRS12_Right Cheek_Ch251_Sample 1_Ant3

DUT: 190723C05

Communication System: GPRS12; Frequency: 848.8 MHz; Duty Cycle: 1:2

Medium: H07T10N3_1007 Medium parameters used: $f = 849$ MHz; $\sigma = 0.941$ S/m; $\epsilon_r = 41.834$; $\rho = 1000$ kg/m³

Ambient Temperature : 23.5 °C ; Liquid Temperature : 23.2 °C

DASY5 Configuration:

- Probe: EX3DV4 - SN7537; ConvF(10.48, 10.48, 10.48); Calibrated: 2019/06/18
- Sensor-Surface: 1.4mm (Mechanical Surface Detection)
- Electronics: DAE4 Sn1585; Calibrated: 2019/06/07
- Phantom: SAM Phantom_1982; Type: QD 000 P41 Ax; Serial: 1982
- Measurement SW: DASY52, Version 52.10 (2); SEMCAD X Version 14.6.12 (7470)

- **Area Scan (71x121x1)**: Interpolated grid: dx=1.500 mm, dy=1.500 mm
Maximum value of SAR (interpolated) = 1.82 W/kg

- **Zoom Scan (5x5x7)/Cube 0**: Measurement grid: dx=8mm, dy=8mm, dz=5mm
Reference Value = 1.399 V/m; Power Drift = 0.11 dB
Peak SAR (extrapolated) = 1.82 W/kg
SAR(1 g) = 1.07 W/kg; SAR(10 g) = 0.604 W/kg
Maximum value of SAR (measured) = 1.55 W/kg

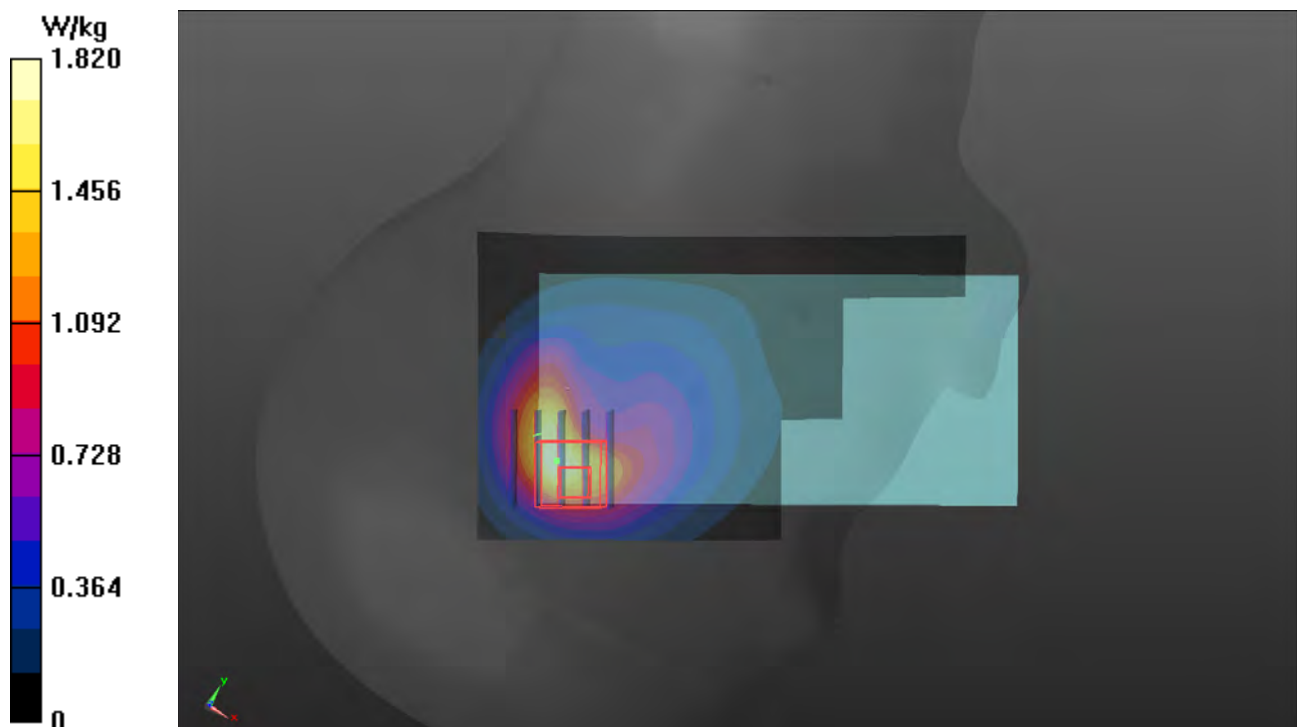

P02 GSM1900_EDGE12_Right Cheek_Ch810_Sample1_Ant1

DUT: 190723C05

Communication System: EGPRS 12; Frequency: 1909.8 MHz; Duty Cycle: 1:2

Medium: H16T20N1_0829 Medium parameters used: $f = 1909.8$ MHz; $\sigma = 1.467$ S/m; $\epsilon_r = 38.509$; $\rho = 1000$ kg/m³

Ambient Temperature : 23.7 °C ; Liquid Temperature : 23.3 °C

DASY5 Configuration:

- Probe: EX3DV4 - SN7537; ConvF(8.13, 8.13, 8.13); Calibrated: 2019/06/18
- Sensor-Surface: 1.4mm (Mechanical Surface Detection)
- Electronics: DAE4 Sn1585; Calibrated: 2019/06/07
- Phantom: SAM Phantom_1982; Type: QD000P41Ax;
- Measurement SW: DASY52, Version 52.10 (2); SEMCAD X Version 14.6.12 (7470)

- **Area Scan (81x121x1)**: Interpolated grid: dx=1.500 mm, dy=1.500 mm
Maximum value of SAR (interpolated) = 0.0319 W/kg

- **Zoom Scan (5x5x7)/Cube 0**: Measurement grid: dx=8mm, dy=8mm, dz=5mm
Reference Value = 1.406 V/m; Power Drift = 0.03 dB
Peak SAR (extrapolated) = 0.0280 W/kg
SAR(1 g) = 0.018 W/kg; SAR(10 g) = 0.012 W/kg
Maximum value of SAR (measured) = 0.0233 W/kg

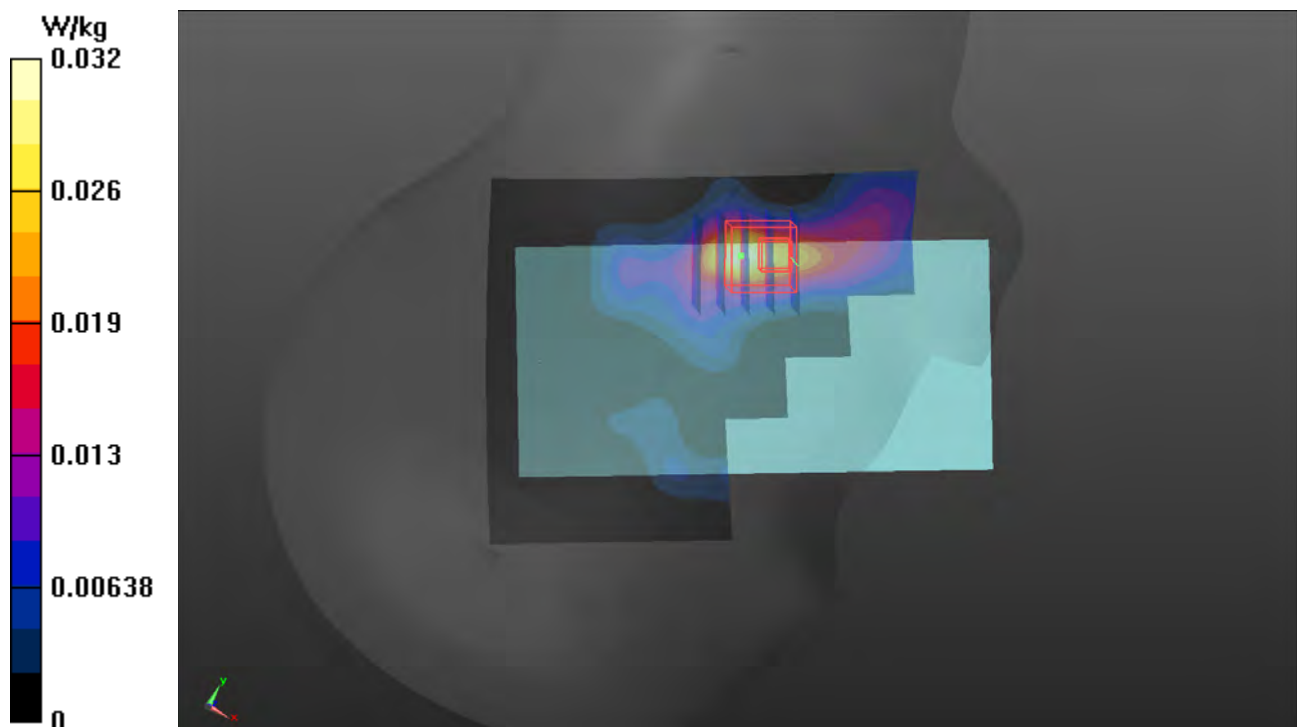

P03 WCDMA II_RMC12.2K_Right Cheek_Ch9538_Sample1_Ant1

DUT: 190723C05

Communication System: WCDMA; Frequency: 1907.6 MHz; Duty Cycle: 1:1

Medium: H16T20N1_0829 Medium parameters used: $f = 1907.6$ MHz; $\sigma = 1.465$ S/m; $\epsilon_r = 38.513$; $\rho = 1000$ kg/m³

Ambient Temperature : 23.5 °C ; Liquid Temperature : 23.1 °C

DASY5 Configuration:

- Probe: EX3DV4 - SN3898; ConvF(8.35, 8.35, 8.35); Calibrated: 2019/06/27
- Sensor-Surface: 1.4mm (Mechanical Surface Detection)
- Electronics: DAE4 Sn916; Calibrated: 2018/12/12
- Phantom: Twin SAM Phantom_1496; Type: QD000P40CB;
- Measurement SW: DASY52, Version 52.10 (2); SEMCAD X Version 14.6.12 (7470)

- **Area Scan (81x141x1):** Interpolated grid: dx=1.500 mm, dy=1.500 mm

Maximum value of SAR (interpolated) = 0.109 W/kg

- **Zoom Scan (5x5x7)/Cube 0:** Measurement grid: dx=8mm, dy=8mm, dz=5mm

Reference Value = 4.929 V/m; Power Drift = -0.17 dB

Peak SAR (extrapolated) = 0.0740 W/kg

SAR(1 g) = 0.047 W/kg; SAR(10 g) = 0.029 W/kg

Maximum value of SAR (measured) = 0.0643 W/kg

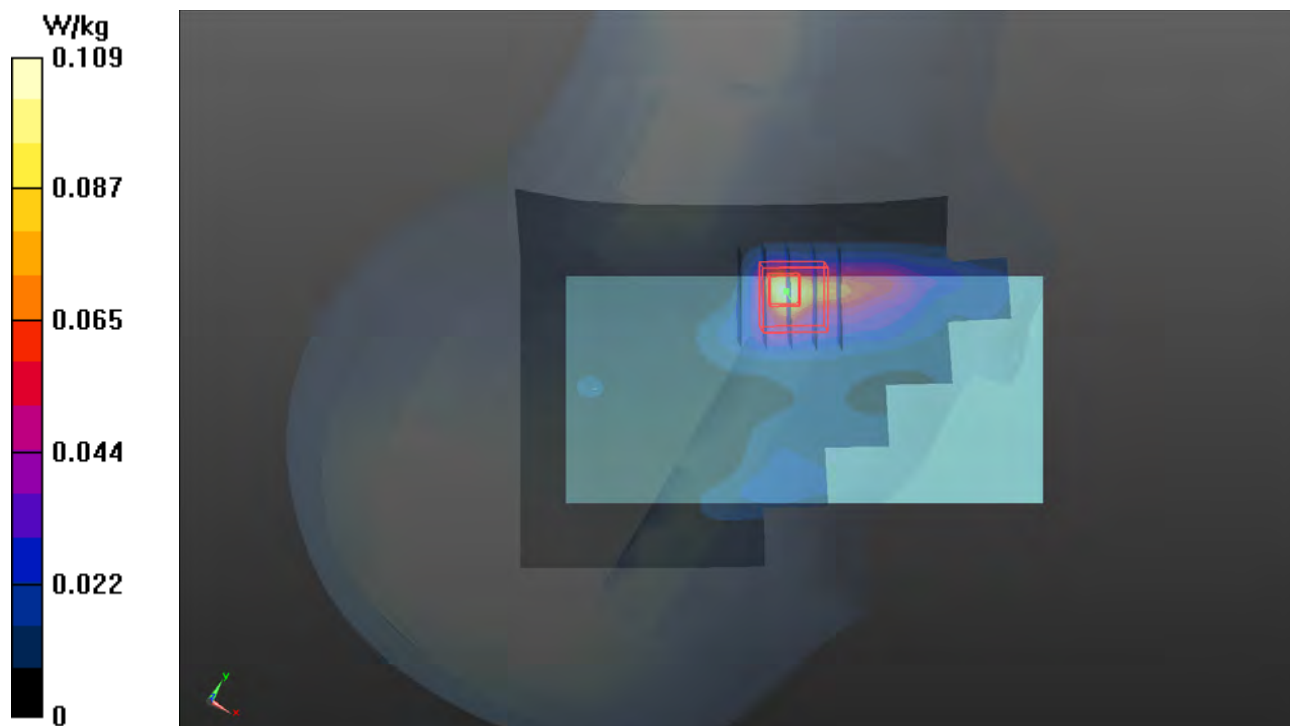

P04 WCDMA V_RMC12.2K_Right Cheek_Ch4182_Sample1_Ant3

DUT: 190723C05

Communication System: WCDMA; Frequency: 836.4 MHz; Duty Cycle: 1:1
Medium: H07T10N1_0907 Medium parameters used: $f = 836.4$ MHz; $\sigma = 0.906$ S/m; $\epsilon_r = 41.797$; $\rho = 1000$ kg/m³
Ambient Temperature : 23.4 °C ; Liquid Temperature : 23.1 °C

DASY5 Configuration:

- Probe: EX3DV4 - SN3650; ConvF(9.82, 9.82, 9.82); Calibrated: 2019/05/20
- Sensor-Surface: 1.4mm (Mechanical Surface Detection)
- Electronics: DAE4 Sn861; Calibrated: 2019/05/08
- Phantom: Twin SAM Phantom_1653; Type: QD000P40CD;
- Measurement SW: DASY52, Version 52.10 (2); SEMCAD X Version 14.6.12 (7470)

- **Area Scan (71x121x1):** Interpolated grid: dx=1.500 mm, dy=1.500 mm
Maximum value of SAR (interpolated) = 1.55 W/kg

- **Zoom Scan (5x5x7)/Cube 0:** Measurement grid: dx=8mm, dy=8mm, dz=5mm
Reference Value = 38.83 V/m; Power Drift = 0.01 dB
Peak SAR (extrapolated) = 2.00 W/kg
SAR(1 g) = 1.05 W/kg; SAR(10 g) = 0.603 W/kg
Maximum value of SAR (measured) = 1.64 W/kg

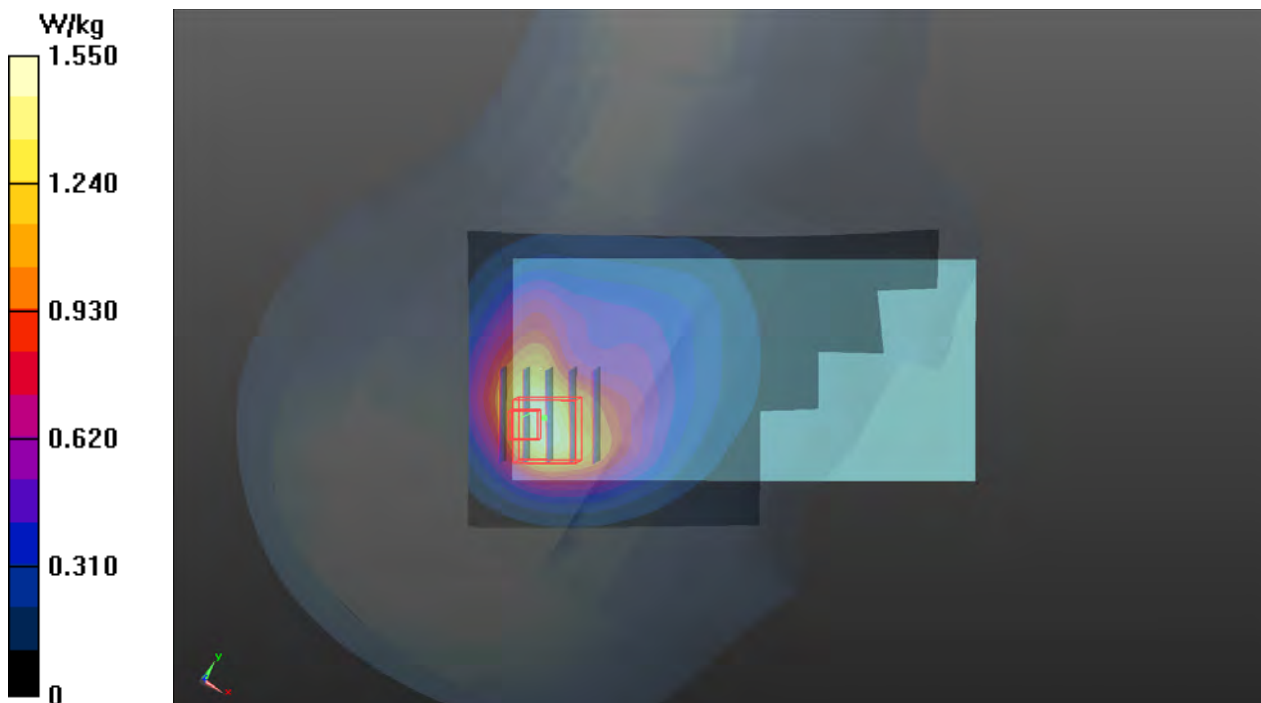

P05 LTE 2_QPSK20M_Right Cheek_Ch18900_1RB_OS0_Sample1_Ant1

DUT: 190723C05

Communication System: LTE; Frequency: 1880 MHz; Duty Cycle: 1:1

Medium: H16T20N1_0829 Medium parameters used: $f = 1880$ MHz; $\sigma = 1.442$ S/m; $\epsilon_r = 38.617$; $\rho = 1000$ kg/m³

Ambient Temperature : 23.5 °C ; Liquid Temperature : 23.1 °C

DASY5 Configuration:

- Probe: EX3DV4 - SN3898; ConvF(8.35, 8.35, 8.35); Calibrated: 2019/06/27
- Sensor-Surface: 1.4mm (Mechanical Surface Detection)
- Electronics: DAE4 Sn916; Calibrated: 2018/12/12
- Phantom: Twin SAM Phantom_1496; Type: QD000P40CB;
- Measurement SW: DASY52, Version 52.10 (2); SEMCAD X Version 14.6.12 (7470)

- **Area Scan (81x141x1):** Interpolated grid: dx=1.500 mm, dy=1.500 mm

Maximum value of SAR (interpolated) = 0.0914 W/kg

- **Zoom Scan (5x5x7)/Cube 1:** Measurement grid: dx=8mm, dy=8mm, dz=5mm

Reference Value = 7.018 V/m; Power Drift = 0.06 dB

Peak SAR (extrapolated) = 0.0860 W/kg

SAR(1 g) = 0.059 W/kg; SAR(10 g) = 0.037 W/kg

Maximum value of SAR (measured) = 0.0751 W/kg

- **Zoom Scan (5x5x7)/Cube 0:** Measurement grid: dx=8mm, dy=8mm, dz=5mm

Reference Value = 7.018 V/m; Power Drift = 0.06 dB

Peak SAR (extrapolated) = 0.0860 W/kg

SAR(1 g) = 0.055 W/kg; SAR(10 g) = 0.036 W/kg

Maximum value of SAR (measured) = 0.0752 W/kg

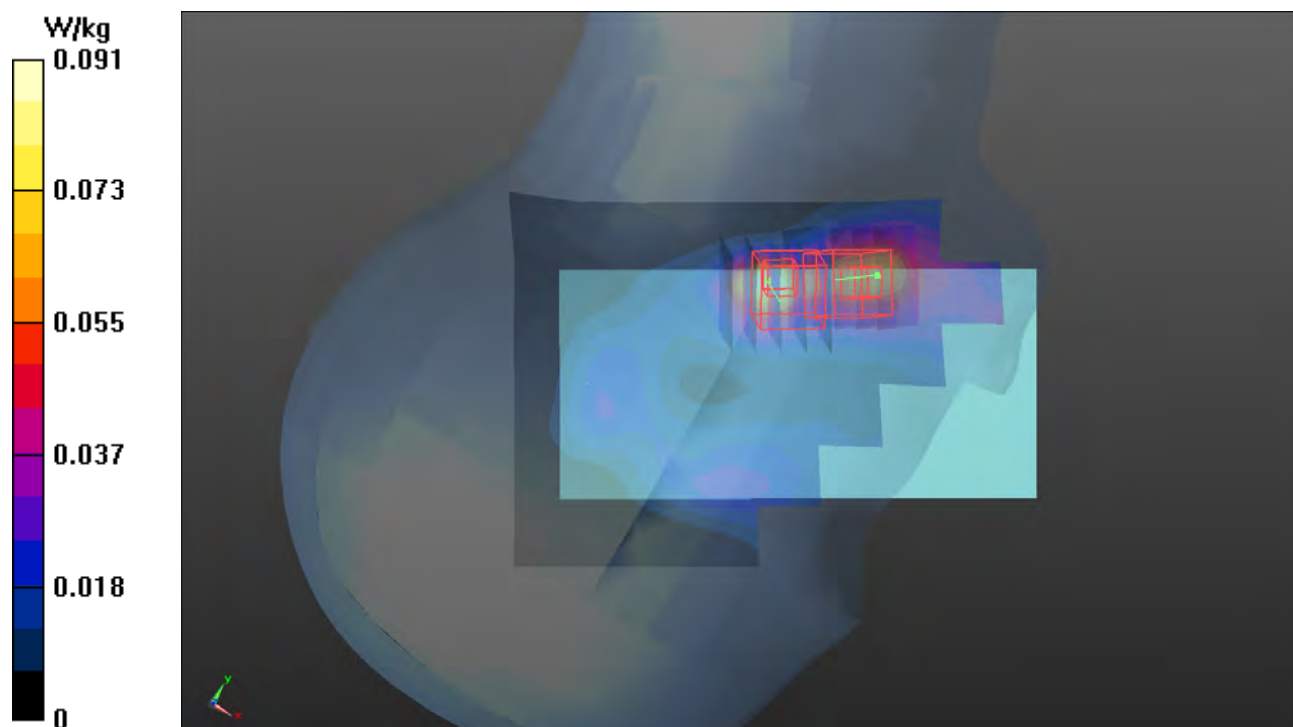

P06 LTE 4_QPSK20M_Right Cheek_Ch20300_1RB_OS50_Sample1_Ant1

DUT: 190723C05

Communication System: LTE; Frequency: 1745 MHz; Duty Cycle: 1:1

Medium: H16T20N1_0829 Medium parameters used: $f = 1745 \text{ MHz}$; $\sigma = 1.325 \text{ S/m}$; $\epsilon_r = 39.135$; $\rho = 1000 \text{ kg/m}^3$

Ambient Temperature : $23.5 \text{ }^\circ\text{C}$; Liquid Temperature : $23.1 \text{ }^\circ\text{C}$

DASY5 Configuration:

- Probe: EX3DV4 - SN3898; ConvF(8.72, 8.72, 8.72); Calibrated: 2019/06/27
- Sensor-Surface: 1.4mm (Mechanical Surface Detection)
- Electronics: DAE4 Sn916; Calibrated: 2018/12/12
- Phantom: Twin SAM Phantom_1496; Type: QD000P40CB;
- Measurement SW: DASY52, Version 52.10 (2); SEMCAD X Version 14.6.12 (7470)

- **Area Scan (81x141x1):** Interpolated grid: $dx=1.500 \text{ mm}$, $dy=1.500 \text{ mm}$

Maximum value of SAR (interpolated) = 0.00449 W/kg

- **Zoom Scan (5x5x7)/Cube 0:** Measurement grid: $dx=8\text{mm}$, $dy=8\text{mm}$, $dz=5\text{mm}$

Reference Value = 102.1 V/m ; Power Drift = -0.09 dB

Peak SAR (extrapolated) = 0.0290 W/kg

SAR(1 g) = 0.00476 W/kg ; SAR(10 g) = 0.00304 W/kg

Maximum value of SAR (measured) = 0.0289 W/kg

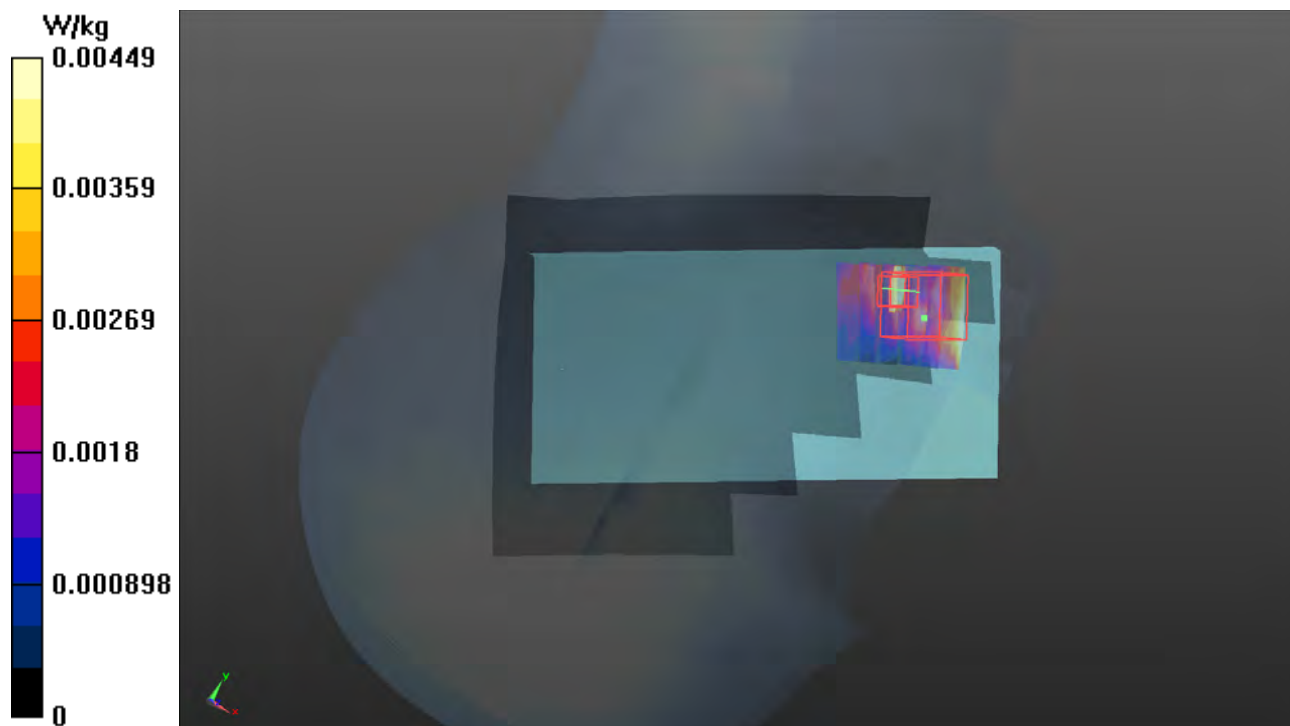

P07 LTE 5_QPSK10M_Right Cheek_Ch20450_1RB_OS0_Sample1_Ant3

DUT: 190723C05

Communication System: LTE; Frequency: 829 MHz; Duty Cycle: 1:1
Medium: H07T10N1_0831 Medium parameters used: $f = 829$ MHz; $\sigma = 0.903$ S/m; $\epsilon_r = 42.359$; $\rho = 1000$ kg/m³
Ambient Temperature : 23.6 °C ; Liquid Temperature : 23.3 °C

DASY5 Configuration:

- Probe: EX3DV4 - SN3971; ConvF(10.18, 10.18, 10.18); Calibrated: 2019/03/29
- Sensor-Surface: 1.4mm (Mechanical Surface Detection)
- Electronics: DAE4 Sn1431; Calibrated: 2019/03/25
- Phantom: Twin SAM Phantom_1823; Type: QD000P40CD;
- Measurement SW: DASY52, Version 52.10 (2); SEMCAD X Version 14.6.12 (7470)

- **Area Scan (81x141x1):** Interpolated grid: dx=1.500 mm, dy=1.500 mm
Maximum value of SAR (interpolated) = 1.81 W/kg

- **Zoom Scan (5x5x7)/Cube 0:** Measurement grid: dx=8mm, dy=8mm, dz=5mm
Reference Value = 42.71 V/m; Power Drift = -0.01 dB
Peak SAR (extrapolated) = 2.09 W/kg
SAR(1 g) = 1.01 W/kg; SAR(10 g) = 0.647 W/kg
Maximum value of SAR (measured) = 1.71 W/kg

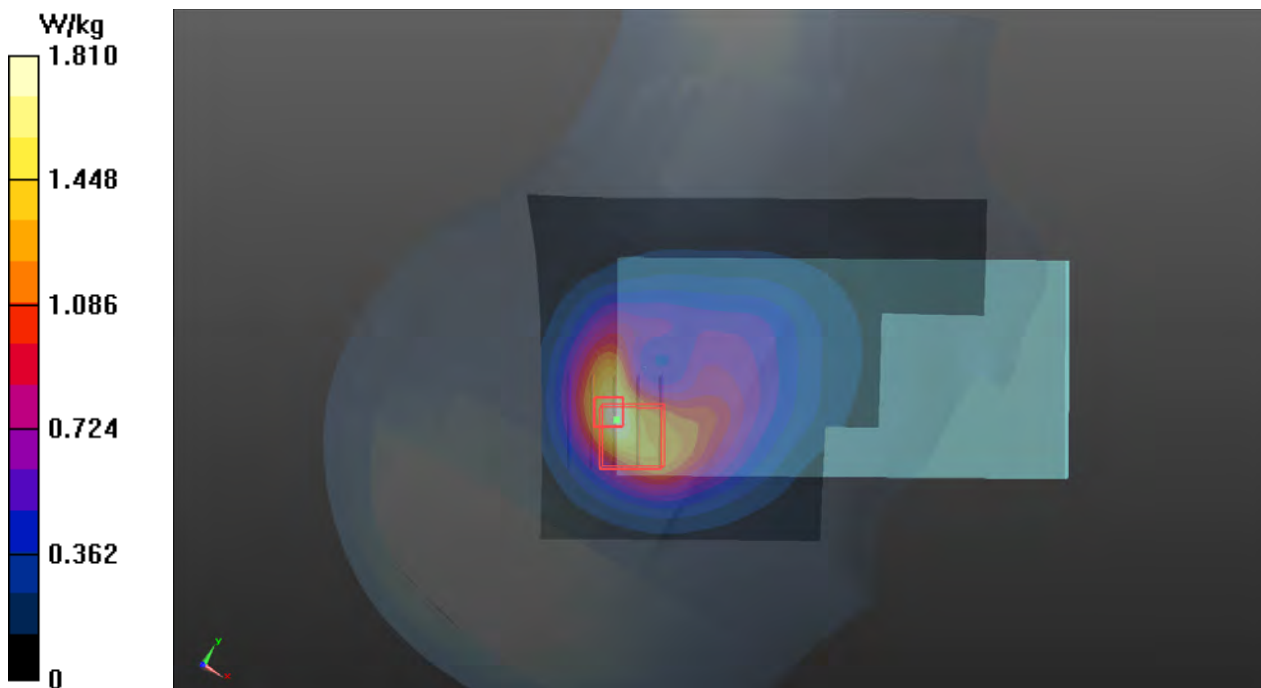

P08 LTE 7_QPSK20M_Right Cheek_Ch21350_1RB_OS50_Sample1_Ant2

DUT: 190723C05

Communication System: LTE; Frequency: 2560 MHz; Duty Cycle: 1:1

Medium: H19T27N3_0816 Medium parameters used: $f = 2560$ MHz; $\sigma = 1.998$ S/m; $\epsilon_r = 37.942$; $\rho = 1000$ kg/m³

Ambient Temperature : 23.7 °C ; Liquid Temperature : 23.2 °C

DASY5 Configuration:

- Probe: EX3DV4 - SN3971; ConvF(7.48, 7.48, 7.48); Calibrated: 2019/03/29
- Sensor-Surface: 1.4mm (Mechanical Surface Detection)
- Electronics: DAE4 Sn1431; Calibrated: 2019/03/25
- Phantom: Twin SAM Phantom_1496; Type: QD000P40CB;
- Measurement SW: DASY52, Version 52.10 (2); SEMCAD X Version 14.6.12 (7470)

- **Area Scan (101x171x1):** Interpolated grid: dx=1.200 mm, dy=1.200 mm

Maximum value of SAR (interpolated) = 0.193 W/kg

- **Zoom Scan (5x5x7)/Cube 0:** Measurement grid: dx=8mm, dy=8mm, dz=5mm

Reference Value = 9.308 V/m; Power Drift = -0.09 dB

Peak SAR (extrapolated) = 0.203 W/kg

SAR(1 g) = 0.124 W/kg; SAR(10 g) = 0.076 W/kg

Maximum value of SAR (measured) = 0.174 W/kg

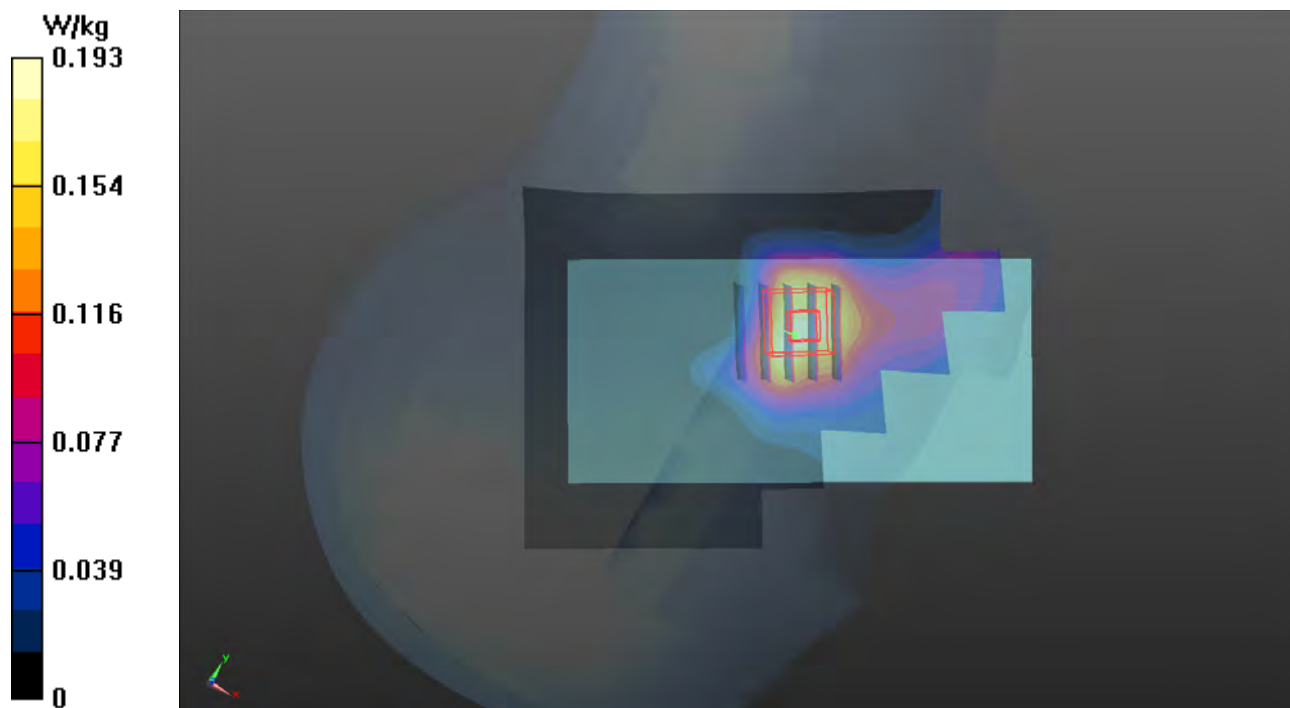

P09 LTE 38_QPSK20M_Right Cheek_Ch38150_1RB_OS50_Sample1_Ant2

DUT: 190723C05

Communication System: LTE TDD CF0; Frequency: 2610 MHz; Duty Cycle: 1:1.58

Medium: H19T27N3_0816 Medium parameters used: $f = 2610$ MHz; $\sigma = 2.054$ S/m; $\epsilon_r = 37.794$; $\rho = 1000$ kg/m³

Ambient Temperature : 23.7 °C ; Liquid Temperature : 23.2 °C

DASY5 Configuration:

- Probe: EX3DV4 - SN3971; ConvF(7.48, 7.48, 7.48); Calibrated: 2019/03/29
- Sensor-Surface: 1.4mm (Mechanical Surface Detection)
- Electronics: DAE4 Sn1431; Calibrated: 2019/03/25
- Phantom: Twin SAM Phantom_1496; Type: QD000P40CB;
- Measurement SW: DASY52, Version 52.10 (2); SEMCAD X Version 14.6.12 (7470)

- **Area Scan (101x171x1):** Interpolated grid: dx=1.200 mm, dy=1.200 mm

Maximum value of SAR (interpolated) = 0.160 W/kg

- **Zoom Scan (5x5x7)/Cube 0:** Measurement grid: dx=8mm, dy=8mm, dz=5mm

Reference Value = 7.276 V/m; Power Drift = -0.01 dB

Peak SAR (extrapolated) = 0.135 W/kg

SAR(1 g) = 0.081 W/kg; SAR(10 g) = 0.048 W/kg

Maximum value of SAR (measured) = 0.114 W/kg

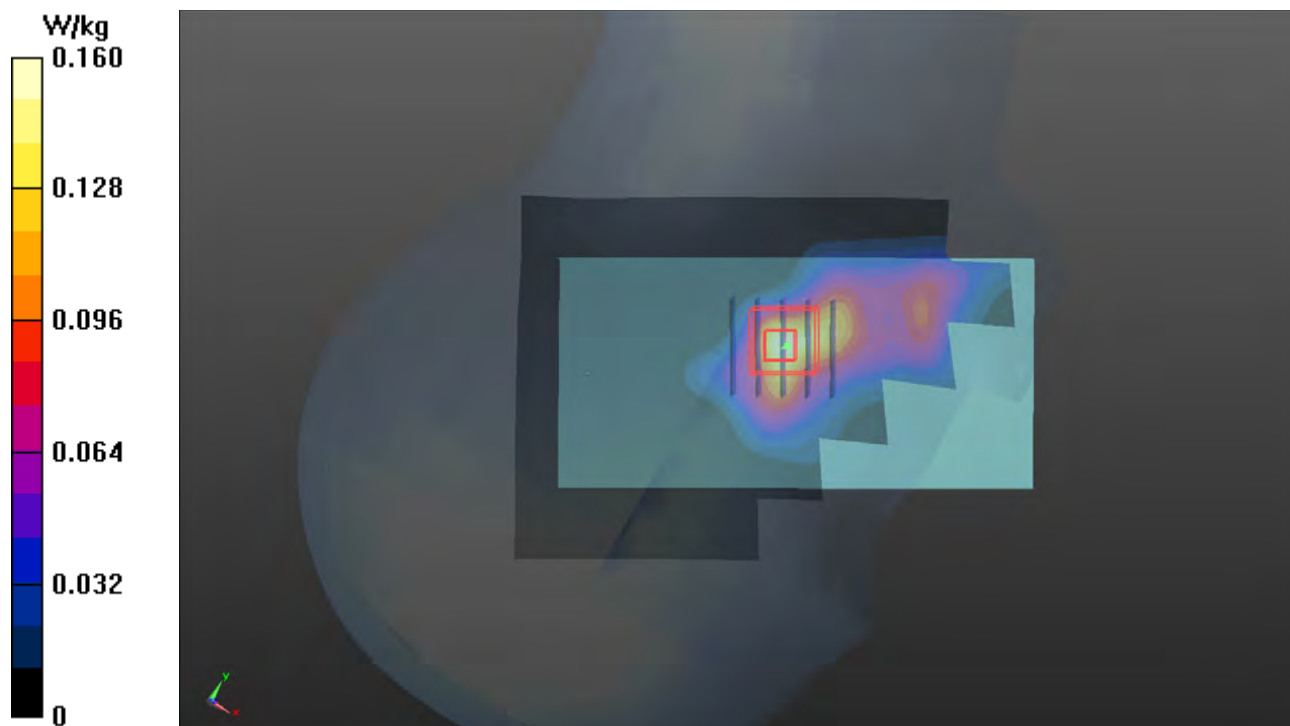

P10 WLAN2.4G_802.11b_Left Cheek_Ch11_Sample1

DUT: 190723C05

Communication System: WLAN_2.4G; Frequency: 2462 MHz; Duty Cycle: 1:1.01

Medium: H19T27N1_0906 Medium parameters used: $f = 2462$ MHz; $\sigma = 1.882$ S/m; $\epsilon_r = 39.956$; $\rho = 1000$ kg/m³

Ambient Temperature : 23.6 °C ; Liquid Temperature : 23.2 °C

DASY5 Configuration:

- Probe: EX3DV4 - SN3650; ConvF(7.63, 7.63, 7.63); Calibrated: 2019/05/20
- Sensor-Surface: 1.4mm (Mechanical Surface Detection)
- Electronics: DAE4 Sn861; Calibrated: 2019/05/08
- Phantom: Twin SAM Phantom_1653; Type: QD000P40CD;
- Measurement SW: DASY52, Version 52.10 (2); SEMCAD X Version 14.6.12 (7470)

- **Area Scan (101x151x1)**: Interpolated grid: dx=1.200 mm, dy=1.200 mm
Maximum value of SAR (interpolated) = 0.744 W/kg

- **Zoom Scan (5x5x7)/Cube 0**: Measurement grid: dx=8mm, dy=8mm, dz=5mm

Reference Value = 18.08 V/m; Power Drift = 0.07 dB

Peak SAR (extrapolated) = 1.51 W/kg

SAR(1 g) = 0.719 W/kg; SAR(10 g) = 0.312 W/kg

Maximum value of SAR (measured) = 1.20 W/kg

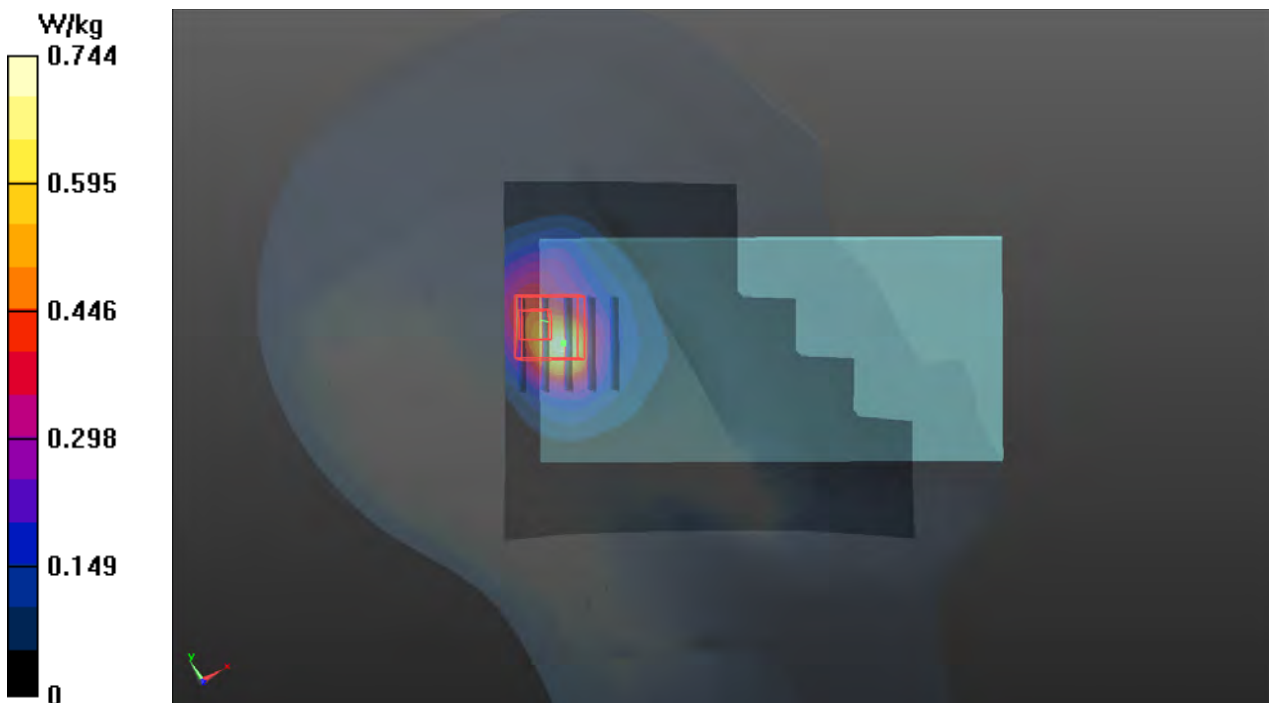

P11 WLAN5.3G_802.11a_Left Cheek_Ch60_Sample1

DUT: 190723C05

Communication System: WLAN_5G; Frequency: 5300 MHz; Duty Cycle: 1:1.03
Medium: H34T60N1_0906 Medium parameters used: $f = 5300$ MHz; $\sigma = 4.845$ S/m; $\epsilon_r = 35.18$; $\rho = 1000$ kg/m³
Ambient Temperature : 23.6 °C ; Liquid Temperature : 23.2 °C

DASY5 Configuration:

- Probe: EX3DV4 - SN3650; ConvF(5.4, 5.4, 5.4); Calibrated: 2019/05/20
- Sensor-Surface: 1.4mm (Mechanical Surface Detection)
- Electronics: DAE4 Sn861; Calibrated: 2019/05/08
- Phantom: Twin SAM Phantom_1653; Type: QD000P40CD;
- Measurement SW: DASY52, Version 52.10 (2); SEMCAD X Version 14.6.12 (7470)

- **Area Scan (121x181x1)**: Interpolated grid: dx=1.000 mm, dy=1.000 mm
Maximum value of SAR (interpolated) = 0.996 W/kg

- **Zoom Scan (6x6x12)/Cube 0**: Measurement grid: dx=5mm, dy=5mm, dz=2mm
Reference Value = 15.49 V/m; Power Drift = -0.11 dB
Peak SAR (extrapolated) = 2.73 W/kg
SAR(1 g) = 0.702 W/kg; SAR(10 g) = 0.208 W/kg
Maximum value of SAR (measured) = 1.60 W/kg

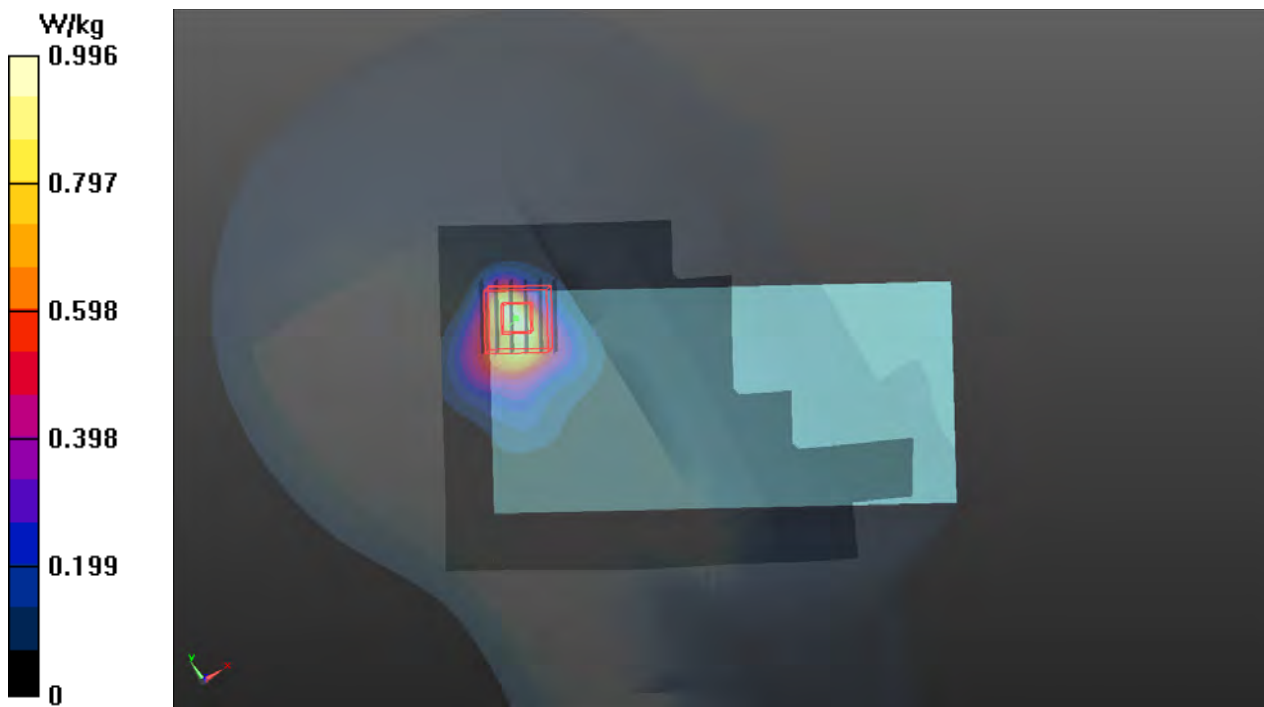

P12 WLAN5.6G_802.11a_Left Cheek_Ch140_Sample1

DUT: 190723C05

Communication System: WLAN_5G; Frequency: 5700 MHz; Duty Cycle: 1:1.03
Medium: H34T60N1_0906 Medium parameters used: $f = 5700$ MHz; $\sigma = 5.289$ S/m; $\epsilon_r = 34.479$; $\rho = 1000$ kg/m³
Ambient Temperature : 23.6 °C ; Liquid Temperature : 23.2 °C

DASY5 Configuration:

- Probe: EX3DV4 - SN3650; ConvF(5.17, 5.17, 5.17); Calibrated: 2019/05/20
- Sensor-Surface: 1.4mm (Mechanical Surface Detection)
- Electronics: DAE4 Sn861; Calibrated: 2019/05/08
- Phantom: Twin SAM Phantom_1653; Type: QD000P40CD;
- Measurement SW: DASY52, Version 52.10 (2); SEMCAD X Version 14.6.12 (7470)

- **Area Scan (121x181x1)**: Interpolated grid: dx=1.000 mm, dy=1.000 mm
Maximum value of SAR (interpolated) = 0.925 W/kg

- **Zoom Scan (6x6x12)/Cube 0**: Measurement grid: dx=5mm, dy=5mm, dz=2mm
Reference Value = 8.367 V/m; Power Drift = 0.16 dB
Peak SAR (extrapolated) = 2.36 W/kg
SAR(1 g) = 0.529 W/kg; SAR(10 g) = 0.147 W/kg
Maximum value of SAR (measured) = 1.34 W/kg

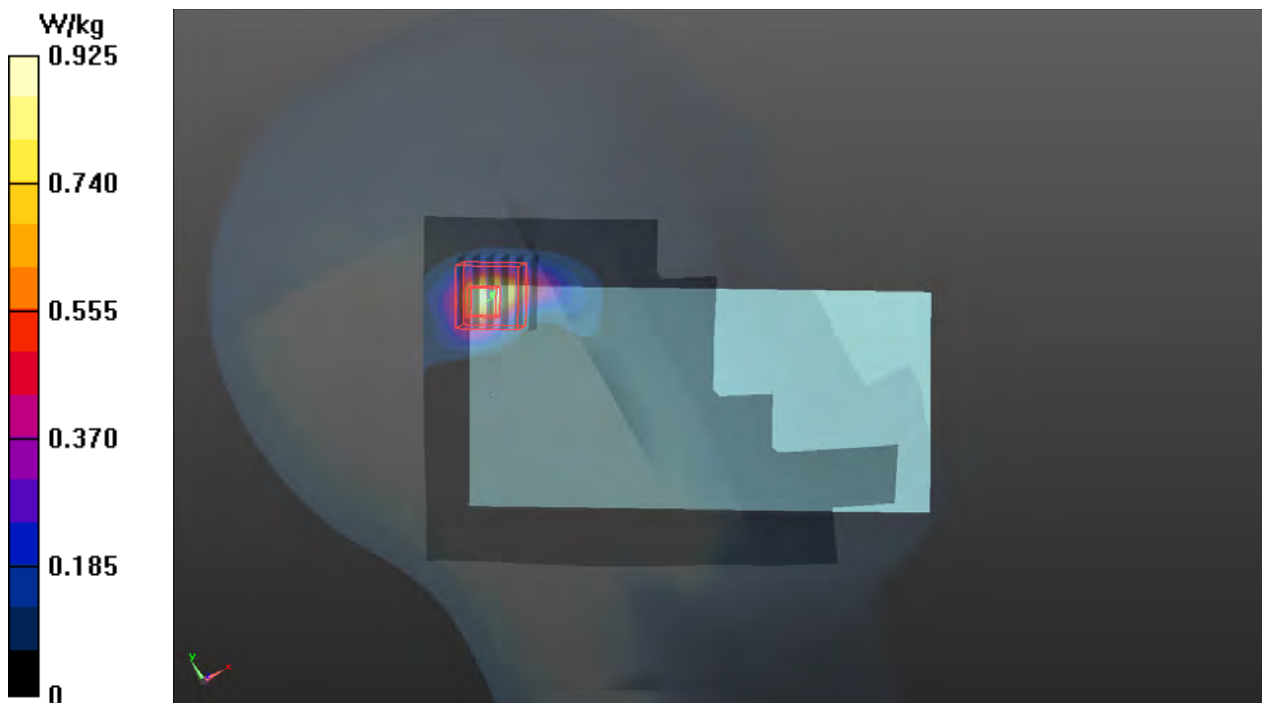

P13 WLAN5.8G_802.11a_Left Cheek_Ch157_Sample1

DUT: 190723C05

Communication System: WLAN_5G; Frequency: 5785 MHz; Duty Cycle: 1:1.03
Medium: H34T60N1_0906 Medium parameters used: $f = 5785$ MHz; $\sigma = 5.382$ S/m; $\epsilon_r = 34.32$; $\rho = 1000$ kg/m³
Ambient Temperature : 23.6 °C ; Liquid Temperature : 23.2 °C

DASY5 Configuration:

- Probe: EX3DV4 - SN3650; ConvF(5.17, 5.17, 5.17); Calibrated: 2019/05/20
- Sensor-Surface: 1.4mm (Mechanical Surface Detection)
- Electronics: DAE4 Sn861; Calibrated: 2019/05/08
- Phantom: Twin SAM Phantom_1653; Type: QD000P40CD;
- Measurement SW: DASY52, Version 52.10 (2); SEMCAD X Version 14.6.12 (7470)

- **Area Scan (121x181x1)**: Interpolated grid: dx=1.000 mm, dy=1.000 mm
Maximum value of SAR (interpolated) = 1.04 W/kg

- **Zoom Scan (6x6x12)/Cube 0**: Measurement grid: dx=5mm, dy=5mm, dz=2mm
Reference Value = 8.227 V/m; Power Drift = 0.16 dB
Peak SAR (extrapolated) = 2.57 W/kg
SAR(1 g) = 0.559 W/kg; SAR(10 g) = 0.151 W/kg
Maximum value of SAR (measured) = 1.47 W/kg

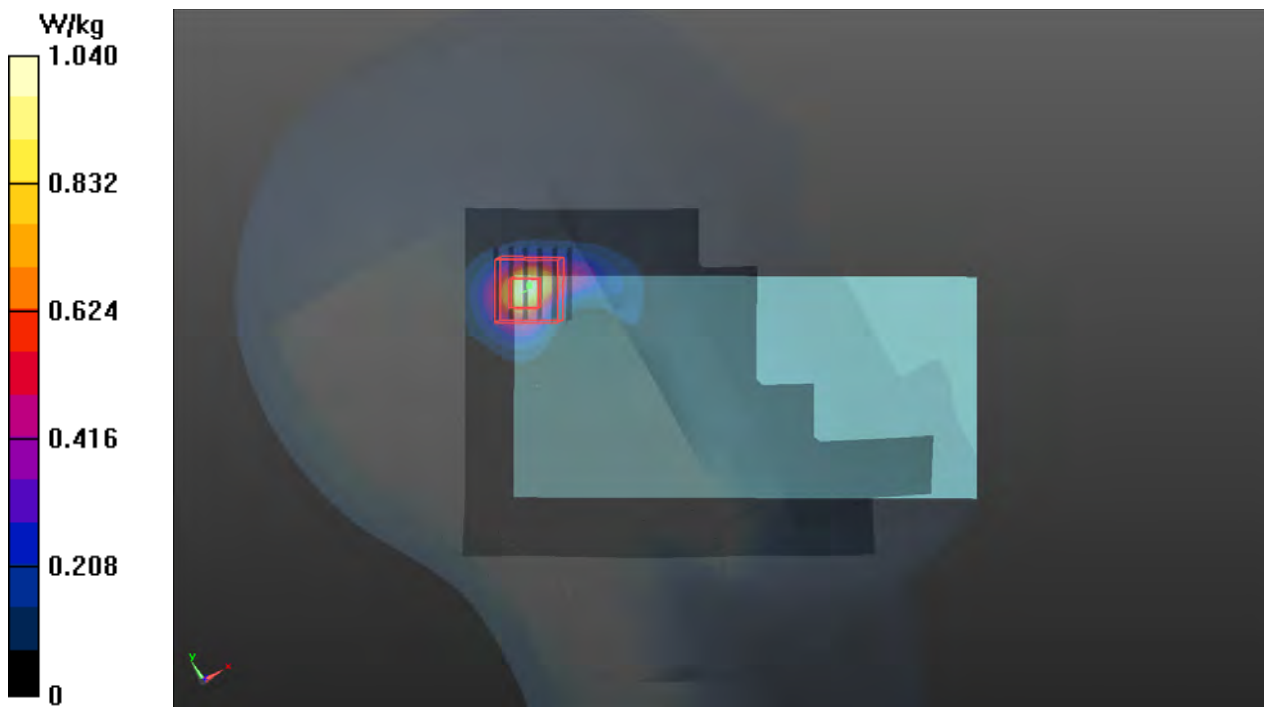

P14 BT_BDR_Left Cheek_Ch78_Sample1

DUT: 190723C05

Communication System: BT; Frequency: 2480 MHz; Duty Cycle: 1:1.31

Medium: H19T27N1_0821 Medium parameters used: $f = 2480$ MHz; $\sigma = 1.904$ S/m; $\epsilon_r = 38.645$; $\rho = 1000$ kg/m³

Ambient Temperature : 23.6 °C ; Liquid Temperature : 23.3 °C

DASY5 Configuration:

- Probe: EX3DV4 - SN7537; ConvF(7.39, 7.39, 7.39); Calibrated: 2019/06/18

- Sensor-Surface: 1.4mm (Mechanical Surface Detection)

- Electronics: DAE4 Sn1585; Calibrated: 2019/06/07

- Phantom: SAM Phantom_1982; Type: QD000P41Ax;

- Measurement SW: DASY52, Version 52.10 (2); SEMCAD X Version 14.6.12 (7470)

- **Area Scan (101x151x1)**: Interpolated grid: $dx=1.200$ mm, $dy=1.200$ mm

Maximum value of SAR (interpolated) = 0.302 W/kg

- **Zoom Scan (5x5x7)/Cube 0**: Measurement grid: $dx=8$ mm, $dy=8$ mm, $dz=5$ mm

Reference Value = 9.993 V/m; Power Drift = -0.07 dB

Peak SAR (extrapolated) = 0.261 W/kg

SAR(1 g) = 0.128 W/kg; SAR(10 g) = 0.062 W/kg

Maximum value of SAR (measured) = 0.208 W/kg

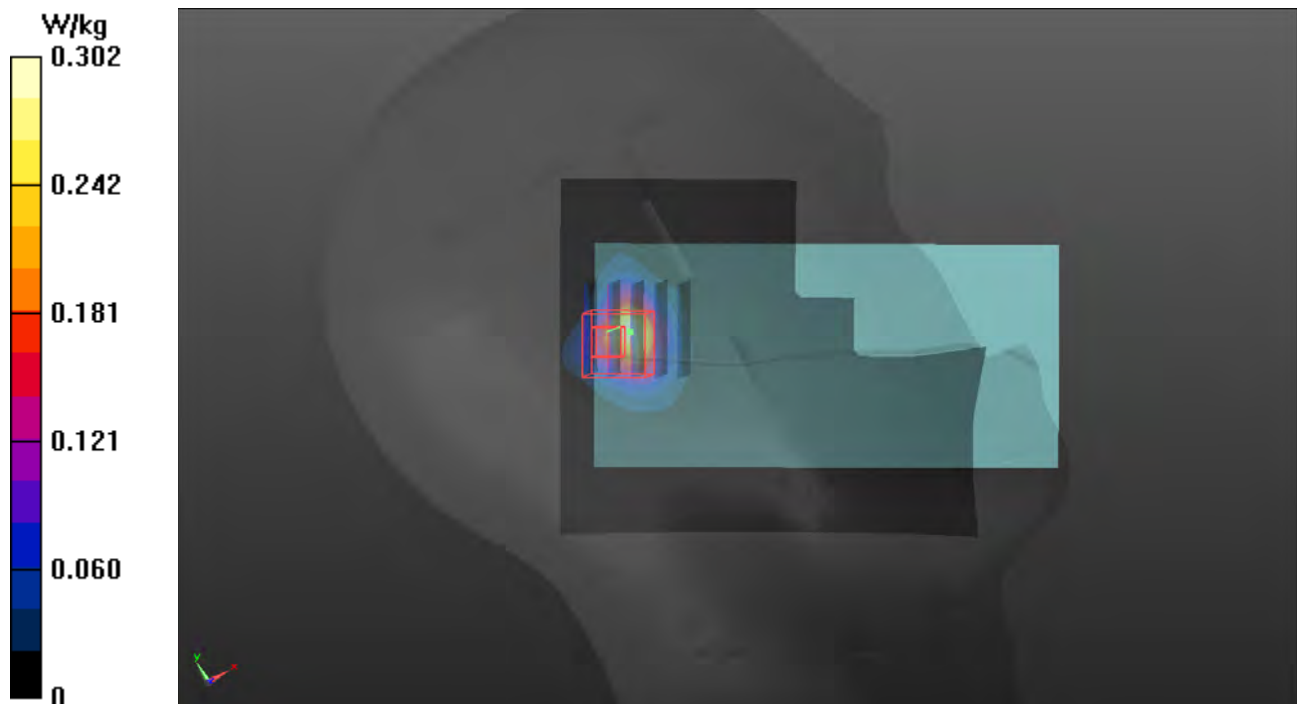

P15 GSM850_GPRS12_Rear Face_10mm_Ch251_Sample1_Ant3

DUT: 190723C05

Communication System: GPRS12; Frequency: 848.8 MHz; Duty Cycle: 1:2

Medium: H07T10N1_0831 Medium parameters used: $f = 848.8$ MHz; $\sigma = 0.921$ S/m; $\epsilon_r = 42.095$; $\rho = 1000$ kg/m³

Ambient Temperature : 23.6 °C ; Liquid Temperature : 23.3 °C

DASY5 Configuration:

- Probe: EX3DV4 - SN3971; ConvF(10.18, 10.18, 10.18); Calibrated: 2019/03/29
- Sensor-Surface: 1.4mm (Mechanical Surface Detection)
- Electronics: DAE4 Sn1431; Calibrated: 2019/03/25
- Phantom: Twin SAM Phantom_1823; Type: QD000P40CD;
- Measurement SW: DASY52, Version 52.10 (2); SEMCAD X Version 14.6.12 (7470)

- **Area Scan (81x141x1):** Interpolated grid: dx=1.500 mm, dy=1.500 mm
Maximum value of SAR (interpolated) = 1.05 W/kg

- **Zoom Scan (5x5x7)/Cube 1:** Measurement grid: dx=8mm, dy=8mm, dz=5mm
Reference Value = 33.84 V/m; Power Drift = -0.05 dB
Peak SAR (extrapolated) = 1.20 W/kg
SAR(1 g) = 0.731 W/kg; SAR(10 g) = 0.465 W/kg
Maximum value of SAR (measured) = 1.04 W/kg

- **Zoom Scan (5x5x7)/Cube 0:** Measurement grid: dx=8mm, dy=8mm, dz=5mm
Reference Value = 33.84 V/m; Power Drift = -0.05 dB
Peak SAR (extrapolated) = 1.26 W/kg
SAR(1 g) = 0.731 W/kg; SAR(10 g) = 0.465 W/kg
Maximum value of SAR (measured) = 1.08 W/kg

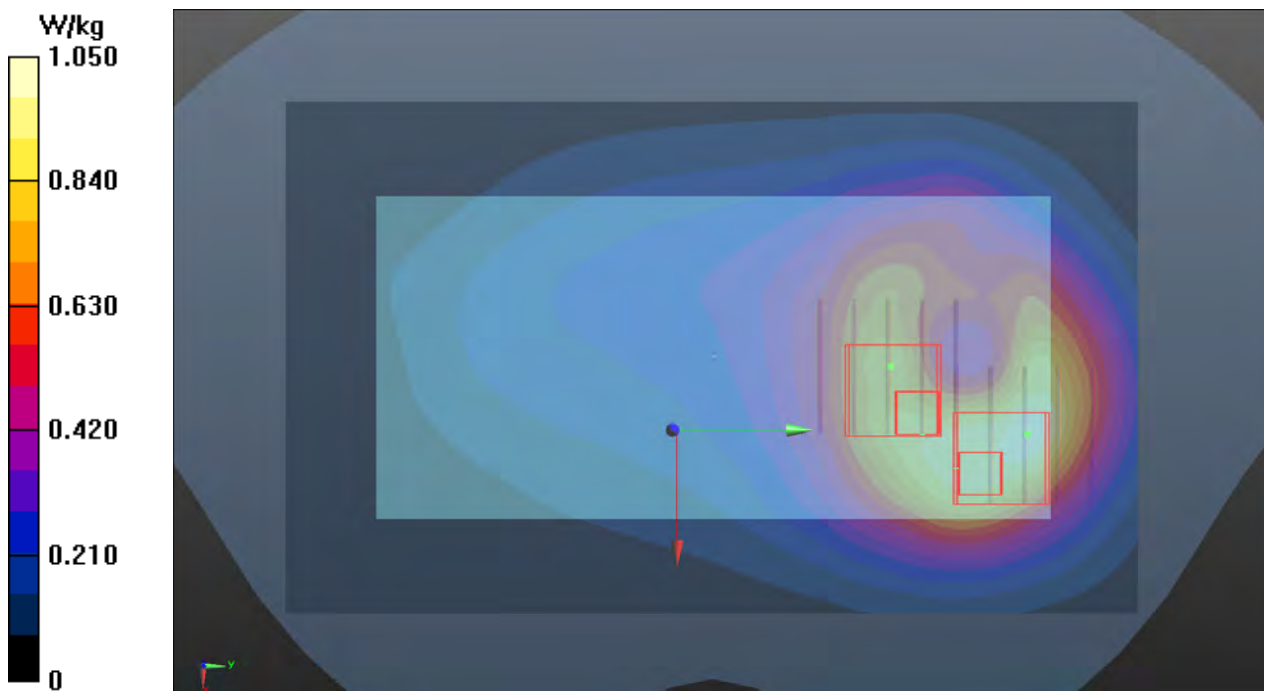

P16 GSM1900_EDGE12_Rear Face_10mm_Ch810_Sample1_Ant1

DUT: 190723C05

Communication System: EGPRS 12 ; Frequency: 1909.8 MHz;Duty Cycle: 1:2

Medium: H16T20N1_0827 Medium parameters used: $f = 1909.8$ MHz; $\sigma = 1.464$ S/m; $\epsilon_r = 40.422$; $\rho = 1000$ kg/m³

Ambient Temperature : 23.5 °C ; Liquid Temperature : 23.1 °C

DASY5 Configuration:

- Probe: EX3DV4 - SN7537; ConvF(8.13, 8.13, 8.13); Calibrated: 2019/06/18
- Sensor-Surface: 1.4mm (Mechanical Surface Detection)
- Electronics: DAE4 Sn1585; Calibrated: 2019/06/07
- Phantom: SAM Phantom_1982; Type: QD000P41Ax;
- Measurement SW: DASY52, Version 52.10 (2); SEMCAD X Version 14.6.12 (7470)

- **Area Scan (81x141x1)**: Interpolated grid: dx=1.500 mm, dy=1.500 mm
Maximum value of SAR (interpolated) = 0.463 W/kg

- **Zoom Scan (5x5x7)/Cube 0**: Measurement grid: dx=8mm, dy=8mm, dz=5mm
Reference Value = 17.08 V/m; Power Drift = -0.02 dB
Peak SAR (extrapolated) = 0.776 W/kg
SAR(1 g) = 0.417 W/kg; SAR(10 g) = 0.220 W/kg
Maximum value of SAR (measured) = 0.567 W/kg

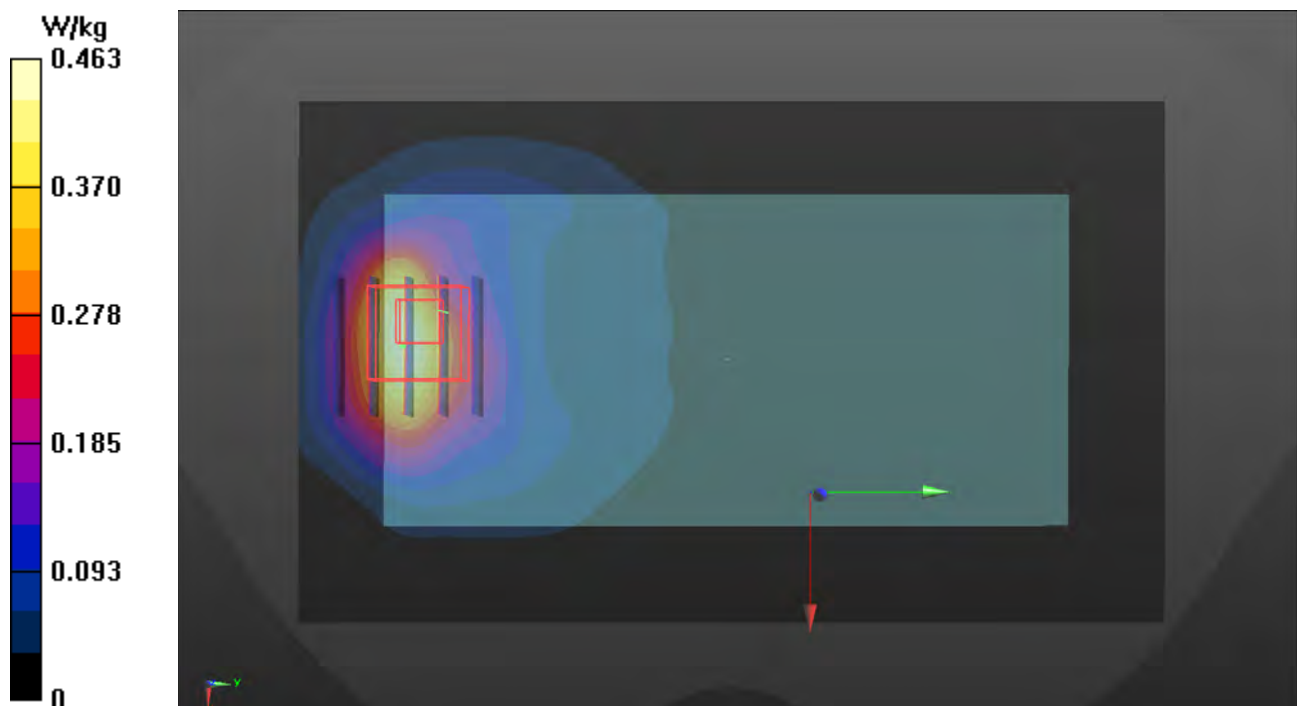

P17 WCDMA II_RMC12.2K_Rear Face_10mm_Ch9538_Sample 1_Ant1

DUT: 190723C05

Communication System: WCDMA; Frequency: 1907.6 MHz; Duty Cycle: 1:1

Medium: H16T20N1_1007 Medium parameters used: $f = 1908$ MHz; $\sigma = 1.462$ S/m; $\epsilon_r = 40.475$; $\rho = 1000$ kg/m³

Ambient Temperature : 23.5 °C ; Liquid Temperature : 23.2 °C

DASY5 Configuration:

- Probe: EX3DV4 - SN7537; ConvF(8.13, 8.13, 8.13); Calibrated: 2019/06/18

- Sensor-Surface: 1.4mm (Mechanical Surface Detection)

- Electronics: DAE4 Sn1585; Calibrated: 2019/06/07

- Phantom: SAM Phantom_1982; Type: QD 000 P41 Ax; Serial: 1982

- Measurement SW: DASY52, Version 52.10 (2); SEMCAD X Version 14.6.12 (7470)

- **Area Scan (81x141x1)**: Interpolated grid: $dx=1.500$ mm, $dy=1.500$ mm

Maximum value of SAR (interpolated) = 0.694 W/kg

- **Zoom Scan (5x5x7)/Cube 0**: Measurement grid: $dx=8$ mm, $dy=8$ mm, $dz=5$ mm

Reference Value = 20.13 V/m; Power Drift = -0.04 dB

Peak SAR (extrapolated) = 1.07 W/kg

SAR(1 g) = 0.611 W/kg; SAR(10 g) = 0.336 W/kg

Maximum value of SAR (measured) = 0.843 W/kg

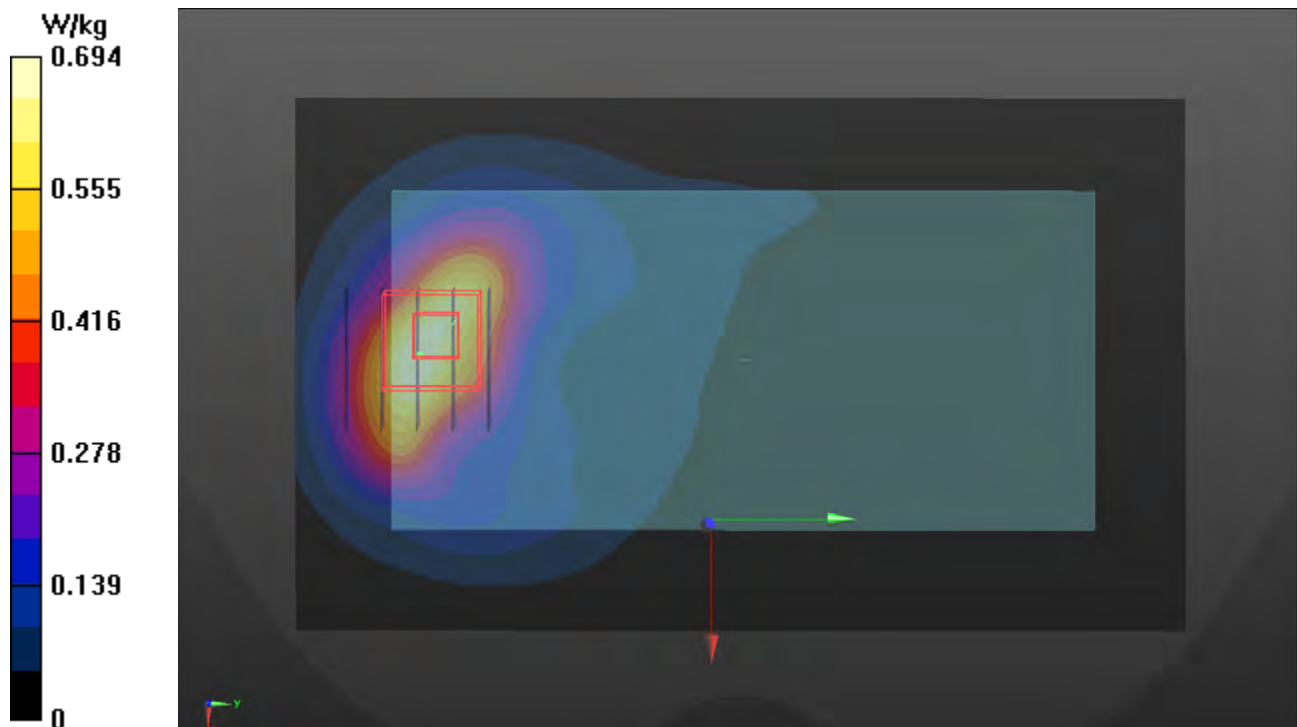

P18 WCDMA IV_RMC12.2K_Rear Face_10mm_Ch1413_Sample 1_Ant1

DUT: 190723C05

Communication System: WCDMA; Frequency: 1732.6 MHz; Duty Cycle: 1:1

Medium: H16T20N1_1007 Medium parameters used: $f = 1733$ MHz; $\sigma = 1.307$ S/m; $\epsilon_r = 41.108$; $\rho = 1000$ kg/m³

Ambient Temperature : 23.5 °C ; Liquid Temperature : 23.2 °C

DASY5 Configuration:

- Probe: EX3DV4 - SN7537; ConvF(8.44, 8.44, 8.44); Calibrated: 2019/06/18

- Sensor-Surface: 1.4mm (Mechanical Surface Detection)

- Electronics: DAE4 Sn1585; Calibrated: 2019/06/07

- Phantom: SAM Phantom_1982; Type: QD 000 P41 Ax; Serial: 1982

- Measurement SW: DASY52, Version 52.10 (2); SEMCAD X Version 14.6.12 (7470)

- **Area Scan (81x141x1)**: Interpolated grid: dx=1.500 mm, dy=1.500 mm

Maximum value of SAR (interpolated) = 0.760 W/kg

- **Zoom Scan (5x5x7)/Cube 0**: Measurement grid: dx=8mm, dy=8mm, dz=5mm

Reference Value = 24.12 V/m; Power Drift = -0.05 dB

Peak SAR (extrapolated) = 0.973 W/kg

SAR(1 g) = 0.586 W/kg; SAR(10 g) = 0.327 W/kg

Maximum value of SAR (measured) = 0.801 W/kg

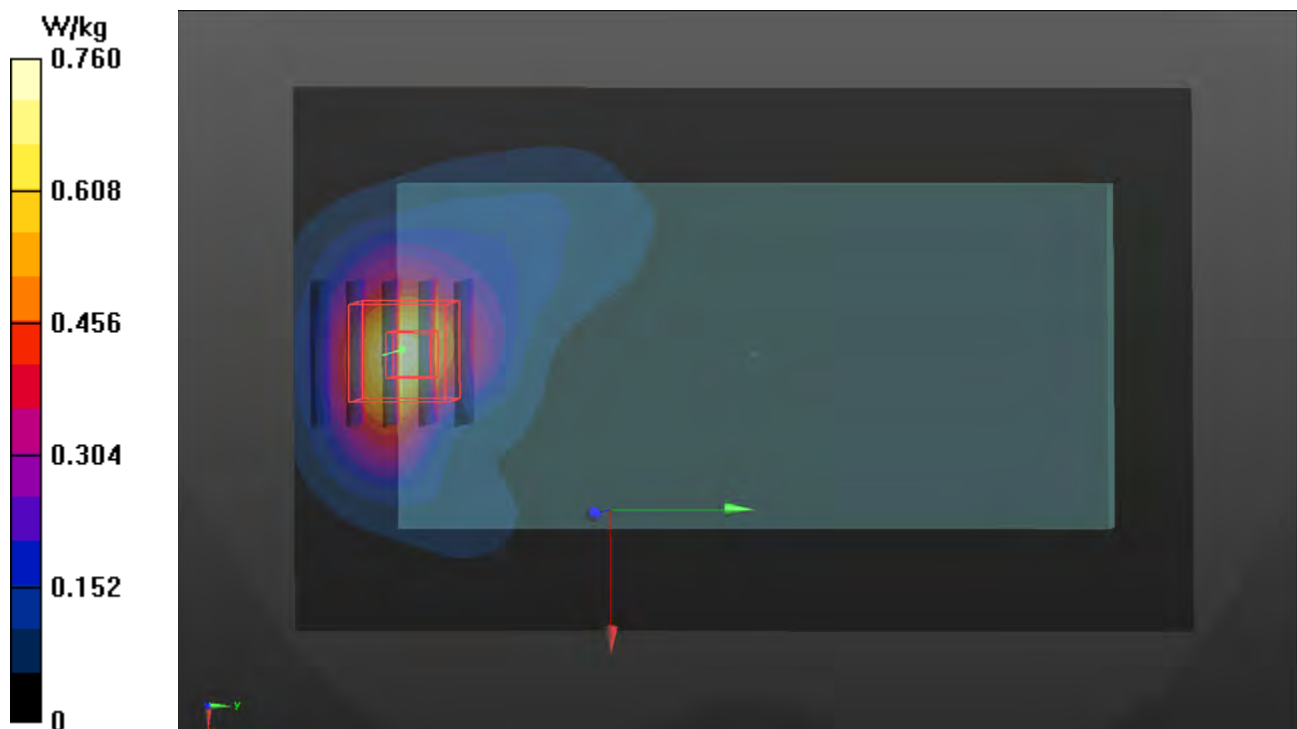

P19 WCDMA V_RMC12.2K_Front Face_10mm_Ch4182_Sample1_Ant3

DUT: 190723C05

Communication System: WCDMA; Frequency: 836.4 MHz; Duty Cycle: 1:1
Medium: H07T10N1_0831 Medium parameters used: $f = 836.4$ MHz; $\sigma = 0.91$ S/m; $\epsilon_r = 42.261$; $\rho = 1000$ kg/m³
Ambient Temperature : 23.6 °C ; Liquid Temperature : 23.3 °C

DASY5 Configuration:

- Probe: EX3DV4 - SN3971; ConvF(10.18, 10.18, 10.18); Calibrated: 2019/03/29
- Sensor-Surface: 1.4mm (Mechanical Surface Detection)
- Electronics: DAE4 Sn1431; Calibrated: 2019/03/25
- Phantom: Twin SAM Phantom_1823; Type: QD000P40CD;
- Measurement SW: DASY52, Version 52.10 (2); SEMCAD X Version 14.6.12 (7470)

- **Area Scan (81x141x1):** Interpolated grid: dx=1.500 mm, dy=1.500 mm
Maximum value of SAR (interpolated) = 0.660 W/kg

- **Zoom Scan (5x5x7)/Cube 0:** Measurement grid: dx=8mm, dy=8mm, dz=5mm
Reference Value = 26.47 V/m; Power Drift = -0.09 dB
Peak SAR (extrapolated) = 0.769 W/kg
SAR(1 g) = 0.478 W/kg; SAR(10 g) = 0.297 W/kg
Maximum value of SAR (measured) = 0.651 W/kg

- **Zoom Scan (5x5x7)/Cube 1:** Measurement grid: dx=8mm, dy=8mm, dz=5mm
Reference Value = 26.47 V/m; Power Drift = -0.09 dB
Peak SAR (extrapolated) = 0.710 W/kg
SAR(1 g) = 0.451 W/kg; SAR(10 g) = 0.302 W/kg
Maximum value of SAR (measured) = 0.617 W/kg

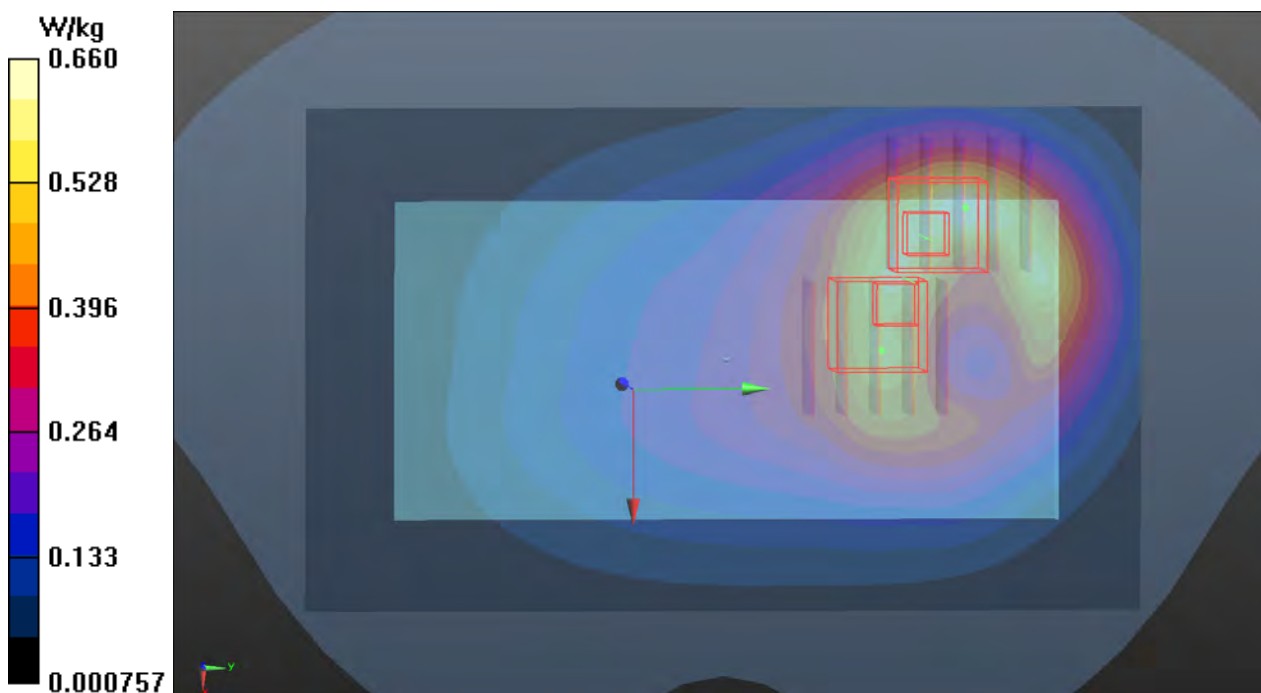

P20 LTE 2_QPSK20M_Rear Face_10mm_Ch18900_1RB_OS00_Sample1_Ant1

DUT: 190723C05

Communication System: LTE; Frequency: 1880 MHz; Duty Cycle: 1:1

Medium: H16T20N1_0916 Medium parameters used: $f = 1880$ MHz; $\sigma = 1.446$ S/m; $\epsilon_r = 38.187$; $\rho = 1000$ kg/m³

Ambient Temperature : 23.6 °C ; Liquid Temperature : 23.2 °C

DASY5 Configuration:

- Probe: EX3DV4 - SN3650; ConvF(8.25, 8.25, 8.25); Calibrated: 2019/05/20
- Sensor-Surface: 1.4mm (Mechanical Surface Detection)
- Electronics: DAE4 Sn861; Calibrated: 2019/05/08
- Phantom: Twin SAM Phantom_1653; Type: QD000P40CD;
- Measurement SW: DASY52, Version 52.10 (2); SEMCAD X Version 14.6.12 (7470)

- **Area Scan (81x141x1):** Interpolated grid: dx=1.500 mm, dy=1.500 mm
Maximum value of SAR (interpolated) = 0.895 W/kg

- **Zoom Scan (5x5x7)/Cube 0:** Measurement grid: dx=8mm, dy=8mm, dz=5mm
Reference Value = 25.69 V/m; Power Drift = -0.04 dB

Peak SAR (extrapolated) = 1.05 W/kg

SAR(1 g) = 0.605 W/kg; SAR(10 g) = 0.323 W/kg

Maximum value of SAR (measured) = 0.891 W/kg

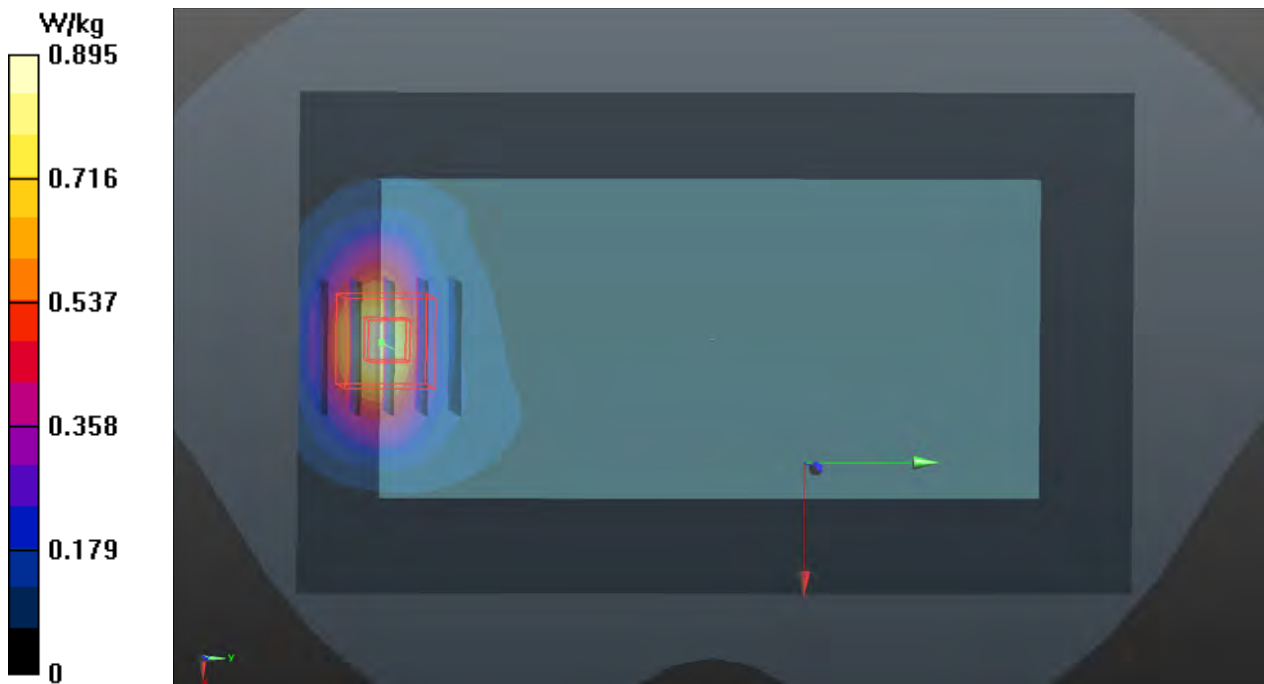

P21 LTE 4_QPSK20M_Rear Face_10mm_Ch20300_1RB_OS50_Sample 1_Ant1

DUT: 190723C05

Communication System: LTE; Frequency: 1745 MHz; Duty Cycle: 1:1

Medium: H16T20N1_1007 Medium parameters used: $f = 1745$ MHz; $\sigma = 1.319$ S/m; $\epsilon_r = 41.061$; $\rho = 1000$ kg/m³

Ambient Temperature : 23.5 °C ; Liquid Temperature : 23.2 °C

DASY5 Configuration:

- Probe: EX3DV4 - SN7537; ConvF(8.44, 8.44, 8.44); Calibrated: 2019/06/18
- Sensor-Surface: 1.4mm (Mechanical Surface Detection)
- Electronics: DAE4 Sn1585; Calibrated: 2019/06/07
- Phantom: SAM Phantom_1982; Type: QD 000 P41 Ax; Serial: 1982
- Measurement SW: DASY52, Version 52.10 (2); SEMCAD X Version 14.6.12 (7470)

- **Area Scan (81x141x1)**: Interpolated grid: dx=1.500 mm, dy=1.500 mm
Maximum value of SAR (interpolated) = 0.898 W/kg

- **Zoom Scan (5x5x7)/Cube 0**: Measurement grid: dx=8mm, dy=8mm, dz=5mm
Reference Value = 27.20 V/m; Power Drift = 0.15 dB
Peak SAR (extrapolated) = 1.08 W/kg
SAR(1 g) = 0.651 W/kg; SAR(10 g) = 0.362 W/kg
Maximum value of SAR (measured) = 0.908 W/kg

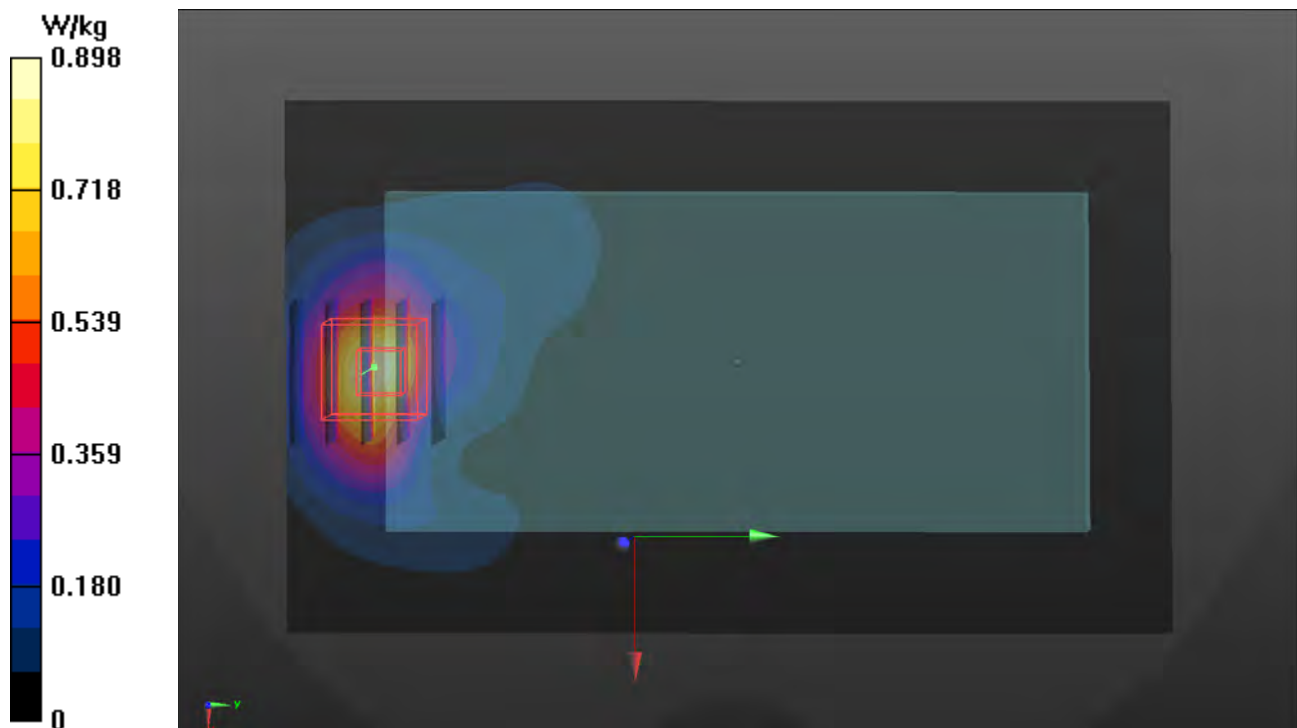

P22 LTE 5_QPSK10M_Rear Face_10mm_Ch20525_1RB_OS0_Sample1_Ant3

DUT: 190723C05

Communication System: LTE; Frequency: 836.5 MHz; Duty Cycle: 1:1

Medium: H07T10N1_0831 Medium parameters used: $f = 836.5$ MHz; $\sigma = 0.91$ S/m; $\epsilon_r = 42.259$; $\rho = 1000$ kg/m³

Ambient Temperature : 23.6 °C ; Liquid Temperature : 23.3 °C

DASY5 Configuration:

- Probe: EX3DV4 - SN3971; ConvF(10.18, 10.18, 10.18); Calibrated: 2019/03/29
- Sensor-Surface: 1.4mm (Mechanical Surface Detection)
- Electronics: DAE4 Sn1431; Calibrated: 2019/03/25
- Phantom: Twin SAM Phantom_1823; Type: QD000P40CD;
- Measurement SW: DASY52, Version 52.10 (2); SEMCAD X Version 14.6.12 (7470)

- **Area Scan (81x141x1):** Interpolated grid: dx=1.500 mm, dy=1.500 mm
Maximum value of SAR (interpolated) = 0.577 W/kg

- **Zoom Scan (5x5x7)/Cube 1:** Measurement grid: dx=8mm, dy=8mm, dz=5mm
Reference Value = 25.44 V/m; Power Drift = -0.06 dB
Peak SAR (extrapolated) = 0.664 W/kg
SAR(1 g) = 0.416 W/kg; SAR(10 g) = 0.280 W/kg
Maximum value of SAR (measured) = 0.569 W/kg

- **Zoom Scan (5x5x7)/Cube 0:** Measurement grid: dx=8mm, dy=8mm, dz=5mm
Reference Value = 25.44 V/m; Power Drift = -0.06 dB
Peak SAR (extrapolated) = 0.711 W/kg
SAR(1 g) = 0.392 W/kg; SAR(10 g) = 0.229 W/kg
Maximum value of SAR (measured) = 0.607 W/kg

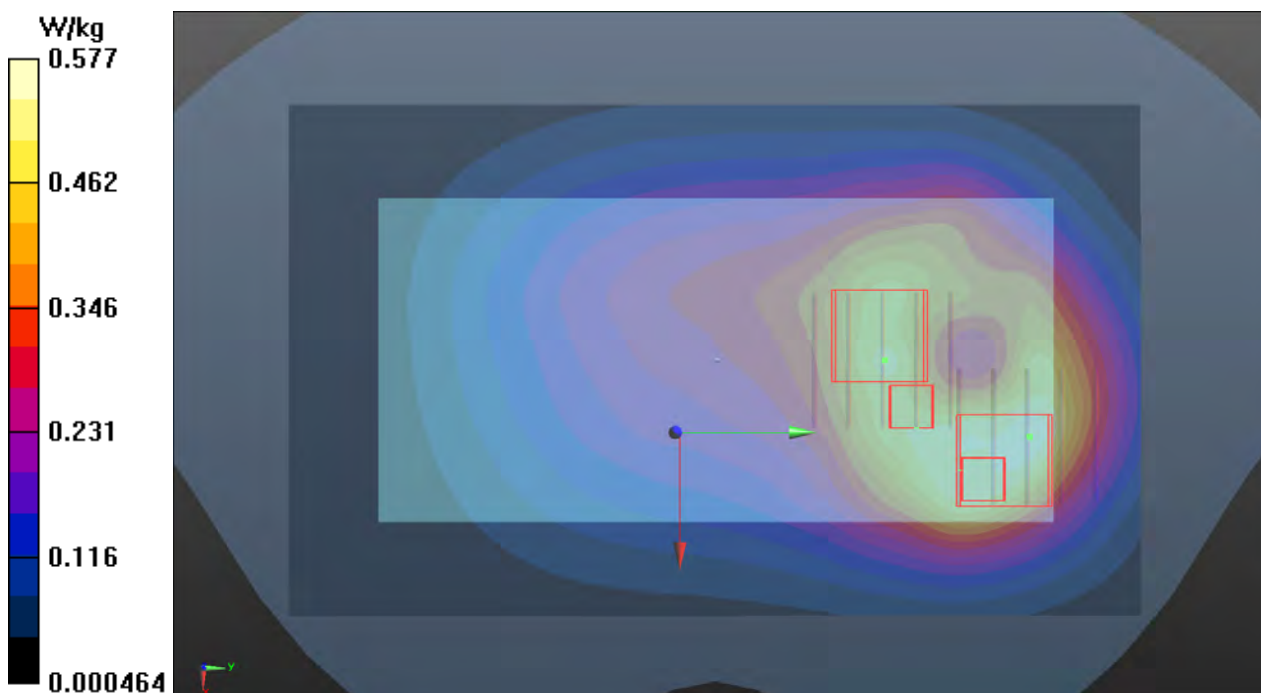

P23 LTE 7_QPSK20M_Front Face_10mm_Ch21350_1RB_OS50_Sample1_Ant2

DUT: 190723C05

Communication System: LTE; Frequency: 2560 MHz; Duty Cycle: 1:1

Medium: H19T27N3_0816 Medium parameters used: $f = 2560$ MHz; $\sigma = 1.998$ S/m; $\epsilon_r = 37.942$; $\rho = 1000$ kg/m³

Ambient Temperature : 23.7 °C ; Liquid Temperature : 23.2 °C

DASY5 Configuration:

- Probe: EX3DV4 - SN3971; ConvF(7.48, 7.48, 7.48); Calibrated: 2019/03/29
- Sensor-Surface: 1.4mm (Mechanical Surface Detection)
- Electronics: DAE4 Sn1431; Calibrated: 2019/03/25
- Phantom: Twin SAM Phantom_1496; Type: QD000P40CB;
- Measurement SW: DASY52, Version 52.10 (2); SEMCAD X Version 14.6.12 (7470)

- **Area Scan (101x171x1):** Interpolated grid: dx=1.200 mm, dy=1.200 mm

Maximum value of SAR (interpolated) = 0.766 W/kg

- **Zoom Scan (5x5x7)/Cube 0:** Measurement grid: dx=8mm, dy=8mm, dz=5mm

Reference Value = 19.62 V/m; Power Drift = -0.04 dB

Peak SAR (extrapolated) = 1.28 W/kg

SAR(1 g) = 0.647 W/kg; SAR(10 g) = 0.316 W/kg

Maximum value of SAR (measured) = 1.01 W/kg

- **Zoom Scan (5x5x7)/Cube 1:** Measurement grid: dx=8mm, dy=8mm, dz=5mm

Reference Value = 19.62 V/m; Power Drift = -0.04 dB

Peak SAR (extrapolated) = 0.631 W/kg

SAR(1 g) = 0.320 W/kg; SAR(10 g) = 0.165 W/kg

Maximum value of SAR (measured) = 0.475 W/kg

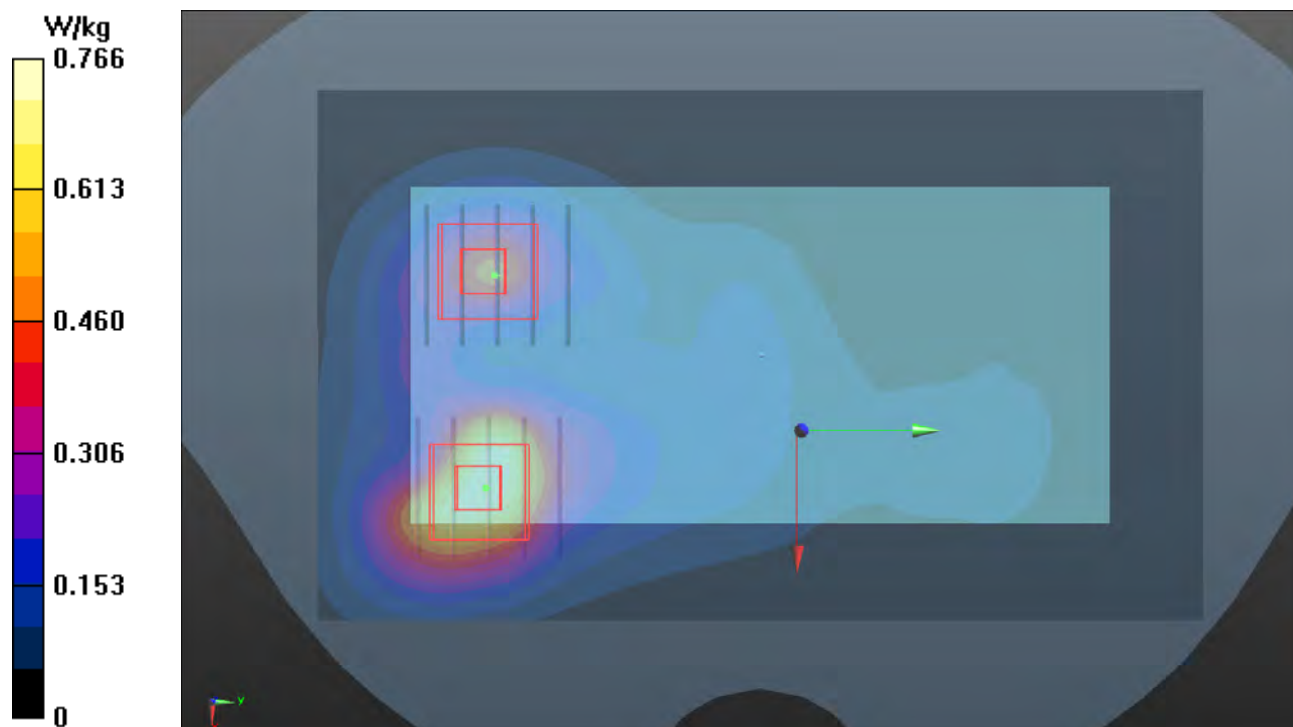

P24 LTE 38_QPSK20M_Front Face_10mm_Ch38150_1RB_OS50_Sample1_Ant2

DUT: 190723C05

Communication System: LTE TDD CF0; Frequency: 2610 MHz; Duty Cycle: 1:1.58

Medium: H19T27N3_0816 Medium parameters used: $f = 2610$ MHz; $\sigma = 2.054$ S/m; $\epsilon_r = 37.794$; $\rho = 1000$ kg/m³

Ambient Temperature : 23.7 °C ; Liquid Temperature : 23.2 °C

DASY5 Configuration:

- Probe: EX3DV4 - SN3971; ConvF(7.48, 7.48, 7.48); Calibrated: 2019/03/29
- Sensor-Surface: 1.4mm (Mechanical Surface Detection)
- Electronics: DAE4 Sn1431; Calibrated: 2019/03/25
- Phantom: Twin SAM Phantom_1496; Type: QD000P40CB;
- Measurement SW: DASY52, Version 52.10 (2); SEMCAD X Version 14.6.12 (7470)

- **Area Scan (101x171x1):** Interpolated grid: dx=1.200 mm, dy=1.200 mm

Maximum value of SAR (interpolated) = 0.552 W/kg

- **Zoom Scan (5x5x7)/Cube 0:** Measurement grid: dx=8mm, dy=8mm, dz=5mm

Reference Value = 16.03 V/m; Power Drift = -0.09 dB

Peak SAR (extrapolated) = 0.863 W/kg

SAR(1 g) = 0.436 W/kg; SAR(10 g) = 0.211 W/kg

Maximum value of SAR (measured) = 0.655 W/kg

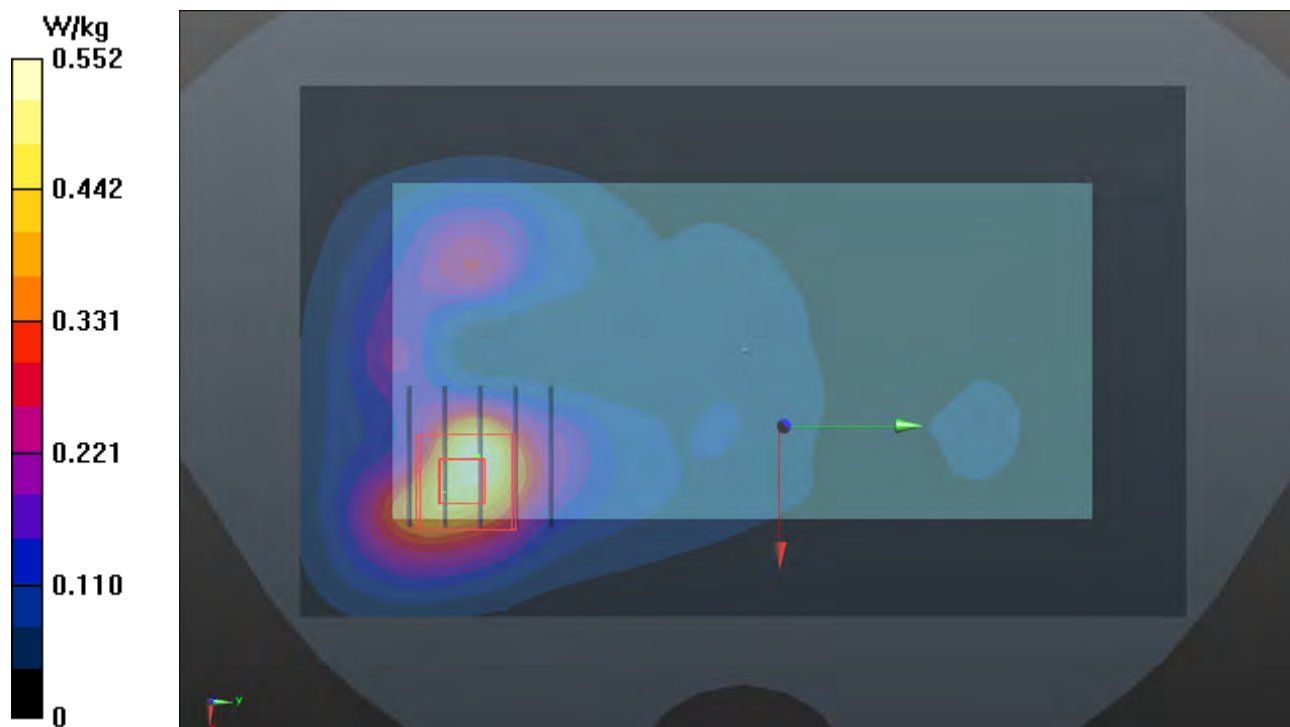

P25 WLAN2.4G_802.11b_Rear Face_10mm_Ch11_Sample1

DUT: 190723C05

Communication System: WLAN_2.4G; Frequency: 2462 MHz; Duty Cycle: 1:1.01

Medium: H19T27N3_0909 Medium parameters used: $f = 2462$ MHz; $\sigma = 1.838$ S/m; $\epsilon_r = 38.895$; $\rho = 1000$ kg/m³

Ambient Temperature : 23.4 °C ; Liquid Temperature : 23.1 °C

DASY5 Configuration:

- Probe: EX3DV4 - SN3650; ConvF(7.63, 7.63, 7.63); Calibrated: 2019/05/20
- Sensor-Surface: 1.4mm (Mechanical Surface Detection)
- Electronics: DAE4 Sn861; Calibrated: 2019/05/08
- Phantom: Twin SAM Phantom_1653; Type: QD000P40CD;
- Measurement SW: DASY52, Version 52.10 (2); SEMCAD X Version 14.6.12 (7470)

- **Area Scan (101x171x1)**: Interpolated grid: dx=1.200 mm, dy=1.200 mm

Maximum value of SAR (interpolated) = 0.278 W/kg

- **Zoom Scan (5x5x7)/Cube 0**: Measurement grid: dx=8mm, dy=8mm, dz=5mm

Reference Value = 10.87 V/m; Power Drift = -0.03 dB

Peak SAR (extrapolated) = 0.266 W/kg

SAR(1 g) = 0.135 W/kg; SAR(10 g) = 0.070 W/kg

Maximum value of SAR (measured) = 0.216 W/kg

- **Zoom Scan (5x5x7)/Cube 1**: Measurement grid: dx=8mm, dy=8mm, dz=5mm

Reference Value = 10.87 V/m; Power Drift = -0.03 dB

Peak SAR (extrapolated) = 0.250 W/kg

SAR(1 g) = 0.126 W/kg; SAR(10 g) = 0.064 W/kg

Maximum value of SAR (measured) = 0.205 W/kg

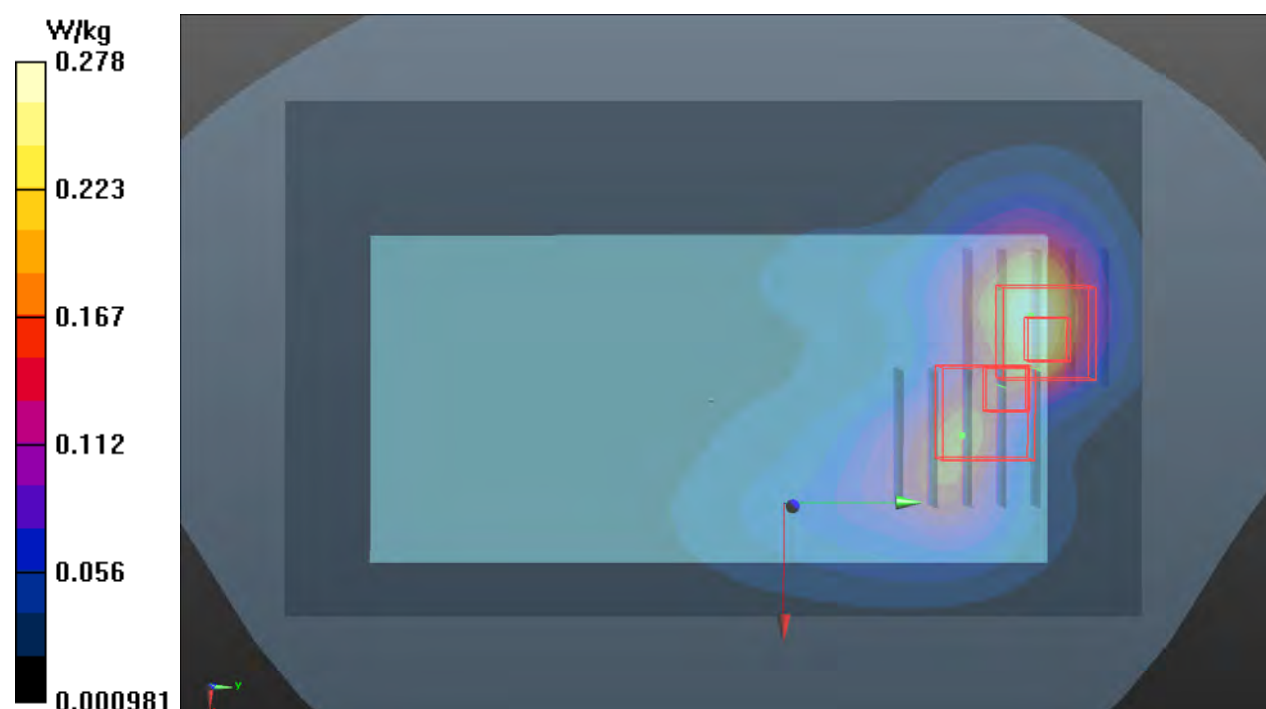

P27 WLAN5.3G_802.11a_Rear Face_10mm_Ch60_Sample1

DUT: 190723C05

Communication System: WLAN_5G; Frequency: 5300 MHz; Duty Cycle: 1:1.03

Medium: H34T60N1_0916 Medium parameters used: $f = 5300$ MHz; $\sigma = 4.687$ S/m; $\epsilon_r = 35.647$; $\rho = 1000$ kg/m³

Ambient Temperature : 23.6 °C ; Liquid Temperature : 23.2 °C

DASY5 Configuration:

- Probe: EX3DV4 - SN3650; ConvF(5.4, 5.4, 5.4); Calibrated: 2019/05/20
- Sensor-Surface: 1.4mm (Mechanical Surface Detection)
- Electronics: DAE4 Sn861; Calibrated: 2019/05/08
- Phantom: Twin SAM Phantom_1653; Type: QD000P40CD;
- Measurement SW: DASY52, Version 52.10 (2); SEMCAD X Version 14.6.12 (7470)

- **Area Scan (121x201x1):** Interpolated grid: dx=1.000 mm, dy=1.000 mm

Maximum value of SAR (interpolated) = 0.326 W/kg

- **Zoom Scan (6x6x12)/Cube 0:** Measurement grid: dx=5mm, dy=5mm, dz=2mm

Reference Value = 8.223 V/m; Power Drift = 0.16 dB

Peak SAR (extrapolated) = 0.641 W/kg

SAR(1 g) = 0.166 W/kg; SAR(10 g) = 0.060 W/kg

Maximum value of SAR (measured) = 0.368 W/kg

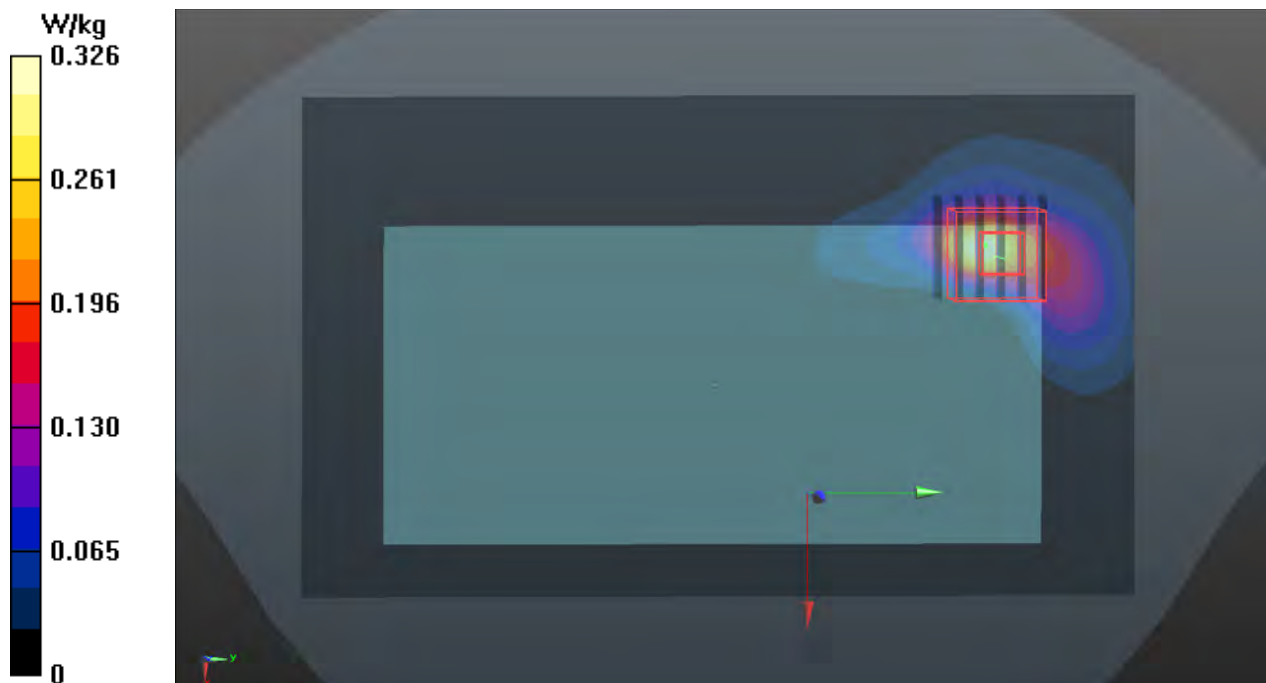

P28 WLAN5.6G_802.11a_Rear Face_10mm_Ch140_Sample1

DUT: 190723C05

Communication System: WLAN_5G; Frequency: 5700 MHz; Duty Cycle: 1:1.03
Medium: H34T60N1_0916 Medium parameters used: $f = 5700$ MHz; $\sigma = 5.088$ S/m; $\epsilon_r = 35.039$; $\rho = 1000$ kg/m³
Ambient Temperature : 23.6 °C ; Liquid Temperature : 23.2 °C

DASY5 Configuration:

- Probe: EX3DV4 - SN3650; ConvF(5.17, 5.17, 5.17); Calibrated: 2019/05/20
- Sensor-Surface: 1.4mm (Mechanical Surface Detection)
- Electronics: DAE4 Sn861; Calibrated: 2019/05/08
- Phantom: Twin SAM Phantom_1653; Type: QD000P40CD;
- Measurement SW: DASY52, Version 52.10 (2); SEMCAD X Version 14.6.12 (7470)

- **Area Scan (121x201x1):** Interpolated grid: dx=1.000 mm, dy=1.000 mm
Maximum value of SAR (interpolated) = 0.224 W/kg

- **Zoom Scan (6x6x12)/Cube 0:** Measurement grid: dx=5mm, dy=5mm, dz=2mm
Reference Value = 5.928 V/m; Power Drift = 0.17 dB
Peak SAR (extrapolated) = 0.502 W/kg
SAR(1 g) = 0.106 W/kg; SAR(10 g) = 0.035 W/kg
Maximum value of SAR (measured) = 0.266 W/kg

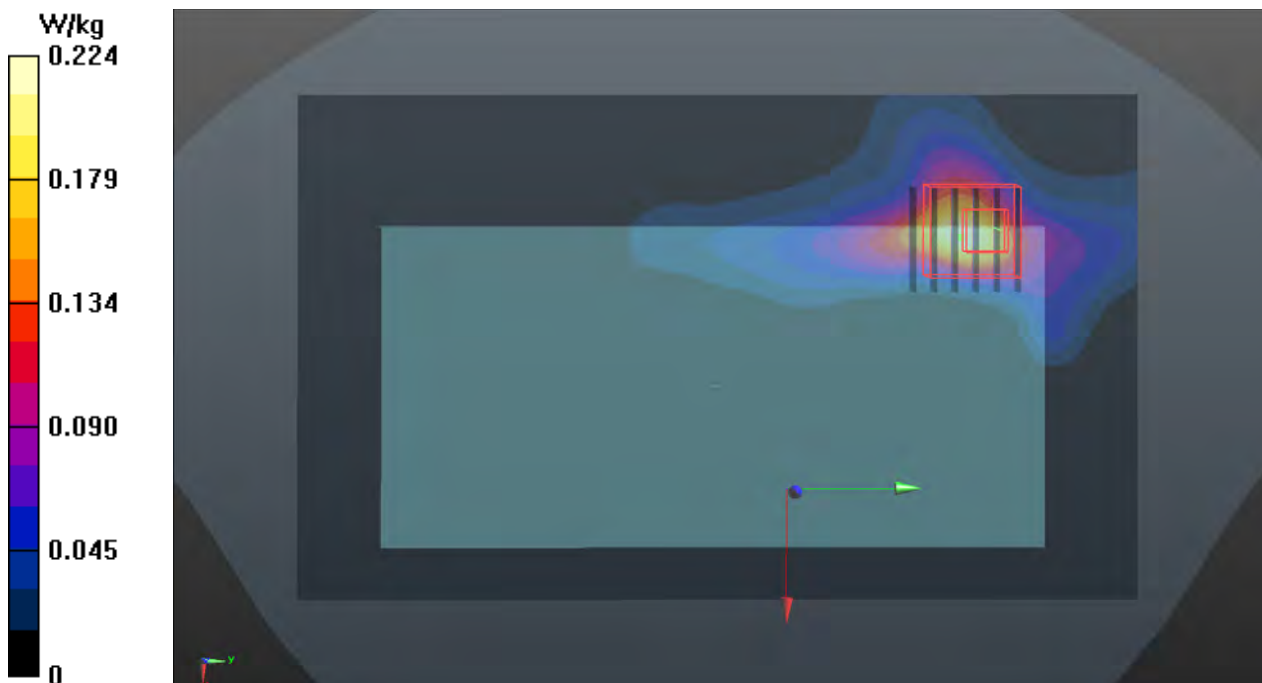

P29 WLAN5.8G_802.11a_Rear Face_10mm_Ch157_Sample1

DUT: 190723C05

Communication System: WLAN_5G; Frequency: 5785 MHz; Duty Cycle: 1:1.03
Medium: H34T60N1_0908 Medium parameters used: $f = 5785$ MHz; $\sigma = 5.323$ S/m; $\epsilon_r = 33.912$; $\rho = 1000$ kg/m³
Ambient Temperature : 23.4 °C ; Liquid Temperature : 23.1 °C

DASY5 Configuration:

- Probe: EX3DV4 - SN3650; ConvF(5.17, 5.17, 5.17); Calibrated: 2019/05/20
- Sensor-Surface: 1.4mm (Mechanical Surface Detection)
- Electronics: DAE4 Sn861; Calibrated: 2019/05/08
- Phantom: Twin SAM Phantom_1653; Type: QD000P40CD;
- Measurement SW: DASY52, Version 52.10 (2); SEMCAD X Version 14.6.12 (7470)

- **Area Scan (121x201x1):** Interpolated grid: dx=1.000 mm, dy=1.000 mm
Maximum value of SAR (interpolated) = 0.0991 W/kg

- **Zoom Scan (6x6x12)/Cube 0:** Measurement grid: dx=5mm, dy=5mm, dz=2mm
Reference Value = 4.467 V/m; Power Drift = -0.01 dB
Peak SAR (extrapolated) = 0.362 W/kg
SAR(1 g) = 0.077 W/kg; SAR(10 g) = 0.023 W/kg
Maximum value of SAR (measured) = 0.196 W/kg

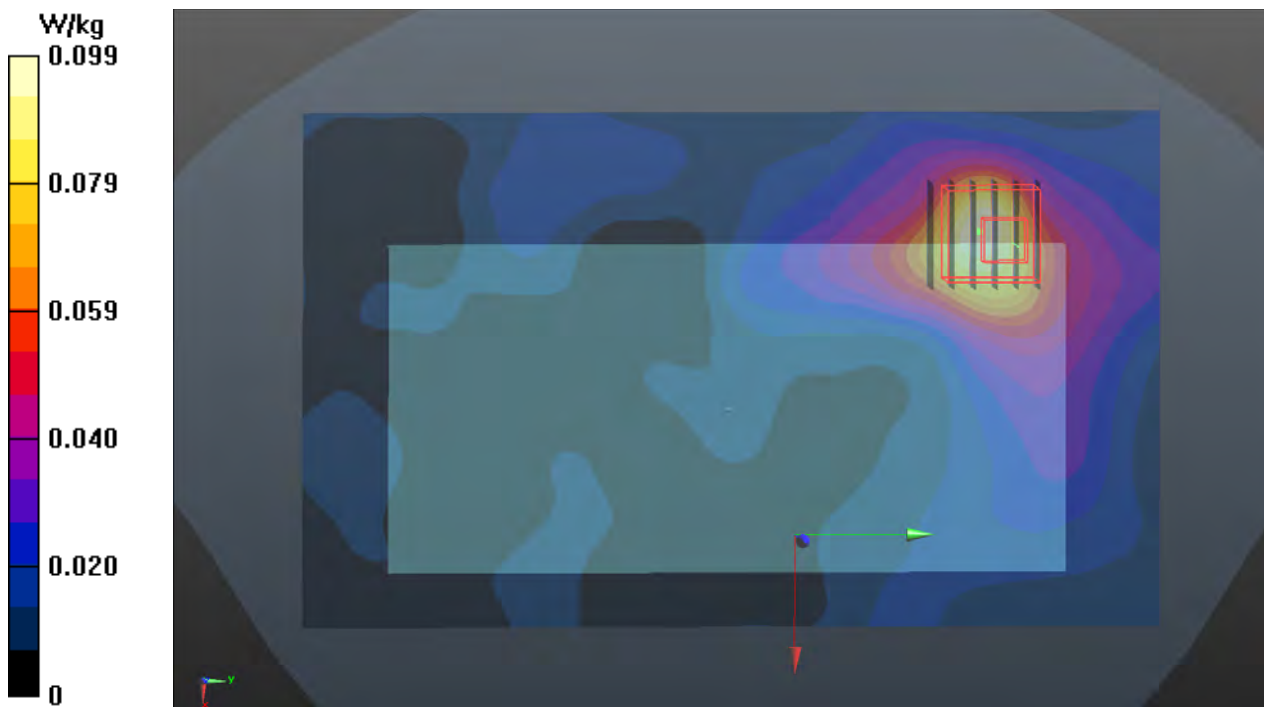

P30 BT_BDR_Rear Face_10mm_Ch78_Sample1_Ant0

DUT: 190723C05

Communication System: BT; Frequency: 2480 MHz; Duty Cycle: 1:1.31
Medium: H19T27N1_0916 Medium parameters used: $f = 2480$ MHz; $\sigma = 1.897$ S/m; $\epsilon_r = 37.978$; $\rho = 1000$ kg/m³
Ambient Temperature : 23.6 °C ; Liquid Temperature : 23.2 °C

DASY5 Configuration:

- Probe: EX3DV4 - SN3650; ConvF(7.63, 7.63, 7.63); Calibrated: 2019/05/20
- Sensor-Surface: 1.4mm (Mechanical Surface Detection)
- Electronics: DAE4 Sn861; Calibrated: 2019/05/08
- Phantom: Twin SAM Phantom_1653; Type: QD000P40CD;
- Measurement SW: DASY52, Version 52.10 (2); SEMCAD X Version 14.6.12 (7470)

- **Area Scan (101x171x1):** Interpolated grid: dx=1.200 mm, dy=1.200 mm
Maximum value of SAR (interpolated) = 0.0784 W/kg

- **Zoom Scan (5x5x7)/Cube 0:** Measurement grid: dx=8mm, dy=8mm, dz=5mm
Reference Value = 5.624 V/m; Power Drift = -0.16 dB
Peak SAR (extrapolated) = 0.0770 W/kg
SAR(1 g) = 0.034 W/kg; SAR(10 g) = 0.013 W/kg
Maximum value of SAR (measured) = 0.0613 W/kg

- **Zoom Scan (5x5x7)/Cube 1:** Measurement grid: dx=8mm, dy=8mm, dz=5mm
Reference Value = 5.624 V/m; Power Drift = -0.16 dB
Peak SAR (extrapolated) = 0.0750 W/kg
SAR(1 g) = 0.031 W/kg; SAR(10 g) = 0.011 W/kg
Maximum value of SAR (measured) = 0.0581 W/kg

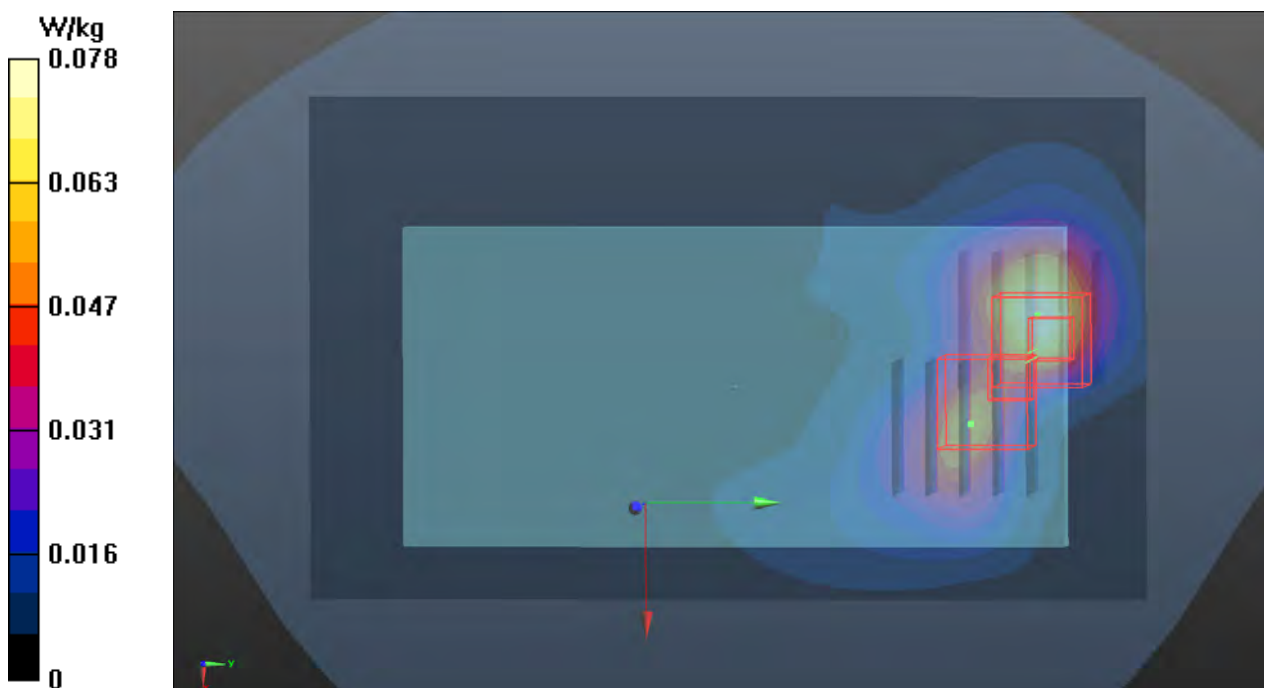

P31 GSM1900_EDGE12_Bottom Side_10mm_Ch810_Sample1_Ant1

DUT: 190723C05

Communication System: EGPRS 12; Frequency: 1909.8 MHz; Duty Cycle: 1:2

Medium: H16T20N1_0829 Medium parameters used: $f = 1909.8$ MHz; $\sigma = 1.467$ S/m; $\epsilon_r = 38.509$; $\rho = 1000$ kg/m³

Ambient Temperature : 23.5 °C ; Liquid Temperature : 23.1 °C

DASY5 Configuration:

- Probe: EX3DV4 - SN3898; ConvF(8.35, 8.35, 8.35); Calibrated: 2019/06/27
- Sensor-Surface: 1.4mm (Mechanical Surface Detection)
- Electronics: DAE4 Sn916; Calibrated: 2018/12/12
- Phantom: Twin SAM Phantom_1496; Type: QD000P40CB;
- Measurement SW: DASY52, Version 52.10 (2); SEMCAD X Version 14.6.12 (7470)

- **Area Scan (71x81x1):** Interpolated grid: dx=1.500 mm, dy=1.500 mm

Maximum value of SAR (interpolated) = 0.802 W/kg

- **Zoom Scan (5x5x7)/Cube 0:** Measurement grid: dx=8mm, dy=8mm, dz=5mm

Reference Value = 21.51 V/m; Power Drift = -0.16 dB

Peak SAR (extrapolated) = 0.999 W/kg

SAR(1 g) = 0.601 W/kg; SAR(10 g) = 0.336 W/kg

Maximum value of SAR (measured) = 0.861 W/kg

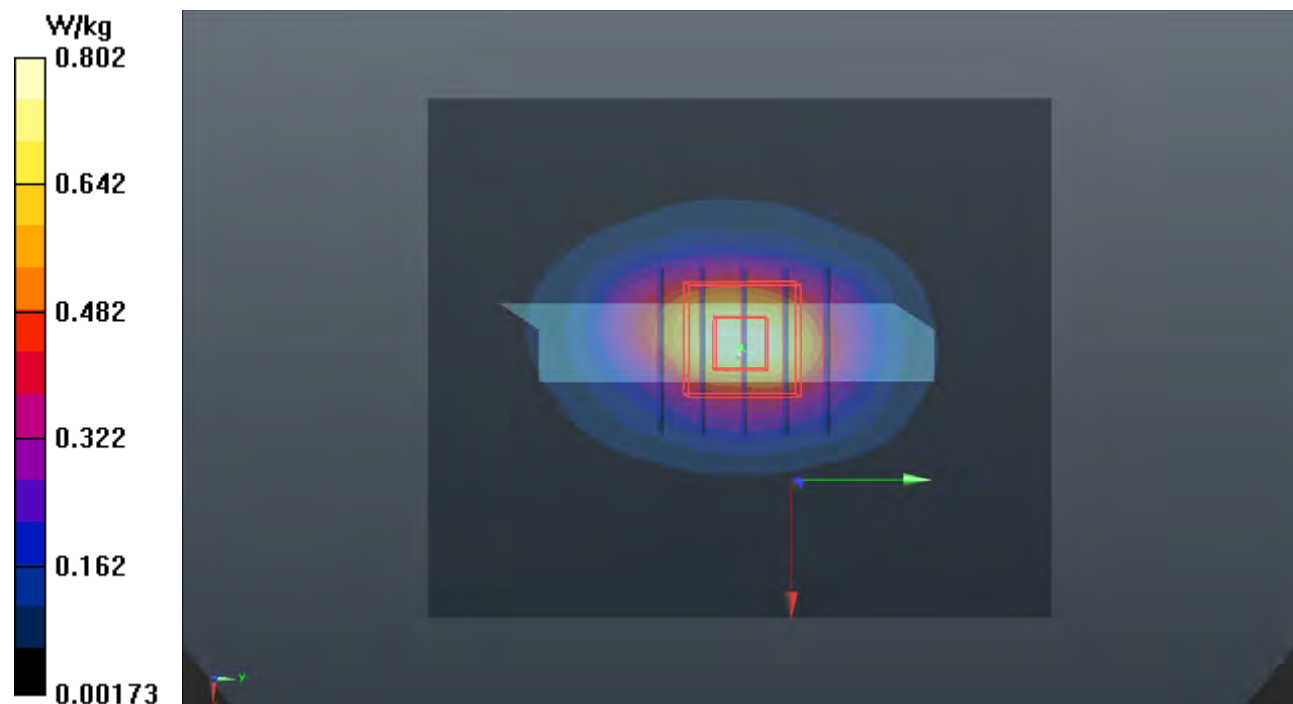

P32 WCDMA II_RMC12.2K_Bottom Side_10mm_Ch9538_Sample 1_Ant1

DUT: 190723C05

Communication System: WCDMA; Frequency: 1907.6 MHz; Duty Cycle: 1:1

Medium: H16T20N1_1007 Medium parameters used: $f = 1908$ MHz; $\sigma = 1.462$ S/m; $\epsilon_r = 40.475$; $\rho = 1000$ kg/m³

Ambient Temperature : 23.5 °C ; Liquid Temperature : 23.2 °C

DASY5 Configuration:

- Probe: EX3DV4 - SN7537; ConvF(8.13, 8.13, 8.13); Calibrated: 2019/06/18

- Sensor-Surface: 1.4mm (Mechanical Surface Detection)

- Electronics: DAE4 Sn1585; Calibrated: 2019/06/07

- Phantom: SAM Phantom_1982; Type: QD 000 P41 Ax; Serial: 1982

- Measurement SW: DASY52, Version 52.10 (2); SEMCAD X Version 14.6.12 (7470)

- **Area Scan (41x81x1)**: Interpolated grid: $dx=1.500$ mm, $dy=1.500$ mm

Maximum value of SAR (interpolated) = 1.27 W/kg

- **Zoom Scan (5x5x7)/Cube 0**: Measurement grid: $dx=8$ mm, $dy=8$ mm, $dz=5$ mm

Reference Value = 28.67 V/m; Power Drift = -0.01 dB

Peak SAR (extrapolated) = 1.52 W/kg

SAR(1 g) = 0.843 W/kg; SAR(10 g) = 0.449 W/kg

Maximum value of SAR (measured) = 1.28 W/kg

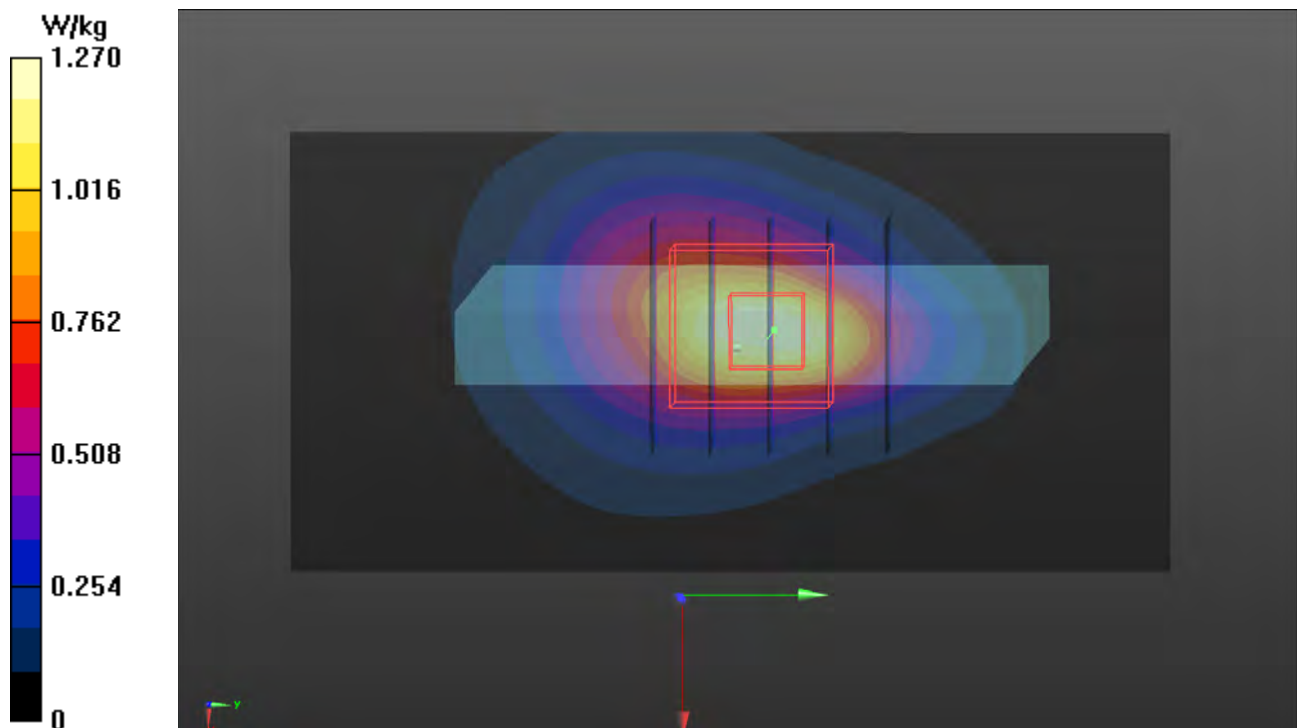

P33 WCDMA IV_RMC12.2K_Bottom Side_10mm_Ch1513_Sample 1_Ant1

DUT: 190723C05

Communication System: WCDMA; Frequency: 1752.6 MHz; Duty Cycle: 1:1

Medium: H16T20N1_1007 Medium parameters used: $f = 1753$ MHz; $\sigma = 1.327$ S/m; $\epsilon_r = 41.032$; $\rho = 1000$ kg/m³

Ambient Temperature : 23.5 °C ; Liquid Temperature : 23.2 °C

DASY5 Configuration:

- Probe: EX3DV4 - SN7537; ConvF(8.44, 8.44, 8.44); Calibrated: 2019/06/18
- Sensor-Surface: 1.4mm (Mechanical Surface Detection)
- Electronics: DAE4 Sn1585; Calibrated: 2019/06/07
- Phantom: SAM Phantom_1982; Type: QD 000 P41 Ax; Serial: 1982
- Measurement SW: DASY52, Version 52.10 (2); SEMCAD X Version 14.6.12 (7470)

- **Area Scan (41x81x1)**: Interpolated grid: dx=1.500 mm, dy=1.500 mm

Maximum value of SAR (interpolated) = 1.40 W/kg

- **Zoom Scan (5x5x7)/Cube 0**: Measurement grid: dx=8mm, dy=8mm, dz=5mm

Reference Value = 32.79 V/m; Power Drift = -0.04 dB

Peak SAR (extrapolated) = 1.61 W/kg

SAR(1 g) = 0.924 W/kg; SAR(10 g) = 0.489 W/kg

Maximum value of SAR (measured) = 1.36 W/kg

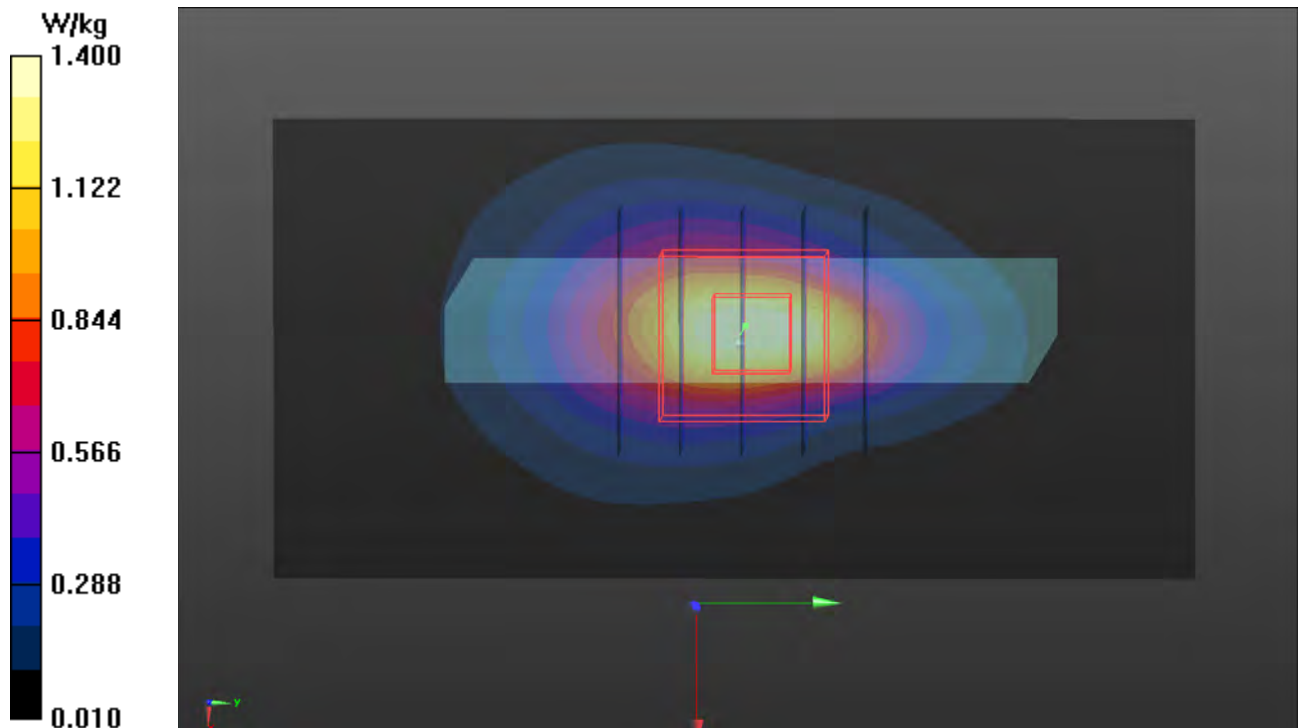

P34 LTE 2_QPSK20M_Bottom Side_10mm_Ch19100_1RB_OS0_Sample1_Ant1

DUT: 190723C05

Communication System: LTE; Frequency: 1900 MHz; Duty Cycle: 1:1
Medium: H16T20N2_0906 Medium parameters used: $f = 1900$ MHz; $\sigma = 1.46$ S/m; $\epsilon_r = 38.175$; $\rho = 1000$ kg/m³
Ambient Temperature : 23.6 °C ; Liquid Temperature : 23.2 °C

DASY5 Configuration:

- Probe: EX3DV4 - SN3650; ConvF(8.25, 8.25, 8.25); Calibrated: 2019/05/20
- Sensor-Surface: 1.4mm (Mechanical Surface Detection)
- Electronics: DAE4 Sn861; Calibrated: 2019/05/08
- Phantom: Twin SAM Phantom_1653; Type: QD000P40CD;
- Measurement SW: DASY52, Version 52.10 (2); SEMCAD X Version 14.6.12 (7470)

- **Area Scan (71x81x1):** Interpolated grid: dx=1.500 mm, dy=1.500 mm
Maximum value of SAR (interpolated) = 1.51 W/kg

- **Zoom Scan (5x5x7)/Cube 0:** Measurement grid: dx=8mm, dy=8mm, dz=5mm
Reference Value = 32.73 V/m; Power Drift = -0.10 dB
Peak SAR (extrapolated) = 1.90 W/kg
SAR(1 g) = 1.03 W/kg; SAR(10 g) = 0.530 W/kg
Maximum value of SAR (measured) = 1.54 W/kg

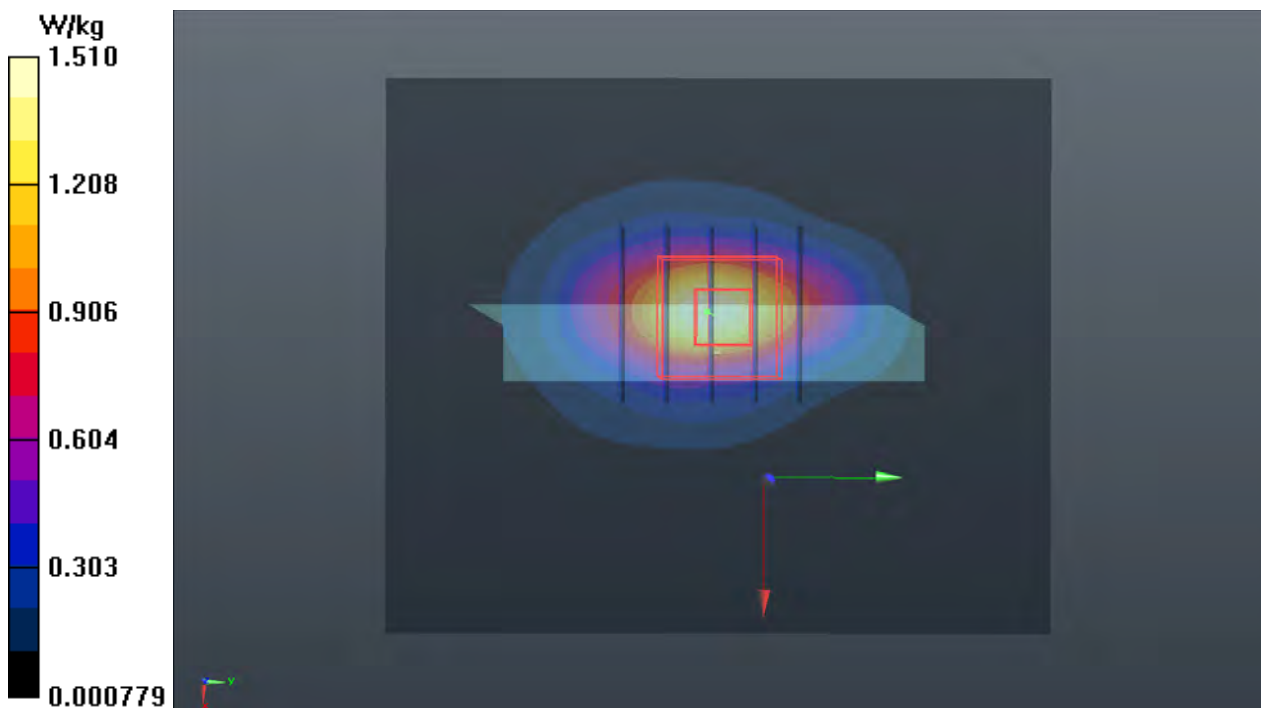

P35 LTE 4_QPSK20M_Bottom Side_10mm_Ch20300_1RB_OS50_Sample1_Ant1

DUT: 190723C05

Communication System: LTE; Frequency: 1745 MHz; Duty Cycle: 1:1

Medium: H16T20N1_1007 Medium parameters used: $f = 1745$ MHz; $\sigma = 1.319$ S/m; $\epsilon_r = 41.061$; $\rho = 1000$ kg/m³

Ambient Temperature : 23.5 °C ; Liquid Temperature : 23.2 °C

DASY5 Configuration:

- Probe: EX3DV4 - SN7537; ConvF(8.44, 8.44, 8.44); Calibrated: 2019/06/18
- Sensor-Surface: 1.4mm (Mechanical Surface Detection)
- Electronics: DAE4 Sn1585; Calibrated: 2019/06/07
- Phantom: SAM Phantom_1982; Type: QD 000 P41 Ax; Serial: 1982
- Measurement SW: DASY52, Version 52.10 (2); SEMCAD X Version 14.6.12 (7470)

- **Area Scan (41x81x1)**: Interpolated grid: dx=1.500 mm, dy=1.500 mm

Maximum value of SAR (interpolated) = 1.22 W/kg

- **Zoom Scan (5x5x7)/Cube 0**: Measurement grid: dx=8mm, dy=8mm, dz=5mm

Reference Value = 30.70 V/m; Power Drift = 0.02 dB

Peak SAR (extrapolated) = 1.41 W/kg

SAR(1 g) = 0.805 W/kg; SAR(10 g) = 0.428 W/kg

Maximum value of SAR (measured) = 1.17 W/kg

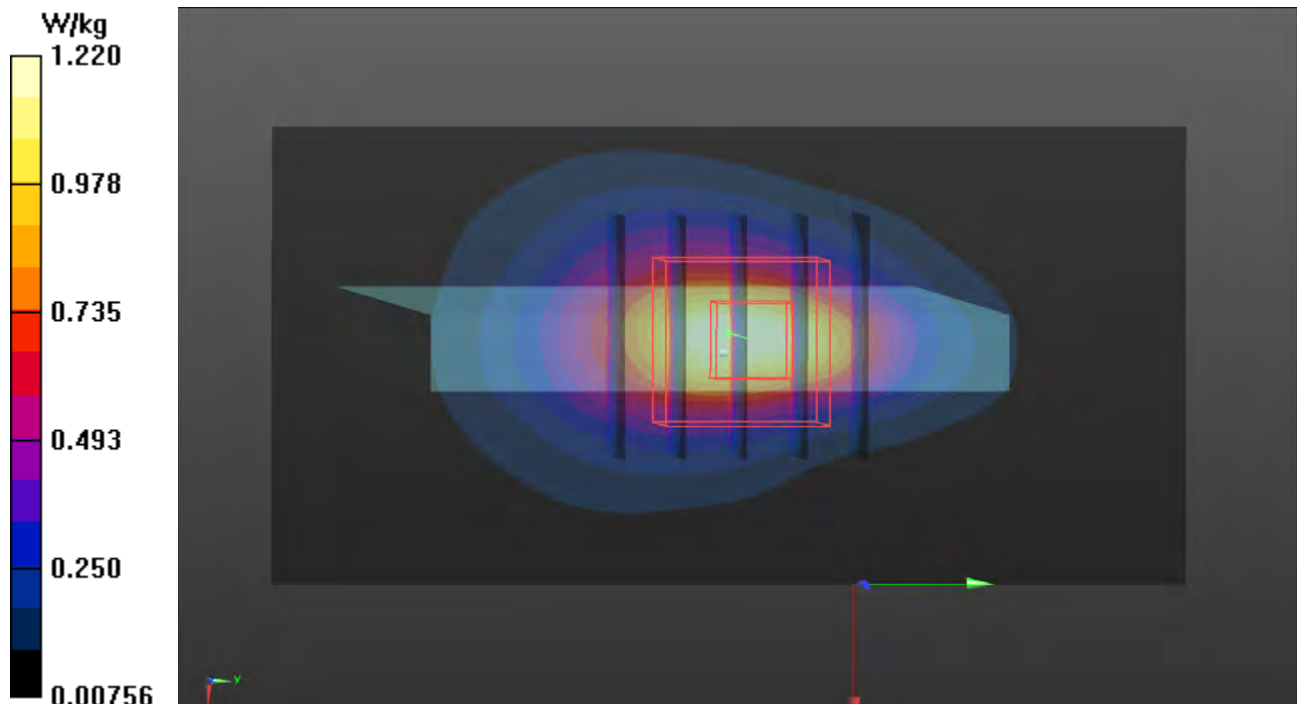

P26 WLAN5.2G_802.11a_Rear Face_10mm_Ch40_Sample1

DUT: 190723C05

Communication System: WLAN_5G; Frequency: 5200 MHz; Duty Cycle: 1:1.03
Medium: H34T60N3_0909 Medium parameters used: $f = 5200$ MHz; $\sigma = 4.622$ S/m; $\epsilon_r = 37.662$; $\rho = 1000$ kg/m³
Ambient Temperature : 23.4 °C ; Liquid Temperature : 23.1 °C

DASY5 Configuration:

- Probe: EX3DV4 - SN3650; ConvF(5.4, 5.4, 5.4); Calibrated: 2019/05/20
- Sensor-Surface: 1.4mm (Mechanical Surface Detection)
- Electronics: DAE4 Sn861; Calibrated: 2019/05/08
- Phantom: Twin SAM Phantom_1653; Type: QD000P40CD;
- Measurement SW: DASY52, Version 52.10 (2); SEMCAD X Version 14.6.12 (7470)

- **Area Scan (121x201x1)**: Interpolated grid: dx=1.000 mm, dy=1.000 mm
Maximum value of SAR (interpolated) = 0.408 W/kg

- **Zoom Scan (6x6x12)/Cube 0**: Measurement grid: dx=5mm, dy=5mm, dz=2mm
Reference Value = 9.863 V/m; Power Drift = -0.09 dB
Peak SAR (extrapolated) = 0.775 W/kg
SAR(1 g) = 0.221 W/kg; SAR(10 g) = 0.077 W/kg
Maximum value of SAR (measured) = 0.475 W/kg

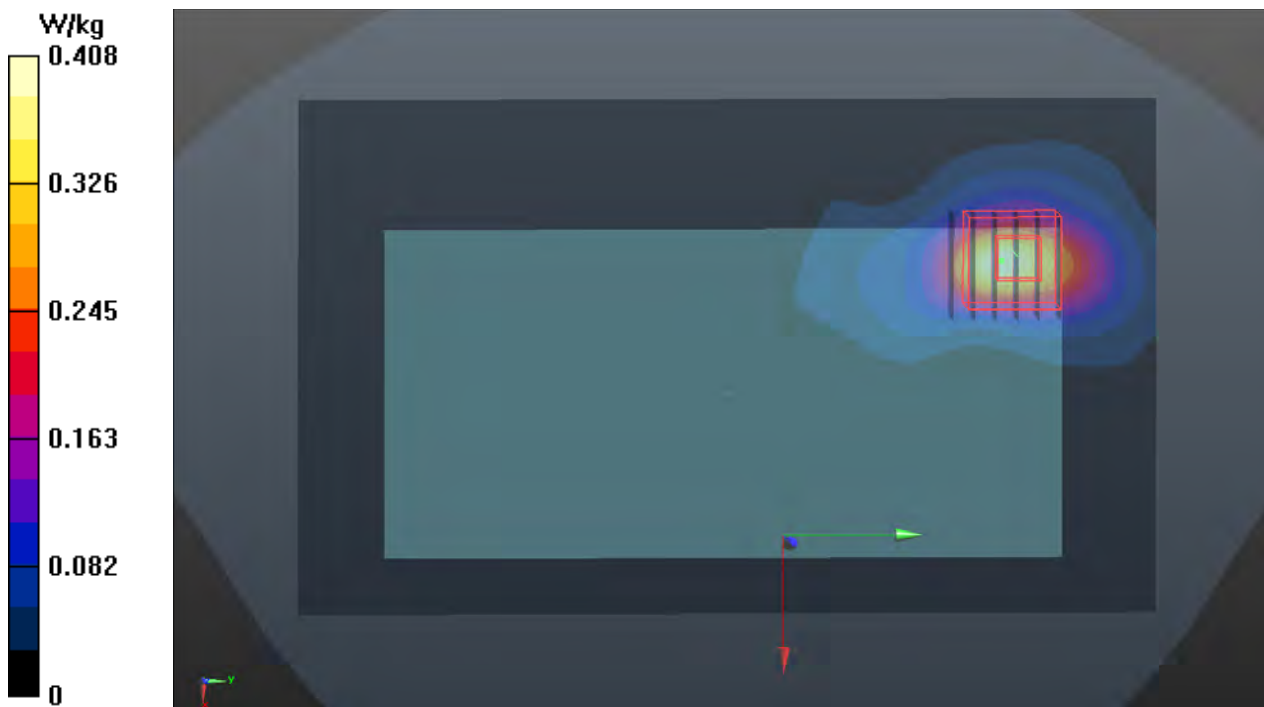

P36 BT_BDR_Top Side_10mm_Ch78_Sample1

DUT: 190723C05

Communication System: BT; Frequency: 2480 MHz; Duty Cycle: 1:1.31

Medium: H19T27N3_0909 Medium parameters used: $f = 2480$ MHz; $\sigma = 1.855$ S/m; $\epsilon_r = 38.824$; $\rho = 1000$ kg/m³

Ambient Temperature : 23.4 °C ; Liquid Temperature : 23.1 °C

DASY5 Configuration:

- Probe: EX3DV4 - SN3650; ConvF(7.63, 7.63, 7.63); Calibrated: 2019/05/20
- Sensor-Surface: 1.4mm (Mechanical Surface Detection)
- Electronics: DAE4 Sn861; Calibrated: 2019/05/08
- Phantom: Twin SAM Phantom_1653; Type: QD000P40CD;
- Measurement SW: DASY52, Version 52.10 (2); SEMCAD X Version 14.6.12 (7470)

- **Area Scan (71x101x1):** Interpolated grid: dx=1.200 mm, dy=1.200 mm

Maximum value of SAR (interpolated) = 0.0612 W/kg

- **Zoom Scan (5x5x7)/Cube 0:** Measurement grid: dx=8mm, dy=8mm, dz=5mm

Reference Value = 5.701 V/m; Power Drift = -0.15 dB

Peak SAR (extrapolated) = 0.0780 W/kg

SAR(1 g) = 0.036 W/kg; SAR(10 g) = 0.017 W/kg

Maximum value of SAR (measured) = 0.0618 W/kg

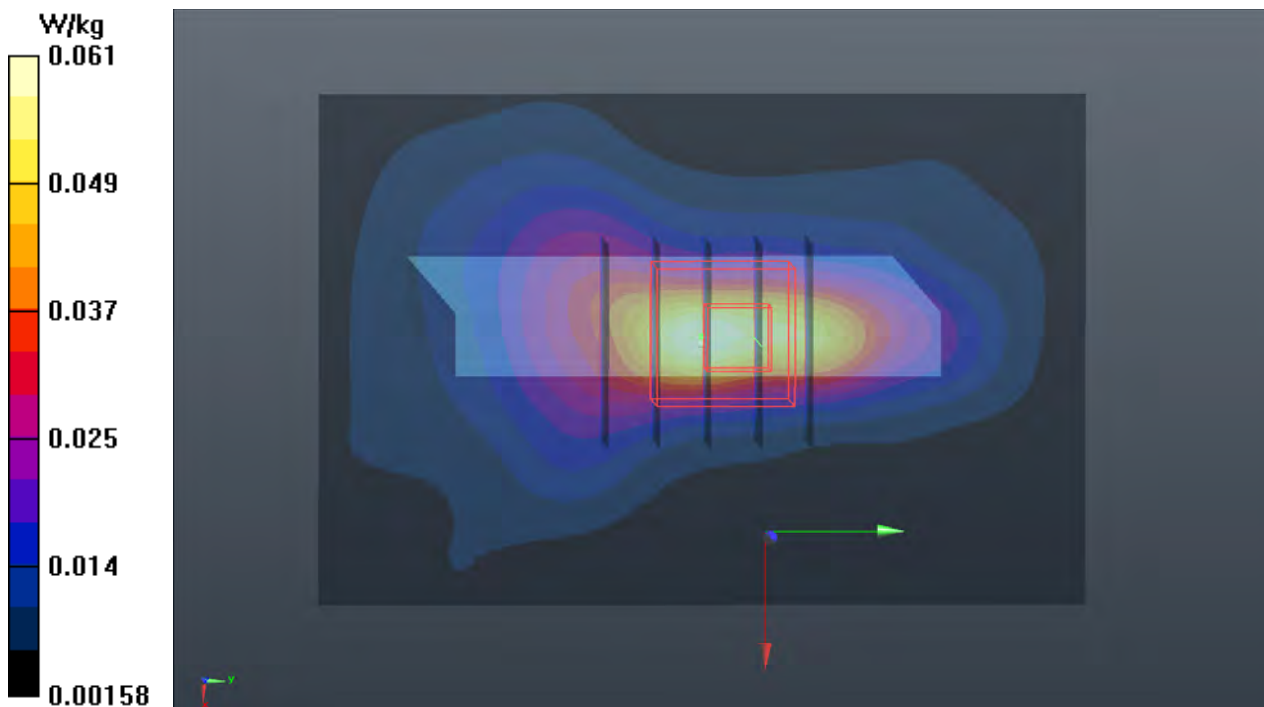

P37 WCDMA II_RMC12.2K_Rear Face_0mm_Ch9538_Sample1_Ant1

DUT: 190723C05

Communication System: WCDMA; Frequency: 1907.6 MHz; Duty Cycle: 1:1
Medium: H16T20N1_0907 Medium parameters used: $f = 1907.6$ MHz; $\sigma = 1.45$ S/m; $\epsilon_r = 38.285$; $\rho = 1000$ kg/m³
Ambient Temperature : 23.4 °C ; Liquid Temperature : 23.1 °C

DASY5 Configuration:

- Probe: EX3DV4 - SN3650; ConvF(8.25, 8.25, 8.25); Calibrated: 2019/05/20
- Sensor-Surface: 1.4mm (Mechanical Surface Detection)
- Electronics: DAE4 Sn861; Calibrated: 2019/05/08
- Phantom: Twin SAM Phantom_1653; Type: QD000P40CD;
- Measurement SW: DASY52, Version 52.10 (2); SEMCAD X Version 14.6.12 (7470)

- **Area Scan (71x141x1):** Interpolated grid: dx=1.500 mm, dy=1.500 mm
Maximum value of SAR (interpolated) = 9.55 W/kg

- **Zoom Scan (5x5x7)/Cube 0:** Measurement grid: dx=8mm, dy=8mm, dz=5mm
Reference Value = 74.93 V/m; Power Drift = 0.01 dB
Peak SAR (extrapolated) = 21.0 W/kg
SAR(1 g) = 5.27 W/kg; SAR(10 g) = 2.33 W/kg
Maximum value of SAR (measured) = 14.0 W/kg

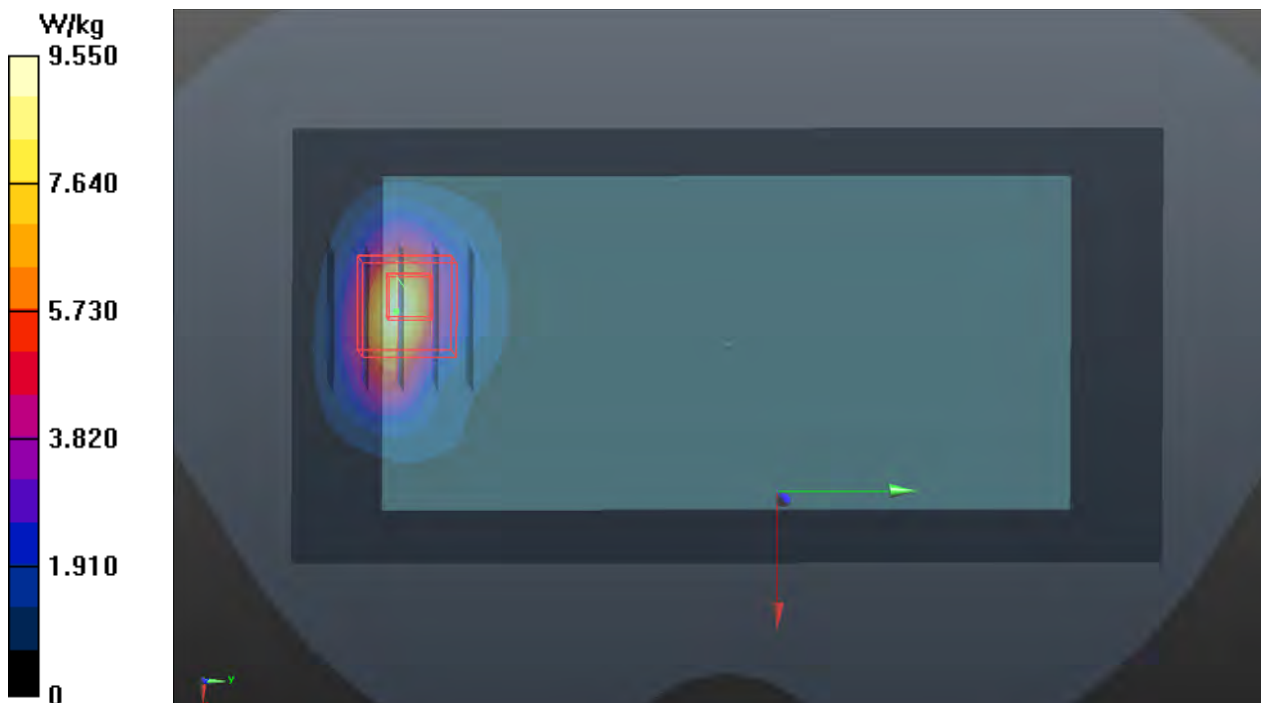

P38 WCDMA IV_RMC12.2K_Rear Face_0mm_Ch1312_Sample 1_Ant1

DUT: 190723C05

Communication System: WCDMA; Frequency: 1712.4 MHz; Duty Cycle: 1:1

Medium: H16T20N1_1008 Medium parameters used: $f = 1712.4$ MHz; $\sigma = 1.295$ S/m; $\epsilon_r = 39.985$; $\rho = 1000$ kg/m³

Ambient Temperature : 23.5 °C ; Liquid Temperature : 23.2 °C

DASY5 Configuration:

- Probe: EX3DV4 - SN7537; ConvF(8.44, 8.44, 8.44); Calibrated: 2019/06/18
- Sensor-Surface: 1.4mm (Mechanical Surface Detection)
- Electronics: DAE4 Sn1585; Calibrated: 2019/06/07
- Phantom: SAM Phantom_1982; Type: QD 000 P41 Ax; Serial: 1982
- Measurement SW: DASY52, Version 52.10 (2); SEMCAD X Version 14.6.12 (7470)

- **Area Scan (81x141x1)**: Interpolated grid: dx=1.500 mm, dy=1.500 mm
Maximum value of SAR (interpolated) = 5.08 W/kg

- **Zoom Scan (5x5x7)/Cube 0**: Measurement grid: dx=8mm, dy=8mm, dz=5mm
Reference Value = 56.52 V/m; Power Drift = -0.07 dB
Peak SAR (extrapolated) = 9.91 W/kg
SAR(1 g) = 4.51 W/kg; SAR(10 g) = 2.03 W/kg
Maximum value of SAR (measured) = 6.16 W/kg

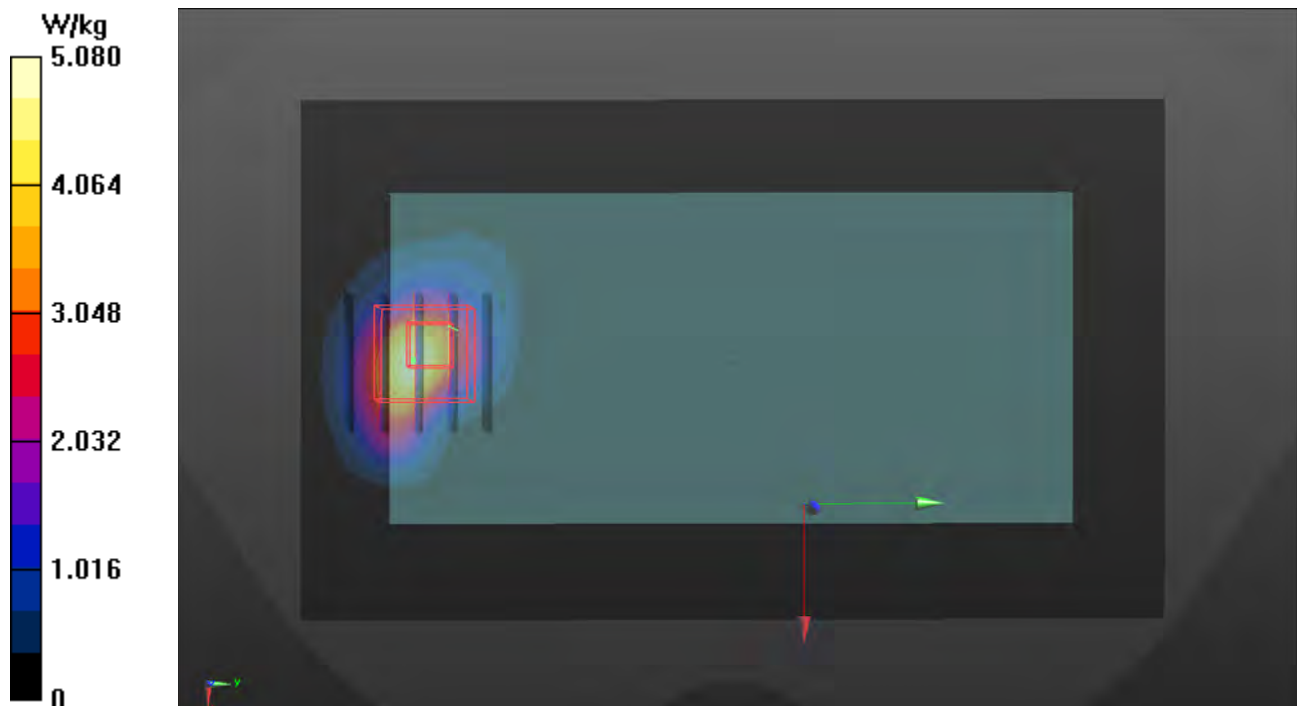

P39 LTE 2_QPSK20M_Rear Face_0mm_Ch19100_1RB_OS0_Sample1_Ant1

DUT: 190723C05

Communication System: LTE; Frequency: 1900 MHz; Duty Cycle: 1:1
Medium: H16T20N1_0907 Medium parameters used: $f = 1900$ MHz; $\sigma = 1.443$ S/m; $\epsilon_r = 38.307$; $\rho = 1000$ kg/m³
Ambient Temperature : 23.4 °C ; Liquid Temperature : 23.1 °C

DASY5 Configuration:

- Probe: EX3DV4 - SN3650; ConvF(8.25, 8.25, 8.25); Calibrated: 2019/05/20
- Sensor-Surface: 1.4mm (Mechanical Surface Detection)
- Electronics: DAE4 Sn861; Calibrated: 2019/05/08
- Phantom: Twin SAM Phantom_1653; Type: QD000P40CD;
- Measurement SW: DASY52, Version 52.10 (2); SEMCAD X Version 14.6.12 (7470)

- **Area Scan (71x141x1):** Interpolated grid: dx=1.500 mm, dy=1.500 mm
Maximum value of SAR (interpolated) = 8.38 W/kg

- **Zoom Scan (5x5x7)/Cube 0:** Measurement grid: dx=8mm, dy=8mm, dz=5mm
Reference Value = 72.88 V/m; Power Drift = 0.14 dB
Peak SAR (extrapolated) = 16.0 W/kg
SAR(1 g) = 6.44 W/kg; SAR(10 g) = 2.95 W/kg
Maximum value of SAR (measured) = 12.0 W/kg

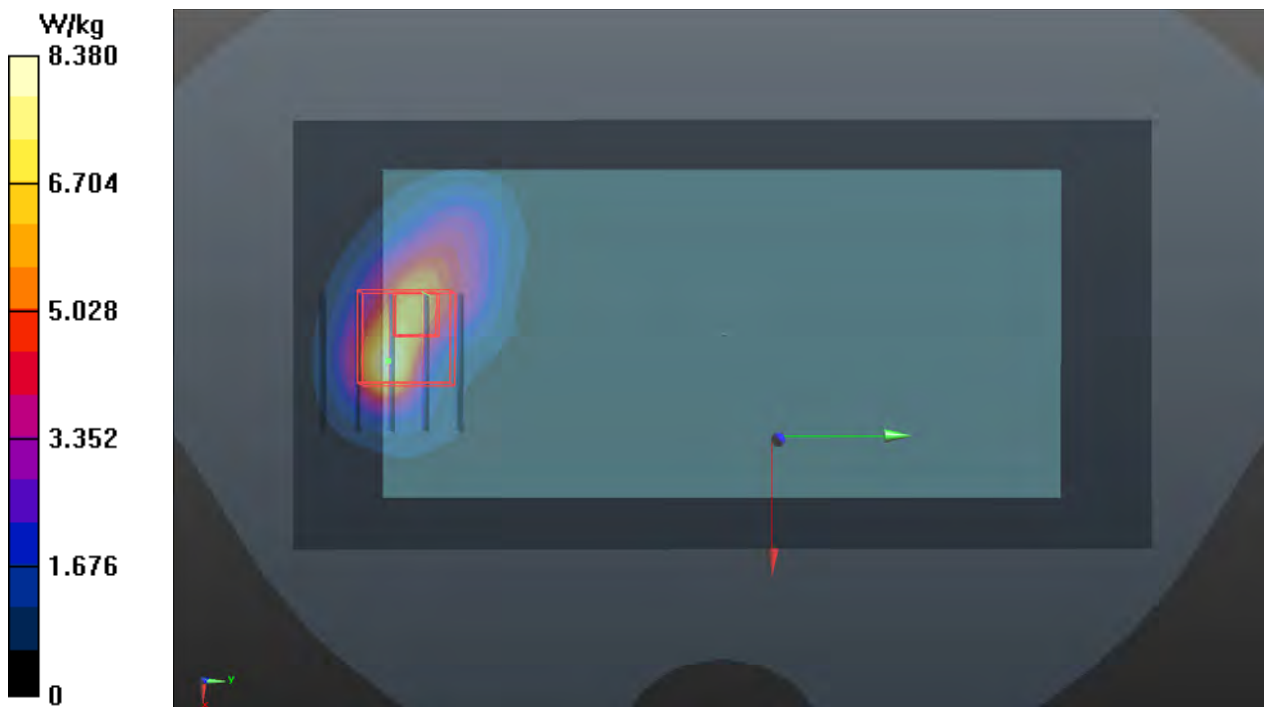

P40 LTE 4_QPSK20M_Rear Face_0mm_Ch20050_1RB_OS50_Sample 1_Ant1

DUT: 190723C05

Communication System: LTE; Frequency: 1720 MHz; Duty Cycle: 1:1

Medium: H16T20N1_1011 Medium parameters used: $f = 1720$ MHz; $\sigma = 1.302$ S/m; $\epsilon_r = 39.953$; $\rho = 1000$ kg/m³

Ambient Temperature : 23.5 °C ; Liquid Temperature : 23.2 °C

DASY5 Configuration:

- Probe: EX3DV4 - SN7537; ConvF(8.44, 8.44, 8.44); Calibrated: 2019/06/18
- Sensor-Surface: 1.4mm (Mechanical Surface Detection)
- Electronics: DAE4 Sn1585; Calibrated: 2019/06/07
- Phantom: SAM Phantom_1982; Type: QD 000 P41 Ax; Serial: 1982
- Measurement SW: DASY52, Version 52.10 (2); SEMCAD X Version 14.6.12 (7470)

- **Area Scan (81x141x1)**: Interpolated grid: dx=1.500 mm, dy=1.500 mm
 Maximum value of SAR (interpolated) = 4.82 W/kg

- **Zoom Scan (5x5x7)/Cube 0**: Measurement grid: dx=8mm, dy=8mm, dz=5mm
 Reference Value = 53.57 V/m; Power Drift = -0.07 dB
 Peak SAR (extrapolated) = 8.98 W/kg
SAR(1 g) = 4.15 W/kg; SAR(10 g) = 1.89 W/kg
 Maximum value of SAR (measured) = 6.13 W/kg

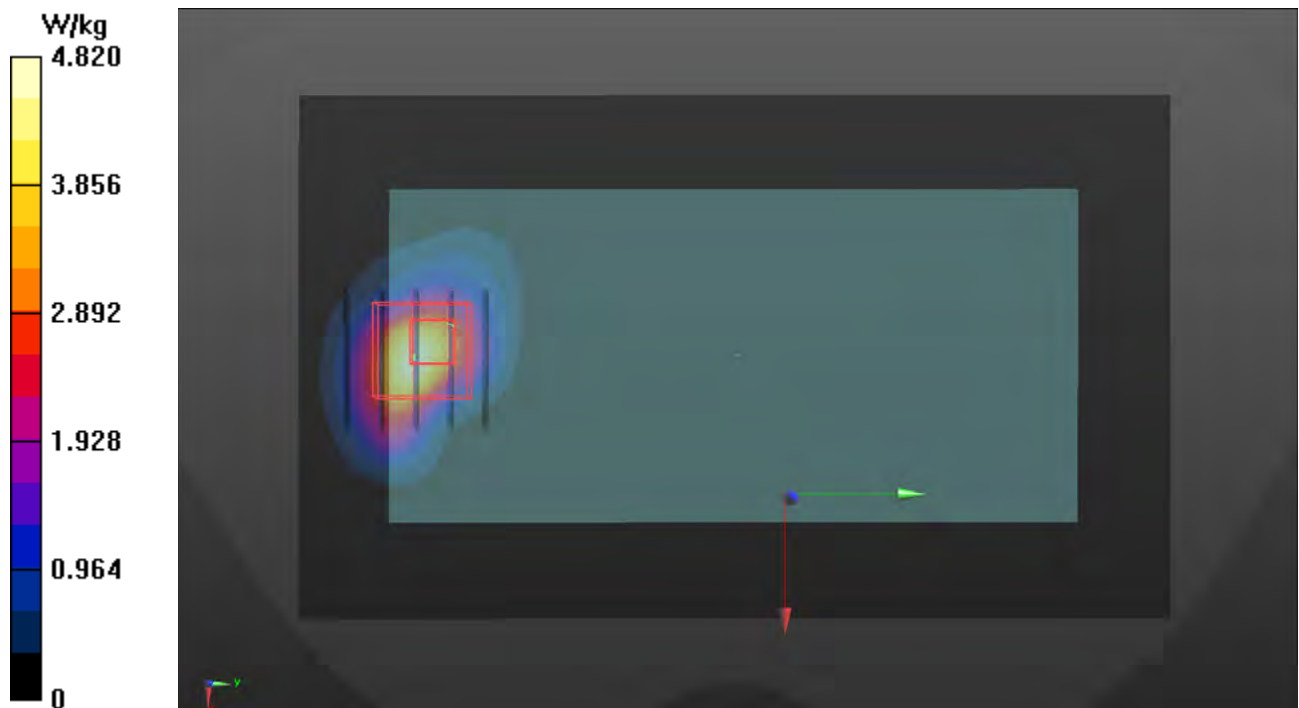

P41 WLAN5.3G_802.11a_Rear Face_0mm_Ch60_Sample1

DUT: 190723C05

Communication System: WLAN_5G; Frequency: 5300 MHz; Duty Cycle: 1:1.03
Medium: H34T60N1_0908 Medium parameters used: $f = 5300$ MHz; $\sigma = 4.792$ S/m; $\epsilon_r = 34.745$; $\rho = 1000$ kg/m³
Ambient Temperature : 23.4 °C ; Liquid Temperature : 23.1 °C

DASY5 Configuration:

- Probe: EX3DV4 - SN3650; ConvF(5.4, 5.4, 5.4); Calibrated: 2019/05/20
- Sensor-Surface: 1.4mm (Mechanical Surface Detection)
- Electronics: DAE4 Sn861; Calibrated: 2019/05/08
- Phantom: Twin SAM Phantom_1653; Type: QD000P40CD;
- Measurement SW: DASY52, Version 52.10 (2); SEMCAD X Version 14.6.12 (7470)

- **Area Scan (101x201x1):** Interpolated grid: dx=1.000 mm, dy=1.000 mm
Maximum value of SAR (interpolated) = 1.59 W/kg

- **Zoom Scan (6x6x12)/Cube 0:** Measurement grid: dx=5mm, dy=5mm, dz=2mm
Reference Value = 18.29 V/m; Power Drift = 0.03 dB
Peak SAR (extrapolated) = 7.82 W/kg
SAR(1 g) = 1.57 W/kg; SAR(10 g) = 0.411 W/kg
Maximum value of SAR (measured) = 4.26 W/kg

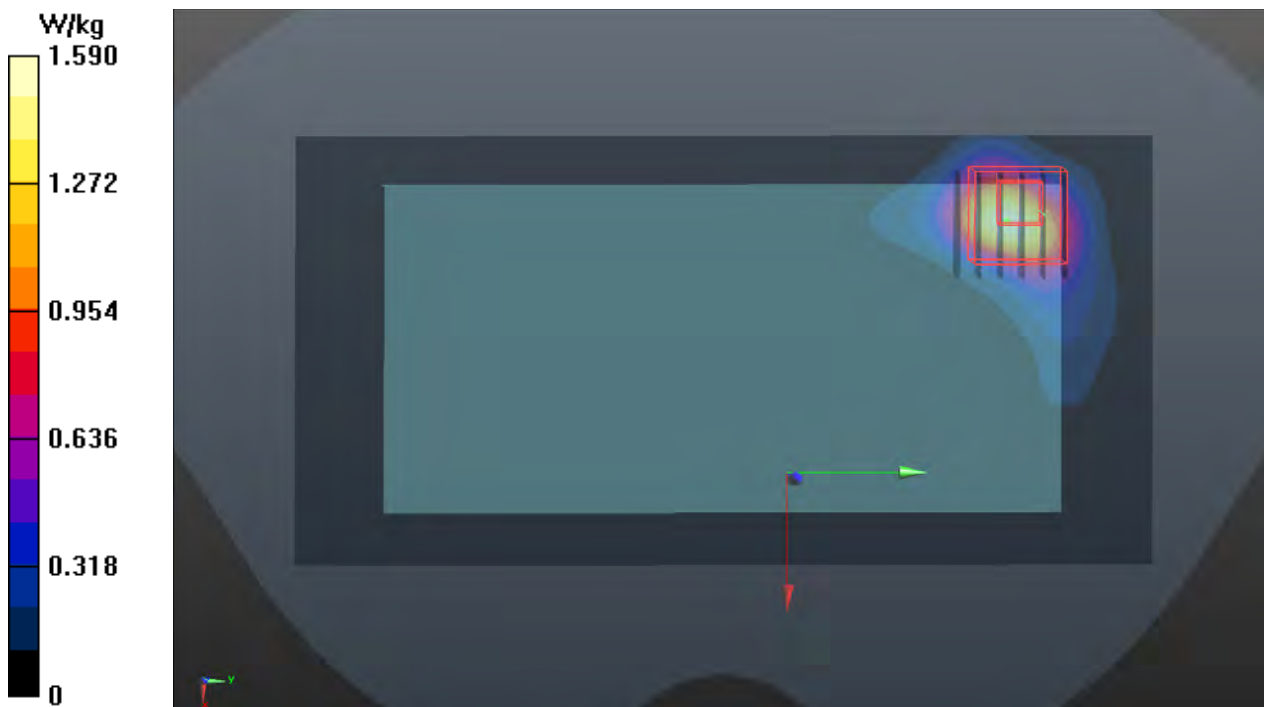

P42 WLAN5.6G_802.11a_Rear Face_0mm_Ch140_Sample1

DUT: 190723C05

Communication System: WLAN_5G; Frequency: 5700 MHz; Duty Cycle: 1:1.03

Medium: H34T60N1_0908 Medium parameters used: $f = 5700$ MHz; $\sigma = 5.229$ S/m; $\epsilon_r = 34.06$; $\rho = 1000$ kg/m³

Ambient Temperature : 23.4 °C ; Liquid Temperature : 23.1 °C

DASY5 Configuration:

- Probe: EX3DV4 - SN3650; ConvF(5.17, 5.17, 5.17); Calibrated: 2019/05/20
- Sensor-Surface: 1.4mm (Mechanical Surface Detection)
- Electronics: DAE4 Sn861; Calibrated: 2019/05/08
- Phantom: Twin SAM Phantom_1653; Type: QD000P40CD;
- Measurement SW: DASY52, Version 52.10 (2); SEMCAD X Version 14.6.12 (7470)

- **Area Scan (101x201x1):** Interpolated grid: dx=1.000 mm, dy=1.000 mm
Maximum value of SAR (interpolated) = 1.83 W/kg

- **Zoom Scan (6x6x12)/Cube 0:** Measurement grid: dx=5mm, dy=5mm, dz=2mm
Reference Value = 20.36 V/m; Power Drift = 0.09 dB

Peak SAR (extrapolated) = 11.9 W/kg

SAR(1 g) = 1.74 W/kg; SAR(10 g) = 0.476 W/kg

Maximum value of SAR (measured) = 6.62 W/kg

