

## FCC Test Report

**Report No.:** RF190723C05-2

**FCC ID:** ZL5S52E

**Test Model:** S52

**Received Date:** Jul. 23, 2019

**Test Date:** Aug. 12 ~ Sep. 12, 2019

**Issued Date:** Oct. 05, 2019

**Applicant:** Bullitt Group

**Address:** One Valpy, Valpy Street, Reading, RG1 1AR, Berkshire, UK

**Issued By:** Bureau Veritas Consumer Products Services (H.K.) Ltd., Taoyuan Branch  
Lin Kou Laboratories

**Lab Address:** No. 47-2, 14th Ling, Chia Pau Vil., Lin Kou Dist., New Taipei City, Taiwan

**Test Location:** No.19, Hwa Ya 2nd Rd., Wen Hwa Vil., Kwei Shan Dist., Taoyuan City  
33383, Taiwan

**FCC Registration /  
Designation Number:** 788550 / TW0003



This report is for your exclusive use. Any copying or replication of this report to or for any other person or entity, or use of our name or trademark, is permitted only with our prior written permission. This report sets forth our findings solely with respect to the test samples identified herein. The results set forth in this report are not indicative or representative of the quality or characteristics of the lot from which a test sample was taken or any similar or identical product unless specifically and expressly noted. Our report includes all of the tests requested by you and the results thereof based upon the information that you provided to us. You have 60 days from date of issuance of this report to notify us of any material error or omission caused by our negligence, provided, however, that such notice shall be in writing and shall specifically address the issue you wish to raise. A failure to raise such issue within the prescribed time shall constitute your unqualified acceptance of the completeness of this report, the tests conducted and the correctness of the report contents. Unless specific mention, the uncertainty of measurement has been explicitly taken into account to declare the compliance or non-compliance to the specification. The report must not be used by the client to claim product certification, approval, or endorsement by TAF or any government agencies.

## Table of Contents

<b>Release Control Record .....</b>	<b>4</b>
<b>1 Certificate of Conformity .....</b>	<b>5</b>
<b>2 Summary of Test Results.....</b>	<b>6</b>
2.1 Measurement Uncertainty.....	6
2.2 Modification Record .....	6
<b>3 General Information .....</b>	<b>7</b>
3.1 General Description of EUT .....	7
3.2 Description of Test Modes.....	8
3.2.1 Test Mode Applicability and Tested Channel Detail.....	9
3.3 Duty Cycle of Test Signal .....	11
3.4 Description of Support Units .....	12
3.4.1 Configuration of System under Test .....	12
3.5 General Description of Applied Standards.....	12
<b>4 Test Types and Results .....</b>	<b>13</b>
4.1 Radiated Emission and Bandedge Measurement .....	13
4.1.1 Limits of Radiated Emission and Bandedge Measurement .....	13
4.1.2 Test Instruments .....	14
4.1.3 Test Procedures.....	15
4.1.4 Deviation from Test Standard .....	16
4.1.5 Test Set Up .....	16
4.1.6 EUT Operating Conditions.....	17
4.1.7 Test Results .....	18
4.2 Conducted Emission Measurement.....	32
4.2.1 Limits of Conducted Emission Measurement .....	32
4.2.2 Test Instruments .....	32
4.2.3 Test Procedures.....	33
4.2.4 Deviation from Test Standard .....	33
4.2.5 Test Setup.....	33
4.2.6 EUT Operating Conditions.....	33
4.2.7 Test Results .....	34
4.3 6 dB Bandwidth Measurement.....	36
4.3.1 Limits of 6 dB Bandwidth Measurement.....	36
4.3.2 Test Setup.....	36
4.3.3 Test Instruments .....	36
4.3.4 Test Procedure .....	36
4.3.5 Deviation from Test Standard .....	36
4.3.6 EUT Operating Conditions.....	36
4.3.7 Test Results .....	37
4.4 Occupied Bandwidth Measurement.....	39
4.4.1 Test Setup.....	39
4.4.2 Test Instruments .....	39
4.4.3 Test Procedure .....	39
4.4.4 Deviation from Test Standard .....	39
4.4.5 EUT Operating Conditions.....	39
4.4.6 Test Results .....	40
4.5 Conducted Output Power Measurement .....	42
4.5.1 Limits of Conducted Output Power Measurement.....	42
4.5.2 Test Setup.....	42
4.5.3 Test Instruments .....	42
4.5.4 Test Procedures.....	42
4.5.5 Deviation from Test Standard .....	42
4.5.6 EUT Operating Conditions.....	42
4.5.7 Test Results .....	43

4.6	Power Spectral Density Measurement .....	44
4.6.1	Limits of Power Spectral Density Measurement.....	44
4.6.2	Test Setup.....	44
4.6.3	Test Instruments .....	44
4.6.4	Test Procedure .....	44
4.6.5	Deviation from Test Standard .....	44
4.6.6	EUT Operating Condition .....	44
4.6.7	Test Results .....	45
4.7	Conducted Out of Band Emission Measurement .....	47
4.7.1	Limits of Conducted Out of Band Emission Measurement.....	47
4.7.2	Test Setup.....	47
4.7.3	Test Instruments .....	47
4.7.4	Test Procedure .....	47
4.7.5	Deviation from Test Standard .....	47
4.7.6	EUT Operating Condition .....	47
4.7.7	Test Results .....	48
<b>5</b>	<b>Pictures of Test Arrangements.....</b>	<b>52</b>
	<b>Appendix – Information of the Testing Laboratories .....</b>	<b>53</b>

### Release Control Record

Issue No.	Description	Date Issued
RF190723C05-2	Original Release	Oct. 05, 2019

## 1 Certificate of Conformity

**Product:** Rugged Smart Phone

**Brand:** CAT

**Test Model:** S52

**Sample Status:** Identical Prototype

**Applicant:** Bullitt Group

**Test Date:** Aug. 12 ~ Sep. 12, 2019

**Standards:** 47 CFR FCC Part 15, Subpart C (Section 15.247)  
ANSI C63.10:2013

The above equipment has been tested by **Bureau Veritas Consumer Products Services (H.K.) Ltd., Taoyuan Branch**, and found compliance with the requirement of the above standards. The test record, data evaluation & Equipment Under Test (EUT) configurations represented herein are true and accurate accounts of the measurements of the sample's RF characteristics under the conditions specified in this report.

**Prepared by :** Gina Liu, **Date:** Oct. 05, 2019  
Gina Liu / Specialist

**Approved by :** Dylan Chiou, **Date:** Oct. 05, 2019  
Dylan Chiou / Project Engineer

## 2 Summary of Test Results

47 CFR FCC Part 15, Subpart C (Section 15.247)			
FCC Clause	Test Item	Result	Remarks
15.207	AC Power Conducted Emission	Pass	Meet the requirement of limit. Minimum passing margin is -18.56 dB at 0.45097 MHz.
15.205 / 15.209 / 15.247(d)	Radiated Emissions and Band Edge Measurement	Pass	Meet the requirement of limit. Minimum passing margin is -0.37 dB at 2389.94 MHz.
15.247(d)	Antenna Port Emission	Pass	Meet the requirement of limit.
15.247(a)(2)	6 dB Bandwidth	Pass	Meet the requirement of limit.
---	Occupied Bandwidth Measurement	Pass	Reference only
15.247(b)	Conducted power	Pass	Meet the requirement of limit.
15.247(e)	Power Spectral Density	Pass	Meet the requirement of limit.
15.203	Antenna Requirement	Pass	No antenna connector is used.

Note: Determining compliance based on the results of the compliance measurement, not taking into account measurement instrumentation uncertainty.

### 2.1 Measurement Uncertainty

Where relevant, the following measurement uncertainty levels have been estimated for tests performed on the EUT as specified in CISPR 16-4-2:

Measurement	Frequency	Expanded Uncertainty (k=2) (±)
Conducted Emissions at mains ports	150 kHz ~ 30 MHz	2.94 dB
Radiated Emissions up to 1 GHz	9 kHz ~ 30 MHz	3.04 dB
	30 MHz ~ 200 MHz	2.93 dB
	200 MHz ~ 1000 MHz	2.95 dB
Radiated Emissions above 1 GHz	1 GHz ~ 18 GHz	2.26 dB
	18 GHz ~ 40 GHz	1.94 dB

### 2.2 Modification Record

There were no modifications required for compliance.

### 3 General Information

#### 3.1 General Description of EUT

<b>Product</b>	Rugged Smart Phone
<b>Brand</b>	CAT
<b>Test Model</b>	S52
<b>Status of EUT</b>	Identical Prototype
<b>Power Supply Rating</b>	5-8 Vdc / 8.5-10 Vdc / 10-12 Vdc (adapter 1) 5.0 Vdc / 9.0 Vdc / 12.0 Vdc (adapter 2) 3.8 Vdc (Li-ion battery)
<b>Modulation Type</b>	CCK, DQPSK, DBPSK for DSSS 64QAM, 16QAM, QPSK, BPSK for OFDM
<b>Modulation Technology</b>	DSSS, OFDM
<b>Transfer Rate</b>	802.11b: 11.0 / 5.5 / 2.0 / 1.0 Mbps 802.11g: 54.0 / 48.0 / 36.0 / 24.0 / 18.0 / 12.0 / 9.0 / 6.0 Mbps 802.11n: up to 150 Mbps 802.11ac: up to 200 Mbps
<b>Operating Frequency</b>	2412 ~ 2462 MHz
<b>Number of Channel</b>	11 for 802.11b, 802.11g, 802.11n (HT20), 802.11ac (VHT20) 7 for 802.11n (HT40), 802.11ac (VHT40)
<b>Output Power</b>	245.471 mW
<b>Antenna Type</b>	Loop antenna with -6.5 dBi gain
<b>Antenna Connector</b>	N/A
<b>Accessory Device</b>	Refer to Note as below
<b>Data Cable Supplied</b>	Refer to Note as below

Note:

- The EUT details of the sample are as follows.

Sample	Description
DS	Dual SIM
SS	Single SIM

\* The samples have the same layout, circuit, and components, but different SIM tray.

After pre-tested with the EUT, only the worst sample (Dual SIM) was chosen for the final test.

- The EUT incorporates a SISO function. Physically, the EUT provides one completed transmitter and one receiver.

Modulation Mode	TX Function
802.11b	1TX (SISO)
802.11g	1TX (SISO)
802.11n (HT20)	1TX (SISO)
802.11n (HT40)	1TX (SISO)
802.11ac (VHT20)	1TX (SISO)
802.11ac (VHT40)	1TX (SISO)

\* The modulation and bandwidth are similar for 802.11n mode for HT20 / HT40 and 802.11ac mode for VHT20 / VHT40, therefore investigated worst case to representative mode in test report. (Final test mode refer section 3.2.1)

3. The EUT contains following accessory devices.

Product	Manufacture	Model	Description
Adapter 1	Lucent Trans Electronics Co., LTD.	1M52	I/P: 100-240 Vac, 50-60 Hz, 500 mA O/P: 5Vdc-8Vdc, 2.0A / 8.5Vdc-10Vdc, 1.7A / 10Vdc-12Vdc, 1.5A
Adapter 2	Jiangsu Chenyang Electron Co., LTD.	CK18W02U	I/P: 100-240 Vac, 50-60 Hz, 500 mA O/P: 5 Vdc, 3.0A / 9Vdc, 2.0A / 12Vdc, 1.5A
Battery	Apack Technology Co., LTD.	APP00307	3.8 Vdc, 3000 mAh
Earphone	Ganet Global LTD.	HF-AC04D-03 HF	1.2m non-shielded cable with core
USB Cable	Saibao (Jiangxi) Communication Industrial Co., LTD.	SRB-A001A	1.2m shielded cable with core

4. The above EUT information is declared by manufacturer and for more detailed features description, please refers to the manufacturer's specifications or user's manual.

### 3.2 Description of Test Modes

11 channels are provided for 802.11b, 802.11g, 802.11n (HT20) and 802.11ac (VHT20):

Channel	Frequency (MHz)	Channel	Frequency (MHz)
1	2412	7	2442
2	2417	8	2447
3	2422	9	2452
4	2427	10	2457
5	2432	11	2462
6	2437		

7 channels are provided for 802.11n (HT40) and 802.11ac (VHT40):

Channel	Frequency (MHz)	Channel	Frequency (MHz)
3	2422	7	2442
4	2427	8	2447
5	2432	9	2452
6	2437		



### 3.2.1 Test Mode Applicability and Tested Channel Detail

EUT Configure Mode	Applicable To				Description
	RE≥1G	RE<1G	PLC	APCM	
-	√	√	√	√	-

Where **RE≥1G**: Radiated Emission above 1 GHz      **RE<1G**: Radiated Emission below 1 GHz  
**PLC**: Power Line Conducted Emission      **APCM**: Antenna Port Conducted Measurement

**NOTE:** The EUT had been pre-tested on the positioned of each 3 axis. The worst case was found when positioned on **X-plane**.

#### **Radiated Emission Test (Above 1 GHz):**

- Pre-Scan has been conducted to determine the worst-case mode from all possible combinations between available modulations, data rates and antenna ports (if EUT with antenna diversity architecture).
- Following channel(s) was (were) selected for the final test as listed below.

EUT Configure Mode	Mode	Available Channel	Tested Channel	Modulation Technology	Modulation Type	Data Rate (Mbps)
-	802.11b	1 to 11	1, 6, 11	DSSS	DBPSK	1.0
-	802.11g	1 to 11	1, 6, 11	OFDM	BPSK	6.0
-	802.11n (HT20)	1 to 11	1, 6, 11	OFDM	BPSK	6.5
-	802.11n (HT40)	3 to 9	3, 6, 9	OFDM	BPSK	13.5

#### **Radiated Emission Test (Below 1 GHz):**

- Pre-Scan has been conducted to determine the worst-case mode from all possible combinations between available modulations, data rates and antenna ports (if EUT with antenna diversity architecture).
- Following channel(s) was (were) selected for the final test as listed below.

EUT Configure Mode	Mode	Available Channel	Tested Channel	Modulation Technology	Modulation Type	Data Rate (Mbps)
-	802.11g	1 to 11	1	OFDM	BPSK	6.0

#### **Power Line Conducted Emission Test:**

- Pre-Scan has been conducted to determine the worst-case mode from all possible combinations between available modulations, data rates and antenna ports (if EUT with antenna diversity architecture).
- Following channel(s) was (were) selected for the final test as listed below.

EUT Configure Mode	Mode	Available Channel	Tested Channel	Modulation Technology	Modulation Type	Data Rate (Mbps)
-	802.11g	1 to 11	1	OFDM	BPSK	6.0

### **Bandedge Measurement:**

- Pre-Scan has been conducted to determine the worst-case mode from all possible combinations between available modulations, data rates and antenna ports (if EUT with antenna diversity architecture).
- Following channel(s) was (were) selected for the final test as listed below.

EUT Configure Mode	Mode	Available Channel	Tested Channel	Modulation Technology	Modulation Type	Data Rate (Mbps)
-	802.11b	1 to 11	1, 11	DSSS	DBPSK	1.0
-	802.11g	1 to 11	1, 11	OFDM	BPSK	6.0
-	802.11n (HT20)	1 to 11	1, 11	OFDM	BPSK	6.5
-	802.11n (HT40)	3 to 9	3, 9	OFDM	BPSK	13.5

### **Antenna Port Conducted Measurement:**

- This item includes all test value of each mode, but only includes spectrum plot of worst value of each mode.
- Pre-Scan has been conducted to determine the worst-case mode from all possible combinations between available modulations, data rates and antenna ports (if EUT with antenna diversity architecture).
- Following channel(s) was (were) selected for the final test as listed below.

EUT Configure Mode	Mode	Available Channel	Tested Channel	Modulation Technology	Modulation Type	Data Rate (Mbps)
-	802.11b	1 to 11	1, 6, 11	DSSS	DBPSK	1.0
-	802.11g	1 to 11	1, 6, 11	OFDM	BPSK	6.0
-	802.11n (HT20)	1 to 11	1, 6, 11	OFDM	BPSK	6.5
-	802.11n (HT40)	3 to 9	3, 6, 9	OFDM	BPSK	13.5

### **Test Condition:**

Applicable To	Environmental Conditions	Input Power	Tested by
RE $\geq$ 1G	25 deg. C, 65 % RH	120 Vac, 60 Hz	Thomas Wei
RE<1G	25 deg. C, 65 % RH	120 Vac, 60 Hz	Thomas Wei
PLC	25 deg. C, 65 % RH	120 Vac, 60 Hz	Thomas Wei
APCM	25 deg. C, 65 % RH	3.8 Vdc	Gavin Wu

### 3.3 Duty Cycle of Test Signal

**802.11b:** Duty cycle of test signal is  $\geq 98\%$ , duty factor is not required.

**802.11g:** Duty cycle =  $1.391/1.436 = 0.969$ , Duty factor =  $10 * \log(1/0.969) = 0.14$

**802.11n (HT20):** Duty cycle =  $1.287/1.333 = 0.965$ , Duty factor =  $10 * \log(1/0.965) = 0.15$

**802.11n (HT40):** Duty cycle =  $0.634/0.679 = 0.934$ , Duty factor =  $10 * \log(1/0.934) = 0.30$

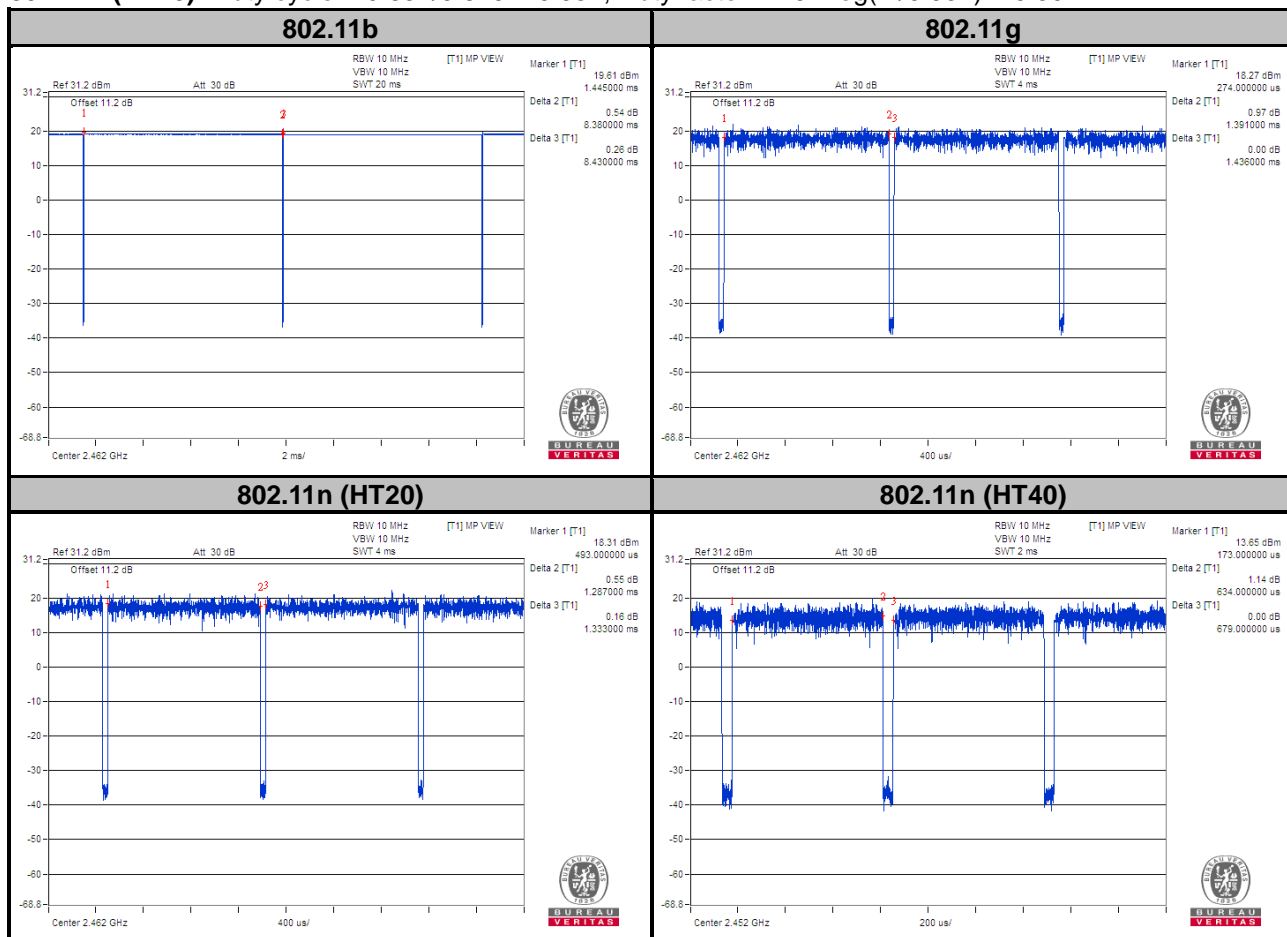

### 3.4 Description of Support Units

The EUT has been tested as an independent unit together with other necessary accessories or support units.

#### 3.4.1 Configuration of System under Test

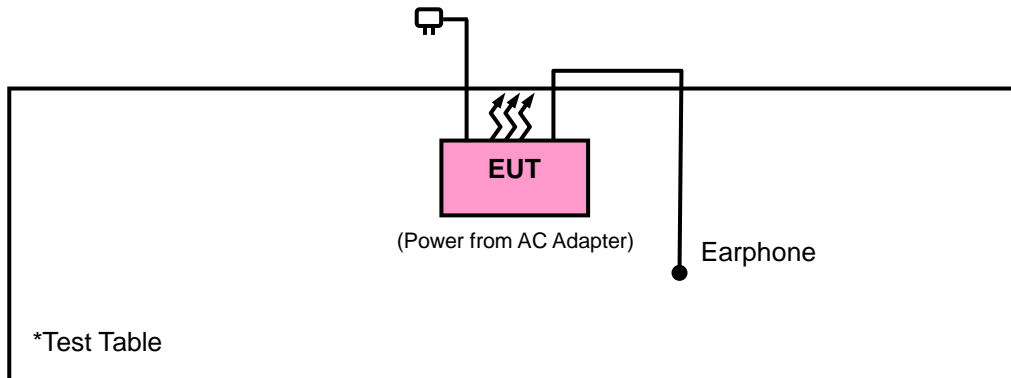

### 3.5 General Description of Applied Standards

The EUT is a RF Product. According to the specifications of the manufacturer, it must comply with the requirements of the following standards:

**FCC Part 15, Subpart C (15.247)**

**KDB 558074 D01 15.247 Meas Guidance v05r02**

ANSI C63.10-2013

All test items have been performed and recorded as per the above standards.

## 4 Test Types and Results

### 4.1 Radiated Emission and Bandedge Measurement

#### 4.1.1 Limits of Radiated Emission and Bandedge Measurement

Radiated emissions which fall in the restricted bands must comply with the radiated emission limits specified as below table. Other emissions shall be at least 20 dB below the highest level of the desired power:

Frequencies (MHz)	Field Strength (microvolts/meter)	Measurement Distance (meters)
0.009 ~ 0.490	2400/F (kHz)	300
0.490 ~ 1.705	24000/F (kHz)	30
1.705 ~ 30.0	30	30
30 ~ 88	100	3
88 ~ 216	150	3
216 ~ 960	200	3
Above 960	500	3

**NOTE:**

1. The lower limit shall apply at the transition frequencies.
2. Emission level (dBuV/m) = 20 log Emission level (uV/m).
3. For frequencies above 1000 MHz, the field strength limits are based on average detector, however, the peak field strength of any emission shall not exceed the maximum permitted average limits, specified above by more than 20 dB under any condition of modulation.

#### 4.1.2 Test Instruments

Description & Manufacturer	Model No.	Serial No.	Date of Calibration	Due Date of Calibration
Test Receiver Agilent	N9038A	MY51210203	Mar. 18, 2019	Mar. 17, 2020
Spectrum Analyzer Agilent	N9010A	MY52220314	Dec. 13, 2018	Dec. 12, 2019
Spectrum Analyzer ROHDE & SCHWARZ	FSU43	101261	Apr. 15, 2019	Apr. 14, 2020
Broadband Horn Antenna SCHWARZBECK	BBHA 9170	148	Nov. 25, 2018	Nov. 24, 2019
HORN Antenna SCHWARZBECK	BBHA 9120D	9120D-969	Nov. 25, 2018	Nov. 24, 2019
BILOG Antenna SCHWARZBECK	VULB 9168	9168-472	Nov. 23, 2018	Nov. 22, 2019
Fixed Attenuator Mini-Circuits	MDCS18N-10	MDCS18N-10-01	Apr. 15, 2019	Apr. 14, 2020
Loop Antenna	HLA 6121	45745	Jul. 01, 2019	Jun. 30, 2020
Preamplifier EMCI	EMC001340	980201	Oct. 12, 2018	Oct. 11, 2019
Preamplifier EMCI	EMC 012645	980115	Oct. 12, 2018	Oct. 11, 2019
Preamplifier EMCI	EMC 184045	980116	Oct. 12, 2018	Oct. 11, 2019
Preamplifier EMCI	EMC 330H	980112	Oct. 12, 2018	Oct. 11, 2019
Power Meter Anritsu	ML2495A	1012010	Sep. 05, 2018	Sep. 04, 2019
			Sep. 04, 2019	Sep. 03, 2020
Power Sensor Anritsu	MA2411B	1315050	Sep. 04, 2018	Sep. 03, 2019
			Sep. 04, 2019	Sep. 03, 2020
RF Coaxial Cable HUBER+SUHNNER	EMC104-SM-SM-8 000&3000	140811+170717	Oct. 12, 2018	Oct. 11, 2019
RF Coaxial Cable HUBER+SUHNNER	SUCOFLEX 104	EMC104-SM-SM-1 000(140807)	Oct. 12, 2018	Oct. 11, 2019
RF Coaxial Cable WOKEN	8D-FB	Cable-Ch10-01	Oct. 12, 2018	Oct. 11, 2019
Boresight Antenna Fixture	FBA-01	FBA-SIP01	NA	NA
Software BV ADT	E3 6.120103	NA	NA	NA
Antenna Tower MF	MFA-440H	NA	NA	NA
Turn Table MF	MFT-201SS	NA	NA	NA
Antenna Tower & Turn Table Controller MF	MF-7802	NA	NA	NA

Note: 1. The calibration interval of the above test instruments is 12 months and the calibrations are traceable to NML/ROC and NIST/USA.

2. The test was performed in HwaYa Chamber 10.

#### 4.1.3 Test Procedures

##### **For Radiated Emission below 30 MHz**

- a. The EUT was placed on the top of a rotating table 0.8 meters above the ground at a 3 meter chamber room. The table was rotated 360 degrees to determine the position of the highest radiation.
- b. The EUT was set 3 meters away from the interference-receiving antenna, which was mounted on the top of a variable-height antenna tower.
- c. Parallel, perpendicular, and ground-parallel orientations of the antenna are set to make the measurement.
- d. For each suspected emission, the EUT was arranged to its worst case and the rotatable table was turned from 0 degrees to 360 degrees to find the maximum reading.
- e. The test-receiver system was set to Quasi-Peak Detect Function and Specified Bandwidth with Maximum Hold Mode.

##### **Note:**

1. The resolution bandwidth and video bandwidth of test receiver/spectrum analyzer is 9 kHz at frequency below 30 MHz.

##### **For Radiated Emission above 30 MHz**

- a. The EUT was placed on the top of a rotating table 0.8 meters (for 30 MHz ~ 1 GHz) / 1.5 meters (for above 1 GHz) above the ground at 3 meter chamber room for test. The table was rotated 360 degrees to determine the position of the highest radiation.
- b. The EUT was set 3 meters away from the interference-receiving antenna, which was mounted on the top of a variable-height antenna tower.
- c. The height of antenna is varied from one meter to four meters above the ground to determine the maximum value of the field strength. Both horizontal and vertical polarizations of the antenna are set to make the measurement.
- d. For each suspected emission, the EUT was arranged to its worst case and then the antenna was tuned to heights from 1 meter to 4 meters and the rotatable table was turned from 0 degrees to 360 degrees to find the maximum reading.
- e. The test-receiver system was set to quasi-peak detect function and specified bandwidth with maximum hold mode when the test frequency is below 1 GHz.
- f. The test-receiver system was set to peak and average detected function and specified bandwidth with maximum hold mode when the test frequency is above 1 GHz. If the peak reading value also meets average limit, measurement with the average detector is unnecessary.

##### **Note:**

1. The resolution bandwidth and video bandwidth of test receiver/spectrum analyzer is 120 kHz for Quasi-peak detection (QP) or Peak detection (PK) at frequency below 1 GHz.
2. The resolution bandwidth of test receiver/spectrum analyzer is 1 MHz and the video bandwidth is 3 MHz for Peak detection (PK) at frequency above 1 GHz.
3. The resolution bandwidth of test receiver/spectrum analyzer is 1 MHz and the video bandwidth is  $\geq 1/T$  (Duty cycle < 98 %) or 10 Hz (Duty cycle  $\geq 98$  %) for Average detection (AV) at frequency above 1 GHz.  
(11b: RBW = 1 MHz, VBW = 300 Hz ; 11g: RBW = 1 MHz, VBW = 1 kHz ;  
11n (HT20): RBW = 1 MHz, VBW = 1 kHz ; 11n (HT40): RBW = 1 MHz, VBW = 3 kHz)
4. All modes of operation were investigated and the worst-case emissions are reported.

4.1.4 Deviation from Test Standard

No deviation.

4.1.5 Test Set Up

<Radiated Emission below 30 MHz>

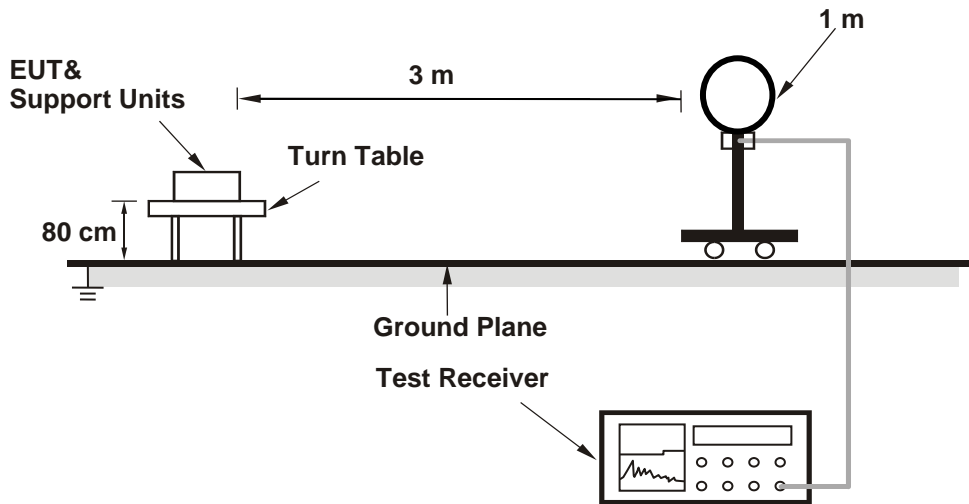

<Radiated Emission 30 MHz to 1 GHz>

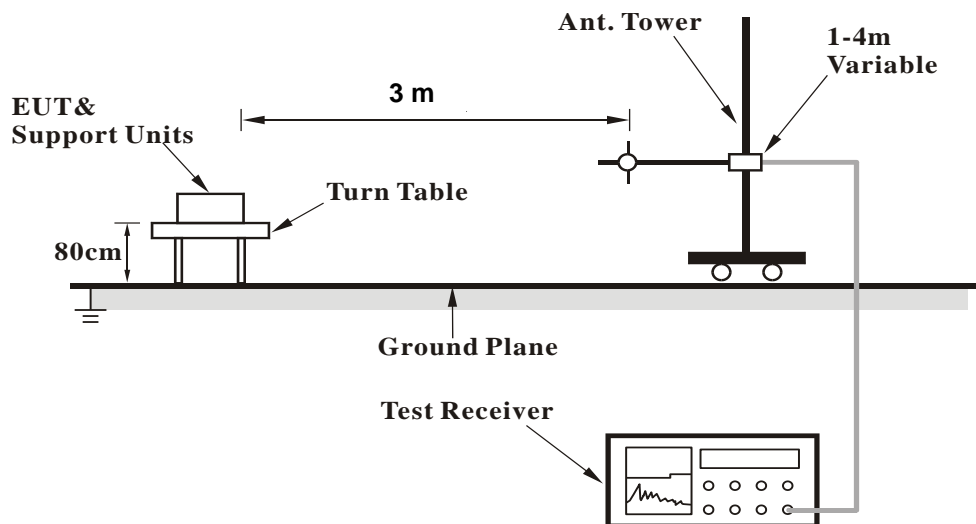



**<Radiated Emission above 1 GHz>**

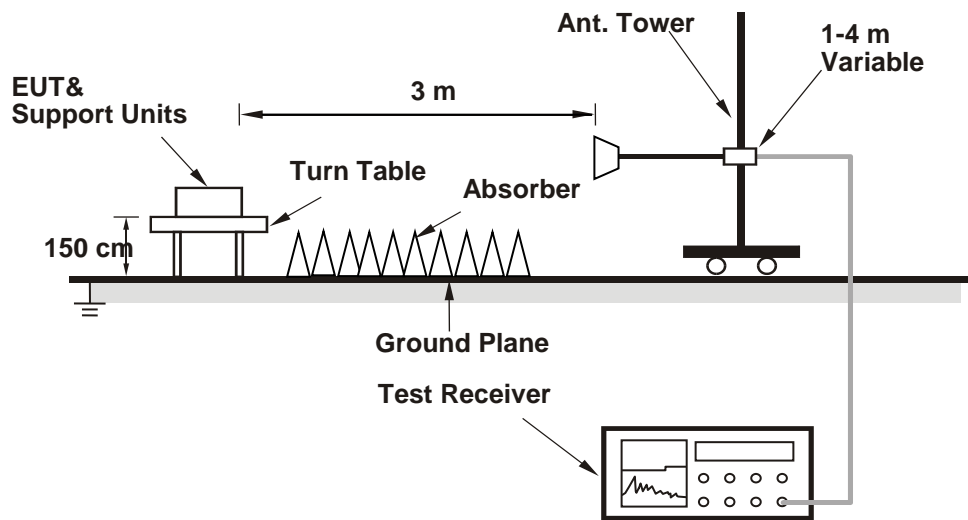

For the actual test configuration, please refer to the attached file (Test Setup Photo).

**4.1.6 EUT Operating Conditions**

Set the EUT under transmission condition continuously at specific channel frequency.

4.1.7 Test Results

Above 1 GHz Data :  
802.11b

EUT Test Condition		Measurement Detail	
Channel	Channel 1	Frequency Range	1 GHz ~ 25 GHz
Input Power	120 Vac, 60 Hz	Detector Function	Peak (PK) Average (AV)
Environmental Conditions	25 deg. C, 65 % RH	Tested By	Thomas Wei

Antenna Polarity & Test Distance: Horizontal at 3 m								
Frequency (MHz)	Emission Level (dBuV/m)	Read Level (dBuV)	Factor (dB/m)	Limit (dBuV/m)	Margin (dB)	Antenna Height (cm)	Table Angle (Degree)	Remark
2387.84	45	49.98	-4.98	54	-9	124	218	Average
2387.84	51.55	56.53	-4.98	74	-22.45	124	218	Peak
2412	104.51	109.52	-5.01			124	218	Average
2412	108.51	113.52	-5.01			124	218	Peak
4824	52.83	67.21	-14.38	54	-1.17	137	37	Average
4824	54.98	69.36	-14.38	74	-19.02	137	37	Peak

Antenna Polarity & Test Distance: Vertical at 3 m								
Frequency (MHz)	Emission Level (dBuV/m)	Read Level (dBuV)	Factor (dB/m)	Limit (dBuV/m)	Margin (dB)	Antenna Height (cm)	Table Angle (Degree)	Remark
2387.84	38.01	42.99	-4.98	54	-15.99	238	266	Average
2387.84	47.46	52.44	-4.98	74	-26.54	238	266	Peak
2412	96.51	101.52	-5.01			238	266	Average
2412	99.04	104.05	-5.01			238	266	Peak
4824	51.13	65.51	-14.38	54	-2.87	107	4	Average
4824	51.57	65.95	-14.38	74	-22.43	107	4	Peak

Remarks:

- Emission Level = Read Level + Factor  
Margin value = Emission level – Limit value
- 2412 MHz: Fundamental frequency.
- The emission levels of other frequencies were very low against the limit.

EUT Test Condition		Measurement Detail	
Channel	Channel 6	Frequency Range	1 GHz ~ 25 GHz
Input Power	120 Vac, 60 Hz	Detector Function	Peak (PK) Average (AV)
Environmental Conditions	25 deg. C, 65 % RH	Tested By	Thomas Wei

Antenna Polarity & Test Distance: Horizontal at 3 m								
Frequency (MHz)	Emission Level (dBuV/m)	Read Level (dBuV)	Factor (dB/m)	Limit (dBuV/m)	Margin (dB)	Antenna Height (cm)	Table Angle (Degree)	Remark
2389.66	38.3	43.28	-4.98	54	-15.7	185	219	Average
2389.66	48.03	53.01	-4.98	74	-25.97	185	219	Peak
2437	104.78	109.76	-4.98			185	219	Average
2437	107.26	112.24	-4.98			185	219	Peak
2483.52	37.41	42.26	-4.85	54	-16.59	185	219	Average
2483.52	47.81	52.66	-4.85	74	-26.19	185	219	Peak
4874	45.52	59.6	-14.08	54	-8.48	149	35	Average
4874	49.77	63.85	-14.08	74	-24.23	149	35	Peak

Antenna Polarity & Test Distance: Vertical at 3 m								
Frequency (MHz)	Emission Level (dBuV/m)	Read Level (dBuV)	Factor (dB/m)	Limit (dBuV/m)	Margin (dB)	Antenna Height (cm)	Table Angle (Degree)	Remark
2333.8	36.3	40.89	-4.59	54	-17.7	100	281	Average
2333.8	48.24	52.83	-4.59	74	-25.76	100	281	Peak
2437	96.33	101.31	-4.98			100	281	Average
2437	98.75	103.73	-4.98			100	281	Peak
2484.6	36.31	41.16	-4.85	54	-17.69	100	281	Average
2484.6	47.37	52.22	-4.85	74	-26.63	100	281	Peak
4874	45.16	59.24	-14.08	54	-8.84	105	4	Average
4874	49.22	63.3	-14.08	74	-24.78	105	4	Peak

Remarks:

- Emission Level = Read Level + Factor  
Margin value = Emission level – Limit value
- 2437 MHz: Fundamental frequency.
- The emission levels of other frequencies were very low against the limit.

EUT Test Condition		Measurement Detail	
Channel	Channel 11	Frequency Range	1 GHz ~ 25 GHz
Input Power	120 Vac, 60 Hz	Detector Function	Peak (PK) Average (AV)
Environmental Conditions	25 deg. C, 65 % RH	Tested By	Thomas Wei

Antenna Polarity & Test Distance: Horizontal at 3 m								
Frequency (MHz)	Emission Level (dBuV/m)	Read Level (dBuV)	Factor (dB/m)	Limit (dBuV/m)	Margin (dB)	Antenna Height (cm)	Table Angle (Degree)	Remark
2462	105.24	110.15	-4.91			182	224	Average
2462	107.73	112.64	-4.91			182	224	Peak
2486.84	47.01	51.86	-4.85	54	-6.99	182	224	Average
2486.84	52.85	57.7	-4.85	74	-21.15	182	224	Peak
4924	38.38	52.34	-13.96	54	-15.62	161	329	Average
4924	44.5	58.46	-13.96	74	-29.5	161	329	Peak
Antenna Polarity & Test Distance: Vertical at 3 m								
Frequency (MHz)	Emission Level (dBuV/m)	Read Level (dBuV)	Factor (dB/m)	Limit (dBuV/m)	Margin (dB)	Antenna Height (cm)	Table Angle (Degree)	Remark
2462	99.43	104.34	-4.91			234	277	Average
2462	101.82	106.73	-4.91			234	277	Peak
2486.64	41.37	46.22	-4.85	54	-12.63	234	277	Average
2486.64	49.32	54.17	-4.85	74	-24.68	234	277	Peak
4924	39.04	53	-13.96	54	-14.96	113	260	Average
4924	45.09	59.05	-13.96	74	-28.91	113	260	Peak

Remarks:

- Emission Level = Read Level + Factor  
Margin value = Emission level – Limit value
- 2462 MHz: Fundamental frequency.
- The emission levels of other frequencies were very low against the limit.

802.11g

EUT Test Condition		Measurement Detail	
Channel	Channel 1	Frequency Range	1 GHz ~ 25 GHz
Input Power	120 Vac, 60 Hz	Detector Function	Peak (PK) Average (AV)
Environmental Conditions	25 deg. C, 65 % RH	Tested By	Thomas Wei

Antenna Polarity & Test Distance: Horizontal at 3 m								
Frequency (MHz)	Emission Level (dBuV/m)	Read Level (dBuV)	Factor (dB/m)	Limit (dBuV/m)	Margin (dB)	Antenna Height (cm)	Table Angle (Degree)	Remark
2389.94	53.63	58.63	-5	54	-0.37	151	212	Average
2389.94	64.87	69.87	-5	74	-9.13	151	212	Peak
2412	97.52	102.53	-5.01			151	212	Average
2412	104.02	109.03	-5.01			151	212	Peak
4824	36	50.38	-14.38	54	-18	166	289	Average
4824	43.21	57.59	-14.38	74	-30.79	166	289	Peak
Antenna Polarity & Test Distance: Vertical at 3 m								
Frequency (MHz)	Emission Level (dBuV/m)	Read Level (dBuV)	Factor (dB/m)	Limit (dBuV/m)	Margin (dB)	Antenna Height (cm)	Table Angle (Degree)	Remark
2389.8	44.45	49.45	-5	54	-9.55	245	277	Average
2389.8	57.13	62.13	-5	74	-16.87	245	277	Peak
2412	89.59	94.6	-5.01			245	277	Average
2412	96.06	101.07	-5.01			245	277	Peak
4824	34.96	49.34	-14.38	54	-19.04	152	108	Average
4824	44.12	58.5	-14.38	74	-29.88	152	108	Peak

Remarks:

- Emission Level = Read Level + Factor  
Margin value = Emission level – Limit value
- 2412 MHz: Fundamental frequency.
- The emission levels of other frequencies were very low against the limit.

EUT Test Condition		Measurement Detail	
Channel	Channel 6	Frequency Range	1 GHz ~ 25 GHz
Input Power	120 Vac, 60 Hz	Detector Function	Peak (PK) Average (AV)
Environmental Conditions	25 deg. C, 65 % RH	Tested By	Thomas Wei

Antenna Polarity & Test Distance: Horizontal at 3 m								
Frequency (MHz)	Emission Level (dBuV/m)	Read Level (dBuV)	Factor (dB/m)	Limit (dBuV/m)	Margin (dB)	Antenna Height (cm)	Table Angle (Degree)	Remark
2389.94	49.19	54.19	-5	54	-4.81	133	222	Average
2389.94	61.79	66.79	-5	74	-12.21	133	222	Peak
2437	102.66	107.64	-4.98			133	222	Average
2437	109.57	114.55	-4.98			133	222	Peak
2483.52	42.38	47.23	-4.85	54	-11.62	133	222	Average
2483.52	53.24	58.09	-4.85	74	-20.76	133	222	Peak
4874	36.62	50.7	-14.08	54	-17.38	142	319	Average
4874	44.79	58.87	-14.08	74	-29.21	142	319	Peak

Antenna Polarity & Test Distance: Vertical at 3 m								
Frequency (MHz)	Emission Level (dBuV/m)	Read Level (dBuV)	Factor (dB/m)	Limit (dBuV/m)	Margin (dB)	Antenna Height (cm)	Table Angle (Degree)	Remark
2389.8	41.14	46.14	-5	54	-12.86	240	275	Average
2389.8	53.31	58.31	-5	74	-20.69	240	275	Peak
2437	96.98	101.96	-4.98			240	275	Average
2437	103.55	108.53	-4.98			240	275	Peak
2483.52	38.42	43.27	-4.85	54	-15.58	240	275	Average
2483.52	48.45	53.3	-4.85	74	-25.55	240	275	Peak
4874	36.17	50.25	-14.08	54	-17.83	151	272	Average
4874	43.28	57.36	-14.08	74	-30.72	151	272	Peak

Remarks:

- Emission Level = Read Level + Factor  
Margin value = Emission level – Limit value
- 2437 MHz: Fundamental frequency.
- The emission levels of other frequencies were very low against the limit.

EUT Test Condition		Measurement Detail	
Channel	Channel 11	Frequency Range	1 GHz ~ 25 GHz
Input Power	120 Vac, 60 Hz	Detector Function	Peak (PK) Average (AV)
Environmental Conditions	25 deg. C, 65 % RH	Tested By	Thomas Wei

Antenna Polarity & Test Distance: Horizontal at 3 m								
Frequency (MHz)	Emission Level (dBuV/m)	Read Level (dBuV)	Factor (dB/m)	Limit (dBuV/m)	Margin (dB)	Antenna Height (cm)	Table Angle (Degree)	Remark
2462	100.24	105.15	-4.91			181	223	Average
2462	106.74	111.65	-4.91			181	223	Peak
2483.52	53.2	58.05	-4.85	54	-0.8	181	223	Average
2483.52	67.74	72.59	-4.85	74	-6.26	181	223	Peak
4924	36.47	50.43	-13.96	54	-17.53	139	323	Average
4924	45.07	59.03	-13.96	74	-28.93	139	323	Peak
Antenna Polarity & Test Distance: Vertical at 3 m								
Frequency (MHz)	Emission Level (dBuV/m)	Read Level (dBuV)	Factor (dB/m)	Limit (dBuV/m)	Margin (dB)	Antenna Height (cm)	Table Angle (Degree)	Remark
2462	94.41	99.32	-4.91			235	276	Average
2462	100.72	105.63	-4.91			235	276	Peak
2483.52	46.41	51.26	-4.85	54	-7.59	235	276	Average
2483.52	62.44	67.29	-4.85	74	-11.56	235	276	Peak
4924	35.65	49.61	-13.96	54	-18.35	164	266	Average
4924	43.54	57.5	-13.96	74	-30.46	164	266	Peak

Remarks:

- Emission Level = Read Level + Factor  
Margin value = Emission level – Limit value
- 2462 MHz: Fundamental frequency.
- The emission levels of other frequencies were very low against the limit.

### 802.11n (HT20)

EUT Test Condition		Measurement Detail	
Channel	Channel 1	Frequency Range	1 GHz ~ 25 GHz
Input Power	120 Vac, 60 Hz	Detector Function	Peak (PK) Average (AV)
Environmental Conditions	25 deg. C, 65 % RH	Tested By	Thomas Wei

Antenna Polarity & Test Distance: Horizontal at 3 m								
Frequency (MHz)	Emission Level (dBuV/m)	Read Level (dBuV)	Factor (dB/m)	Limit (dBuV/m)	Margin (dB)	Antenna Height (cm)	Table Angle (Degree)	Remark
2389.94	52.95	57.95	-5	54	-1.05	135	222	Average
2389.94	67.76	72.76	-5	74	-6.24	135	222	Peak
2412	95.19	100.2	-5.01			135	222	Average
2412	102.26	107.27	-5.01			135	222	Peak
4824	35.84	50.22	-14.38	54	-18.16	142	308	Average
4824	44.77	59.15	-14.38	74	-29.23	142	308	Peak
Antenna Polarity & Test Distance: Vertical at 3 m								
Frequency (MHz)	Emission Level (dBuV/m)	Read Level (dBuV)	Factor (dB/m)	Limit (dBuV/m)	Margin (dB)	Antenna Height (cm)	Table Angle (Degree)	Remark
2389.66	43.82	48.8	-4.98	54	-10.18	245	276	Average
2389.66	58.24	63.22	-4.98	74	-15.76	245	276	Peak
2412	87.97	92.98	-5.01			245	276	Average
2412	94.58	99.59	-5.01			245	276	Peak
4824	35.38	49.76	-14.38	54	-18.62	163	232	Average
4824	43.96	58.34	-14.38	74	-30.04	163	232	Peak

Remarks:

- Emission Level = Read Level + Factor  
Margin value = Emission level – Limit value
- 2412 MHz: Fundamental frequency.
- The emission levels of other frequencies were very low against the limit.



EUT Test Condition		Measurement Detail	
Channel	Channel 6	Frequency Range	1 GHz ~ 25 GHz
Input Power	120 Vac, 60 Hz	Detector Function	Peak (PK) Average (AV)
Environmental Conditions	25 deg. C, 65 % RH	Tested By	Thomas Wei

Antenna Polarity & Test Distance: Horizontal at 3 m								
Frequency (MHz)	Emission Level (dBuV/m)	Read Level (dBuV)	Factor (dB/m)	Limit (dBuV/m)	Margin (dB)	Antenna Height (cm)	Table Angle (Degree)	Remark
2389.8	39.6	44.6	-5	54	-14.4	145	213	Average
2389.8	52.64	57.64	-5	74	-21.36	145	213	Peak
2437	99.71	104.69	-4.98			145	213	Average
2437	105.97	110.95	-4.98			145	213	Peak
2483.56	38.68	43.53	-4.85	54	-15.32	145	213	Average
2483.56	48.12	52.97	-4.85	74	-25.88	145	213	Peak
4874	36.1	50.18	-14.08	54	-17.9	170	325	Average
4874	44.51	58.59	-14.08	74	-29.49	170	325	Peak

Antenna Polarity & Test Distance: Vertical at 3 m								
Frequency (MHz)	Emission Level (dBuV/m)	Read Level (dBuV)	Factor (dB/m)	Limit (dBuV/m)	Margin (dB)	Antenna Height (cm)	Table Angle (Degree)	Remark
2389.38	37.18	42.16	-4.98	54	-16.82	241	276	Average
2389.38	47.49	52.47	-4.98	74	-26.51	241	276	Peak
2437	92.39	97.37	-4.98			241	276	Average
2437	99.75	104.73	-4.98			241	276	Peak
2483.88	37.17	42.02	-4.85	54	-16.83	241	276	Average
2483.88	47.11	51.96	-4.85	74	-26.89	241	276	Peak
4874	35.24	49.32	-14.08	54	-18.76	159	225	Average
4874	43.74	57.82	-14.08	74	-30.26	159	225	Peak

Remarks:

- Emission Level = Read Level + Factor  
Margin value = Emission level – Limit value
- 2437 MHz: Fundamental frequency.
- The emission levels of other frequencies were very low against the limit.

EUT Test Condition		Measurement Detail	
Channel	Channel 11	Frequency Range	1 GHz ~ 25 GHz
Input Power	120 Vac, 60 Hz	Detector Function	Peak (PK) Average (AV)
Environmental Conditions	25 deg. C, 65 % RH	Tested By	Thomas Wei

Antenna Polarity & Test Distance: Horizontal at 3 m								
Frequency (MHz)	Emission Level (dBuV/m)	Read Level (dBuV)	Factor (dB/m)	Limit (dBuV/m)	Margin (dB)	Antenna Height (cm)	Table Angle (Degree)	Remark
2462	98.88	103.79	-4.91			182	222	Average
2462	105.11	110.02	-4.91			182	222	Peak
2483.64	52.16	57.01	-4.85	54	-1.84	182	222	Average
2483.64	67.11	71.96	-4.85	74	-6.89	182	222	Peak
4924	35.6	49.56	-13.96	54	-18.4	137	241	Average
4924	44.93	58.89	-13.96	74	-29.07	137	241	Peak
Antenna Polarity & Test Distance: Vertical at 3 m								
Frequency (MHz)	Emission Level (dBuV/m)	Read Level (dBuV)	Factor (dB/m)	Limit (dBuV/m)	Margin (dB)	Antenna Height (cm)	Table Angle (Degree)	Remark
2462	92.48	97.39	-4.91			228	277	Average
2462	99.8	104.71	-4.91			228	277	Peak
2483.52	46.73	51.58	-4.85	54	-7.27	228	277	Average
2483.52	61.98	66.83	-4.85	74	-12.02	228	277	Peak
4924	35.21	49.17	-13.96	54	-18.79	159	294	Average
4924	44.22	58.18	-13.96	74	-29.78	159	294	Peak

Remarks:

- Emission Level = Read Level + Factor  
Margin value = Emission level – Limit value
- 2462 MHz: Fundamental frequency.
- The emission levels of other frequencies were very low against the limit.

### 802.11n (HT40)

EUT Test Condition		Measurement Detail	
Channel	Channel 3	Frequency Range	1 GHz ~ 25 GHz
Input Power	120 Vac, 60 Hz	Detector Function	Peak (PK) Average (AV)
Environmental Conditions	25 deg. C, 65 % RH	Tested By	Thomas Wei

#### Antenna Polarity & Test Distance: Horizontal at 3 m

Frequency (MHz)	Emission Level (dBuV/m)	Read Level (dBuV)	Factor (dB/m)	Limit (dBuV/m)	Margin (dB)	Antenna Height (cm)	Table Angle (Degree)	Remark
2389.66	51.68	56.66	-4.98	54	-2.32	111	227	Average
2389.66	65.2	70.18	-4.98	74	-8.8	111	227	Peak
2422	94.97	99.94	-4.97			111	227	Average
2422	101.27	106.24	-4.97			111	227	Peak
2483.84	38.65	43.5	-4.85	54	-15.35	111	227	Average
2483.84	49.67	54.52	-4.85	74	-24.33	111	227	Peak
4844	36.06	50.33	-14.27	54	-17.94	160	215	Average
4844	44.7	58.97	-14.27	74	-29.3	160	215	Peak

#### Antenna Polarity & Test Distance: Vertical at 3 m

Frequency (MHz)	Emission Level (dBuV/m)	Read Level (dBuV)	Factor (dB/m)	Limit (dBuV/m)	Margin (dB)	Antenna Height (cm)	Table Angle (Degree)	Remark
2389.66	42.99	47.97	-4.98	54	-11.01	100	273	Average
2389.66	53.84	58.82	-4.98	74	-20.16	100	273	Peak
2422	86.69	91.66	-4.97			100	273	Average
2422	93.12	98.09	-4.97			100	273	Peak
2483.68	37.65	42.5	-4.85	54	-16.35	100	273	Average
2483.68	47.25	52.1	-4.85	74	-26.75	100	273	Peak
4844	35.52	49.79	-14.27	54	-18.48	159	251	Average
4844	43.46	57.73	-14.27	74	-30.54	159	251	Peak

#### Remarks:

- Emission Level = Read Level + Factor  
Margin value = Emission level – Limit value
- 2422 MHz: Fundamental frequency.
- The emission levels of other frequencies were very low against the limit.

EUT Test Condition		Measurement Detail	
Channel	Channel 6	Frequency Range	1 GHz ~ 25 GHz
Input Power	120 Vac, 60 Hz	Detector Function	Peak (PK) Average (AV)
Environmental Conditions	25 deg. C, 65 % RH	Tested By	Thomas Wei

Antenna Polarity & Test Distance: Horizontal at 3 m								
Frequency (MHz)	Emission Level (dBuV/m)	Read Level (dBuV)	Factor (dB/m)	Limit (dBuV/m)	Margin (dB)	Antenna Height (cm)	Table Angle (Degree)	Remark
2389.52	44.23	49.21	-4.98	54	-9.77	167	211	Average
2389.52	60.59	65.57	-4.98	74	-13.41	167	211	Peak
2437	96.28	101.26	-4.98			167	211	Average
2437	103.71	108.69	-4.98			167	211	Peak
2483.52	39.34	44.19	-4.85	54	-14.66	167	211	Average
2483.52	49.48	54.33	-4.85	74	-24.52	167	211	Peak
4874	35.49	49.57	-14.08	54	-18.51	172	113	Average
4874	44.51	58.59	-14.08	74	-29.49	172	113	Peak

Antenna Polarity & Test Distance: Vertical at 3 m								
Frequency (MHz)	Emission Level (dBuV/m)	Read Level (dBuV)	Factor (dB/m)	Limit (dBuV/m)	Margin (dB)	Antenna Height (cm)	Table Angle (Degree)	Remark
2389.94	38.9	43.9	-5	54	-15.1	240	276	Average
2389.94	52.36	57.36	-5	74	-21.64	240	276	Peak
2437	89.28	94.26	-4.98			240	276	Average
2437	95.74	100.72	-4.98			240	276	Peak
2484.36	37.65	42.5	-4.85	54	-16.35	240	276	Average
2484.36	46.84	51.69	-4.85	74	-27.16	240	276	Peak
4874	35.24	49.32	-14.08	54	-18.76	152	134	Average
4874	43.83	57.91	-14.08	74	-30.17	152	134	Peak

Remarks:

- Emission Level = Read Level + Factor  
Margin value = Emission level – Limit value
- 2437 MHz: Fundamental frequency.
- The emission levels of other frequencies were very low against the limit.

EUT Test Condition		Measurement Detail	
Channel	Channel 9	Frequency Range	1 GHz ~ 25 GHz
Input Power	120 Vac, 60 Hz	Detector Function	Peak (PK) Average (AV)
Environmental Conditions	25 deg. C, 65 % RH	Tested By	Thomas Wei

Antenna Polarity & Test Distance: Horizontal at 3 m								
Frequency (MHz)	Emission Level (dBuV/m)	Read Level (dBuV)	Factor (dB/m)	Limit (dBuV/m)	Margin (dB)	Antenna Height (cm)	Table Angle (Degree)	Remark
2389.8	39.55	44.55	-5	54	-14.45	128	223	Average
2389.8	49.98	54.98	-5	74	-24.02	128	223	Peak
2452	91.22	96.13	-4.91			128	223	Average
2452	97.75	102.66	-4.91			128	223	Peak
2483.52	48.26	53.11	-4.85	54	-5.74	128	223	Average
2483.52	64.88	69.73	-4.85	74	-9.12	128	223	Peak
4904	36.1	50.08	-13.98	54	-17.9	152	268	Average
4904	45.19	59.17	-13.98	74	-28.81	152	268	Peak

Antenna Polarity & Test Distance: Vertical at 3 m								
Frequency (MHz)	Emission Level (dBuV/m)	Read Level (dBuV)	Factor (dB/m)	Limit (dBuV/m)	Margin (dB)	Antenna Height (cm)	Table Angle (Degree)	Remark
2344.3	37.7	42.43	-4.73	54	-16.3	263	276	Average
2344.3	47.22	51.95	-4.73	74	-26.78	263	276	Peak
2452	82.58	87.49	-4.91			263	276	Average
2452	89.24	94.15	-4.91			263	276	Peak
2483.6	43.42	48.27	-4.85	54	-10.58	263	276	Average
2483.6	59.36	64.21	-4.85	74	-14.64	263	276	Peak
4904	36.16	50.14	-13.98	54	-17.84	149	126	Average
4904	45.38	59.36	-13.98	74	-28.62	149	126	Peak

Remarks:

- Emission Level = Read Level + Factor  
Margin value = Emission level – Limit value
- 2452 MHz: Fundamental frequency.
- The emission levels of other frequencies were very low against the limit.

**9 kHz ~ 30 MHz Data:**

The amplitude of spurious emissions attenuated more than 20 dB below the permissible value is not required to be report.

**30 MHz ~ 1 GHz Worst-Case Data:**

**802.11g**

EUT Test Condition		Measurement Detail	
Channel	Channel 1	Frequency Range	30 MHz ~ 1 GHz
Input Power	120 Vac, 60 Hz	Detector Function	Peak (PK) Quasi-peak (QP)
Environmental Conditions	25 deg. C, 65 % RH	Tested By	Thomas Wei

**Horizontal**

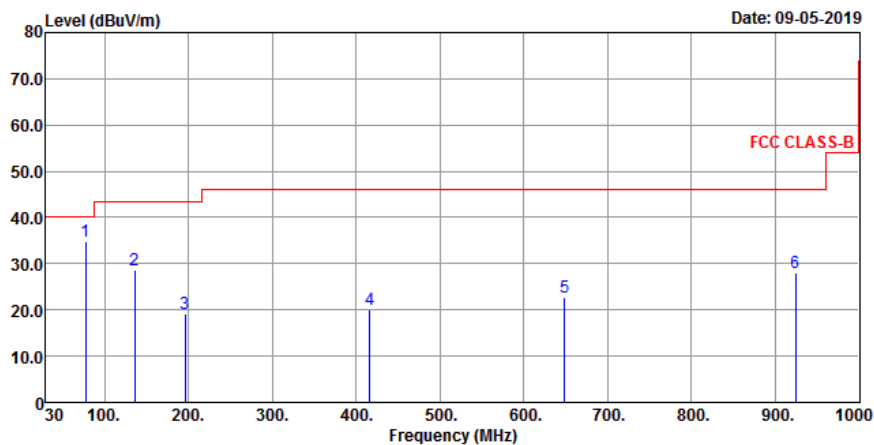

**Vertical**

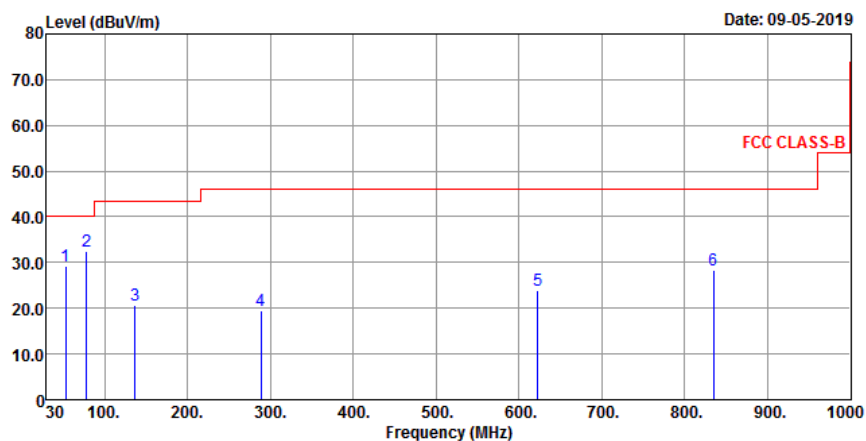

**Antenna Polarity & Test Distance: Horizontal at 3 m**

Frequency (MHz)	Emission Level (dBuV/m)	Read Level (dBuV)	Factor (dB/m)	Limit (dBuV/m)	Margin (dB)	Antenna Height (cm)	Table Angle (Degree)	Remark
77.53	34.73	55.97	-21.24	40	-5.27	128	132	Peak
135.73	28.6	46.96	-18.36	43.5	-14.9	145	161	Peak
195.87	19.12	38.85	-19.73	43.5	-24.38	174	189	Peak
416.06	20.12	33.15	-13.03	46	-25.88	216	228	Peak
648.86	22.88	31.12	-8.24	46	-23.12	245	256	Peak
924.34	28.03	31.2	-3.17	46	-17.97	284	296	Peak

**Antenna Polarity & Test Distance: Vertical at 3 m**

Frequency (MHz)	Emission Level (dBuV/m)	Read Level (dBuV)	Factor (dB/m)	Limit (dBuV/m)	Margin (dB)	Antenna Height (cm)	Table Angle (Degree)	Remark
53.28	29.13	46.74	-17.61	40	-10.87	132	141	Peak
78.5	32.54	53.85	-21.31	40	-7.46	158	167	Peak
136.7	20.76	38.88	-18.12	43.5	-22.74	195	204	Peak
288.99	19.61	36.4	-16.79	46	-26.39	233	246	Peak
622.67	23.85	32.28	-8.43	46	-22.15	259	268	Peak
835.1	28.23	32.58	-4.35	46	-17.77	289	297	Peak

Remarks:

- Emission Level = Read Level + Factor  
Margin value = Emission level – Limit value.
- The emission levels of other frequencies were very low against the limit.

## 4.2 Conducted Emission Measurement

### 4.2.1 Limits of Conducted Emission Measurement

Frequency (MHz)	Conducted Limit (dBuV)	
	Quasi-Peak	Average
0.15 - 0.5	66 - 56	56 - 46
0.50 - 5.0	56	46
5.0 - 30.0	60	50

- Note: 1. The lower limit shall apply at the transition frequencies.  
 2. The limit decreases in line with the logarithm of the frequency in the range of 0.15 to 0.50 MHz.

### 4.2.2 Test Instruments

Description & Manufacturer	Model No.	Serial No.	Date of Calibration	Due Date of Calibration
Test Receiver ROHDE & SCHWARZ	ESCI	100613	Dec. 10, 2018	Dec. 09, 2019
RF signal cable Woken	5D-FB	Cable-cond1-01	Sep. 05, 2018	Sep. 04, 2019
LISN ROHDE & SCHWARZ (EUT)	ENV216	101826	Feb. 21, 2019	Feb. 20, 2020
LISN ROHDE & SCHWARZ (Peripheral)	ESH3-Z5	100311	Aug. 22, 2019	Aug. 21, 2020
Software ADT	BV ADT_Cond_ V7.3.7.4	NA	NA	NA

- Note: 1. The calibration interval of the above test instruments is 12 months and the calibrations are traceable to NML/ROC and NIST/USA.  
 2. The test was performed in HwaYa Shielded Room 1.  
 3. The VCCI Site Registration No. is C-12040.



#### 4.2.3 Test Procedures

- The EUT was placed 0.4 meters from the conducting wall of the shielded room with EUT being connected to the power mains through a line impedance stabilization network (LISN). Other support units were connected to the power mains through another LISN. The two LISNs provide 50 ohm/50 uH of coupling impedance for the measuring instrument.
- Both lines of the power mains connected to the EUT were checked for maximum conducted interference.
- The frequency range from 150 kHz to 30 MHz was searched. Emission levels under (Limit – 20 dB) was not recorded.

**Note:** The resolution bandwidth and video bandwidth of test receiver is 9 kHz for quasi-peak detection (QP) and average detection (AV) at frequency 0.15 MHz – 30 MHz.

#### 4.2.4 Deviation from Test Standard

No deviation.

#### 4.2.5 Test Setup

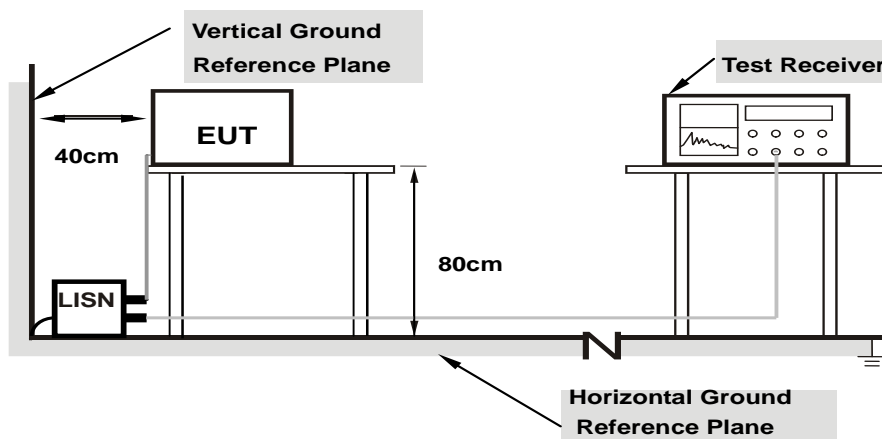

**Note:** 1.Support units were connected to second LISN.

For the actual test configuration, please refer to the attached file (Test Setup Photo).

#### 4.2.6 EUT Operating Conditions

Set the EUT under transmission condition continuously at specific channel frequency.

#### 4.2.7 Test Results

Frequency Range	150kHz ~ 30MHz	Detector Function & Resolution Bandwidth	Quasi-Peak (QP) / Average (AV), 9kHz
Input Power	120Vac, 60Hz	Environmental Conditions	25°C, 65%RH
Tested by	Thomas Wei	Test Date	2019/9/4

Phase Of Power : Line (L)										
No	Frequency (MHz)	Correction Factor (dB)	Reading Value (dBuV)		Emission Level (dBuV)		Limit (dBuV)		Margin (dB)	
			Q.P.	AV.	Q.P.	AV.	Q.P.	AV.	Q.P.	AV.
1	0.16967	9.84	9.78	2.89	19.62	12.73	64.98	54.98	-45.36	-42.25
2	0.30249	9.87	12.46	7.29	22.33	17.16	60.17	50.17	-37.84	-33.01
<b>3</b>	<b>0.45097</b>	<b>9.88</b>	<b>24.94</b>	<b>18.42</b>	<b>34.82</b>	<b>28.30</b>	<b>56.86</b>	<b>46.86</b>	<b>-22.04</b>	<b>-18.56</b>
4	0.59943	9.89	14.79	8.58	24.68	18.47	56.00	46.00	-31.32	-27.53
5	0.81861	9.91	14.96	5.37	24.87	15.28	56.00	46.00	-31.13	-30.72
6	2.71496	9.98	9.38	1.72	19.36	11.70	56.00	46.00	-36.64	-34.30

Remarks:

1. Q.P. and AV. are abbreviations of quasi-peak and average individually.
2. The emission levels of other frequencies were very low against the limit.
3. Margin value = Emission level – Limit value
4. Correction factor = Insertion loss + Cable loss
5. Emission Level = Correction Factor + Reading Value

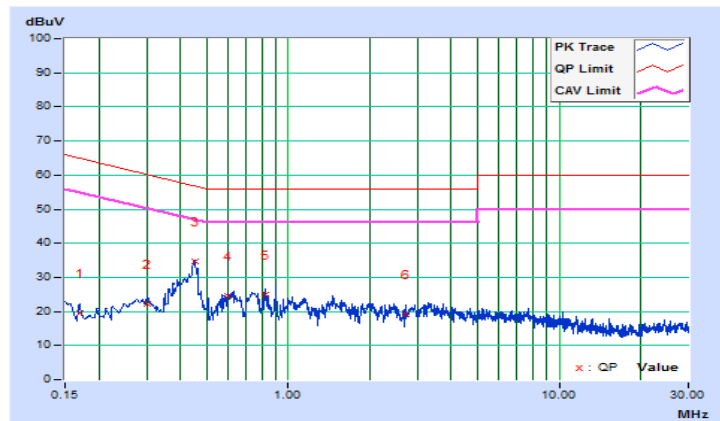

Frequency Range	150kHz ~ 30MHz	Detector Function & Resolution Bandwidth	Quasi-Peak (QP) / Average (AV), 9kHz
Input Power	120Vac, 60Hz	Environmental Conditions	25°C, 65%RH
Tested by	Thomas Wei	Test Date	2019/9/3

Phase Of Power : Neutral (N)										
No	Frequency (MHz)	Correction Factor (dB)	Reading Value (dBuV)		Emission Level (dBuV)		Limit (dBuV)		Margin (dB)	
			Q.P.	AV.	Q.P.	AV.	Q.P.	AV.	Q.P.	AV.
1	0.15719	9.82	19.57	10.75	29.39	20.57	65.61	55.61	-36.22	-35.04
2	0.22038	9.84	17.41	5.39	27.25	15.23	62.80	52.80	-35.55	-37.57
3	0.38808	9.87	22.42	12.06	32.29	21.93	58.10	48.10	-25.81	-26.17
4	0.47453	9.87	26.45	14.43	36.32	24.30	56.43	46.43	-20.11	-22.13
5	0.60356	9.87	16.72	2.04	26.59	11.91	56.00	46.00	-29.41	-34.09
6	25.04497	10.34	17.26	0.73	27.60	11.07	60.00	50.00	-32.40	-38.93

Remarks:

1. Q.P. and AV. are abbreviations of quasi-peak and average individually.
2. The emission levels of other frequencies were very low against the limit.
3. Margin value = Emission level – Limit value
4. Correction factor = Insertion loss + Cable loss
5. Emission Level = Correction Factor + Reading Value

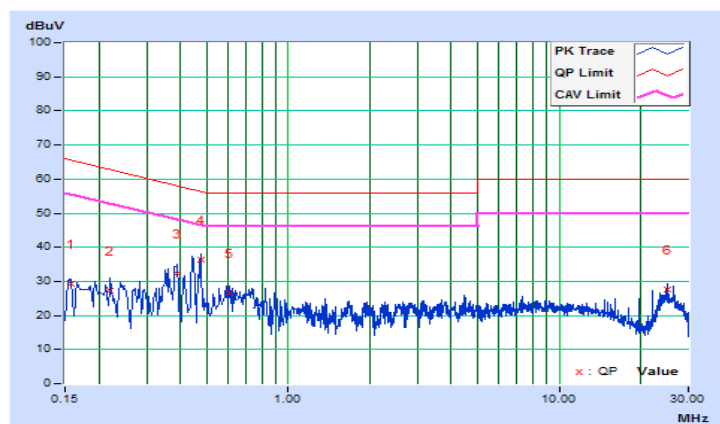

### 4.3 6 dB Bandwidth Measurement

#### 4.3.1 Limits of 6 dB Bandwidth Measurement

The minimum of 6 dB Bandwidth Measurement is 0.5 MHz.

#### 4.3.2 Test Setup

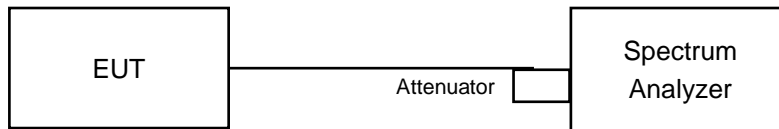

#### 4.3.3 Test Instruments

Refer to section 4.1.2 to get information of above instrument.

#### 4.3.4 Test Procedure

- a. Set resolution bandwidth (RBW) = 100 kHz
- b. Set the video bandwidth (VBW)  $\geq 3 \times$  RBW, Detector = Peak.
- c. Trace mode = max hold.
- d. Sweep = auto couple.
- e. Measure the maximum width of the emission that is constrained by the frequencies associated with the two amplitude points (upper and lower) that are attenuated by 6 dB relative to the maximum level measured in the fundamental emission

#### 4.3.5 Deviation from Test Standard

No deviation.

#### 4.3.6 EUT Operating Conditions

The software provided by client to enable the EUT under transmission condition continuously at lowest, middle and highest channel frequencies individually.

#### 4.3.7 Test Results

##### 802.11b

Channel	Frequency (MHz)	6 dB Bandwidth (MHz)	Minimum Limit (MHz)	Pass / Fail
1	2412	8.08	0.5	Pass
6	2437	8.11	0.5	Pass
11	2462	7.62	0.5	Pass

##### 802.11g

Channel	Frequency (MHz)	6 dB Bandwidth (MHz)	Minimum Limit (MHz)	Pass / Fail
1	2412	15.51	0.5	Pass
6	2437	14.81	0.5	Pass
11	2462	15.47	0.5	Pass

##### 802.11n (HT20)

Channel	Frequency (MHz)	6 dB Bandwidth (MHz)	Minimum Limit (MHz)	Pass / Fail
1	2412	15.48	0.5	Pass
6	2437	15.50	0.5	Pass
11	2462	15.16	0.5	Pass

##### 802.11n (HT40)

Channel	Frequency (MHz)	6 dB Bandwidth (MHz)	Minimum Limit (MHz)	Pass / Fail
3	2422	35.11	0.5	Pass
6	2437	35.21	0.5	Pass
9	2452	35.15	0.5	Pass

### Spectrum Plot of Worst Value

#### 802.11b

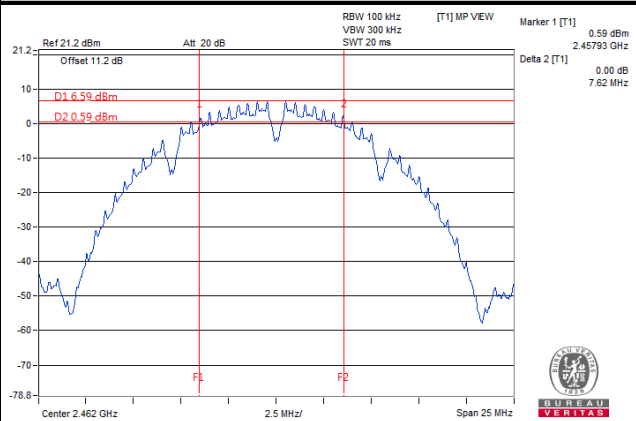

#### 802.11g

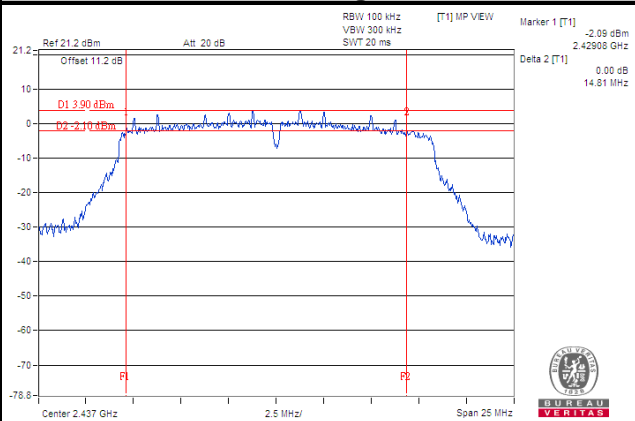

#### 802.11n (HT20)

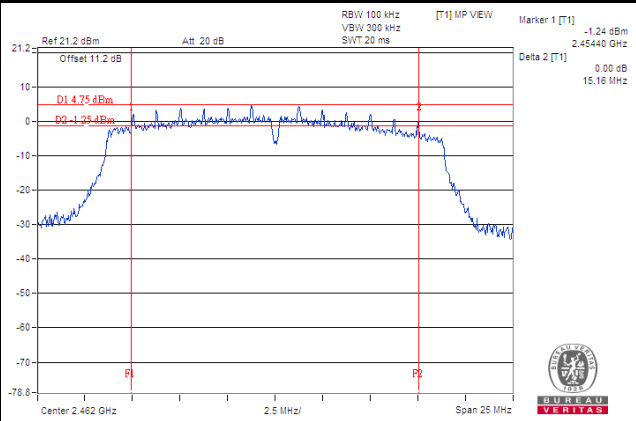

#### 802.11n (HT40)

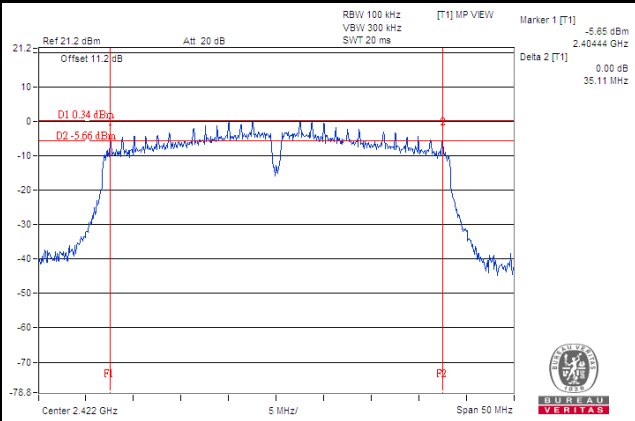

## 4.4 Occupied Bandwidth Measurement

### 4.4.1 Test Setup

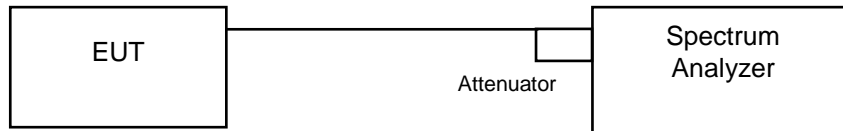

### 4.4.2 Test Instruments

Refer to section 4.1.2 to get information of above instrument.

### 4.4.3 Test Procedure

The transmitter output was connected to the spectrum analyzer through an attenuator. The bandwidth of the fundamental frequency was measured by spectrum analyzer with resolution bandwidth in the range of 1 % to 5 % of the anticipated emission bandwidth, and a video bandwidth at least 3x the resolution bandwidth and set the detector to PEAK. The width of a frequency band such that, below the lower and above the upper frequency limits, the mean powers emitted are each equal to a specified percentage 0.5 % of the total mean power of a given emission.

### 4.4.4 Deviation from Test Standard

No deviation.

### 4.4.5 EUT Operating Conditions

The software provided by client to enable the EUT under transmission condition continuously at lowest, middle and highest channel frequencies individually.

#### 4.4.6 Test Results

##### 802.11b

Channel	Frequency (MHz)	Occupied Bandwidth (MHz)	Pass / Fail
1	2412	12.96	Pass
6	2437	12.96	Pass
11	2462	12.72	Pass

##### 802.11g

Channel	Frequency (MHz)	Occupied Bandwidth (MHz)	Pass / Fail
1	2412	16.74	Pass
6	2437	16.73	Pass
11	2462	16.63	Pass

##### 802.11n (HT20)

Channel	Frequency (MHz)	Occupied Bandwidth (MHz)	Pass / Fail
1	2412	17.79	Pass
6	2437	17.79	Pass
11	2462	17.69	Pass

##### 802.11n (HT40)

Channel	Frequency (MHz)	Occupied Bandwidth (MHz)	Pass / Fail
3	2422	36.06	Pass
6	2437	36.54	Pass
9	2452	36.15	Pass



### Spectrum Plot of Worst Value

#### 802.11b

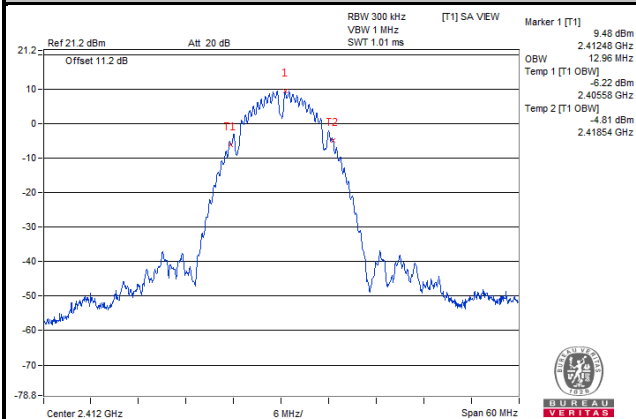

#### 802.11g

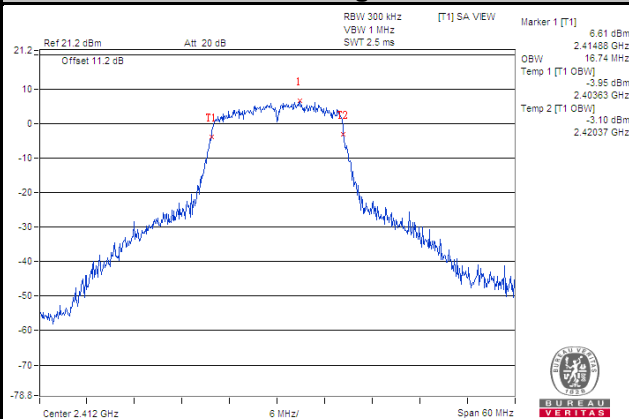

#### 802.11n (HT20)

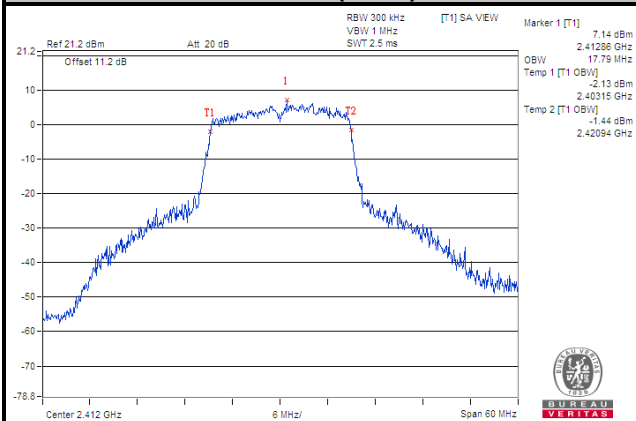

#### 802.11n (HT40)

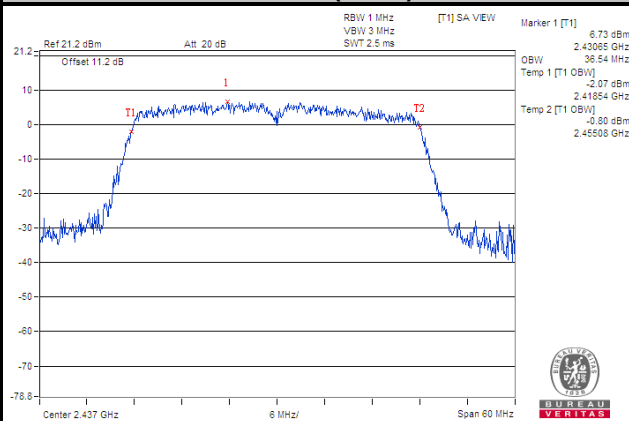

## 4.5 Conducted Output Power Measurement

### 4.5.1 Limits of Conducted Output Power Measurement

For systems using digital modulation in the 2400–2483.5 MHz bands: 1 Watt (30 dBm)

### 4.5.2 Test Setup

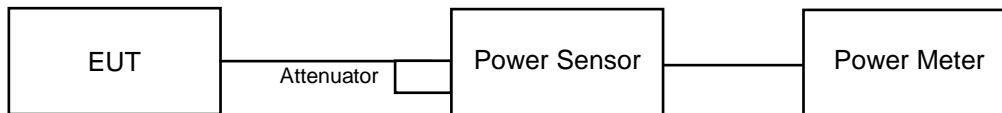

### 4.5.3 Test Instruments

Refer to section 4.1.2 to get information of above instrument.

### 4.5.4 Test Procedures

A peak power sensor was used on the output port of the EUT. A power meter was used to read the response of the peak power sensor. Record the power level.

### 4.5.5 Deviation from Test Standard

No deviation.

### 4.5.6 EUT Operating Conditions

The software provided by client to enable the EUT under transmission condition continuously at lowest, middle and highest channel frequencies individually.

#### 4.5.7 Test Results

##### 802.11b

Channel	Frequency (MHz)	Peak Power (mW)	Peak Power (dBm)	Limit (dBm)	Pass / Fail
1	2412	55.335	17.43	30	Pass
6	2437	54.828	17.39	30	Pass
11	2462	55.976	17.48	30	Pass

##### 802.11g

Channel	Frequency (MHz)	Peak Power (mW)	Peak Power (dBm)	Limit (dBm)	Pass / Fail
1	2412	236.592	23.74	30	Pass
6	2437	216.272	23.35	30	Pass
11	2462	244.343	23.88	30	Pass

##### 802.11n (HT20)

Channel	Frequency (MHz)	Peak Power (mW)	Peak Power (dBm)	Limit (dBm)	Pass / Fail
1	2412	231.739	23.65	30	Pass
6	2437	212.814	23.28	30	Pass
11	2462	<b>245.471</b>	23.90	30	Pass

##### 802.11n (HT40)

Channel	Frequency (MHz)	Peak Power (mW)	Peak Power (dBm)	Limit (dBm)	Pass / Fail
3	2422	204.644	23.11	30	Pass
6	2437	193.197	22.86	30	Pass
9	2452	203.236	23.08	30	Pass

## 4.6 Power Spectral Density Measurement

### 4.6.1 Limits of Power Spectral Density Measurement

The Maximum of Power Spectral Density Measurement is 8 dBm in any 3 kHz band during any time interval of continuous transmission.

### 4.6.2 Test Setup

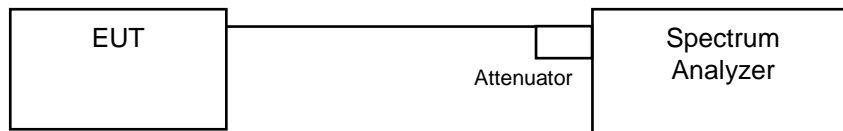

### 4.6.3 Test Instruments

Refer to section 4.1.2 to get information of above instrument.

### 4.6.4 Test Procedure

- a. Set analyzer center frequency to DTS channel center frequency.
- b. Set the span to 1.5 times the DTS bandwidth.
- c. Set the RBW to:  $3 \text{ kHz} \leq \text{RBW} \leq 100 \text{ kHz}$ .
- d. Set the VBW  $\geq 3 \times \text{RBW}$ .
- e. Detector = peak.
- f. Sweep time = auto couple.
- g. Trace mode = max hold.
- h. Allow trace to fully stabilize.
- i. Use the peak marker function to determine the maximum amplitude level within the RBW.

### 4.6.5 Deviation from Test Standard

No deviation.

### 4.6.6 EUT Operating Condition

The software provided by client to enable the EUT under transmission condition continuously at lowest, middle and highest channel frequencies individually.

#### 4.6.7 Test Results

##### 802.11b

Channel	Frequency (MHz)	PSD (dBm/3 kHz)	Limit (dBm/3 kHz)	Pass / Fail
1	2412	-6.18	8	Pass
6	2437	-5.54	8	Pass
11	2462	-5.39	8	Pass

##### 802.11g

Channel	Frequency (MHz)	PSD (dBm/3 kHz)	Limit (dBm/3 kHz)	Pass / Fail
1	2412	-10.30	8	Pass
6	2437	-10.76	8	Pass
11	2462	-9.81	8	Pass

##### 802.11n (HT20)

Channel	Frequency (MHz)	PSD (dBm/3 kHz)	Limit (dBm/3 kHz)	Pass / Fail
1	2412	-11.40	8	Pass
6	2437	-11.70	8	Pass
11	2462	-10.75	8	Pass

##### 802.11n (HT40)

Channel	Frequency (MHz)	PSD (dBm/3 kHz)	Limit (dBm/3 kHz)	Pass / Fail
3	2422	-15.92	8	Pass
6	2437	-17.00	8	Pass
9	2452	-16.26	8	Pass

### Spectrum Plot of Worst Value

#### 802.11b

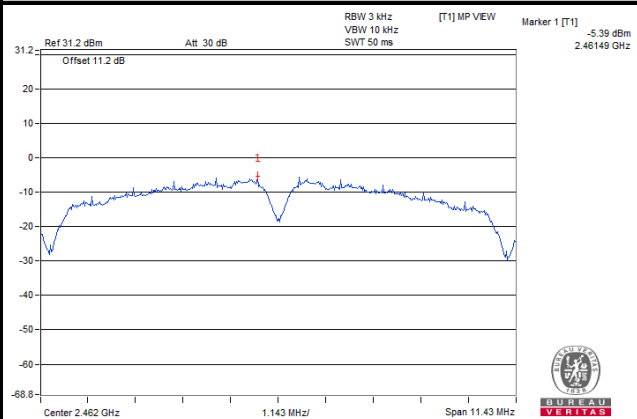

#### 802.11g

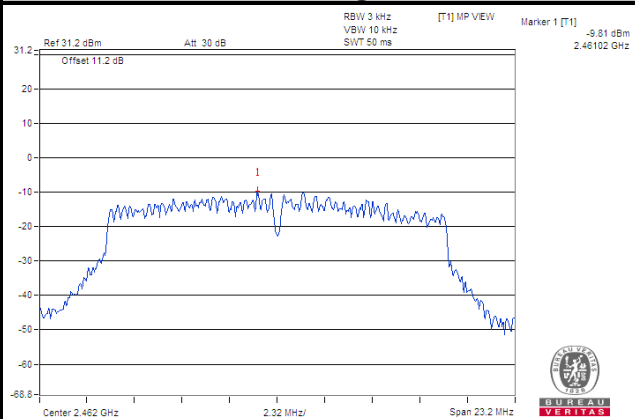

#### 802.11n (HT20)

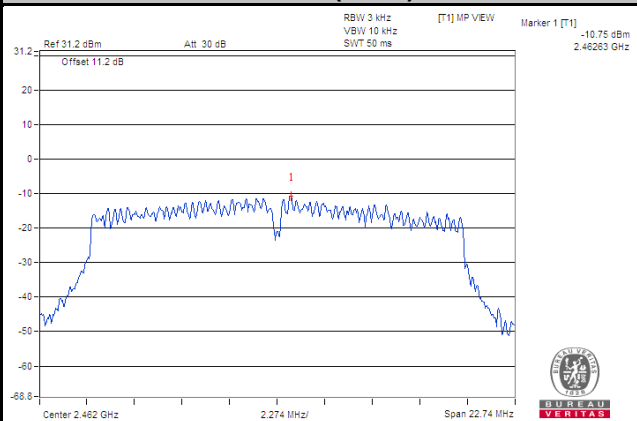

#### 802.11n (HT40)

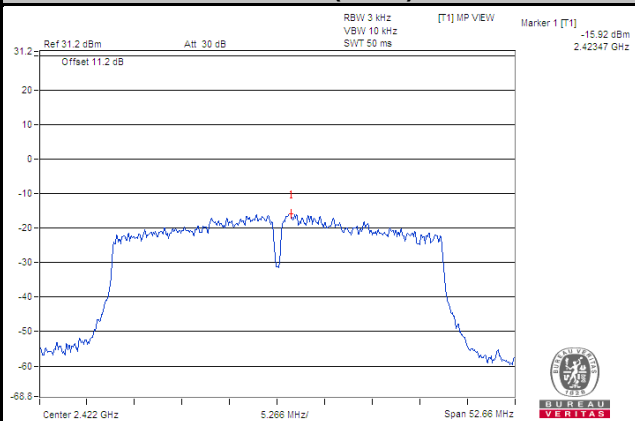

## 4.7 Conducted Out of Band Emission Measurement

### 4.7.1 Limits of Conducted Out of Band Emission Measurement

Below -20 dB of the highest emission level of operating band (in 100 kHz Resolution Bandwidth).

### 4.7.2 Test Setup

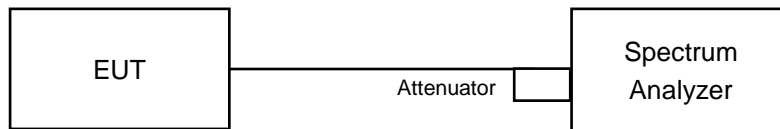

### 4.7.3 Test Instruments

Refer to section 4.1.2 to get information of above instrument.

### 4.7.4 Test Procedure

#### MEASUREMENT PROCEDURE REF

1. Set the RBW = 100 kHz.
2. Set the VBW  $\geq$  300 kHz.
3. Detector = peak.
4. Sweep time = auto couple.
5. Trace mode = max hold.
6. Allow trace to fully stabilize.
7. Use the peak marker function to determine the maximum power level in any 100 kHz band segment within the fundamental EBW.

#### MEASUREMENT PROCEDURE OOB

1. Set RBW = 100 kHz.
2. Set VBW  $\geq$  300 kHz.
3. Detector = peak.
4. Sweep = auto couple.
5. Trace Mode = max hold.
6. Allow trace to fully stabilize.
7. Use the peak marker function to determine the maximum amplitude level.

### 4.7.5 Deviation from Test Standard

No deviation.

### 4.7.6 EUT Operating Condition

The software provided by client to enable the EUT under transmission condition continuously at lowest, middle and highest channel frequencies individually.

### 4.7.7 Test Results

The spectrum plots are attached on the following images. D1 line indicates the highest level, and D2 line indicates the 20 dB offset below D1. It shows compliance with the requirement.

#### 802.11b

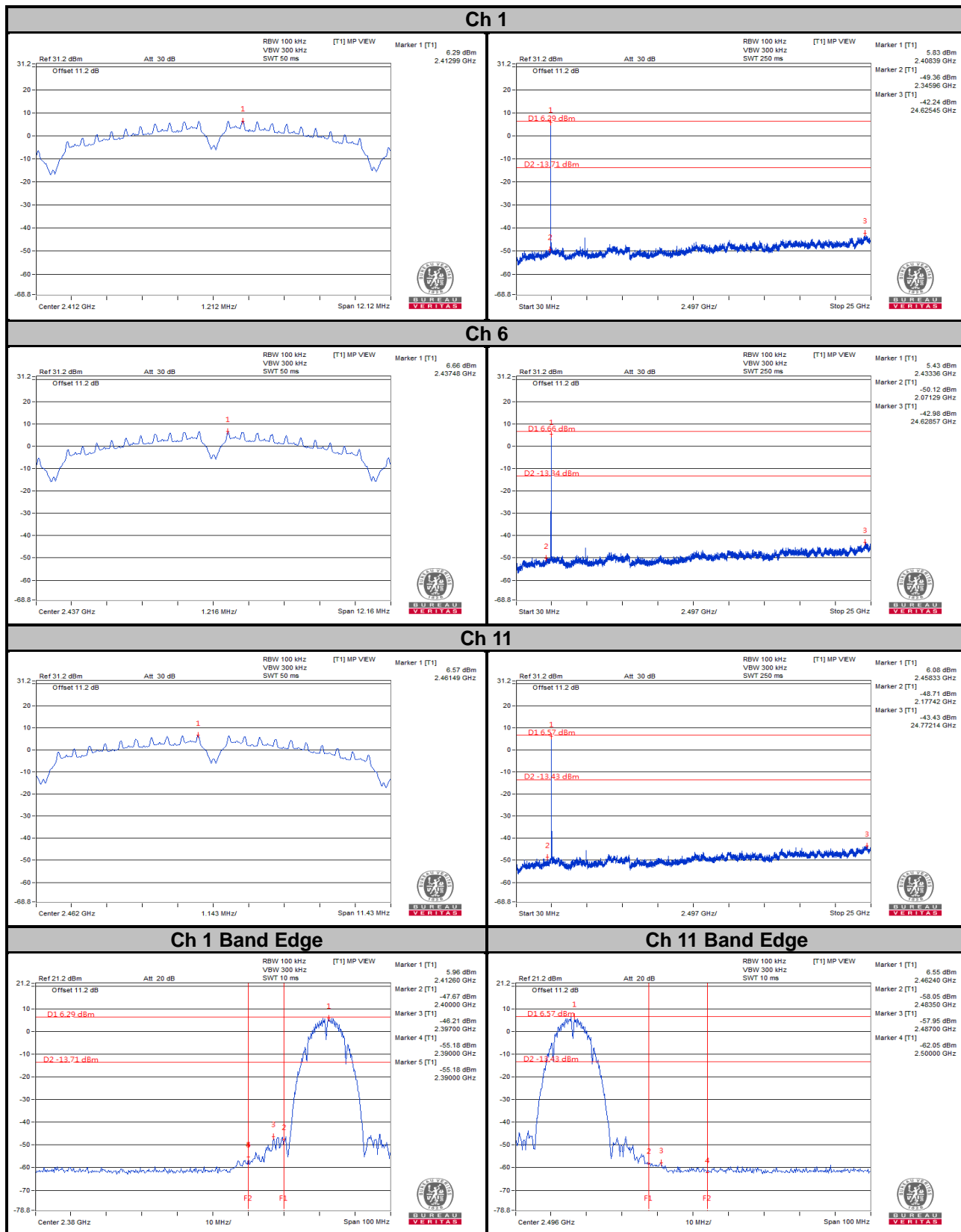



802.11g

Ch 1

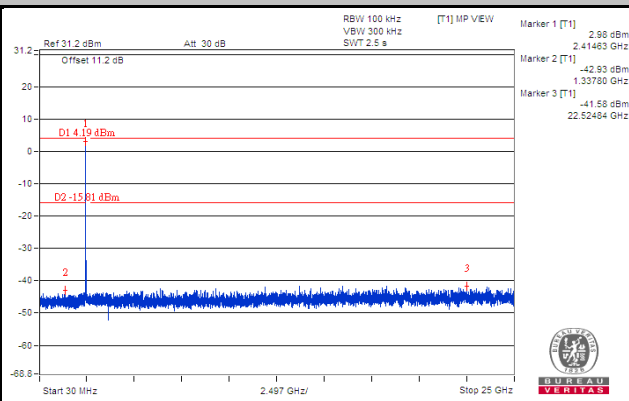
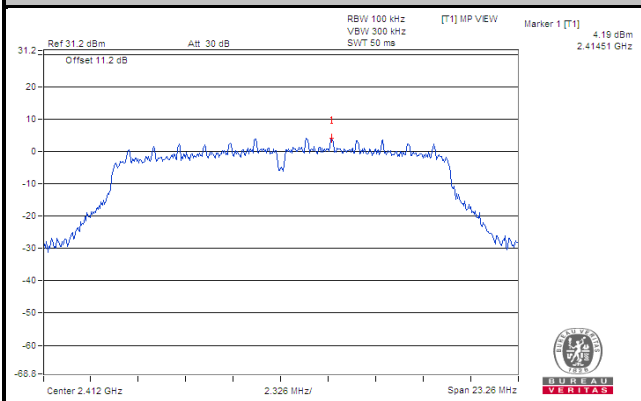

Ch 6

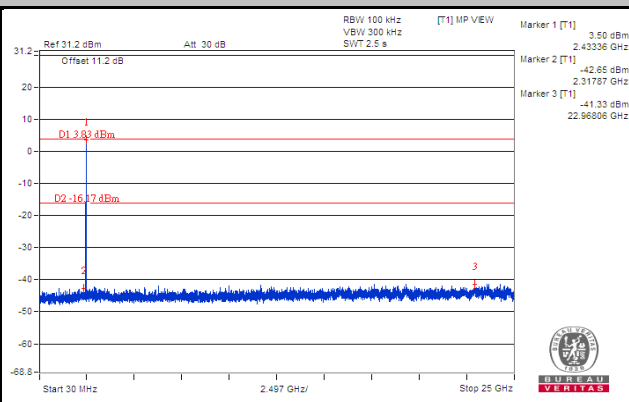
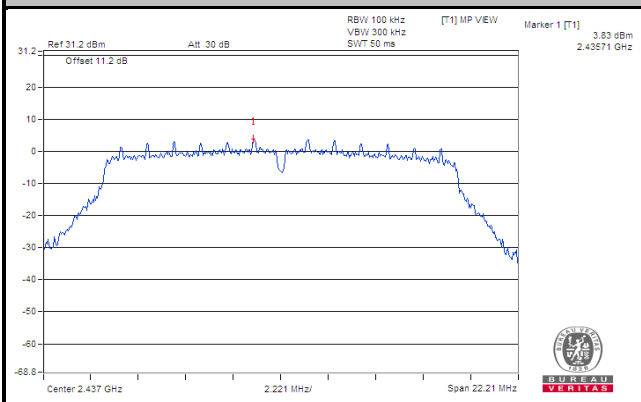

Ch 11

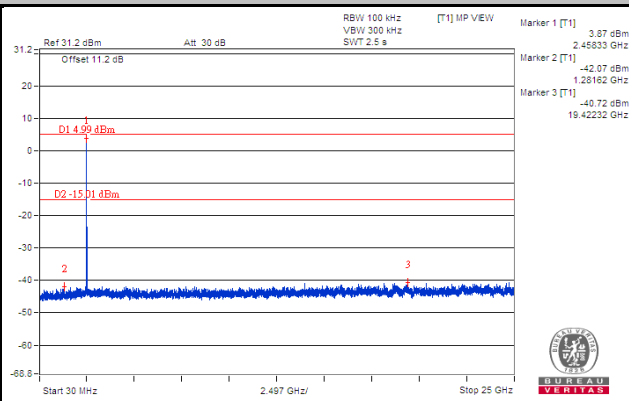
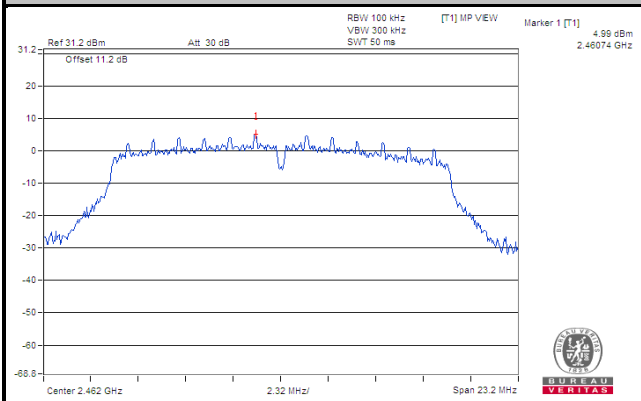

Ch 1 Band Edge

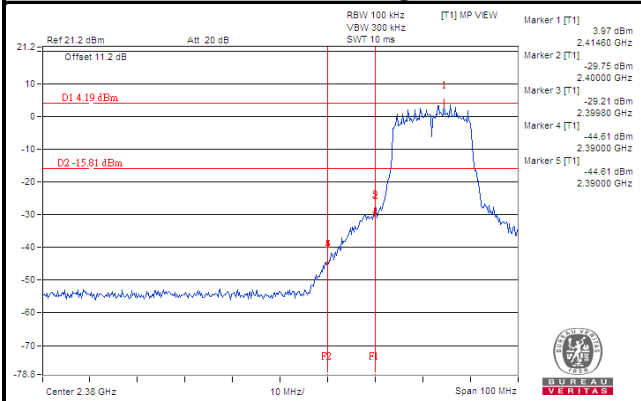

Ch 11 Band Edge

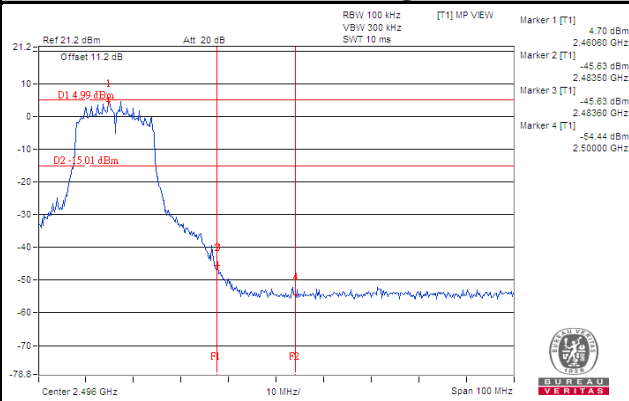

### 802.11n (HT20)

#### Ch 1

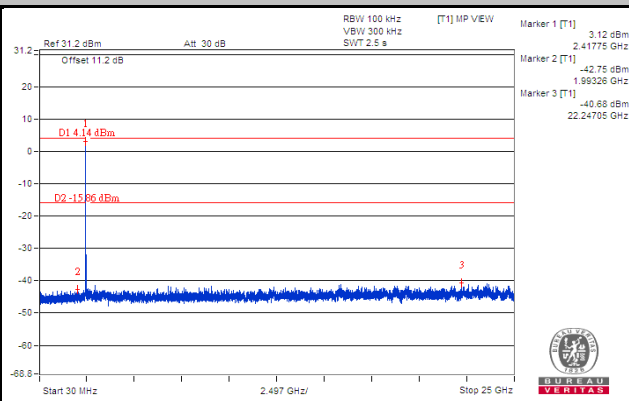
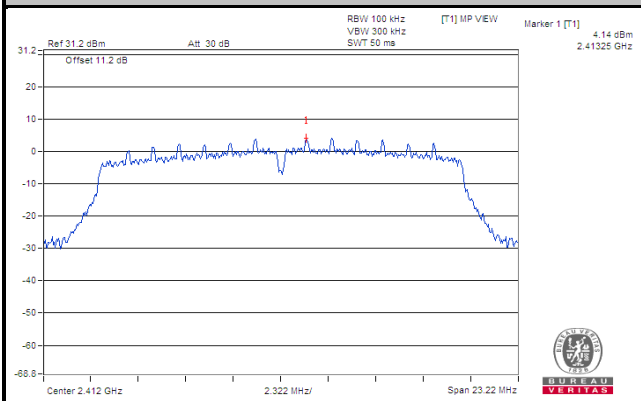

#### Ch 6

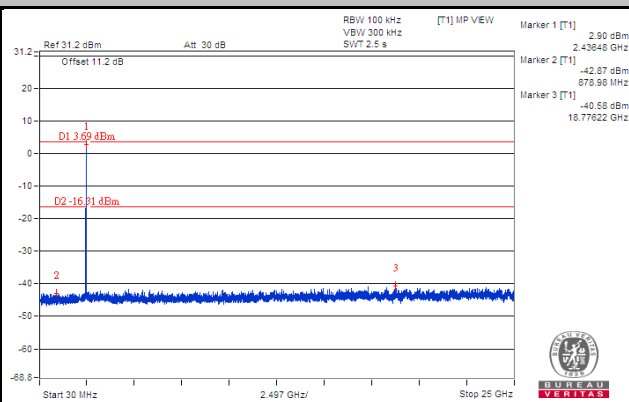
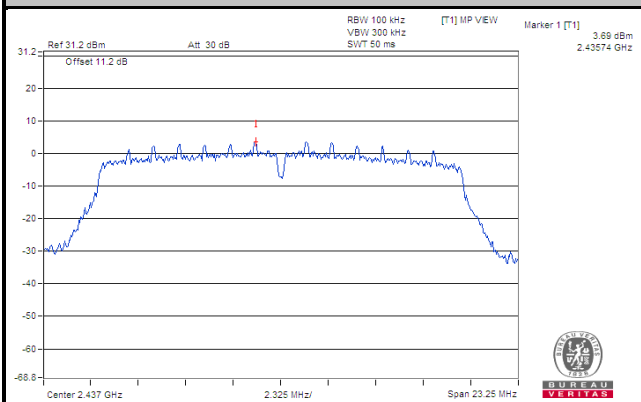

#### Ch 11

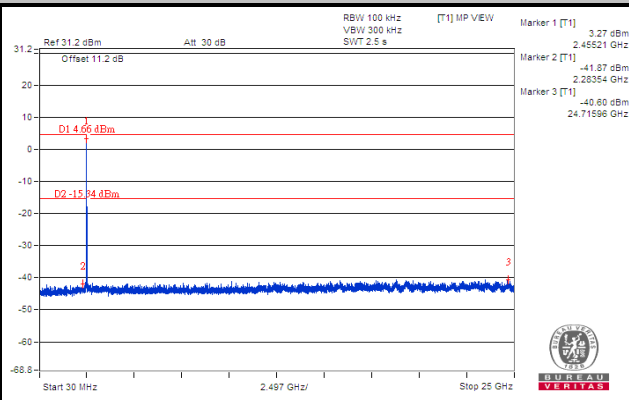
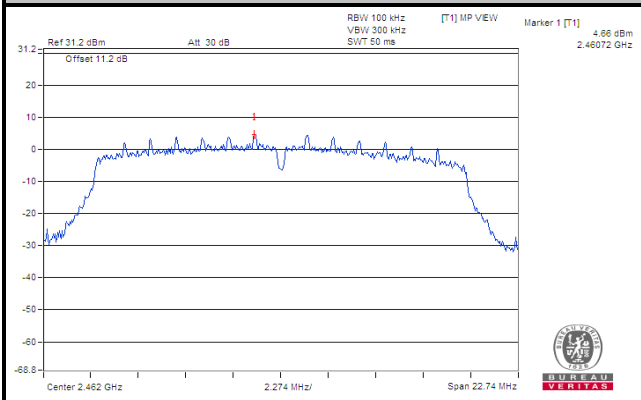

#### Ch 1 Band Edge

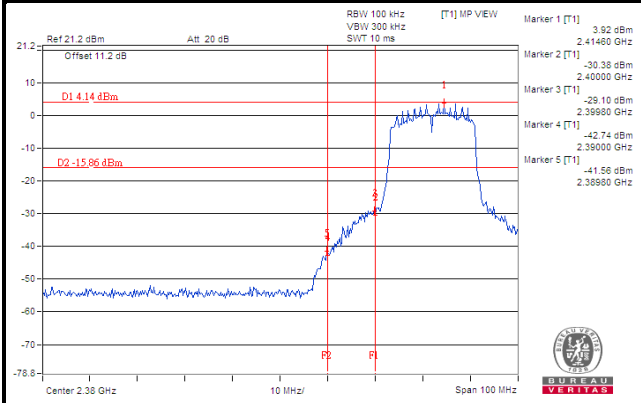

#### Ch 11 Band Edge

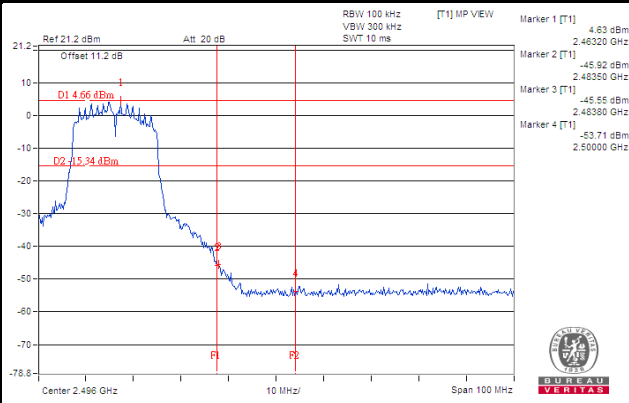

# 802.11n (HT40)

## Ch 3

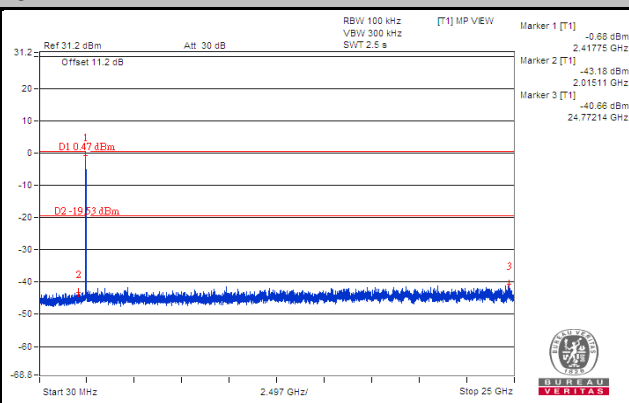
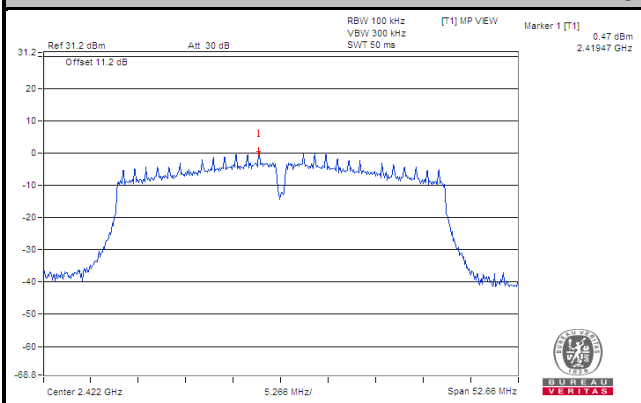

## Ch 6

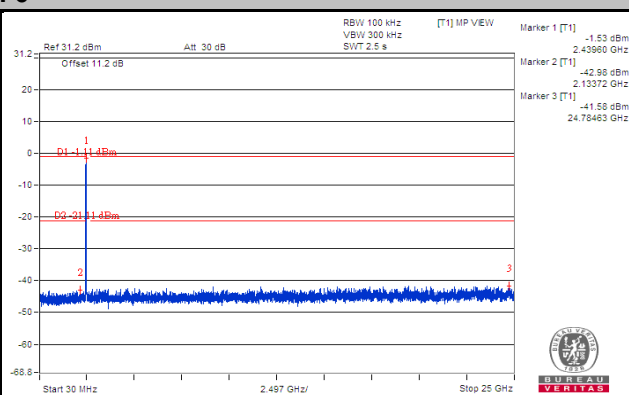
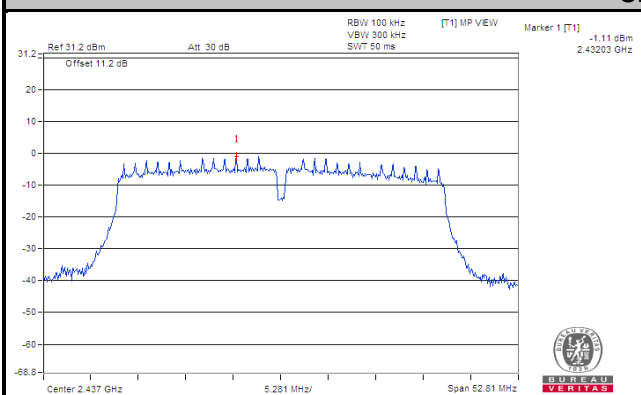

## Ch 9

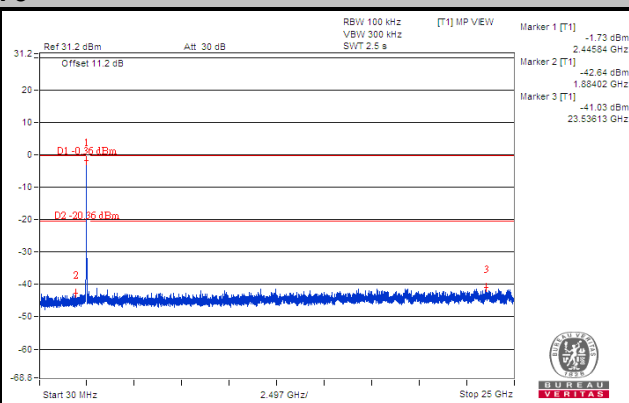
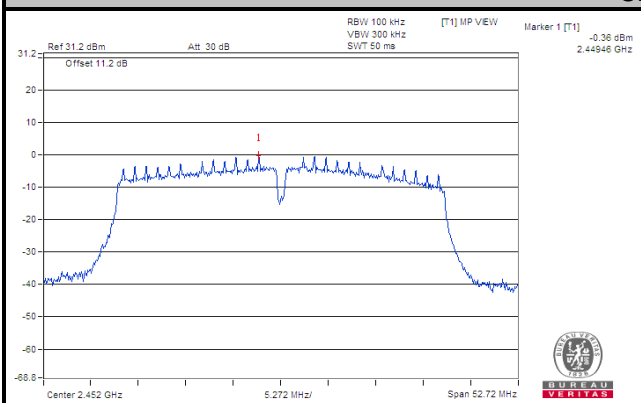

## Ch 3 Band Edge

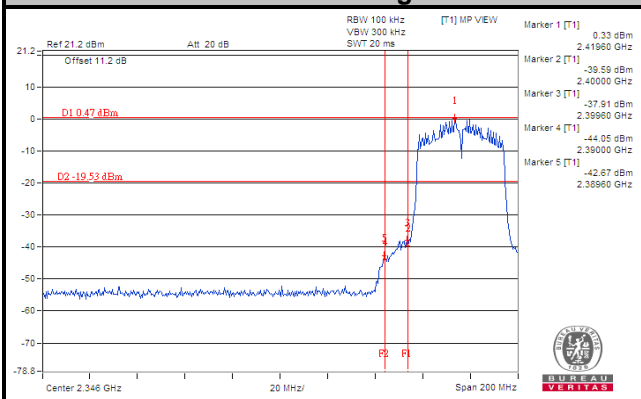

## Ch 9 Band Edge

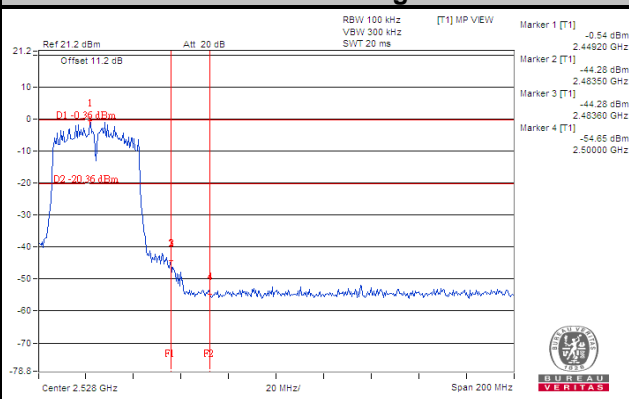

## 5 Pictures of Test Arrangements

Please refer to the attached file (Test Setup Photo).

## Appendix – Information of the Testing Laboratories

We, Bureau Veritas Consumer Products Services (H.K.) Ltd., Taoyuan Branch, were founded in 1988 to provide our best service in EMC, Radio, Telecom and Safety consultation. Our laboratories are FCC recognized accredited test firms and accredited according to ISO/IEC 17025.

If you have any comments, please feel free to contact us at the following:

**Lin Kou EMC/RF Lab**

Tel: 886-2-26052180

Fax: 886-2-26051924

**Hsin Chu EMC/RF/Telecom Lab**

Tel: 886-3-6668565

Fax: 886-3-6668323

**Hwa Ya EMC/RF/Safety Lab**

Tel: 886-3-3183232

Fax: 886-3-3270892

**Email:** [service.adt@tw.bureauveritas.com](mailto:service.adt@tw.bureauveritas.com)

**Web Site:** [www.bureauveritas-adt.com](http://www.bureauveritas-adt.com)

The address and road map of all our labs can be found in our web site also.

--- END ---