

FCC Test Report

(PART 27)

Report No.: RF190723C05-7

FCC ID: ZL5S52E

Test Model: S52

Received Date: Jul. 23, 2019

Test Date: Aug. 12 ~ Sep. 06, 2019

Issued Date: Oct. 08, 2019

Applicant: Bullitt Group

Address: One Valpy, Valpy Street, Reading, RG1 1AR, Berkshire, UK

Issued By: Bureau Veritas Consumer Products Services (H.K.) Ltd., Taoyuan Branch
Lin Kou Laboratories

Lab Address: No. 47-2, 14th Ling, Chia Pau Vil., Lin Kou Dist., New Taipei City, Taiwan

Test Location: No.19, Hwa Ya 2nd Rd., Wen Hwa Vil., Kwei Shan Dist., Taoyuan City
33383, Taiwan

**FCC Registration /
Designation Number:** 788550 / TW0003



This report is for your exclusive use. Any copying or replication of this report to or for any other person or entity, or use of our name or trademark, is permitted only with our prior written permission. This report sets forth our findings solely with respect to the test samples identified herein. The results set forth in this report are not indicative or representative of the quality or characteristics of the lot from which a test sample was taken or any similar or identical product unless specifically and expressly noted. Our report includes all of the tests requested by you and the results thereof based upon the information that you provided to us. You have 60 days from date of issuance of this report to notify us of any material error or omission caused by our negligence, provided, however, that such notice shall be in writing and shall specifically address the issue you wish to raise. A failure to raise such issue within the prescribed time shall constitute your unqualified acceptance of the completeness of this report, the tests conducted and the correctness of the report contents. Unless specific mention, the uncertainty of measurement has been explicitly taken into account to declare the compliance or non-compliance to the specification. The report must not be used by the client to claim product certification, approval, or endorsement by TAF or any government agencies

Table of Contents

Release Control Record	4
1 Certificate of Conformity	5
2 Summary of Test Results	6
2.1 Measurement Uncertainty	7
2.2 Test Site and Instruments	8
3 General Information	9
3.1 General Description of EUT	9
3.2 Configuration of System under Test	11
3.2.1 Description of Support Units	11
3.3 Test Mode Applicability and Tested Channel Detail	12
3.4 EUT Operating Conditions	15
3.5 General Description of Applied Standards	15
4 Test Types and Results	16
4.1 Output Power Measurement	16
4.1.1 Limits of Output Power Measurement	16
4.1.2 Test Procedures	16
4.1.3 Test Setup	17
4.1.4 Test Results	18
4.2 Modulation Characteristics Measurement	26
4.2.1 Limits of Modulation Characteristics	26
4.2.2 Test Setup	26
4.2.3 Test Procedure	26
4.2.4 Test Results	27
4.3 Frequency Stability Measurement	28
4.3.1 Limits of Frequency Stability Measurement	28
4.3.2 Test Procedure	28
4.3.3 Test Setup	28
4.3.4 Test Results	29
4.4 Occupied Bandwidth Measurement	36
4.4.1 Limits of Occupied Bandwidth Measurement	36
4.4.2 Test Procedure	36
4.4.3 Test Setup	36
4.4.4 Test Result	37
4.5 Band Edge Measurement	41
4.5.1 Limits of Band Edge Measurement	41
4.5.2 Test Setup	41
4.5.3 Test Procedures	41
4.5.4 Test Results	42
4.6 Peak to Average Ratio	48
4.6.1 Limits of Peak to Average Ratio Measurement	48
4.6.2 Test Setup	48
4.6.3 Test Procedures	48
4.6.4 Test Results	49
4.7 Conducted Spurious Emissions	53
4.7.1 Limits of Conducted Spurious Emissions Measurement	53
4.7.2 Test Setup	53
4.7.3 Test Procedure	53
4.7.4 Test Results	54
4.8 Radiated Emission Measurement	61
4.8.1 Limits of Radiated Emission Measurement	61
4.8.2 Test Procedure	61
4.8.3 Deviation from Test Standard	61
4.8.4 Test Setup	62

4.8.5 Test Results	63
5 Pictures of Test Arrangements.....	87
Appendix – Information of the Testing Laboratories	88

Release Control Record

Issue No.	Description	Date Issued
RF190723C05-7	Original Release	Oct. 08, 2019

1 Certificate of Conformity

Product: Rugged Smart Phone
Brand: CAT
Test Model: S52
Sample Status: Identical Prototype
Applicant: Bullitt Group
Test Date: Aug. 12 ~ Sep. 06, 2019
Standards: FCC Part 27, Subpart C, L

The above equipment has been tested by **Bureau Veritas Consumer Products Services (H.K.) Ltd., Taoyuan Branch**, and found compliance with the requirement of the above standards. The test record, data evaluation & Equipment Under Test (EUT) configurations represented herein are true and accurate accounts of the measurements of the sample's RF characteristics under the conditions specified in this report.

Prepared by : Gina Liu, **Date:** Oct. 08, 2019
Gina Liu / Specialist

Approved by : Dylan Chiou, **Date:** Oct. 08, 2019
Dylan Chiou / Project Engineer

2 Summary of Test Results

Applied Standard: FCC Part 27 & Part 2 (WCDMA)			
FCC Clause	Test Item	Result	Remarks
2.1046 27.50(d)(4)	Equivalent Isotropic Radiated Power	Pass	Meet the requirement of limit.
2.1047	Modulation Characteristics	Pass	Meet the requirement.
2.1055 27.54	Frequency Stability	Pass	Meet the requirement of limit.
2.1049	Occupied Bandwidth	Pass	Meet the requirement of limit.
27.50(d)(5)	Peak to Average Ratio	Pass	Meet the requirement of limit.
27.53(h)	Band Edge Measurements	Pass	Meet the requirement of limit.
2.1051 27.53(h)	Conducted Spurious Emissions	Pass	Meet the requirement of limit.
2.1053 27.53(h)	Radiated Spurious Emissions	Pass	Meet the requirement of limit. Minimum passing margin is -36.25 dB at 36.79 MHz.

Applied Standard: FCC Part 27 & Part 2 (LTE 4)			
FCC Clause	Test Item	Result	Remarks
2.1046 27.50(d)(4)	Maximum Peak Output Power	Pass	Meet the requirement of limit.
2.1047	Modulation Characteristics	Pass	Meet the requirement.
2.1055 27.54	Frequency Stability	Pass	Meet the requirement of limit.
2.1049	Occupied Bandwidth	Pass	Meet the requirement of limit.
27.50(d)(5)	Peak to Average Ratio	Pass	Meet the requirement of limit.
27.53(h)	Band Edge Measurements	Pass	Meet the requirement of limit.
2.1051 27.53(h)	Conducted Spurious Emissions	Pass	Meet the requirement of limit.
2.1053 27.53(h)	Radiated Spurious Emissions	Pass	Meet the requirement of limit. Minimum passing margin is -29.36 dB at 77.53 MHz.

Note: Determining compliance based on the results of the compliance measurement, not taking into account measurement instrumentation uncertainty.

2.1 Measurement Uncertainty

Where relevant, the following measurement uncertainty levels have been estimated for tests performed on the EUT as specified in CISPR 16-4-2:

Measurement	Frequency	Expanded Uncertainty (k=2) (\pm)
Radiated Emissions up to 1 GHz	9 kHz ~ 30 MHz	3.04 dB
	30 MHz ~ 200 MHz	2.93 dB
	200 MHz ~ 1000 MHz	2.95 dB
Radiated Emissions above 1 GHz	1 GHz ~ 18 GHz	2.26 dB
	18 GHz ~ 40 GHz	1.94 dB

2.2 Test Site and Instruments

Description & Manufacturer	Model No.	Serial No.	Date of Calibration	Due Date of Calibration
Test Receiver Agilent	N9038A	MY51210203	Mar. 18, 2019	Mar. 17, 2020
Spectrum Analyzer Agilent	N9010A	MY52220314	Dec. 13, 2018	Dec. 12, 2019
Spectrum Analyzer ROHDE & SCHWARZ	FSU43	101261	Apr. 15, 2019	Apr. 14, 2020
Spectrum Analyzer ROHDE & SCHWARZ	FSW26	102023	Oct. 11, 2018	Oct. 10, 2019
HORN Antenna SCHWARZBECK	BBHA 9120D	9120D-969	Nov. 25, 2018	Nov. 24, 2019
BILOG Antenna SCHWARZBECK	VULB 9168	9168-472	Nov. 23, 2018	Nov. 22, 2019
HORN Antenna SCHWARZBECK	BBHA 9170	148	Nov. 25, 2018	Nov. 24, 2019
Double Ridge Guide Horn Antenna EMCO	3115	5619	Nov. 25, 2018	Nov. 24, 2019
Fixed Attenuator WOKEN	MDCS18N-10	MDCS18N-10-01	Apr. 15, 2019	Apr. 14, 2020
MXG Vector signal generator Agilent	N5182B	MY53050430	Nov. 19, 2018	Nov. 18, 2019
Preamplifier EMCI	EMC 012645	980115	Oct. 12, 2018	Oct. 11, 2019
Preamplifier EMCI	EMC 330H	980112	Oct. 12, 2018	Oct. 11, 2019
RF Coaxial Cable HUBER+SUHNNER	EMC104-SM-SM-800 0&3000	140811+170717	Oct. 12, 2018	Oct. 11, 2019
RF Coaxial Cable HUBER+SUHNNER	SUCOFLEX 104	EMC104-SM-SM-1 000(140807)	Oct. 12, 2018	Oct. 11, 2019
RF Coaxial Cable WOKEN	8D-FB	Cable-Ch10-01	Oct. 12, 2018	Oct. 11, 2019
Boresight Antenna Fixture	FBA-01	FBA-SIP01	NA	NA
Software BV ADT	E3 6.120103	NA	NA	NA
Antenna Tower MF	MFA-440H	NA	NA	NA
Turn Table MF	MFT-201SS	NA	NA	NA
Antenna Tower & Turn Table Controller MF	MF-7802	NA	NA	NA
Radio Communication Analyzer Anritsu	MT8821C	6201462755	Jan. 16, 2019	Jan. 15, 2020
Radio Communication Analyzer Anritsu	MT8820C	6201300640	Aug. 16, 2017	Aug. 15, 2019
			Aug. 19, 2019	Aug. 18, 2020
Temperature & Humidity Chamber	GTH-120-40-CP-AR	MAA1306-019	Sep. 05, 2018	Sep. 04, 2019
			Sep. 06, 2019	Sep. 05, 2020
DC Power Supply Keysight	U8002A	MY56330015	NA	NA

- Note:
1. The calibration interval of the above test instruments is 12 / 24 months and the calibrations are traceable to NML/ROC and NIST/USA.
 2. The test was performed in HwaYa Chamber 10.

3 General Information

3.1 General Description of EUT

Product	Rugged Smart Phone	
Brand	CAT	
Test Model	S52	
Status of EUT	Identical Prototype	
Power Supply Rating	5-8 Vdc / 8.5-10 Vdc / 10-12 Vdc (adapter 1) 5.0 Vdc / 9.0 Vdc / 12.0 Vdc (adapter 2) 3.8 Vdc (Li-ion battery)	
Modulation Type	WCDMA	QPSK
	LTE	QPSK, 16QAM, 64QAM
Frequency Range	WCDMA	1712.4 ~ 1752.6 MHz
	LTE Band 4 (Channel Bandwidth: 1.4 MHz)	1710.7 ~ 1754.3 MHz
	LTE Band 4 (Channel Bandwidth: 3 MHz)	1711.5 ~ 1753.5 MHz
	LTE Band 4 (Channel Bandwidth: 5 MHz)	1712.5 ~ 1752.5 MHz
	LTE Band 4 (Channel Bandwidth: 10 MHz)	1715.0 ~ 1750.0 MHz
	LTE Band 4 (Channel Bandwidth: 15 MHz)	1717.5 ~ 1747.5 MHz
	LTE Band 4 (Channel Bandwidth: 20 MHz)	1720.0 ~ 1745.0 MHz
Emission Designator	WCDMA	4M19F9W
	LTE Band 4 (Channel Bandwidth: 1.4 MHz)	1M09D7W
	LTE Band 4 (Channel Bandwidth: 3 MHz)	2M70G7D
	LTE Band 4 (Channel Bandwidth: 5 MHz)	4M50D7W
	LTE Band 4 (Channel Bandwidth: 10 MHz)	8M99D7W
	LTE Band 4 (Channel Bandwidth: 15 MHz)	13M5G7D
	LTE Band 4 (Channel Bandwidth: 20 MHz)	18M0D7W
Max. EIRP Power	WCDMA	54.08 mW
	LTE Band 4 (Channel Bandwidth: 1.4 MHz)	42.56 mW
	LTE Band 4 (Channel Bandwidth: 3 MHz)	44.67 mW
	LTE Band 4 (Channel Bandwidth: 5 MHz)	48.42 mW
	LTE Band 4 (Channel Bandwidth: 10 MHz)	51.29 mW
	LTE Band 4 (Channel Bandwidth: 15 MHz)	53.83 mW
	LTE Band 4 (Channel Bandwidth: 20 MHz)	56.89 mW
Antenna Type	Loop Antenna with -5.2 dBi gain PIFA Antenna with -9.5 dBi gain	
Accessory Device	Refer to Note as below	
Data Cable Supplied	Refer to Note as below	

Note:

1. The EUT details of the sample are as follows.

Sample	Description
DS	Dual SIM
SS	Single SIM
* The samples have the same layout, circuit, and components, but different SIM tray.	

After pre-tested with the EUT, only the worst sample (Dual SIM) was chosen for the final test.

2. The EUT contains following accessory devices.

Product	Manufacture	Model	Description
Adapter 1	Lucent Trans Electronics Co., LTD.	1M52	I/P: 100-240 Vac, 50-60 Hz, 500 mA O/P: 5Vdc-8Vdc, 2.0A / 8.5Vdc-10Vdc, 1.7A / 10Vdc-12Vdc, 1.5A
Adapter 2	Jiangsu Chenyang Electron Co., LTD.	CK18W02U	I/P: 100-240 Vac, 50-60 Hz, 500 mA O/P: 5 Vdc, 3.0A / 9Vdc, 2.0A / 12Vdc, 1.5A
Battery	Apack Technology Co., LTD.	APP00307	3.8 Vdc, 3000 mAh
Earphone	Ganet Global LTD.	HF-AC04D-03 HF	1.2m non-shielded cable with core
USB Cable	Saibao (Jiangxi) Communication Industrial Co., LTD.	SRB-A001A	1.2m shielded cable with core

3. The above EUT information is declared by manufacturer and for more detailed features description, please refers to the manufacturer's specifications or user's manual.

3.2 Configuration of System under Test

<Radiated Emission Test>

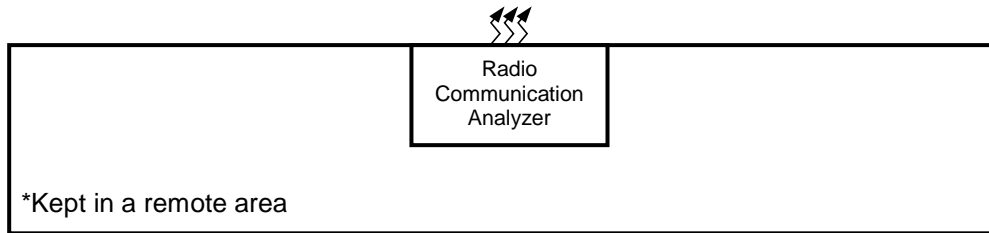
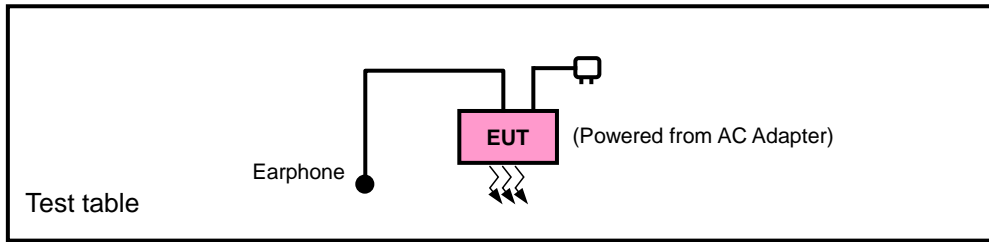

<E.I.R.P. Test>

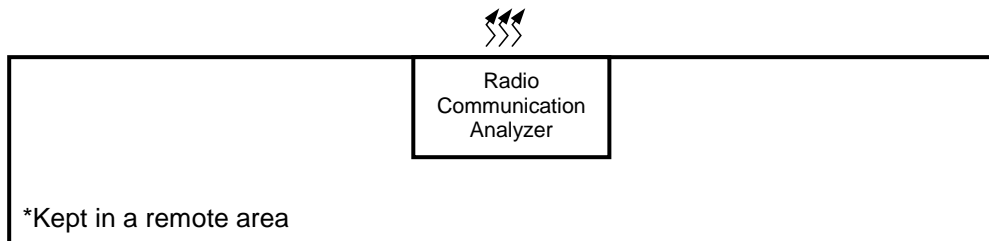
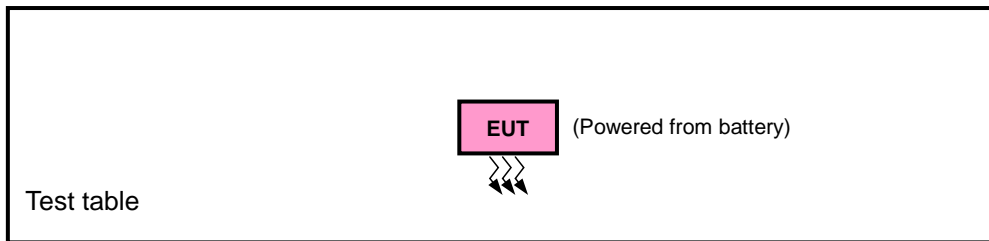

3.2.1 Description of Support Units

The EUT has been tested as an independent unit together with other necessary accessories or support units.

3.3 Test Mode Applicability and Tested Channel Detail

Pre-Scan has been conducted to determine the worst-case mode from all possible combinations between available modulations, data rates, XYZ axis, and antenna ports

The worst case was found when positioned as the table below. Following channel(s) was (were) selected for the final test as listed below:

Band	EIRP	Radiated Emission
WCDMA	Y-plane	Y-plane
LTE Band 4	Y-plane	X-plane

WCDMA

EUT Configure Mode	Test Item	Available Channel	Tested Channel	Mode
-	EIRP	1312 to 1513	1312, 1413, 1513	WCDMA
-	Modulation Characteristics	1312 to 1513	1413	WCDMA
-	Frequency Stability	1312 to 1513	1312, 1513	WCDMA
-	Occupied Bandwidth	1312 to 1513	1312, 1413, 1513	WCDMA
-	Band Edge	1312 to 1513	1312, 1513	WCDMA
-	Peak to Average Ratio	1312 to 1513	1312, 1413, 1513	WCDMA
-	Conducted Emission	1312 to 1513	1312, 1413, 1513	WCDMA
-	Radiated Emission	1312 to 1513	1312, 1413, 1513	WCDMA

LTE Band 4

EUT Configure Mode	Test Item	Available Channel	Tested Channel	Channel Bandwidth	Modulation	Mode
-	EIRP	19957 to 20393	19957, 20175, 20393	1.4 MHz	QPSK, 16QAM, 64QAM	3 RB / 0 RB Offset
		19965 to 20385	19965, 20175, 20385	3 MHz	QPSK, 16QAM, 64QAM	1 RB / 7 RB Offset
		19975 to 20375	19975, 20175, 20375	5 MHz	QPSK, 16QAM, 64QAM	1 RB / 12 RB Offset
		20000 to 20350	20000, 20175, 20350	10 MHz	QPSK, 16QAM, 64QAM	1 RB / 24 RB Offset
		20025 to 20325	20025, 20175, 20325	15 MHz	QPSK, 16QAM, 64QAM	1 RB / 37 RB Offset
		20050 to 20300	20050, 20175, 20300	20 MHz	QPSK, 16QAM, 64QAM	1 RB / 50 RB Offset
-	Modulation Characteristics	20050 to 20300	20175	20 MHz	QPSK, 16QAM, 64QAM	100 RB / 0 RB Offset
-	Frequency Stability	19957 to 20393	19957, 20393	1.4 MHz	QPSK	1 RB / 0 RB Offset
		19965 to 20385	19965, 20385	3 MHz	QPSK	1 RB / 0 RB Offset
		19975 to 20375	19975, 20375	5 MHz	QPSK	1 RB / 0 RB Offset
		20000 to 20350	20000, 20350	10 MHz	QPSK	1 RB / 0 RB Offset
		20025 to 20325	20025, 20325	15 MHz	QPSK	1 RB / 0 RB Offset
		20050 to 20300	20050, 20300	20 MHz	QPSK	1 RB / 0 RB Offset
-	Occupied Bandwidth	19957 to 20393	19957, 20175, 20393	1.4 MHz	QPSK, 16QAM, 64QAM	6 RB / 0 RB Offset
		19965 to 20385	19965, 20175, 20385	3 MHz	QPSK, 16QAM, 64QAM	15 RB / 0 RB Offset
		19975 to 20375	19975, 20175, 20375	5 MHz	QPSK, 16QAM, 64QAM	25 RB / 0 RB Offset
		20000 to 20350	20000, 20175, 20350	10 MHz	QPSK, 16QAM, 64QAM	50 RB / 0 RB Offset
		20025 to 20325	20025, 20175, 20325	15 MHz	QPSK, 16QAM, 64QAM	75 RB / 0 RB Offset
		20050 to 20300	20050, 20175, 20300	20 MHz	QPSK, 16QAM, 64QAM	100 RB / 0 RB Offset
-	Peak to Average Ratio	19957 to 20393	19957, 20175, 20393	1.4 MHz	QPSK, 16QAM, 64QAM	3 RB / 0 RB Offset
		19965 to 20385	19965, 20175, 20385	3 MHz	QPSK, 16QAM, 64QAM	1 RB / 7 RB Offset
		19975 to 20375	19975, 20175, 20375	5 MHz	QPSK, 16QAM, 64QAM	1 RB / 12 RB Offset
		20000 to 20350	20000, 20175, 20350	10 MHz	QPSK, 16QAM, 64QAM	1 RB / 24 RB Offset
		20025 to 20325	20025, 20175, 20325	15 MHz	QPSK, 16QAM, 64QAM	1 RB / 37 RB Offset
		20050 to 20300	20050, 20175, 20300	20 MHz	QPSK, 16QAM, 64QAM	1 RB / 50 RB Offset

EUT Configure Mode	Test Item	Available Channel	Tested Channel	Channel Bandwidth	Modulation	Mode		
-	Band Edge	19957 to 20393	19957	1.4 MHz	QPSK	1 RB / 0 RB Offset 6 RB / 0 RB Offset		
			20393	1.4 MHz	QPSK	1 RB / 5 RB Offset 6 RB / 0 RB Offset		
		19965 to 20385	19965	3 MHz	QPSK	1 RB / 0 RB Offset 15 RB / 0 RB Offset		
			20385	3 MHz	QPSK	1 RB / 14 RB Offset 15 RB / 0 RB Offset		
		19975 to 20375	19975	5 MHz	QPSK	1 RB / 0 RB Offset 25 RB / 0 RB Offset		
			20375	5 MHz	QPSK	1 RB / 24 RB Offset 25 RB / 0 RB Offset		
		20000 to 20350	20000	10 MHz	QPSK	1 RB / 0 RB Offset 50 RB / 0 RB Offset		
			20350	10 MHz	QPSK	1 RB / 49 RB Offset 50 RB / 0 RB Offset		
		20025 to 20325	20025	15 MHz	QPSK	1 RB / 0 RB Offset 75 RB / 0 RB Offset		
			20325	15 MHz	QPSK	1 RB / 74 RB Offset 75 RB / 0 RB Offset		
		20050 to 20300	20050	20 MHz	QPSK	1 RB / 0 RB Offset 100 RB / 0 RB Offset		
			20300	20 MHz	QPSK	1 RB / 99 RB Offset 100 RB / 0 RB Offset		
		-	Conducted Emission	19957 to 20393	19957, 20175, 20393	1.4 MHz	QPSK	3 RB / 0 RB Offset
				19965 to 20385	19965, 20175, 20385	3 MHz	QPSK	1 RB / 7 RB Offset
				19975 to 20375	19975, 20175, 20375	5 MHz	QPSK	1 RB / 12 RB Offset
				20000 to 20350	20000, 20175, 20350	10 MHz	QPSK	1 RB / 24 RB Offset
				20025 to 20325	20025, 20175, 20325	15 MHz	QPSK	1 RB / 37 RB Offset
				20050 to 20300	20050, 20175, 20300	20 MHz	QPSK	1 RB / 50 RB Offset
-	Radiated Emission	19957 to 20393	19957, 20175, 20393	1.4 MHz	QPSK	3 RB / 0 RB Offset		
		19975 to 20375	19975, 20175, 20375	5 MHz	QPSK	1 RB / 12 RB Offset		
		20050 to 20300	20050, 20175, 20300	20 MHz	QPSK	1 RB / 50 RB Offset		

Note:

1. This device was tested under all bandwidths, RB configurations and modulations. The worst case was found in QPSK modulation.
2. For radiated emission above 1 GHz, according to 3GPP 36.521 Section 6.6.3.1.4, choose the lowest, 5 MHz & highest channel bandwidth for final test.

Test Condition:

Test Item	Environmental Conditions	Input Power	Tested By
EIRP	25 deg. C, 65 % RH	3.8 Vdc	Thomas Wei
Modulation Characteristics	25 deg. C, 65 % RH	3.8 Vdc	Wayne Lin
Frequency Stability	25 deg. C, 65 % RH	3.8 Vdc	Wayne Lin
Occupied Bandwidth	25 deg. C, 65 % RH	3.8 Vdc	Wayne Lin
Band Edge	25 deg. C, 65 % RH	3.8 Vdc	Wayne Lin
Peak to Average Ratio	25 deg. C, 65 % RH	3.8 Vdc	Wayne Lin
Conducted Emission	25 deg. C, 65 % RH	3.8 Vdc	Wayne Lin
Radiated Emission	25 deg. C, 65 % RH	120 Vac, 60 Hz	Thomas Wei

3.4 EUT Operating Conditions

The EUT makes a call to the communication simulator. The communication simulator station system controlled a EUT to export maximum output power under transmission mode and specific channel frequency

3.5 General Description of Applied Standards

The EUT is a RF Product. According to the specifications of the manufacturer, it must comply with the requirements of the following standards:

FCC 47 CFR Part 2

FCC 47 CFR Part 27

KDB 971168 D01 Power Meas License Digital Systems v03r01

ANSI/TIA/EIA-603-E 2016

ANSI 63.26-2015

Note: All test items have been performed and recorded as per the above standards.

4 Test Types and Results

4.1 Output Power Measurement

4.1.1 Limits of Output Power Measurement

Fixed, mobile, and portable (hand-held) stations operating in the 1710–1755 MHz band and mobile and portable stations operating in the 1695-1710 MHz and 1755-1780 MHz bands are limited to 1 watt EIRP.

4.1.2 Test Procedures

EIRP / ERP Measurement:

- a. All measurements were done at low, middle and high operational frequency range. RBW and VBW is 5 MHz for WCDMA and 10 MHz for LTE mode.
- b. Substitution method is used for E.I.R.P measurement. In the semi-anechoic chamber, EUT placed on the 0.8 m (below or equal 1 GHz) and/or 1.5 m (above 1 GHz) height of Turn Table, rotated the table around 360 degrees to search the maximum radiation power and receiver antenna shall be rotated vertical and horizontal polarization and moved height from 1 m to 4 m to find the maximum polar radiated power. The “Read Value” is the spectrum reading the maximum power value.
- c. The substitution horn antenna is substituted for EUT at the same position and signals generator export the CW signal to the substitution antenna via a tx cable. Rotated the Turn Table and moved receiving antenna to find the maximum radiation power. Adjust output power level of S.G to get a Value of spectrum reading equal to “Read Value” of step b. Record the power level of S.G.
- d. $EIRP = \text{Output power level of S.G} - \text{TX cable loss} + \text{Antenna gain of substitution horn}$. E.R.P power can be calculated form E.I.R.P power by subtracting the gain of dipole, $E.R.P \text{ power} = E.I.R.P \text{ power} - 2.15 \text{ dB}$.

Conducted Power Measurement:

- a. The EUT was set up for the maximum power with WCDMA and LTE link data modulation and link up with simulator.
- b. Set the EUT to transmit under low, middle and high channel and record the power level shown on simulator.

4.1.3 Test Setup

EIRP / ERP Measurement:

<Radiated Emission below or equal 1 GHz>

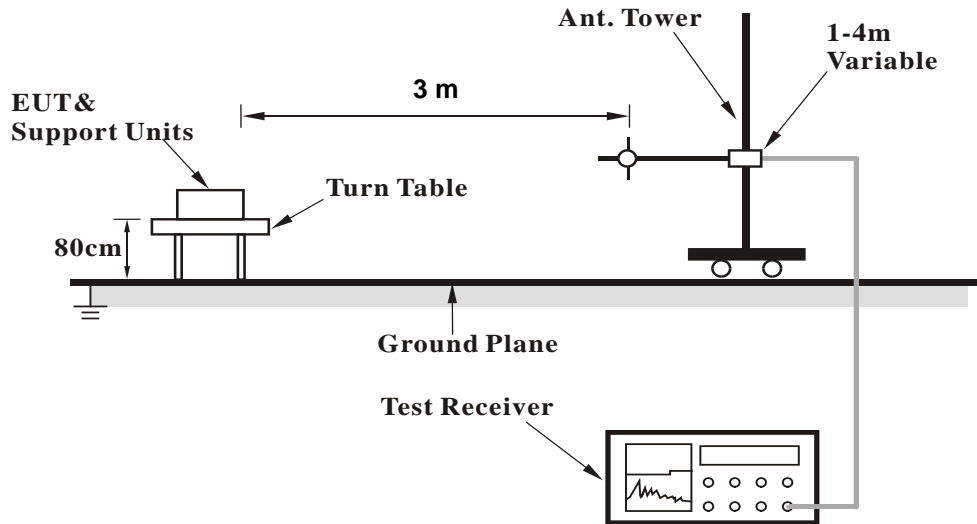

<Radiated Emission above 1 GHz>

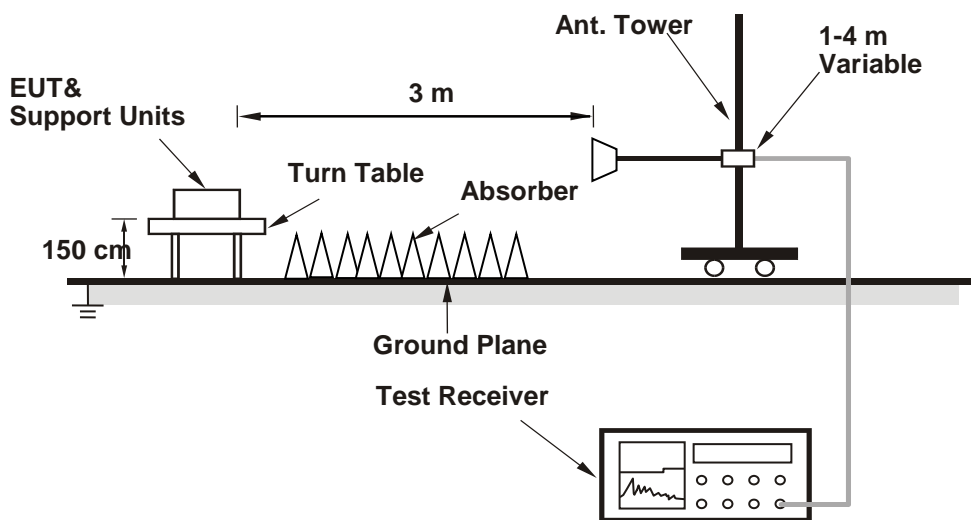

For the actual test configuration, please refer to the attached file (Test Setup Photo).

Conducted Power Measurement:



4.1.4 Test Results

Conducted Output Power (dBm)

Band	WCDMA IV		
	1312	1413	1513
Channel	1712.4	1732.6	1752.6
Frequency (MHz)	1712.4	1732.6	1752.6
RMC 12.2K	23.21	23.27	23.25
HSDPA Subtest-1	21.85	21.90	21.88
HSDPA Subtest-2	21.83	21.89	21.85
HSDPA Subtest-3	21.39	21.44	21.42
HSDPA Subtest-4	20.95	21.01	20.99
DC-HSDPA Subtest-1	21.78	21.83	21.81
DC-HSDPA Subtest-2	21.76	21.82	21.78
DC-HSDPA Subtest-3	21.32	21.37	21.36
DC-HSDPA Subtest-4	20.89	20.94	20.92
HSUPA Subtest-1	21.42	21.48	21.46
HSUPA Subtest-2	19.96	20.02	20.01
HSUPA Subtest-3	20.93	20.98	20.96
HSUPA Subtest-4	19.42	19.48	19.47
HSUPA Subtest-5	21.02	21.01	21.03

LTE Band 4

BW	MCS Index	RB Size	RB Offset	Low	Mid	High	3GPP MPR (dB)	BW	MCS Index	RB Size	RB Offset	Low	Mid	High	3GPP MPR (dB)				
				Channel	20050	20175						20300	Channel	20025		20175	20325		
				Frequency (MHz)	1720.0	1732.5						1745.0	Frequency (MHz)	1717.5		1732.5	1747.5		
20M	QPSK	1	0	22.67	22.73	22.74	0	15M	QPSK	1	0	22.65	22.65	22.74	0				
		1	50	23.01	23.09	23.11	0			1	37	22.94	23.05	23.09	0				
		1	99	22.75	22.80	22.82	0			1	74	22.70	22.70	22.77	0				
		50	0	22.12	22.18	22.20	1			36	0	22.02	22.12	22.18	1				
		50	25	22.06	22.09	22.12	1			36	19	22.00	22.03	22.09	1				
		50	50	22.03	22.06	22.08	1			36	39	21.99	21.96	22.00	1				
	100	0	22.09	22.18	22.19	1	75		0	22.04	22.18	22.13	1						
	16QAM	1	0	22.18	22.27	22.28	1		16QAM	1	0	22.14	22.22	22.28	1				
		1	50	22.41	22.47	22.50	1			1	37	22.40	22.42	22.49	1				
		1	99	22.17	22.21	22.22	1			1	74	22.09	22.16	22.17	1				
		50	0	21.24	21.30	21.33	2			36	0	21.18	21.22	21.33	2				
		50	25	21.18	21.22	21.24	2			36	19	21.09	21.20	21.15	2				
		50	50	21.11	21.16	21.17	2			36	39	21.02	21.08	21.14	2				
	100	0	21.17	21.21	21.26	2	75		0	21.10	21.21	21.21	2						
	64QAM	1	0	20.87	20.93	20.94	2		64QAM	1	0	20.79	20.88	20.89	2				
		1	50	21.25	21.32	21.35	2			1	37	21.15	21.31	21.29	2				
		1	99	20.96	21.05	21.06	2			1	74	20.93	21.02	21.06	2				
		50	0	20.17	20.27	20.30	3			36	0	20.16	20.18	20.27	3				
		50	25	20.12	20.18	20.22	3			36	19	20.06	20.13	20.14	3				
		50	50	20.10	20.14	20.17	3			36	39	20.01	20.06	20.15	3				
	100	0	20.15	20.25	20.28	3	75		0	20.11	20.22	20.28	3						
	BW	MCS Index	RB Size	RB Offset	Low	Mid	High		3GPP MPR (dB)	BW	MCS Index	RB Size	RB Offset	Low	Mid	High	3GPP MPR (dB)		
					Channel	20000	20175							20350	Channel	19975		20175	20375
					Frequency (MHz)	1715.0	1732.5							1750.0	Frequency (MHz)	1712.5		1732.5	1752.5
10M	QPSK	1	0	22.61	22.72	22.67	0	5M	QPSK	1	0	22.60	22.48	22.42	0				
		1	24	22.93	22.99	22.98	0			1	12	22.88	23.01	22.97	0				
		1	49	22.55	22.69	22.63	0			1	24	22.60	22.62	22.50	0				
		25	0	21.97	22.13	22.01	1			12	0	21.98	22.07	22.04	1				
		25	12	22.01	21.94	22.05	1			12	6	21.95	21.92	21.77	1				
		25	25	21.93	21.98	21.94	1			12	13	21.95	21.87	21.91	1				
	50	0	21.92	22.00	22.05	1	25		0	21.89	22.07	22.05	1						
	16QAM	1	0	22.01	22.13	22.09	1		16QAM	1	0	22.06	22.19	22.13	1				
		1	24	22.26	22.25	22.45	1			1	12	22.26	22.33	22.36	1				
		1	49	22.09	22.13	22.06	1			1	24	22.04	22.10	22.22	1				
		25	0	21.05	21.24	21.27	2			12	0	21.04	21.21	21.10	2				
		25	12	21.09	21.13	21.10	2			12	6	21.06	21.09	21.11	2				
		25	25	21.01	21.10	21.08	2			12	13	20.98	21.07	21.13	2				
	50	0	21.04	21.16	21.25	2	25		0	21.07	21.06	21.19	2						
	64QAM	1	0	20.78	20.74	20.86	2		64QAM	1	0	20.66	20.72	20.86	2				
		1	24	21.10	21.16	21.22	2			1	12	21.11	21.19	21.26	2				
		1	49	20.76	20.90	20.86	2			1	24	20.79	20.93	21.01	2				
		25	0	20.08	20.10	20.10	3			12	0	20.13	20.17	20.18	3				
		25	12	20.04	20.06	20.07	3			12	6	20.06	20.01	20.09	3				
		25	25	19.95	19.90	20.01	3			12	13	20.09	20.03	20.08	3				
	50	0	20.02	20.20	20.16	3	25		0	20.03	20.14	20.06	3						
	BW	MCS Index	RB Size	RB Offset	Low	Mid	High		3GPP MPR (dB)	BW	MCS Index	RB Size	RB Offset	Low	Mid	High	3GPP MPR (dB)		
					Channel	19965	20175							20385	Channel	19957		20175	20393
					Frequency (MHz)	1711.5	1732.5							1753.5	Frequency (MHz)	1710.7		1732.5	1754.3
3M	QPSK	1	0	22.55	22.69	22.55	0	1.4M	QPSK	1	0	22.60	22.57	22.66	0				
		1	7	22.99	23.02	22.96	0			1	2	22.94	22.95	22.94	0				
		1	14	22.63	22.64	22.67	0			1	5	22.67	22.64	22.68	0				
		8	0	22.03	21.99	22.10	1			3	0	22.94	23.08	23.08	0				
		8	3	22.03	21.94	21.95	1			3	1	22.95	22.92	22.92	0				
		8	7	21.89	22.00	21.87	1			3	3	22.90	22.89	23.02	0				
	15	0	21.97	22.06	22.01	1	6		0	21.98	22.13	22.11	1						
	16QAM	1	0	22.04	22.05	22.09	1		16QAM	1	0	21.97	22.20	22.11	1				
		1	7	22.35	22.42	22.45	1			1	2	22.29	22.26	22.36	1				
		1	14	22.00	22.13	22.13	1			1	5	22.01	22.09	22.03	1				
		8	0	21.14	21.28	21.24	2			3	0	22.16	22.23	22.13	1				
		8	3	21.16	21.14	21.08	2			3	1	21.99	22.21	22.08	1				
		8	7	20.92	21.13	21.07	2			3	3	21.98	22.03	22.00	1				
	15	0	20.99	21.08	21.20	2	6		0	21.07	21.11	21.11	2						
	64QAM	1	0	20.73	20.79	20.86	2		64QAM	1	0	20.79	20.84	20.83	2				
		1	7	21.11	21.24	21.21	2			1	2	21.17	21.17	21.16	2				
		1	14	20.83	21.03	20.84	2			1	5	20.85	20.91	20.86	2				
		8	0	20.03	20.16	20.13	3			3	0	21.10	21.12	21.17	2				
		8	3	19.92	20.02	20.08	3			3	1	21.04	21.04	21.10	2				
		8	7	19.93	20.03	20.09	3			3	3	20.98	21.02	20.99	2				
	15	0	20.08	20.05	20.15	3	6		0	19.93	20.02	20.19	3						

EIRP Power (dBm)

WCDMA							
Plane	Channel	Frequency (MHz)	Reading (dBm)	Correction Factor (dB)	EIRP (dBm)	EIRP (mW)	Polarization (H/V)
Y	1312	1712.4	-26.07	36.29	10.22	10.52	H
	1413	1732.6	-26.34	36.69	10.35	10.84	
	1513	1752.6	-26.71	36.98	10.27	10.64	
	1312	1712.4	-19.93	37.11	17.18	52.24	V
	1413	1732.6	-20.27	37.60	17.33	54.08	
	1513	1752.6	-20.40	37.65	17.25	53.09	

Note: EIRP (dBm) = Reading (dBm) + Correction Factor (dB)

LTE Band 4							
Channel Bandwidth: 1.4 MHz / QPSK							
Plane	Channel	Frequency (MHz)	Reading (dBm)	Correction Factor (dB)	EIRP (dBm)	EIRP (mW)	Polarization (H/V)
Y	19957	1710.7	-27.36	36.45	9.09	8.11	H
	20175	1732.5	-27.42	36.80	9.38	8.67	
	20393	1754.3	-27.63	36.94	9.31	8.53	
	19957	1710.7	-21.46	37.28	15.82	38.19	V
	20175	1732.5	-21.34	37.63	16.29	42.56	
	20393	1754.3	-21.46	37.64	16.18	41.50	
Channel Bandwidth: 1.4 MHz / 16QAM							
Y	19957	1710.7	-28.29	36.45	8.16	6.55	H
	20175	1732.5	-28.25	36.80	8.55	7.16	
	20393	1754.3	-28.67	36.94	8.27	6.71	
	19957	1710.7	-22.44	37.28	14.84	30.48	V
	20175	1732.5	-22.51	37.63	15.12	32.51	
	20393	1754.3	-22.55	37.64	15.09	32.28	
Channel Bandwidth: 1.4 MHz / 64QAM							
Y	19957	1710.7	-29.37	36.45	7.08	5.11	H
	20175	1732.5	-29.51	36.80	7.29	5.36	
	20393	1754.3	-29.71	36.94	7.23	5.28	
	19957	1710.7	-23.54	37.28	13.74	23.66	V
	20175	1732.5	-23.34	37.63	14.29	26.85	
	20393	1754.3	-23.63	37.64	14.01	25.18	

Note: EIRP (dBm) = Reading (dBm) + Correction Factor (dB)

LTE Band 4							
Channel Bandwidth: 3 MHz / QPSK							
Plane	Channel	Frequency (MHz)	Reading (dBm)	Correction Factor (dB)	EIRP (dBm)	EIRP (mW)	Polarization (H/V)
Y	19965	1711.5	-27.13	36.45	9.32	8.55	H
	20175	1732.5	-27.11	36.80	9.69	9.31	
	20385	1753.5	-27.36	36.94	9.58	9.08	
	19965	1711.5	-21.15	37.28	16.13	41.02	V
	20175	1732.5	-21.13	37.63	16.50	44.67	
	20385	1753.5	-21.17	37.64	16.47	44.36	
Channel Bandwidth: 3 MHz / 16QAM							
Y	19965	1711.5	-28.01	36.45	8.44	6.98	H
	20175	1732.5	-28.03	36.80	8.77	7.53	
	20385	1753.5	-28.34	36.94	8.60	7.24	
	19965	1711.5	-22.19	37.28	15.09	32.28	V
	20175	1732.5	-22.21	37.63	15.42	34.83	
	20385	1753.5	-22.31	37.64	15.33	34.12	
Channel Bandwidth: 3 MHz / 64QAM							
Y	19965	1711.5	-29.08	36.45	7.37	5.46	H
	20175	1732.5	-29.22	36.80	7.58	5.73	
	20385	1753.5	-29.38	36.94	7.56	5.70	
	19965	1711.5	-23.29	37.28	13.99	25.06	V
	20175	1732.5	-23.13	37.63	14.50	28.18	
	20385	1753.5	-23.36	37.64	14.28	26.79	

Note: EIRP (dBm) = Reading (dBm) + Correction Factor (dB)

LTE Band 4							
Channel Bandwidth: 5 MHz / QPSK							
Plane	Channel	Frequency (MHz)	Reading (dBm)	Correction Factor (dB)	EIRP (dBm)	EIRP (mW)	Polarization (H/V)
Y	19975	1712.5	-26.78	36.45	9.67	9.27	H
	20175	1732.5	-26.80	36.80	10.00	10.00	
	20375	1752.5	-27.15	36.94	9.79	9.53	
	19975	1712.5	-20.81	37.28	16.47	44.36	V
	20175	1732.5	-20.78	37.63	16.85	48.42	
	20375	1752.5	-20.95	37.64	16.69	46.67	
Channel Bandwidth: 5 MHz / 16QAM							
Y	19975	1712.5	-27.75	36.45	8.70	7.41	H
	20175	1732.5	-27.81	36.80	8.99	7.93	
	20375	1752.5	-28.12	36.94	8.82	7.62	
	19975	1712.5	-21.97	37.28	15.31	33.96	V
	20175	1732.5	-21.90	37.63	15.73	37.41	
	20375	1752.5	-22.04	37.64	15.60	36.31	
Channel Bandwidth: 5 MHz / 64QAM							
Y	19975	1712.5	-28.84	36.45	7.61	5.77	H
	20175	1732.5	-28.92	36.80	7.88	6.14	
	20375	1752.5	-29.09	36.94	7.85	6.10	
	19975	1712.5	-23.08	37.28	14.20	26.30	V
	20175	1732.5	-22.81	37.63	14.82	30.34	
	20375	1752.5	-23.15	37.64	14.49	28.12	

Note: EIRP (dBm) = Reading (dBm) + Correction Factor (dB)

LTE Band 4							
Channel Bandwidth: 10 MHz / QPSK							
Plane	Channel	Frequency (MHz)	Reading (dBm)	Correction Factor (dB)	EIRP (dBm)	EIRP (mW)	Polarization (H/V)
Y	20000	1715.0	-26.73	36.64	9.91	9.79	H
	20175	1732.5	-26.60	36.80	10.20	10.47	
	20350	1750.0	-26.80	36.80	10.00	10.00	
	20000	1715.0	-20.68	37.44	16.76	47.42	V
	20175	1732.5	-20.53	37.63	17.10	51.29	
	20350	1750.0	-20.75	37.64	16.89	48.87	
Channel Bandwidth: 10 MHz / 16QAM							
Y	20000	1715.0	-27.72	36.64	8.92	7.80	H
	20175	1732.5	-27.55	36.80	9.25	8.41	
	20350	1750.0	-27.76	36.80	9.04	8.02	
	20000	1715.0	-21.83	37.44	15.61	36.39	V
	20175	1732.5	-21.64	37.63	15.99	39.72	
	20350	1750.0	-21.80	37.64	15.84	38.37	
Channel Bandwidth: 10 MHz / 64QAM							
Y	20000	1715.0	-28.83	36.64	7.81	6.04	H
	20175	1732.5	-28.66	36.80	8.14	6.52	
	20350	1750.0	-28.72	36.80	8.08	6.43	
	20000	1715.0	-22.97	37.44	14.47	27.99	V
	20175	1732.5	-22.57	37.63	15.06	32.06	
	20350	1750.0	-22.95	37.64	14.69	29.44	

Note: EIRP (dBm) = Reading (dBm) + Correction Factor (dB)

LTE Band 4							
Channel Bandwidth: 15 MHz / QPSK							
Plane	Channel	Frequency (MHz)	Reading (dBm)	Correction Factor (dB)	EIRP (dBm)	EIRP (mW)	Polarization (H/V)
Y	20025	1717.5	-26.19	36.45	10.26	10.62	H
	20175	1732.5	-26.39	36.80	10.41	10.99	
	20325	1747.5	-26.60	36.94	10.34	10.81	
	20025	1717.5	-20.17	37.28	17.11	51.40	V
	20175	1732.5	-20.32	37.63	17.31	53.83	
	20325	1747.5	-20.41	37.64	17.23	52.84	
Channel Bandwidth: 15 MHz / 16QAM							
Y	20025	1717.5	-27.28	36.45	9.17	8.27	H
	20175	1732.5	-27.30	36.80	9.50	8.91	
	20325	1747.5	-27.64	36.94	9.30	8.51	
	20025	1717.5	-21.42	37.28	15.86	38.55	V
	20175	1732.5	-21.35	37.63	16.28	42.46	
	20325	1747.5	-21.53	37.64	16.11	40.83	
Channel Bandwidth: 15 MHz / 64QAM							
Y	20025	1717.5	-28.32	36.45	8.13	6.50	H
	20175	1732.5	-28.36	36.80	8.44	6.98	
	20325	1747.5	-28.66	36.94	8.28	6.73	
	20025	1717.5	-22.53	37.28	14.75	29.85	V
	20175	1732.5	-22.33	37.63	15.30	33.88	
	20325	1747.5	-22.73	37.64	14.91	30.97	

Note: EIRP (dBm) = Reading (dBm) + Correction Factor (dB)

LTE Band 4							
Channel Bandwidth: 20 MHz / QPSK							
Plane	Channel	Frequency (MHz)	Reading (dBm)	Correction Factor (dB)	EIRP (dBm)	EIRP (mW)	Polarization (H/V)
Y	20050	1720.0	-25.84	36.45	10.61	11.51	H
	20175	1732.5	-26.05	36.80	10.75	11.89	
	20300	1745.0	-26.26	36.94	10.68	11.69	
	20050	1720.0	-19.88	37.28	17.40	54.95	V
	20175	1732.5	-20.08	37.63	17.55	56.89	
	20300	1745.0	-20.15	37.64	17.49	56.10	
Channel Bandwidth: 20 MHz / 16QAM							
Y	20050	1720.0	-27.00	36.45	9.45	8.81	H
	20175	1732.5	-26.93	36.80	9.87	9.71	
	20300	1745.0	-27.33	36.94	9.61	9.14	
	20050	1720.0	-21.13	37.28	16.15	41.21	V
	20175	1732.5	-21.03	37.63	16.60	45.71	
	20300	1745.0	-21.32	37.64	16.32	42.85	
Channel Bandwidth: 20 MHz / 64QAM							
Y	20050	1720.0	-28.02	36.45	8.43	6.97	H
	20175	1732.5	-28.10	36.80	8.70	7.41	
	20300	1745.0	-28.38	36.94	8.56	7.18	
	20050	1720.0	-22.21	37.28	15.07	32.14	V
	20175	1732.5	-22.13	37.63	15.50	35.48	
	20300	1745.0	-22.44	37.64	15.20	33.11	

Note: EIRP (dBm) = Reading (dBm) + Correction Factor (dB)

4.2 Modulation Characteristics Measurement

4.2.1 Limits of Modulation Characteristics

N/A

4.2.2 Test Setup



4.2.3 Test Procedure

Connect the EUT to Communication Simulator via the antenna connector. The frequency band is set as EUT supported Modulation and Channels, the EUT output is matched with 50 ohm load, the waveform quality and constellation of the EUT was tested.

4.2.4 Test Results

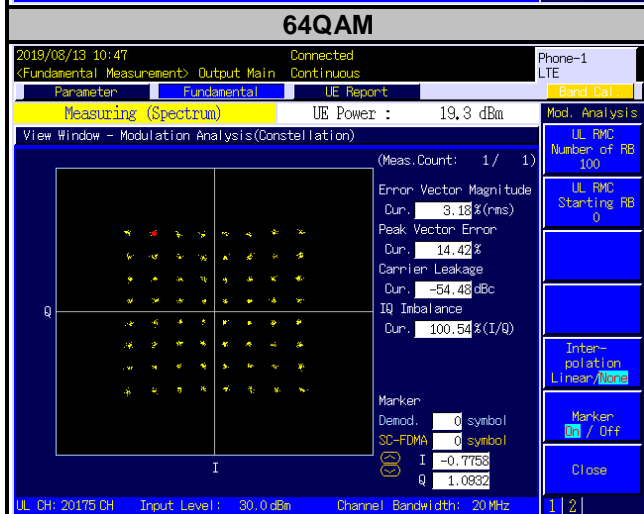
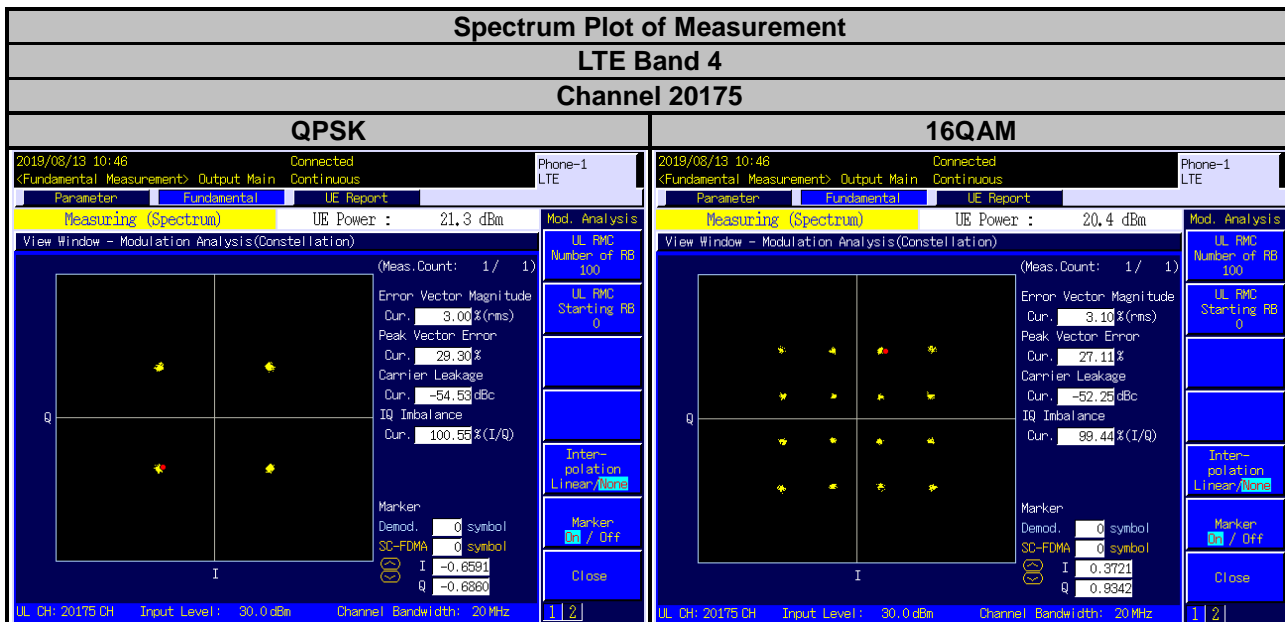
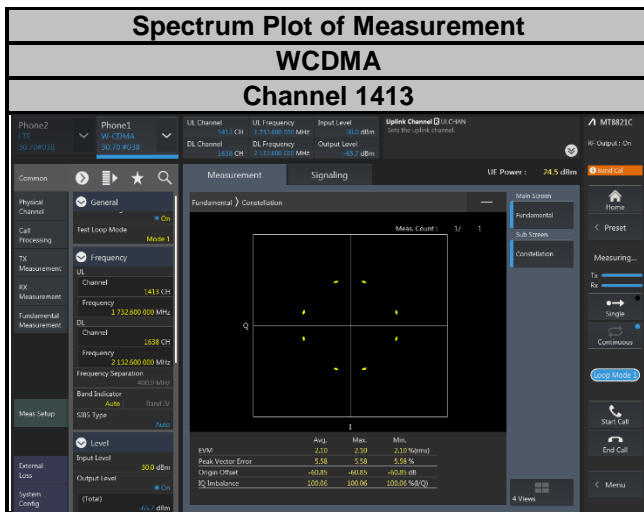

4.3 Frequency Stability Measurement

4.3.1 Limits of Frequency Stability Measurement

The frequency stability shall be sufficient to ensure that the fundamental emissions stay within the authorized bands of operation.

4.3.2 Test Procedure

- a. Device is placed at the oven room. The oven room could control the temperatures and humidity. Power warm up is at least 15 min and power applied should perform before recording frequency error.
- b. EUT is connected the external power supply to control the DC input power. The test voltage range is from minimum to maximum working voltage. Each step shall be record the frequency error rate.
- c. The temperature range step is 10 degrees in this test items. All temperature levels shall be hold the $\pm 0.5^{\circ}\text{C}$ during the measurement testing. The each temperature step shall be at least 0.5 hours, consider the EUT could be test under the stability condition.

Note: The frequency error was recorded frequency error from the communication simulator.

4.3.3 Test Setup

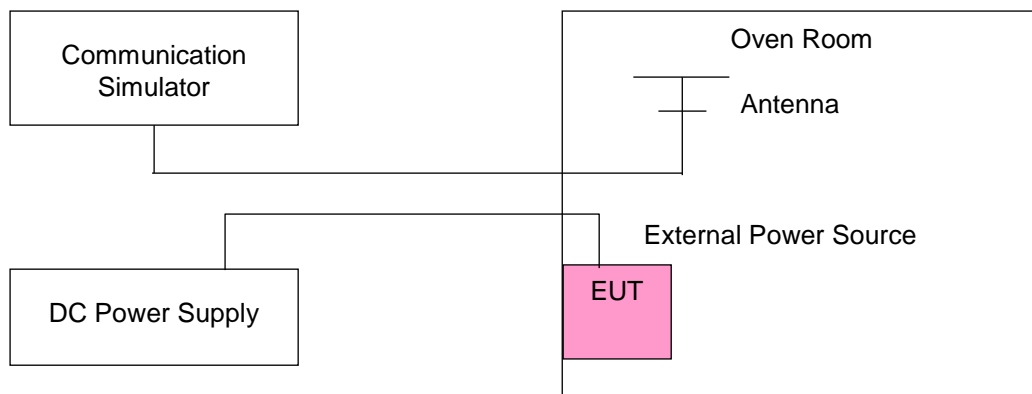

4.3.4 Test Results

Frequency Error vs. Voltage

Voltage (Volts)	WCDMA			
	Low Channel		High Channel	
	Frequency (MHz)	Frequency Error (ppm)	Frequency (MHz)	Frequency Error (ppm)
3.8	1712.400003	0.002	1752.600003	0.002
3.4	1712.400002	0.001	1752.600002	0.001
4.35	1712.400004	0.002	1752.600004	0.002

Note: The applicant defined the normal working voltage of the battery is from 3.4 Vdc to 4.35 Vdc.

Frequency Error vs. Temperature

Temp. (°C)	WCDMA			
	Low Channel		High Channel	
	Frequency (MHz)	Frequency Error (ppm)	Frequency (MHz)	Frequency Error (ppm)
-25	1712.400002	0.001	1752.600004	0.002
-20	1712.400003	0.002	1752.600004	0.002
-10	1712.400002	0.001	1752.600002	0.001
0	1712.400002	0.001	1752.600002	0.001
10	1712.400003	0.002	1752.600001	0.001
20	1712.399996	-0.002	1752.599996	-0.002
30	1712.399998	-0.001	1752.599999	-0.001
40	1712.399999	-0.001	1752.599997	-0.002
50	1712.399997	-0.002	1752.599999	-0.001
55	1712.399997	-0.002	1752.599997	-0.001

Note:

1. The applicant declared that the normal operating temperature of the EUT is from -25°C to 55°C.
2. The EUT would shut down automatically as below -25°C.

Frequency Error vs. Voltage

Voltage (Volts)	LTE Band 4			
	Channel Bandwidth: 1.4 MHz			
	Low Channel		High Channel	
	Frequency (MHz)	Frequency Error (ppm)	Frequency (MHz)	Frequency Error (ppm)
3.8	1710.700003	0.002	1754.300003	0.002
3.4	1710.700004	0.002	1754.300003	0.001
4.35	1710.700003	0.002	1754.300003	0.002

Note: The applicant defined the normal working voltage of the battery is from 3.4 Vdc to 4.35 Vdc.

Frequency Error vs. Temperature

Temp. (°C)	LTE Band 4			
	Channel Bandwidth: 1.4 MHz			
	Low Channel		High Channel	
	Frequency (MHz)	Frequency Error (ppm)	Frequency (MHz)	Frequency Error (ppm)
-25	1710.700004	0.002	1754.300003	0.002
-20	1710.700003	0.002	1754.300002	0.001
-10	1710.700003	0.002	1754.300002	0.001
0	1710.700003	0.001	1754.300001	0.001
10	1710.700004	0.002	1754.300001	0.001
20	1710.699999	-0.001	1754.299997	-0.002
30	1710.699998	-0.001	1754.299997	-0.002
40	1710.699998	-0.001	1754.299997	-0.002
50	1710.699997	-0.002	1754.299997	-0.002
55	1710.699997	-0.002	1754.299997	-0.002

Note:

1. The applicant declared that the normal operating temperature of the EUT is from -25°C to 55°C.
2. The EUT would shut down automatically as below -25°C.

Frequency Error vs. Voltage

Voltage (Volts)	LTE Band 4			
	Channel Bandwidth: 3 MHz			
	Low Channel		High Channel	
	Frequency (MHz)	Frequency Error (ppm)	Frequency (MHz)	Frequency Error (ppm)
3.8	1711.500004	0.002	1753.500003	0.001
3.4	1711.500003	0.002	1753.500002	0.001
4.35	1711.500002	0.001	1753.500001	0.001

Note: The applicant defined the normal working voltage of the battery is from 3.4 Vdc to 4.35 Vdc.

Frequency Error vs. Temperature

Temp. (°C)	LTE Band 4			
	Channel Bandwidth: 3 MHz			
	Low Channel		High Channel	
	Frequency (MHz)	Frequency Error (ppm)	Frequency (MHz)	Frequency Error (ppm)
-25	1711.500002	0.001	1753.500001	0.001
-20	1711.500002	0.001	1753.500001	0.001
-10	1711.500002	0.001	1753.500002	0.001
0	1711.500003	0.002	1753.500002	0.001
10	1711.500001	0.001	1753.500004	0.002
20	1711.499999	-0.001	1753.499997	-0.002
30	1711.499999	-0.001	1753.499999	-0.001
40	1711.499996	-0.002	1753.499998	-0.001
50	1711.499997	-0.002	1753.499997	-0.002
55	1711.499998	-0.001	1753.499996	-0.002

Note:

1. The applicant declared that the normal operating temperature of the EUT is from -25°C to 55°C.
2. The EUT would shut down automatically as below -25°C.

Frequency Error vs. Voltage

Voltage (Volts)	LTE Band 4			
	Channel Bandwidth: 5 MHz			
	Low Channel		High Channel	
	Frequency (MHz)	Frequency Error (ppm)	Frequency (MHz)	Frequency Error (ppm)
3.8	1712.500002	0.001	1752.500004	0.002
3.4	1712.500003	0.002	1752.500002	0.001
4.35	1712.500003	0.002	1752.500003	0.002

Note: The applicant defined the normal working voltage of the battery is from 3.4 Vdc to 4.35 Vdc.

Frequency Error vs. Temperature

Temp. (°C)	LTE Band 4			
	Channel Bandwidth: 5 MHz			
	Low Channel		High Channel	
	Frequency (MHz)	Frequency Error (ppm)	Frequency (MHz)	Frequency Error (ppm)
-25	1712.500001	0.001	1752.500001	0.001
-20	1712.500004	0.002	1752.500003	0.002
-10	1712.500001	0.001	1752.500001	0.001
0	1712.500002	0.001	1752.500002	0.001
10	1712.500004	0.002	1752.500002	0.001
20	1712.499997	-0.002	1752.499999	-0.001
30	1712.499997	-0.002	1752.499998	-0.001
40	1712.499997	-0.002	1752.499997	-0.002
50	1712.499997	-0.002	1752.499999	-0.001
55	1712.499997	-0.002	1752.499997	-0.002

Note:

1. The applicant declared that the normal operating temperature of the EUT is from -25°C to 55°C.
2. The EUT would shut down automatically as below -25°C.

Frequency Error vs. Voltage

Voltage (Volts)	LTE Band 4			
	Channel Bandwidth: 10 MHz			
	Low Channel		High Channel	
	Frequency (MHz)	Frequency Error (ppm)	Frequency (MHz)	Frequency Error (ppm)
3.8	1715.000001	0.001	1750.000004	0.002
3.4	1715.000002	0.001	1750.000003	0.002
4.35	1715.000002	0.001	1750.000002	0.001

Note: The applicant defined the normal working voltage of the battery is from 3.4 Vdc to 4.35 Vdc.

Frequency Error vs. Temperature

Temp. (°C)	LTE Band 4			
	Channel Bandwidth: 10 MHz			
	Low Channel		High Channel	
	Frequency (MHz)	Frequency Error (ppm)	Frequency (MHz)	Frequency Error (ppm)
-25	1715.000004	0.002	1750.000001	0.001
-20	1715.000002	0.001	1750.000004	0.002
-10	1715.000001	0.001	1750.000001	0.001
0	1715.000004	0.002	1750.000002	0.001
10	1715.000004	0.002	1750.000002	0.001
20	1714.999996	-0.002	1749.999999	-0.001
30	1714.999999	-0.001	1749.999996	-0.002
40	1714.999998	-0.001	1749.999997	-0.002
50	1714.999998	-0.001	1749.999998	-0.001
55	1714.999996	-0.002	1749.999997	-0.002

Note:

1. The applicant declared that the normal operating temperature of the EUT is from -25°C to 55°C.
2. The EUT would shut down automatically as below -25°C.

Frequency Error vs. Voltage

Voltage (Volts)	LTE Band 4			
	Channel Bandwidth: 15 MHz			
	Low Channel		High Channel	
	Frequency (MHz)	Frequency Error (ppm)	Frequency (MHz)	Frequency Error (ppm)
3.8	1717.500001	0.001	1747.500003	0.002
3.4	1717.500004	0.002	1747.500004	0.002
4.35	1717.500001	0.001	1747.500001	0.001

Note: The applicant defined the normal working voltage of the battery is from 3.4 Vdc to 4.35 Vdc.

Frequency Error vs. Temperature

Temp. (°C)	LTE Band 4			
	Channel Bandwidth: 15 MHz			
	Low Channel		High Channel	
	Frequency (MHz)	Frequency Error (ppm)	Frequency (MHz)	Frequency Error (ppm)
-25	1717.500002	0.001	1747.500003	0.002
-20	1717.500004	0.002	1747.500004	0.002
-10	1717.500001	0.001	1747.500002	0.001
0	1717.500002	0.001	1747.500004	0.002
10	1717.500003	0.002	1747.500003	0.001
20	1717.499997	-0.002	1747.499999	-0.001
30	1717.499996	-0.002	1747.499997	-0.001
40	1717.499999	-0.001	1747.499999	-0.001
50	1717.499999	-0.001	1747.499998	-0.001
55	1717.499997	-0.002	1747.499997	-0.002

Note:

1. The applicant declared that the normal operating temperature of the EUT is from -25°C to 55°C.
2. The EUT would shut down automatically as below -25°C.

Frequency Error vs. Voltage

Voltage (Volts)	LTE Band 4			
	Channel Bandwidth: 20 MHz			
	Low Channel		High Channel	
	Frequency (MHz)	Frequency Error (ppm)	Frequency (MHz)	Frequency Error (ppm)
3.8	1720.000002	0.001	1745.000001	0.001
3.4	1720.000001	0.001	1745.000002	0.001
4.35	1720.000001	0.001	1745.000001	0.001

Note: The applicant defined the normal working voltage of the battery is from 3.4 Vdc to 4.35 Vdc.

Frequency Error vs. Temperature

Temp. (°C)	LTE Band 4			
	Channel Bandwidth: 20 MHz			
	Low Channel		High Channel	
	Frequency (MHz)	Frequency Error (ppm)	Frequency (MHz)	Frequency Error (ppm)
-25	1720.000003	0.002	1745.000003	0.002
-20	1720.000003	0.002	1745.000003	0.002
-10	1720.000002	0.001	1745.000003	0.002
0	1720.000004	0.002	1745.000001	0.001
10	1720.000004	0.002	1745.000002	0.001
20	1719.999999	-0.001	1744.999998	-0.001
30	1719.999997	-0.002	1744.999998	-0.001
40	1719.999998	-0.001	1744.999999	-0.001
50	1719.999997	-0.002	1744.999998	-0.001
55	1719.999998	-0.001	1744.999996	-0.002

Note:

1. The applicant declared that the normal operating temperature of the EUT is from -25°C to 55°C.
2. The EUT would shut down automatically as below -25°C.

4.4 Occupied Bandwidth Measurement

4.4.1 Limits of Occupied Bandwidth Measurement

The width of a frequency band such that, below the lower and above the upper frequency limits, the mean powers emitted are each equal to a specified percentage 0.5 % of the total mean power of a given emission.

4.4.2 Test Procedure

- The conducted occupied bandwidth used the power splitter via EUT RF power connector between simulation base station and spectrum analyzer.
- Use OBW measurement function of Spectrum analyzer to measure 99 % occupied bandwidth.

4.4.3 Test Setup

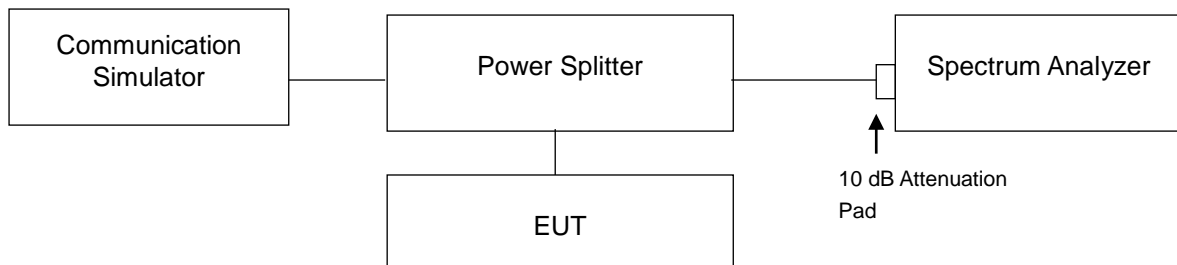

4.4.4 Test Result

WCDMA			
Channel	Frequency (MHz)	99 % Occupied Bandwidth (MHz)	26 dB Bandwidth (MHz)
1312	1712.4	4.1885	4.714
1413	1732.6	4.1799	4.703
1513	1752.6	4.1892	4.734

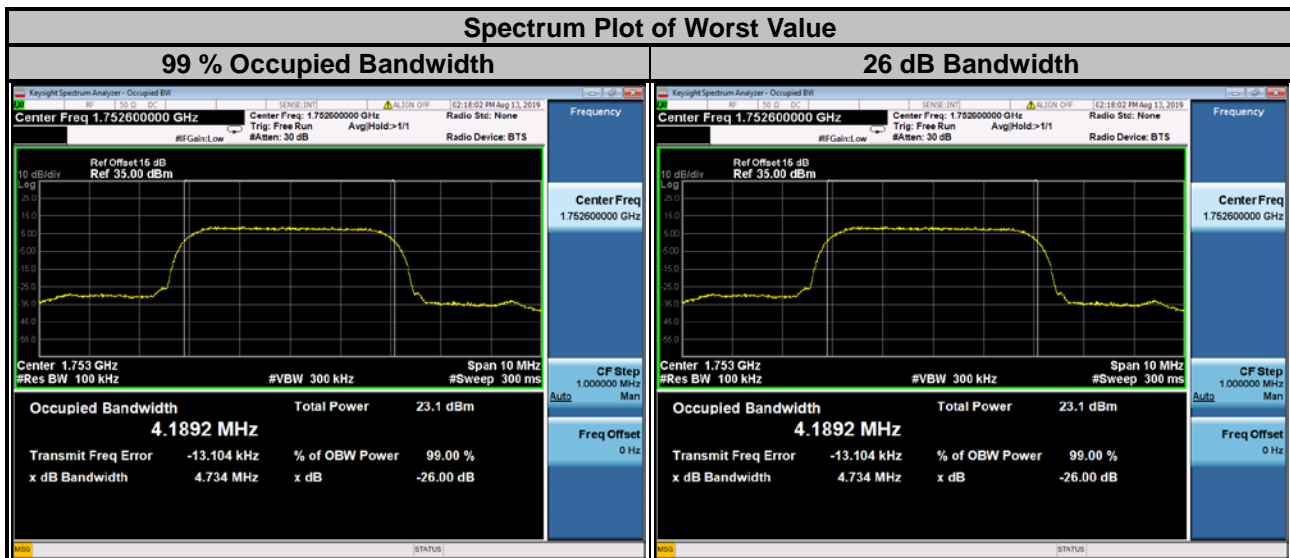

LTE Band 4							
Channel Bandwidth: 1.4 MHz							
Channel	Frequency (MHz)	99 % Occupied Bandwidth (MHz)			26 dB Bandwidth (MHz)		
		QPSK	16QAM	64QAM	QPSK	16QAM	64QAM
19957	1710.7	1.0869	1.0913	1.0903	1.255	1.279	1.269
20175	1732.5	1.0870	1.0885	1.0903	1.254	1.264	1.268
20393	1754.3	1.0863	1.0882	1.0869	1.245	1.256	1.261

Channel Bandwidth: 3 MHz							
Channel	Frequency (MHz)	99 % Occupied Bandwidth (MHz)			26 dB Bandwidth (MHz)		
		QPSK	16QAM	64QAM	QPSK	16QAM	64QAM
19965	1711.5	2.6997	2.6952	2.6964	2.872	2.880	2.872
20175	1732.5	2.7005	2.6952	2.6952	2.873	2.879	2.868
20385	1753.5	2.6968	2.6917	2.6914	2.871	2.865	2.864



LTE Band 4							
Channel Bandwidth: 5 MHz							
Channel	Frequency (MHz)	99 % Occupied Bandwidth (MHz)			26 dB Bandwidth (MHz)		
		QPSK	16QAM	64QAM	QPSK	16QAM	64QAM
19975	1712.5	4.4952	4.4978	4.5038	4.799	4.792	4.787
20175	1732.5	4.4956	4.4973	4.5035	4.785	4.791	4.807
20375	1752.5	4.4896	4.4911	4.5013	4.769	4.775	4.778

Channel Bandwidth: 10 MHz							
Channel	Frequency (MHz)	99 % Occupied Bandwidth (MHz)			26 dB Bandwidth (MHz)		
		QPSK	16QAM	64QAM	QPSK	16QAM	64QAM
20000	1715.0	8.9833	8.9902	8.9932	9.498	9.512	9.523
20175	1732.5	8.9907	8.9935	8.9935	9.512	9.524	9.530
20350	1750.0	8.9688	8.9759	8.9728	9.496	9.503	9.514



LTE Band 4							
Channel Bandwidth: 15 MHz							
Channel	Frequency (MHz)	99 % Occupied Bandwidth (MHz)			26 dB Bandwidth (MHz)		
		QPSK	16QAM	64QAM	QPSK	16QAM	64QAM
20025	1717.5	13.470	13.460	13.454	14.250	14.240	14.240
20175	1732.5	13.497	13.484	13.479	14.260	14.260	14.250
20325	1747.5	13.459	13.448	13.442	14.250	14.230	14.230
Channel Bandwidth: 20 MHz							
Channel	Frequency (MHz)	99 % Occupied Bandwidth (MHz)			26 dB Bandwidth (MHz)		
		QPSK	16QAM	64QAM	QPSK	16QAM	64QAM
20050	1720.0	17.932	17.947	17.939	19.040	19.050	19.040
20175	1732.5	17.980	18.005	18.000	19.060	19.060	19.070
20300	1745.0	17.937	17.956	17.950	19.030	19.050	19.030



4.5 Band Edge Measurement

4.5.1 Limits of Band Edge Measurement

For operations in the 1710–1755 MHz bands, the power of any emission outside a licensee's frequency block shall be attenuated below the transmitter power (P) by at least $43 + 10 \log (P)$ dB.

4.5.2 Test Setup

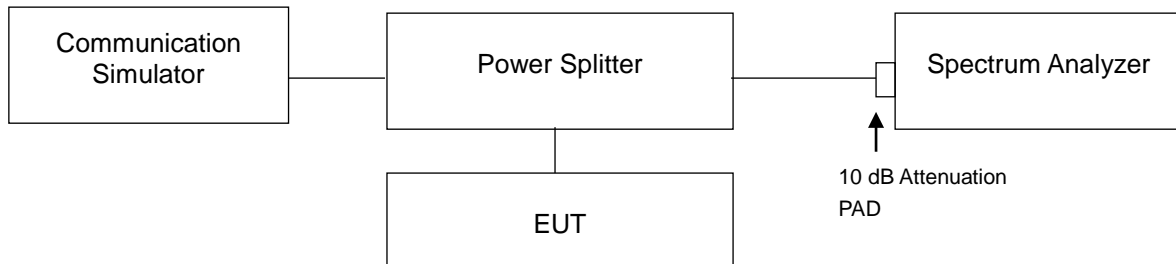

4.5.3 Test Procedures

- a. All measurements were done at low and high operational frequency range.
- b. The center frequency of spectrum is the band edge frequency and span is 5 MHz. RB of the spectrum is 51 kHz and VB of the spectrum is 160 kHz (WCDMA).
- c. The center frequency of spectrum is the band edge frequency and span is 1 MHz. RB of the spectrum is 15 kHz and VB of the spectrum is 51 kHz (LTE Bandwidth 1.4 MHz).
- d. The center frequency of spectrum is the band edge frequency and span is 1 MHz. RB of the spectrum is 30 kHz and VB of the spectrum is 100 kHz (LTE Bandwidth 3 MHz).
- e. The center frequency of spectrum is the band edge frequency and span is 1 MHz. RB of the spectrum is 51 kHz and VB of the spectrum is 160 kHz (LTE Bandwidth 5 MHz).
- f. The center frequency of spectrum is the band edge frequency and span is 1 MHz. RB of the spectrum is 100 kHz and VB of the spectrum is 300 kHz (LTE Bandwidth 10 MHz).
- g. The center frequency of spectrum is the band edge frequency and span is 1 MHz. RB of the spectrum is 150 kHz and VB of the spectrum is 470 kHz (LTE Bandwidth 15 MHz).
- h. The center frequency of spectrum is the band edge frequency and span is 1 MHz. RB of the spectrum is 200 kHz and VB of the spectrum is 1 MHz (LTE Bandwidth 20 MHz).
- i. Record the max. trace plot into the test report.

4.5.4 Test Results

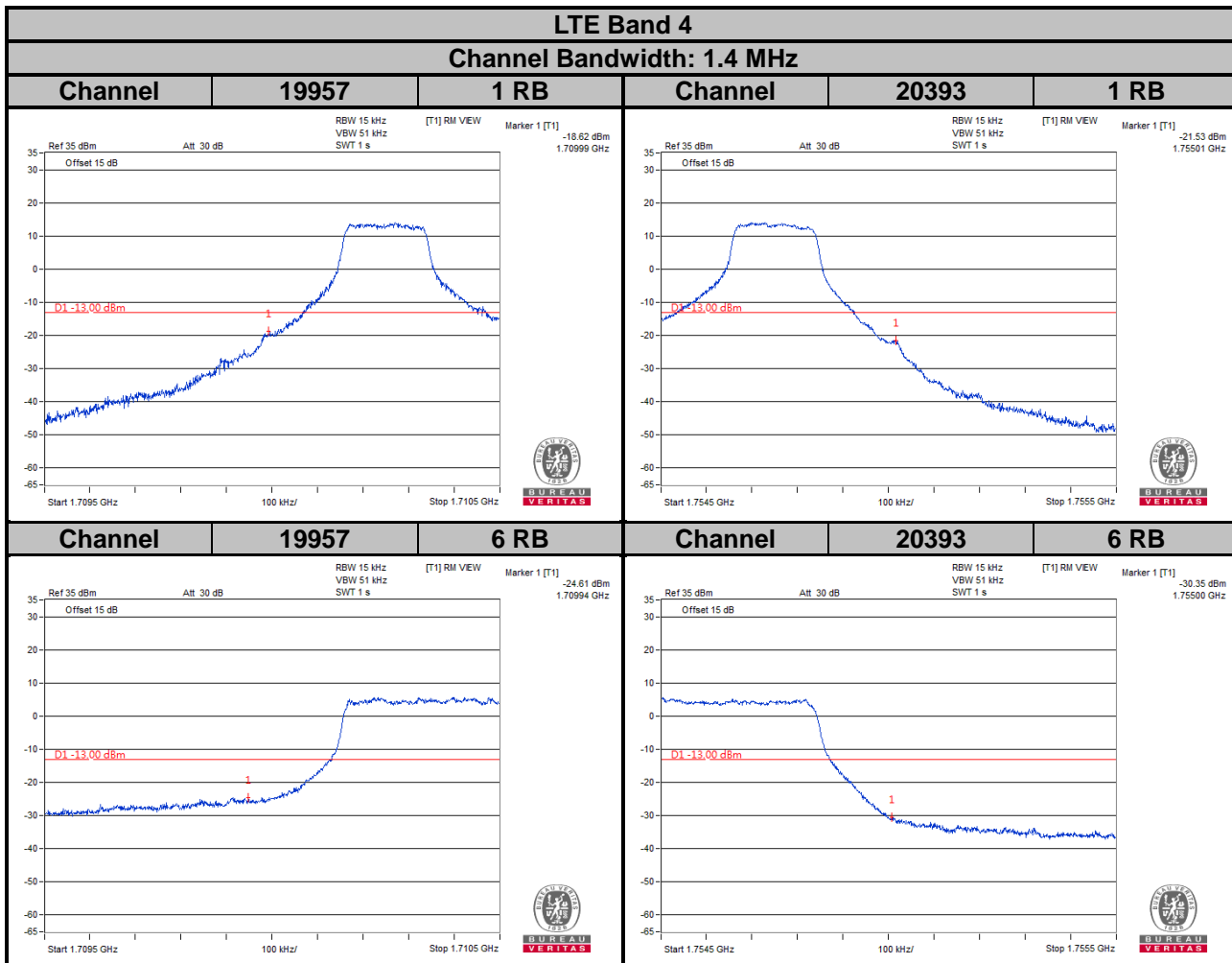
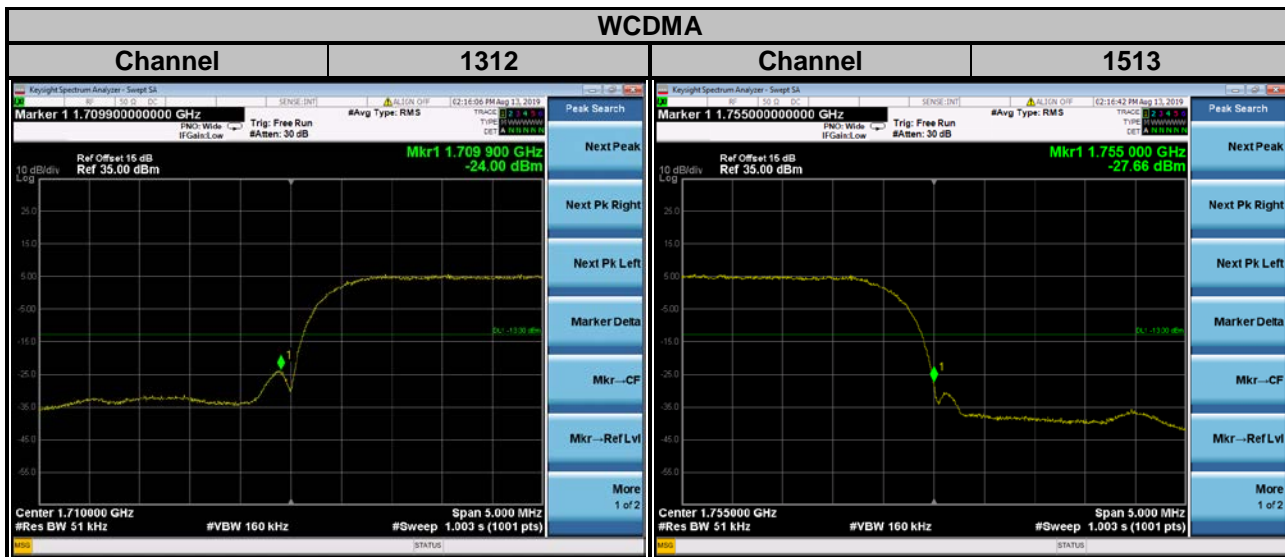

LTE Band 4

Channel Bandwidth: 3 MHz

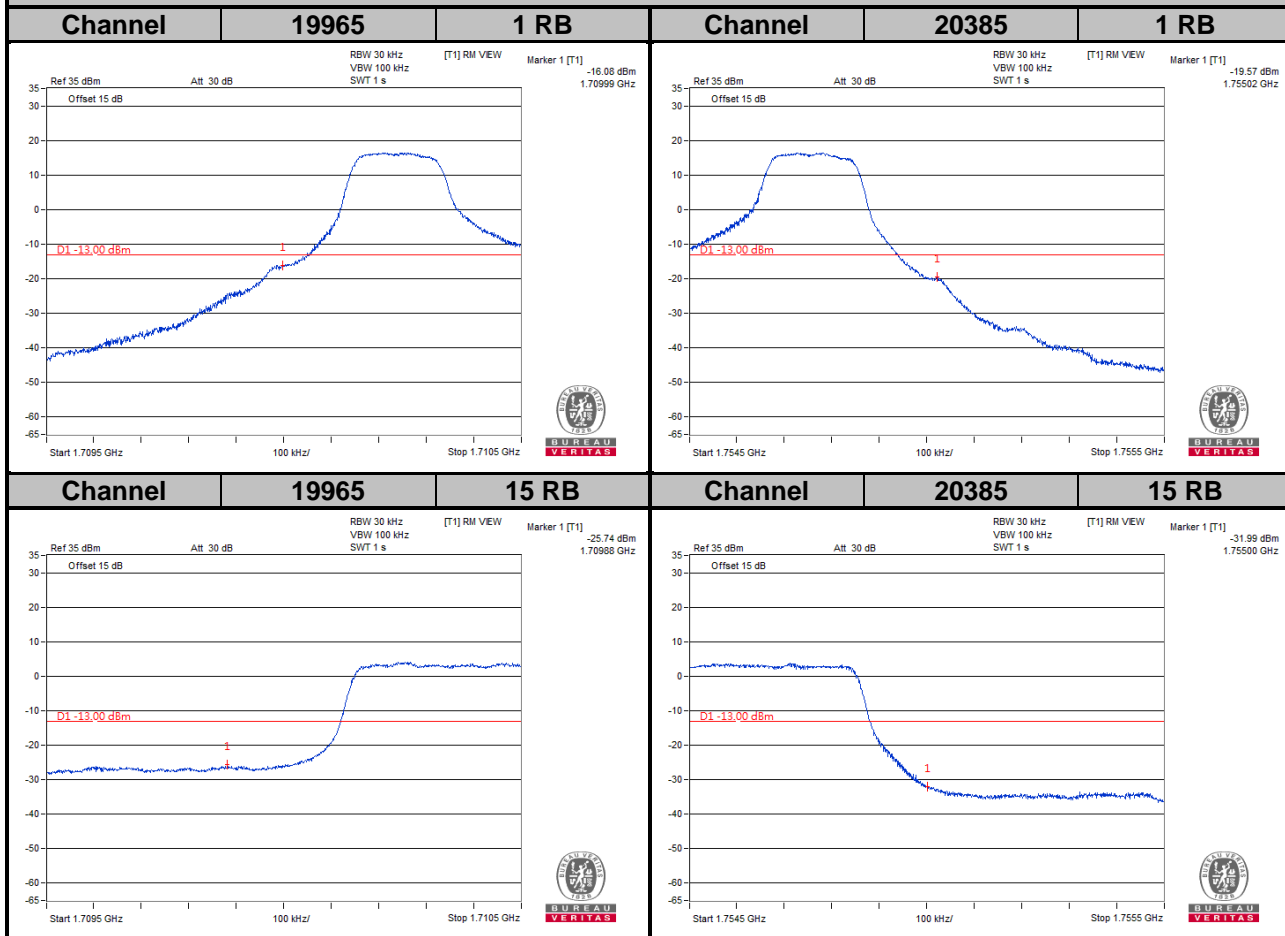

LTE Band 4

Channel Bandwidth: 5 MHz

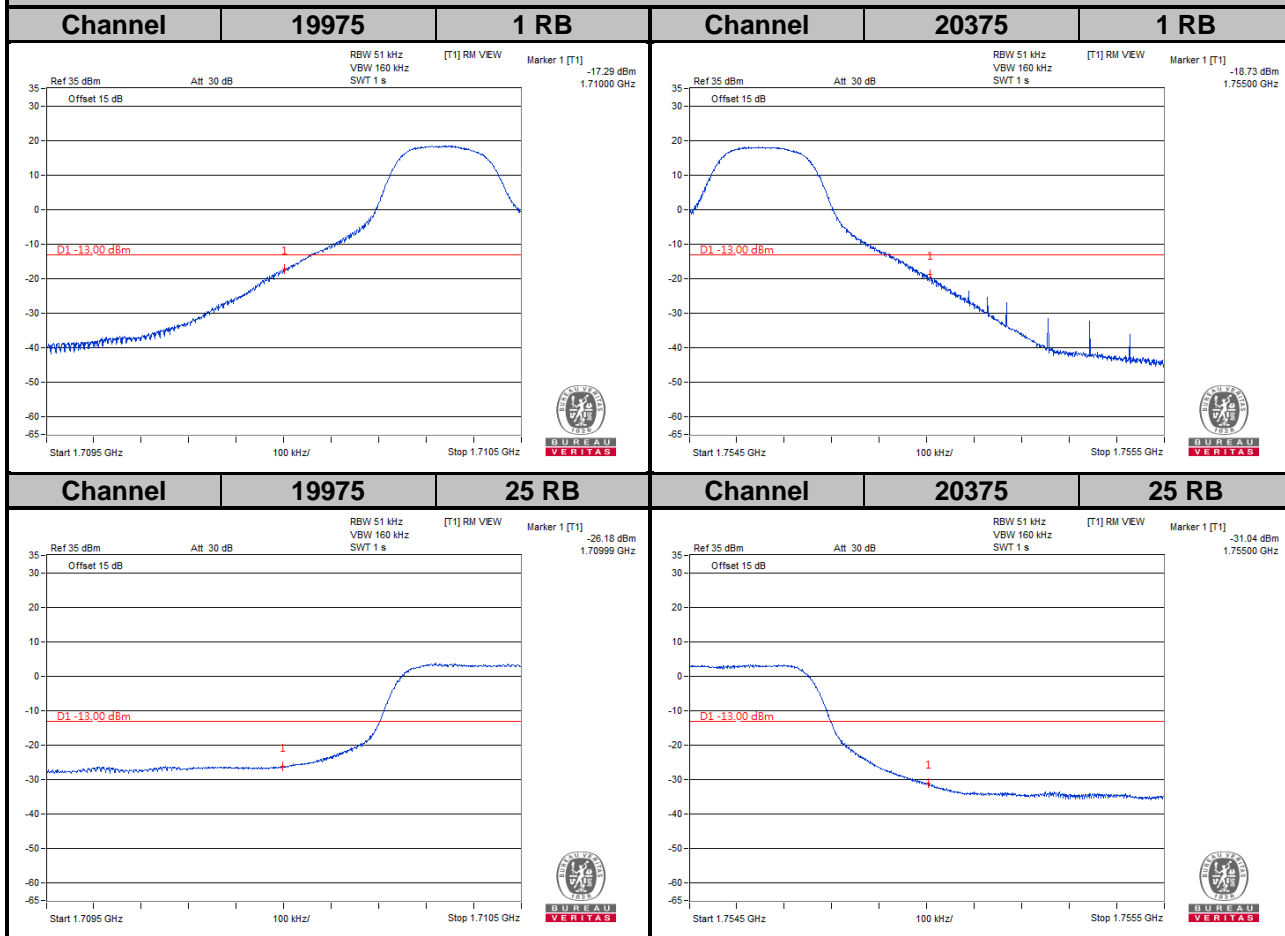

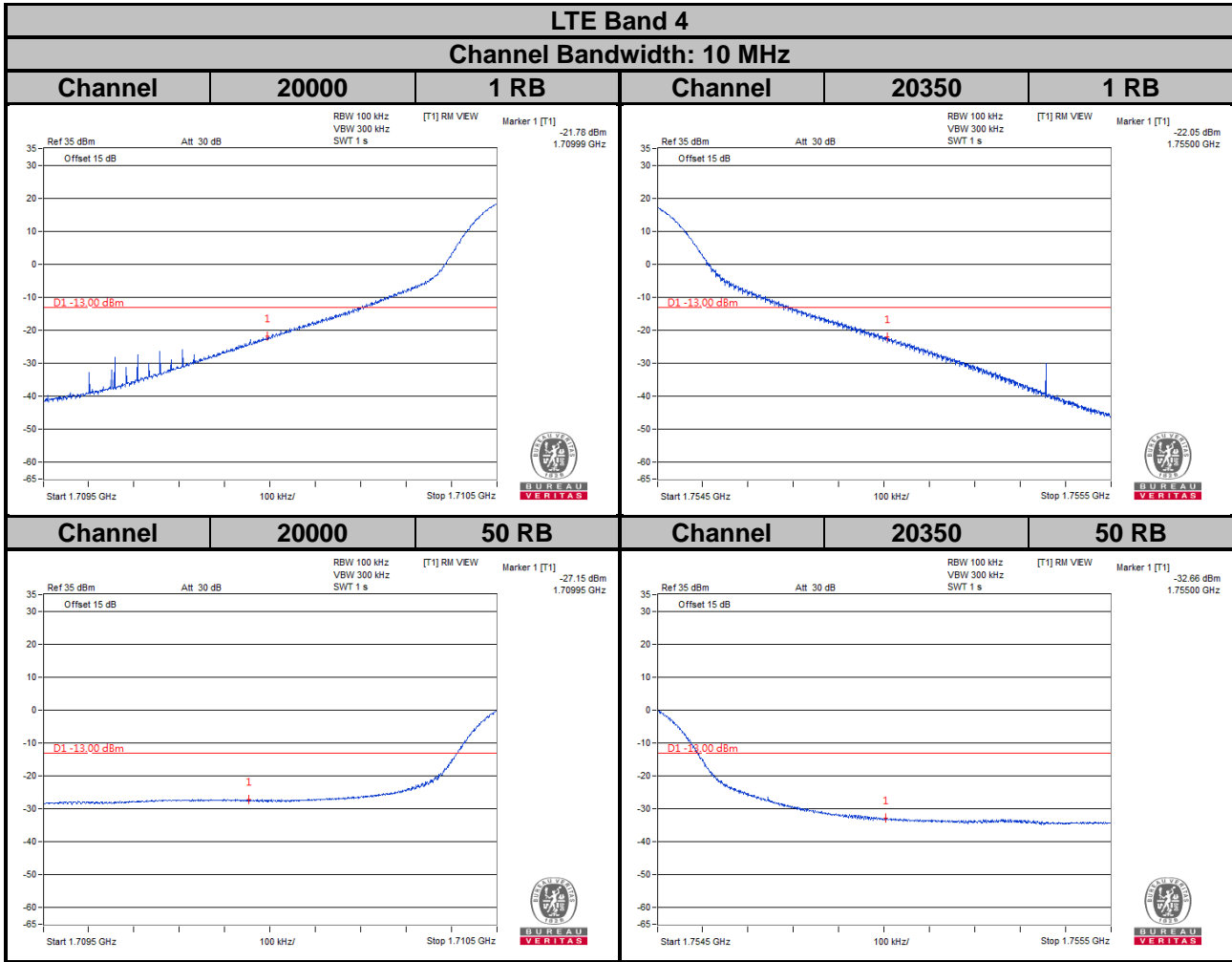

LTE Band 4
Channel Bandwidth: 15 MHz

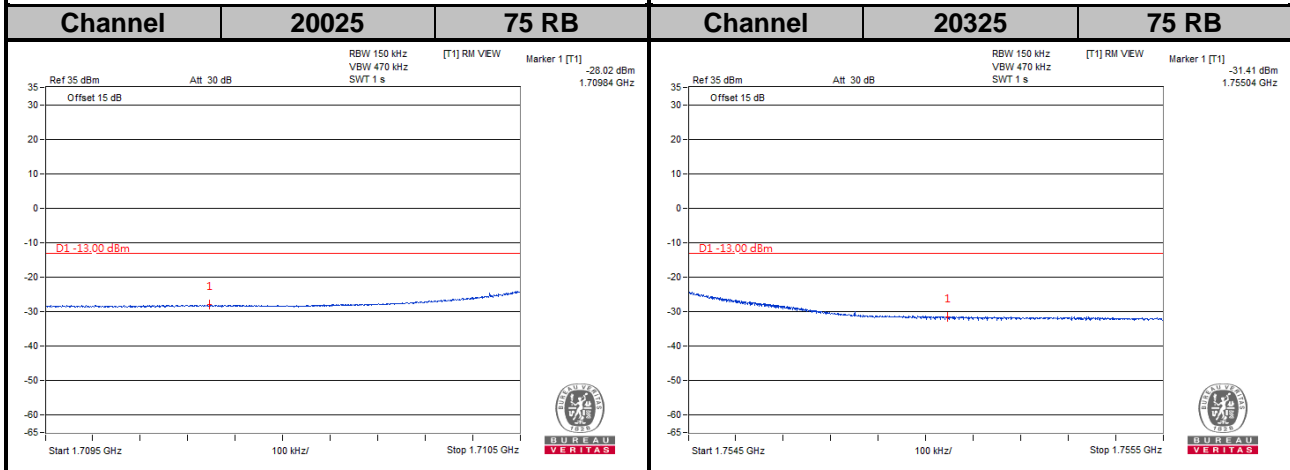
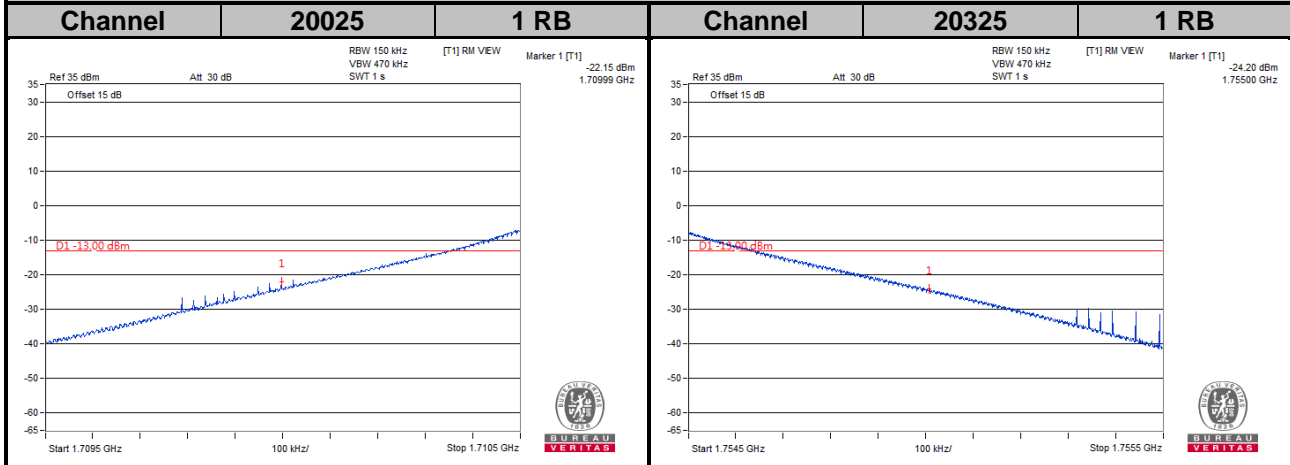

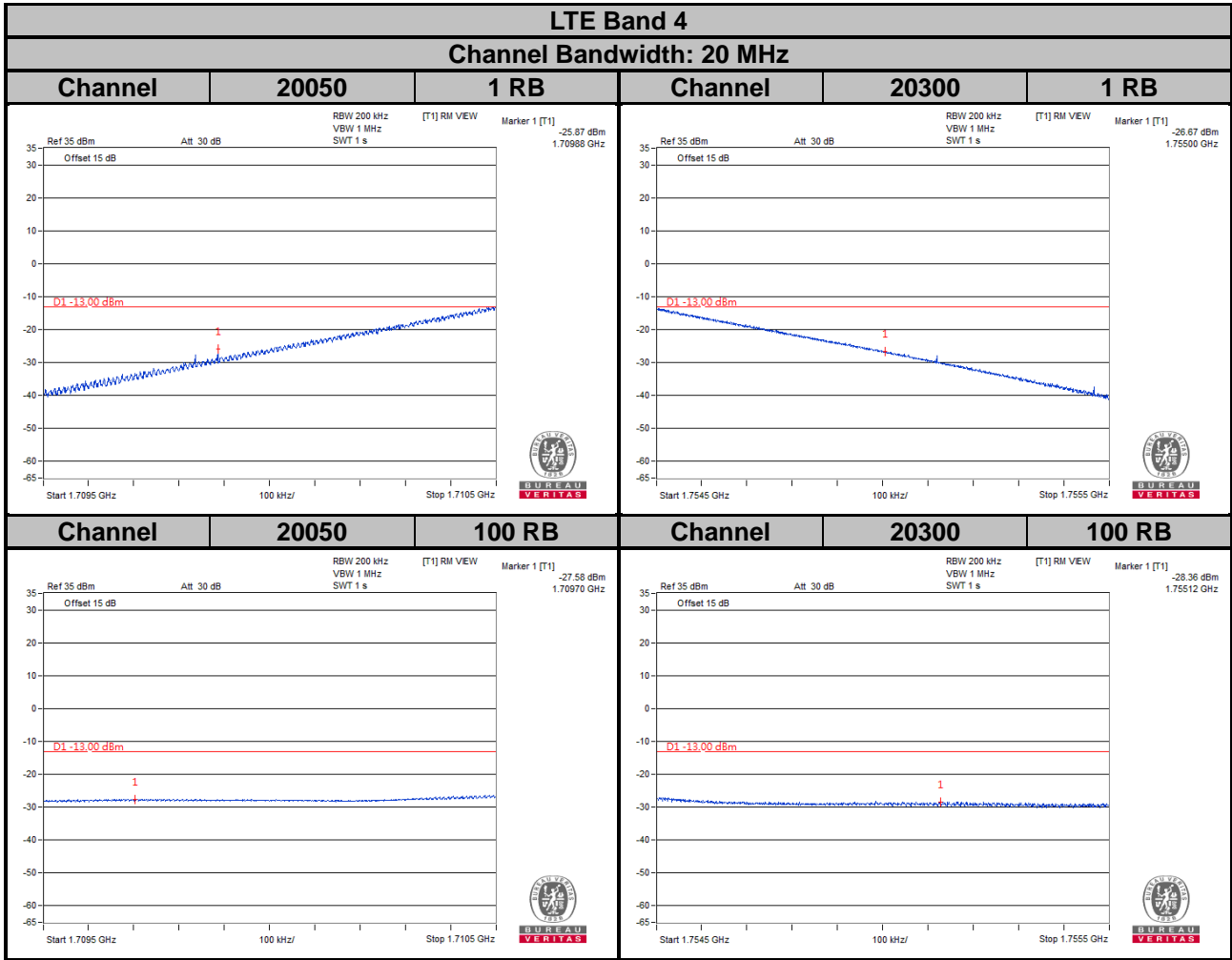

4.6 Peak to Average Ratio

4.6.1 Limits of Peak to Average Ratio Measurement

In measuring transmissions in this band using an average power technique, the peak to-average ratio (PAR) of the transmission may not exceed 13 dB.

4.6.2 Test Setup

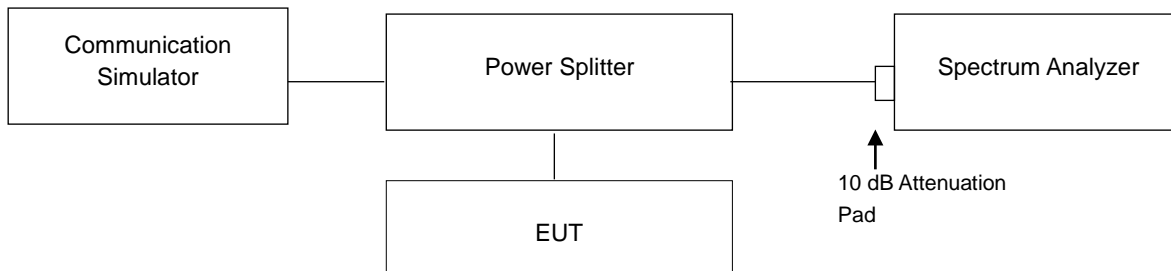

4.6.3 Test Procedures

1. Set resolution/measurement bandwidth \geq signal's occupied bandwidth;
2. Set the number of counts to a value that stabilizes the measured CCDF curve;
3. Record the maximum PAPR level associated with a probability of 0.1 %.

4.6.4 Test Results

WCDMA		
Channel	Frequency (MHz)	Peak to Average Ratio (dB)
1312	1712.4	3.07
1413	1732.6	3.24
1513	1752.6	2.88

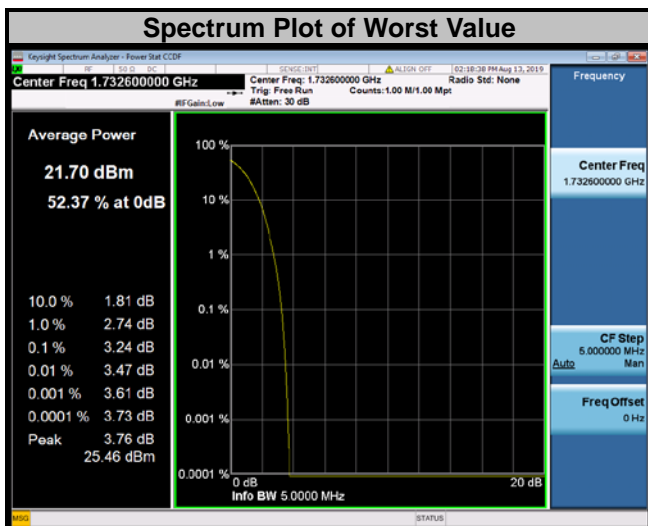

LTE Band 4									
Channel Bandwidth: 1.4 MHz					Channel Bandwidth: 3 MHz				
Channel	Frequency (MHz)	Peak to Average Ratio (dB)			Channel	Frequency (MHz)	Peak to Average Ratio (dB)		
		QPSK	16QAM	64QAM			QPSK	16QAM	64QAM
19957	1710.7	4.35	5.31	6.07	19965	1711.5	4.32	5.26	6.14
20175	1732.5	4.98	5.89	6.61	20175	1732.5	4.99	5.89	6.68
20393	1754.3	4.58	5.52	6.18	20385	1753.5	4.52	5.47	6.20

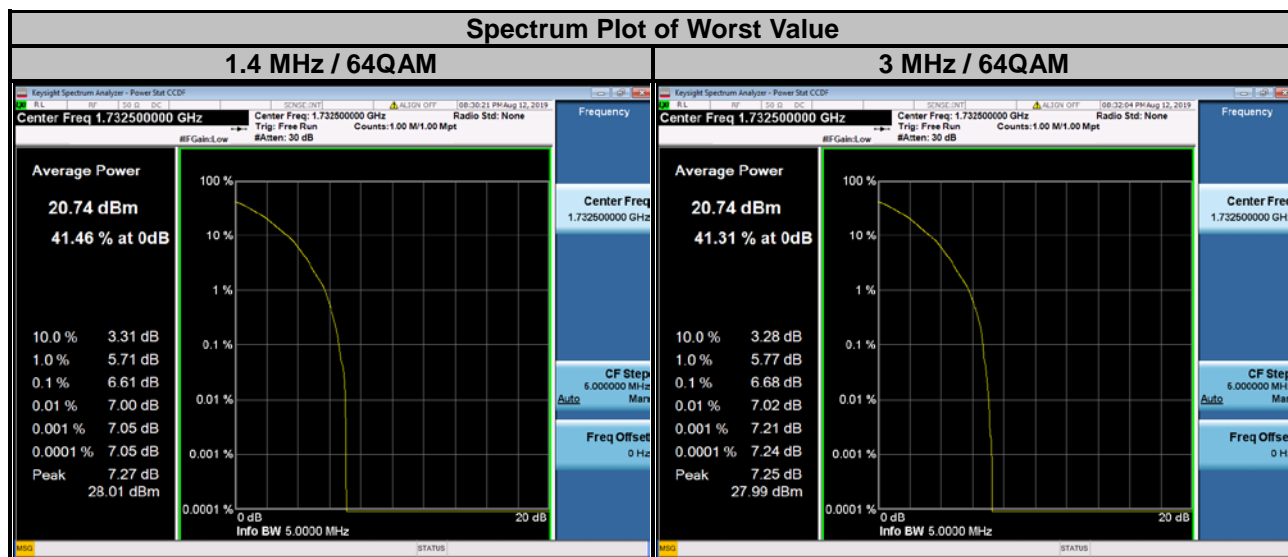

LTE Band 4									
Channel Bandwidth: 5 MHz					Channel Bandwidth: 10 MHz				
Channel	Frequency (MHz)	Peak to Average Ratio (dB)			Channel	Frequency (MHz)	Peak to Average Ratio (dB)		
		QPSK	16QAM	64QAM			QPSK	16QAM	64QAM
19975	1712.5	4.50	5.40	6.23	20000	1715.0	4.38	5.35	6.17
20175	1732.5	5.16	6.02	6.72	20175	1732.5	5.04	5.97	6.70
20375	1752.5	4.68	5.61	6.26	20350	1750.0	4.77	5.69	6.41

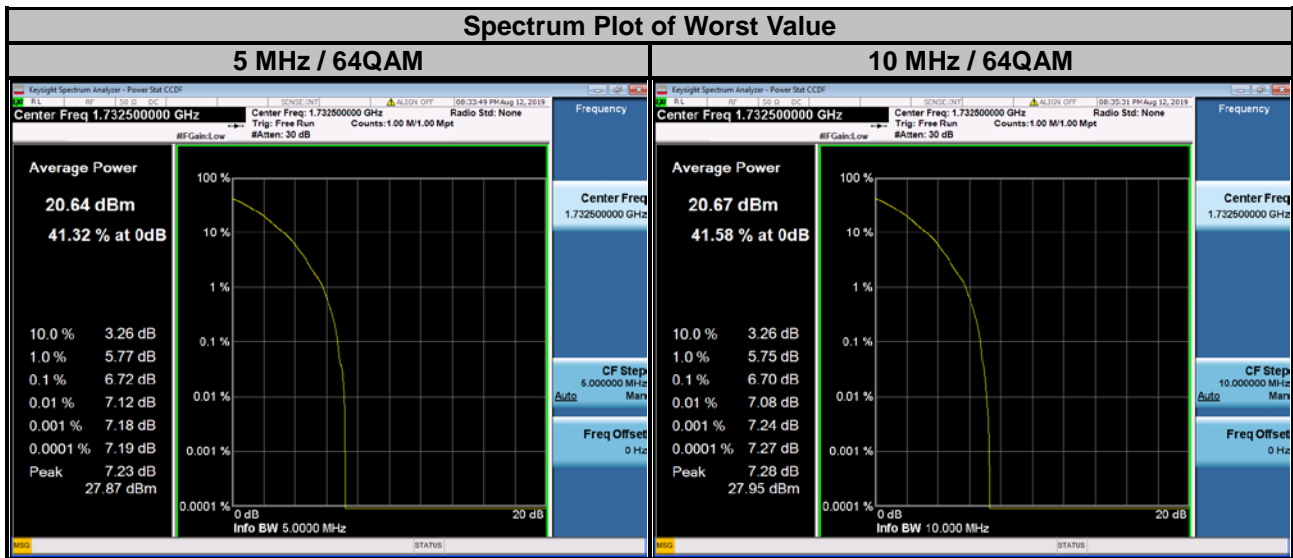

LTE Band 4									
Channel Bandwidth: 15 MHz					Channel Bandwidth: 20 MHz				
Channel	Frequency (MHz)	Peak to Average Ratio (dB)			Channel	Frequency (MHz)	Peak to Average Ratio (dB)		
		QPSK	16QAM	64QAM			QPSK	16QAM	64QAM
20025	1717.5	4.47	5.34	6.28	20050	1720.0	4.51	5.36	6.21
20175	1732.5	5.02	5.91	6.56	20175	1732.5	4.97	5.87	6.67
20325	1747.5	4.93	5.89	6.49	20300	1745.0	5.02	5.94	6.71

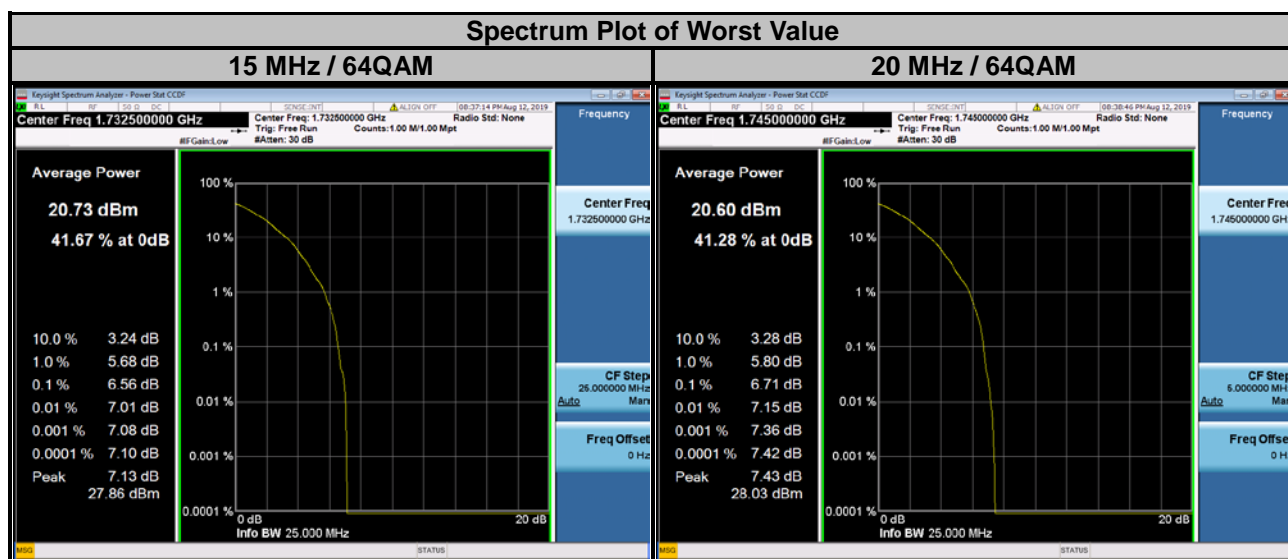

4.7 Conducted Spurious Emissions

4.7.1 Limits of Conducted Spurious Emissions Measurement

The power of any emission outside a licensee's frequency block shall be attenuated below the transmitter power (P) by at least $43 + 10 \log (P)$ dB. The limit of emission is equal to -13 dBm.

4.7.2 Test Setup

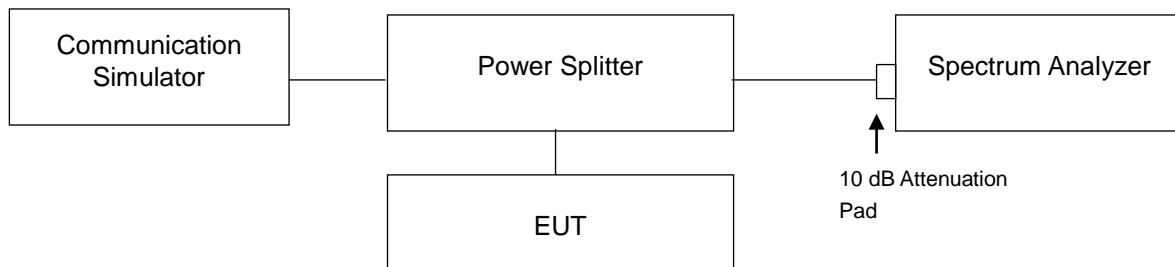

4.7.3 Test Procedure

- The EUT makes a phone call to the communication simulator. All measurements were done at low, middle and high operational frequency range.
- Measuring frequency range is from 9 kHz to 1 GHz. 10 dB attenuation pad is connected with spectrum. RBW = 1 MHz and VBW = 3 MHz is used for conducted emission measurement.
- Measuring frequency range is from 1 GHz to 18 GHz. 10 dB attenuation pad is connected with spectrum. RBW = 1 MHz and VBW = 3 MHz is used for conducted emission measurement.

4.7.4 Test Results

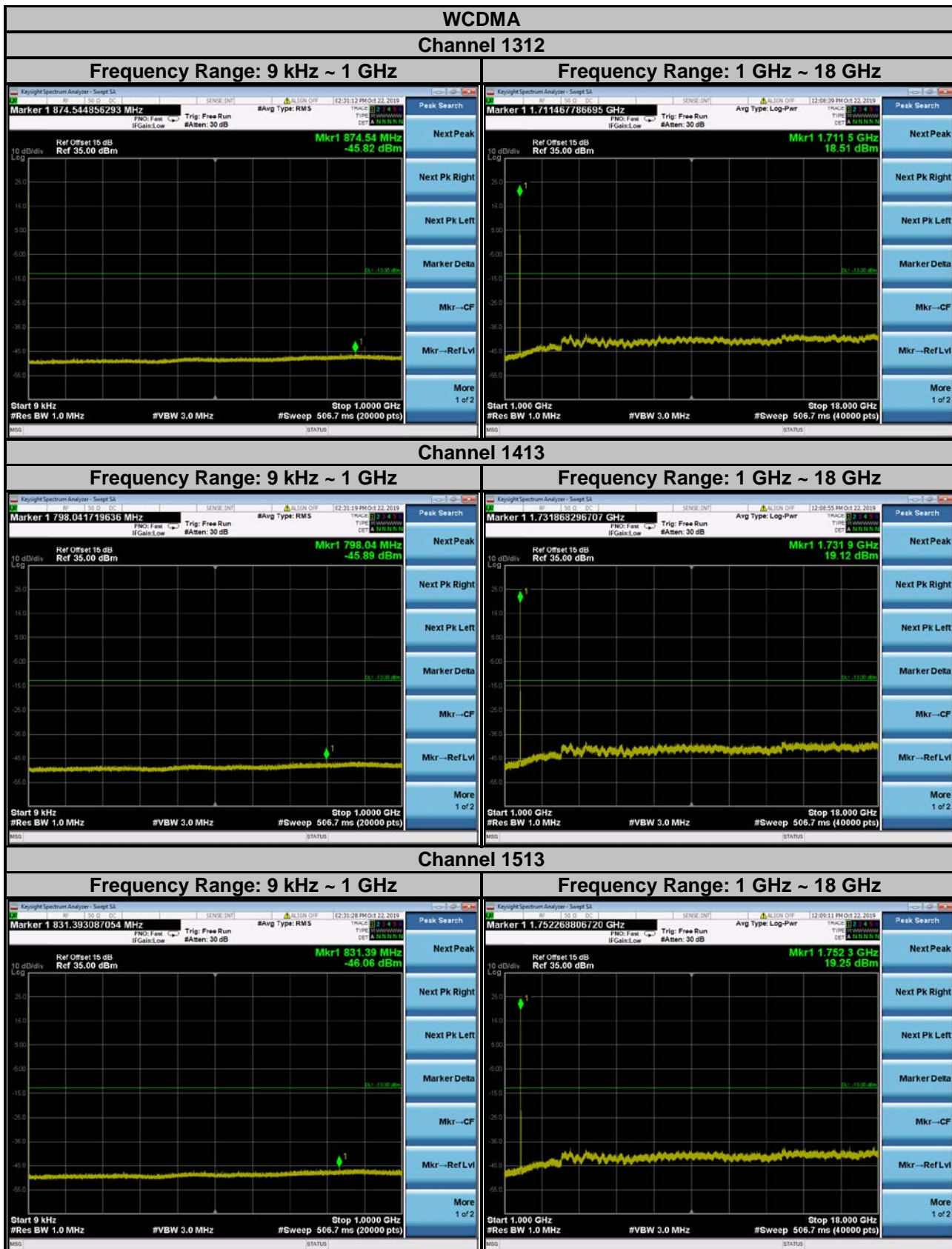

Note: The signal over the limit in 9 kHz is from spectrum analyzer.

LTE Band 4
Channel Bandwidth: 1.4 MHz
Channel 19957

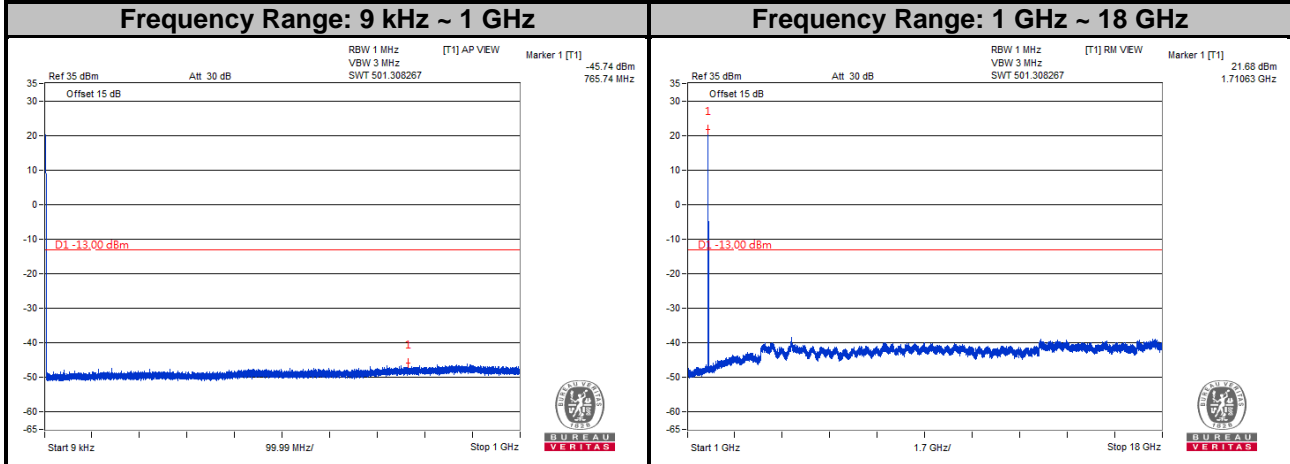

Channel Bandwidth: 1.4 MHz
Channel 20175

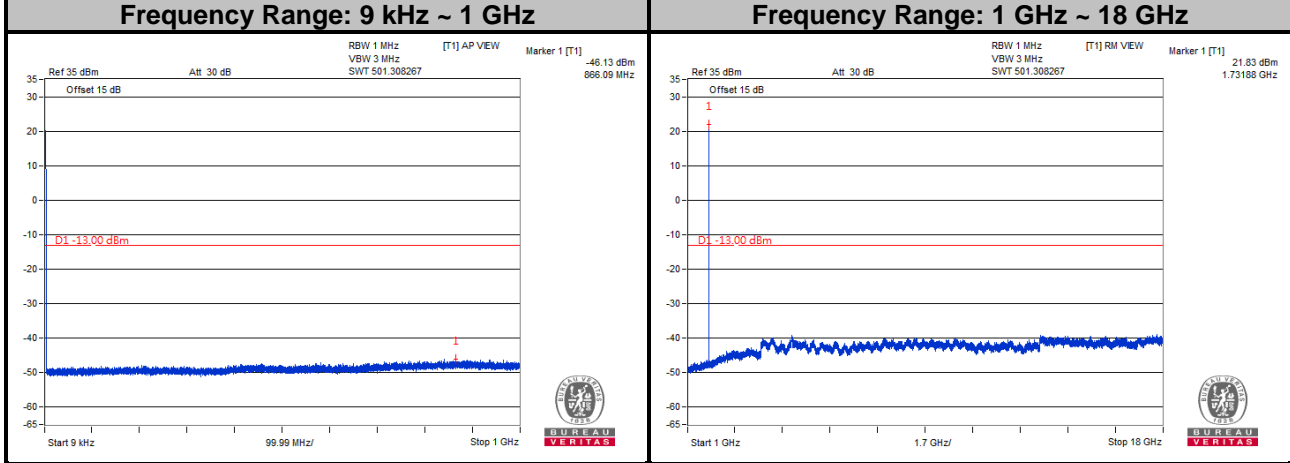

Channel Bandwidth: 1.4 MHz
Channel 20393

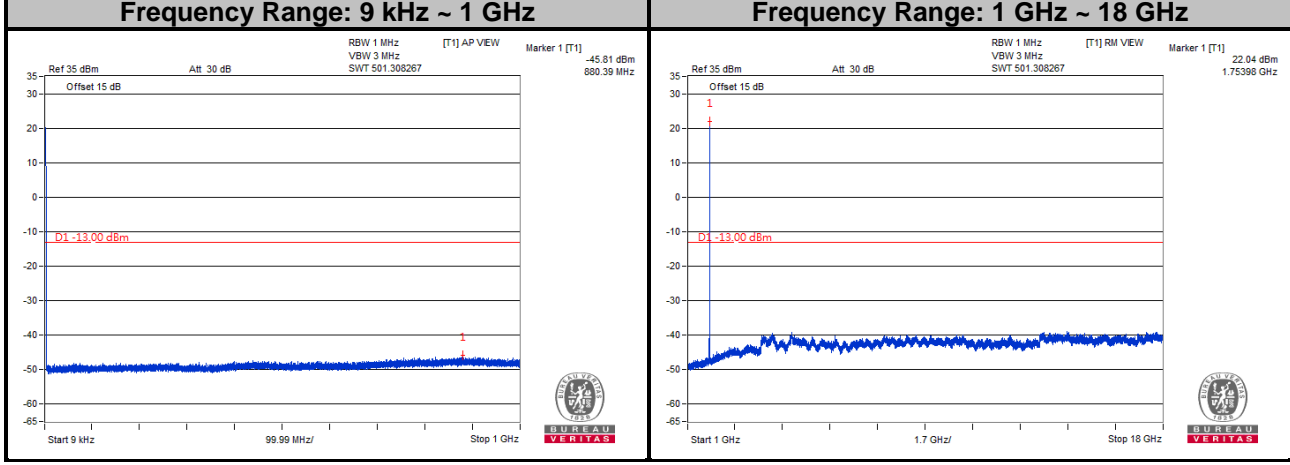

Note: The signal over the limit in 9 kHz is from spectrum analyzer.

LTE Band 4
Channel Bandwidth: 3 MHz
Channel 19965

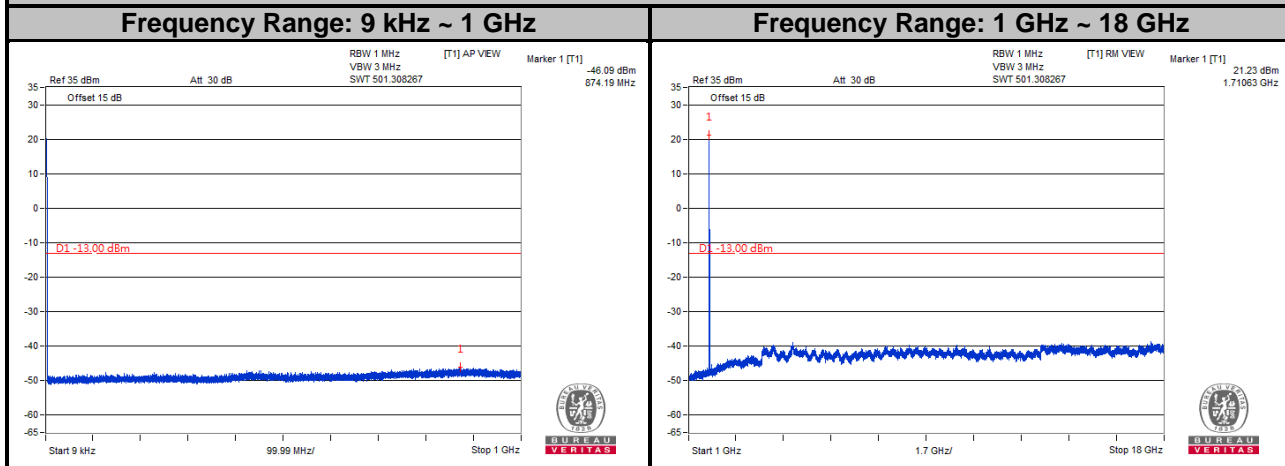

Channel Bandwidth: 3 MHz
Channel 20175

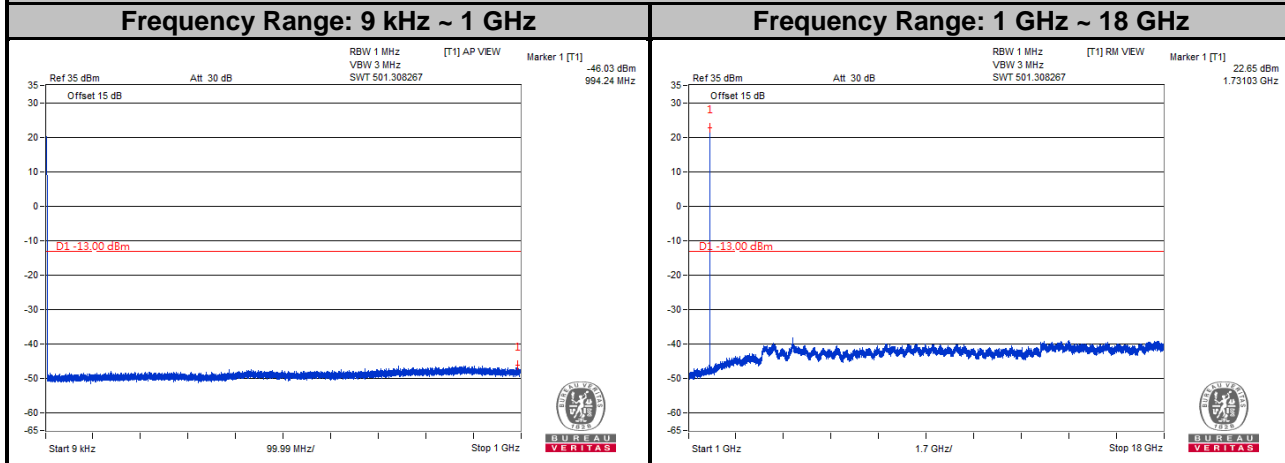

Channel Bandwidth: 3 MHz
Channel 20385

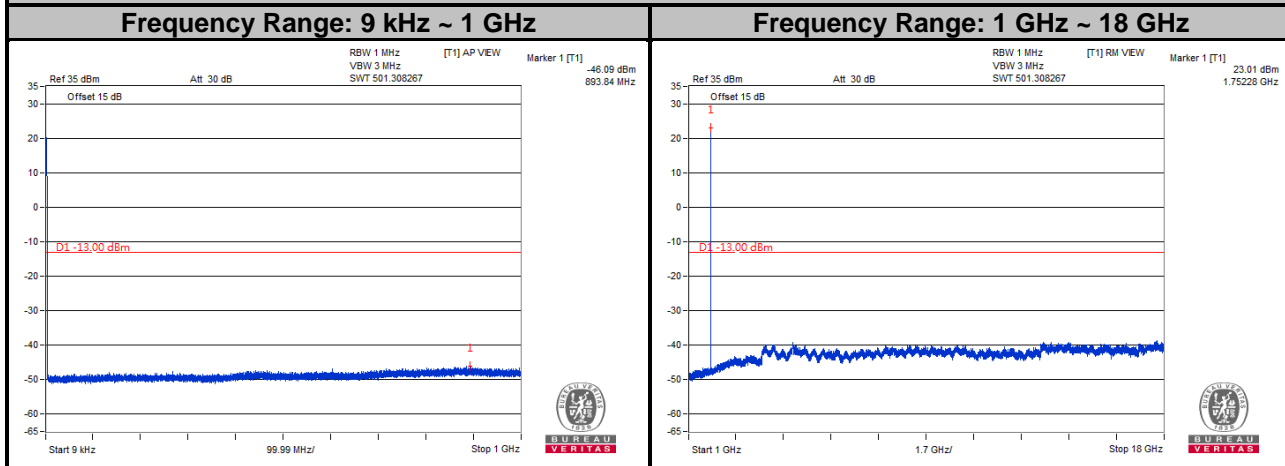

Note: The signal over the limit in 9 kHz is from spectrum analyzer.

LTE Band 4
Channel Bandwidth: 5 MHz
Channel 19975

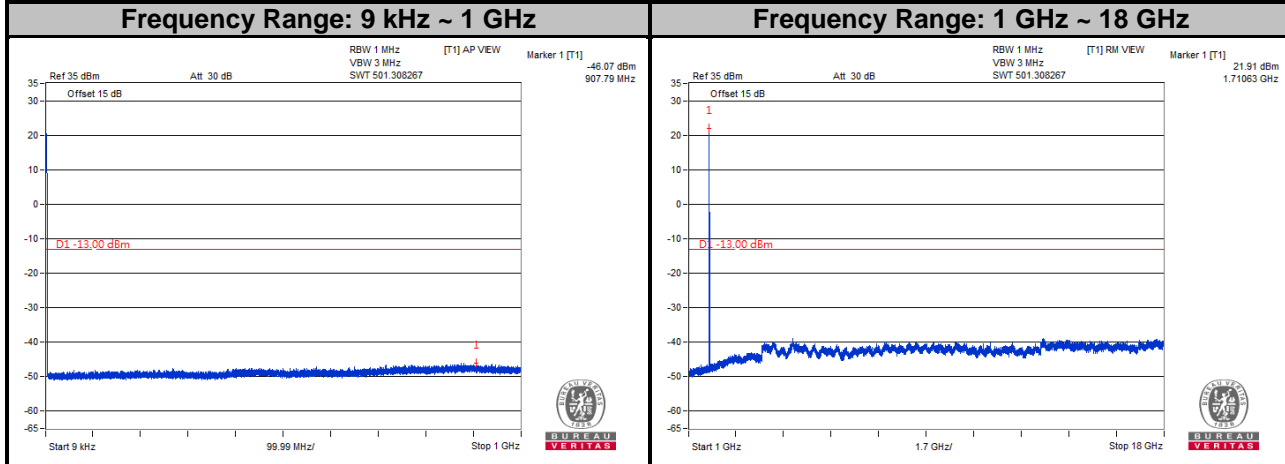

Channel Bandwidth: 5 MHz
Channel 20175

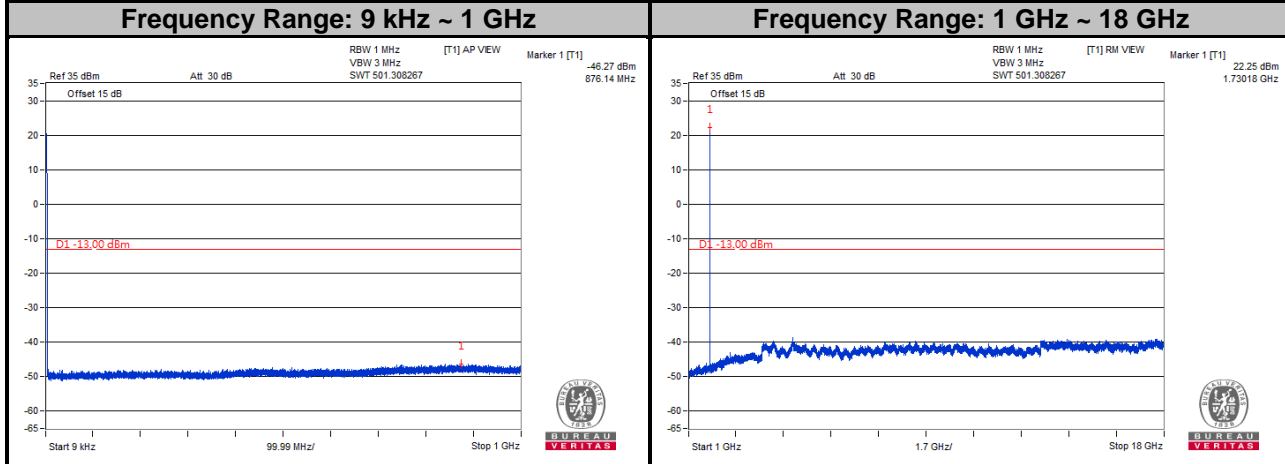

Channel Bandwidth: 5 MHz
Channel 20375

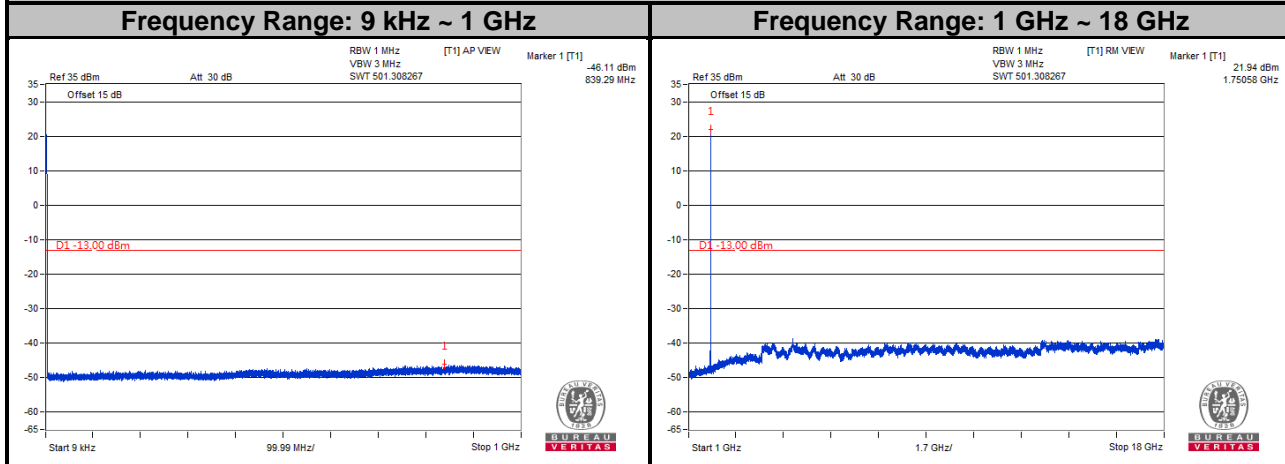

Note: The signal over the limit in 9 kHz is from spectrum analyzer.

LTE Band 4
Channel Bandwidth: 10 MHz
Channel 20000

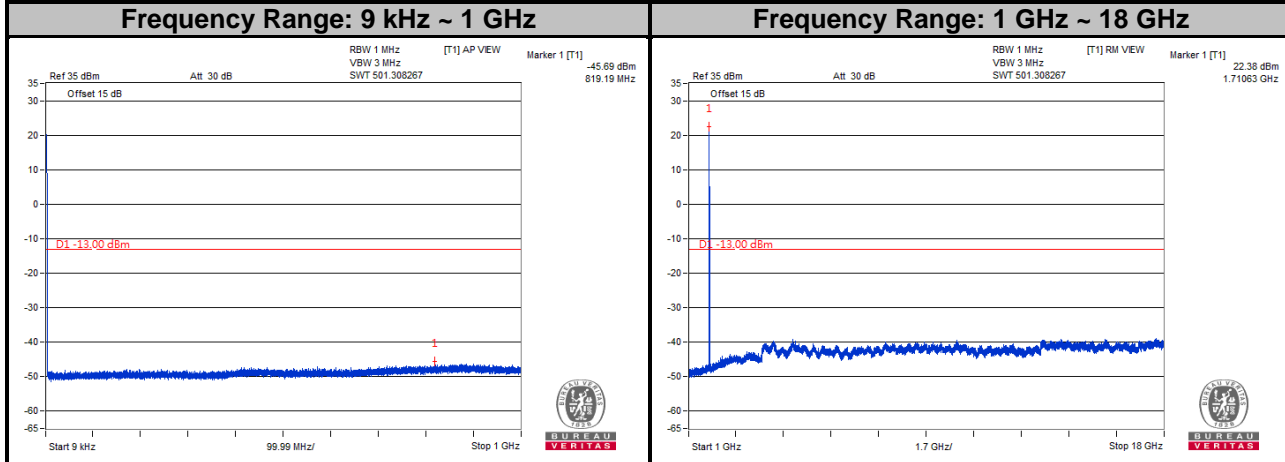

Channel Bandwidth: 10 MHz
Channel 20175

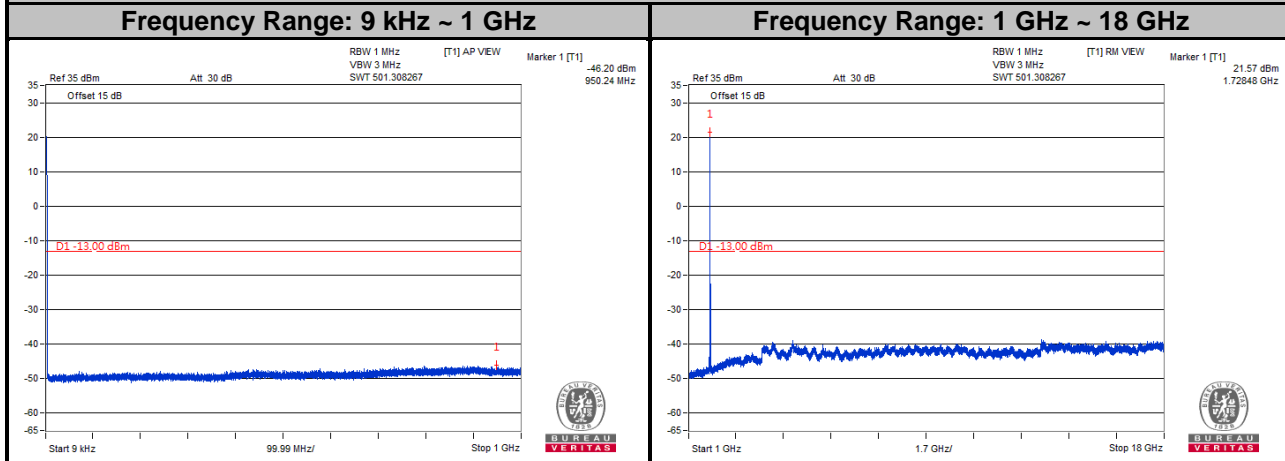

Channel Bandwidth: 10 MHz
Channel 20350

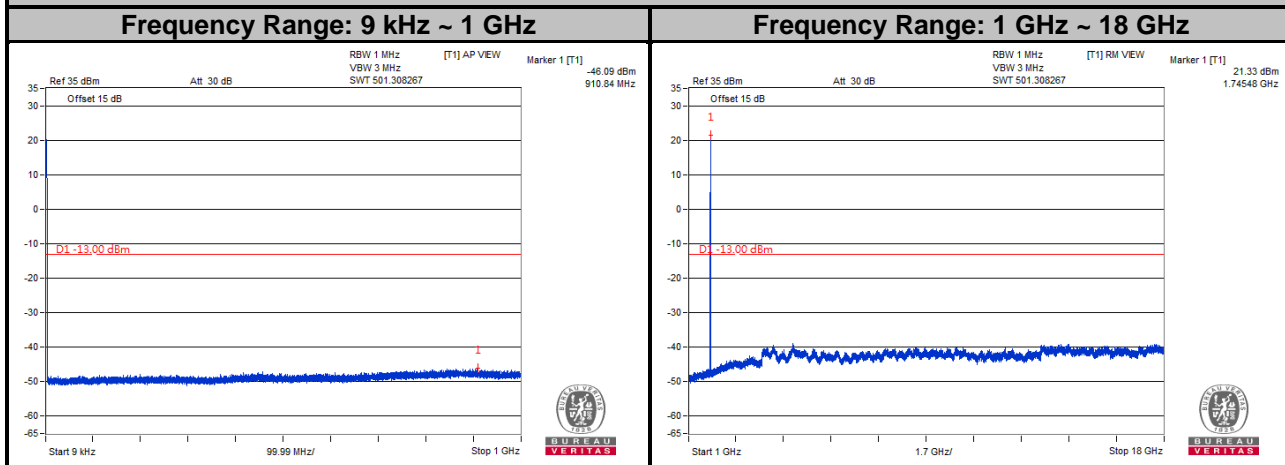

Note: The signal over the limit in 9 kHz is from spectrum analyzer.

LTE Band 4
Channel Bandwidth: 15 MHz
Channel 20025

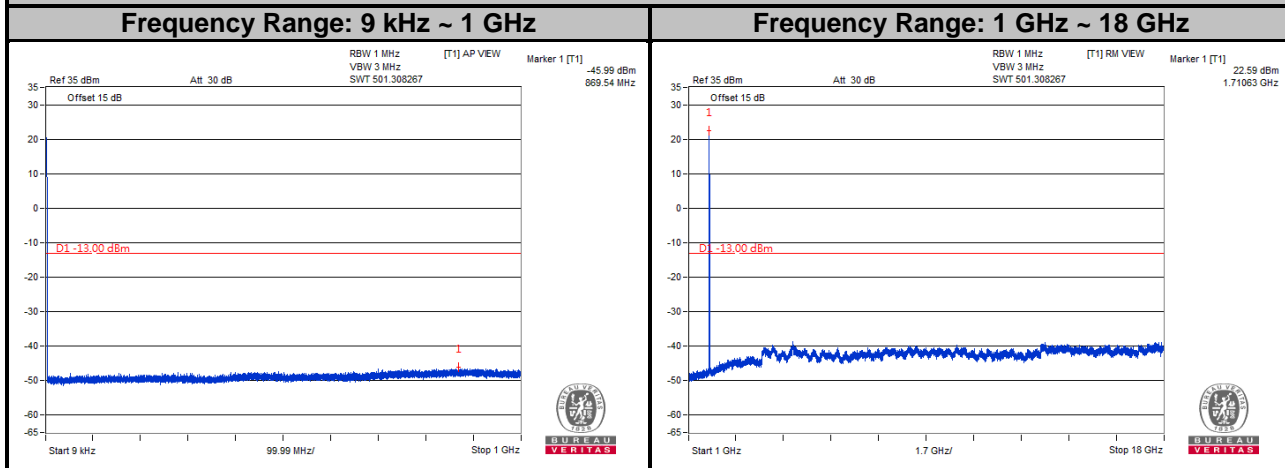

Channel Bandwidth: 15 MHz
Channel 20175

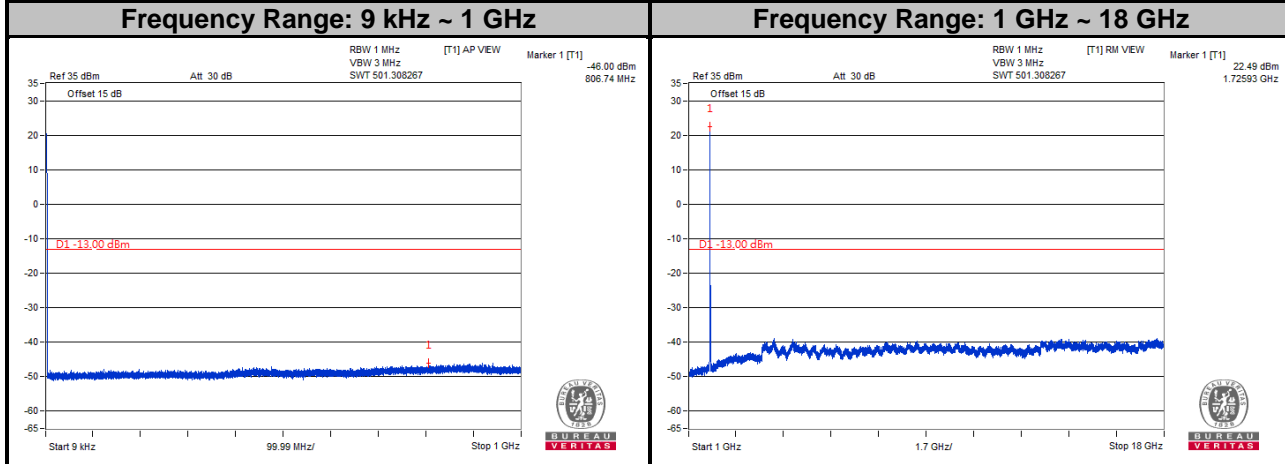

Channel Bandwidth: 15 MHz
Channel 20325

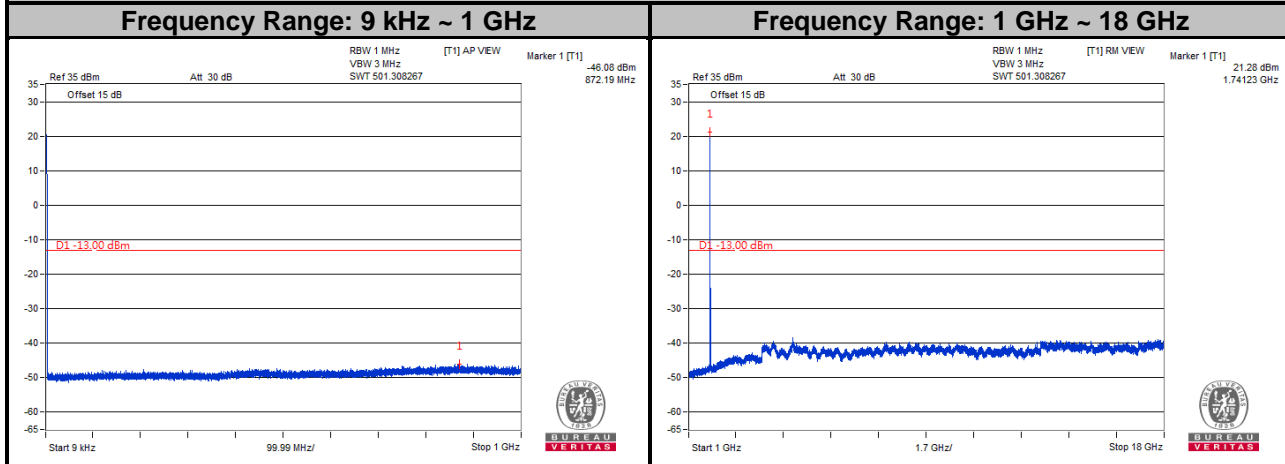

Note: The signal over the limit in 9 kHz is from spectrum analyzer.

LTE Band 4
Channel Bandwidth: 20 MHz
Channel 20050

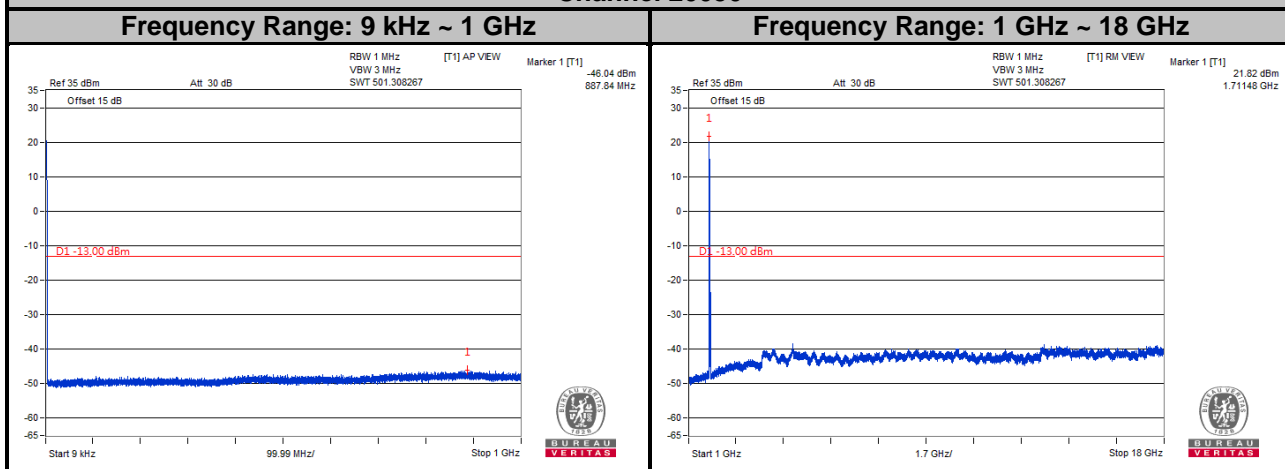

Channel Bandwidth: 20 MHz
Channel 20175

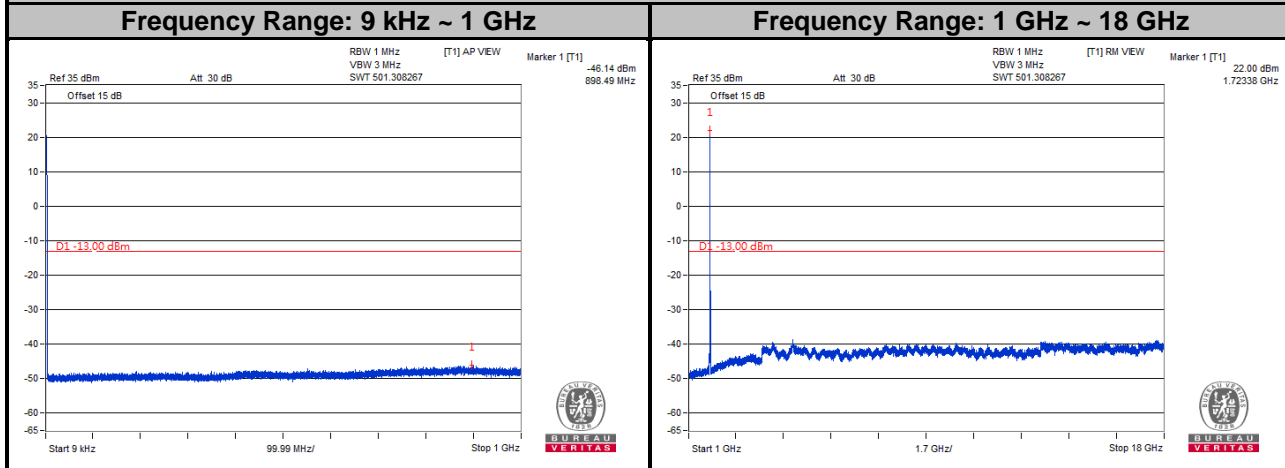

Channel Bandwidth: 20 MHz
Channel 20300

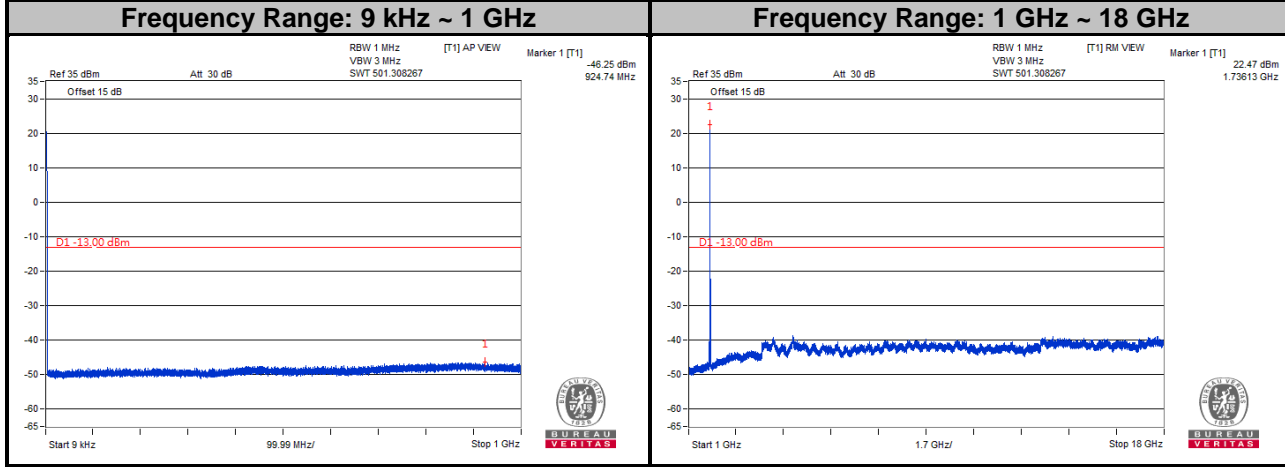

Note: The signal over the limit in 9 kHz is from spectrum analyzer.

4.8 Radiated Emission Measurement

4.8.1 Limits of Radiated Emission Measurement

- a. The power of any emission outside a licensee's frequency block shall be attenuated below the transmitter power (P) by at least $43 + 10 \log (P)$ dB. The limit of emission is equal to -13 dBm.

4.8.2 Test Procedure

- a. Substitution method is used for E.I.R.P measurement. In the semi-anechoic chamber, EUT placed on the 0.8 m (below or equal 1 GHz) and/or 1.5 m (above 1 GHz) height of Turn Table, rotated the table around 360 degrees to search the maximum radiation power and receiver antenna shall be rotated vertical and horizontal polarization and moved height from 1 m to 4 m to find the maximum polar radiated power. The "Read Value" is the spectrum reading the maximum power value.
- b. The substitution horn antenna is substituted for EUT at the same position and signals generator export the CW signal to the substitution antenna via a TX cable. Rotated the Turn Table and moved receiving antenna to find the maximum radiation power. Adjust output power level of S.G to get a Value of spectrum reading equal to "Read Value" of step a. Record the power level of S.G.
- c. $EIRP = \text{Output power level of S.G} - \text{TX cable loss} + \text{Antenna gain of substitution horn}$.
- d. E.R.P power can be calculated form E.I.R.P power by subtracting the gain of dipole, $E.R.P \text{ power} = E.I.R.P \text{ power} - 2.15 \text{ dB}$.

Note: The resolution bandwidth of spectrum analyzer is 1 MHz and the video bandwidth is 3 MHz.

4.8.3 Deviation from Test Standard

No deviation.

4.8.4 Test Setup

<Radiated Emission below or equal 1 GHz>

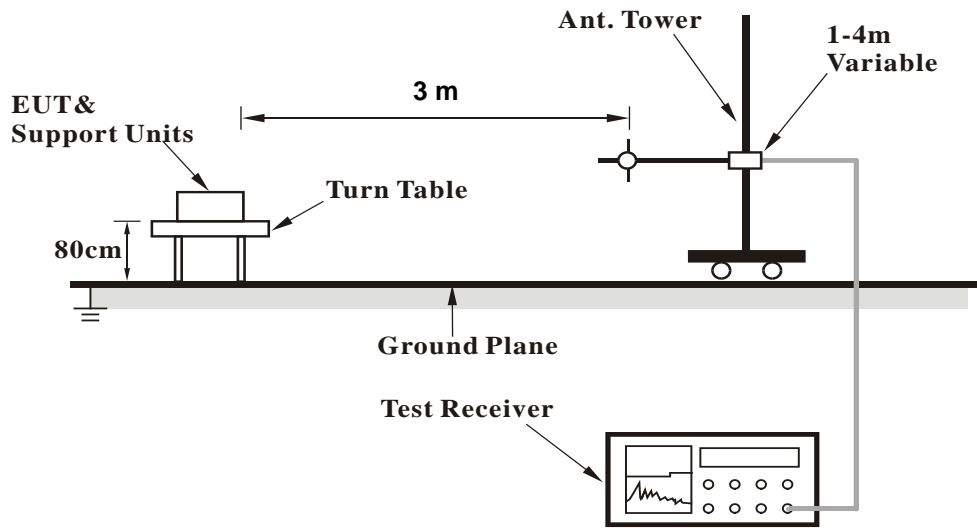

<Radiated Emission above 1 GHz>

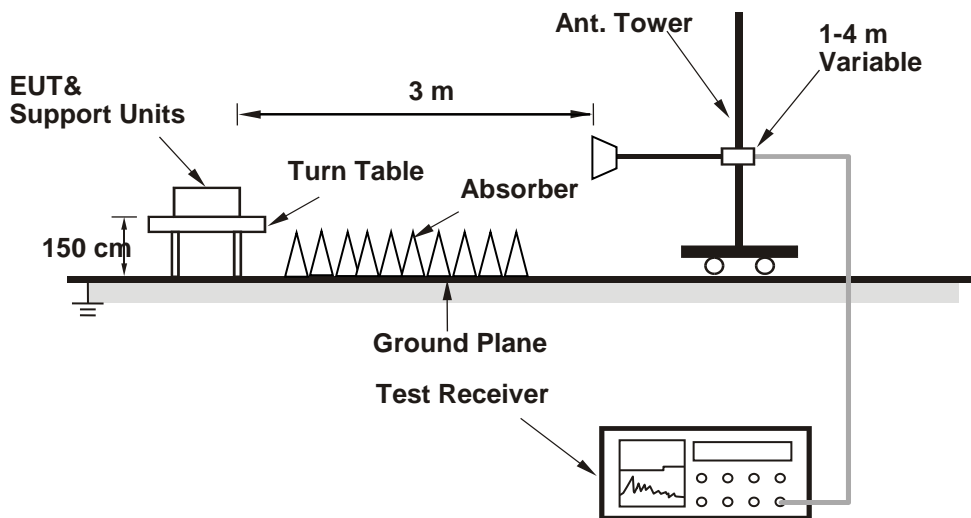

For the actual test configuration, please refer to the attached file (Test Setup Photo).

4.8.5 Test Results

WCDMA:
Low Channel



Bureau Veritas Consumer Products Services Ltd., Taoyuan Branch

A D T

Data: 3

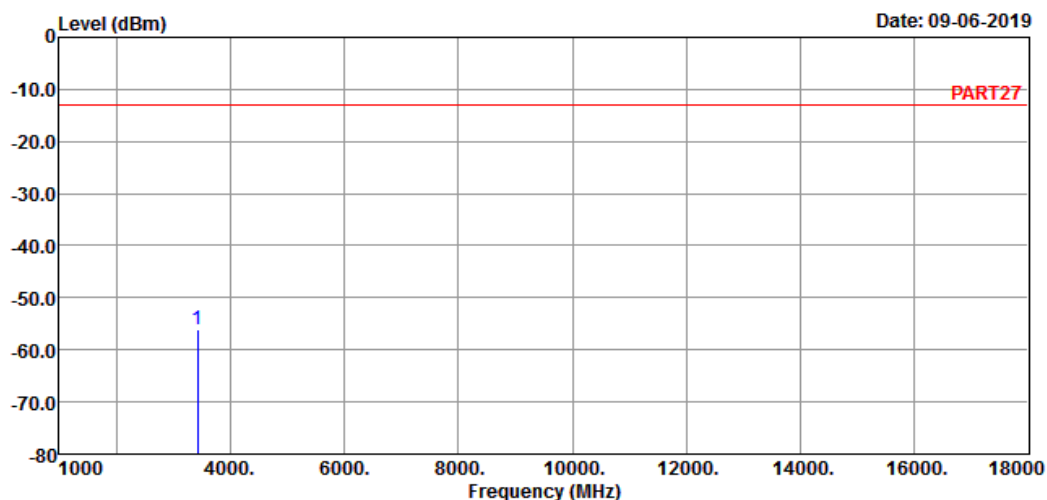

Site : 966 Chamber 5
Condition: PART27 HORIZONTAL
Remark : WCDMA Band 4 Link_L-CH
Tested by: Thomas Wei

Freq	Level	Read Level	Limit	Line Factor	Over Limit	Remark
MHz	dBm	dBm	dBm	dB	dB	
1 pp 3424.80	-55.97	-47.63	-13.00	-8.34	-42.97	Peak



Bureau Veritas Consumer Products Services Ltd., Taoyuan Branch

A D T

Data: 4

Date: 09-06-2019

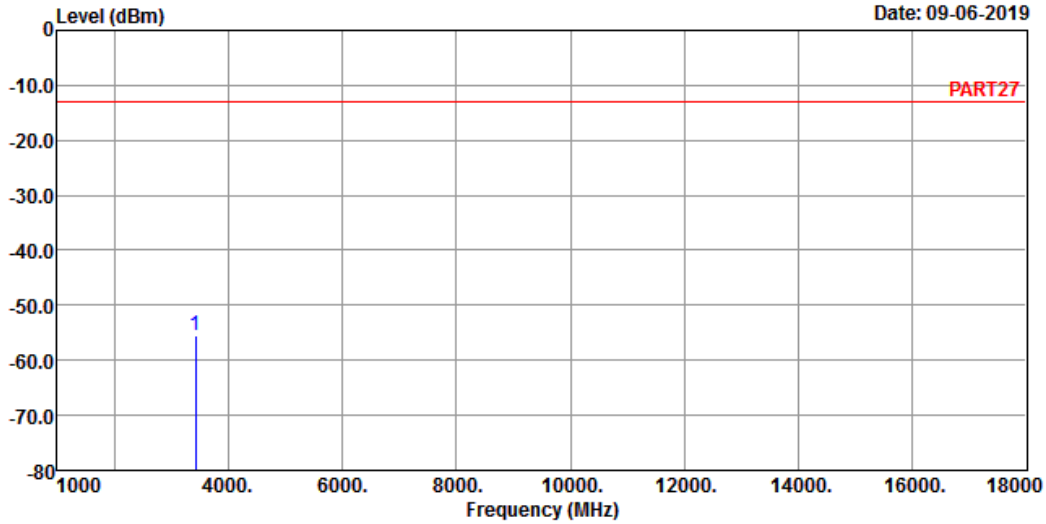

Site : 966 Chamber 5
 Condition: PART27 VERTICAL
 Remark : WCDMA Band 4 Link_L-CH
 Tested by: Thomas Wei

Freq	Level	Read Level	Limit	Line Factor	Over Limit	Remark
MHz	dBm	dBm	dBm	dB	dB	
1 pp 3424.80	-55.53	-47.19	-13.00	-8.34	-42.53	Peak

Middle Channel



Bureau Veritas Consumer Products Services Ltd., Taoyuan Branch

A D T

Data: 5

Date: 08-15-2019

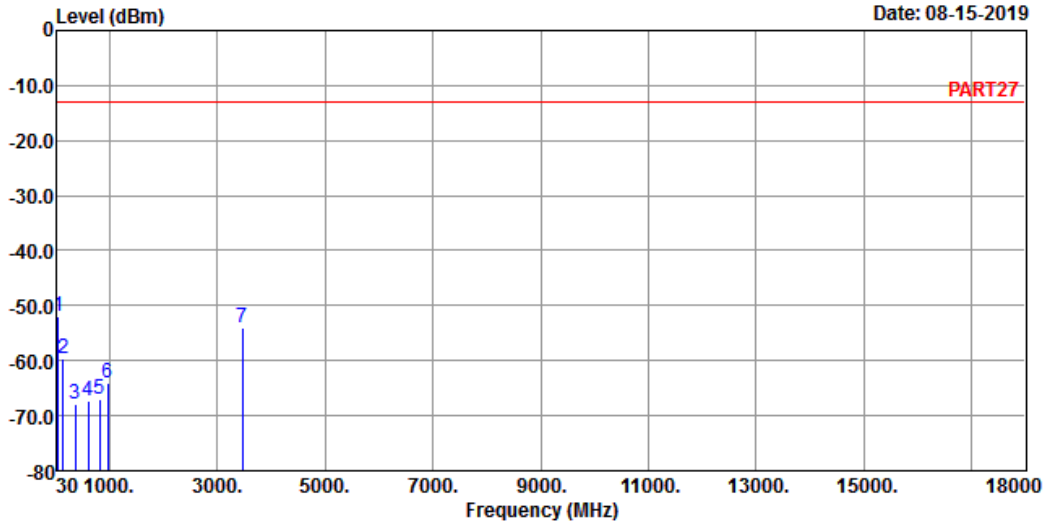

Site : 966 Chamber 5
 Condition: PART27 HORIZONTAL
 Remark : WCDMA Band 4 Link_M-CH
 Tested by: Thomas Wei

	Freq	Level	Read Level	Limit	Line Factor	Over Limit	Remark
	MHz	dBm	dBm	dBm	dB	dB	
1 pp	53.28	-52.03	-46.22	-13.00	-5.81	-39.03	Peak
2	132.82	-59.50	-50.82	-13.00	-8.68	-46.50	Peak
3	358.83	-67.76	-61.57	-13.00	-6.19	-54.76	Peak
4	602.30	-67.44	-66.68	-13.00	-0.76	-54.44	Peak
5	821.52	-67.00	-67.54	-13.00	0.54	-54.00	Peak
6	967.02	-64.13	-66.54	-13.00	2.41	-51.13	Peak
7	3465.20	-54.07	-46.19	-13.00	-7.88	-41.07	Peak



Bureau Veritas Consumer Products Services Ltd., Taoyuan Branch

A D T

Data: 6

Date: 08-15-2019

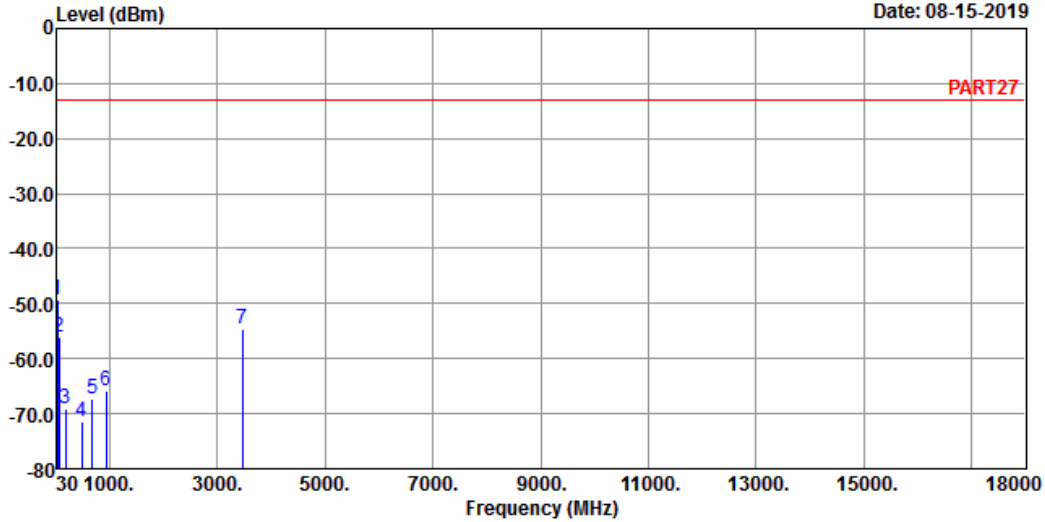

Site : 966 Chamber 5
 Condition: PART27 VERTICAL
 Remark : WCDMA Band 4 Link_M-CH
 Tested by: Thomas Wei

	Read	Limit	Over			
Freq	Level	Level	Line	Factor	Limit	Remark
MHz	dBm	dBm	dBm	dB	dB	
1 pp	36.79	-49.25	-48.26	-13.00	-0.99	-36.25 Peak
2	70.74	-56.21	-47.59	-13.00	-8.62	-43.21 Peak
3	181.32	-68.95	-61.58	-13.00	-7.37	-55.95 Peak
4	486.87	-71.55	-66.69	-13.00	-4.86	-58.55 Peak
5	684.75	-67.30	-66.96	-13.00	-0.34	-54.30 Peak
6	934.04	-65.78	-67.19	-13.00	1.41	-52.78 Peak
7	3465.20	-54.63	-46.75	-13.00	-7.88	-41.63 Peak

High Channel



Bureau Veritas Consumer Products Services Ltd., Taoyuan Branch

A D T

Data: 3

Date: 09-06-2019

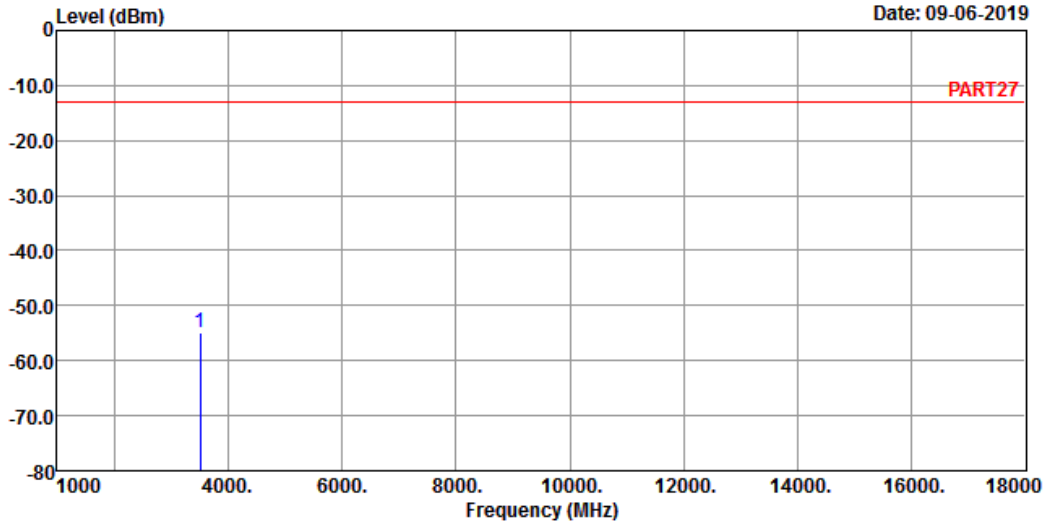

Site : 966 Chamber 5
 Condition: PART27 HORIZONTAL
 Remark : WCDMA Band 4 Link_H-CH
 Tested by: Thomas Wei

	Read	Limit	Over		
Freq	Level	Level	Line	Factor	Limit Remark
MHz	dBm	dBm	dBm	dB	dB
1 pp 3505.20	-54.93	-47.48	-13.00	-7.45	-41.93 Peak



Bureau Veritas Consumer Products Services Ltd., Taoyuan Branch

A D T

Data: 4

Date: 09-06-2019

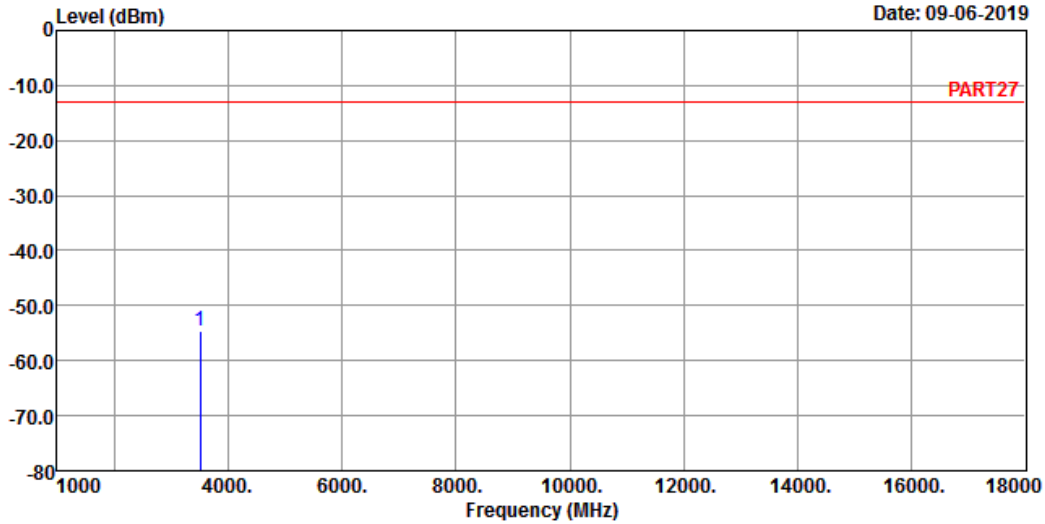

Site : 966 Chamber 5
 Condition: PART27 VERTICAL
 Remark : WCDMA Band 4 Link_H-CH
 Tested by: Thomas Wei

Freq	Level	Read Level	Limit	Line Factor	Over Limit	Remark
MHz	dBm	dBm	dBm	dB	dB	
1 pp 3505.20	-54.50	-47.05	-13.00	-7.45	-41.50	Peak

LTE Band 4
Channel Bandwidth: 1.4 MHz / QPSK
Low Channel



Bureau Veritas Consumer Products Services Ltd., Taoyuan Branch

A D T

Data: 3

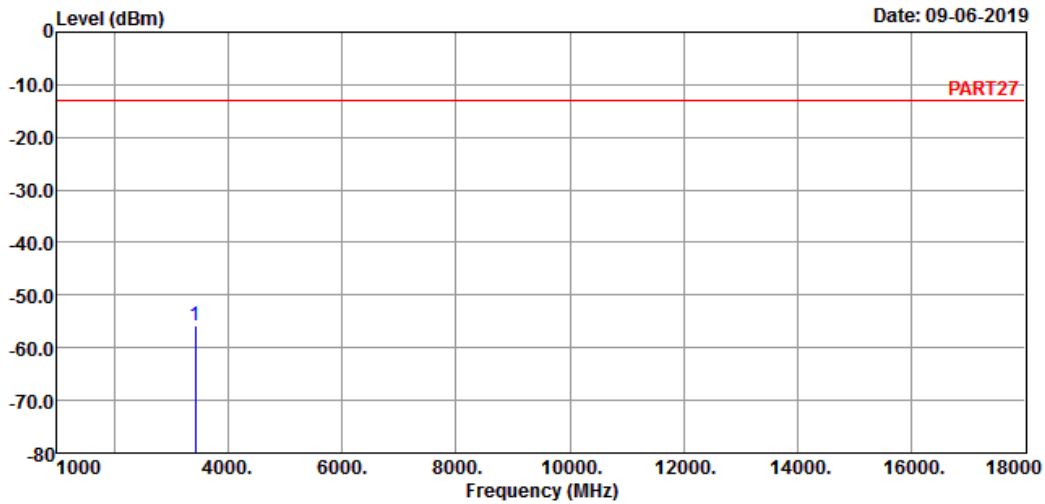

Site : 966 Chamber 5
Condition: PART27 HORIZONTAL
Remak : LTE Band 4 QPSK_1.4M Link_L-CH
Tested by: Thomas Wei

Freq	Level	Read Level	Limit	Line Factor	Over Limit	Remark
MHz	dBm	dBm	dBm	dB	dB	
1 pp 3421.40	-55.73	-47.39	-13.00	-8.34	-42.73	Peak



Bureau Veritas Consumer Products Services Ltd., Taoyuan Branch

A D T

Data: 4

Date: 09-06-2019

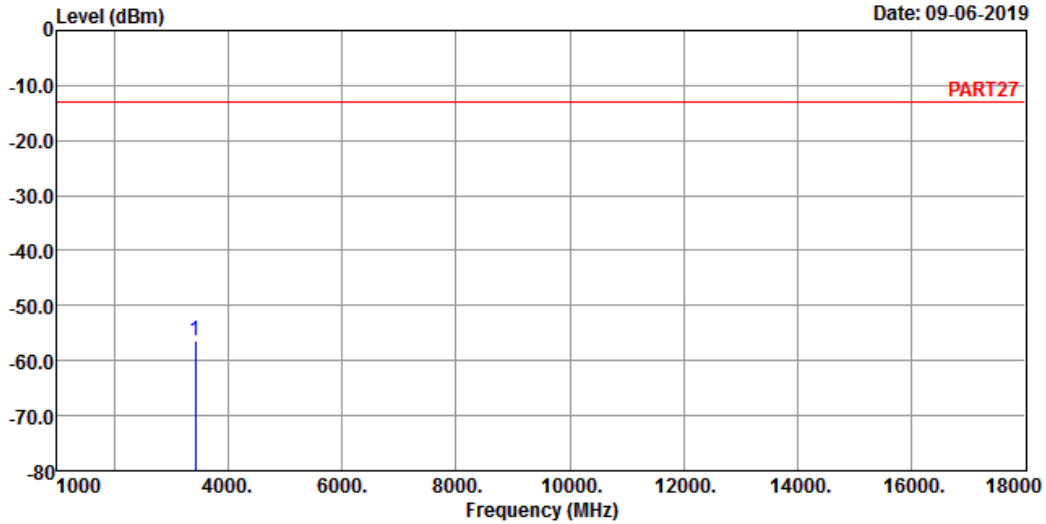

Site : 966 Chamber 5
 Condition: PART27 VERTICAL
 Remak : LTE Band 4 QPSK_1.4M Link_L-CH
 Tested by: Thomas Wei

Freq	Level	Read Level	Limit	Line Factor	Over Limit	Remark
MHz	dBm	dBm	dBm	dB	dB	
1 pp 3421.40	-56.34	-48.00	-13.00	-8.34	-43.34	Peak

Middle Channel



Bureau Veritas Consumer Products Services Ltd., Taoyuan Branch

A D T

Data: 3

Date: 09-06-2019

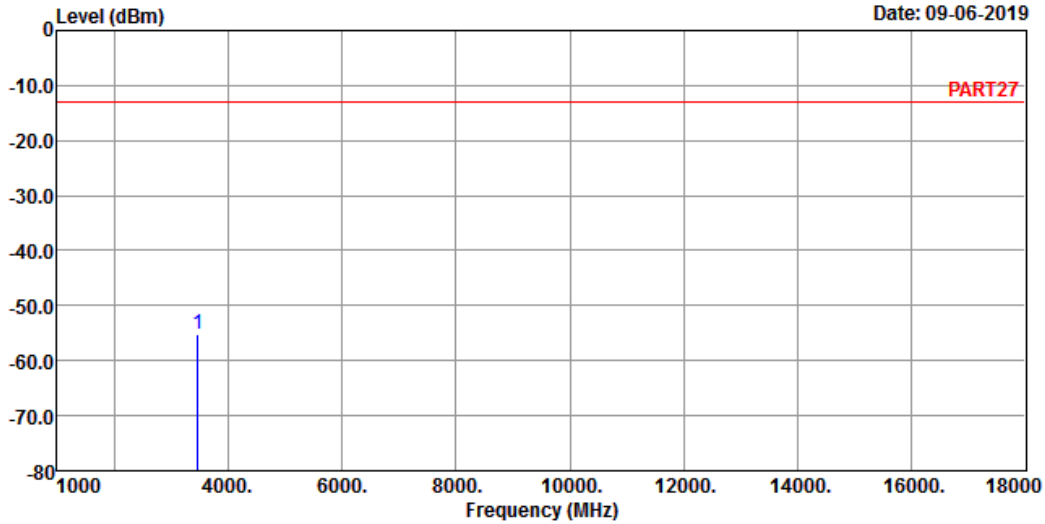

Site : 966 Chamber 5
 Condition: PART27 HORIZONTAL
 Remak : LTE Band 4 QPSK_1.4M Link_M-CH
 Tested by: Thomas Wei

Freq	Level	Read Level	Limit	Line Factor	Over Limit	Remark
MHz	dBm	dBm	dBm	dB	dB	

1 pp 3465.00 -55.18 -47.30 -13.00 -7.88 -42.18 Peak



Bureau Veritas Consumer Products Services Ltd., Taoyuan Branch

A D T

Data: 4

Date: 09-06-2019

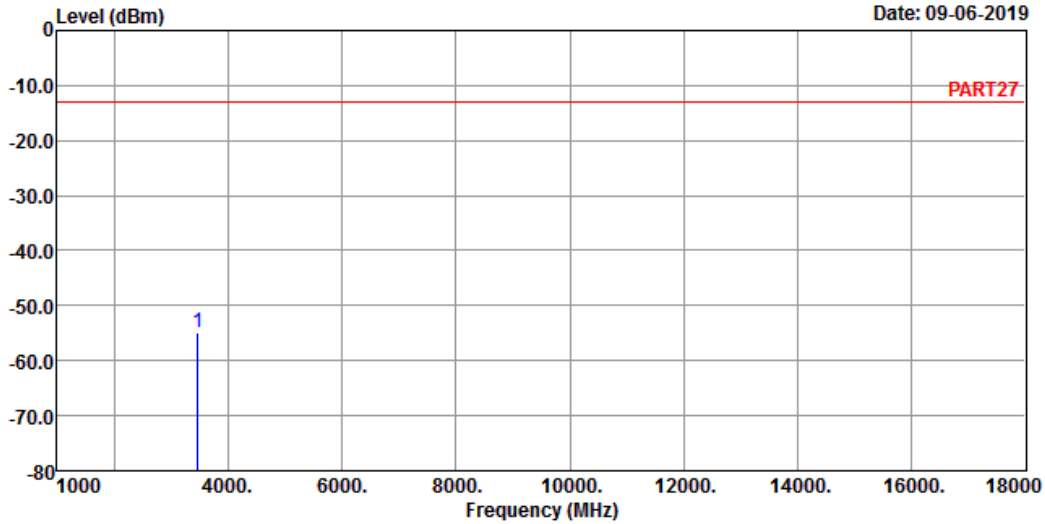

Site : 966 Chamber 5
 Condition: PART27 VERTICAL
 Remak : LTE Band 4 QPSK_1.4M Link_M-CH
 Tested by: Thomas Wei

Freq	Level	Read Level	Limit	Line Factor	Over Limit	Remark
MHz	dBm	dBm	dBm	dB	dB	
1 pp 3465.00	-54.86	-46.98	-13.00	-7.88	-41.86	Peak

High Channel



Bureau Veritas Consumer Products Services Ltd., Taoyuan Branch

A D T

Data: 3

Date: 09-06-2019

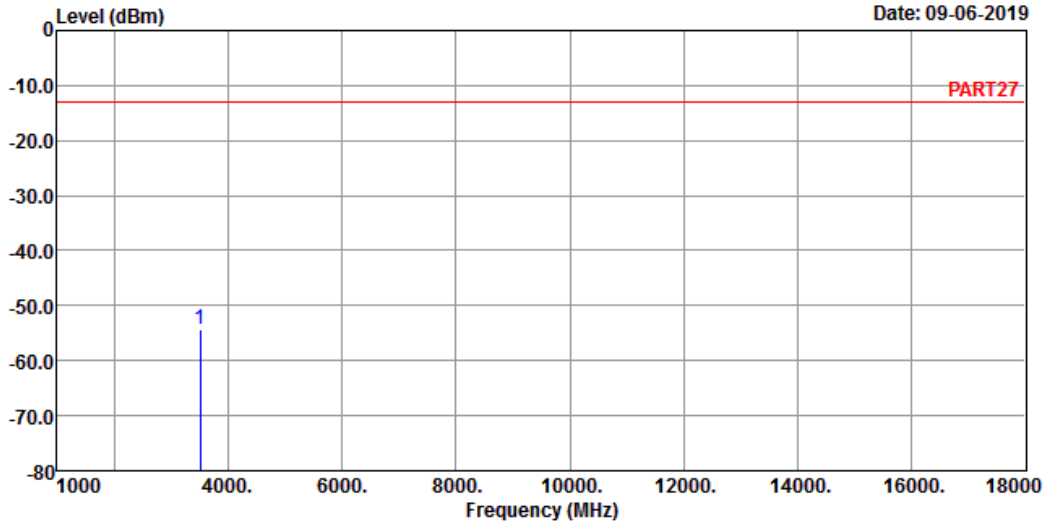

Site : 966 Chamber 5
 Condition: PART27 HORIZONTAL
 Remak : LTE Band 4 QPSK_1.4M Link_H-CH
 Tested by: Thomas Wei

Freq	Level	Read Level	Limit	Line Factor	Over Limit	Remark
MHz	dBm	dBm	dBm	dB	dB	

1 pp 3508.60 -54.37 -46.92 -13.00 -7.45 -41.37 Peak



Bureau Veritas Consumer Products Services Ltd., Taoyuan Branch

A D T

Data: 4

Date: 09-06-2019

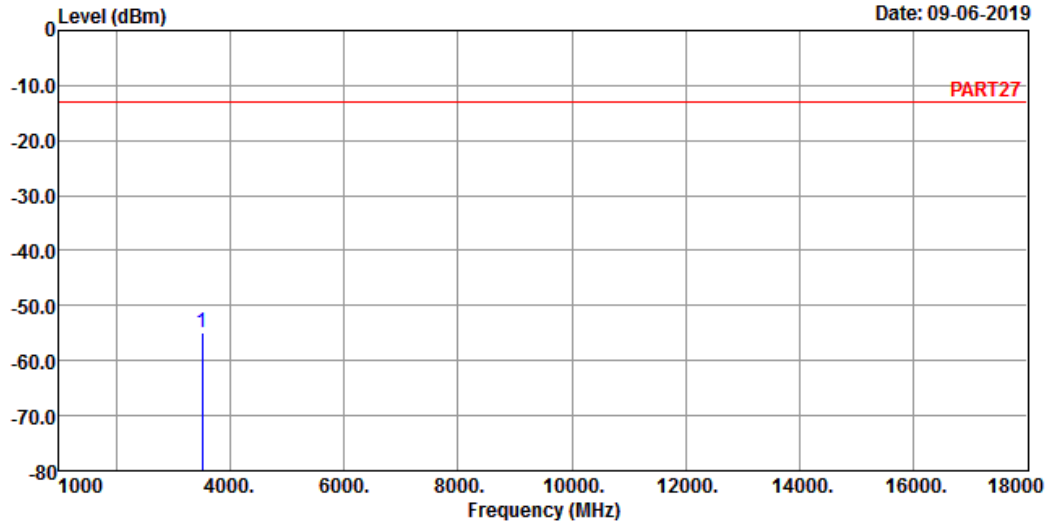

Site : 966 Chamber 5
 Condition: PART27 VERTICAL
 Remak : LTE Band 4 QPSK_1.4M Link_H-CH
 Tested by: Thomas Wei

Freq	Level	Read Level	Limit	Line Factor	Over Limit	Remark
MHz	dBm	dBm	dBm	dB	dB	
1 pp 3508.60	-54.89	-47.44	-13.00	-7.45	-41.89	Peak

Channel Bandwidth: 5 MHz / QPSK
Low Channel



Bureau Veritas Consumer Products Services Ltd., Taoyuan Branch

A D T

Data: 3

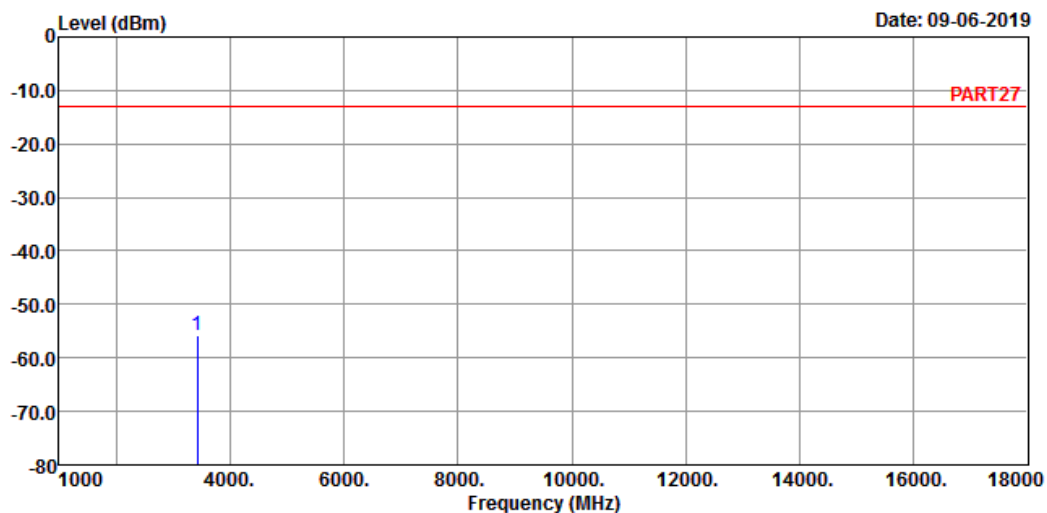

Site : 966 Chamber 5
Condition: PART27 HORIZONTAL
Remak : LTE Band 4 QPSK_5M Link_L-CH
Tested by: Thomas Wei

Freq	Level	Read Level	Limit	Over	Remark
MHz	dBm	dBm	dBm	dB	dB
1 pp 3425.00	-55.68	-47.34	-13.00	-8.34	-42.68 Peak



Bureau Veritas Consumer Products Services Ltd., Taoyuan Branch

A D T

Data: 4

Date: 09-06-2019

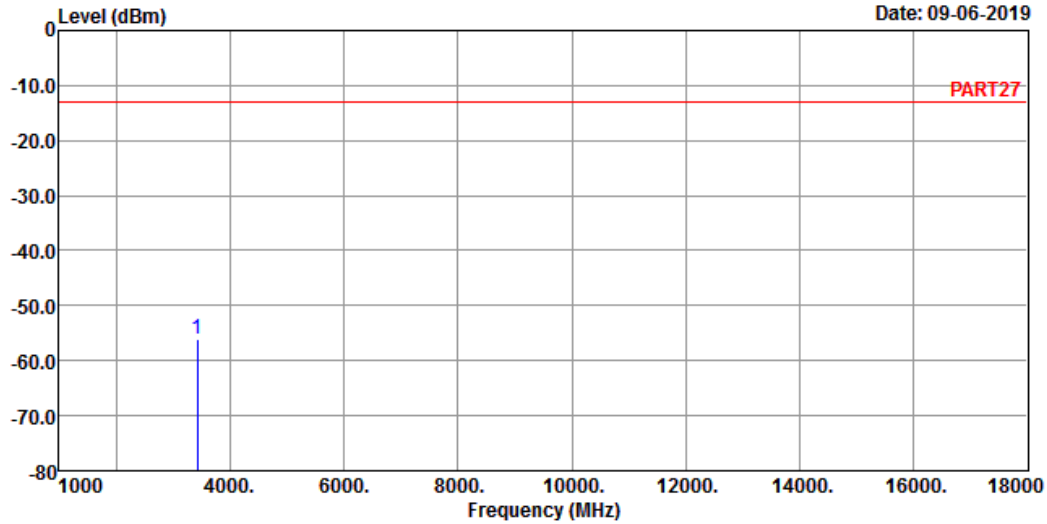

Site : 966 Chamber 5
 Condition: PART27 VERTICAL
 Remak : LTE Band 4 QPSK_5M Link_L-CH
 Tested by: Thomas Wei

Freq	Level	Read Level	Limit	Line Factor	Over Limit	Remark
MHz	dBm	dBm	dBm	dB	dB	
1 pp 3425.00	-56.22	-47.88	-13.00	-8.34	-43.22	Peak

Middle Channel



Bureau Veritas Consumer Products Services Ltd., Taoyuan Branch

A D T

Data: 3

Date: 09-06-2019

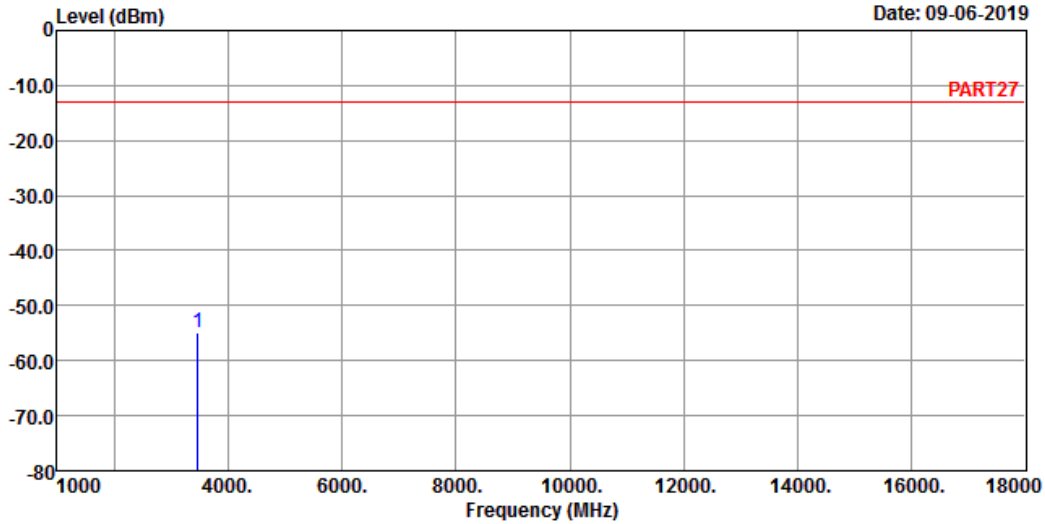

Site : 966 Chamber 5
 Condition: PART27 HORIZONTAL
 Remak : LTE Band 4 QPSK_5M Link_M-CH
 Tested by: Thomas Wei

Freq	Level	Read Level	Limit	Line Factor	Over Limit	Remark
MHz	dBm	dBm	dBm	dB	dB	

1 pp 3465.00 -55.04 -47.16 -13.00 -7.88 -42.04 Peak



Bureau Veritas Consumer Products Services Ltd., Taoyuan Branch

A D T

Data: 4

Date: 09-06-2019

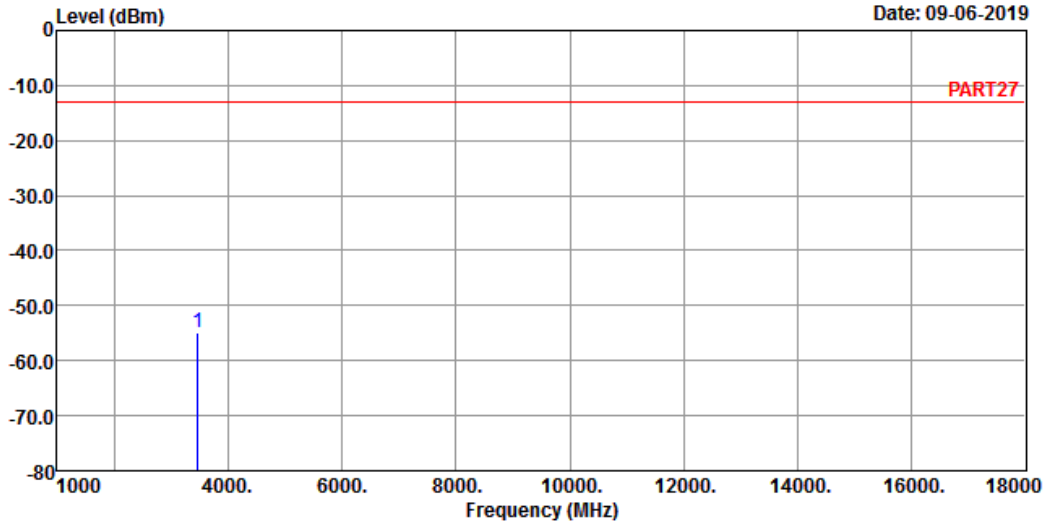

Site : 966 Chamber 5
 Condition: PART27 VERTICAL
 Remak : LTE Band 4 QPSK_5M Link_M-CH
 Tested by: Thomas Wei

Freq	Level	Read Level	Limit	Line Factor	Over Limit	Remark
MHz	dBm	dBm	dBm	dB	dB	
1 pp 3465.00	-54.78	-46.90	-13.00	-7.88	-41.78	Peak

High Channel



Bureau Veritas Consumer Products Services Ltd., Taoyuan Branch

A D T

Data: 3

Date: 09-06-2019

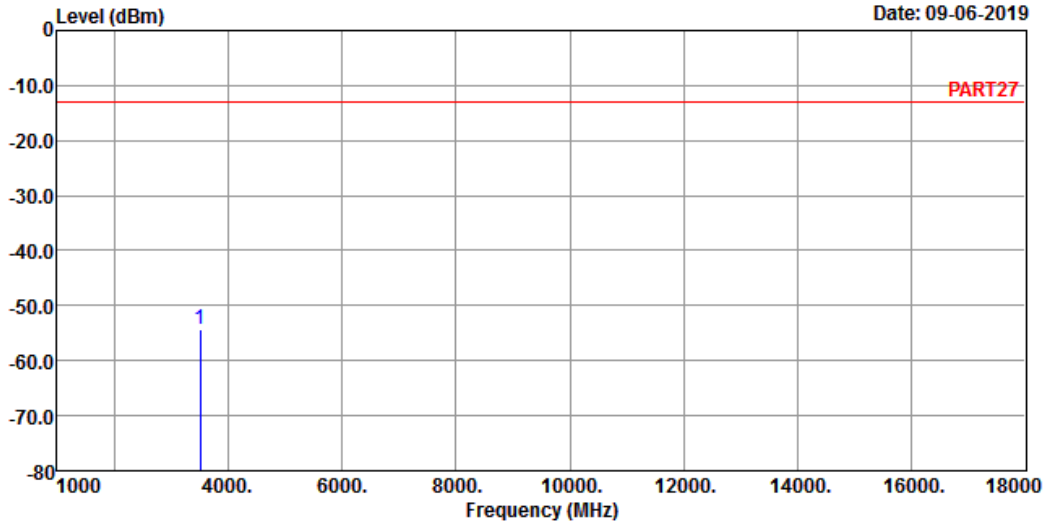

Site : 966 Chamber 5
 Condition: PART27 HORIZONTAL
 Remak : LTE Band 4 QPSK_5M Link_H-CH
 Tested by: Thomas Wei

	Read	Limit	Over		
Freq	Level	Level	Line	Factor	Limit Remark
MHz	dBm	dBm	dBm	dB	dB
1 pp 3505.00	-54.22	-46.77	-13.00	-7.45	-41.22 Peak



Bureau Veritas Consumer Products Services Ltd., Taoyuan Branch

A D T

Data: 4

Date: 09-06-2019

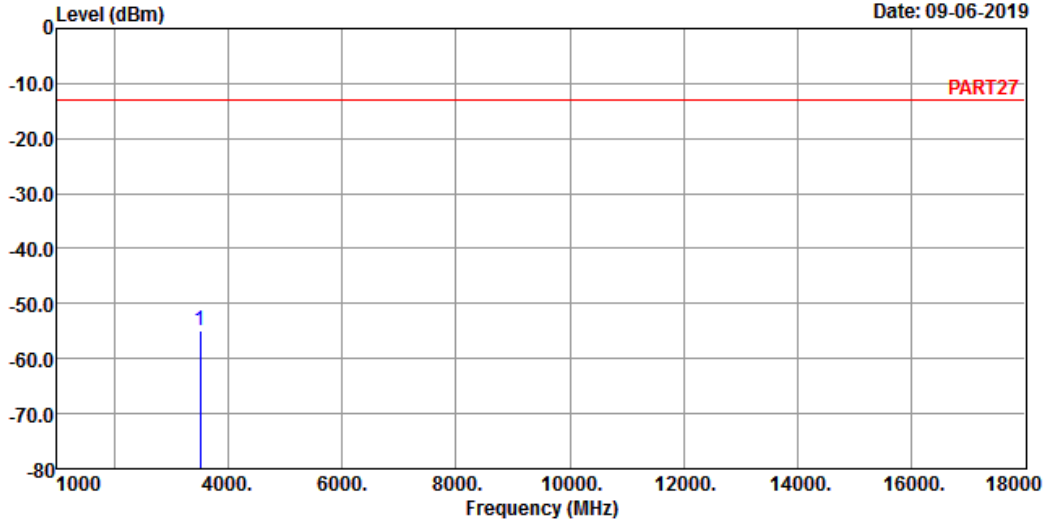

Site : 966 Chamber 5
 Condition: PART27 VERTICAL
 Remak : LTE Band 4 QPSK_5M Link_H-CH
 Tested by: Thomas Wei

Freq	Level	Read Level	Limit	Line Factor	Over Limit	Remark
MHz	dBm	dBm	dBm	dB	dB	
1 pp 3505.00	-54.78	-47.33	-13.00	-7.45	-41.78	Peak

Channel Bandwidth: 20 MHz / QPSK
Low Channel



Bureau Veritas Consumer Products Services Ltd., Taoyuan Branch

A D T

Data: 3

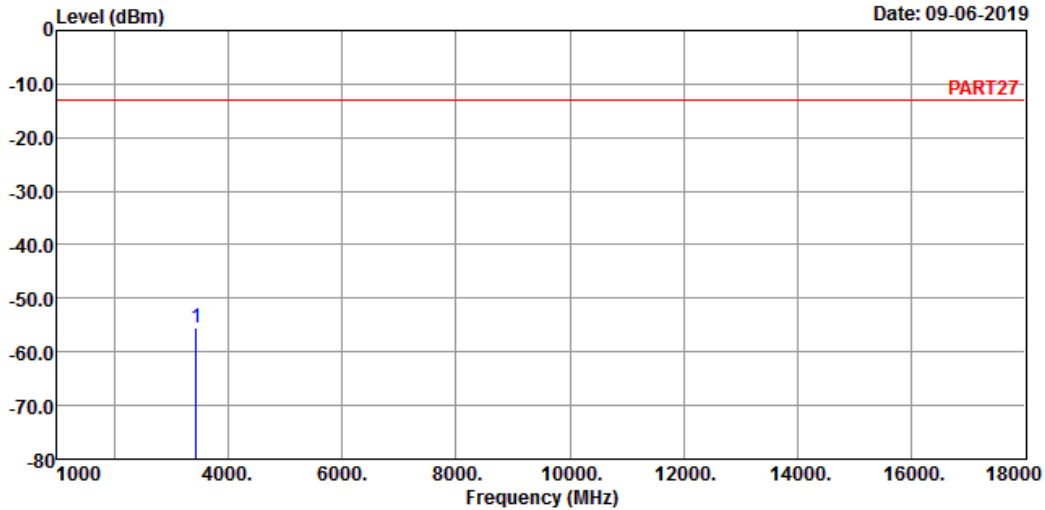

Site : 966 Chamber 5
Condition: PART27 HORIZONTAL
Remak : LTE Band 4 QPSK_20M Link_L-CH
Tested by: Thomas Wei

Freq	Level	Read Level	Limit	Over	Remark
MHz	dBm	dBm	dBm	dB	dB
1 pp 3440.00	-55.43	-47.21	-13.00	-8.22	-42.43 Peak



Bureau Veritas Consumer Products Services Ltd., Taoyuan Branch

A D T

Data: 4

Date: 09-06-2019

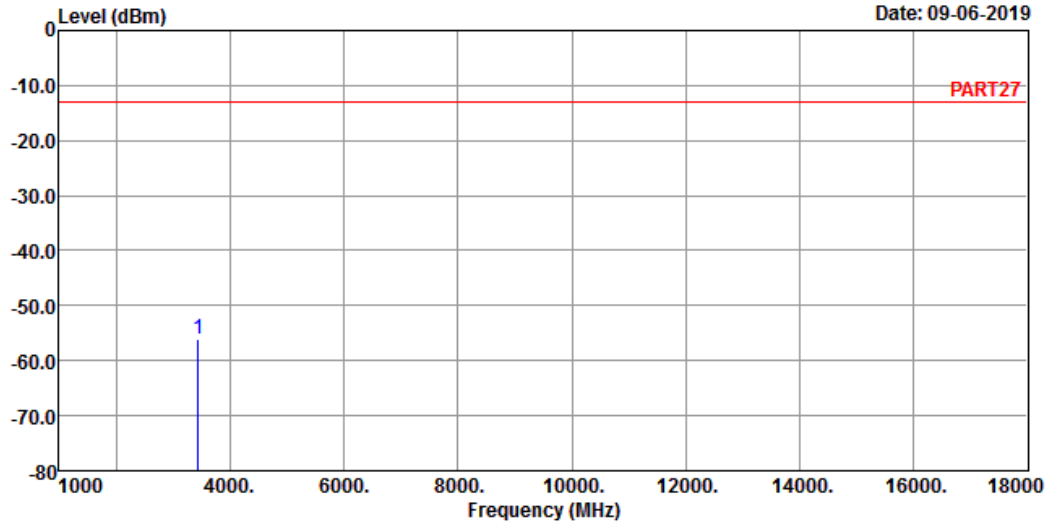

Site : 966 Chamber 5
 Condition: PART27 VERTICAL
 Remak : LTE Band 4 QPSK_20M Link_L-CH
 Tested by: Thomas Wei

Freq	Level	Read Level	Limit	Line Factor	Over Limit	Remark
MHz	dBm	dBm	dBm	dB	dB	
1 pp 3440.00	-56.10	-47.88	-13.00	-8.22	-43.10	Peak

Middle Channel



Bureau Veritas Consumer Products Services Ltd., Taoyuan Branch

A D T

Data: 3

Date: 08-15-2019

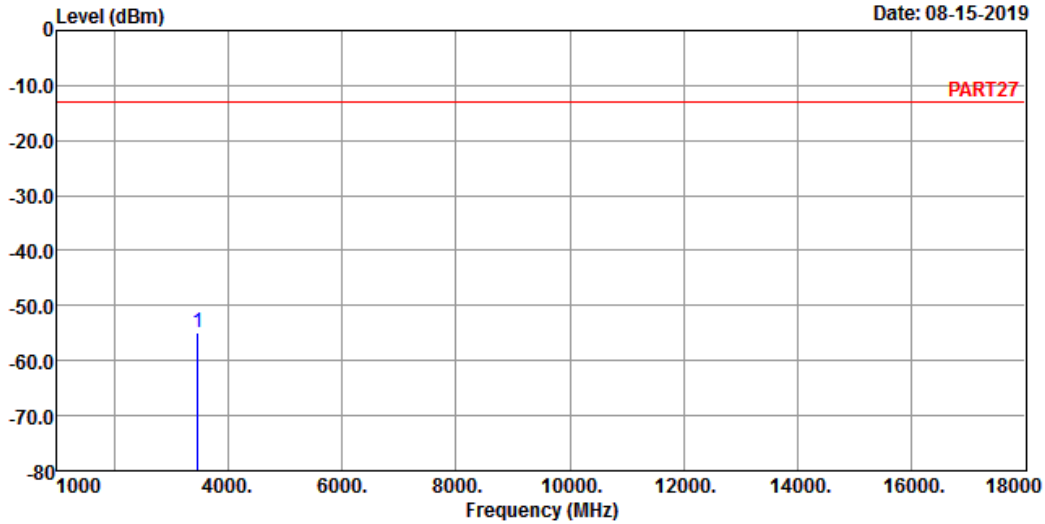

Site : 966 Chamber 5
 Condition: PART27 HORIZONTAL
 Remak : LTE Band 4 QPSK_20M Link_M-CH
 Tested by: Thomas Wei

Freq	Level	Read Level	Limit	Line Factor	Over Limit	Remark
MHz	dBm	dBm	dBm	dB	dB	
1 pp 3465.00	-54.96	-47.08	-13.00	-7.88	-41.96	Peak



Bureau Veritas Consumer Products Services Ltd., Taoyuan Branch

A D T

Data: 4

Date: 08-15-2019

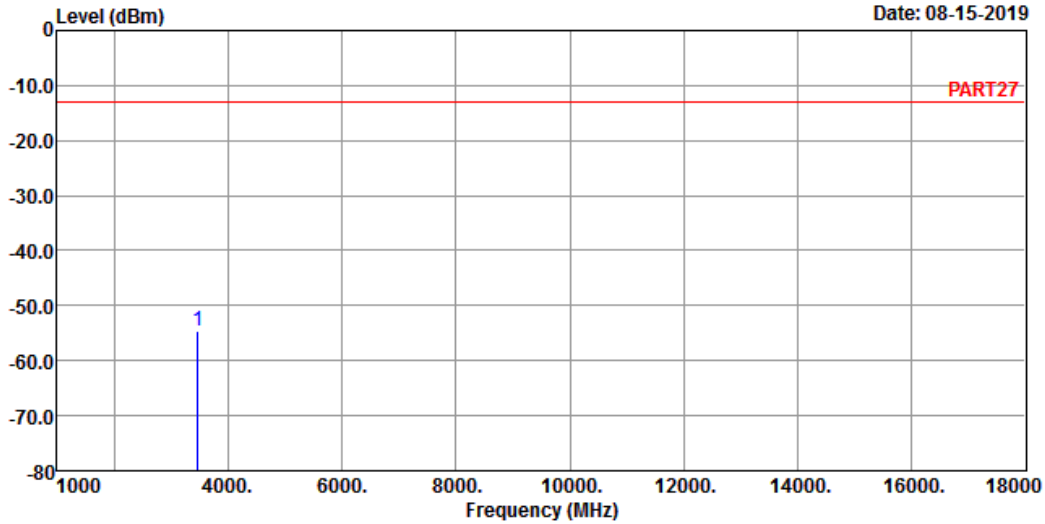

Site : 966 Chamber 5
 Condition: PART27 VERTICAL
 Remak : LTE Band 4 QPSK_20M Link_M-CH
 Tested by: Thomas Wei

Freq	Level	Read Level	Limit	Line Factor	Over Limit	Remark
MHz	dBm	dBm	dBm	dB	dB	
1 pp 3465.00	-54.72	-46.84	-13.00	-7.88	-41.72	Peak

High Channel



Bureau Veritas Consumer Products Services Ltd., Taoyuan Branch

A D T

Data: 5

Date: 09-06-2019

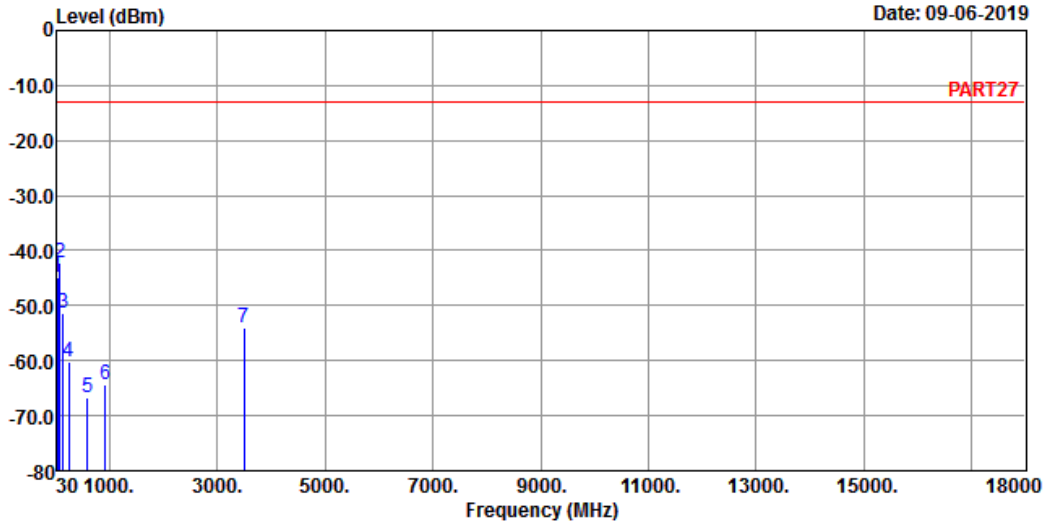

Site : 966 Chamber 5
 Condition: PART27 HORIZONTAL
 Remak : LTE Band 4 QPSK_20M Link_H-CH
 Tested by: Thomas Wei

	Freq	Level	Read Level	Limit	Line Factor	Over Limit	Remark
	MHz	dBm	dBm	dBm	dB	dB	
1	32.91	-44.89	-43.80	-13.00	-1.09	-31.89	Peak
2 pp	77.53	-42.36	-32.16	-13.00	-10.20	-29.36	Peak
3	135.73	-51.44	-42.77	-13.00	-8.67	-38.44	Peak
4	245.34	-60.34	-54.15	-13.00	-6.19	-47.34	Peak
5	597.45	-66.58	-65.71	-13.00	-0.87	-53.58	Peak
6	923.37	-64.33	-65.48	-13.00	1.15	-51.33	Peak
7	3490.00	-54.10	-46.45	-13.00	-7.65	-41.10	Peak



Bureau Veritas Consumer Products Services Ltd., Taoyuan Branch

A D T

Data: 6

Date: 09-06-2019

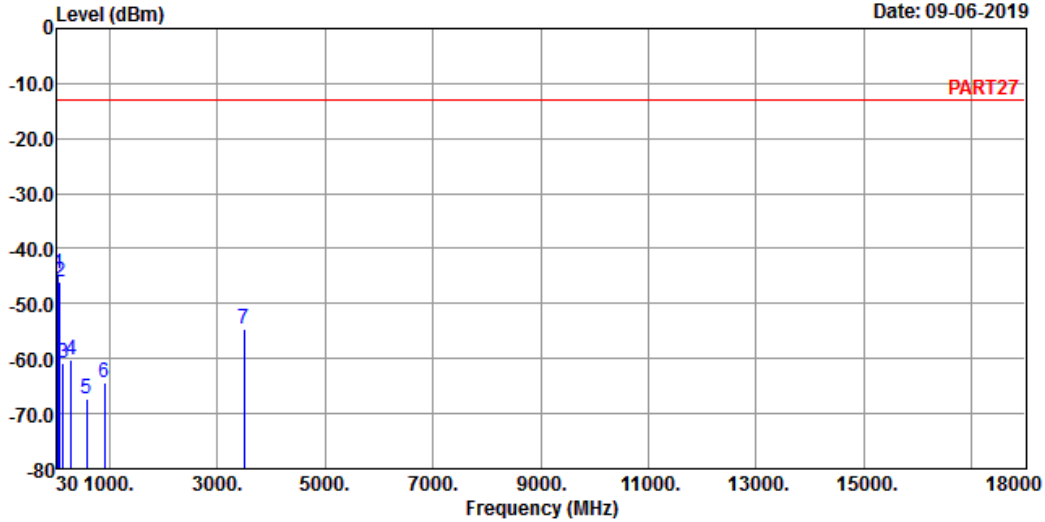

Site : 966 Chamber 5
 Condition: PART27 VERTICAL
 Remak : LTE Band 4 QPSK_20M Link_H-CH
 Tested by: Thomas Wei

	Freq	Level	Read Level	Limit Line	Over Factor	Over Limit	Remark
	MHz	dBm	dBm	dBm	dB	dB	
1 pp	43.58	-44.59	-43.12	-13.00	-1.47	-31.59	Peak
2	78.50	-46.14	-35.71	-13.00	-10.43	-33.14	Peak
3	134.76	-60.74	-52.07	-13.00	-8.67	-47.74	Peak
4	290.93	-60.10	-53.27	-13.00	-6.83	-47.10	Peak
5	571.26	-67.25	-65.29	-13.00	-1.96	-54.25	Peak
6	913.67	-64.45	-65.36	-13.00	0.91	-51.45	Peak
7	3490.00	-54.55	-46.90	-13.00	-7.65	-41.55	Peak

5 Pictures of Test Arrangements

Please refer to the attached file (Test Setup Photo).

Appendix – Information of the Testing Laboratories

We, Bureau Veritas Consumer Products Services (H.K.) Ltd., Taoyuan Branch, were founded in 1988 to provide our best service in EMC, Radio, Telecom and Safety consultation. Our laboratories are FCC recognized accredited test firms and accredited according to ISO/IEC 17025.

If you have any comments, please feel free to contact us at the following:

Lin Kou EMC/RF Lab

Tel: 886-2-26052180

Fax: 886-2-26051924

Hsin Chu EMC/RF/Telecom Lab

Tel: 886-3-6668565

Fax: 886-3-6668323

Hwa Ya EMC/RF/Safety Lab

Tel: 886-3-3183232

Fax: 886-3-3270892

Email: service.adt@tw.bureauveritas.com

Web Site: www.bureauveritas-adt.com

The address and road map of all our labs can be found in our web site also.

--- END ---