

## FCC Test Report

### (PART 27)

**Report No.:** RF190723C05-8

**FCC ID:** ZL5S52E

**Test Model:** S52

**Received Date:** Jul. 23, 2019

**Test Date:** Aug. 12 ~ Oct. 09, 2019

**Issued Date:** Oct. 09, 2019

**Applicant:** Bullitt Group

**Address:** One Valpy, Valpy Street, Reading, RG1 1AR, Berkshire, UK

**Issued By:** Bureau Veritas Consumer Products Services (H.K.) Ltd., Taoyuan Branch  
Lin Kou Laboratories

**Lab Address:** No. 47-2, 14th Ling, Chia Pau Vil., Lin Kou Dist., New Taipei City, Taiwan

**Test Location:** No.19, Hwa Ya 2nd Rd., Wen Hwa Vil., Kwei Shan Dist., Taoyuan City  
33383, Taiwan

**FCC Registration /  
Designation Number:** 788550 / TW0003



This report is for your exclusive use. Any copying or replication of this report to or for any other person or entity, or use of our name or trademark, is permitted only with our prior written permission. This report sets forth our findings solely with respect to the test samples identified herein. The results set forth in this report are not indicative or representative of the quality or characteristics of the lot from which a test sample was taken or any similar or identical product unless specifically and expressly noted. Our report includes all of the tests requested by you and the results thereof based upon the information that you provided to us. You have 60 days from date of issuance of this report to notify us of any material error or omission caused by our negligence, provided, however, that such notice shall be in writing and shall specifically address the issue you wish to raise. A failure to raise such issue within the prescribed time shall constitute your unqualified acceptance of the completeness of this report, the tests conducted and the correctness of the report contents. Unless specific mention, the uncertainty of measurement has been explicitly taken into account to declare the compliance or non-compliance to the specification. The report must not be used by the client to claim product certification, approval, or endorsement by TAF or any government agencies

## Table of Contents

<b>Release Control Record</b> .....	<b>4</b>
<b>1 Certificate of Conformity</b> .....	<b>5</b>
<b>2 Summary of Test Results</b> .....	<b>6</b>
2.1 Measurement Uncertainty .....	6
2.2 Test Site and Instruments .....	7
<b>3 General Information</b> .....	<b>8</b>
3.1 General Description of EUT .....	8
3.2 Configuration of System under Test .....	10
3.2.1 Description of Support Units .....	10
3.3 Test Mode Applicability and Tested Channel Detail .....	11
3.4 EUT Operating Conditions .....	15
3.5 General Description of Applied Standards .....	15
<b>4 Test Types and Results</b> .....	<b>16</b>
4.1 Output Power Measurement .....	16
4.1.1 Limits of Output Power Measurement .....	16
4.1.2 Test Procedures .....	16
4.1.3 Test Setup .....	17
4.1.4 Test Results .....	18
4.2 Modulation Characteristics Measurement .....	30
4.2.1 Limits of Modulation Characteristics .....	30
4.2.2 Test Setup .....	30
4.2.3 Test Procedure .....	30
4.2.4 Test Results .....	31
4.3 Frequency Stability Measurement .....	35
4.3.1 Limits of Frequency Stability Measurement .....	35
4.3.2 Test Procedure .....	35
4.3.3 Test Setup .....	35
4.3.4 Test Results .....	36
4.4 Occupied Bandwidth Measurement .....	46
4.4.1 Limits of Occupied Bandwidth Measurement .....	46
4.4.2 Test Procedure .....	46
4.4.3 Test Setup .....	46
4.4.4 Test Results .....	47
4.5 Out-of-Band Emissions Measurement .....	53
4.5.1 Limits of Out-of-Band Emissions Measurement .....	53
4.5.2 Test Setup .....	53
4.5.3 Test Procedures .....	53
4.5.4 Test Results .....	54
4.6 Peak to Average Ratio .....	80
4.6.1 Limits of Peak to Average Ratio Measurement .....	80
4.6.2 Test Setup .....	80
4.6.3 Test Procedures .....	80
4.6.4 Test Results .....	81
4.7 Conducted Spurious Emissions .....	91
4.7.1 Limits of Conducted Spurious Emissions Measurement .....	91
4.7.2 Test Setup .....	91
4.7.3 Test Procedure .....	91
4.7.4 Test Results .....	92
4.8 Radiated Emission Measurement .....	118
4.8.1 Limits of Radiated Emission Measurement .....	118
4.8.2 Test Procedure .....	118
4.8.3 Deviation from Test Standard .....	118
4.8.4 Test Setup .....	119

4.8.5 Test Results .....	120
<b>5 Pictures of Test Arrangements.....</b>	<b>156</b>
<b>Appendix – Information of the Testing Laboratories .....</b>	<b>157</b>

### Release Control Record

Issue No.	Description	Date Issued
RF190723C05-8	Original Release	Oct. 09, 2019

## 1 Certificate of Conformity

**Product:** Rugged Smart Phone

**Brand:** CAT

**Test Model:** S52

**Sample Status:** Identical Prototype

**Applicant:** Bullitt Group

**Test Date:** Aug. 12 ~ Oct. 09, 2019

**Standards:** FCC Part 27, Subpart C, M

The above equipment has been tested by **Bureau Veritas Consumer Products Services (H.K.) Ltd., Taoyuan Branch**, and found compliance with the requirement of the above standards. The test record, data evaluation & Equipment Under Test (EUT) configurations represented herein are true and accurate accounts of the measurements of the sample's RF characteristics under the conditions specified in this report.

**Prepared by :** Gina Liu, **Date:** Oct. 09, 2019  
Gina Liu / Specialist

**Approved by :** Dylan Chiou, **Date:** Oct. 09, 2019  
Dylan Chiou / Project Engineer

## 2 Summary of Test Results

Applied Standard: FCC Part 27 & Part 2			
FCC Clause	Test Item	Result	Remarks
2.1046 27.50(h)(2)	Equivalent Isotropic Radiated Power	Pass	Meet the requirement of limit.
2.1047	Modulation Characteristics	Pass	Meet the requirement.
2.1055 27.54	Frequency Stability	Pass	Meet the requirement of limit.
2.1049 27.53(m)(6)	Occupied Bandwidth	Pass	Meet the requirement of limit.
--	Peak to Average Ratio	Pass	Meet the requirement of limit.
27.53(m)(4)(6)	Out-of-Band Emissions Measurements	Pass	Meet the requirement of limit.
2.1051 27.53(m)(4)(6)	Conducted Spurious Emissions	Pass	Meet the requirement of limit.
2.1053 27.53(m)(4)(6)	Radiated Spurious Emissions	Pass	Meet the requirement of limit. Minimum passing margin is -14.65 dB at 7680 MHz.

Note: Determining compliance based on the results of the compliance measurement, not taking into account measurement instrumentation uncertainty.

### 2.1 Measurement Uncertainty

Where relevant, the following measurement uncertainty levels have been estimated for tests performed on the EUT as specified in CISPR 16-4-2:

Measurement	Frequency	Expanded Uncertainty (k=2) (±)
Radiated Emissions up to 1 GHz	9 kHz ~ 30 MHz	3.04 dB
	30 MHz ~ 200 MHz	2.93 dB
	200 MHz ~ 1000 MHz	2.95 dB
Radiated Emissions above 1 GHz	1 GHz ~ 18 GHz	2.26 dB
	18 GHz ~ 40 GHz	1.94 dB

## 2.2 Test Site and Instruments

Description & Manufacturer	Model No.	Serial No.	Date of Calibration	Due Date of Calibration
Test Receiver Agilent	N9038A	MY51210203	Mar. 18, 2019	Mar. 17, 2020
Spectrum Analyzer Agilent	N9010A	MY52220314	Dec. 13, 2018	Dec. 12, 2019
Spectrum Analyzer ROHDE & SCHWARZ	FSU43	101261	Apr. 15, 2019	Apr. 14, 2020
Spectrum Analyzer ROHDE & SCHWARZ	FSW26	102023	Oct. 11, 2018	Oct. 10, 2019
HORN Antenna SCHWARZBECK	BBHA 9120D	9120D-969	Nov. 25, 2018	Nov. 24, 2019
BILOG Antenna SCHWARZBECK	VULB 9168	9168-472	Nov. 23, 2018	Nov. 22, 2019
HORN Antenna SCHWARZBECK	BBHA 9170	148	Nov. 25, 2018	Nov. 24, 2019
Double Ridge Guide Horn Antenna EMCO	3115	5619	Nov. 25, 2018	Nov. 24, 2019
Fixed Attenuator WOKEN	MDCS18N-10	MDCS18N-10-01	Apr. 15, 2019	Apr. 14, 2020
MXG Vector signal generator Agilent	N5182B	MY53050430	Nov. 19, 2018	Nov. 18, 2019
Preamplifier EMCI	EMC 012645	980115	Oct. 12, 2018	Oct. 11, 2019
Preamplifier EMCI	EMC 330H	980112	Oct. 12, 2018	Oct. 11, 2019
RF Coaxial Cable HUBER+SUHNNER	EMC104-SM-SM-800 0&3000	140811+170717	Oct. 12, 2018	Oct. 11, 2019
RF Coaxial Cable HUBER+SUHNNER	SUCOFLEX 104	EMC104-SM-SM-1 000(140807)	Oct. 12, 2018	Oct. 11, 2019
RF Coaxial Cable WOKEN	8D-FB	Cable-Ch10-01	Oct. 12, 2018	Oct. 11, 2019
Boresight Antenna Fixture	FBA-01	FBA-SIP01	NA	NA
Software BV ADT	E3 6.120103	NA	NA	NA
Antenna Tower MF	MFA-440H	NA	NA	NA
Turn Table MF	MFT-201SS	NA	NA	NA
Antenna Tower & Turn Table Controller MF	MF-7802	NA	NA	NA
Radio Communication Analyzer Anritsu	MT8821C	6201462755	Jan. 16, 2019	Jan. 15, 2020
Radio Communication Analyzer Anritsu	MT8820C	6201300640	Aug. 16, 2017	Aug. 15, 2019
			Aug. 19, 2019	Aug. 18, 2020
Temperature & Humidity Chamber	GTH-120-40-CP-AR	MAA1306-019	Sep. 05, 2018	Sep. 04, 2019
			Sep. 06, 2019	Sep. 05, 2020
DC Power Supply Keysight	U8002A	MY56330015	NA	NA

- Note:
1. The calibration interval of the above test instruments is 12 / 24 months and the calibrations are traceable to NML/ROC and NIST/USA.
  2. The test was performed in HwaYa Chamber 10.

### 3 General Information

#### 3.1 General Description of EUT

<b>Product</b>	Rugged Smart Phone	
<b>Brand</b>	CAT	
<b>Test Model</b>	S52	
<b>Status of EUT</b>	Identical Prototype	
<b>Power Supply Rating</b>	5-8 Vdc / 8.5-10 Vdc / 10-12 Vdc (adapter 1) 5.0 Vdc / 9.0 Vdc / 12.0 Vdc (adapter 2) 3.8 Vdc (Li-ion battery)	
<b>Modulation Type</b>	QPSK, 16QAM, 64QAM	
<b>Frequency Range</b>	LTE Band 7 (Channel Bandwidth: 5 MHz)	2502.5 ~ 2567.5 MHz
	LTE Band 7 (Channel Bandwidth: 10 MHz)	2505 ~ 2565 MHz
	LTE Band 7 (Channel Bandwidth: 15 MHz)	2507.5 ~ 2562.5 MHz
	LTE Band 7 (Channel Bandwidth: 20 MHz)	2510 ~ 2560 MHz
	LTE Band 38 (Channel Bandwidth: 5 MHz)	2572.5 ~ 2617.5 MHz
	LTE Band 38 (Channel Bandwidth: 10 MHz)	2575.0 ~ 2615.0 MHz
	LTE Band 38 (Channel Bandwidth: 15 MHz)	2577.5 ~ 2612.5 MHz
	LTE Band 38 (Channel Bandwidth: 20 MHz)	2580.0 ~ 2610.0 MHz
<b>Max. EIRP Power</b>	LTE Band 7 (Channel Bandwidth: 5 MHz)	24.77 mW
	LTE Band 7 (Channel Bandwidth: 10 MHz)	26.12 mW
	LTE Band 7 (Channel Bandwidth: 15 MHz)	27.73 mW
	LTE Band 7 (Channel Bandwidth: 20 MHz)	29.31 mW
	LTE Band 7 (Channel Bandwidth: 20+20 MHz)	28.16 mW
	LTE Band 38 (Channel Bandwidth: 5 MHz)	24.60 mW
	LTE Band 38 (Channel Bandwidth: 10 MHz)	26.36 mW
	LTE Band 38 (Channel Bandwidth: 15 MHz)	27.86 mW
	LTE Band 38 (Channel Bandwidth: 20 MHz)	29.85 mW
	LTE Band 38 (Channel Bandwidth: 20+20 MHz)	28.58 mW
<b>Emission Designator</b>	LTE Band 7 (Channel Bandwidth: 5 MHz)	4M50D7W
	LTE Band 7 (Channel Bandwidth: 10 MHz)	8M98D7W
	LTE Band 7 (Channel Bandwidth: 15 MHz)	13M5G7D
	LTE Band 7 (Channel Bandwidth: 20 MHz)	18M0D7W
	LTE Band 7 (Channel Bandwidth: 20+20 MHz)	37M6G7D
	LTE Band 38 (Channel Bandwidth: 5 MHz)	4M50D7W
	LTE Band 38 (Channel Bandwidth: 10 MHz)	8M97D7W
	LTE Band 38 (Channel Bandwidth: 15 MHz)	13M5G7D
	LTE Band 38 (Channel Bandwidth: 20 MHz)	17M9D7W
	LTE Band 38 (Channel Bandwidth: 20+20 MHz)	37M6G7D
<b>Antenna Type</b>	PIFA Antenna with -8.5 dBi gain	
<b>Accessory Device</b>	Refer to Note as below	
<b>Data Cable Supplied</b>	Refer to Note as below	



Note:

1. The EUT details of the sample are as follows.

Sample	Description
DS	Dual SIM
SS	Single SIM
* The samples have the same layout, circuit, and components, but different SIM tray.	

After pre-tested with the EUT, only the worst sample (Dual SIM) was chosen for the final test.

2. The EUT contains following accessory devices.

Product	Manufacture	Model	Description
Adapter 1	Lucent Trans Electronics Co., LTD.	1M52	I/P: 100-240 Vac, 50-60 Hz, 500 mA O/P: 5Vdc-8Vdc, 2.0A / 8.5Vdc-10Vdc, 1.7A / 10Vdc-12Vdc, 1.5A
Adapter 2	Jiangsu Chenyang Electron Co., LTD.	CK18W02U	I/P: 100-240 Vac, 50-60 Hz, 500 mA O/P: 5 Vdc, 3.0A / 9Vdc, 2.0A / 12Vdc, 1.5A
Battery	Apack Technology Co., LTD.	APP00307	3.8 Vdc, 3000 mAh
Earphone	Ganet Global LTD.	HF-AC04D-03 HF	1.2m non-shielded cable with core
USB Cable	Saibao (Jiangxi) Communication Industrial Co., LTD.	SRB-A001A	1.2m shielded cable with core

3. The above EUT information is declared by manufacturer and for more detailed features description, please refers to the manufacturer's specifications or user's manual.

### 3.2 Configuration of System under Test

#### <Radiated Emission Test>

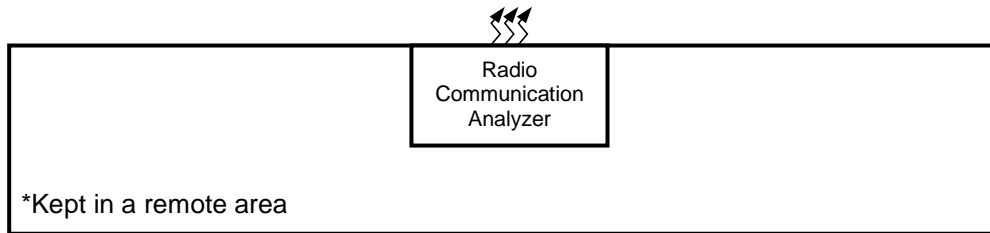
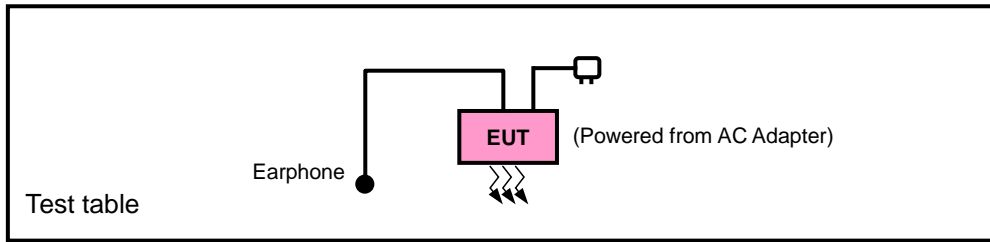

#### <E.I.R.P. Test>

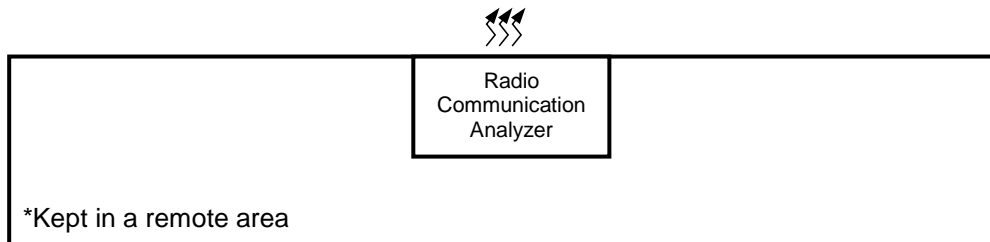
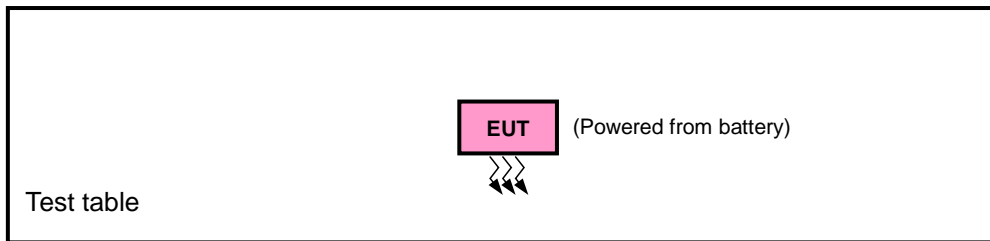

#### 3.2.1 Description of Support Units

The EUT has been tested as an independent unit together with other necessary accessories or support units.

### 3.3 Test Mode Applicability and Tested Channel Detail

Pre-Scan has been conducted to determine the worst-case mode from all possible combinations between available modulations, data rates, XYZ axis, and antenna ports.

The worst case was found when positioned as the table below. Following channel(s) was (were) selected for the final test as listed below:

Band	EIRP	Radiated Emission
LTE Band 7	Y-plane	X-plane
LTE Band 7 CA	Y-plane	X-plane
LTE Band 38	Y-plane	X-plane
LTE Band 38 CA	Y-plane	X-plane

#### LTE Band 7

EUT Configure Mode	Test Item	Available Channel	Tested Channel	Channel Bandwidth	Modulation	Mode
-	EIRP	20775 to 21425	20775, 21100, 21425	5 MHz	QPSK, 16QAM, 64QAM	1 RB / 12 RB Offset
		20800 to 21400	20800, 21100, 21400	10 MHz	QPSK, 16QAM, 64QAM	1 RB / 24 RB Offset
		20825 to 21375	20825, 21100, 21375	15 MHz	QPSK, 16QAM, 64QAM	1 RB / 37 RB Offset
		20850 to 21350	20850, 21100, 21350	20 MHz	QPSK, 16QAM, 64QAM	1 RB / 50 RB Offset
-	Modulation Characteristics	20850 to 21350	21110	20 MHz	QPSK, 16QAM, 64QAM	100 RB / 0 RB Offset
-	Frequency Stability	20775 to 21425	20775, 21425	5 MHz	QPSK	1 RB / 0 RB Offset
		20800 to 21400	20800, 21400	10 MHz	QPSK	1 RB / 0 RB Offset
		20825 to 21375	20825, 21375	15 MHz	QPSK	1 RB / 0 RB Offset
		20850 to 21350	20850, 21350	20 MHz	QPSK	1 RB / 0 RB Offset
-	Occupied Bandwidth	20775 to 21425	20775, 21100, 21425	5 MHz	QPSK, 16QAM, 64QAM	25 RB / 0 RB Offset
		20800 to 21400	20800, 21100, 21400	10 MHz	QPSK, 16QAM, 64QAM	50 RB / 0 RB Offset
		20825 to 21375	20825, 21100, 21375	15 MHz	QPSK, 16QAM, 64QAM	75 RB / 0 RB Offset
		20850 to 21350	20850, 21100, 21350	20 MHz	QPSK, 16QAM, 64QAM	100 RB / 0 RB Offset
-	Peak to Average Ratio	20775 to 21425	20775, 21100, 21425	5 MHz	QPSK, 16QAM, 64QAM	1 RB / 12 RB Offset
		20800 to 21400	20800, 21100, 21400	10 MHz	QPSK, 16QAM, 64QAM	1 RB / 24 RB Offset
		20825 to 21375	20825, 21100, 21375	15 MHz	QPSK, 16QAM, 64QAM	1 RB / 37 RB Offset
		20850 to 21350	20850, 21100, 21350	20 MHz	QPSK, 16QAM, 64QAM	1 RB / 50 RB Offset
-	Out-of-Band Emissions	20775 to 21425	20775, 21425	5 MHz	QPSK, 16QAM, 64QAM	25 RB / 0 RB Offset
		20800 to 21400	20800, 21400	10 MHz	QPSK, 16QAM, 64QAM	50 RB / 0 RB Offset
		20825 to 21375	20825, 21375	15 MHz	QPSK, 16QAM, 64QAM	75 RB / 0 RB Offset
		20850 to 21350	20850, 21350	20 MHz	QPSK, 16QAM, 64QAM	100 RB / 0 RB Offset

EUT Configure Mode	Test Item	Available Channel	Tested Channel	Channel Bandwidth	Modulation	Mode
-	Conducted Emission	20775 to 21425	20775, 21100, 21425	5 MHz	QPSK	1 RB / 12 RB Offset
		20800 to 21400	20800, 21100, 21400	10 MHz	QPSK	1 RB / 24 RB Offset
		20825 to 21375	20825, 21100, 21375	15 MHz	QPSK	1 RB / 37 RB Offset
		20850 to 21350	20850, 21100, 21350	20 MHz	QPSK	1 RB / 50 RB Offset
-	Radiated Emission	20775 to 21425	20775, 21100, 21425	5 MHz	QPSK	1 RB / 12 RB Offset
		20850 to 21350	20850, 21100, 21350	20 MHz	QPSK	1 RB / 50 RB Offset

**Note:**

1. This device was tested under all bandwidths, RB configurations and modulations. The worst case was found in QPSK modulation.
2. For radiated emission above 1 GHz, according to 3GPP 36.521 Section 6.6.3.1.4, choose the lowest, 5 MHz & highest channel bandwidth for final test.

**LTE Band 7 CA Mode**

EUT Configure Mode	Test Item	Available Channel	Tested Channel	Channel Bandwidth	Modulation	Mode
-	EIRP	20850 to 21048	20850+21048	20+20 MHz	QPSK	1 RB / 0 RB Offset 1 RB / 99 RB Offset
		21001 to 21199	21001+21199	20+20 MHz	QPSK	1 RB / 0 RB Offset 1 RB / 99 RB Offset
		21152 to 21350	21152+21350	20+20 MHz	QPSK	1 RB / 0 RB Offset 1 RB / 99 RB Offset
-	Modulation Characteristics	20850 to 21350	21001+21199	20+20 MHz	QPSK, 16QAM, 64QAM	100 RB / 0 RB Offset
-	Frequency Stability	20850 to 21048	20850+21048	20+20 MHz	QPSK	100 RB / 0 RB Offset
		21001 to 21199	21001+21199	20+20 MHz	QPSK	100 RB / 0 RB Offset
		21152 to 21350	21152+21350	20+20 MHz	QPSK	100 RB / 0 RB Offset
-	Occupied Bandwidth	20850 to 21048	20850+21048	20+20 MHz	QPSK	100 RB / 0 RB Offset
		21001 to 21199	21001+21199	20+20 MHz	QPSK	100 RB / 0 RB Offset
		21152 to 21350	21152+21350	20+20 MHz	QPSK	100 RB / 0 RB Offset
-	Peak to Average Ratio	20850 to 21048	20850+21048	20+20 MHz	QPSK	1 RB / 0 RB Offset 1 RB / 99 RB Offset
		21001 to 21199	21001+21199	20+20 MHz	QPSK	1 RB / 0 RB Offset 1 RB / 99 RB Offset
		21152 to 21350	21152+21350	20+20 MHz	QPSK	1 RB / 0 RB Offset 1 RB / 99 RB Offset
-	Out-of-Band Emissions	20850 to 21048	20850+21048	20+20 MHz	QPSK	1 RB / 0 RB Offset 1 RB / 99 RB Offset; 100 RB / 0 RB Offset
		21152 to 21350	21152+21350	20+20 MHz	QPSK	1 RB / 0 RB Offset 1 RB / 99 RB Offset; 100 RB / 0 RB Offset
-	Conducted Emission	20850 to 21048	20850+21048	20+20 MHz	QPSK	1 RB / 0 RB Offset 1 RB / 99 RB Offset
		21001 to 21199	21001+21199	20+20 MHz	QPSK	1 RB / 0 RB Offset 1 RB / 99 RB Offset
		21152 to 21350	21152+21350	20+20 MHz	QPSK	1 RB / 0 RB Offset 1 RB / 99 RB Offset

EUT Configure Mode	Test Item	Available Channel	Tested Channel	Channel Bandwidth	Modulation	Mode
-	Radiated Emission	20850 to 21048	20850+21048	20+20 MHz	QPSK	1 RB / 0 RB Offset 1 RB / 99 RB Offset
		21001 to 21199	21001+21199	20+20 MHz	QPSK	1 RB / 0 RB Offset 1 RB / 99 RB Offset
		21152 to 21350	21152+21350	20+20 MHz	QPSK	1 RB / 0 RB Offset 1 RB / 99 RB Offset

**Note:**

1. This device was tested under all bandwidths, RB configurations and modulations. The worst case was found in QPSK modulation.
2. Follow 3GPP after per-test all the mode and found 20+20 MHz was the bandwidths and power. Therefore only 20+20MHz was for the final test and presented in the test report
3. The configurations as below:  
7C: 10MHz +20MHz · 15MHz+10MHz · 15MHz+15MHz · 20MHz+10MHz · 20MHz+15MHz · 20MHz+20MHz

**LTE Band 38**

EUT Configure Mode	Test Item	Available Channel	Tested Channel	Channel Bandwidth	Modulation	Mode
-	EIRP	37775 to 38225	37775, 38000, 38225	5 MHz	QPSK, 16QAM, 64QAM	1 RB / 12 RB Offset
		37800 to 38200	37800, 38000, 38200	10 MHz	QPSK, 16QAM, 64QAM	1 RB / 24 RB Offset
		37825 to 38175	37825, 38000, 38175	15 MHz	QPSK, 16QAM, 64QAM	1 RB / 37 RB Offset
		37850 to 38150	37850, 38000, 38150	20 MHz	QPSK, 16QAM, 64QAM	1 RB / 50 RB Offset
-	Modulation Characteristics	37850 to 38150	38000	20 MHz	QPSK, 16QAM, 64QAM	100 RB / 0 RB Offset
-	Frequency Stability	37775 to 38225	37775, 38225	5 MHz	QPSK	1 RB / 0 RB Offset
		37800 to 38200	37800, 38200	10 MHz	QPSK	1 RB / 0 RB Offset
		37825 to 38175	37825, 38175	15 MHz	QPSK	1 RB / 0 RB Offset
		37850 to 38150	37850, 38150	20 MHz	QPSK	1 RB / 0 RB Offset
-	Occupied Bandwidth	37775 to 38225	37775, 38000, 38225	5 MHz	QPSK, 16QAM, 64QAM	25 RB / 0 RB Offset
		37800 to 38200	37800, 38000, 38200	10 MHz	QPSK, 16QAM, 64QAM	50 RB / 0 RB Offset
		37825 to 38175	37825, 38000, 38175	15 MHz	QPSK, 16QAM, 64QAM	75 RB / 0 RB Offset
		37850 to 38150	37850, 38000, 38150	20 MHz	QPSK, 16QAM, 64QAM	100 RB / 0 RB Offset
-	Peak to Average Ratio	37775 to 38225	37775, 38000, 38225	5 MHz	QPSK, 16QAM, 64QAM	1 RB / 12 RB Offset
		37800 to 38200	37800, 38000, 38200	10 MHz	QPSK, 16QAM, 64QAM	1 RB / 24 RB Offset
		37825 to 38175	37825, 38000, 38175	15 MHz	QPSK, 16QAM, 64QAM	1 RB / 37 RB Offset
		37850 to 38150	37850, 38000, 38150	20 MHz	QPSK, 16QAM, 64QAM	1 RB / 50 RB Offset
-	Out-of-Band Emissions	37775 to 38225	37775, 38225	5 MHz	QPSK, 16QAM, 64QAM	25 RB / 0 RB Offset
		37800 to 38200	37800, 38200	10 MHz	QPSK, 16QAM, 64QAM	50 RB / 0 RB Offset
		37825 to 38175	37825, 38175	15 MHz	QPSK, 16QAM, 64QAM	75 RB / 0 RB Offset
		37850 to 38150	37850, 38150	20 MHz	QPSK, 16QAM, 64QAM	100 RB / 0 RB Offset

EUT Configure Mode	Test Item	Available Channel	Tested Channel	Channel Bandwidth	Modulation	Mode
-	Conducted Emission	37775 to 38225	37775, 38000, 38225	5 MHz	QPSK	1 RB / 12 RB Offset
		37800 to 38200	37800, 38000, 38200	10 MHz	QPSK	1 RB / 24 RB Offset
		37825 to 38175	37825, 38000, 38175	15 MHz	QPSK	1 RB / 37 RB Offset
		37850 to 38150	37850, 38000, 38150	20 MHz	QPSK	1 RB / 50 RB Offset
-	Radiated Emission	37775 to 38225	37775, 38000, 38225	5 MHz	QPSK	1 RB / 12 RB Offset
		37850 to 38150	37850, 38000, 38150	20 MHz	QPSK	1 RB / 50 RB Offset

**Note:**

1. This device was tested under all bandwidths, RB configurations and modulations. The worst case was found in QPSK modulation.
2. For radiated emission above 1 GHz, according to 3GPP 36.521 Section 6.6.3.1.4, choose the lowest, 5 MHz & highest channel bandwidth for final test.

**LTE Band 38 CA Mode**

EUT Configure Mode	Test Item	Available Channel	Tested Channel	Channel Bandwidth	Modulation	Mode
-	EIRP	37850 to 38048	37850+38048	20+20 MHz	QPSK	1 RB / 0 RB Offset 1 RB / 99 RB Offset
		37901 to 38099	37901+38099	20+20 MHz	QPSK	1 RB / 0 RB Offset 1 RB / 99 RB Offset
		37952 to 38150	37952+38150	20+20 MHz	QPSK	1 RB / 0 RB Offset 1 RB / 99 RB Offset
-	Modulation Characteristics	37901 to 38099	37901+38099	20+20 MHz	QPSK, 16QAM, 64QAM	100 RB / 0 RB Offset
-	Frequency Stability	37850 to 38048	37850+38048	20+20 MHz	QPSK	100 RB / 0 RB Offset
		37901 to 38099	37901+38099	20+20 MHz	QPSK	100 RB / 0 RB Offset
		37952 to 38150	37952+38150	20+20 MHz	QPSK	100 RB / 0 RB Offset
-	Occupied Bandwidth	37850 to 38048	37850+38048	20+20 MHz	QPSK	100 RB / 0 RB Offset
		37901 to 38099	37901+38099	20+20 MHz	QPSK	100 RB / 0 RB Offset
		37952 to 38150	37952+38150	20+20 MHz	QPSK	100 RB / 0 RB Offset
-	Peak to Average Ratio	37850 to 38048	37850+38048	20+20 MHz	QPSK	1 RB / 0 RB Offset 1 RB / 99 RB Offset
		37901 to 38099	37901+38099	20+20 MHz	QPSK	1 RB / 0 RB Offset 1 RB / 99 RB Offset
		37952 to 38150	37952+38150	20+20 MHz	QPSK	1 RB / 0 RB Offset 1 RB / 99 RB Offset
-	Out-of-Band Emissions	37850 to 38048	37850+38048	20+20 MHz	QPSK	1 RB / 0 RB Offset 1 RB / 99 RB Offset; 100 RB / 0 RB Offset
		37952 to 38150	37952+38150	20+20 MHz	QPSK	1 RB / 0 RB Offset 1 RB / 99 RB Offset; 100 RB / 0 RB Offset
-	Conducted Emission	37850 to 38048	37850+38048	20+20 MHz	QPSK	1 RB / 0 RB Offset 1 RB / 99 RB Offset
		37901 to 38099	37901+38099	20+20 MHz	QPSK	1 RB / 0 RB Offset 1 RB / 99 RB Offset
		37952 to 38150	37952+38150	20+20 MHz	QPSK	1 RB / 0 RB Offset 1 RB / 99 RB Offset
-	Radiated Emission	37850 to 38048	37850+38048	20+20 MHz	QPSK	1 RB / 0 RB Offset 1 RB / 99 RB Offset
		37901 to 38099	37901+38099	20+20 MHz	QPSK	1 RB / 0 RB Offset 1 RB / 99 RB Offset
		37952 to 38150	37952+38150	20+20 MHz	QPSK	1 RB / 0 RB Offset 1 RB / 99 RB Offset

**Note:**

1. This device was tested under all bandwidths, RB configurations and modulations. The worst case was found in QPSK modulation.
2. Follow 3GPP after per-test all the mode and found 20+20 MHz was the bandwidths and power. Therefore only 20+20MHz was for the final test and presented in the test report
3. The configurations as below:  
38C: 15MHz+15MHz · 20MHz+20MHz

**Test Condition:**

Test Item	Environmental Conditions	Input Power	Tested By
EIRP	25 deg. C, 65 % RH	3.8 Vdc	Thomas Wei
Modulation Characteristics	25 deg. C, 65 % RH	3.8 Vdc	Wayne Lin
Frequency Stability	25 deg. C, 65 % RH	3.8 Vdc	Wayne Lin
Occupied Bandwidth	25 deg. C, 65 % RH	3.8 Vdc	Wayne Lin
Out-of-Band Emissions	25 deg. C, 65 % RH	3.8 Vdc	Wayne Lin
Peak to Average Ratio	25 deg. C, 65 % RH	3.8 Vdc	Wayne Lin
Conducted Emission	25 deg. C, 65 % RH	3.8 Vdc	Wayne Lin
Radiated Emission	25 deg. C, 65 % RH	120 Vac, 60 Hz	Thomas Wei

**3.4 EUT Operating Conditions**

The EUT makes a call to the communication simulator. The communication simulator station system controlled a EUT to export maximum output power under transmission mode and specific channel frequency

**3.5 General Description of Applied Standards**

The EUT is a RF Product. According to the specifications of the manufacturer, it must comply with the requirements of the following standards:

**FCC 47 CFR Part 2**

**FCC 47 CFR Part 27**

**KDB 971168 D01 Power Meas License Digital Systems v03r01**

**ANSI/TIA/EIA-603-E 2016**

**ANSI 63.26-2015**

**Note:** All test items have been performed and recorded as per the above standards.

## 4 Test Types and Results

### 4.1 Output Power Measurement

#### 4.1.1 Limits of Output Power Measurement

The radiated peak output power shall be according to the specific rule Part 27.50(h)(2) that “Mobile stations are limited to 2.0 watts EIRP. All user stations are limited to 2 watts transmitter output power” and 27.50(i) specific that “Peak transmit power must be measure over any interval of continuous transmission using instrumentation calibration in terms of rms-equivalent voltage.”

#### 4.1.2 Test Procedures

##### **EIRP Measurement:**

- a. All measurements were done at low, middle and high operational frequency range. RBW and VBW is 10 MHz for LTE mode.
- b. Substitution method is used for E.I.R.P measurement. In the semi-anechoic chamber, EUT placed on the 0.8 m (below or equal 1 GHz) and/or 1.5 m (above 1 GHz) height of Turn Table, rotated the table around 360 degrees to search the maximum radiation power and receiver antenna shall be rotated vertical and horizontal polarization and moved height from 1 m to 4 m to find the maximum polar radiated power. The “Read Value” is the spectrum reading the maximum power value.
- c. The substitution horn antenna is substituted for EUT at the same position and signals generator export the CW signal to the substitution antenna via a tx cable. Rotated the Turn Table and moved receiving antenna to find the maximum radiation power. Adjust output power level of S.G to get a Value of spectrum reading equal to “Read Value“ of step b. Record the power level of S.G.
- d.  $EIRP = \text{Output power level of S.G} - \text{TX cable loss} + \text{Antenna gain of substitution horn}.$

##### **Conducted Power Measurement:**

- a. The EUT was set up for the maximum power with LTE link data modulation and link up with simulator.
- b. Set the EUT to transmit under low, middle and high channel and record the power level shown on simulator.



4.1.3 Test Setup

**EIRP / ERP Measurement:  
<Radiated Emission below or equal 1 GHz>**

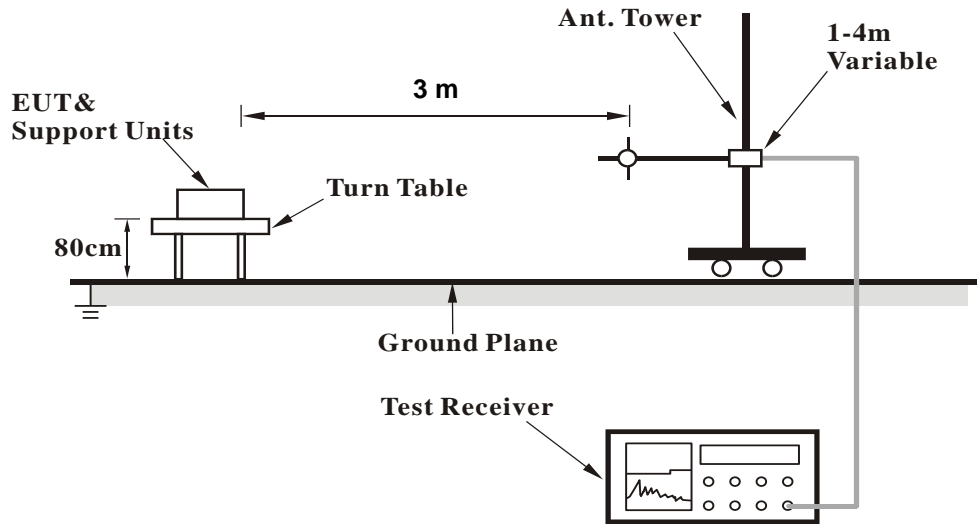

**<Radiated Emission above 1 GHz>**

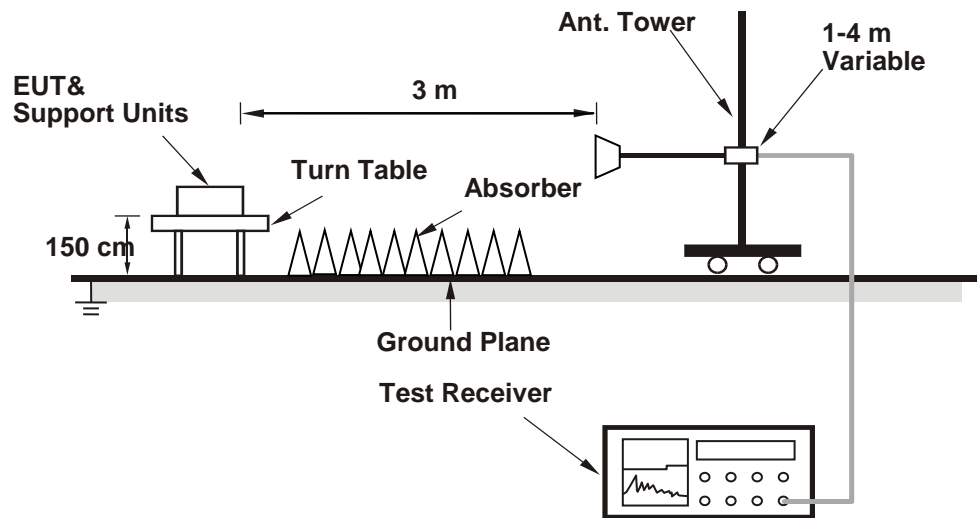

For the actual test configuration, please refer to the attached file (Test Setup Photo).

**Conducted Power Measurement:**

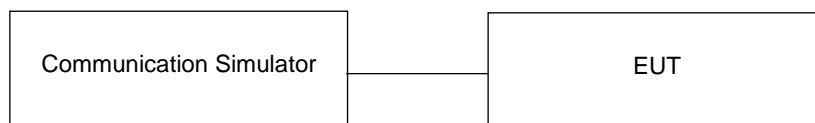

4.1.4 Test Results

Conducted Output Power (dBm)

LTE Band 7															
BW	MCS Index	RB Size	RB Offset	Low	Mid	High	3GPP MPR (dB)	BW	MCS Index	RB Size	RB Offset	Low	Mid	High	3GPP MPR (dB)
				20850	21100	21350						20825	21100	21375	
		Channel Frequency (MHz)	2510.0	2535.0	2560.0	Channel Frequency (MHz)	2507.5			2535.0	2562.5				
20M	QPSK	1	0	23.27	23.31	23.45	0	15M	QPSK	1	0	23.26	23.27	23.44	0
		1	50	23.42	23.46	23.60	0			1	37	23.41	23.36	23.54	0
		1	99	23.23	23.27	23.41	0			1	74	23.19	23.22	23.34	0
		50	0	22.34	22.38	22.52	1			36	0	22.29	22.28	22.47	1
		50	25	22.31	22.35	22.49	1			36	19	22.23	22.34	22.42	1
		50	50	22.25	22.29	22.43	1			36	39	22.15	22.28	22.43	1
	100	0	22.30	22.34	22.48	1	75		0	22.21	22.31	22.45	1		
	16QAM	1	0	22.33	22.37	22.51	1		16QAM	1	0	22.26	22.30	22.49	1
		1	50	22.72	22.76	22.90	1			1	37	22.66	22.76	22.89	1
		1	99	22.69	22.73	22.87	1			1	74	22.67	22.64	22.83	1
		50	0	21.31	21.35	21.49	2			36	0	21.21	21.33	21.47	2
		50	25	21.33	21.37	21.51	2			36	19	21.31	21.27	21.43	2
		50	50	21.26	21.30	21.44	2			36	39	21.18	21.25	21.36	2
	100	0	21.27	21.31	21.45	2	75		0	21.23	21.26	21.45	2		
	64QAM	1	0	21.22	21.26	21.40	2		64QAM	1	0	21.20	21.24	21.34	2
		1	50	21.53	21.57	21.71	2			1	37	21.44	21.49	21.62	2
		1	99	21.42	21.46	21.60	2			1	74	21.32	21.45	21.52	2
		50	0	20.29	20.33	20.47	3			36	0	20.26	20.33	20.37	3
50		25	20.27	20.31	20.45	3	36	19		20.19	20.31	20.38	3		
50		50	20.18	20.22	20.36	3	36	39		20.14	20.13	20.32	3		
100	0	20.30	20.34	20.48	3	75	0	20.26	20.31	20.45	3				
BW	MCS Index	RB Size	RB Offset	Low	Mid	High	3GPP MPR (dB)	BW	MCS Index	RB Size	RB Offset	Low	Mid	High	3GPP MPR (dB)
				20800	21100	21400						20775	21100	21425	
		Channel Frequency (MHz)	2505.0	2535.0	2565.0	Channel Frequency (MHz)	2502.5			2535.0	2567.5				
10M	QPSK	1	0	23.05	23.18	23.41	0	5M	QPSK	1	0	23.13	23.17	23.06	0
		1	24	23.28	23.39	23.57	0			1	12	23.28	23.32	23.41	0
		1	49	23.11	23.12	23.36	0			1	24	23.02	23.06	23.20	0
		25	0	22.17	22.24	22.35	1			12	0	22.25	22.18	22.40	1
		25	12	22.11	22.26	22.33	1			12	6	22.15	22.14	22.20	1
		25	25	22.17	22.19	22.34	1			12	13	22.07	22.05	22.29	1
	50	0	22.24	22.25	22.37	1	25		0	22.19	22.12	22.28	1		
	16QAM	1	0	22.29	22.17	22.38	1		16QAM	1	0	22.14	22.32	22.34	1
		1	24	22.58	22.64	22.77	1			1	12	22.65	22.68	22.80	1
		1	49	22.65	22.66	22.80	1			1	24	22.63	22.70	22.68	1
		25	0	21.12	21.26	21.39	2			12	0	21.18	21.25	21.34	2
		25	12	21.27	21.22	21.46	2			12	6	21.27	21.29	21.44	2
		25	25	21.16	21.16	21.37	2			12	13	21.03	21.16	21.33	2
	50	0	21.10	21.25	21.32	2	25		0	21.16	21.11	21.29	2		
	64QAM	1	0	21.07	21.13	21.26	2		64QAM	1	0	21.10	21.23	21.29	2
		1	24	21.29	21.43	21.46	2			1	12	21.36	21.49	21.56	2
		1	49	21.26	21.28	21.37	2			1	24	21.37	21.40	21.46	2
		25	0	20.27	20.21	20.42	3			12	0	20.10	20.29	20.40	3
25		12	20.19	20.11	20.33	3	12	6		20.15	20.28	20.33	3		
25		25	20.12	20.08	20.31	3	12	13		20.00	20.11	20.24	3		
50	0	20.15	20.24	20.29	3	25	0	20.19	20.25	20.41	3				

LTE Band 38																	
BW	MCS Index	RB Size	RB Offset	Low	Mid	High	3GPP MPR (dB)	BW	MCS Index	RB Size	RB Offset	Low	Mid	High	3GPP MPR (dB)		
		Channel		37850	38000	38150				Channel		37825	38000	38175			
		Frequency (MHz)		2580	2595	2610				Frequency (MHz)		2577.5	2595	2612.5			
20M	QPSK	1	0	23.27	23.32	23.42	0	15M	QPSK	1	0	23.21	23.31	23.39	0		
		1	50	23.51	23.56	23.66	0			1	37	23.47	23.52	23.60	0		
		1	99	23.30	23.35	23.45	0			1	74	23.28	23.25	23.35	0		
		50	0	22.42	22.47	22.57	1			36	0	22.33	22.38	22.48	1		
		50	25	22.46	22.51	22.61	1			36	19	22.43	22.49	22.58	1		
		50	50	22.20	22.25	22.35	1			36	39	22.14	22.19	22.30	1		
	100	0	22.44	22.49	22.59	1	75		0	22.43	22.41	22.51	1				
	16QAM	1	0	22.37	22.42	22.52	1		16QAM	1	0	22.29	22.42	22.45	1		
		1	50	22.59	22.64	22.74	1			1	37	22.59	22.61	22.67	1		
		1	99	22.42	22.47	22.57	1			1	74	22.39	22.44	22.54	1		
		50	0	21.50	21.55	21.65	2			36	0	21.50	21.50	21.56	2		
		50	25	21.62	21.67	21.77	2			36	19	21.54	21.59	21.74	2		
		50	50	21.43	21.48	21.58	2			36	39	21.35	21.44	21.54	2		
	100	0	21.47	21.52	21.62	2	75		0	21.47	21.45	21.57	2				
	64QAM	1	0	21.14	21.19	21.29	2		64QAM	1	0	21.08	21.12	21.24	2		
		1	50	21.32	21.37	21.47	2			1	37	21.24	21.37	21.37	2		
		1	99	21.06	21.11	21.21	2			1	74	21.01	21.10	21.19	2		
		50	0	20.46	20.51	20.61	3			36	0	20.42	20.50	20.60	3		
		50	25	20.51	20.56	20.66	3			36	19	20.47	20.48	20.61	3		
		50	50	20.43	20.48	20.58	3			36	39	20.35	20.41	20.57	3		
	100	0	20.48	20.53	20.63	3	75		0	20.42	20.46	20.55	3				
	10M	QPSK	1	0	23.25	23.30	23.38		0	5M	QPSK	1	0	23.18	23.22	23.22	0
			1	24	23.42	23.56	23.59		0			1	12	23.30	23.40	23.54	0
			1	49	23.30	23.32	23.45		0			1	24	23.16	23.12	23.33	0
25			0	22.33	22.44	22.50	1	12	0			22.33	22.39	22.38	1		
25			12	22.44	22.43	22.58	1	12	6			22.31	22.40	22.43	1		
25			25	22.13	22.17	22.25	1	12	13			22.08	22.11	22.33	1		
50		0	22.39	22.40	22.54	1	25	0	22.26		22.33	22.51	1				
16QAM		1	0	22.28	22.41	22.45	1	16QAM	1		0	22.19	22.32	22.38	1		
		1	24	22.57	22.60	22.72	1		1		12	22.56	22.53	22.57	1		
		1	49	22.39	22.38	22.57	1		1		24	22.32	22.35	22.46	1		
		25	0	21.50	21.46	21.57	2		12		0	21.34	21.44	21.51	2		
		25	12	21.60	21.64	21.74	2		12		6	21.41	21.46	21.63	2		
		25	25	21.37	21.46	21.57	2		12		13	21.19	21.44	21.44	2		
50		0	21.43	21.48	21.58	2	25	0	21.37		21.44	21.51	2				
64QAM		1	0	21.12	21.18	21.21	2	64QAM	1		0	21.08	21.01	21.15	2		
		1	24	21.24	21.36	21.41	2		1		12	21.17	21.25	21.39	2		
		1	49	20.98	21.03	21.19	2		1		24	20.96	21.03	21.13	2		
		25	0	20.41	20.46	20.57	3		12		0	20.44	20.41	20.59	3		
		25	12	20.42	20.56	20.63	3		12		6	20.44	20.44	20.56	3		
		25	25	20.34	20.38	20.52	3		12		13	20.34	20.34	20.39	3		
50		0	20.40	20.51	20.58	3	25	0	20.37		20.36	20.58	3				

**Uplink Carrier Aggregation Scenarios Conducted Power**

Confugure	Combination	PCC								SCC						Measurement Power				
		Band	BW (MHz)	Modulation	RB Size		UL Channel	UL Frequency (MHz)	Band	BW (MHz)	Modulation	RB Size		UL Channel	UL Frequency (MHz)	Maximum Tune-up Power	Single Carrier Tx Power without UL-CA Active (dBm)	Tx Power with UL-CA Active (dBm)		
					RB Size	RB Offset						RB Size	RB Offset					PCC	SCC	Total
Intra Band Contiguous	CA_7C	7	20	QPSK	1	0	20850	2510	7	20	QPSK	1	99	21048	2529.8	24.5	23.27	11.21	11.89	14.57
					1	99						1	0			24.5	23.23	20.13	20.18	23.17
		7	20	QPSK	1	0	21001	2525.1	7	20	QPSK	1	99	21199	2544.9	24.5	23.31	12.41	10.83	14.70
					1	99						1	0			24.5	23.27	20.21	20.23	23.23
		7	20	QPSK	1	0	21152	2540.2	7	20	QPSK	1	99	21350	2560	24.5	23.45	12.53	13.11	15.84
					1	99						1	0			24.5	23.41	20.3	20.31	23.32
	CA_38C	38	20	QPSK	1	0	37850	2580	38	20	QPSK	1	99	38048	2599.8	24.5	23.27	12.43	11.12	14.83
					1	99						1	0			24.5	23.30	20.31	20.25	23.29
		38	20	QPSK	1	0	37901	2585.1	38	20	QPSK	1	99	38099	2604.9	24.5	23.32	12.5	11.15	14.89
					1	99						1	0			24.5	23.35	20.36	20.28	23.33
		38	20	QPSK	1	0	37952	2590.2	38	20	QPSK	1	99	38150	2610	24.5	23.42	12.69	11.04	14.95
					1	99						1	0			24.5	23.45	20.41	20.34	23.39

**EIRP Power (dBm)**

LTE Band 7							
Channel Bandwidth: 5 MHz / QPSK							
Plane	Channel	Frequency (MHz)	Reading (dBm)	Correction Factor (dB)	EIRP (dBm)	EIRP (mW)	Polarization (H/V)
Y	20775	2502.5	-30.07	38.52	8.45	7.00	H
	21100	2535.0	-29.88	38.36	8.48	7.05	
	21425	2567.5	-30.26	38.58	8.32	6.79	
	20775	2502.5	-25.13	38.92	13.79	23.93	V
	21100	2535.0	-25.32	39.26	13.94	24.77	
	21425	2567.5	-25.52	39.22	13.70	23.44	
Channel Bandwidth: 5 MHz / 16QAM							
Y	20775	2502.5	-31.06	38.52	7.46	5.57	H
	21100	2535.0	-30.85	38.36	7.51	5.64	
	21425	2567.5	-31.49	38.58	7.09	5.12	
	20775	2502.5	-26.16	38.92	12.76	18.88	V
	21100	2535.0	-26.30	39.26	12.96	19.77	
	21425	2567.5	-26.58	39.22	12.64	18.37	
Channel Bandwidth: 5 MHz / 64QAM							
Y	20775	2502.5	-32.35	38.52	6.17	4.14	H
	21100	2535.0	-32.01	38.36	6.35	4.32	
	21425	2567.5	-32.47	38.58	6.11	4.08	
	20775	2502.5	-27.25	38.92	11.67	14.69	V
	21100	2535.0	-27.28	39.26	11.98	15.78	
	21425	2567.5	-27.60	39.22	11.62	14.52	

Note: EIRP (dBm) = Reading (dBm) + Correction Factor (dB)

LTE Band 7							
Channel Bandwidth: 10 MHz / QPSK							
Plane	Channel	Frequency (MHz)	Reading (dBm)	Correction Factor (dB)	EIRP (dBm)	EIRP (mW)	Polarization (H/V)
Y	20800	2505.0	-29.99	38.65	8.66	7.35	H
	21100	2535.0	-29.58	38.36	8.78	7.55	
	21400	2565.0	-29.90	38.49	8.59	7.23	
	20800	2505.0	-24.73	38.84	14.11	25.76	V
	21100	2535.0	-25.09	39.26	14.17	26.12	
	21400	2565.0	-25.09	39.10	14.01	25.18	
Channel Bandwidth: 10 MHz / 16QAM							
Y	20800	2505.0	-30.92	38.65	7.73	5.93	H
	21100	2535.0	-30.52	38.36	7.84	6.08	
	21400	2565.0	-31.09	38.49	7.40	5.50	
	20800	2505.0	-25.78	38.84	13.06	20.23	V
	21100	2535.0	-26.02	39.26	13.24	21.09	
	21400	2565.0	-26.19	39.10	12.91	19.54	
Channel Bandwidth: 10 MHz / 64QAM							
Y	20800	2505.0	-32.20	38.65	6.45	4.42	H
	21100	2535.0	-31.75	38.36	6.61	4.58	
	21400	2565.0	-32.18	38.49	6.31	4.28	
	20800	2505.0	-26.85	38.84	11.99	15.81	V
	21100	2535.0	-27.06	39.26	12.20	16.60	
	21400	2565.0	-27.26	39.10	11.84	15.28	

Note: EIRP (dBm) = Reading (dBm) + Correction Factor (dB)

LTE Band 7							
Channel Bandwidth: 15 MHz / QPSK							
Plane	Channel	Frequency (MHz)	Reading (dBm)	Correction Factor (dB)	EIRP (dBm)	EIRP (mW)	Polarization (H/V)
Y	20825	2507.5	-29.53	38.52	8.99	7.93	H
	21100	2535.0	-29.31	38.36	9.05	8.04	
	21375	2562.5	-29.78	38.58	8.80	7.59	
	20825	2507.5	-24.60	38.92	14.32	27.04	V
	21100	2535.0	-24.83	39.26	14.43	27.73	
	21375	2562.5	-24.96	39.22	14.26	26.67	
Channel Bandwidth: 15 MHz / 16QAM							
Y	20825	2507.5	-30.58	38.52	7.94	6.22	H
	21100	2535.0	-30.32	38.36	8.04	6.37	
	21375	2562.5	-30.96	38.58	7.62	5.78	
	20825	2507.5	-25.63	38.92	13.29	21.33	V
	21100	2535.0	-25.72	39.26	13.54	22.59	
	21375	2562.5	-26.07	39.22	13.15	20.65	
Channel Bandwidth: 15 MHz / 64QAM							
Y	20825	2507.5	-31.81	38.52	6.71	4.69	H
	21100	2535.0	-31.53	38.36	6.83	4.82	
	21375	2562.5	-31.99	38.58	6.59	4.56	
	20825	2507.5	-26.61	38.92	12.31	17.02	V
	21100	2535.0	-26.82	39.26	12.44	17.54	
	21375	2562.5	-27.12	39.22	12.10	16.22	

Note: EIRP (dBm) = Reading (dBm) + Correction Factor (dB)

LTE Band 7							
Channel Bandwidth: 20 MHz / QPSK							
Plane	Channel	Frequency (MHz)	Reading (dBm)	Correction Factor (dB)	EIRP (dBm)	EIRP (mW)	Polarization (H/V)
Y	20850	2510.0	-29.29	38.52	9.23	8.38	H
	21100	2535.0	-29.06	38.36	9.30	8.51	
	21350	2560.0	-29.44	38.58	9.14	8.20	
	20850	2510.0	-24.31	38.92	14.61	28.91	V
	21100	2535.0	-24.59	39.26	14.67	29.31	
	21350	2560.0	-24.69	39.22	14.53	28.38	
Channel Bandwidth: 20 MHz / 16QAM							
Y	20850	2510.0	-30.37	38.52	8.15	6.53	H
	21100	2535.0	-30.06	38.36	8.30	6.76	
	21350	2560.0	-30.69	38.58	7.89	6.15	
	20850	2510.0	-25.33	38.92	13.59	22.86	V
	21100	2535.0	-25.52	39.26	13.74	23.66	
	21350	2560.0	-25.77	39.22	13.45	22.13	
Channel Bandwidth: 20 MHz / 64QAM							
Y	20850	2510.0	-31.50	38.52	7.02	5.04	H
	21100	2535.0	-31.21	38.36	7.15	5.19	
	21350	2560.0	-31.77	38.58	6.81	4.80	
	20850	2510.0	-26.35	38.92	12.57	18.07	V
	21100	2535.0	-26.62	39.26	12.64	18.37	
	21350	2560.0	-26.87	39.22	12.35	17.18	

Note: EIRP (dBm) = Reading (dBm) + Correction Factor (dB)

#### CA Mode

LTE Band 7							
Channel Bandwidth: 20+20 MHz / QPSK							
Plane	Channel	Frequency (MHz)	Reading (dBm)	Correction Factor (dB)	EIRP (dBm)	EIRP (mW)	Polarization (H/V)
Y	20850+21048	2510+2529.8	-35.57	43.66	8.09	6.45	H
	21001+21199	2525.1+2544.9	-35.18	43.66	8.48	7.05	
	21152+21350	2540.2+2560	-35.00	43.66	8.66	7.35	
	20850+21048	2510+2529.8	-29.88	44.30	14.42	27.65	V
	21001+21199	2525.1+2544.9	-30.06	44.30	14.24	26.53	
	21152+21350	2540.2+2560	-29.80	44.30	14.50	28.16	

Note: EIRP (dBm) = Reading (dBm) + Correction Factor (dB)



LTE Band 38							
Channel Bandwidth: 5 MHz / QPSK							
Plane	Channel	Frequency (MHz)	Reading (dBm)	Correction Factor (dB)	EIRP (dBm)	EIRP (mW)	Polarization (H/V)
Y	37775	2572.5	-30.28	38.99	8.71	7.43	H
	38000	2595.0	-29.42	38.17	8.75	7.50	
	38225	2617.5	-29.53	38.55	9.02	7.98	
	37775	2572.5	-25.49	39.27	13.78	23.88	V
	38000	2595.0	-24.84	38.68	13.84	24.21	
	38225	2617.5	-24.64	38.55	13.91	24.60	
Channel Bandwidth: 5 MHz / 16QAM							
Y	37775	2572.5	-31.24	38.99	7.75	5.96	H
	38000	2595.0	-30.33	38.17	7.84	6.08	
	38225	2617.5	-30.51	38.55	8.04	6.37	
	37775	2572.5	-26.64	39.27	12.63	18.32	V
	38000	2595.0	-25.83	38.68	12.85	19.28	
	38225	2617.5	-25.56	38.55	12.99	19.91	
Channel Bandwidth: 5 MHz / 64QAM							
Y	37775	2572.5	-32.51	38.99	6.48	4.45	H
	38000	2595.0	-31.45	38.17	6.72	4.70	
	38225	2617.5	-31.75	38.55	6.80	4.79	
	37775	2572.5	-27.56	39.27	11.71	14.83	V
	38000	2595.0	-26.82	38.68	11.86	15.35	
	38225	2617.5	-26.63	38.55	11.92	15.56	

Note: EIRP (dBm) = Reading (dBm) + Correction Factor (dB)

LTE Band 38							
Channel Bandwidth: 10 MHz / QPSK							
Plane	Channel	Frequency (MHz)	Reading (dBm)	Correction Factor (dB)	EIRP (dBm)	EIRP (mW)	Polarization (H/V)
Y	37800	2575.0	-30.03	38.98	8.95	7.85	H
	38000	2595.0	-29.11	38.17	9.06	8.05	
	38200	2615.0	-29.20	38.45	9.25	8.41	
	37800	2575.0	-25.01	39.04	14.03	25.29	V
	38000	2595.0	-24.57	38.68	14.11	25.76	
	38200	2615.0	-24.39	38.60	14.21	26.36	
Channel Bandwidth: 10 MHz / 16QAM							
Y	37800	2575.0	-31.00	38.98	7.98	6.28	H
	38000	2595.0	-30.05	38.17	8.12	6.49	
	38200	2615.0	-30.12	38.45	8.33	6.81	
	37800	2575.0	-26.08	39.04	12.96	19.77	V
	38000	2595.0	-25.52	38.68	13.16	20.70	
	38200	2615.0	-25.37	38.60	13.23	21.04	
Channel Bandwidth: 10 MHz / 64QAM							
Y	37800	2575.0	-32.24	38.98	6.74	4.72	H
	38000	2595.0	-31.17	38.17	7.00	5.01	
	38200	2615.0	-31.40	38.45	7.05	5.07	
	37800	2575.0	-27.11	39.04	11.93	15.60	V
	38000	2595.0	-26.54	38.68	12.14	16.37	
	38200	2615.0	-26.40	38.60	12.20	16.60	

Note: EIRP (dBm) = Reading (dBm) + Correction Factor (dB)

LTE Band 38							
Channel Bandwidth: 15 MHz / QPSK							
Plane	Channel	Frequency (MHz)	Reading (dBm)	Correction Factor (dB)	EIRP (dBm)	EIRP (mW)	Polarization (H/V)
Y	37825	2577.5	-29.82	39.09	9.27	8.45	H
	38000	2595.0	-28.78	38.17	9.39	8.69	
	38175	2612.5	-28.96	38.52	9.56	9.04	
	37825	2577.5	-24.72	39.04	14.32	27.04	V
	38000	2595.0	-24.27	38.68	14.41	27.61	
	38175	2612.5	-24.21	38.66	14.45	27.86	
Channel Bandwidth: 15 MHz / 16QAM							
Y	37825	2577.5	-30.86	39.09	8.23	6.65	H
	38000	2595.0	-29.77	38.17	8.40	6.92	
	38175	2612.5	-29.94	38.52	8.58	7.21	
	37825	2577.5	-25.77	39.04	13.27	21.23	V
	38000	2595.0	-25.32	38.68	13.36	21.68	
	38175	2612.5	-25.16	38.66	13.50	22.39	
Channel Bandwidth: 15 MHz / 64QAM							
Y	37825	2577.5	-32.04	39.09	7.05	5.07	H
	38000	2595.0	-30.95	38.17	7.22	5.27	
	38175	2612.5	-31.15	38.52	7.37	5.46	
	37825	2577.5	-26.86	39.04	12.18	16.52	V
	38000	2595.0	-26.33	38.68	12.35	17.18	
	38175	2612.5	-26.17	38.66	12.49	17.74	

Note: EIRP (dBm) = Reading (dBm) + Correction Factor (dB)

LTE Band 38							
Channel Bandwidth: 20 MHz / QPSK							
Plane	Channel	Frequency (MHz)	Reading (dBm)	Correction Factor (dB)	EIRP (dBm)	EIRP (mW)	Polarization (H/V)
Y	37850	2580.0	-29.64	39.26	9.62	9.16	H
	38000	2595.0	-28.47	38.17	9.70	9.33	
	38150	2610.0	-28.94	38.71	9.77	9.48	
	37850	2580.0	-24.72	39.33	14.61	28.91	V
	38000	2595.0	-24.00	38.68	14.68	29.38	
	38150	2610.0	-24.01	38.76	14.75	29.85	
Channel Bandwidth: 20 MHz / 16QAM							
Y	37850	2580.0	-30.80	39.26	8.46	7.01	H
	38000	2595.0	-29.52	38.17	8.65	7.33	
	38150	2610.0	-29.90	38.71	8.81	7.60	
	37850	2580.0	-25.73	39.33	13.60	22.91	V
	38000	2595.0	-25.01	38.68	13.67	23.28	
	38150	2610.0	-25.00	38.76	13.76	23.77	
Channel Bandwidth: 20 MHz / 64QAM							
Y	37850	2580.0	-31.99	39.26	7.27	5.33	H
	38000	2595.0	-30.64	38.17	7.53	5.66	
	38150	2610.0	-31.08	38.71	7.63	5.79	
	37850	2580.0	-26.87	39.33	12.46	17.62	V
	38000	2595.0	-26.09	38.68	12.59	18.16	
	38150	2610.0	-26.06	38.76	12.70	18.62	

Note: EIRP (dBm) = Reading (dBm) + Correction Factor (dB)

**CA Mode**

LTE Band 38							
Channel Bandwidth: 20+20 MHz / QPSK							
Plane	Channel	Frequency (MHz)	Reading (dBm)	Correction Factor (dB)	EIRP (dBm)	EIRP (mW)	Polarization (H/V)
Y	37850+38048	2580+2599.8	-30.67	38.71	8.04	6.37	H
	37901+38099	2585.1+2604.9	-29.42	38.71	9.29	8.49	
	37952+38150	2590.2+2610	-29.77	38.71	8.94	7.83	
	37850+38048	2580+2599.8	-25.08	38.76	13.68	23.33	V
	37901+38099	2585.1+2604.9	-24.21	38.76	14.55	28.51	
	37952+38150	2590.2+2610	-24.20	38.76	14.56	28.58	

Note: EIRP (dBm) = Reading (dBm) + Correction Factor (dB)

## 4.2 Modulation Characteristics Measurement

### 4.2.1 Limits of Modulation Characteristics

N/A

### 4.2.2 Test Setup



### 4.2.3 Test Procedure

Connect the EUT to Communication Simulator via the antenna connector. The frequency band is set as EUT supported Modulation and Channels, the EUT output is matched with 50 ohm load, the waveform quality and constellation of the EUT was tested.

### 4.2.4 Test Results

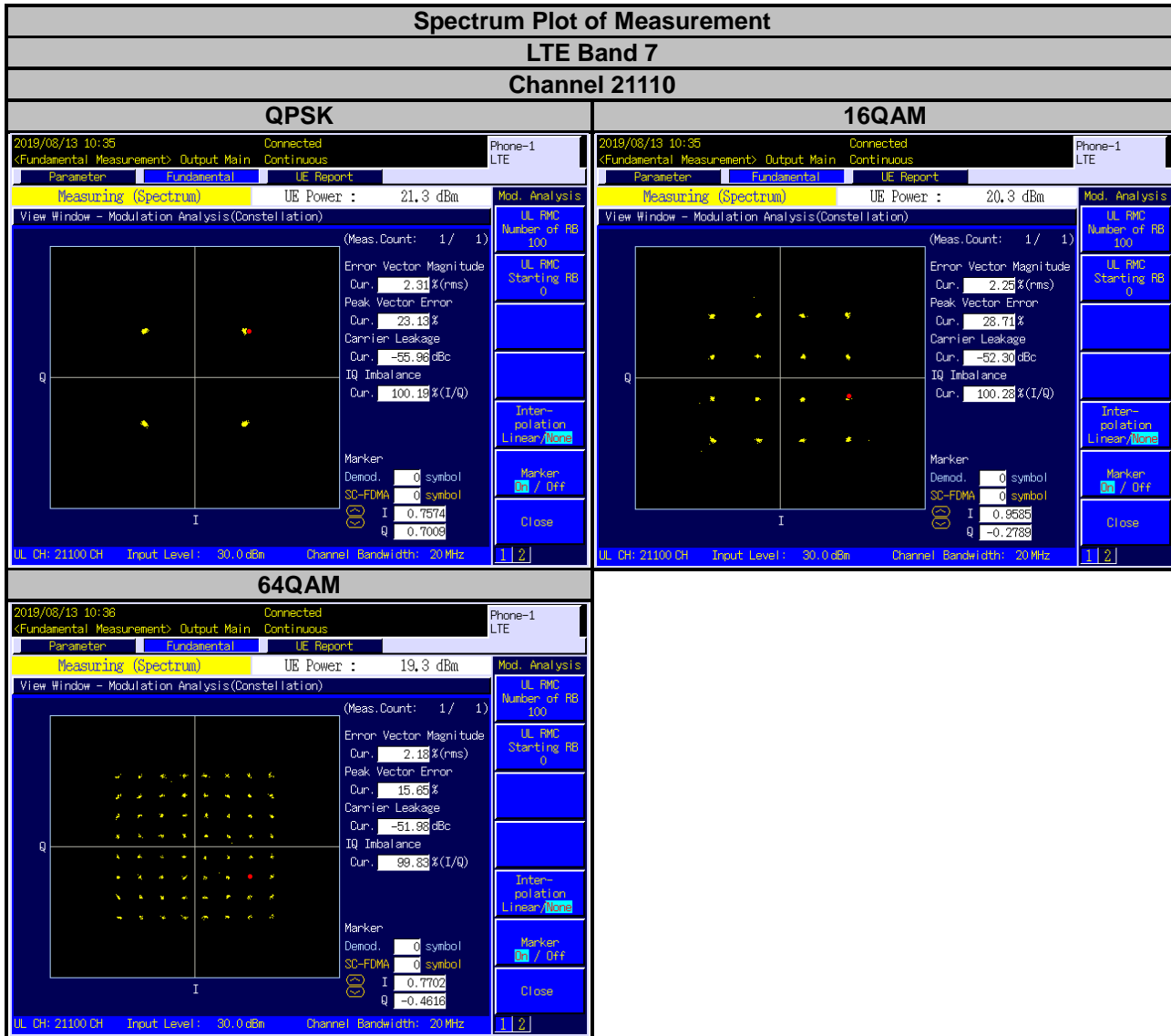

CA Mode

Spectrum Plot of Measurement

LTE Band 7

Channel 21001 & 21199

QPSK

16QAM

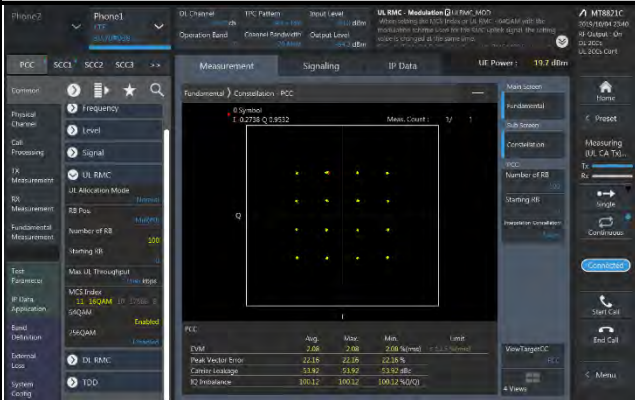
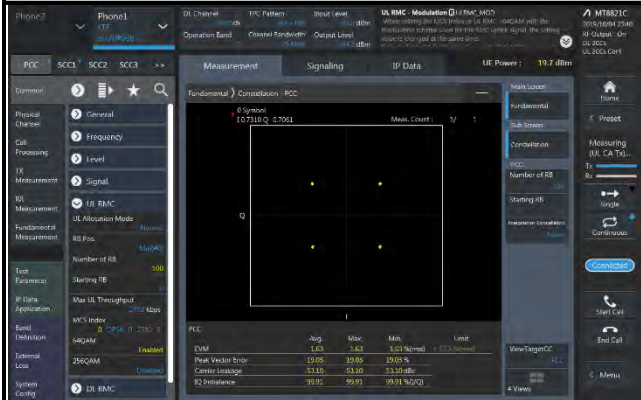

64QAM

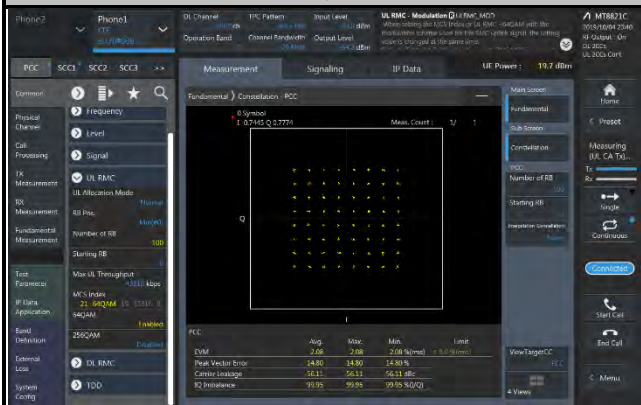



### Spectrum Plot of Measurement

LTE Band 38

Channel 38000

**QPSK**

**16QAM**

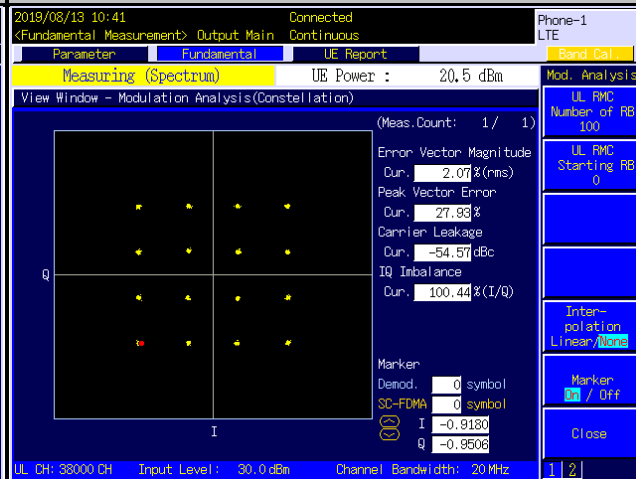
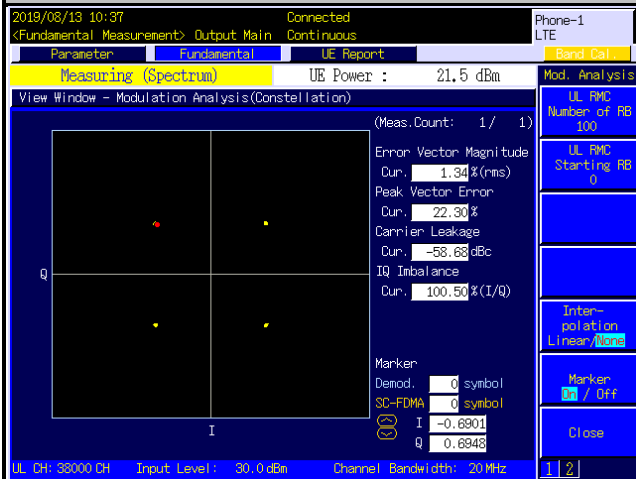

**64QAM**

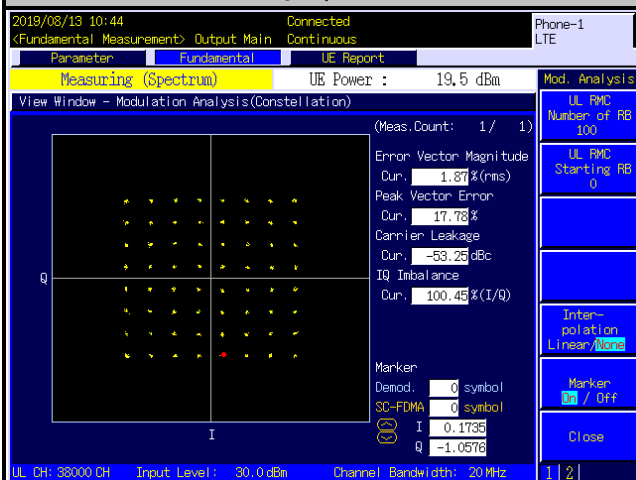

CA Mode

Spectrum Plot of Measurement

LTE Band 38

Channel 37901 & 38099

QPSK

16QAM

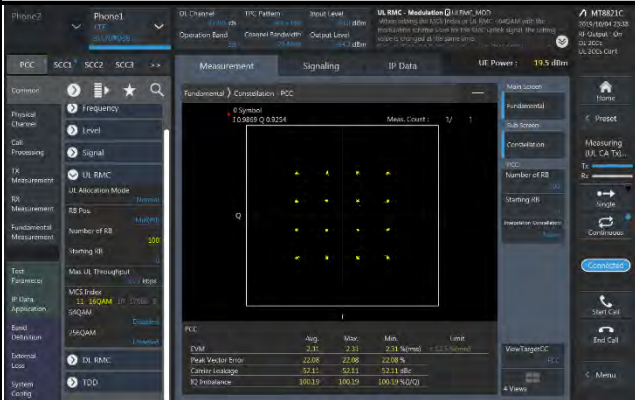
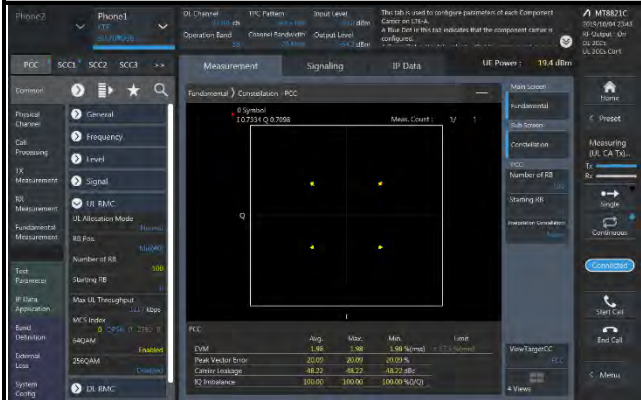

64QAM

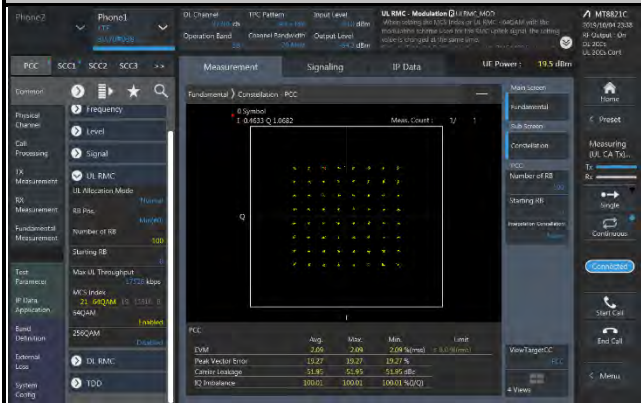

### 4.3 Frequency Stability Measurement

#### 4.3.1 Limits of Frequency Stability Measurement

According to the FCC part 2.1055 shall be tested the frequency stability. The rule is defined that "The frequency stability shall be sufficient to ensure that the fundamental emission stays within the authorized frequency block." The test extreme voltage is according to the 2.1055(d)(1) Vary primary supply voltage from 85 to 115 percent of the nominal value for other than hand carried battery equipment and the extreme temperature rule is comply with specification of EUT  $-30^{\circ}\text{C} \sim 50^{\circ}\text{C}$ .

#### 4.3.2 Test Procedure

- Device is placed at the oven room. The oven room could control the temperatures and humidity. Power warm up is at least 15 min and power applied should perform before recording frequency error.
- EUT is connected the external power supply to control the DC input power. The test voltage range is from minimum to maximum working voltage. Each step shall be record the frequency error rate.
- The temperature range step is 10 degrees in this test items. All temperature levels shall be hold the  $\pm 0.5^{\circ}\text{C}$  during the measurement testing. The each temperature step shall be at least 0.5 hours, consider the EUT could be test under the stability condition.

**NOTE:** The frequency error was recorded frequency error from the communication simulator.

#### 4.3.3 Test Setup

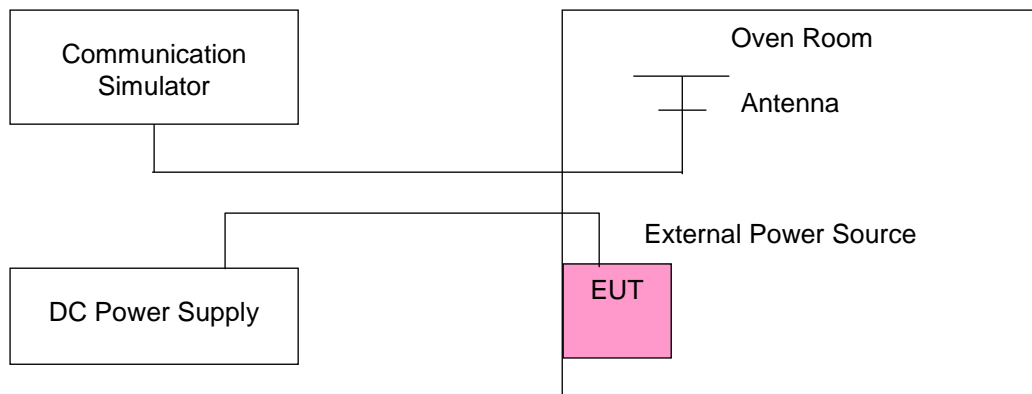

#### 4.3.4 Test Results

##### Frequency Error vs. Voltage

Voltage (Volts)	LTE Band 7			
	Channel Bandwidth: 5 MHz			
	Low Channel		High Channel	
	Frequency (MHz)	Frequency Error (ppm)	Frequency (MHz)	Frequency Error (ppm)
3.8	2502.500002	0.001	2567.500002	0.001
3.4	2502.500002	0.001	2567.500003	0.001
4.35	2502.500001	0.000	2567.500004	0.001

**Note:** The applicant defined the normal working voltage of the battery is from 3.4 Vdc to 4.35 Vdc.

##### Frequency Error vs. Temperature

Temp. (°C)	LTE Band 7			
	Channel Bandwidth: 5 MHz			
	Low Channel		High Channel	
	Frequency (MHz)	Frequency Error (ppm)	Frequency (MHz)	Frequency Error (ppm)
-25	2502.500003	0.001	2567.500001	0.000
-20	2502.500003	0.001	2567.500004	0.001
-10	2502.500002	0.001	2567.500001	0.001
0	2502.500002	0.001	2567.500003	0.001
10	2502.500001	0.001	2567.500004	0.001
20	2502.499999	0.000	2567.499998	-0.001
30	2502.499999	-0.001	2567.499999	0.000
40	2502.499998	-0.001	2567.499997	-0.001
50	2502.499999	0.000	2567.499999	-0.001
55	2502.499996	-0.002	2567.499998	-0.001

**Note:**

1. The applicant declared that the normal operating temperature of the EUT is from -25°C to 55°C.
2. The EUT would shut down automatically as below -25°C.

Frequency Error vs. Voltage

Voltage (Volts)	LTE Band 7			
	Channel Bandwidth: 10 MHz			
	Low Channel		High Channel	
	Frequency (MHz)	Frequency Error (ppm)	Frequency (MHz)	Frequency Error (ppm)
3.8	2505.000004	0.001	2565.000003	0.001
3.4	2505.000002	0.001	2565.000003	0.001
4.35	2505.000001	0.001	2565.000004	0.001

**Note:** The applicant defined the normal working voltage of the battery is from 3.4 Vdc to 4.35 Vdc.

Frequency Error vs. Temperature

Temp. (°C)	LTE Band 7			
	Channel Bandwidth: 10 MHz			
	Low Channel		High Channel	
	Frequency (MHz)	Frequency Error (ppm)	Frequency (MHz)	Frequency Error (ppm)
-25	2505.000004	0.001	2565.000002	0.001
-20	2505.000003	0.001	2565.000002	0.001
-10	2505.000002	0.001	2565.000001	0.000
0	2505.000003	0.001	2565.000003	0.001
10	2505.000002	0.001	2565.000004	0.001
20	2504.999998	-0.001	2564.999996	-0.002
30	2504.999998	-0.001	2564.999998	-0.001
40	2504.999997	-0.001	2564.999999	0.000
50	2504.999996	-0.001	2564.999998	-0.001
55	2504.999997	-0.001	2564.999997	-0.001

**Note:**

1. The applicant declared that the normal operating temperature of the EUT is from -25°C to 55°C.
2. The EUT would shut down automatically as below -25°C.

Frequency Error vs. Voltage

Voltage (Volts)	LTE Band 7			
	Channel Bandwidth: 15 MHz			
	Low Channel		High Channel	
	Frequency (MHz)	Frequency Error (ppm)	Frequency (MHz)	Frequency Error (ppm)
3.8	2507.500002	0.001	2562.500004	0.002
3.4	2507.500002	0.001	2562.500003	0.001
4.35	2507.500003	0.001	2562.500002	0.001

**Note:** The applicant defined the normal working voltage of the battery is from 3.4 Vdc to 4.35 Vdc.

Frequency Error vs. Temperature

Temp. (°C)	LTE Band 7			
	Channel Bandwidth: 15 MHz			
	Low Channel		High Channel	
	Frequency (MHz)	Frequency Error (ppm)	Frequency (MHz)	Frequency Error (ppm)
-25	2507.500001	0.001	2562.500002	0.001
-20	2507.500003	0.001	2562.500002	0.001
-10	2507.500001	0.001	2562.500003	0.001
0	2507.500002	0.001	2562.500003	0.001
10	2507.500002	0.001	2562.500001	0.001
20	2507.499997	-0.001	2562.499998	-0.001
30	2507.499998	-0.001	2562.499998	-0.001
40	2507.499997	-0.001	2562.499998	-0.001
50	2507.499999	0.000	2562.499997	-0.001
55	2507.499997	-0.001	2562.499998	-0.001

**Note:**

1. The applicant declared that the normal operating temperature of the EUT is from -25°C to 55°C.
2. The EUT would shut down automatically as below -25°C.

Frequency Error vs. Voltage

Voltage (Volts)	LTE Band 7			
	Channel Bandwidth: 20 MHz			
	Low Channel		High Channel	
	Frequency (MHz)	Frequency Error (ppm)	Frequency (MHz)	Frequency Error (ppm)
3.8	2510.000001	0.000	2560.000002	0.001
3.4	2510.000004	0.001	2560.000003	0.001
4.35	2510.000003	0.001	2560.000003	0.001

**Note:** The applicant defined the normal working voltage of the battery is from 3.4 Vdc to 4.35 Vdc.

Frequency Error vs. Temperature

Temp. (°C)	LTE Band 7			
	Channel Bandwidth: 20 MHz			
	Low Channel		High Channel	
	Frequency (MHz)	Frequency Error (ppm)	Frequency (MHz)	Frequency Error (ppm)
-25	2510.000003	0.001	2560.000001	0.000
-20	2510.000004	0.001	2560.000003	0.001
-10	2510.000003	0.001	2560.000003	0.001
0	2510.000002	0.001	2560.000003	0.001
10	2510.000003	0.001	2560.000002	0.001
20	2509.999999	0.000	2559.999998	-0.001
30	2509.999998	-0.001	2559.999999	-0.001
40	2509.999999	0.000	2559.999998	-0.001
50	2509.999998	-0.001	2559.999999	0.000
55	2509.999996	-0.001	2559.999997	-0.001

**Note:**

1. The applicant declared that the normal operating temperature of the EUT is from -25°C to 55°C.
2. The EUT would shut down automatically as below -25°C.

**CA Mode**

Frequency Error vs. Voltage

Voltage (Volts)	LTE Band 7	
	Channel Bandwidth: 20+20 MHz	
	Frequency (MHz)	Frequency Error (ppm)
3.8	2549.800002	0.001
3.4	2549.800002	0.001
4.35	2549.800002	0.001

**Note:** The applicant defined the normal working voltage of the battery is from 3.4 Vdc to 4.35 Vdc.

Frequency Error vs. Temperature

Temp. (°C)	LTE Band 7	
	Channel Bandwidth: 20+20 MHz	
	Frequency (MHz)	Frequency Error (ppm)
-25	2549.800003	0.001
-20	2549.800003	0.001
-10	2549.800001	0.001
0	2549.800003	0.001
10	2549.800001	0.000
20	2549.799997	-0.001
30	2549.799999	-0.001
40	2549.799999	0.000
50	2549.799998	-0.001
55	2549.799997	-0.001

**Note:**

1. The applicant declared that the normal operating temperature of the EUT is from -25°C to 55°C.
2. The EUT would shut down automatically as below -25°C.



Frequency Error vs. Voltage

Voltage (Volts)	LTE Band 38			
	Channel Bandwidth: 5 MHz			
	Low Channel		High Channel	
	Frequency (MHz)	Frequency Error (ppm)	Frequency (MHz)	Frequency Error (ppm)
3.8	2572.500002	0.001	2617.500003	0.001
3.4	2572.500001	0.000	2617.500003	0.001
4.35	2572.500004	0.001	2617.500002	0.001

**Note:** The applicant defined the normal working voltage of the battery is from 3.4 Vdc to 4.35 Vdc.

Frequency Error vs. Temperature

Temp. (°C)	LTE Band 38			
	Channel Bandwidth: 5 MHz			
	Low Channel		High Channel	
	Frequency (MHz)	Frequency Error (ppm)	Frequency (MHz)	Frequency Error (ppm)
-25	2572.500002	0.001	2617.500001	0.000
-20	2572.500001	0.000	2617.500002	0.001
-10	2572.500002	0.001	2617.500002	0.001
0	2572.500002	0.001	2617.500002	0.001
10	2572.500002	0.001	2617.500003	0.001
20	2572.499996	-0.001	2617.499997	-0.001
30	2572.499997	-0.001	2617.499998	-0.001
40	2572.499999	-0.001	2617.499997	-0.001
50	2572.499999	-0.001	2617.499997	-0.001
55	2572.499998	-0.001	2617.499997	-0.001

**Note:**

1. The applicant declared that the normal operating temperature of the EUT is from -25°C to 55°C.
2. The EUT would shut down automatically as below -25°C.

Frequency Error vs. Voltage

Voltage (Volts)	LTE Band 38			
	Channel Bandwidth: 10 MHz			
	Low Channel		High Channel	
	Frequency (MHz)	Frequency Error (ppm)	Frequency (MHz)	Frequency Error (ppm)
3.8	2575.000002	0.001	2615.000002	0.001
3.4	2575.000003	0.001	2615.000001	0.000
4.35	2575.000002	0.001	2615.000002	0.001

**Note:** The applicant defined the normal working voltage of the battery is from 3.4 Vdc to 4.35 Vdc.

Frequency Error vs. Temperature

Temp. (°C)	LTE Band 38			
	Channel Bandwidth: 10 MHz			
	Low Channel		High Channel	
	Frequency (MHz)	Frequency Error (ppm)	Frequency (MHz)	Frequency Error (ppm)
-25	2575.000002	0.001	2615.000003	0.001
-20	2575.000003	0.001	2615.000002	0.001
-10	2575.000004	0.002	2615.000002	0.001
0	2575.000001	0.001	2615.000003	0.001
10	2575.000002	0.001	2615.000003	0.001
20	2574.999997	-0.001	2614.999998	-0.001
30	2574.999997	-0.001	2614.999997	-0.001
40	2574.999996	-0.002	2614.999996	-0.002
50	2574.999997	-0.001	2614.999998	-0.001
55	2574.999998	-0.001	2614.999998	-0.001

**Note:**

1. The applicant declared that the normal operating temperature of the EUT is from -25°C to 55°C.
2. The EUT would shut down automatically as below -25°C.

Frequency Error vs. Voltage

Voltage (Volts)	LTE Band 38			
	Channel Bandwidth: 15 MHz			
	Low Channel		High Channel	
	Frequency (MHz)	Frequency Error (ppm)	Frequency (MHz)	Frequency Error (ppm)
3.8	2577.500002	0.001	2612.500002	0.001
3.4	2577.500002	0.001	2612.500003	0.001
4.35	2577.500002	0.001	2612.500004	0.001

**Note:** The applicant defined the normal working voltage of the battery is from 3.4 Vdc to 4.35 Vdc.

Frequency Error vs. Temperature

Temp. (°C)	LTE Band 38			
	Channel Bandwidth: 15 MHz			
	Low Channel		High Channel	
	Frequency (MHz)	Frequency Error (ppm)	Frequency (MHz)	Frequency Error (ppm)
-25	2577.500003	0.001	2612.500003	0.001
-20	2577.500002	0.001	2612.500001	0.000
-10	2577.500004	0.002	2612.500002	0.001
0	2577.500004	0.001	2612.500001	0.000
10	2577.500003	0.001	2612.500002	0.001
20	2577.499998	-0.001	2612.499997	-0.001
30	2577.499999	0.000	2612.499999	-0.001
40	2577.499997	-0.001	2612.499999	0.000
50	2577.499996	-0.001	2612.499997	-0.001
55	2577.499996	-0.002	2612.499997	-0.001

**Note:**

1. The applicant declared that the normal operating temperature of the EUT is from -25°C to 55°C.
2. The EUT would shut down automatically as below -25°C.

Frequency Error vs. Voltage

Voltage (Volts)	LTE Band 38			
	Channel Bandwidth: 20 MHz			
	Low Channel		High Channel	
	Frequency (MHz)	Frequency Error (ppm)	Frequency (MHz)	Frequency Error (ppm)
3.8	2580.000002	0.001	2610.000002	0.001
3.4	2580.000003	0.001	2610.000002	0.001
4.35	2580.000001	0.001	2610.000000	0.001

**Note:** The applicant defined the normal working voltage of the battery is from 3.4 Vdc to 4.35 Vdc.

Frequency Error vs. Temperature

Temp. (°C)	LTE Band 38			
	Channel Bandwidth: 20 MHz			
	Low Channel		High Channel	
	Frequency (MHz)	Frequency Error (ppm)	Frequency (MHz)	Frequency Error (ppm)
-25	2580.000003	0.001	2610.000003	0.001
-20	2580.000003	0.001	2610.000001	0.000
-10	2580.000001	0.000	2610.000004	0.001
0	2580.000002	0.001	2610.000002	0.001
10	2580.000003	0.001	2610.000003	0.001
20	2579.999997	-0.001	2609.999997	-0.001
30	2579.999999	0.000	2609.999998	-0.001
40	2579.999998	-0.001	2609.999998	-0.001
50	2579.999996	-0.001	2609.999996	-0.001
55	2579.999998	-0.001	2609.999999	0.000

**Note:**

1. The applicant declared that the normal operating temperature of the EUT is from -25°C to 55°C.
2. The EUT would shut down automatically as below -25°C.

**CA Mode**

Frequency Error vs. Voltage

Voltage (Volts)	LTE Band 38	
	Channel Bandwidth: 20+20 MHz	
	Frequency (MHz)	Frequency Error (ppm)
3.8	2589.250004	0.002
3.4	2589.250003	0.001
4.35	2589.250003	0.001

**Note:** The applicant defined the normal working voltage of the battery is from 3.4 Vdc to 4.35 Vdc.

Frequency Error vs. Temperature

Temp. (°C)	LTE Band 38	
	Channel Bandwidth: 20+20 MHz	
	Frequency (MHz)	Frequency Error (ppm)
-25	2589.250002	0.001
-20	2589.250003	0.001
-10	2589.250004	0.002
0	2589.250003	0.001
10	2589.250004	0.002
20	2589.249997	-0.001
30	2589.249998	-0.001
40	2589.249998	-0.001
50	2589.249997	-0.001
55	2589.249997	-0.001

**Note:**

1. The applicant declared that the normal operating temperature of the EUT is from -25°C to 55°C.
2. The EUT would shut down automatically as below -25°C.

#### 4.4 Occupied Bandwidth Measurement

##### 4.4.1 Limits of Occupied Bandwidth Measurement

The width of a frequency band such that, below the lower and above the upper frequency limits, the mean powers emitted are each equal to a specified percentage 0.5 % of the total mean power of a given emission.

##### 4.4.2 Test Procedure

- The conducted occupied bandwidth used the power splitter via EUT RF power connector between simulation base station and spectrum analyzer.
- Use OBW measurement function of Spectrum analyzer to measure 99 % occupied bandwidth.

##### 4.4.3 Test Setup

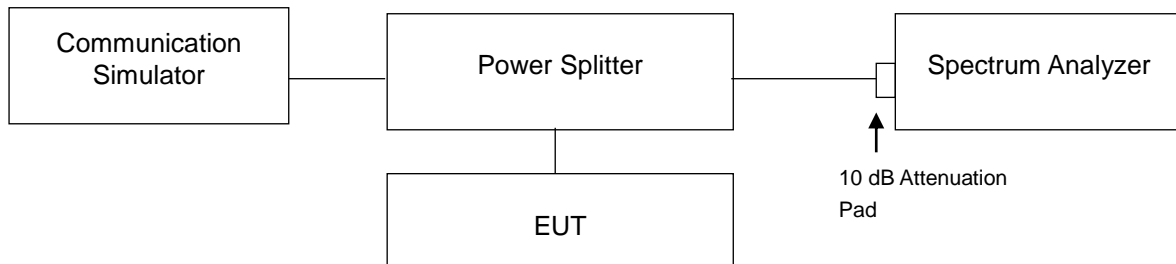

#### 4.4.4 Test Results

LTE Band 7							
Channel Bandwidth: 5 MHz							
Channel	Frequency (MHz)	99 % Occupied Bandwidth (MHz)			26 dB Bandwidth (MHz)		
		QPSK	16QAM	64QAM	QPSK	16QAM	64QAM
20775	2502.5	4.4899	4.4911	4.4986	4.778	4.773	4.795
21100	2535.0	4.4899	4.4905	4.4967	4.773	4.776	4.801
21425	2567.5	4.4890	4.4894	4.4949	4.766	4.768	4.799
Channel Bandwidth: 10 MHz							
Channel	Frequency (MHz)	99 % Occupied Bandwidth (MHz)			26 dB Bandwidth (MHz)		
		QPSK	16QAM	64QAM	QPSK	16QAM	64QAM
20800	2505.0	8.9745	8.9779	8.9789	9.484	9.500	9.507
21100	2535.0	8.9752	8.9805	8.9820	9.496	9.509	9.516
21400	2565.0	8.9652	8.9709	8.9708	9.491	9.490	9.512



LTE Band 7							
Channel Bandwidth: 15 MHz							
Channel	Frequency (MHz)	99 % Occupied Bandwidth (MHz)			26 dB Bandwidth (MHz)		
		QPSK	16QAM	64QAM	QPSK	16QAM	64QAM
20825	2507.5	13.464	13.452	13.448	14.23	14.23	14.22
21100	2535.0	13.475	13.460	13.453	14.25	14.25	14.23
21375	2562.5	13.454	13.437	13.436	14.23	14.23	14.23

Channel Bandwidth: 20 MHz							
Channel	Frequency (MHz)	99 % Occupied Bandwidth (MHz)			26 dB Bandwidth (MHz)		
		QPSK	16QAM	64QAM	QPSK	16QAM	64QAM
20850	2510.0	17.919	17.943	17.936	19.00	18.99	19.01
21100	2535.0	17.940	17.963	17.958	19.01	19.01	19.02
21350	2560.0	17.909	17.928	17.930	19.01	19.02	19.02





### CA Mode

LTE Band 7			
Channel Bandwidth: 20+20 MHz			
Channel	Frequency (MHz)	99 % Occupied Bandwidth (MHz)	26 dB Bandwidth (MHz)
		QPSK	QPSK
20850 & 21048	2510+2529.8	37.578	39.62
21001 & 21199	2525.1+2544.9	37.422	39.51
21152 & 21350	2540.2+2560	37.574	39.61

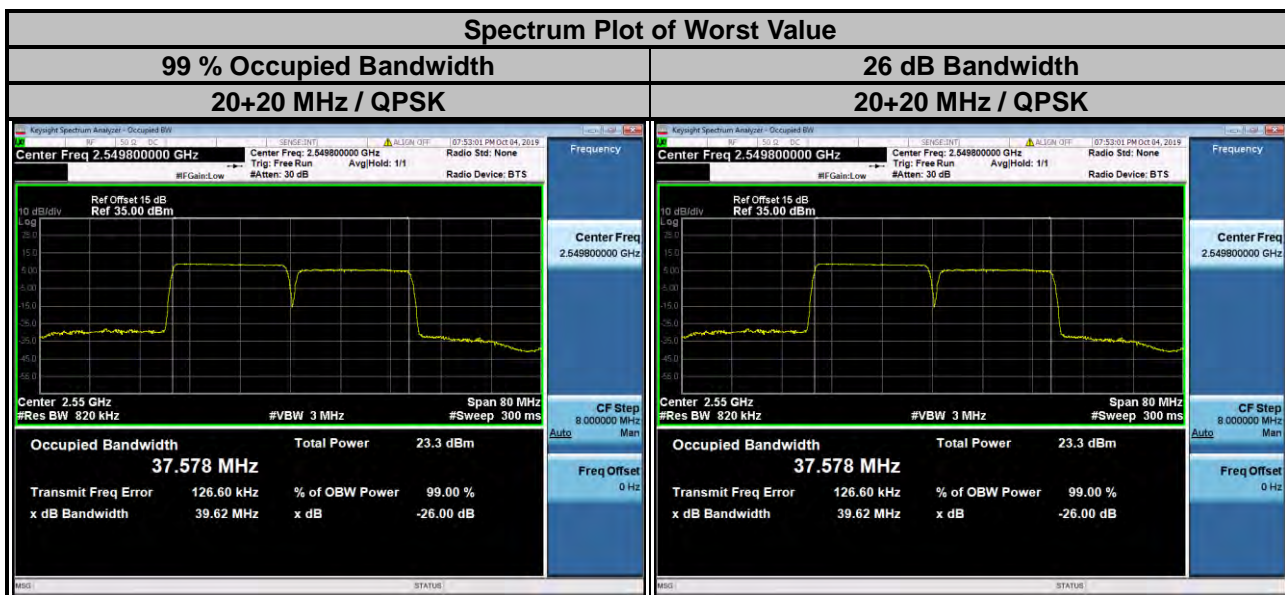

LTE Band 38							
Channel Bandwidth: 5 MHz							
Channel	Frequency (MHz)	99 % Occupied Bandwidth (MHz)			26 dB Bandwidth (MHz)		
		QPSK	16QAM	64QAM	QPSK	16QAM	64QAM
37775	2572.5	4.4916	4.4893	4.4975	4.773	4.770	4.786
38000	2595.0	4.4874	4.4876	4.4990	4.759	4.760	4.758
38225	2617.5	4.4895	4.4881	4.4965	4.773	4.760	4.763

Channel Bandwidth: 10 MHz							
Channel	Frequency (MHz)	99 % Occupied Bandwidth (MHz)			26 dB Bandwidth (MHz)		
		QPSK	16QAM	64QAM	QPSK	16QAM	64QAM
37800	2575.0	8.9624	8.9724	8.9736	9.472	9.493	9.503
38000	2595.0	8.9586	8.9706	8.9681	9.474	9.497	9.496
38200	2615.0	8.9646	8.9749	8.9685	9.474	9.490	9.503

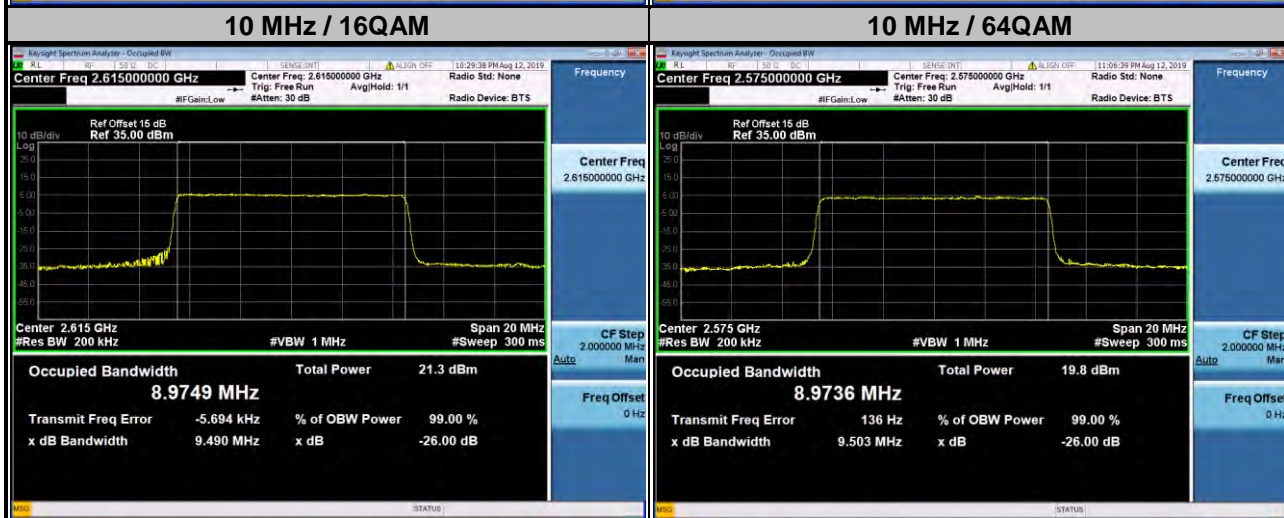
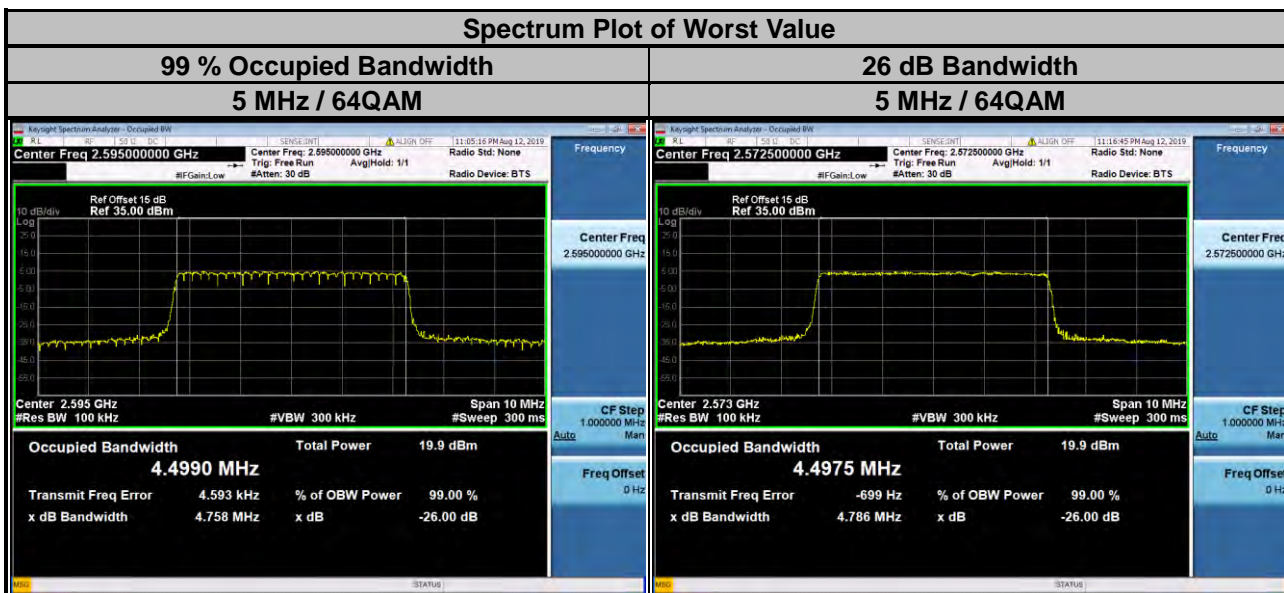

LTE Band 38							
Channel Bandwidth: 15 MHz							
Channel	Frequency (MHz)	99 % Occupied Bandwidth (MHz)			26 dB Bandwidth (MHz)		
		QPSK	16QAM	64QAM	QPSK	16QAM	64QAM
37825	2577.5	13.464	13.446	13.447	14.25	14.23	14.22
38000	2595.0	13.467	13.449	13.453	14.23	14.21	14.23
38175	2612.5	13.468	13.452	13.442	14.23	14.22	14.23

  

Channel Bandwidth: 20 MHz							
Channel	Frequency (MHz)	99 % Occupied Bandwidth (MHz)			26 dB Bandwidth (MHz)		
		QPSK	16QAM	64QAM	QPSK	16QAM	64QAM
37850	2580.0	17.933	17.920	17.944	19.01	19.01	19.03
38000	2595.0	17.930	17.927	17.942	19.00	19.02	19.03
38150	2610.0	17.934	17.924	17.939	19.01	19.01	19.01

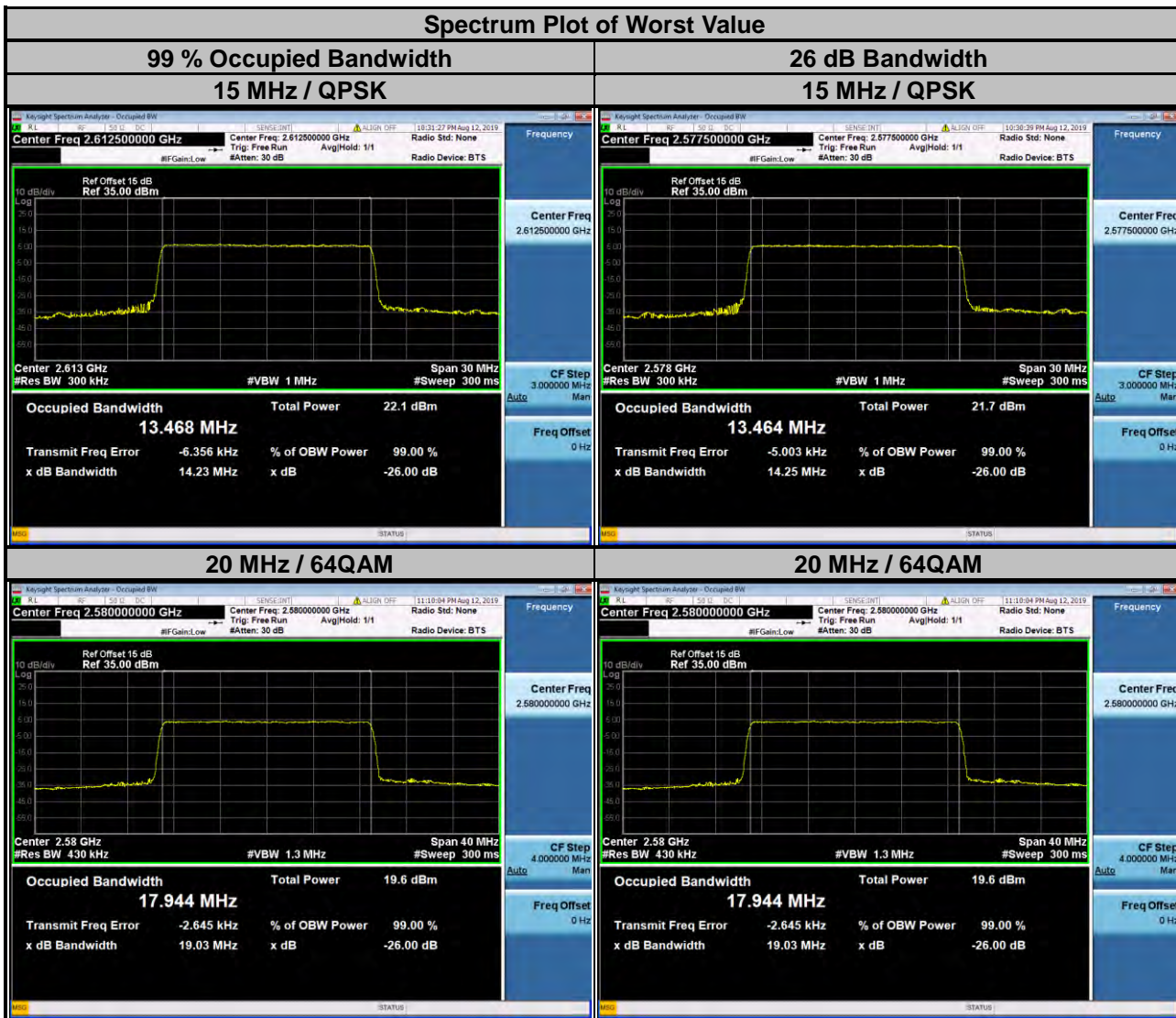

### CA Mode

LTE Band 38			
Channel Bandwidth: 20+20 MHz			
Channel	Frequency (MHz)	99 % Occupied Bandwidth (MHz)	26 dB Bandwidth (MHz)
		QPSK	QPSK
37850 & 38048	2580+2599.8	37.584	39.60
37901 & 38099	2585.1+2604.9	37.586	39.59
37952 & 38150	2590.2+2610	37.584	39.60

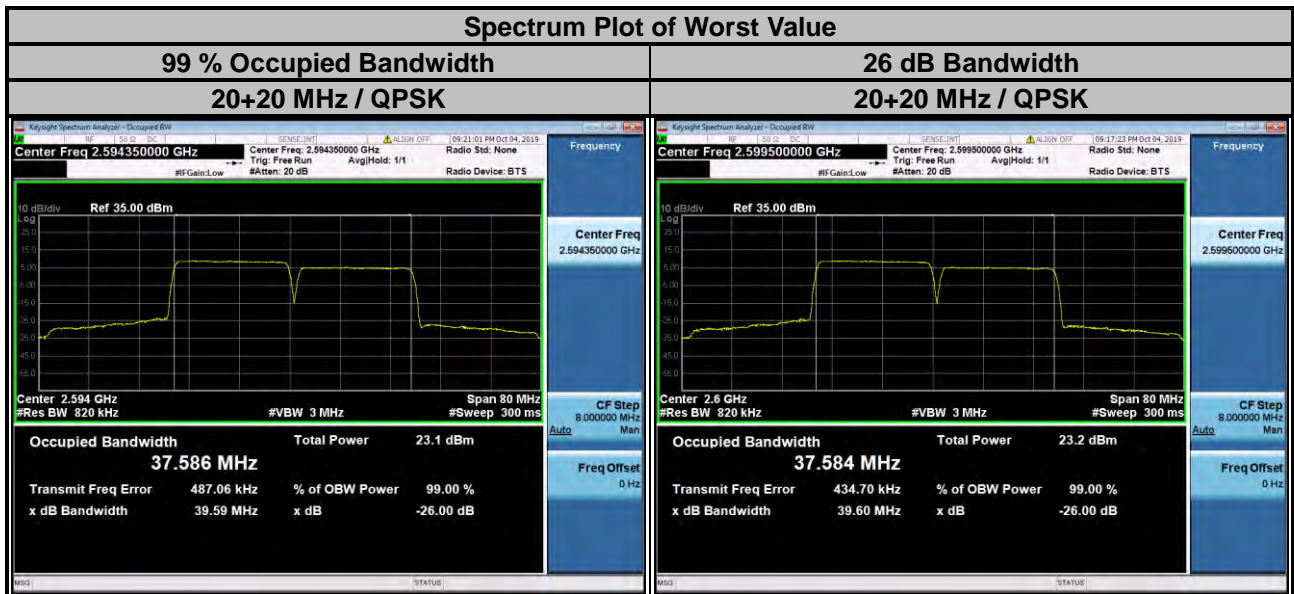

## 4.5 Out-of-Band Emissions Measurement

### 4.5.1 Limits of Out-of-Band Emissions Measurement

According to FCC 27.53(m)(4)&(6) specified that power of any emission outside of the channel edge must be attenuated below the transmitting power (P) by a factor shall be not less than  $40 + 10 \log (P)$  dB on all frequencies between the channel edge and 5 megahertz from the channel edge,  $43 + 10 \log (P)$  dB on all frequencies between 5 megahertz and X megahertz from the channel edge, and  $55 + 10 \log (P)$  dB on all frequencies more than X megahertz from the channel edge, where X is the greater of 6 megahertz or the actual emission bandwidth. In addition, the attenuation factor shall not be less that  $43 + 10 \log (P)$  dB on all frequencies between 2490.5 MHz and 2496 MHz and  $55 + 10 \log (P)$  dB at or below 2490.5 MHz. In the 1 MHz bands immediately outside and adjacent to the frequency block a resolution bandwidth of at least two percent may be employed, except when the 1 megahertz band is 2495-2496 MHz, in which case a resolution bandwidth of at least one percent may be employed.

### 4.5.2 Test Setup

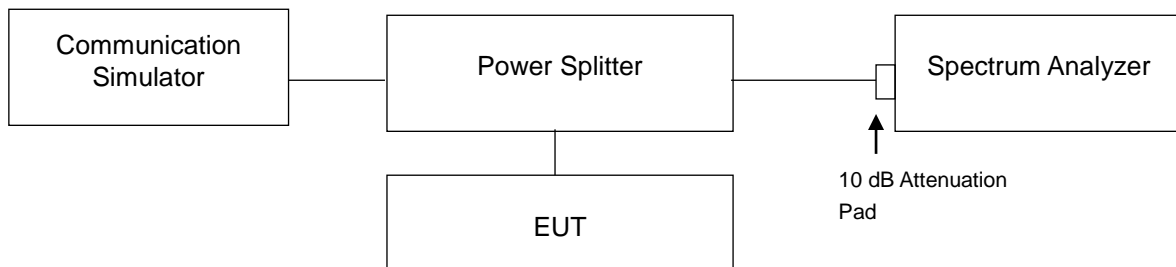

### 4.5.3 Test Procedures

- The EUT was set up for the maximum peak power with LTE link data modulation. The power was measured with R&S Spectrum Analyzer. All measurements were done at 2 channels (low and high operational frequency range).
- The out-of-band emissions measurement used the power splitter via EUT RF power connector between simulation base station and spectrum analyzer.
- Record the max. trace plot into the test report.



4.5.4 Test Results

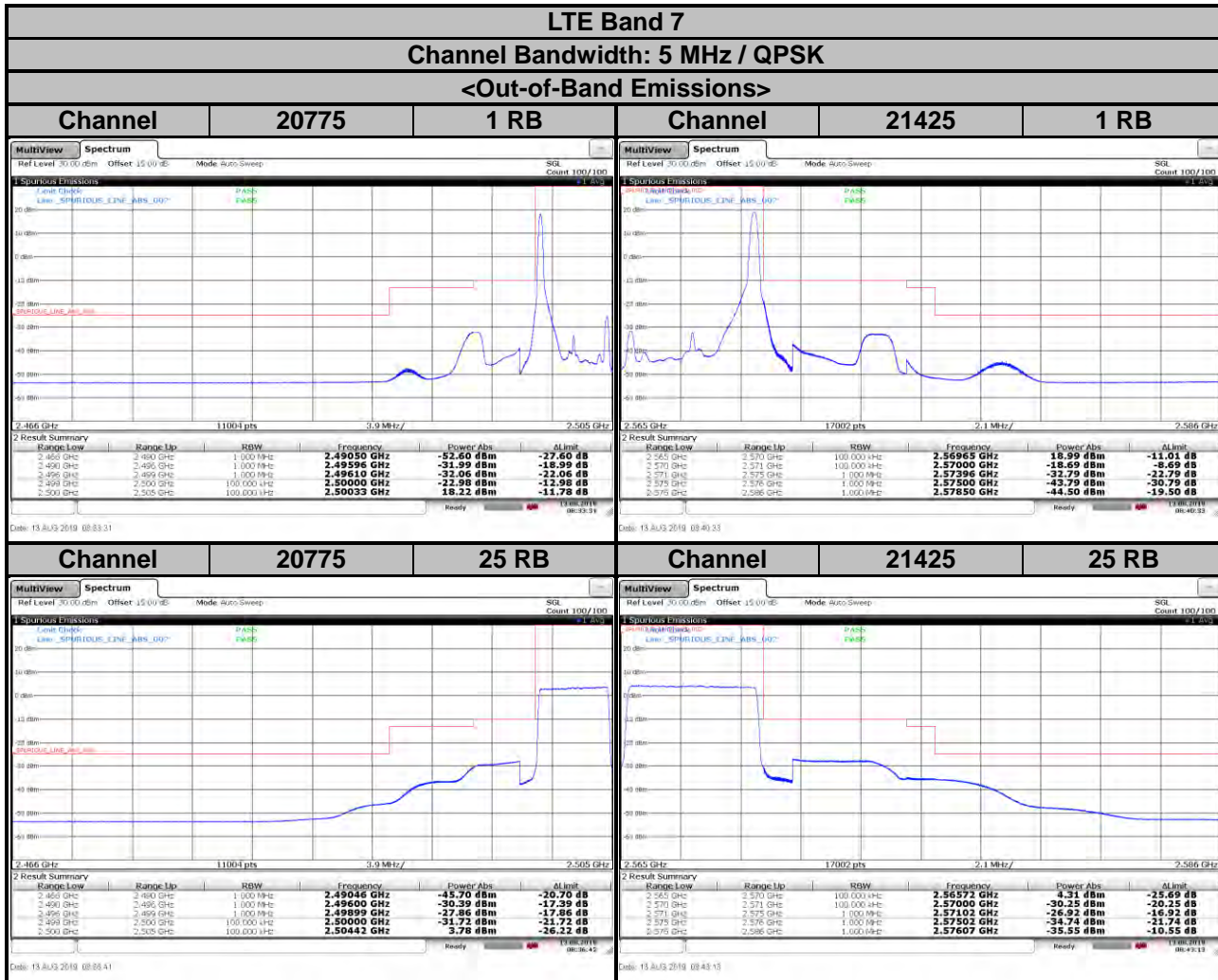

LTE Band 7

Channel Bandwidth: 5 MHz / 16QAM

<Out-of-Band Emissions>

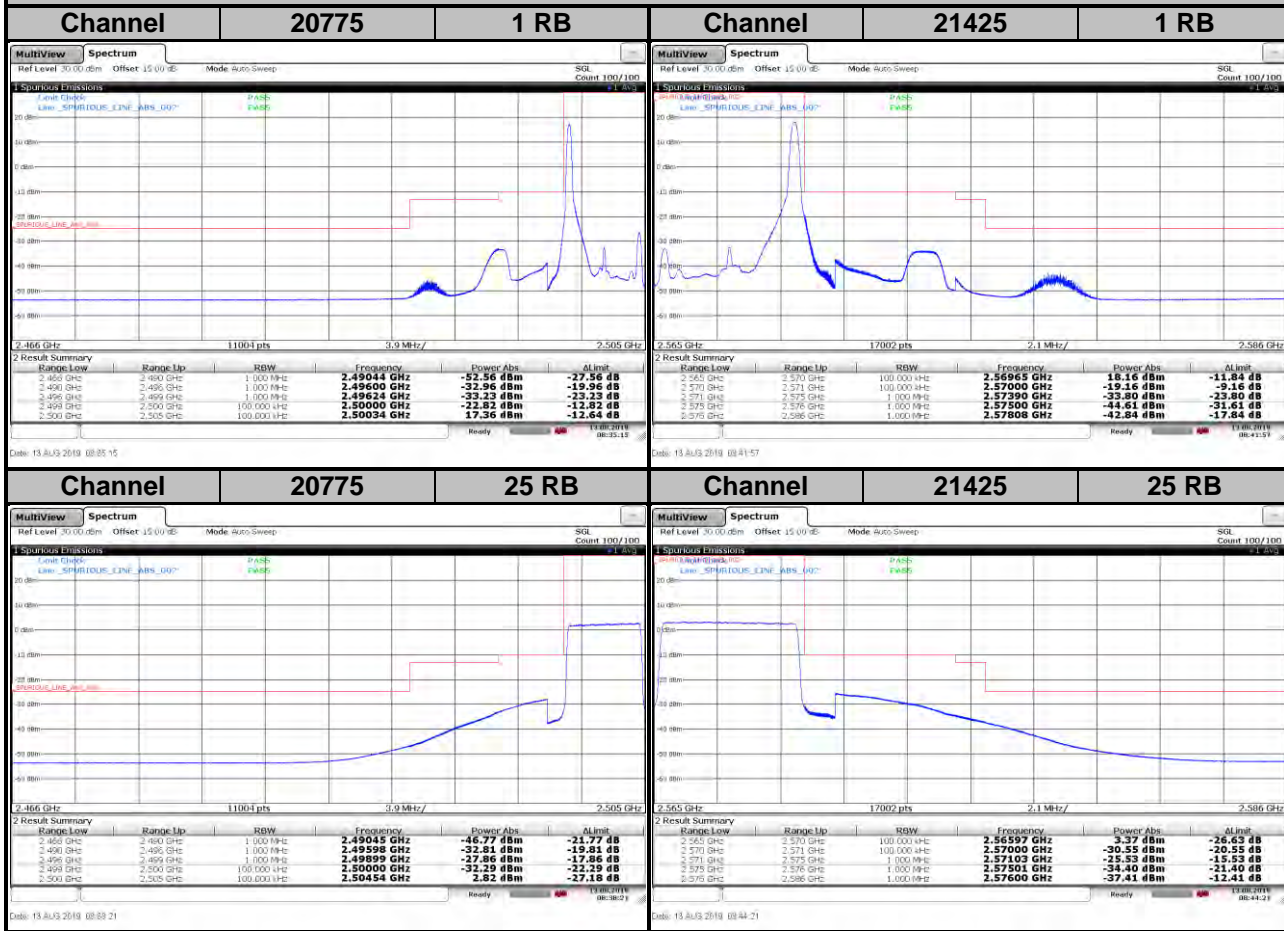

**LTE Band 7**  
**Channel Bandwidth: 5 MHz / 64QAM**

**<Out-of-Band Emissions>**

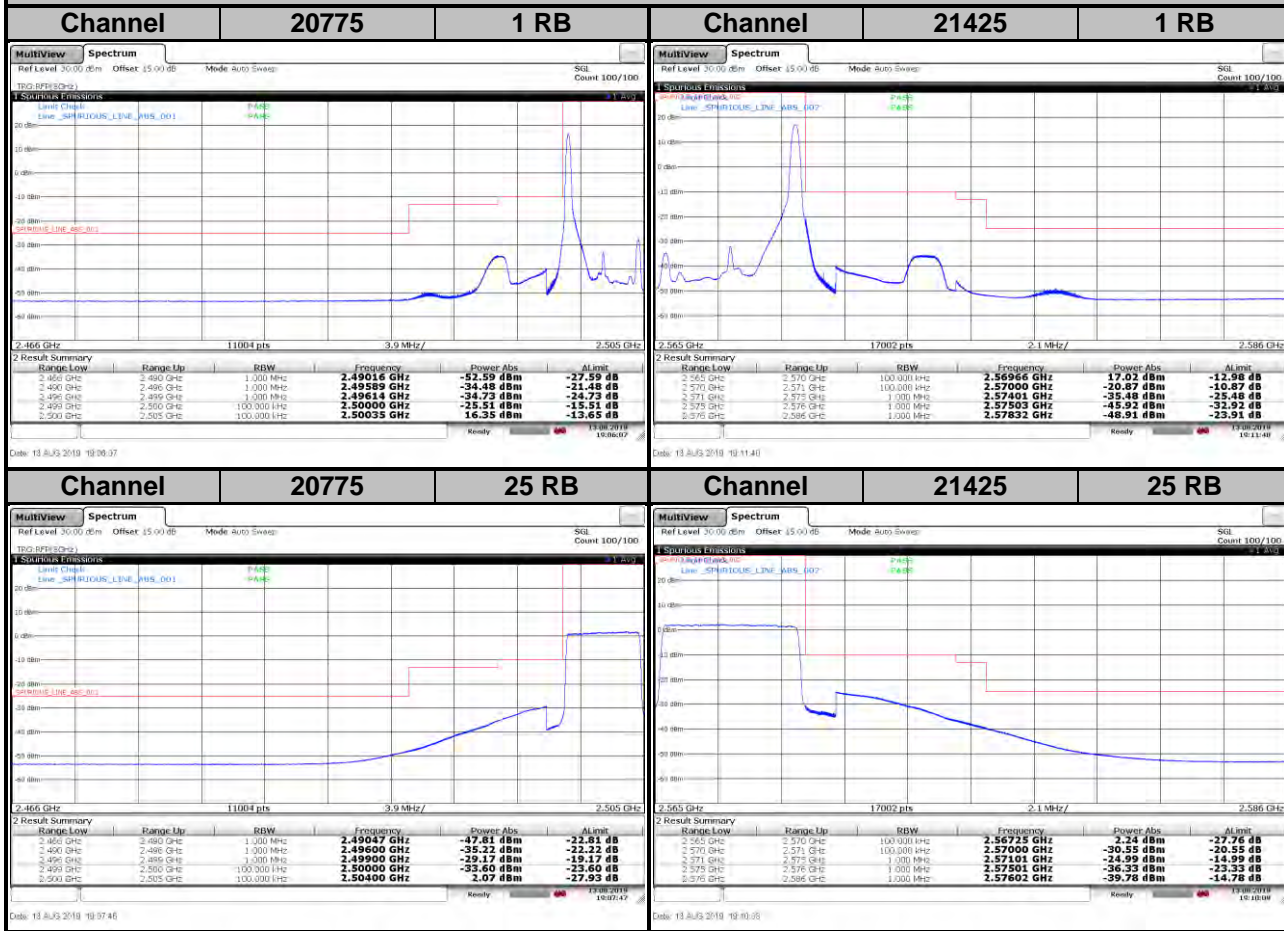



LTE Band 7

Channel Bandwidth: 10 MHz / QPSK

<Out-of-Band Emissions>

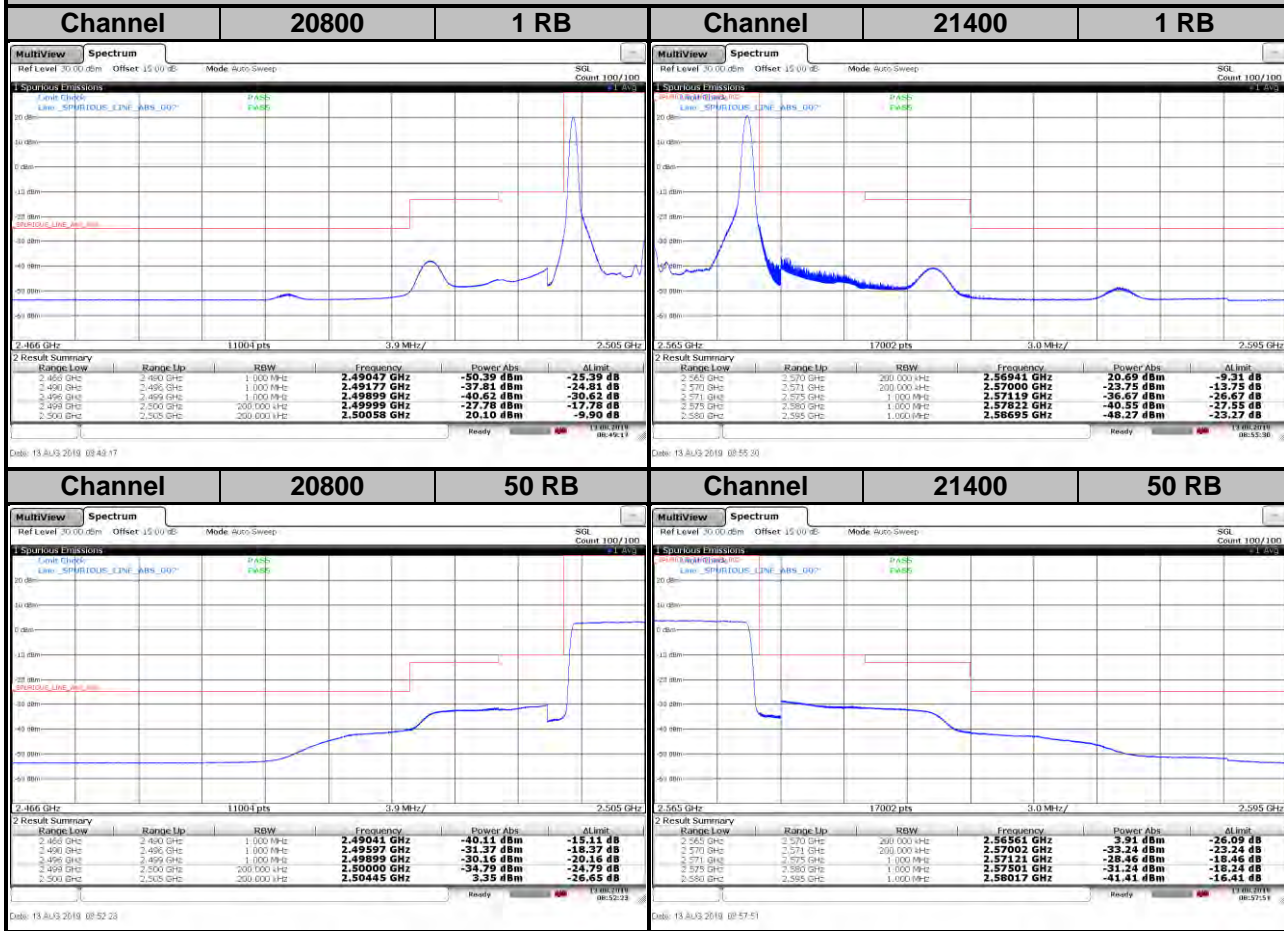

LTE Band 7

Channel Bandwidth: 10 MHz / 16QAM

<Out-of-Band Emissions>

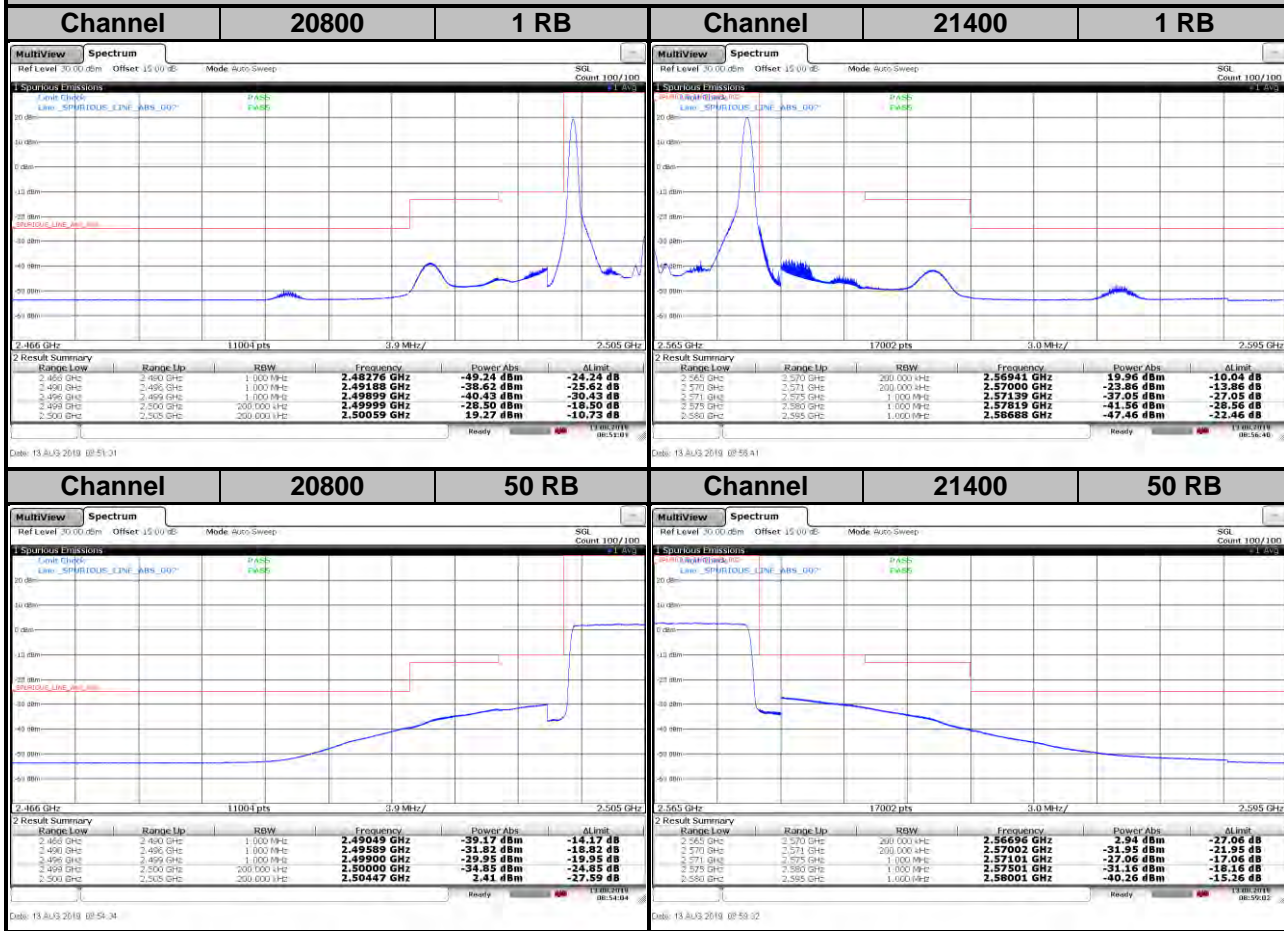

LTE Band 7

Channel Bandwidth: 10 MHz / 64QAM

<Out-of-Band Emissions>

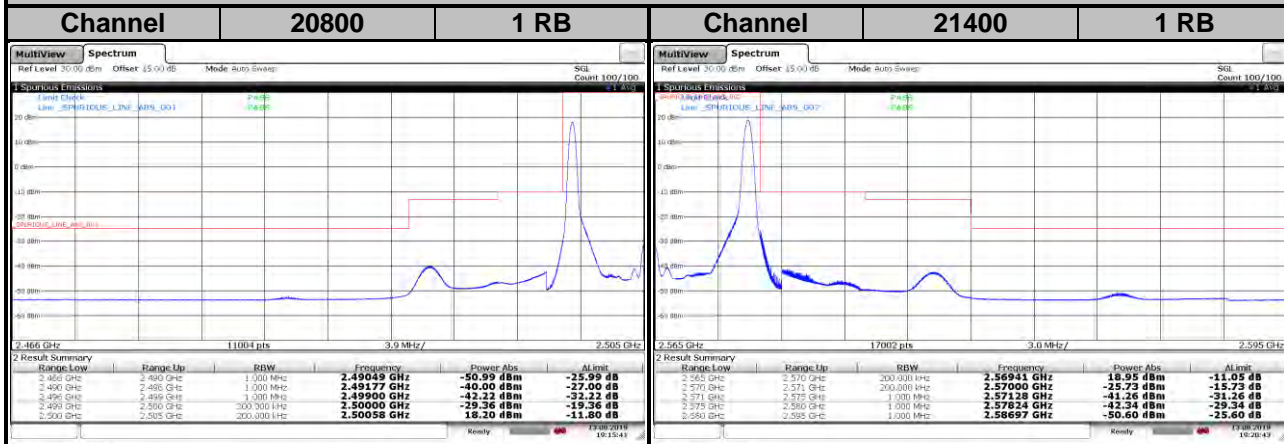

Date: 13.AUG.2018 19:15:41

Date: 13.AUG.2018 19:20:43

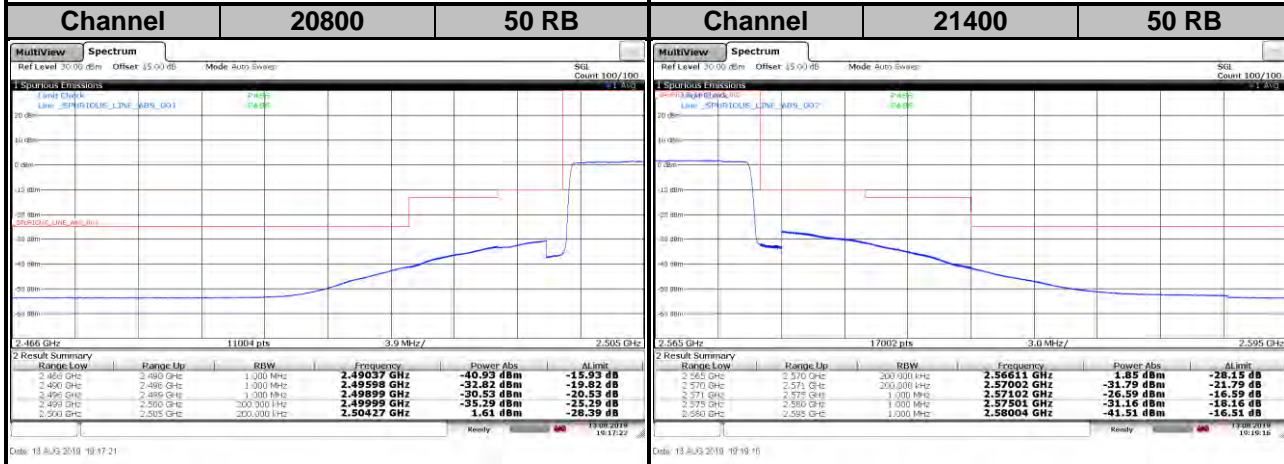

Date: 13.AUG.2018 19:17:21

Date: 13.AUG.2018 19:19:16

LTE Band 7

Channel Bandwidth: 15 MHz / QPSK

<Out-of-Band Emissions>

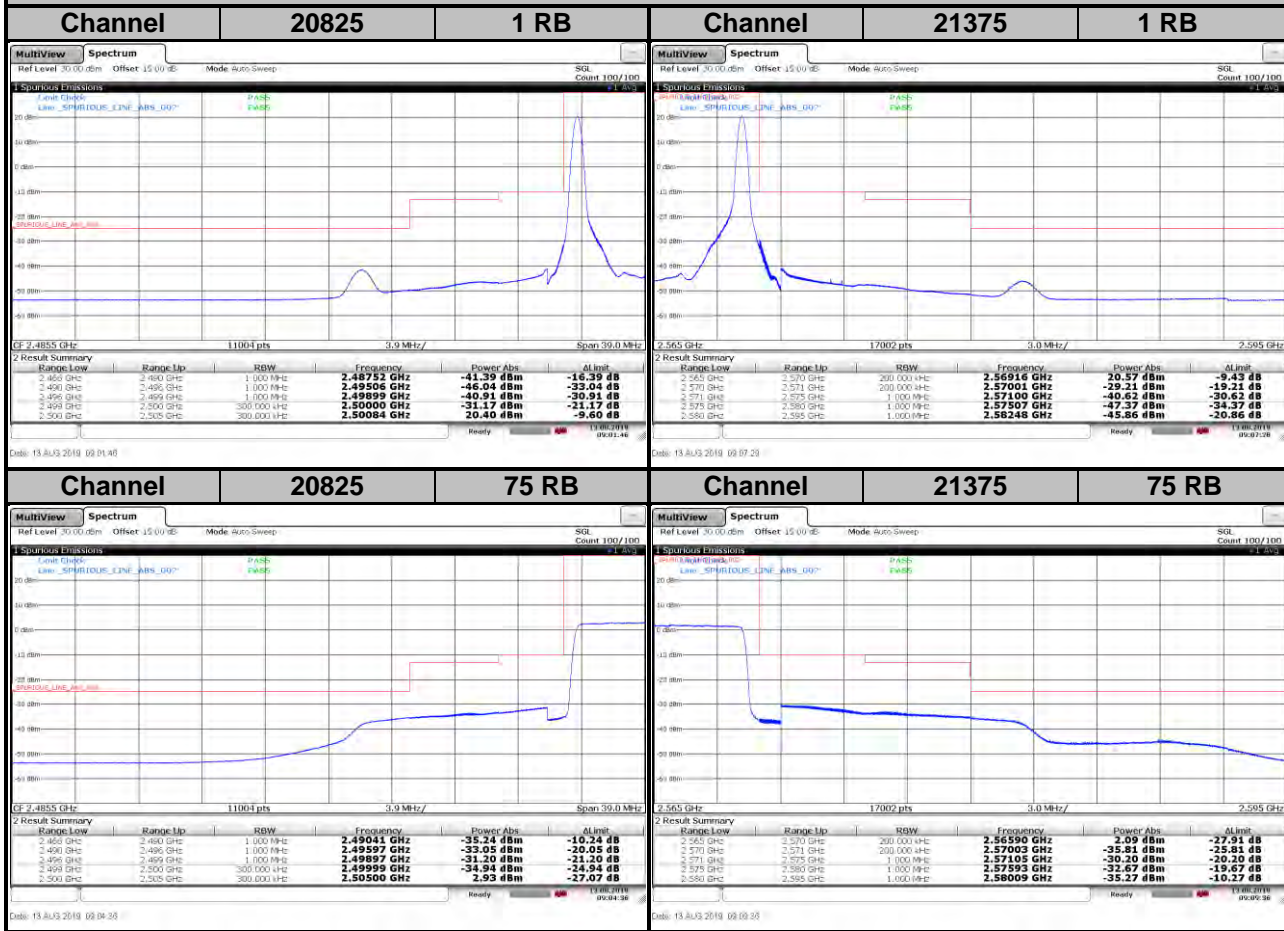



**LTE Band 7**  
**Channel Bandwidth: 15 MHz / 16QAM**

**<Out-of-Band Emissions>**

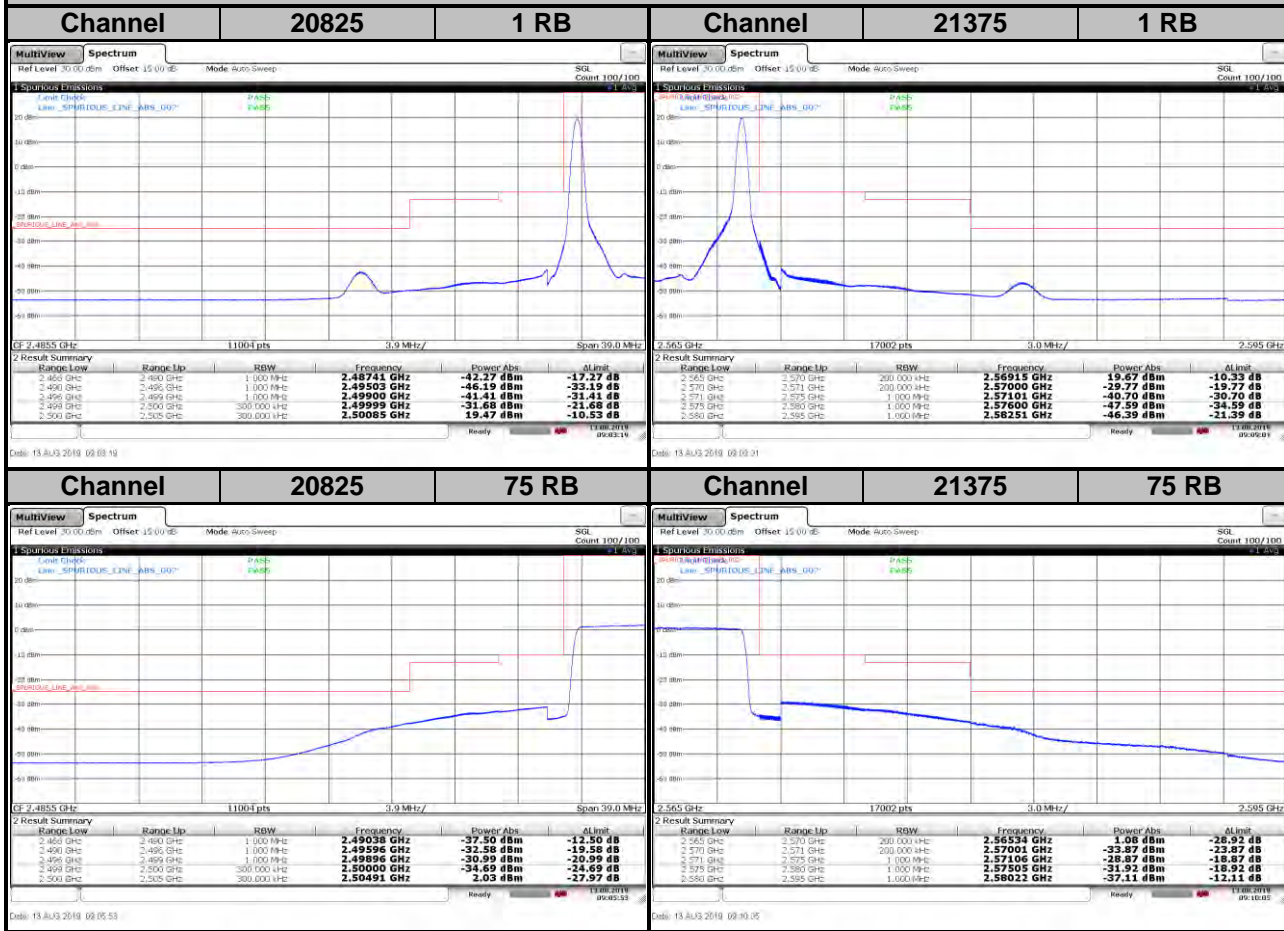

LTE Band 7

Channel Bandwidth: 15 MHz / 64QAM

<Out-of-Band Emissions>

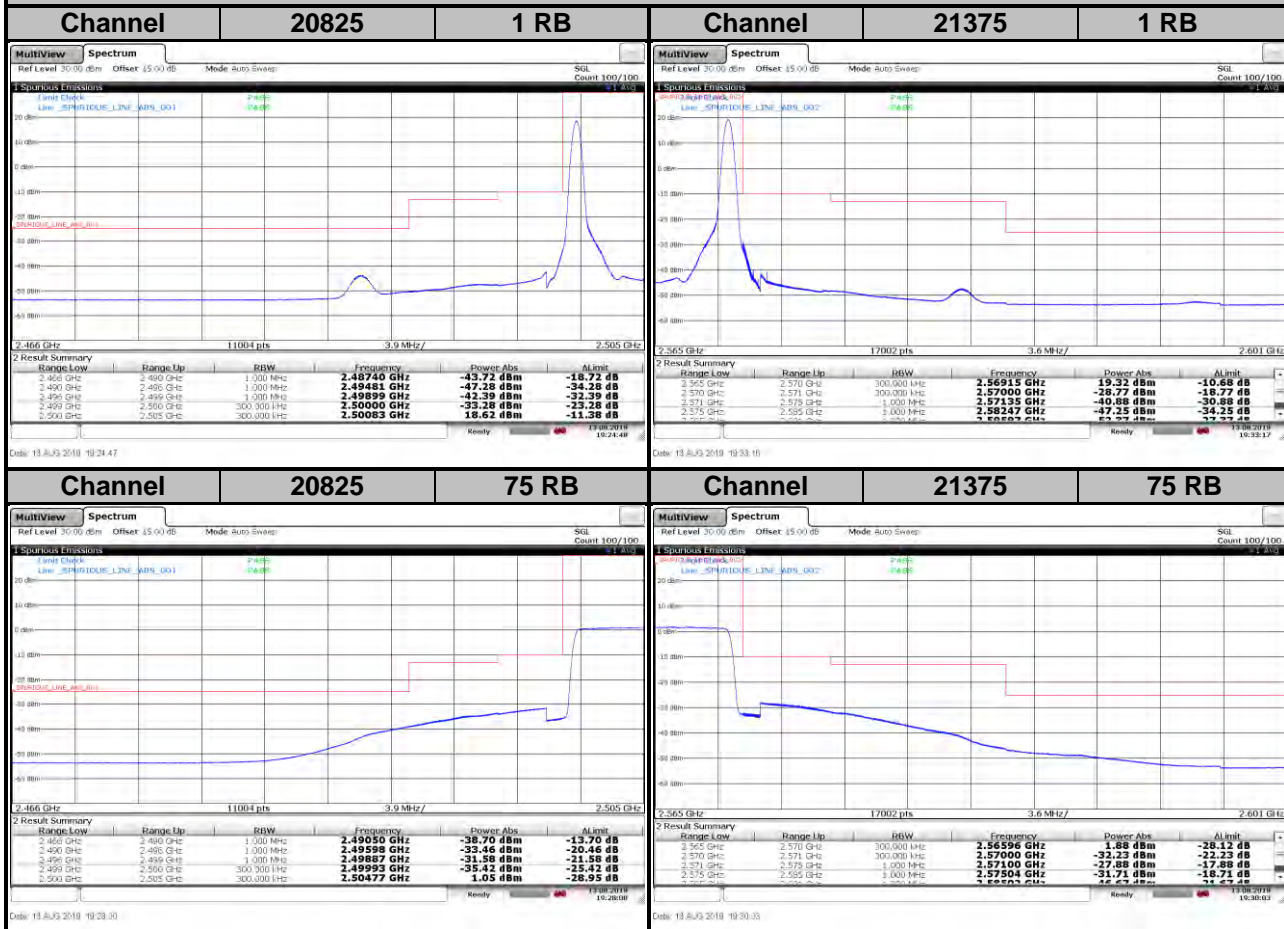

LTE Band 7

Channel Bandwidth: 20 MHz / QPSK

<Out-of-Band Emissions>

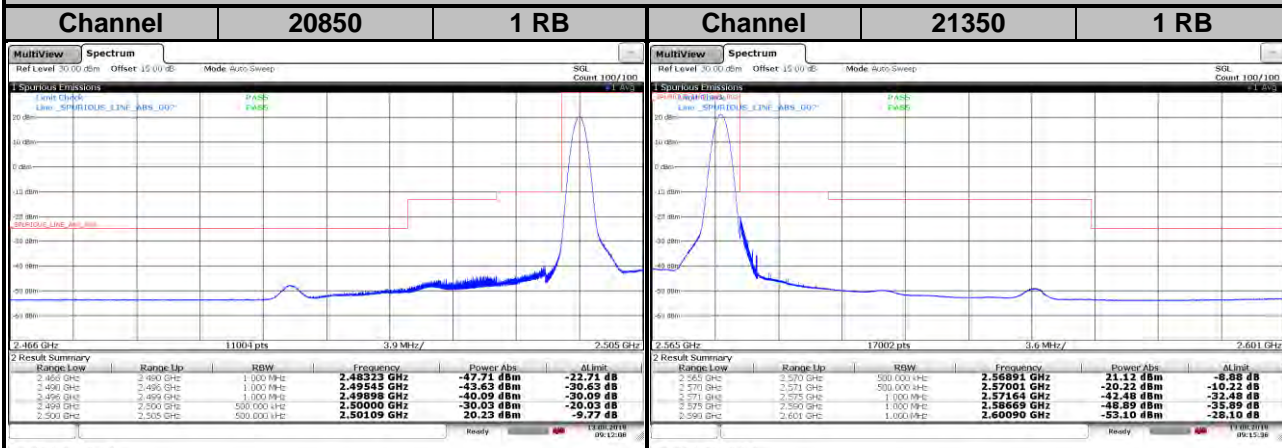

Date: 13.AUG.2019 09:12:39

Date: 13.AUG.2019 09:15:38

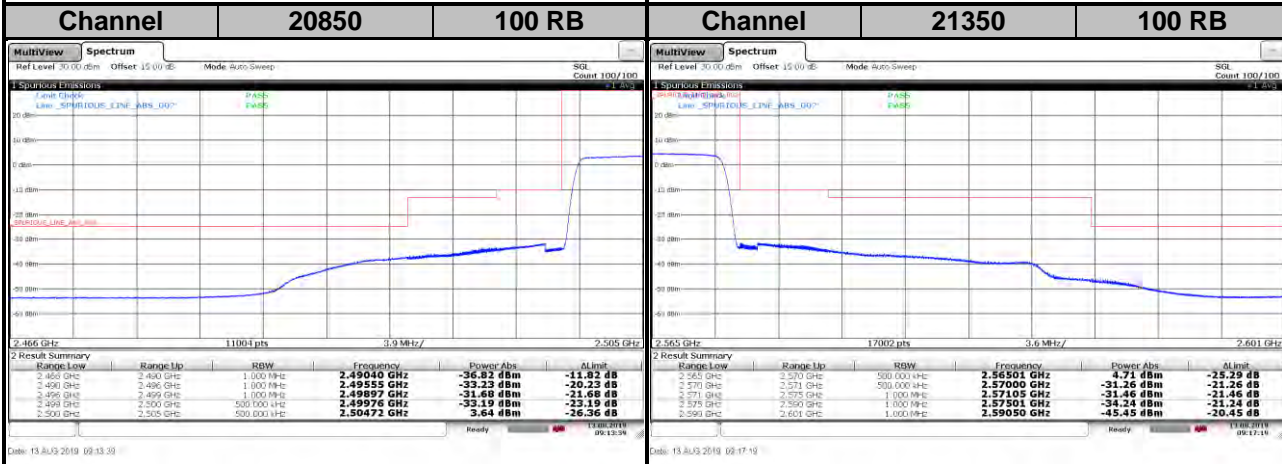

Date: 13.AUG.2019 09:13:39

Date: 13.AUG.2019 09:17:19

LTE Band 7

Channel Bandwidth: 20 MHz / 16QAM

<Out-of-Band Emissions>

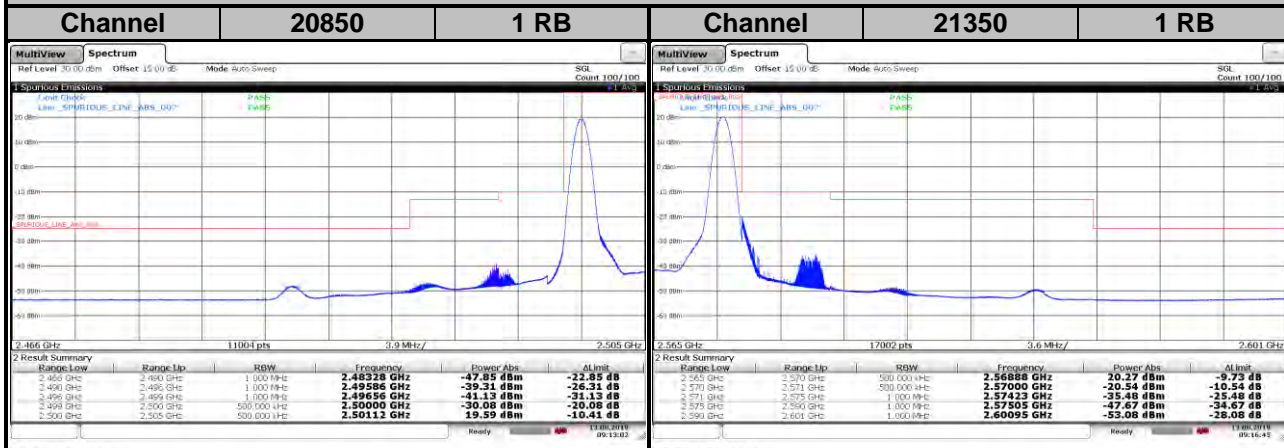

Date: 13.AUG.2018 09:13:02

Date: 13.AUG.2018 09:16:45

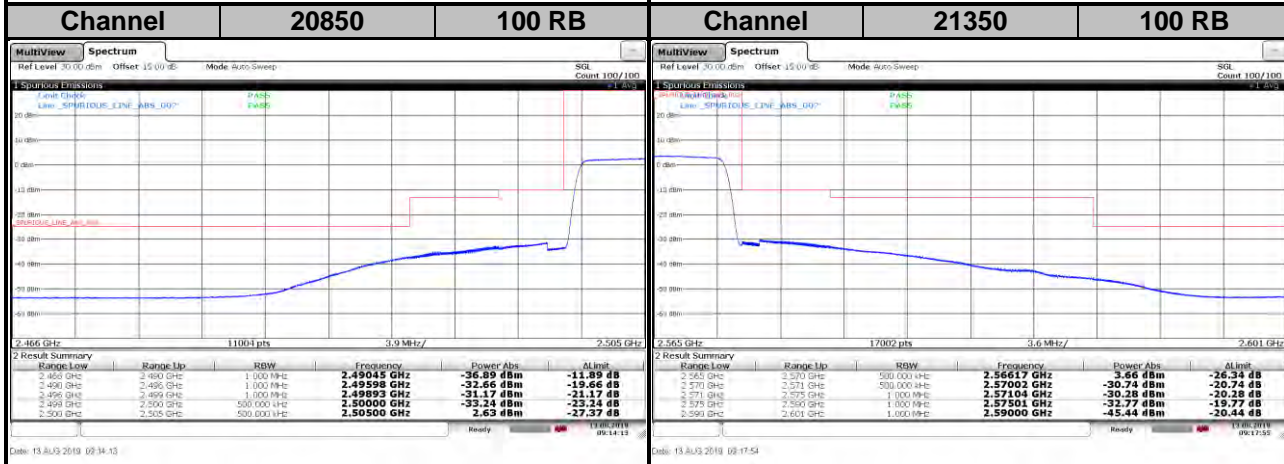

Date: 13.AUG.2018 09:14:13

Date: 13.AUG.2018 09:17:51



**LTE Band 7**  
**Channel Bandwidth: 20 MHz / 64QAM**  
**<Out-of-Band Emissions>**

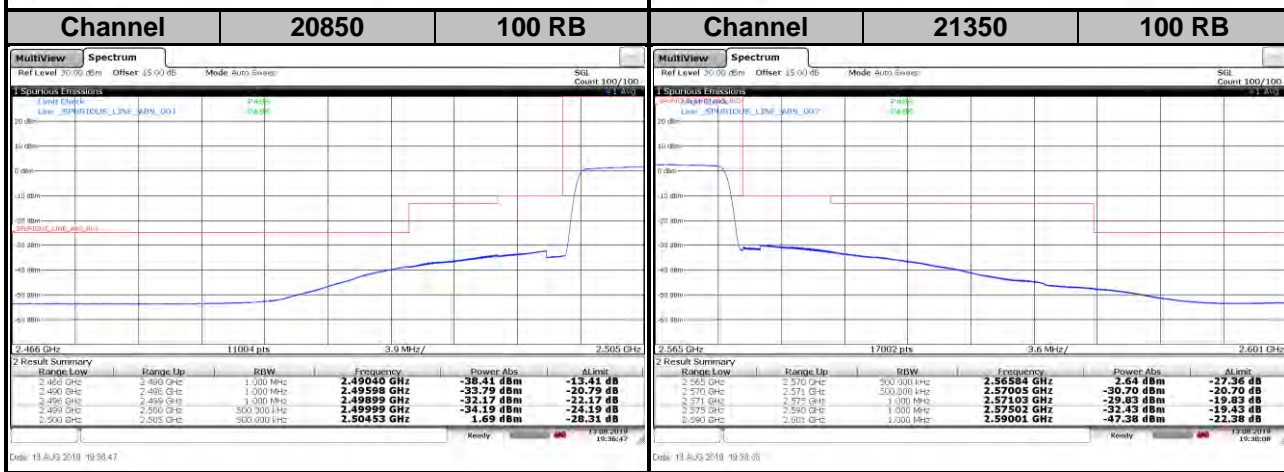
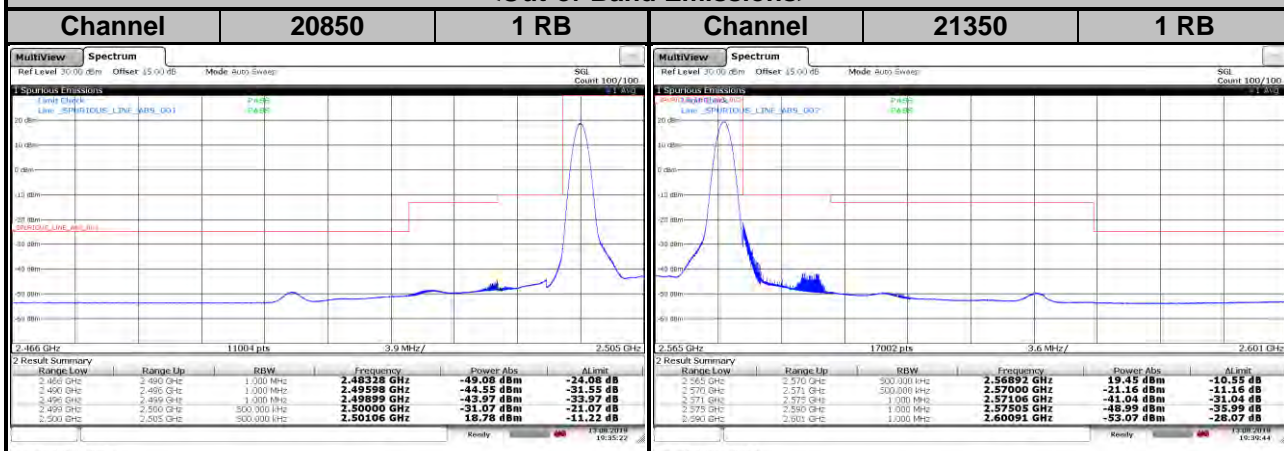

CA Mode

**LTE Band 7**  
**Channel Bandwidth: 20+20 MHz / QPSK**  
**<Out-of-Band Emissions>**

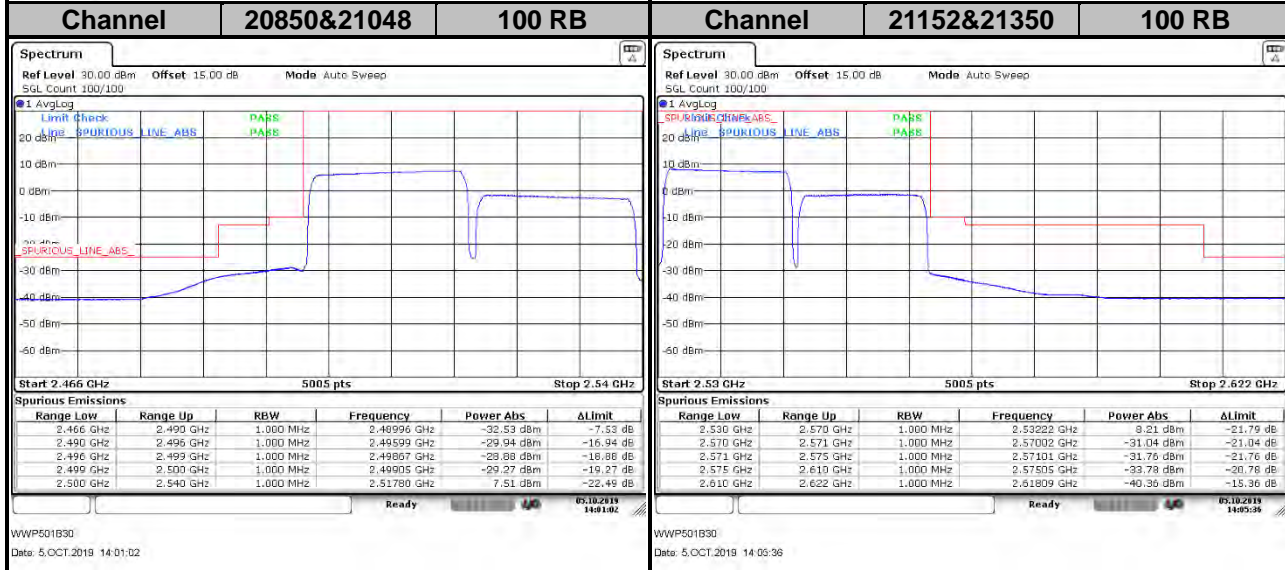
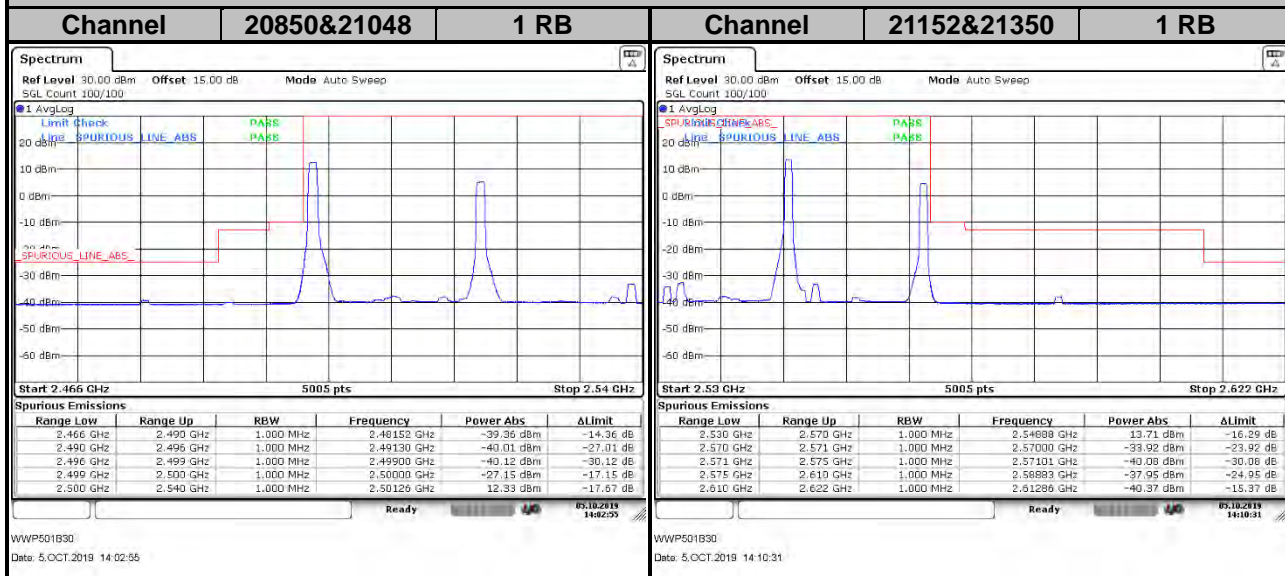

**LTE Band 38**  
**Channel Bandwidth: 5 MHz / QPSK**

**<Out-of-Band Emissions>**

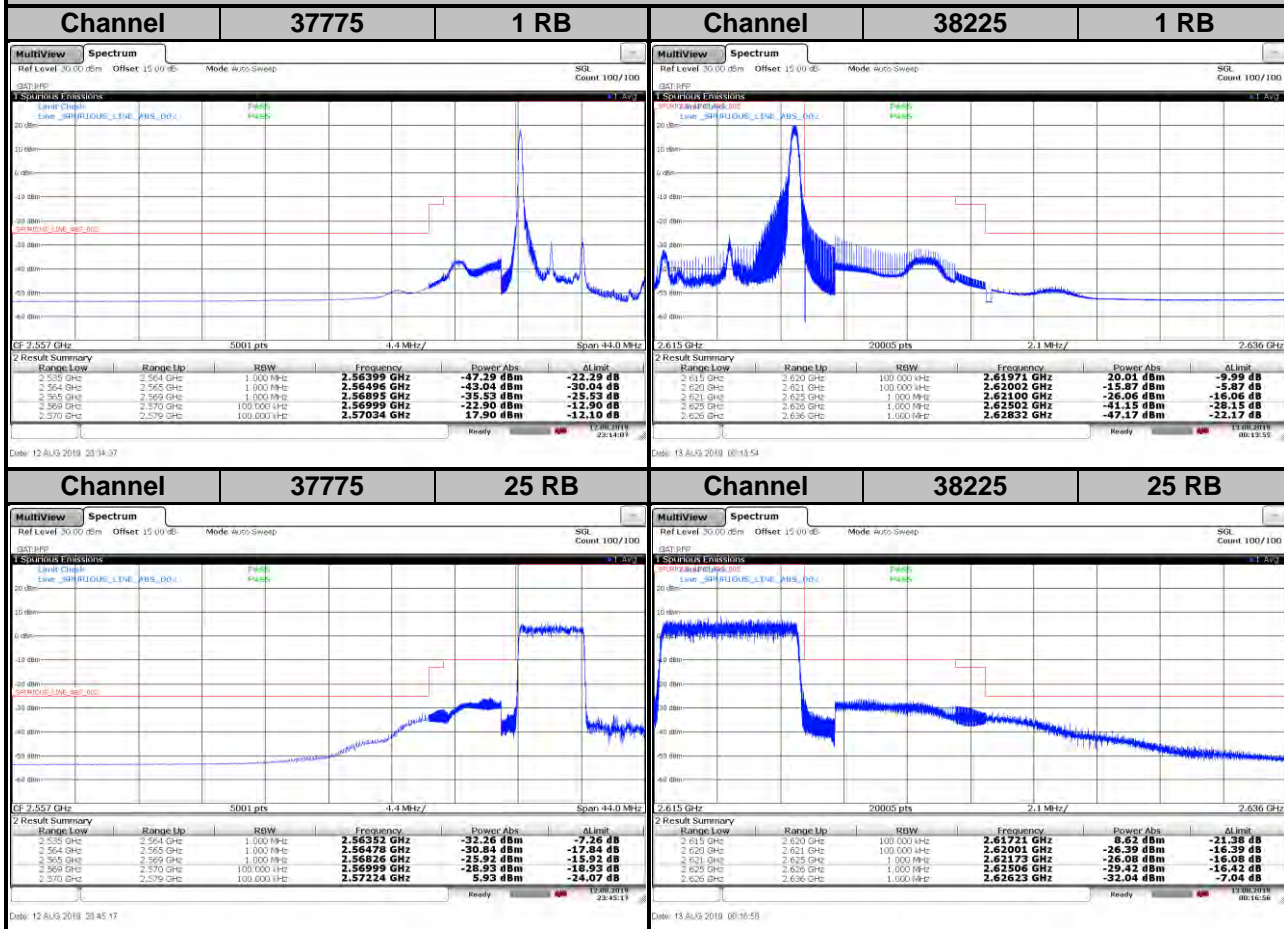



LTE Band 38

Channel Bandwidth: 5 MHz / 16QAM

<Out-of-Band Emissions>

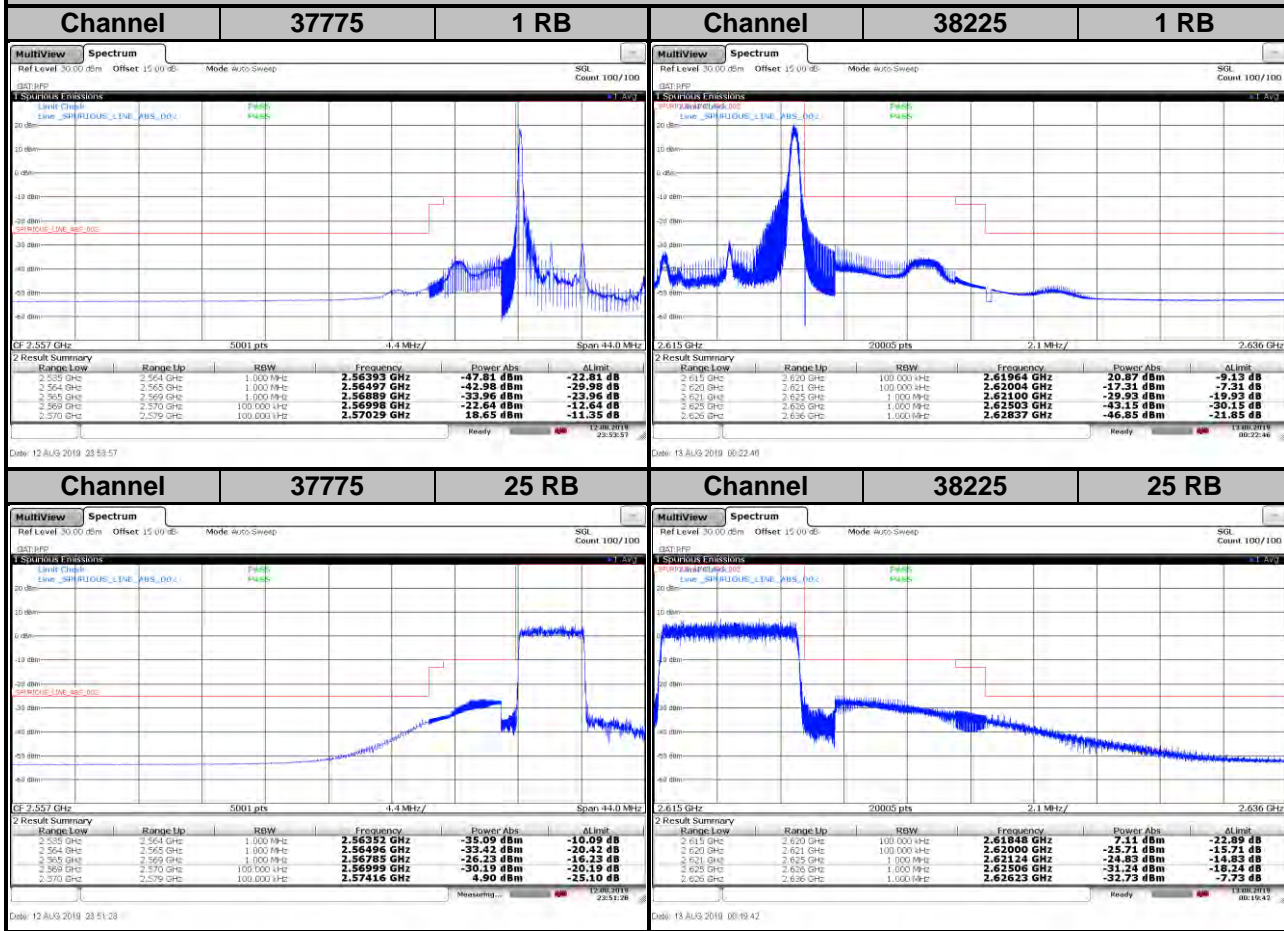

**LTE Band 38**  
**Channel Bandwidth: 5 MHz / 64QAM**

**<Out-of-Band Emissions>**

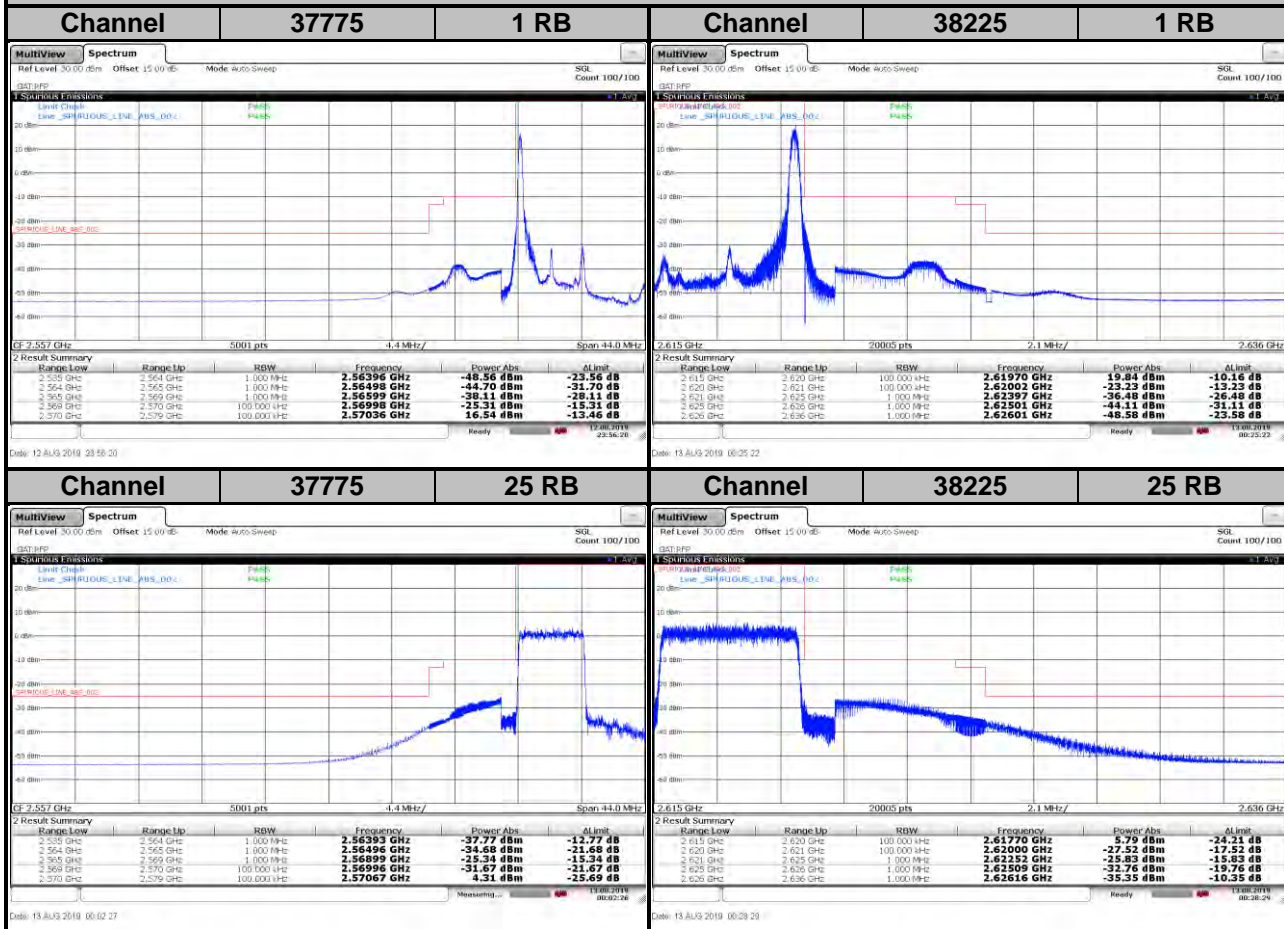

**LTE Band 38**  
**Channel Bandwidth: 10 MHz / QPSK**

**<Out-of-Band Emissions>**

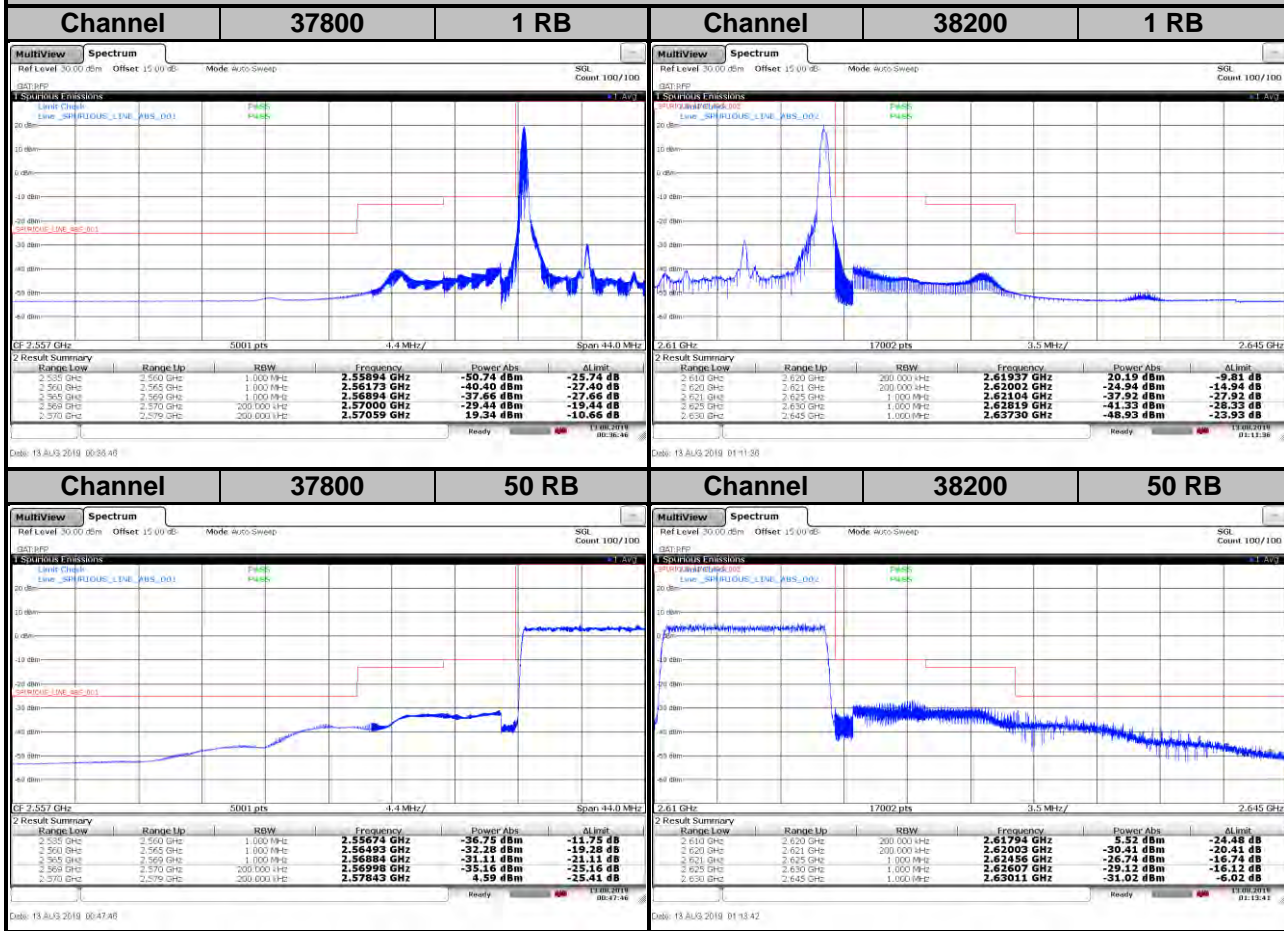



**LTE Band 38**  
**Channel Bandwidth: 10 MHz / 16QAM**

**<Out-of-Band Emissions>**

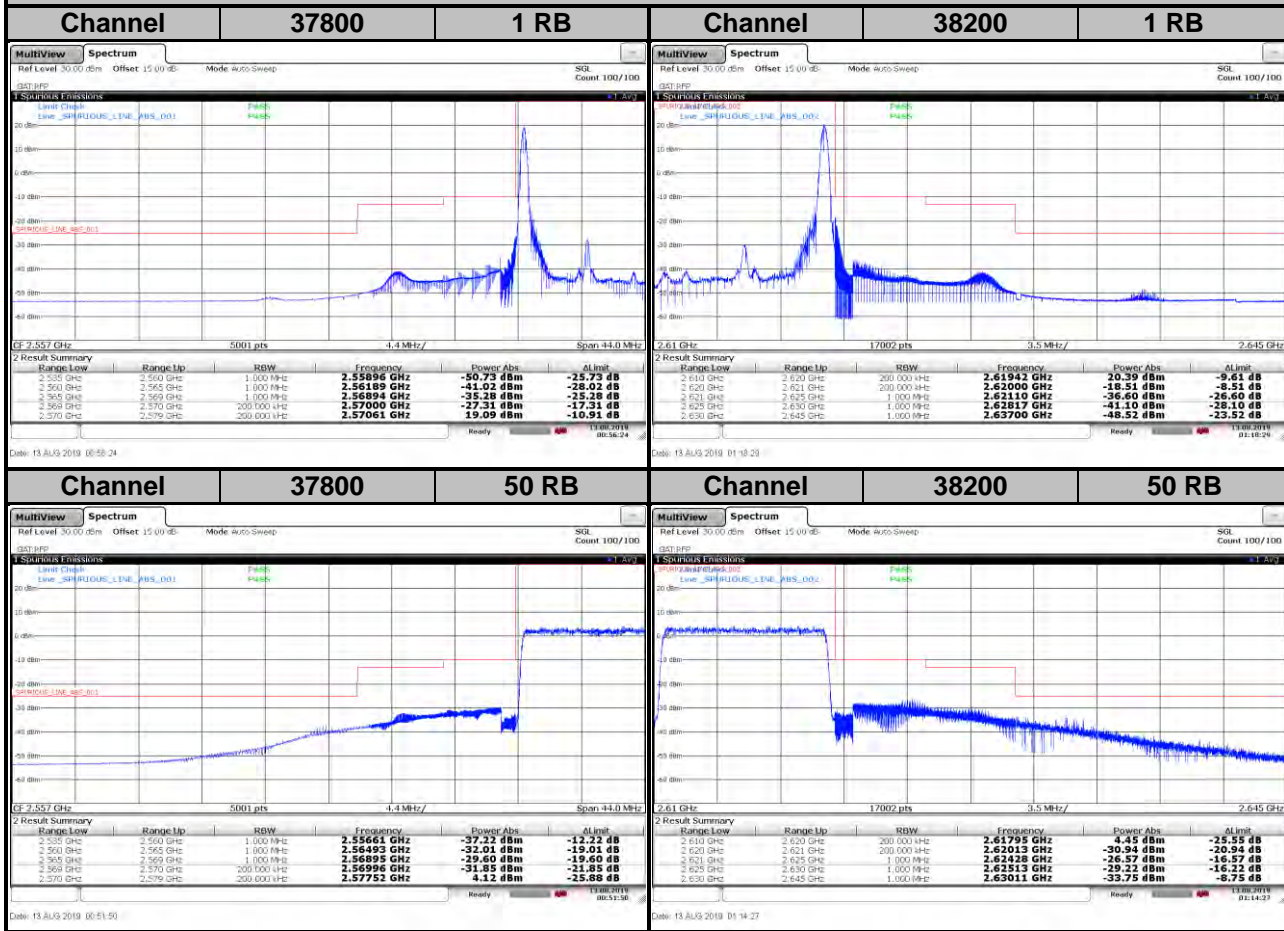

**LTE Band 38**  
**Channel Bandwidth: 10 MHz / 64QAM**

**<Out-of-Band Emissions>**

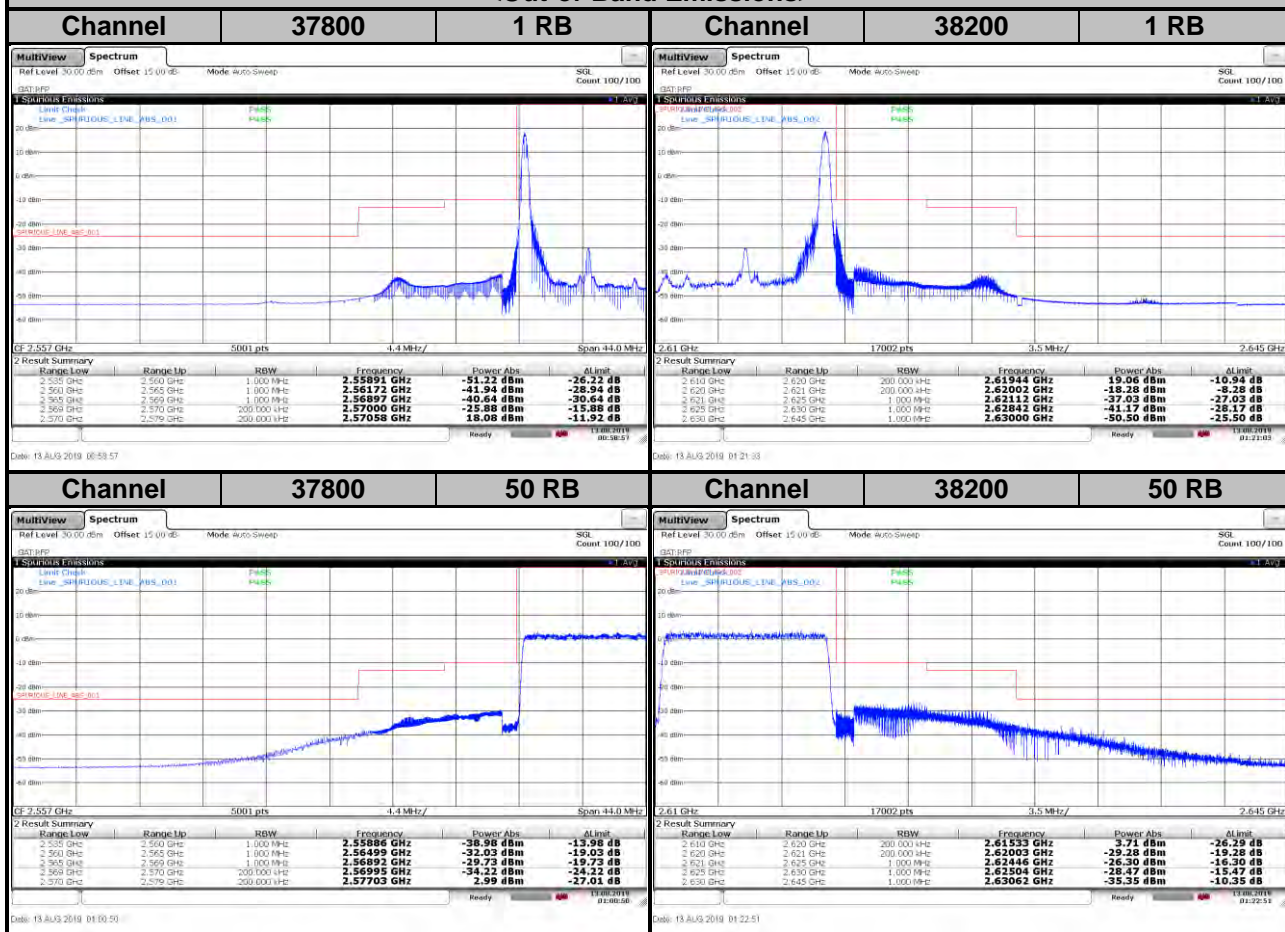



**LTE Band 38**  
**Channel Bandwidth: 15 MHz / QPSK**

**<Out-of-Band Emissions>**

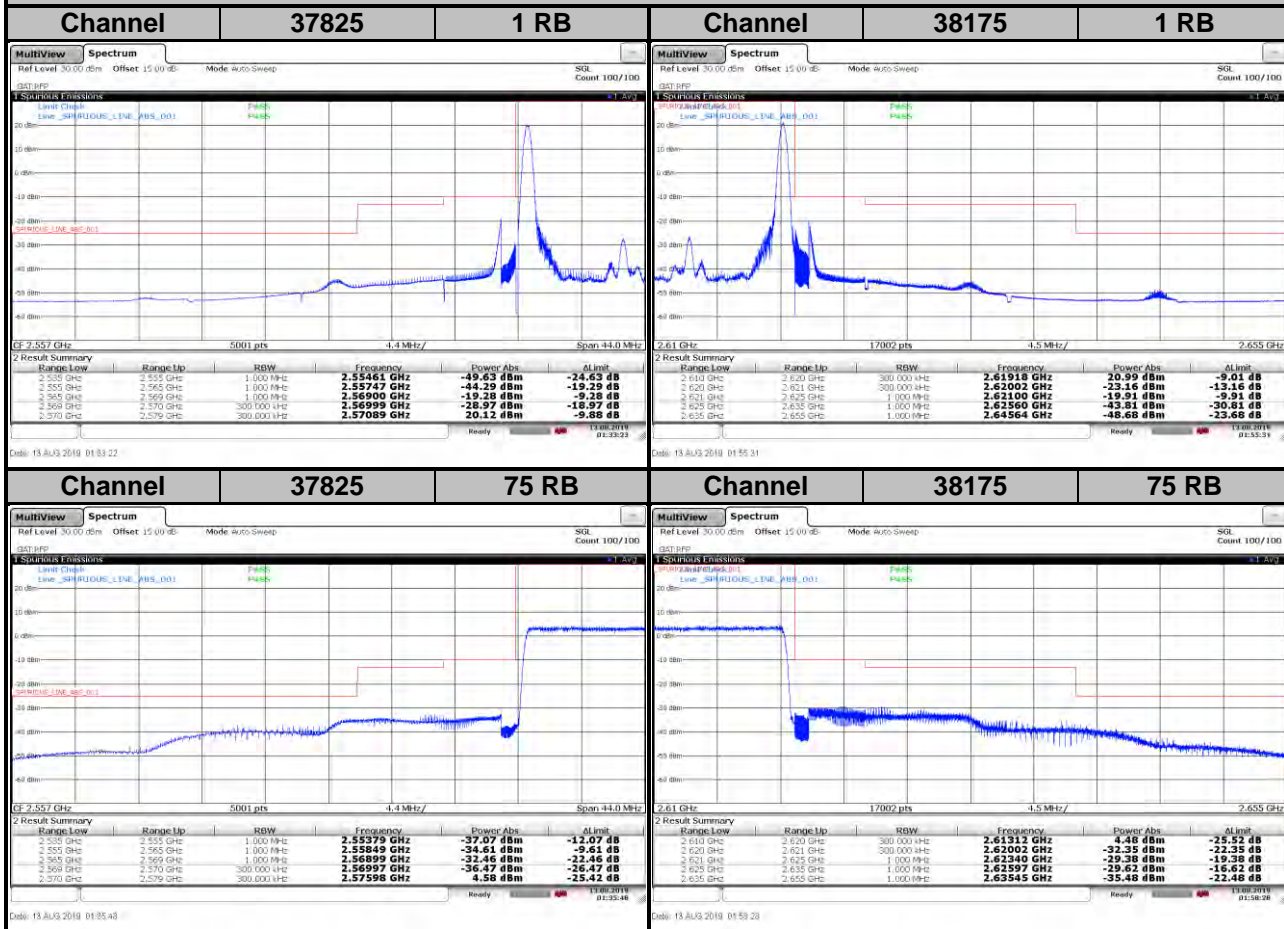

**LTE Band 38**  
**Channel Bandwidth: 15 MHz / 16QAM**

**<Out-of-Band Emissions>**

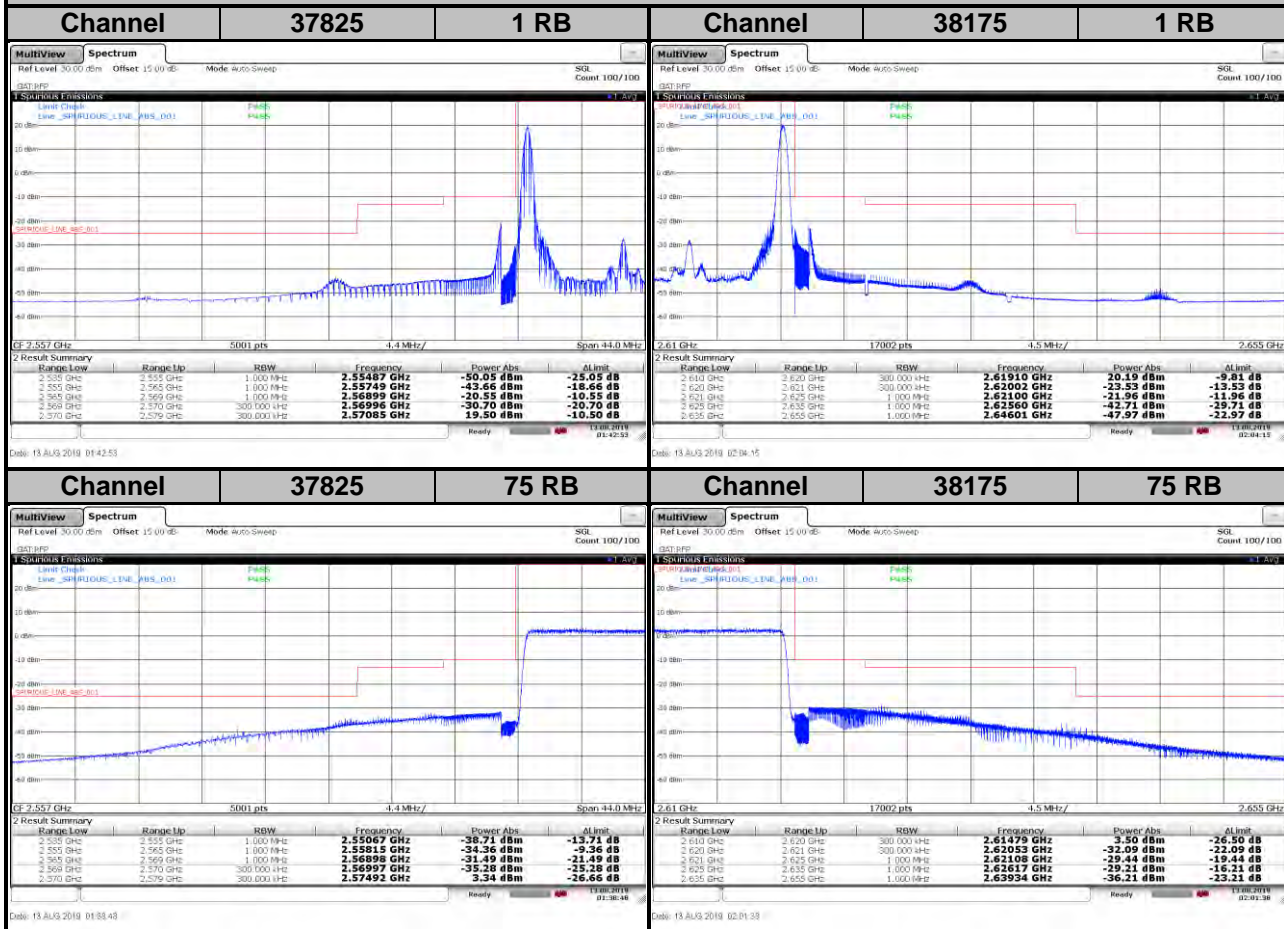

**LTE Band 38**  
**Channel Bandwidth: 15 MHz / 64QAM**

**<Out-of-Band Emissions>**

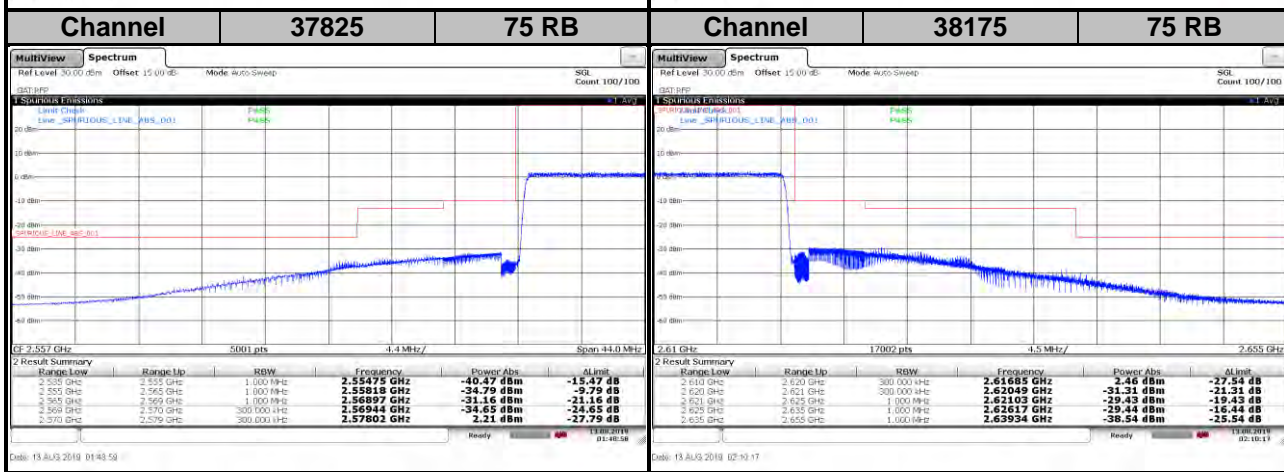
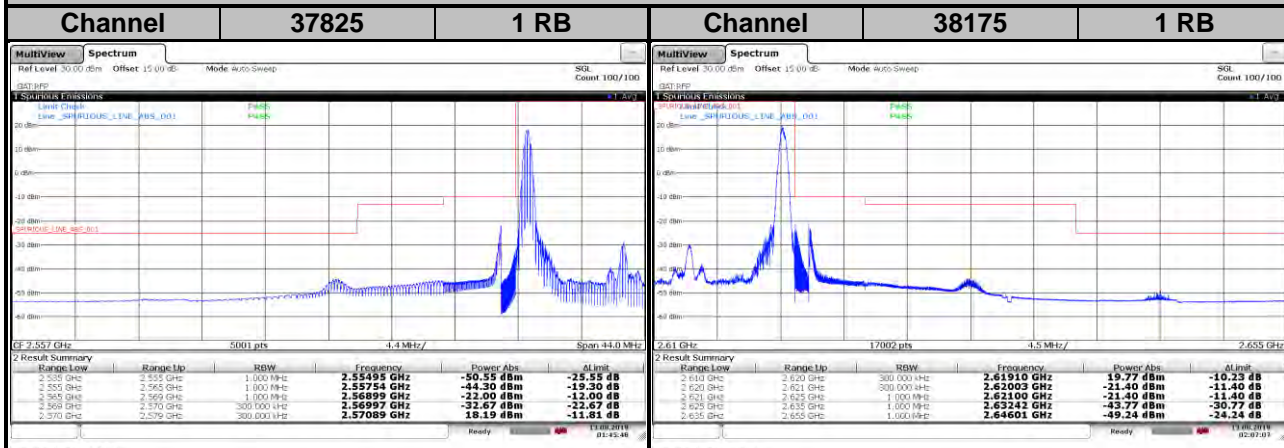

**LTE Band 38**  
**Channel Bandwidth: 20 MHz / QPSK**

**<Out-of-Band Emissions>**

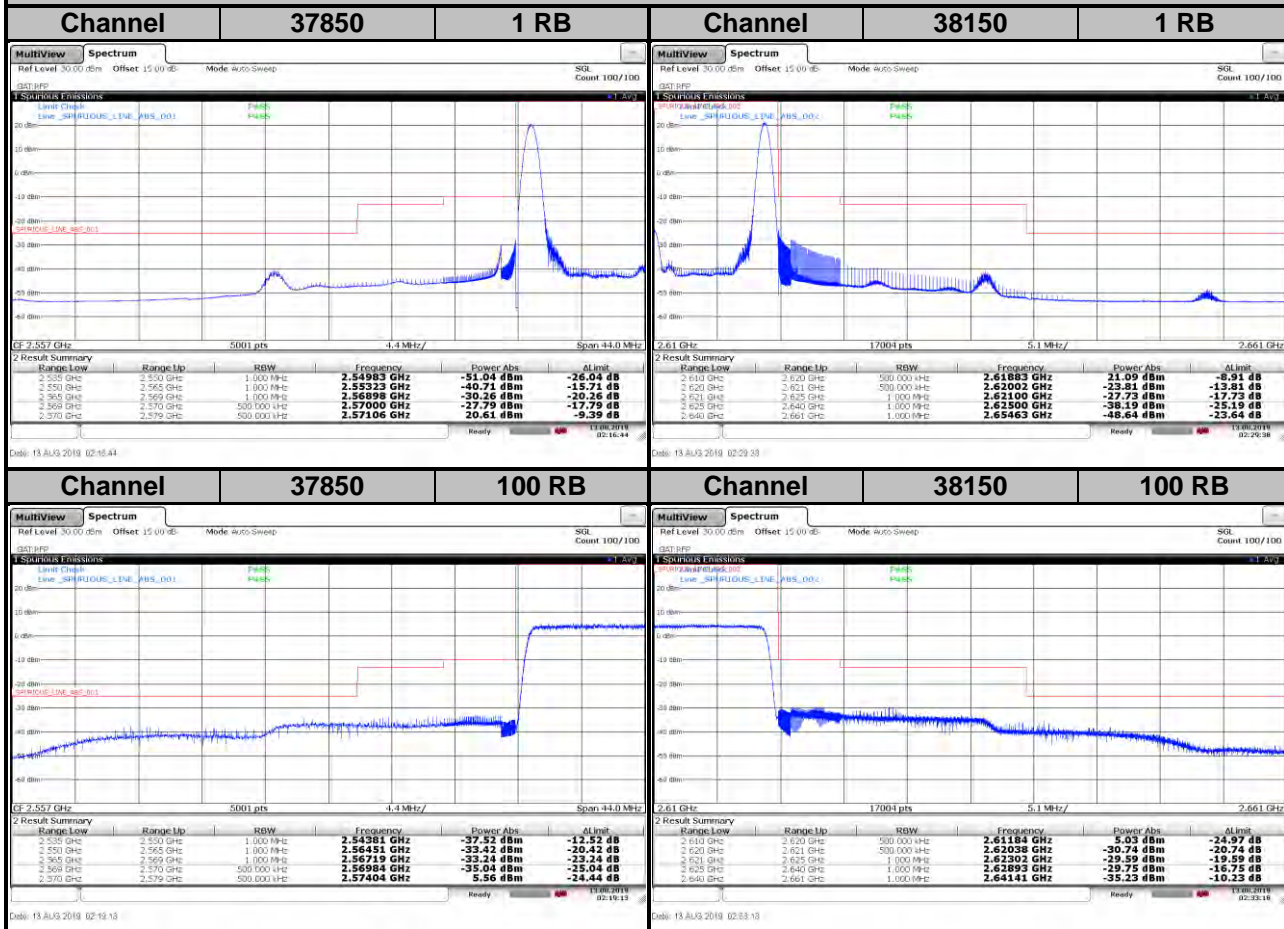



**LTE Band 38**  
**Channel Bandwidth: 20 MHz / 16QAM**

**<Out-of-Band Emissions>**

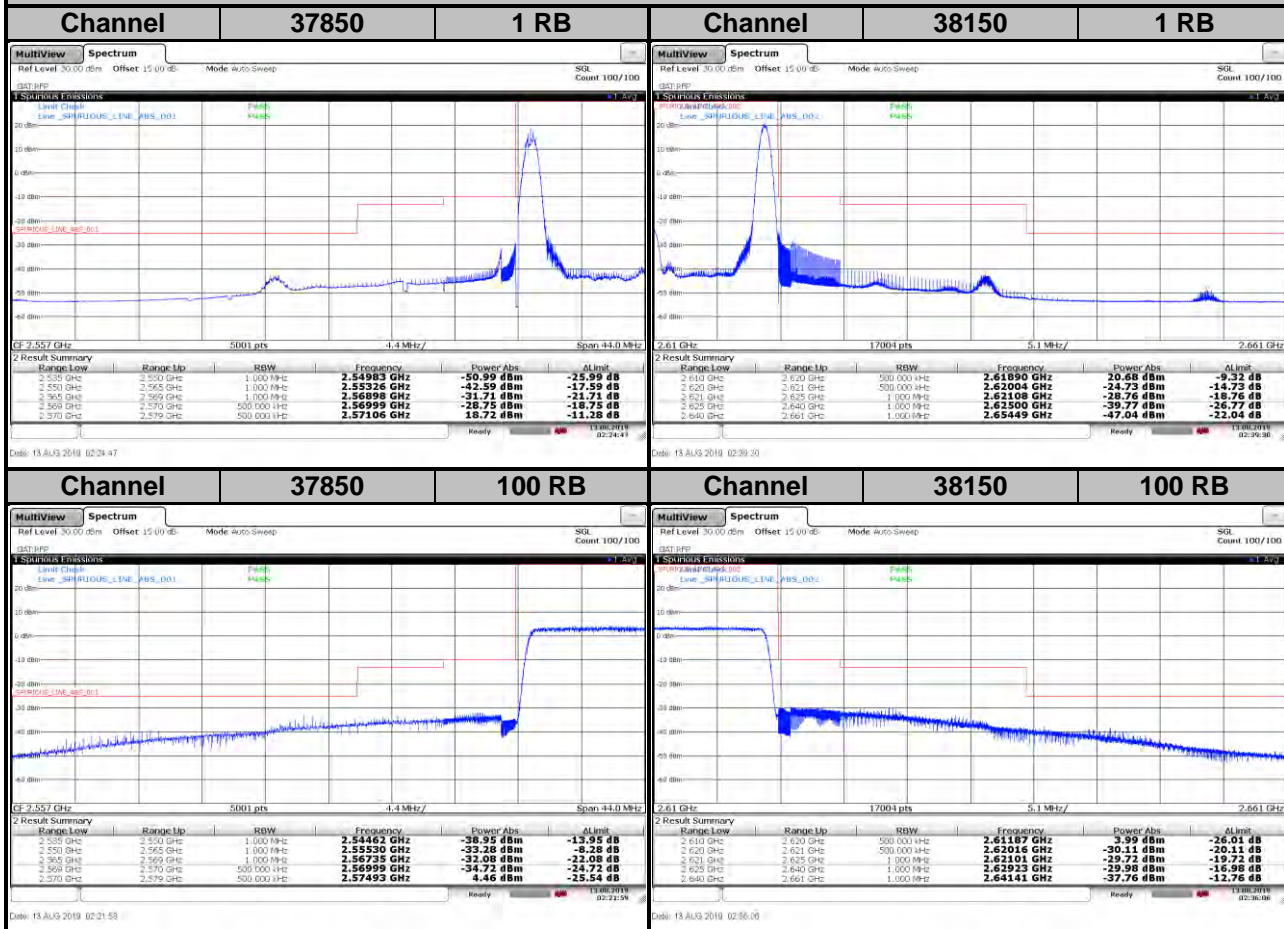

**LTE Band 38**  
**Channel Bandwidth: 20 MHz / 64QAM**

**<Out-of-Band Emissions>**

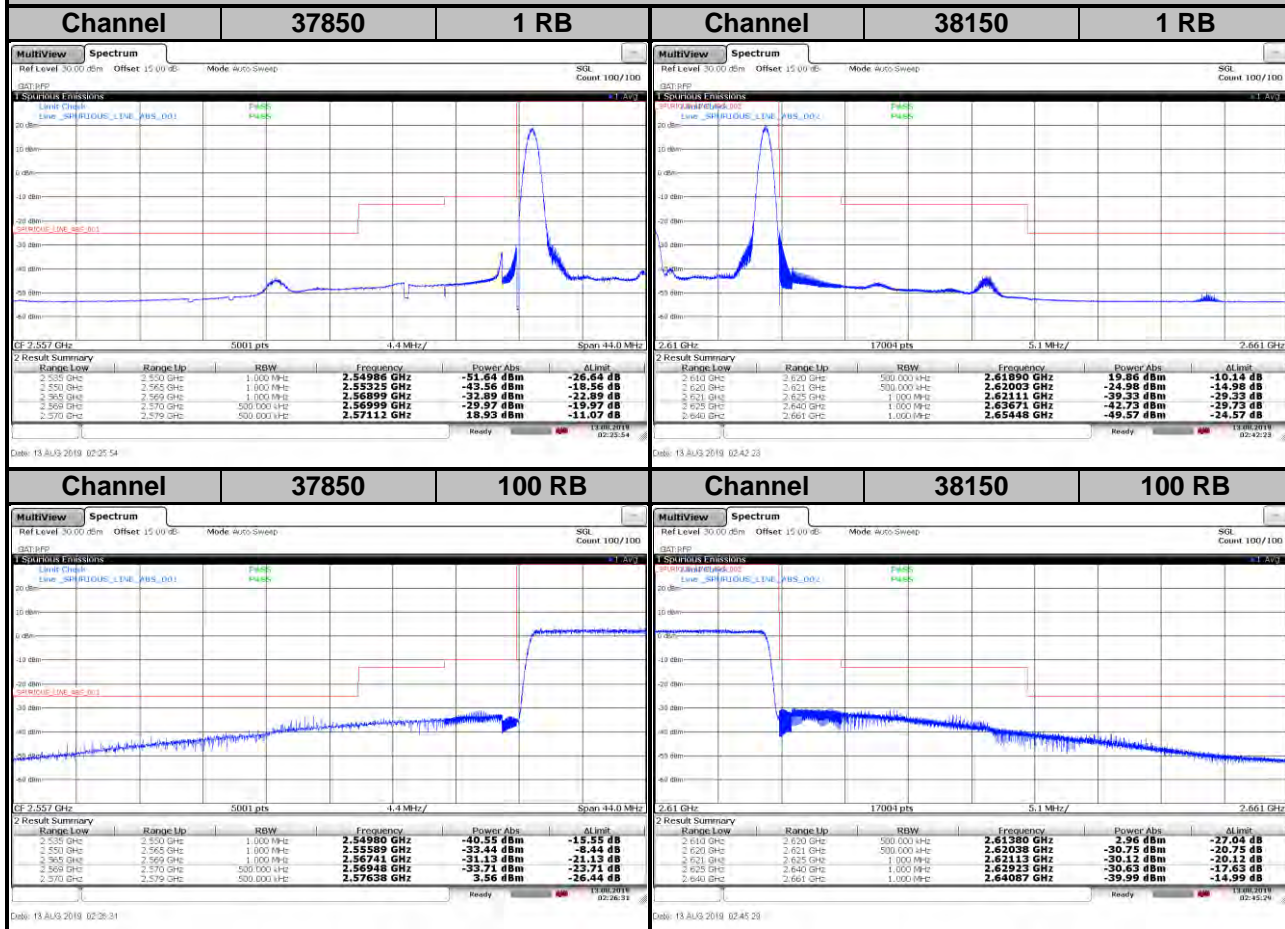

CA Mode

**LTE Band 38**  
**Channel Bandwidth: 20+20 MHz / QPSK**  
**<Out-of-Band Emissions>**

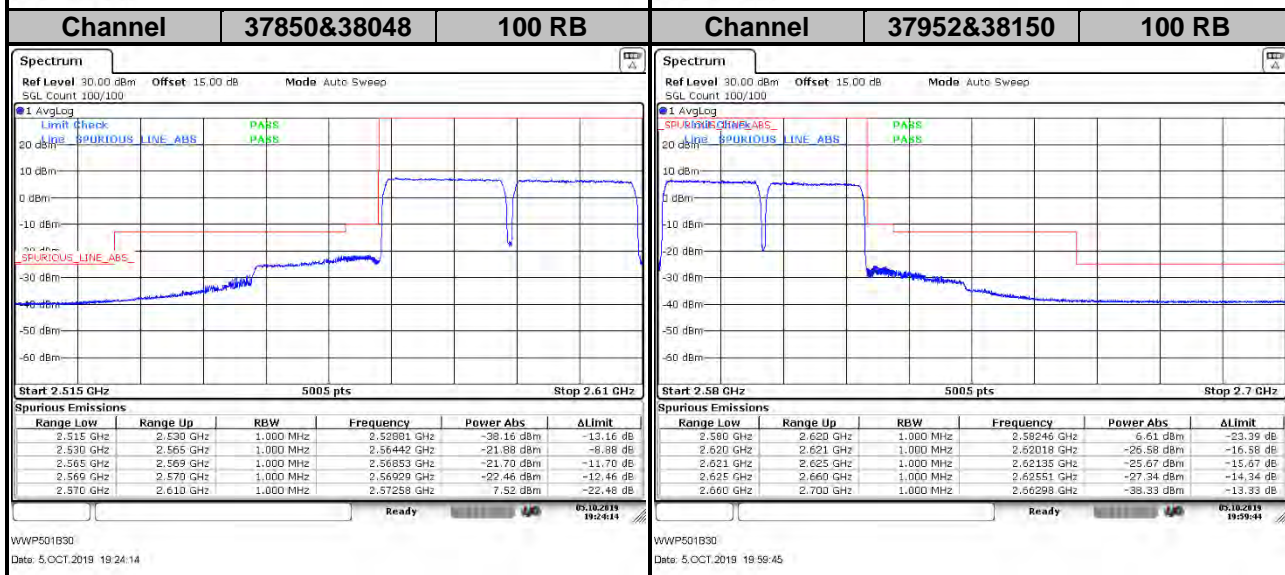
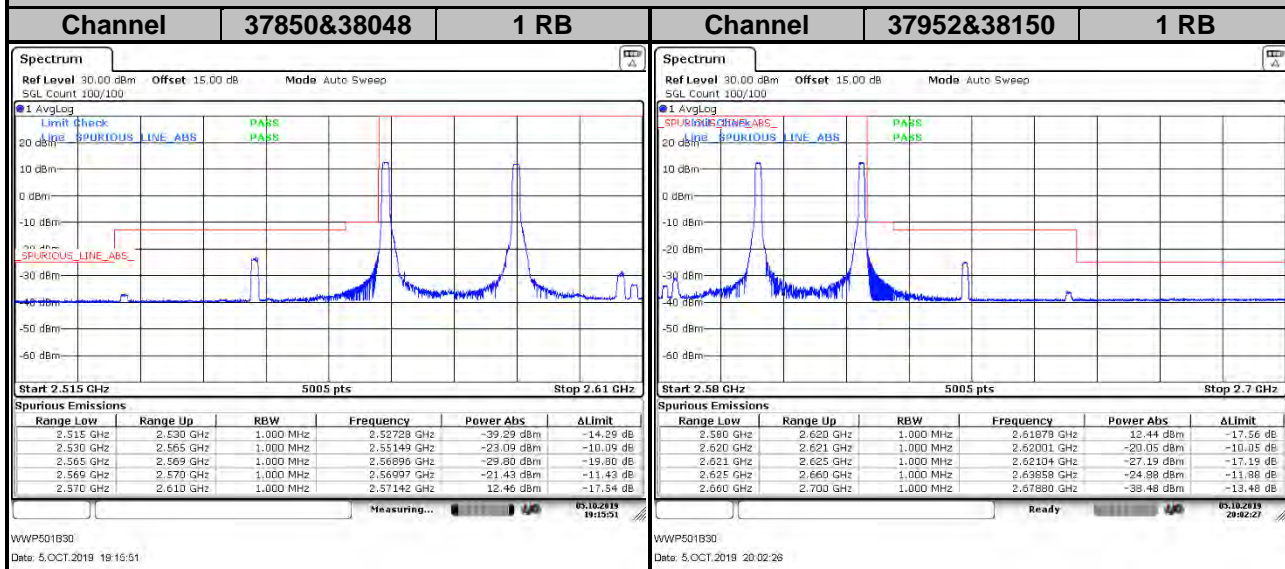



## 4.6 Peak to Average Ratio

### 4.6.1 Limits of Peak to Average Ratio Measurement

In measuring transmissions in this band using an average power technique, the peak to-average ratio (PAR) of the transmission may not exceed 13 dB.

### 4.6.2 Test Setup

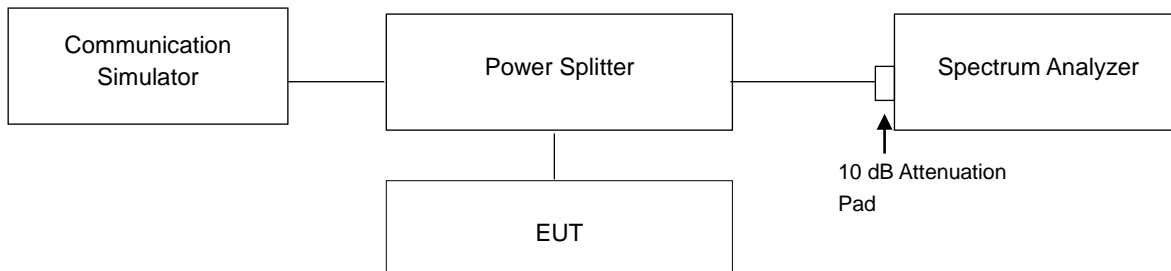

### 4.6.3 Test Procedures

1. Set resolution/measurement bandwidth  $\geq$  signal's occupied bandwidth;
2. Set the number of counts to a value that stabilizes the measured CCDF curve;
3. Record the maximum PAPR level associated with a probability of 0.1 %.

#### 4.6.4 Test Results

LTE Band 7									
Channel Bandwidth: 5 MHz					Channel Bandwidth: 10 MHz				
Channel	Frequency (MHz)	Peak to Average Ratio (dB)			Channel	Frequency (MHz)	Peak to Average Ratio (dB)		
		QPSK	16QAM	64QAM			QPSK	16QAM	64QAM
20775	2502.5	5.17	6.16	6.52	20800	2505.0	5.17	6.16	6.51
21100	2535.0	5.44	6.52	6.54	21100	2535.0	5.38	6.53	6.39
21425	2567.5	5.03	5.99	6.35	21400	2565.0	4.97	5.85	6.45

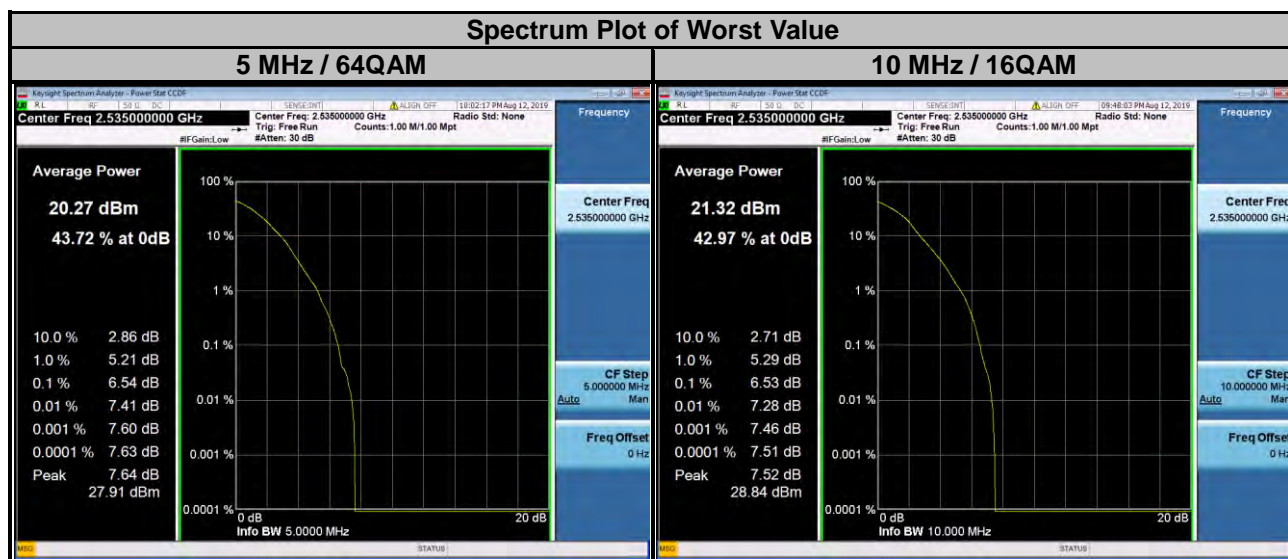

LTE Band 7									
Channel Bandwidth: 15 MHz					Channel Bandwidth: 20 MHz				
Channel	Frequency (MHz)	Peak to Average Ratio (dB)			Channel	Frequency (MHz)	Peak to Average Ratio (dB)		
		QPSK	16QAM	64QAM			QPSK	16QAM	64QAM
20825	2507.5	5.22	6.21	6.50	20850	2510.0	5.24	6.19	6.48
21100	2535.0	5.28	6.59	6.34	21100	2535.0	5.31	6.23	6.37
21375	2562.5	5.12	5.95	6.40	21350	2560.0	5.29	6.25	6.80

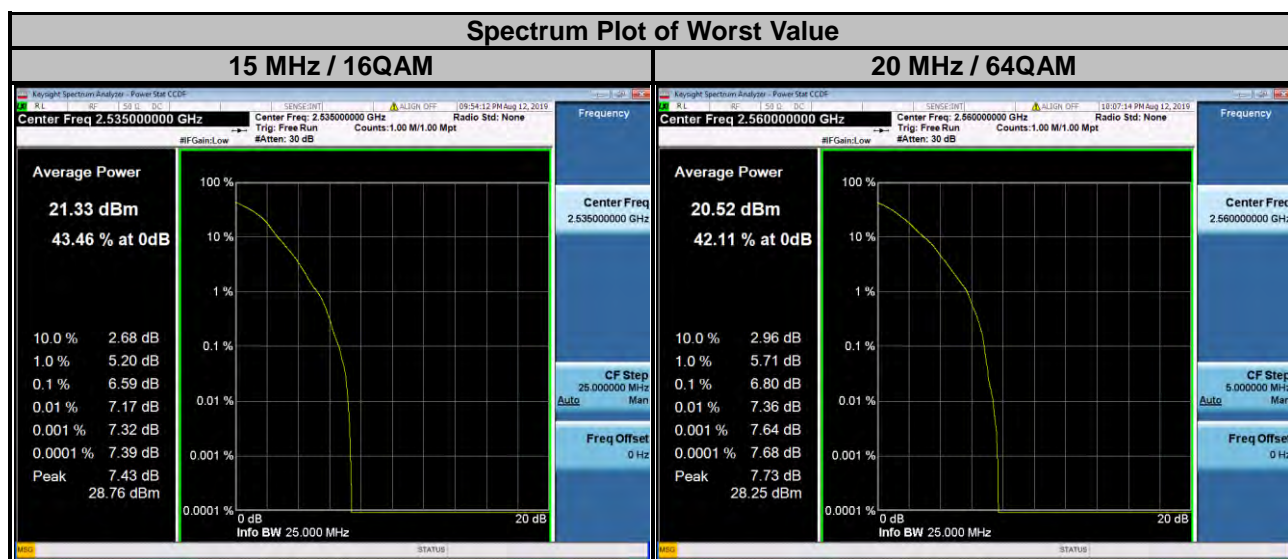

### CA Mode

LTE Band 7			
Low Channel			
Channel	Frequency (MHz)	Mode	Peak to Average Ratio (dB)
			QPSK
20850	2510	1 RB / 0RB Offset	4.97
21480	2529.8	1 RB / 99RB Offset	4.96
20850	2510	1 RB / 99RB Offset	6.40
21480	2529.8	1 RB / 0RB Offset	6.43

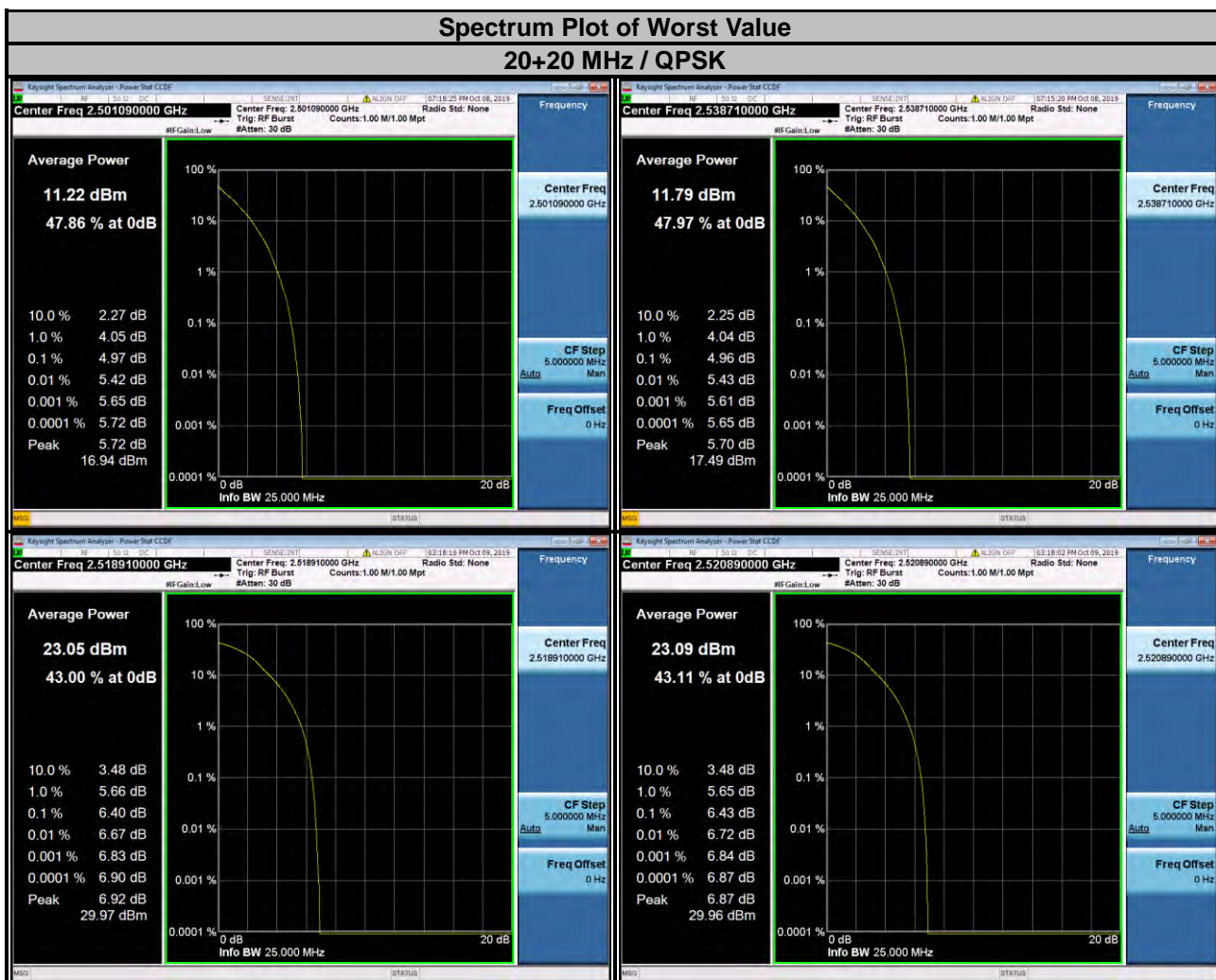

LTE Band 7			
Middle Channel			
Channel	Frequency (MHz)	Mode	Peak to Average Ratio (dB)
			QPSK
21001	2525.1	1 RB / 0RB Offset	4.61
21199	2544.9	1 RB / 99RB Offset	4.62
21001	2525.1	1 RB / 99RB Offset	6.66
21199	2544.9	1 RB / 0RB Offset	6.64

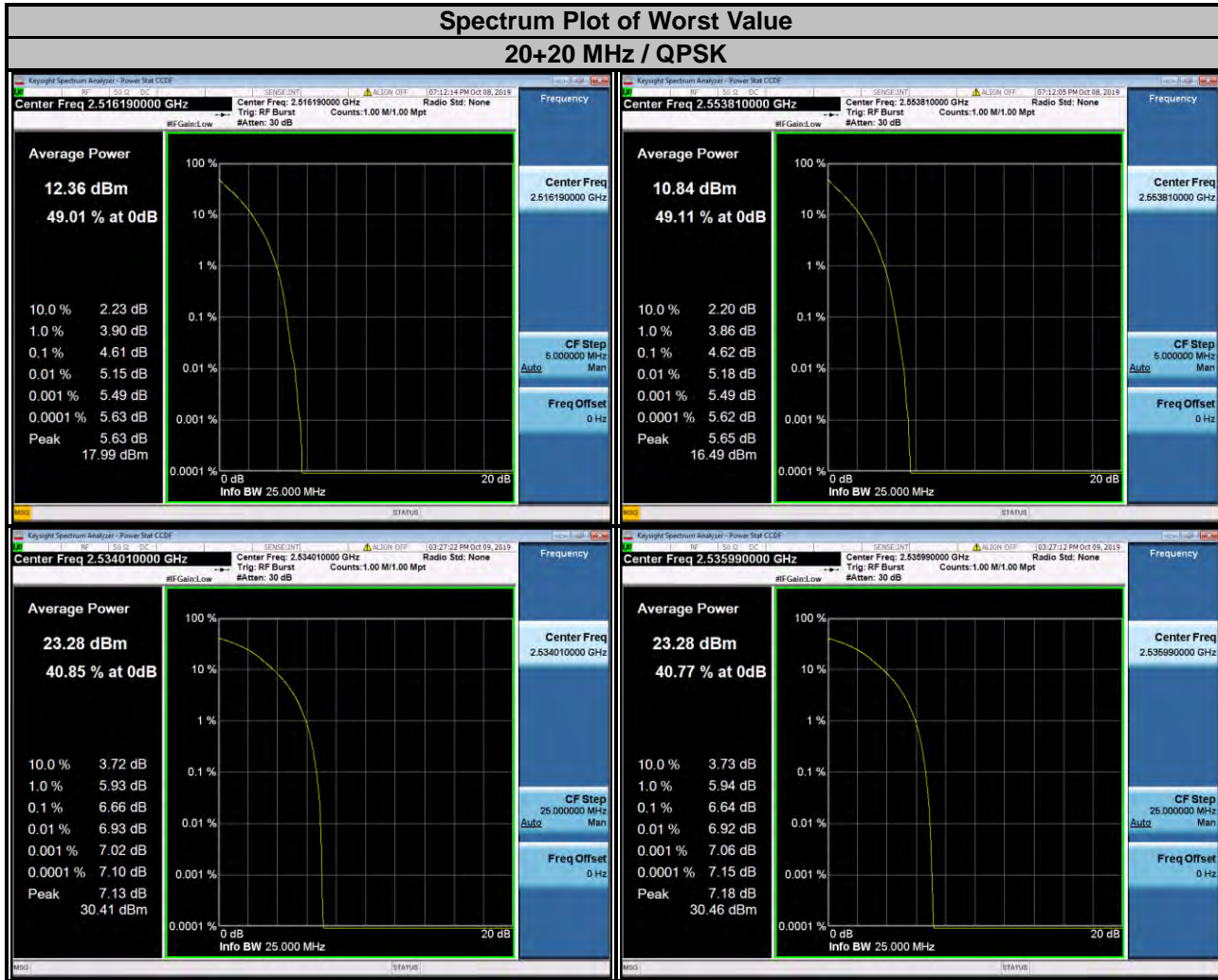



LTE Band 7			
High Channel			
Channel	Frequency (MHz)	Mode	Peak to Average Ratio (dB)
			QPSK
21152	2540.2	1 RB / 0RB Offset	4.87
21350	2560	1 RB / 99RB Offset	4.81
21152	2540.2	1 RB / 99RB Offset	6.30
21350	2560	1 RB / 0RB Offset	6.33

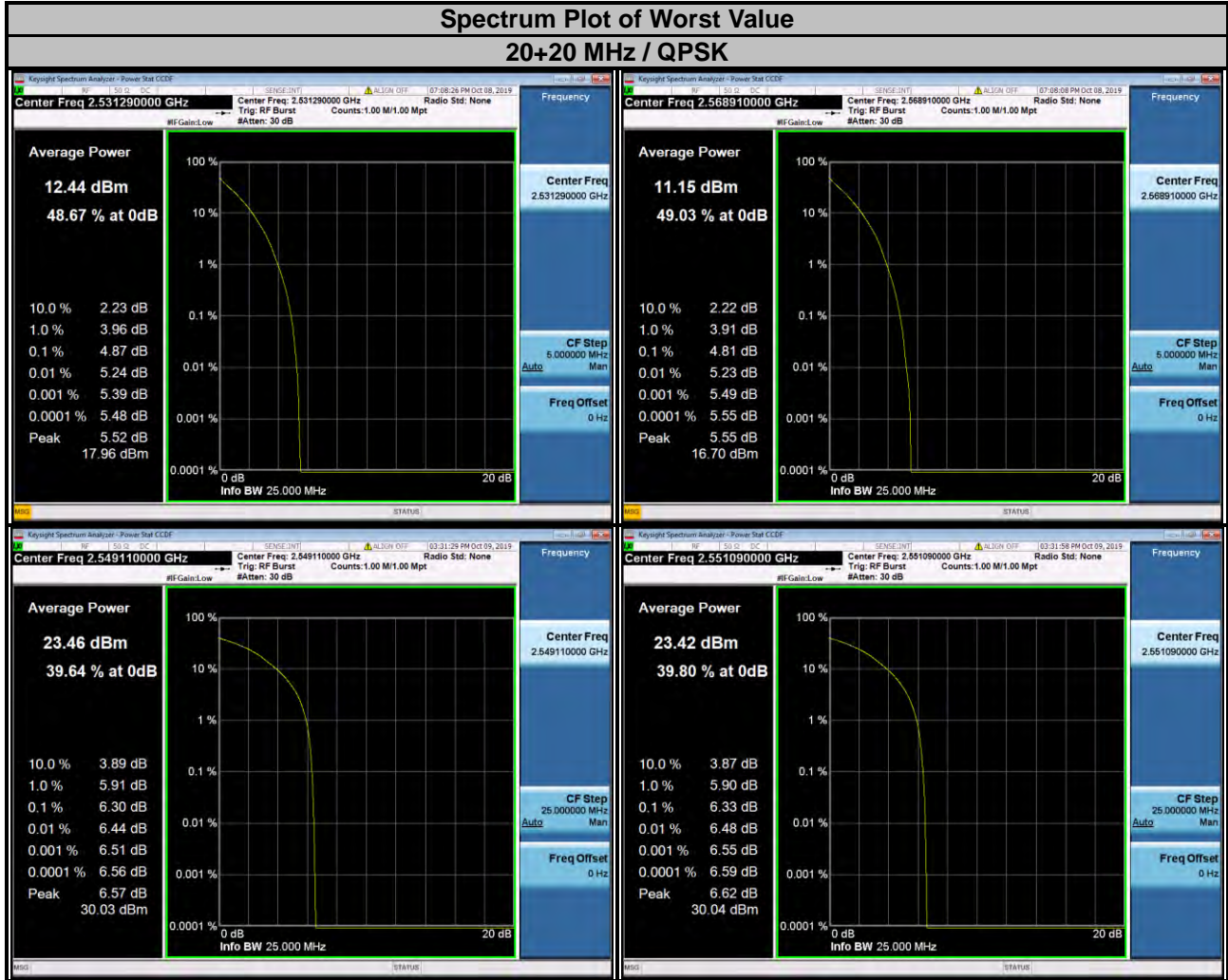

### LTE Band 38

Channel Bandwidth: 5 MHz					Channel Bandwidth: 10 MHz				
Channel	Frequency (MHz)	Peak to Average Ratio (dB)			Channel	Frequency (MHz)	Peak to Average Ratio (dB)		
		QPSK	16QAM	64QAM			QPSK	16QAM	64QAM
37775	2572.5	6.71	7.47	6.69	37800	2575.0	6.58	7.53	6.77
38000	2595.0	6.97	6.80	7.10	38000	2595.0	7.51	7.06	6.77
38225	2617.5	7.77	7.72	7.31	38200	2615.0	6.50	7.87	7.45

### Spectrum Plot of Worst Value

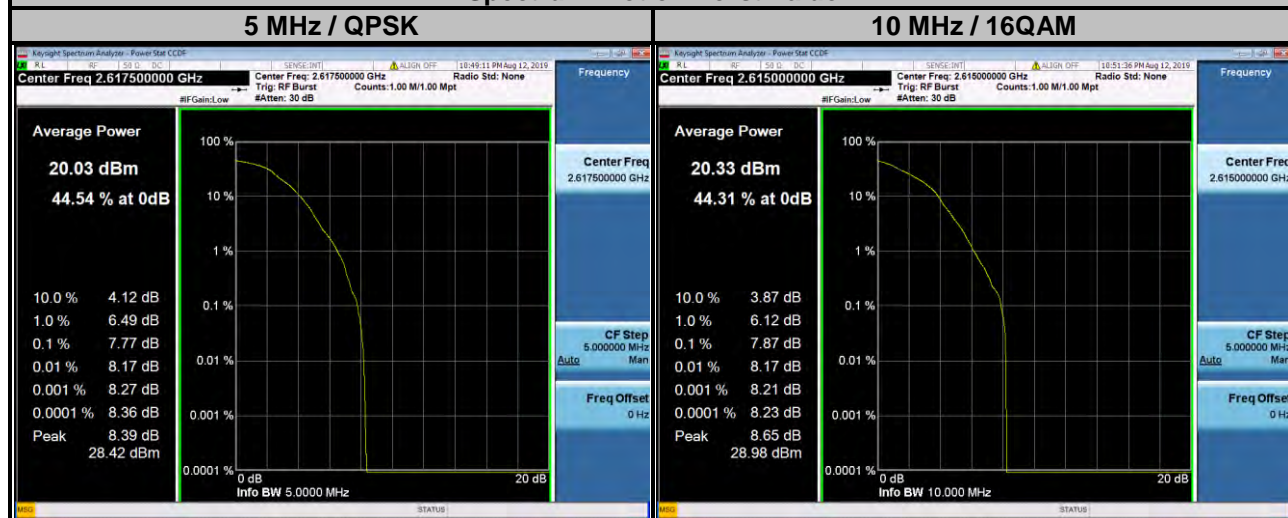



LTE Band 38									
Channel Bandwidth: 15 MHz					Channel Bandwidth: 20 MHz				
Channel	Frequency (MHz)	Peak to Average Ratio (dB)			Channel	Frequency (MHz)	Peak to Average Ratio (dB)		
		QPSK	16QAM	64QAM			QPSK	16QAM	64QAM
37825	2577.5	7.02	7.42	6.88	37850	2580.0	7.28	7.87	7.18
38000	2595.0	7.53	7.73	6.63	38000	2595.0	7.05	7.72	6.64
38175	2612.5	5.93	7.25	6.70	38150	2610.0	6.71	7.68	7.00

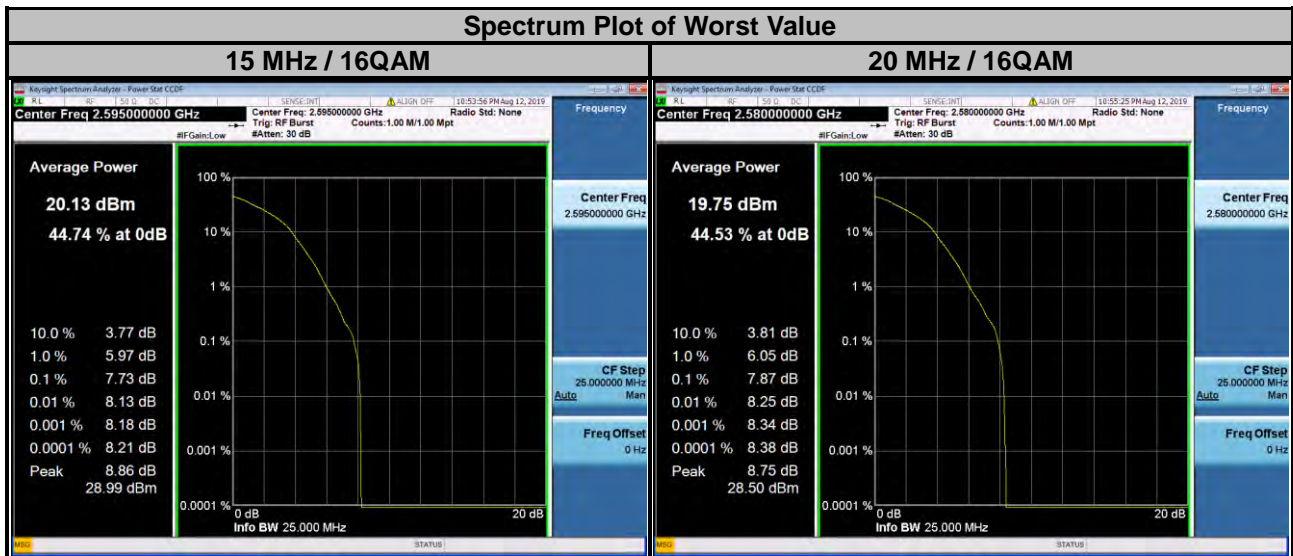

### CA Mode

LTE Band 38			
Low Channel			
Channel	Frequency (MHz)	Mode	Peak to Average Ratio (dB)
			QPSK
37850	2580	1 RB / 0RB Offset	4.87
38048	2599.8	1 RB / 99RB Offset	5.13
37850	2580	1 RB / 99RB Offset	7.16
38048	2599.8	1 RB / 0RB Offset	7.26

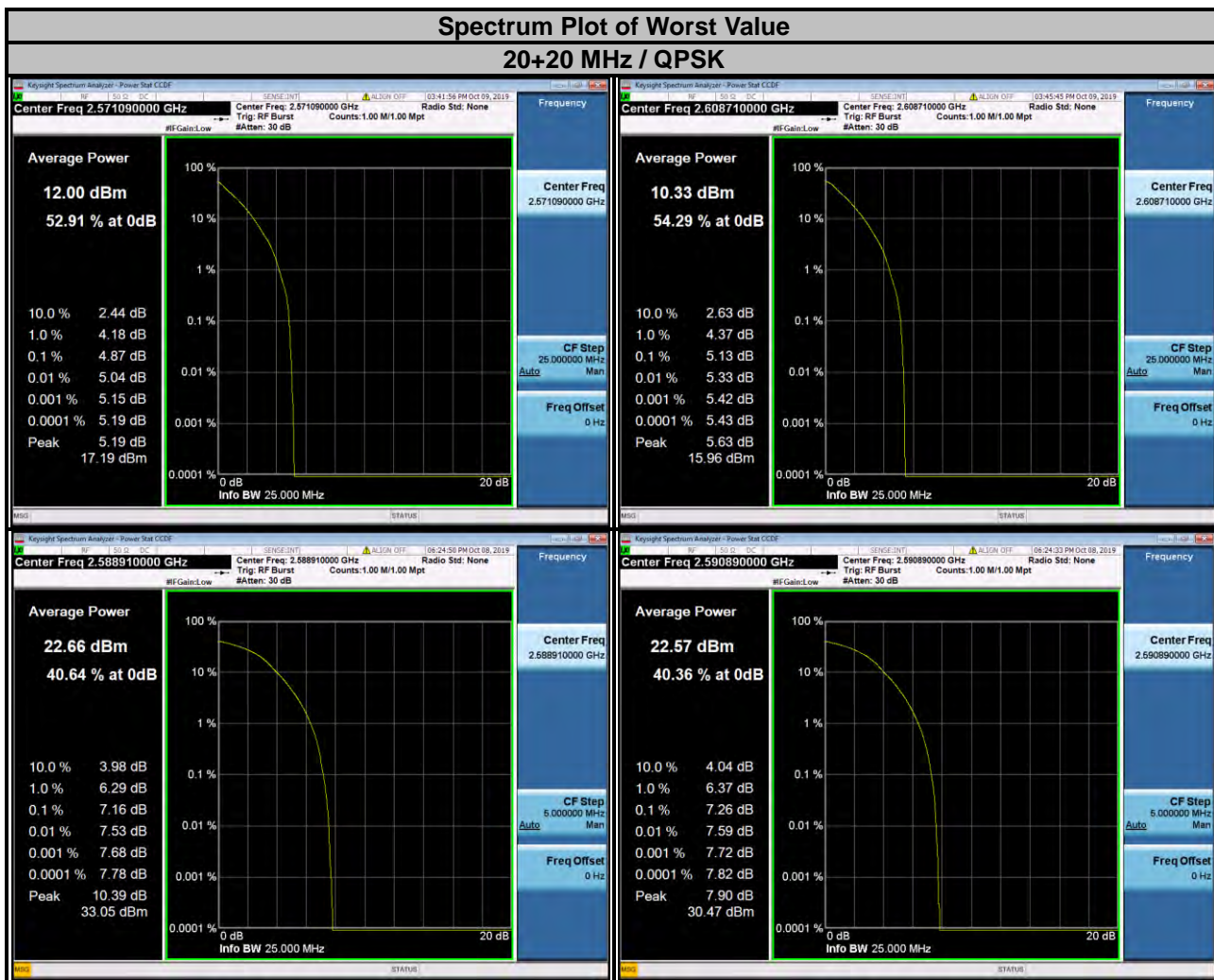

### LTE Band 38

#### Middle Channel

Channel	Frequency (MHz)	Mode	Peak to Average Ratio (dB)
			QPSK
37901	2585.1	1 RB / 0RB Offset	4.94
38099	2604.9	1 RB / 99RB Offset	5.08
37901	2585.1	1 RB / 99RB Offset	7.37
38099	2604.9	1 RB / 0RB Offset	7.23

### Spectrum Plot of Worst Value 20+20 MHz / QPSK

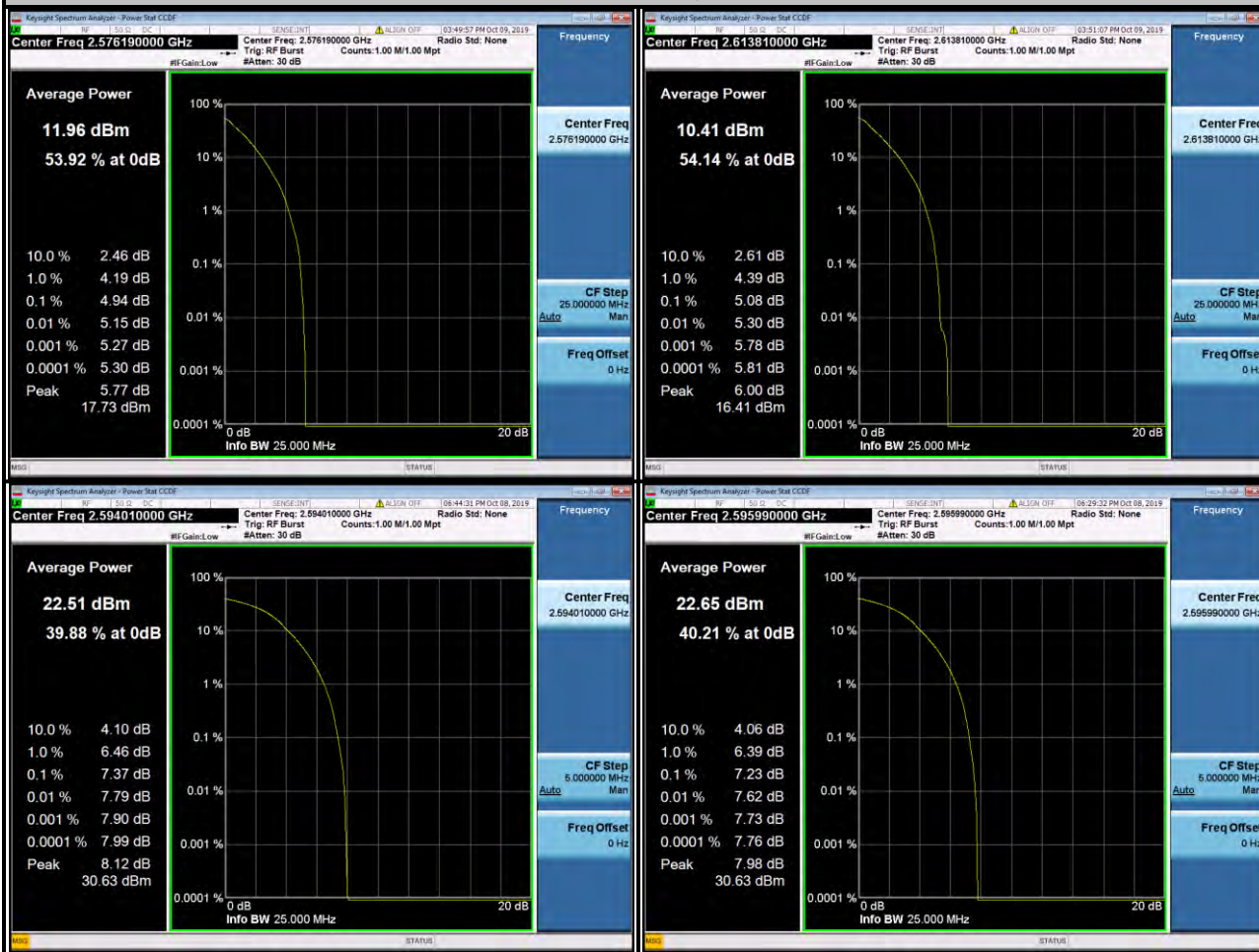

### LTE Band 38

### High Channel

Channel	Frequency (MHz)	Mode	Peak to Average Ratio (dB)
			QPSK
37952	2590.2	1 RB / 0RB Offset	4.94
38150	2610	1 RB / 99RB Offset	5.10
37952	2590.2	1 RB / 99RB Offset	7.07
38150	2610	1 RB / 0RB Offset	7.45

### Spectrum Plot of Worst Value 20+20 MHz / QPSK

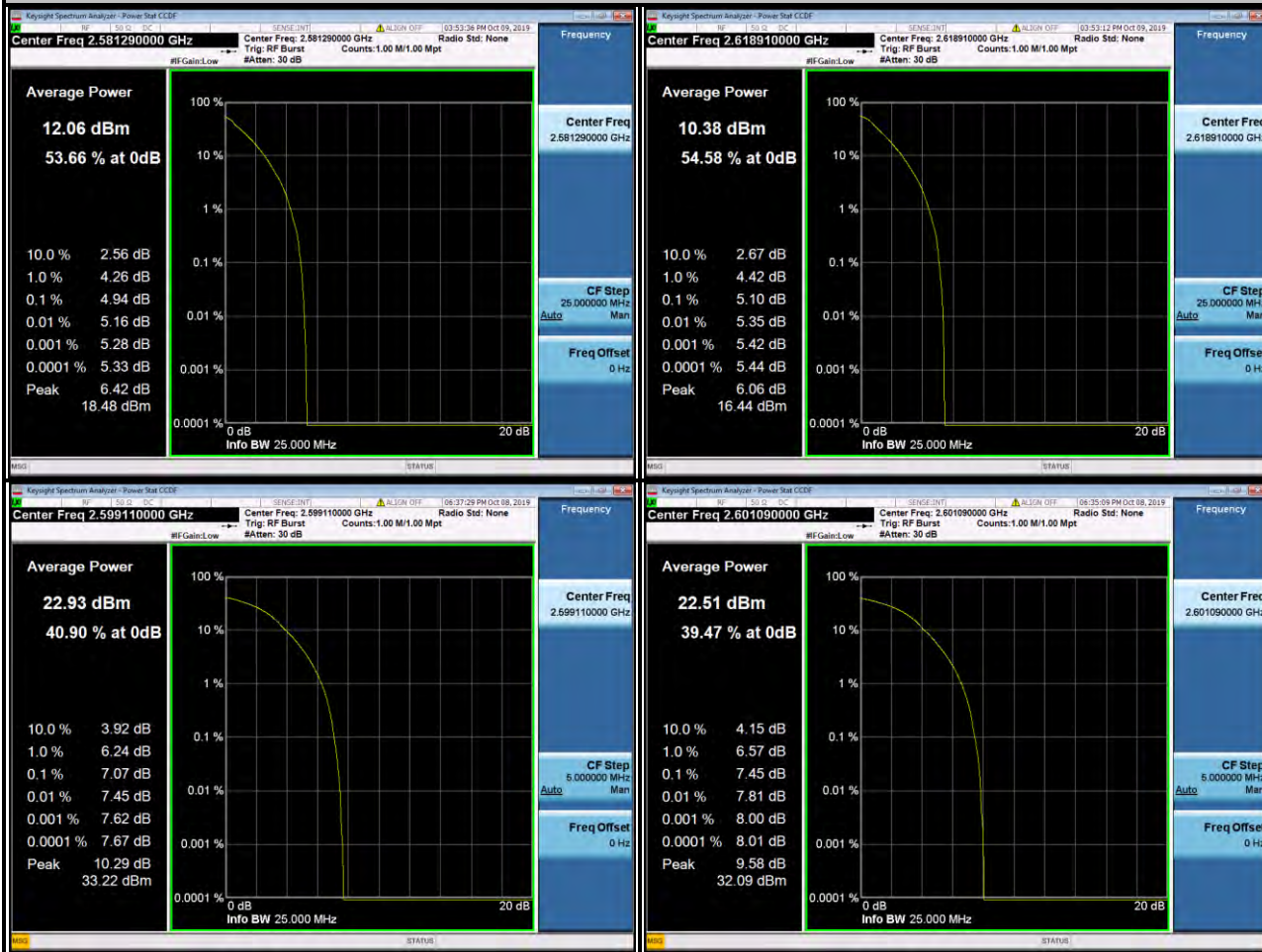

## 4.7 Conducted Spurious Emissions

### 4.7.1 Limits of Conducted Spurious Emissions Measurement

The power of any emission outside a licensee's frequency block shall be attenuated below the transmitter power (P) by at least  $55 + 10 \log (P)$  dB. The limit of emission is equal to -25 dBm.

### 4.7.2 Test Setup

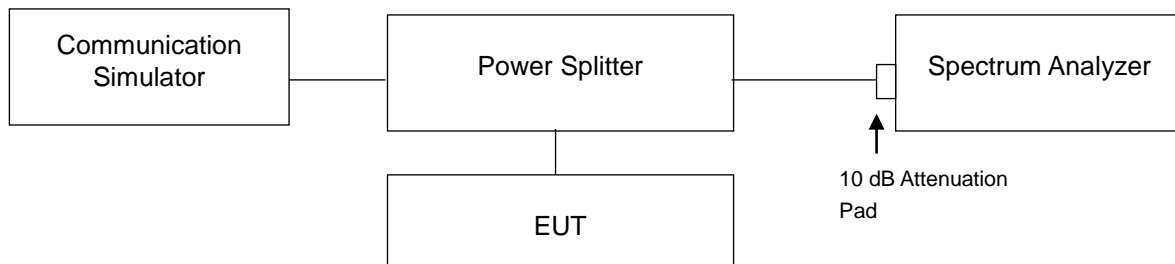

### 4.7.3 Test Procedure

- The EUT makes a phone call to the communication simulator. All measurements were done at low, middle and high operational frequency range.
- Measuring frequency range is from 9 kHz to 1 GHz. 10 dB attenuation pad is connected with spectrum. RBW = 1 MHz and VBW = 3 MHz are used for conducted emission measurement.
- Measuring frequency range is from 1 GHz to 26 or 27 GHz. 10 dB attenuation pad is connected with spectrum. RBW = 1 MHz and VBW = 3 MHz are used for conducted emission measurement.
- Spectrum RBW settings are referenced to ANSI C63.26 section 5.7.2.



#### 4.7.4 Test Results

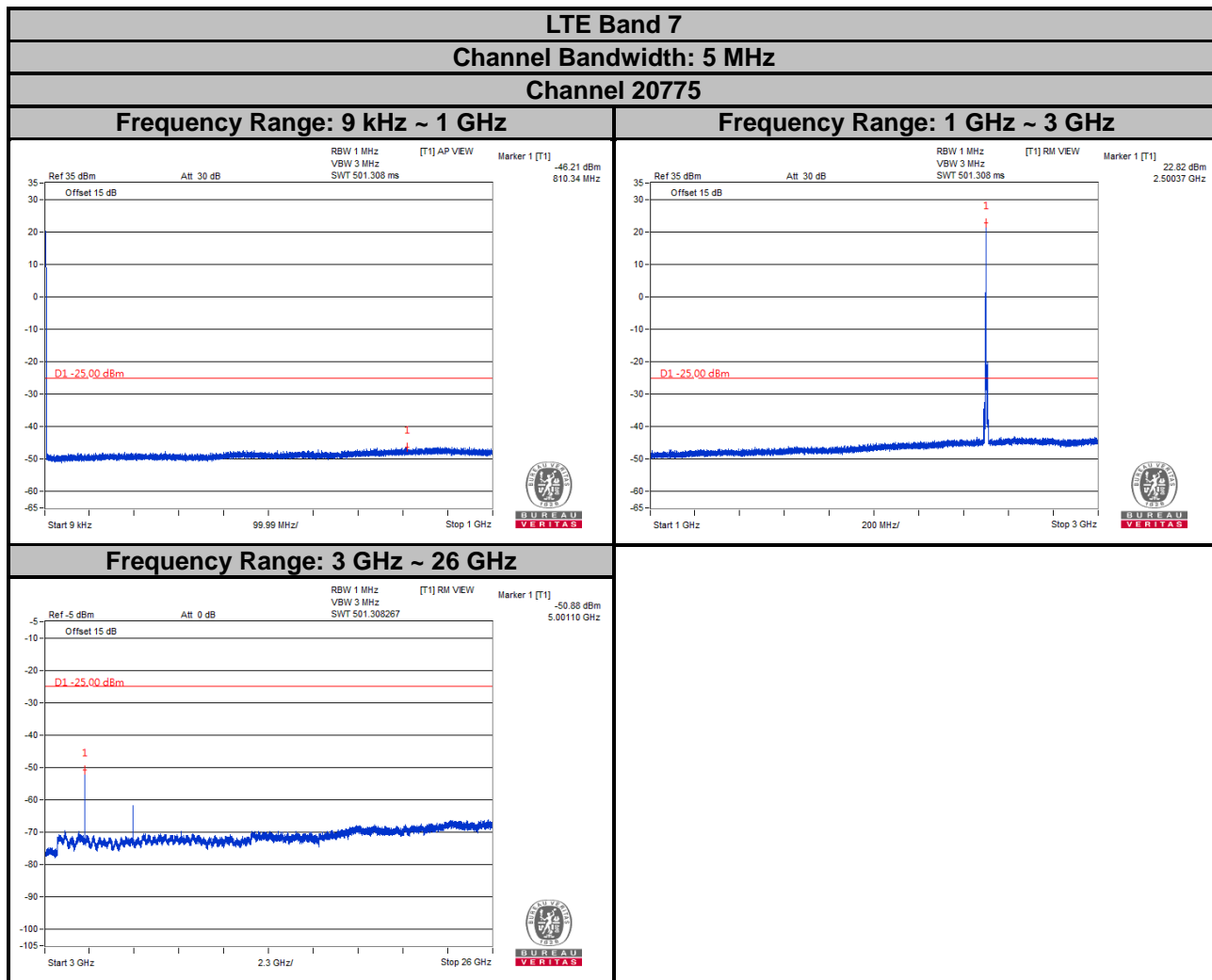

Note: The signal over the limit in 9 kHz is from spectrum analyzer.

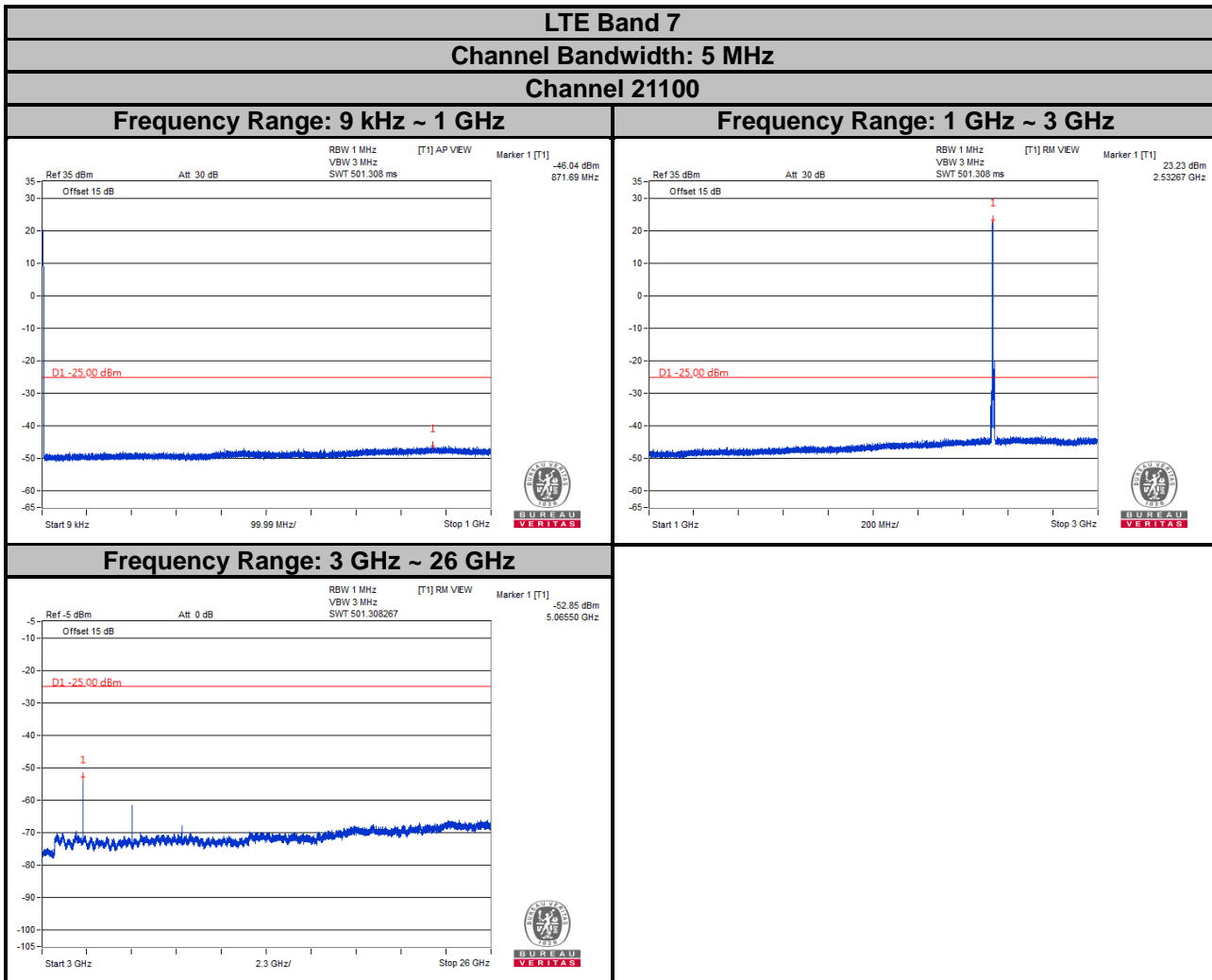

Note: The signal over the limit in 9 kHz is from spectrum analyzer.



**LTE Band 7**

**Channel Bandwidth: 5 MHz**

**Channel 21425**

**Frequency Range: 9 kHz ~ 1 GHz**

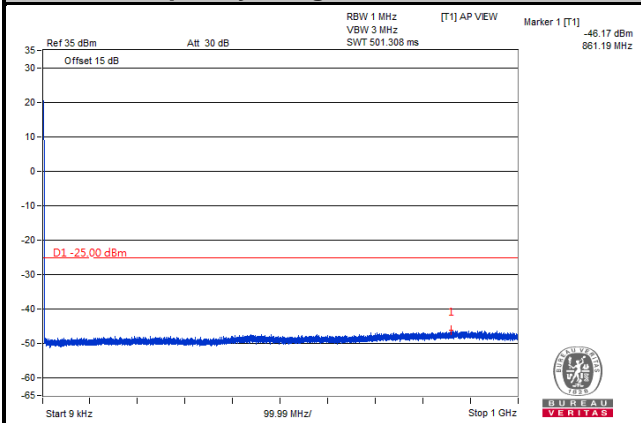

**Frequency Range: 1 GHz ~ 3 GHz**

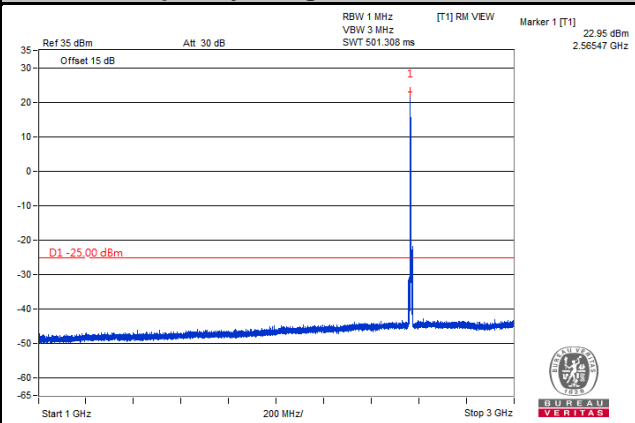

**Frequency Range: 3 GHz ~ 26 GHz**

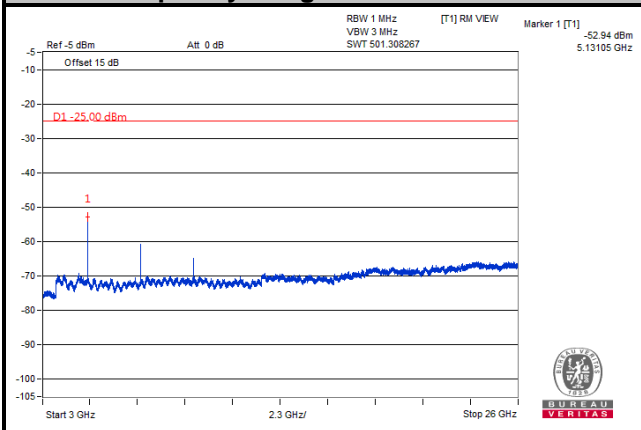

Note: The signal over the limit in 9 kHz is from spectrum analyzer.

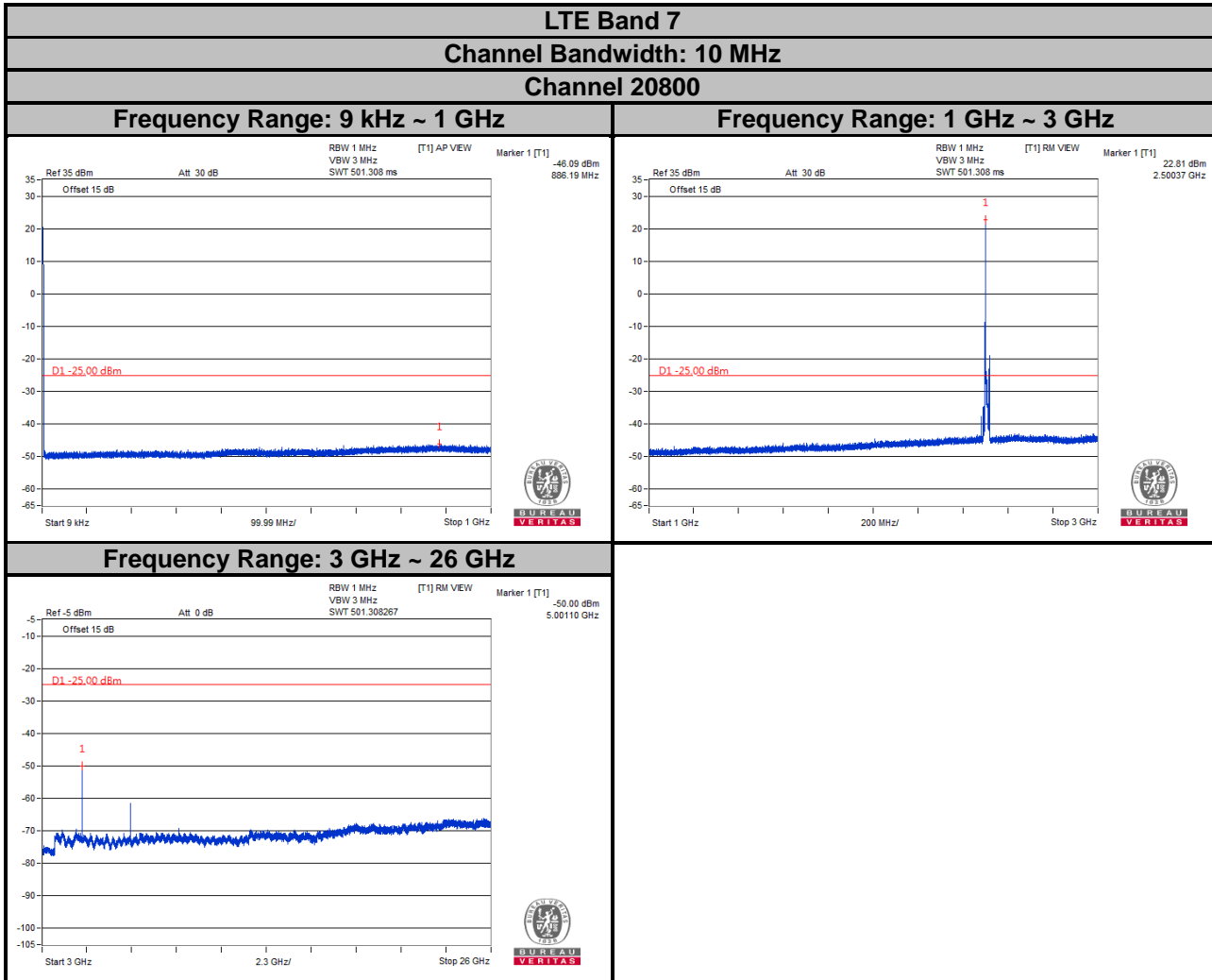

Note: The signal over the limit in 9 kHz is from spectrum analyzer.

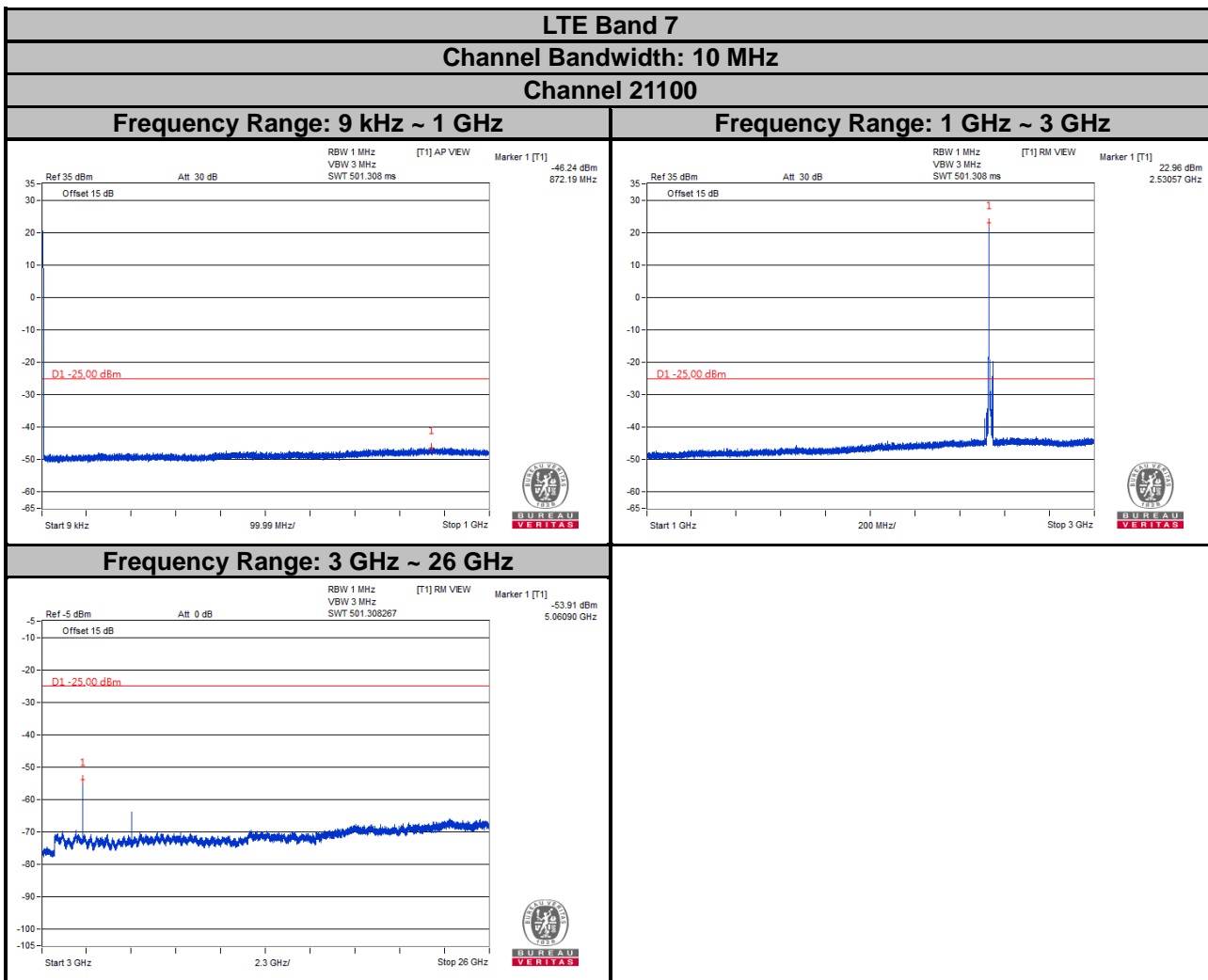

Note: The signal over the limit in 9 kHz is from spectrum analyzer.

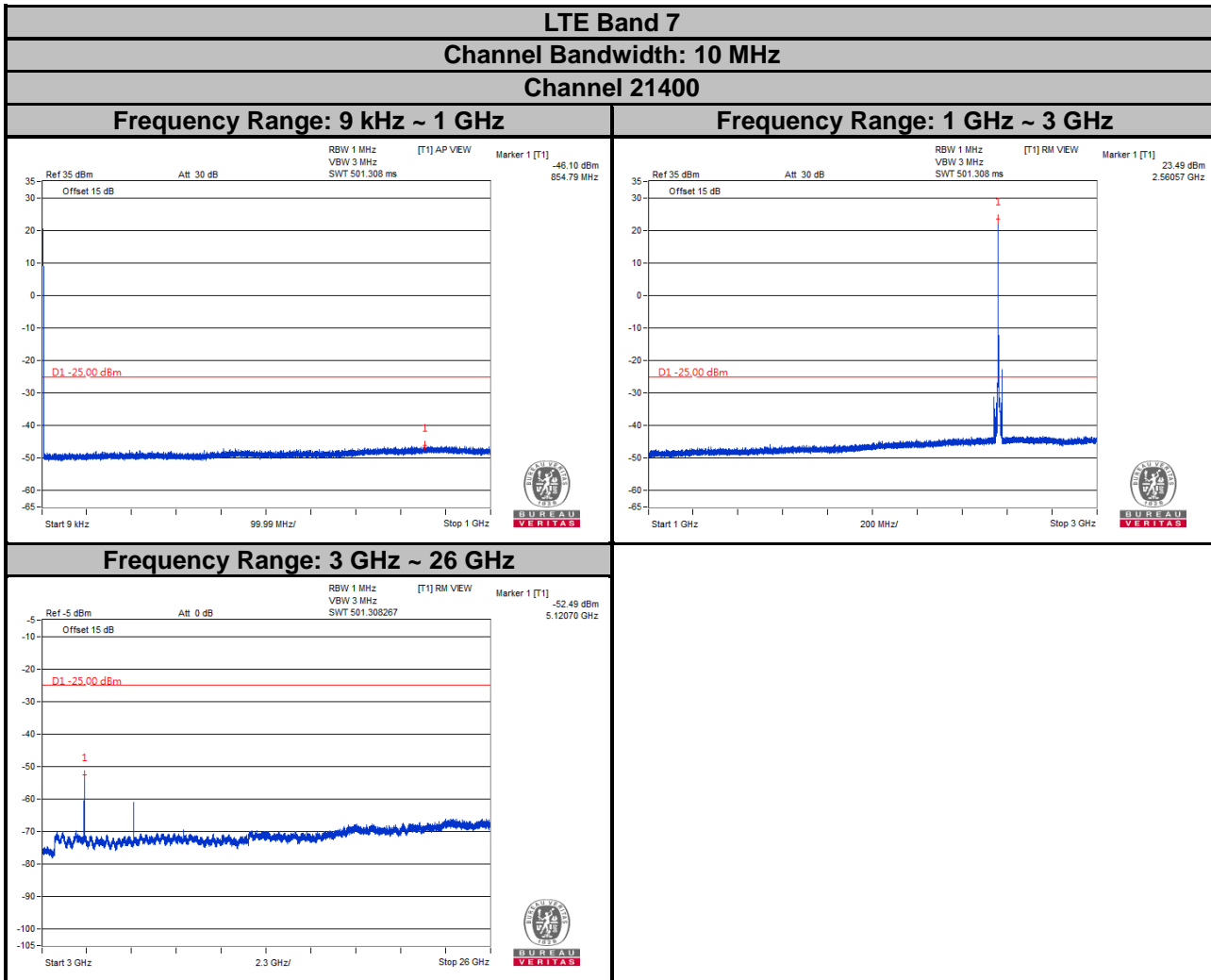

Note: The signal over the limit in 9 kHz is from spectrum analyzer.

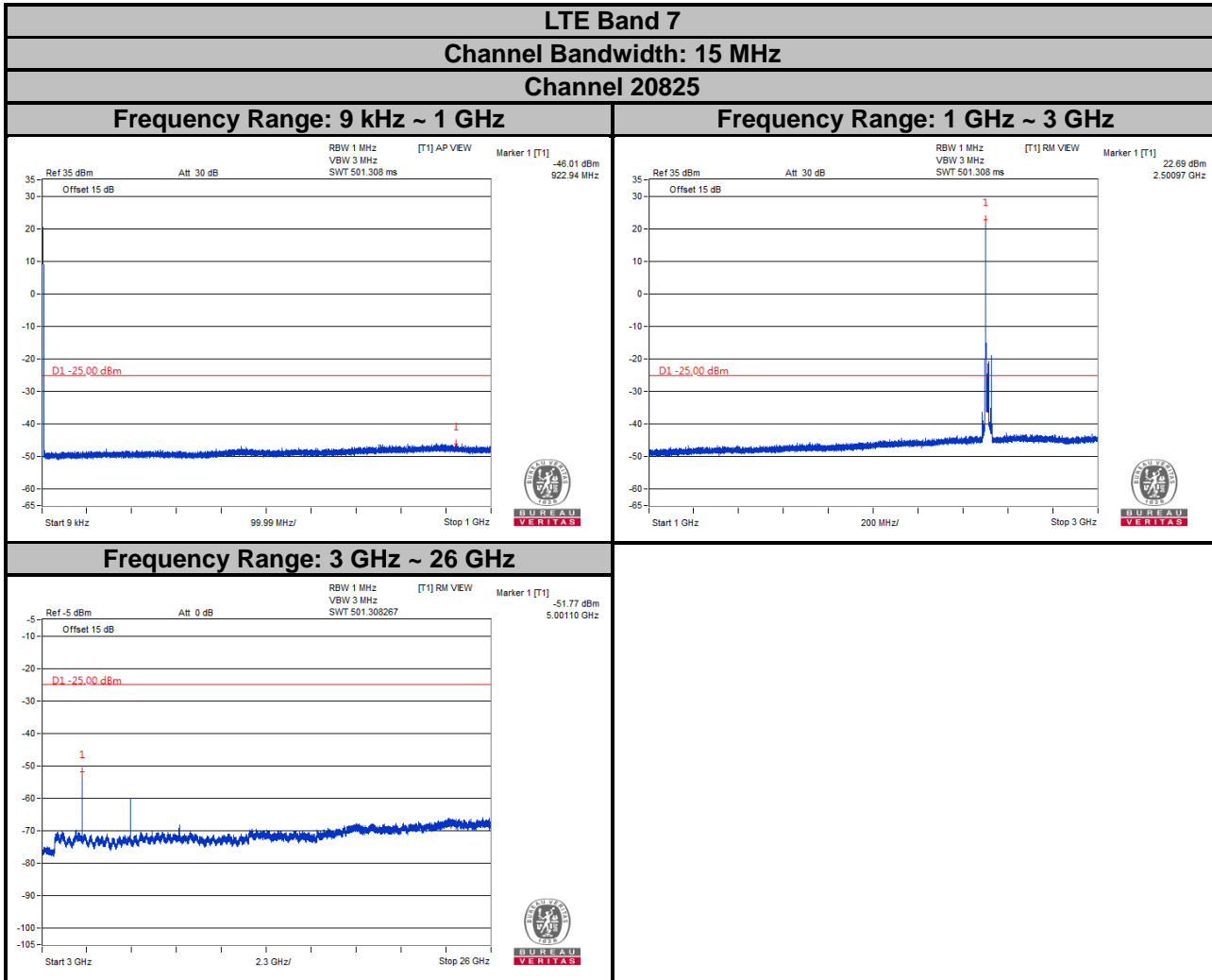

Note: The signal over the limit in 9 kHz is from spectrum analyzer.

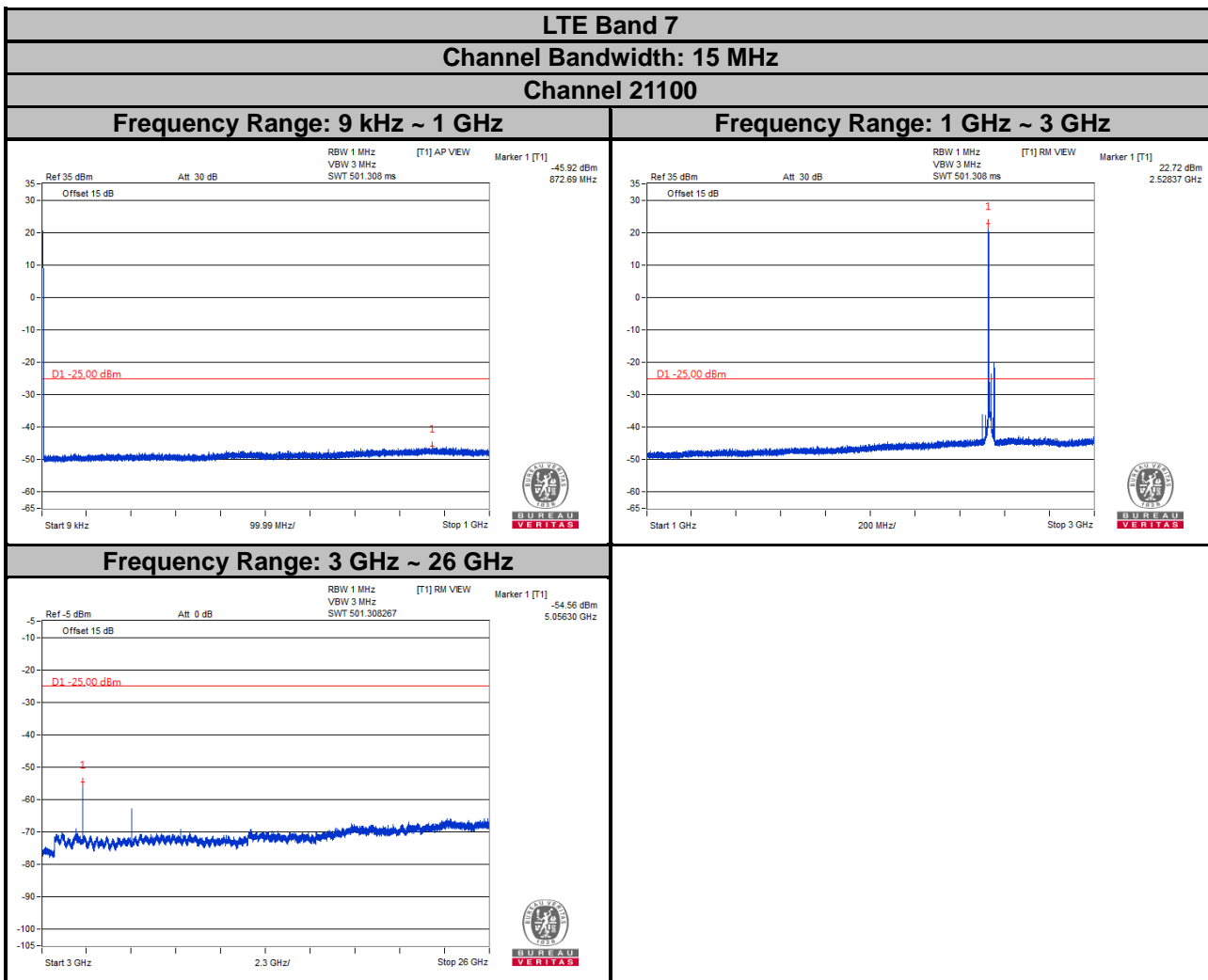

Note: The signal over the limit in 9 kHz is from spectrum analyzer.



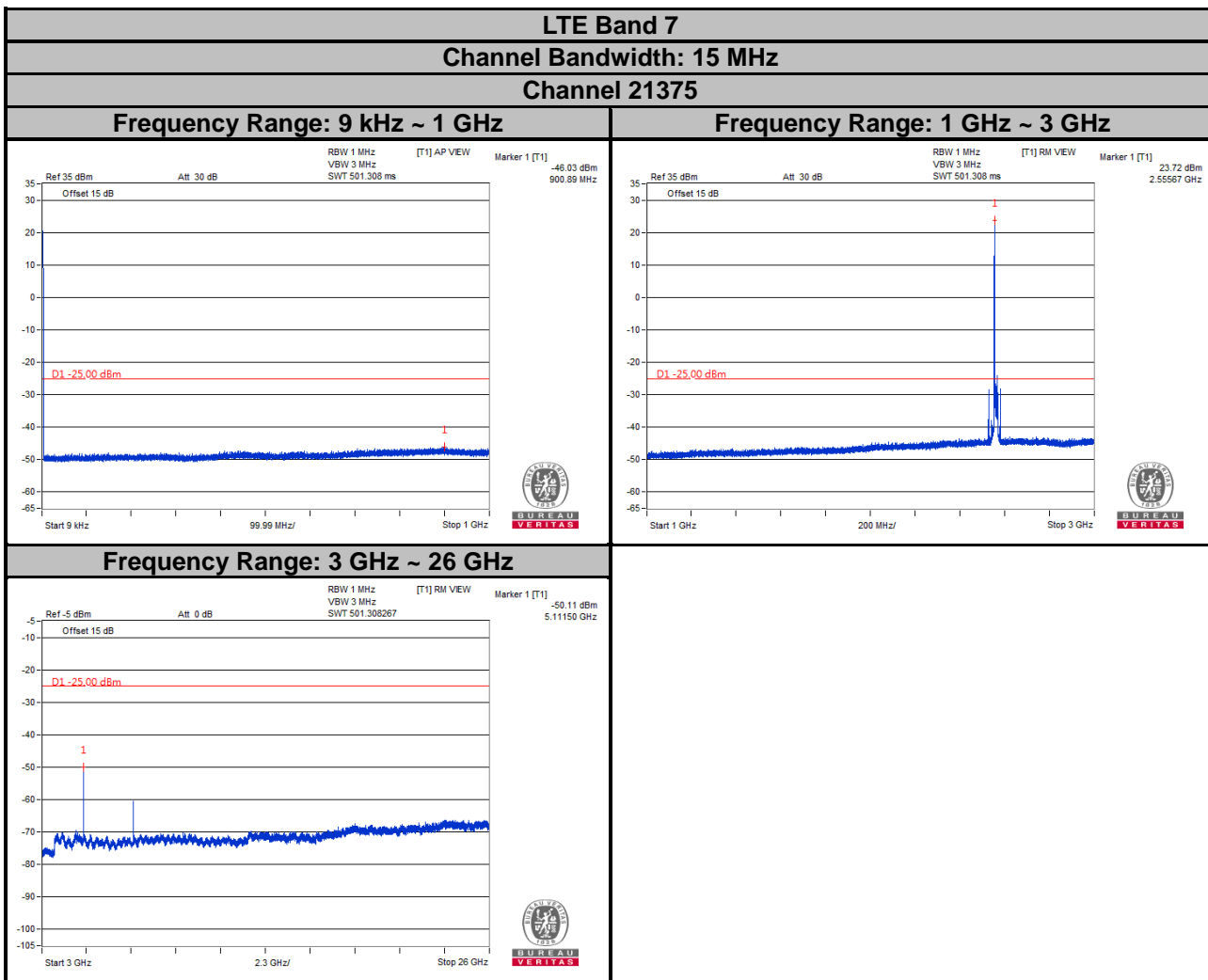

Note: The signal over the limit in 9 kHz is from spectrum analyzer.

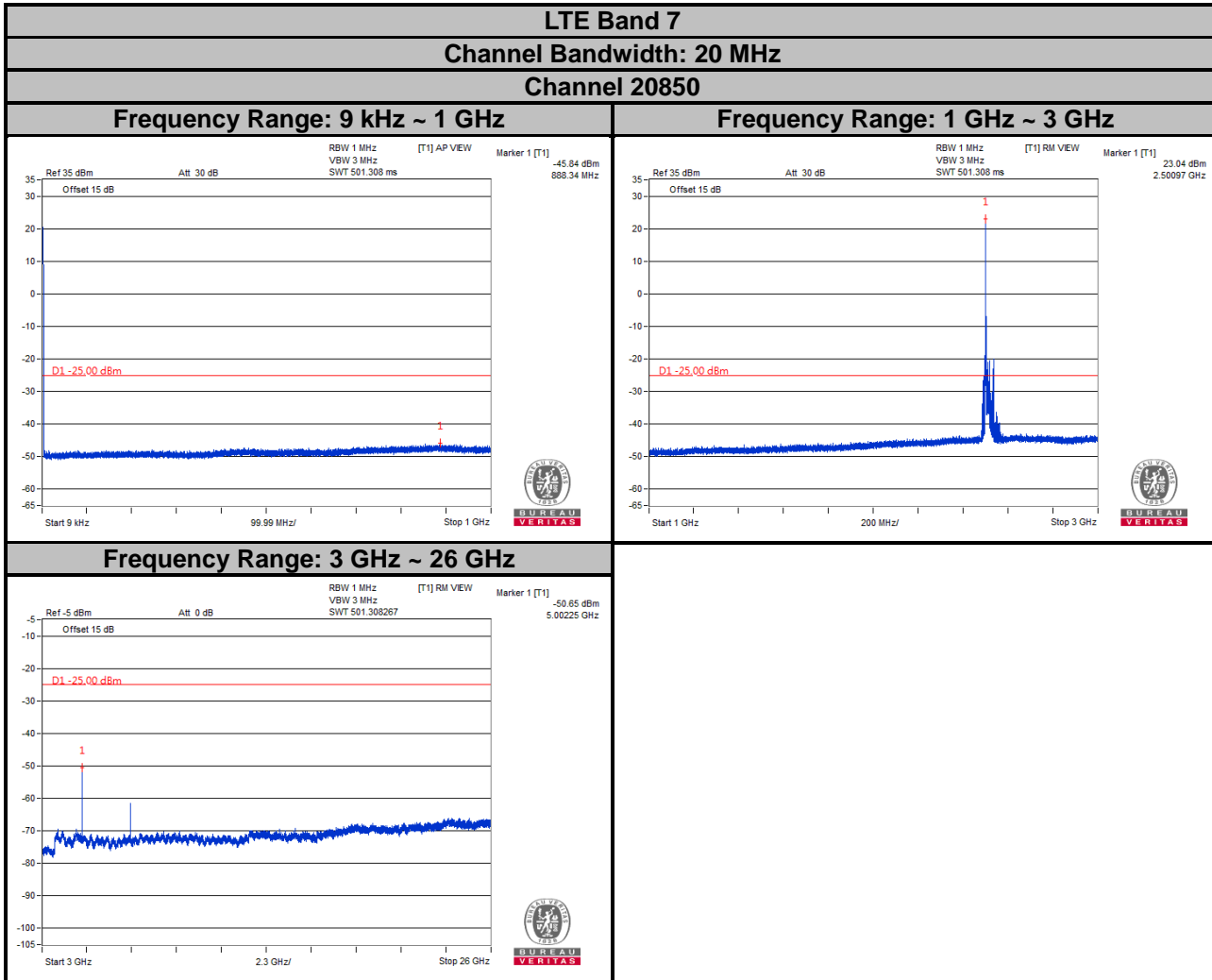

Note: The signal over the limit in 9 kHz is from spectrum analyzer.

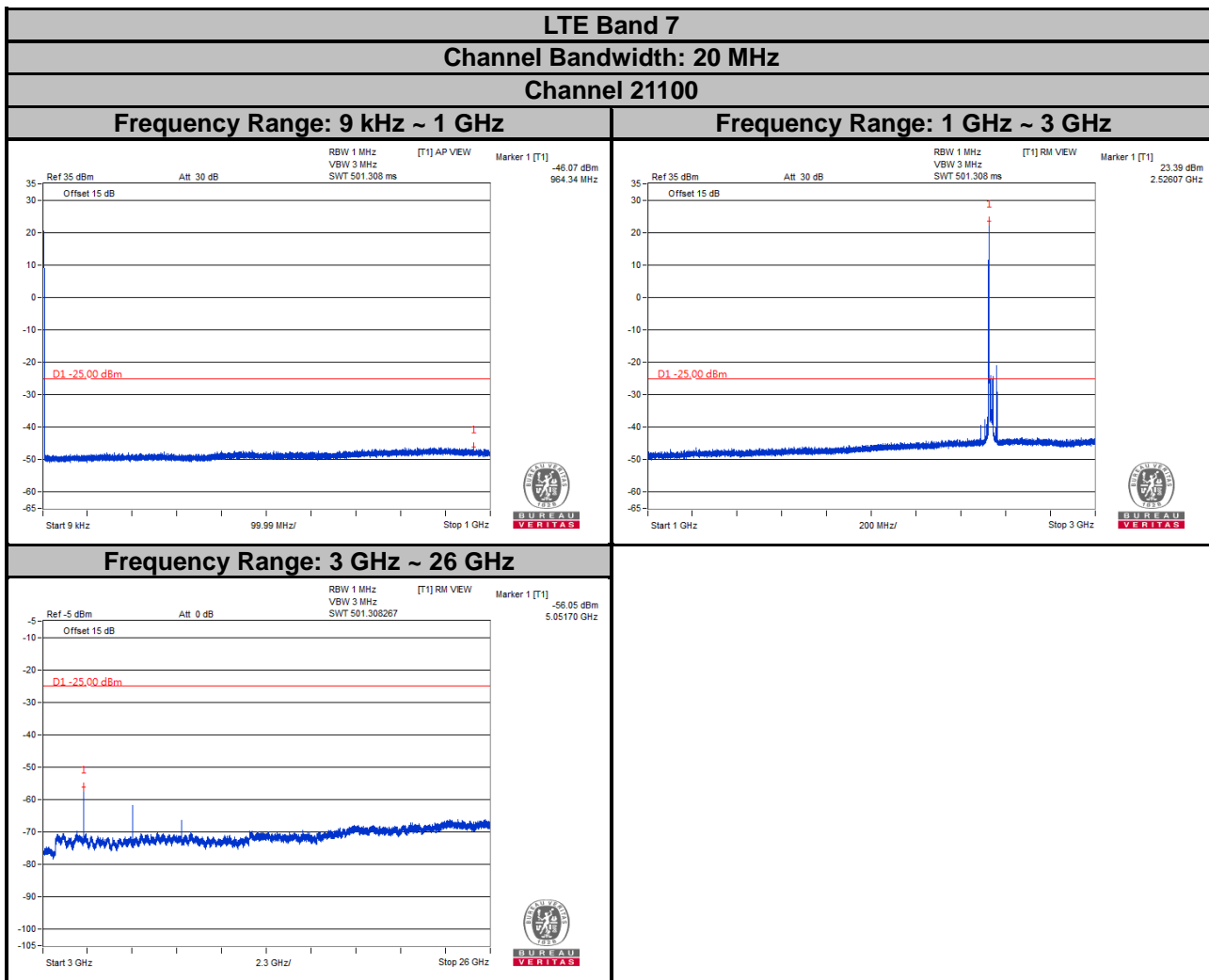

Note: The signal over the limit in 9 kHz is from spectrum analyzer.

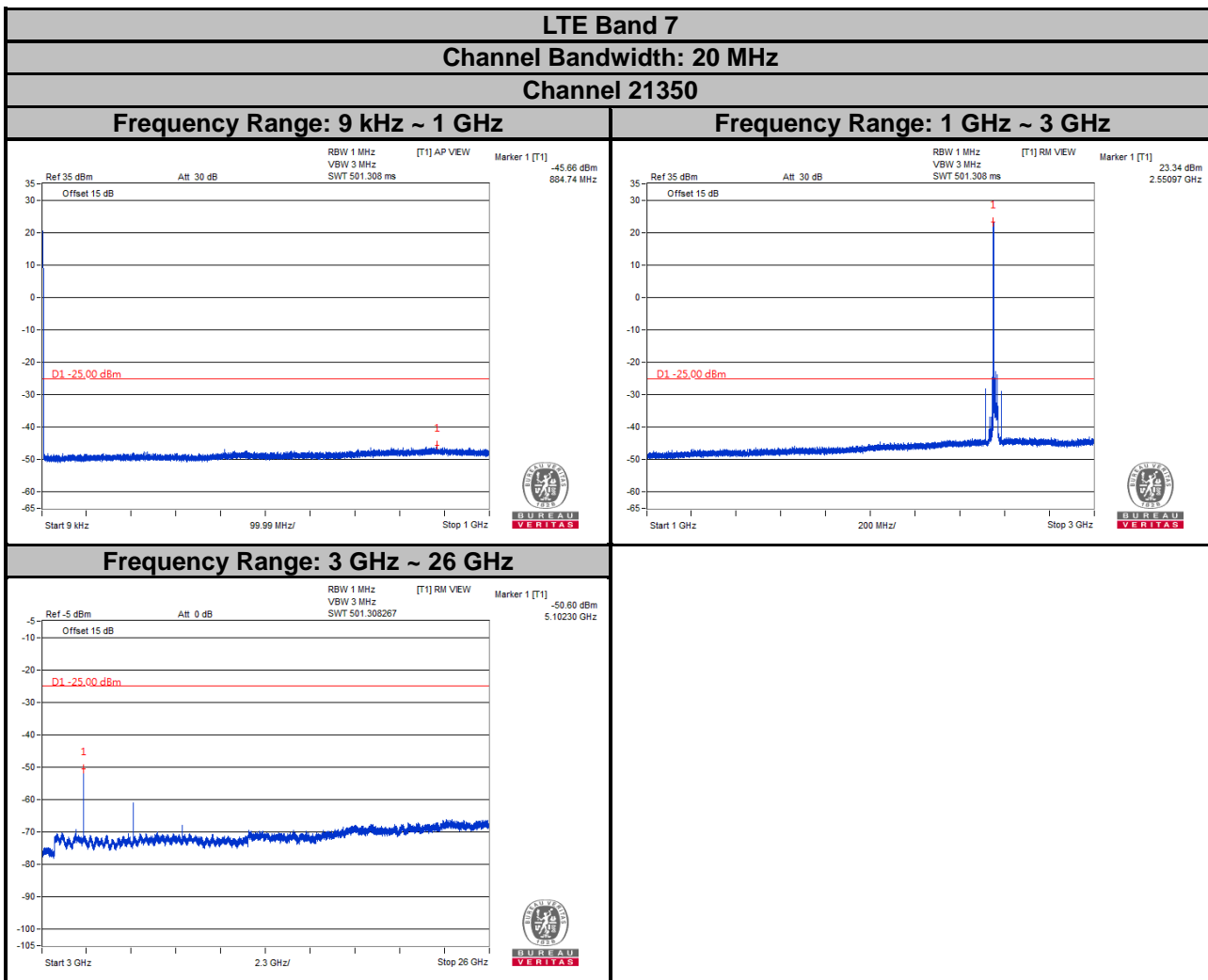

Note: The signal over the limit in 9 kHz is from spectrum analyzer.

CA Mode

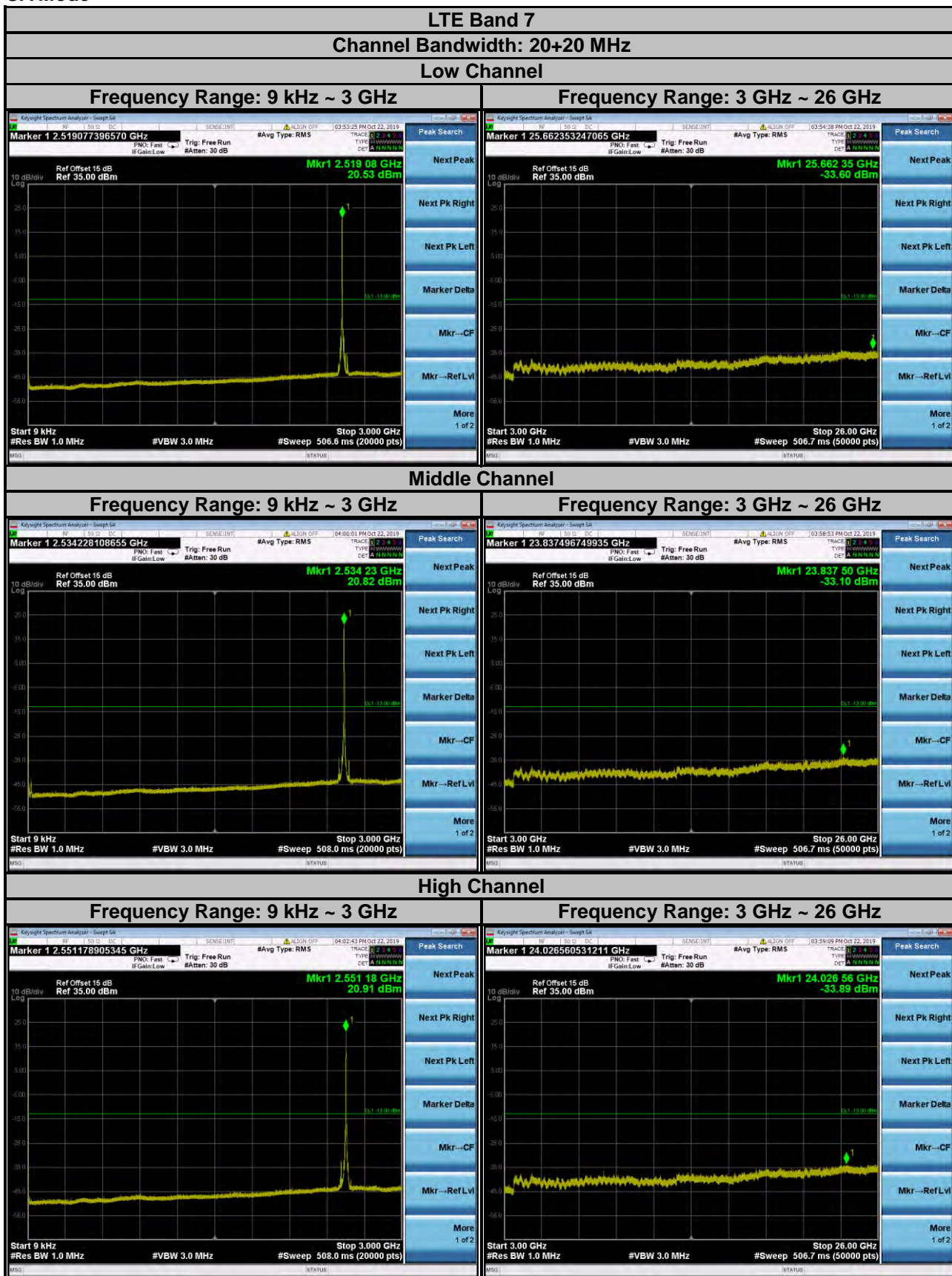

Note: The signal over the limit in 9 kHz is from spectrum analyzer.

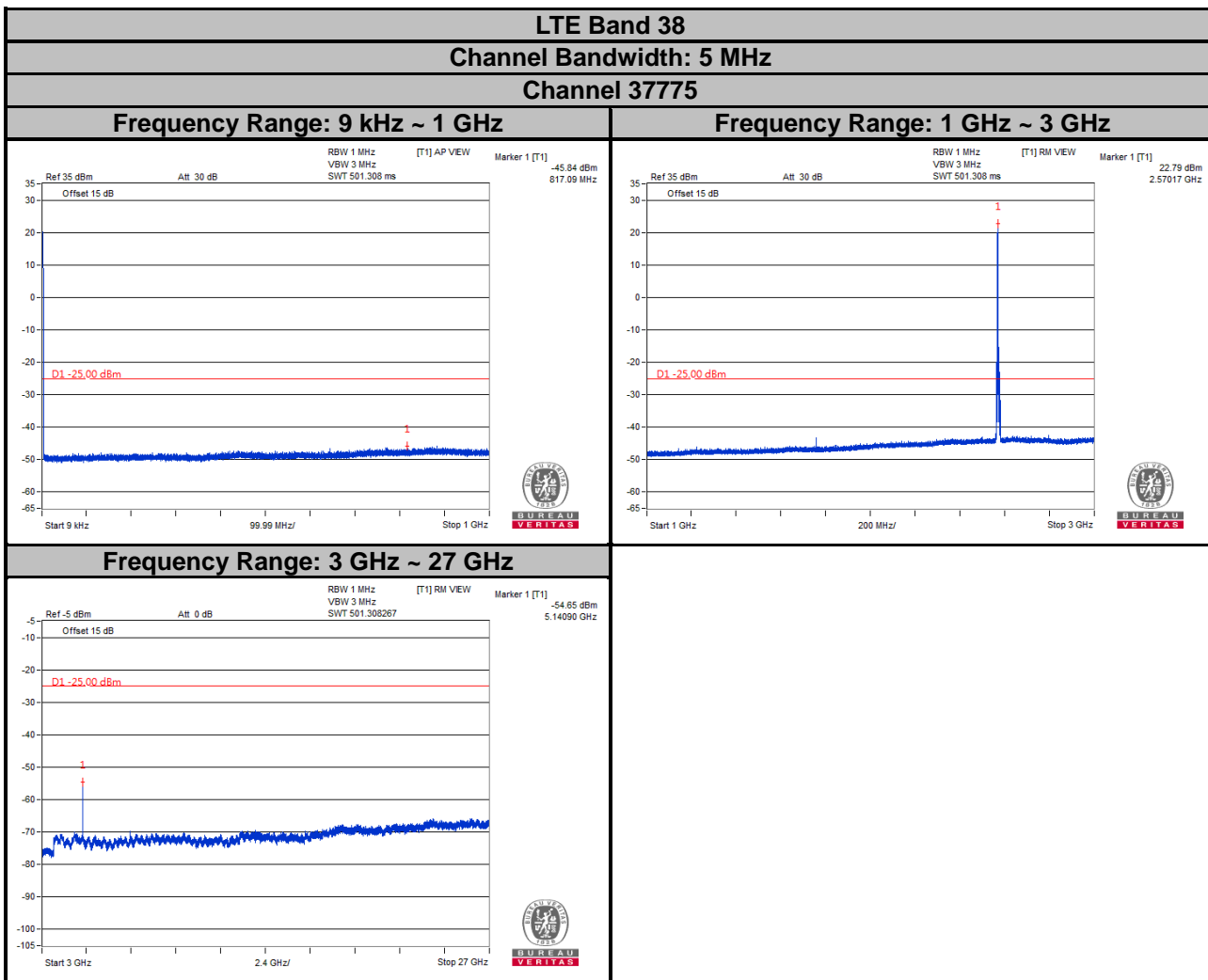

Note: The signal over the limit in 9 kHz is from spectrum analyzer.



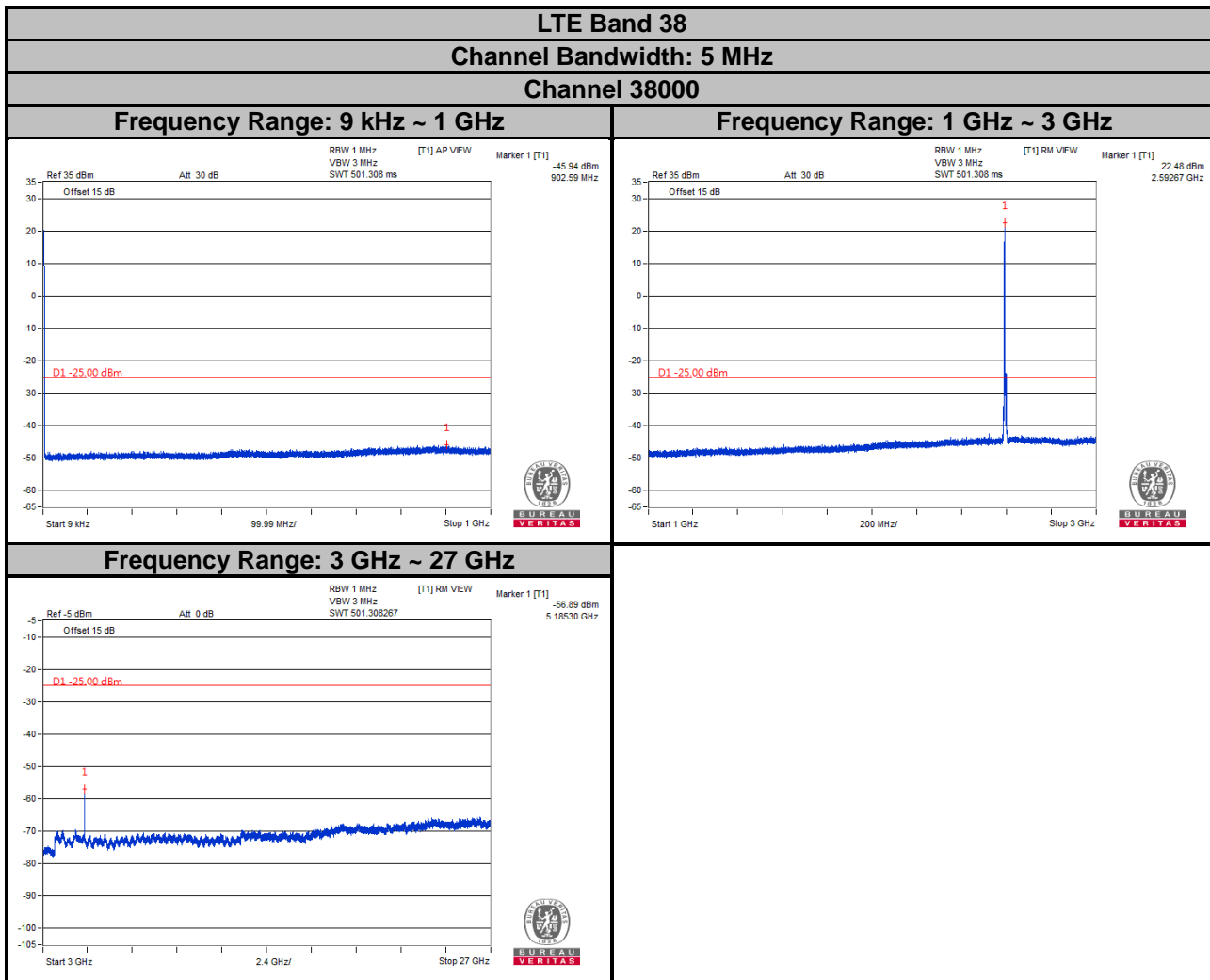

Note: The signal over the limit in 9 kHz is from spectrum analyzer.

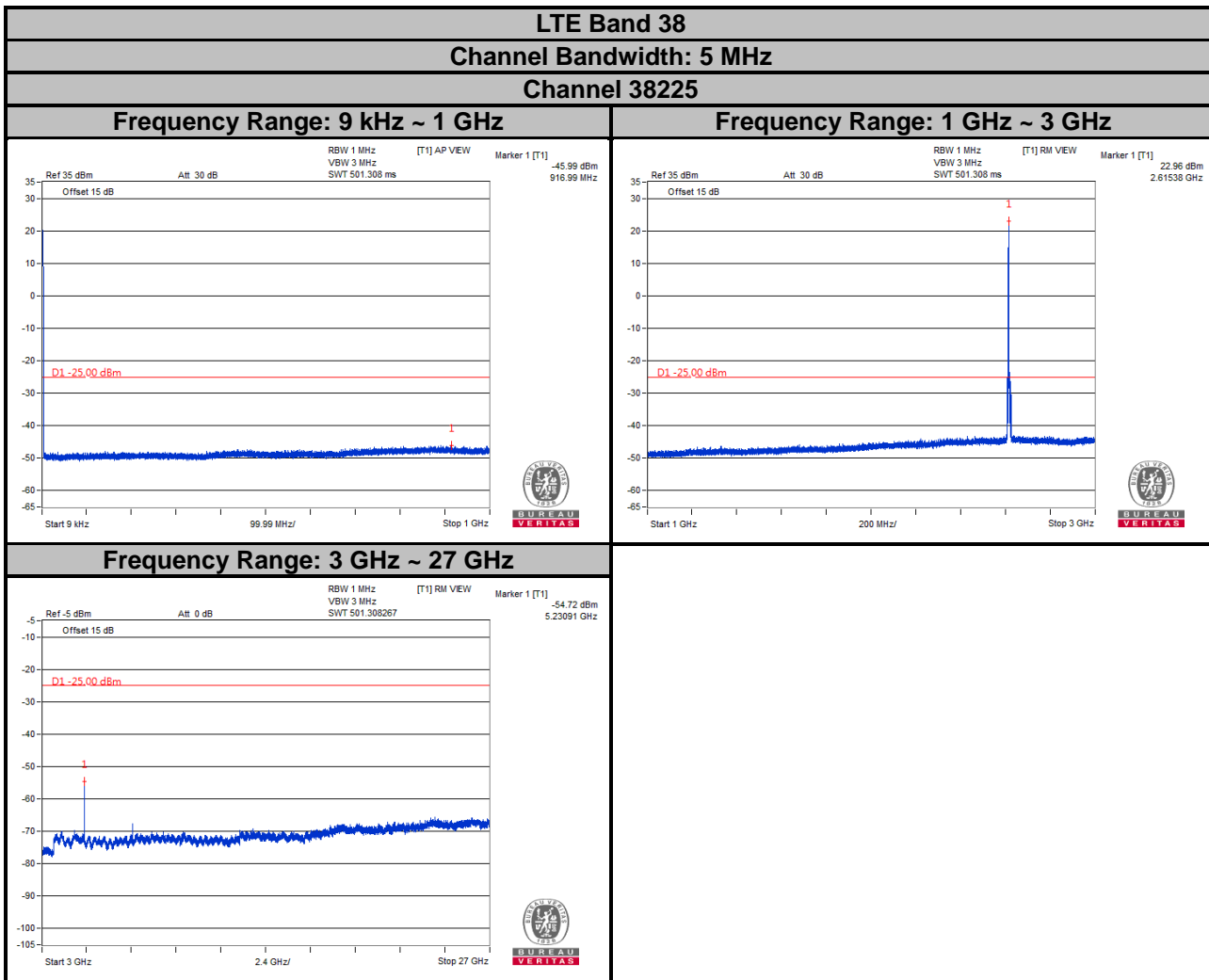

Note: The signal over the limit in 9 kHz is from spectrum analyzer.

**LTE Band 38**

**Channel Bandwidth: 10 MHz**

**Channel 37800**

**Frequency Range: 9 kHz ~ 1 GHz**

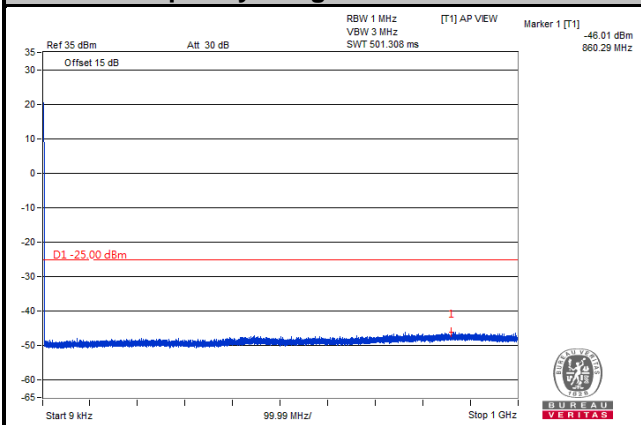

**Frequency Range: 1 GHz ~ 3 GHz**

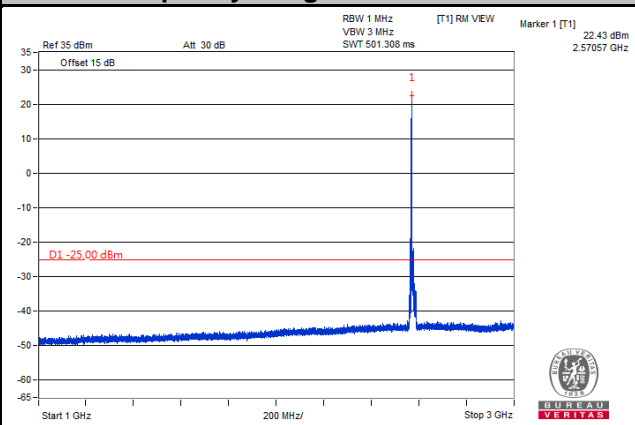

**Frequency Range: 3 GHz ~ 27 GHz**

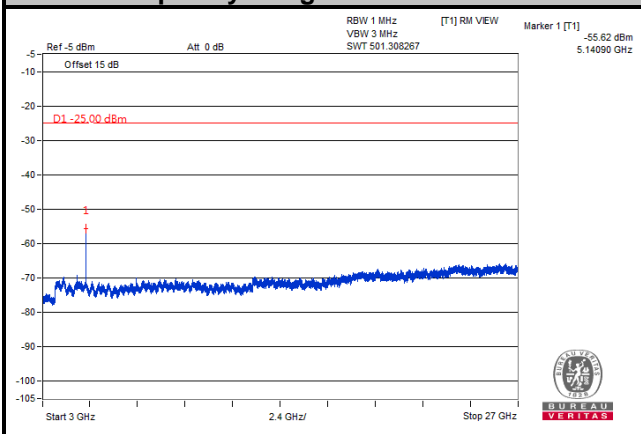

Note: The signal over the limit in 9 kHz is from spectrum analyzer.

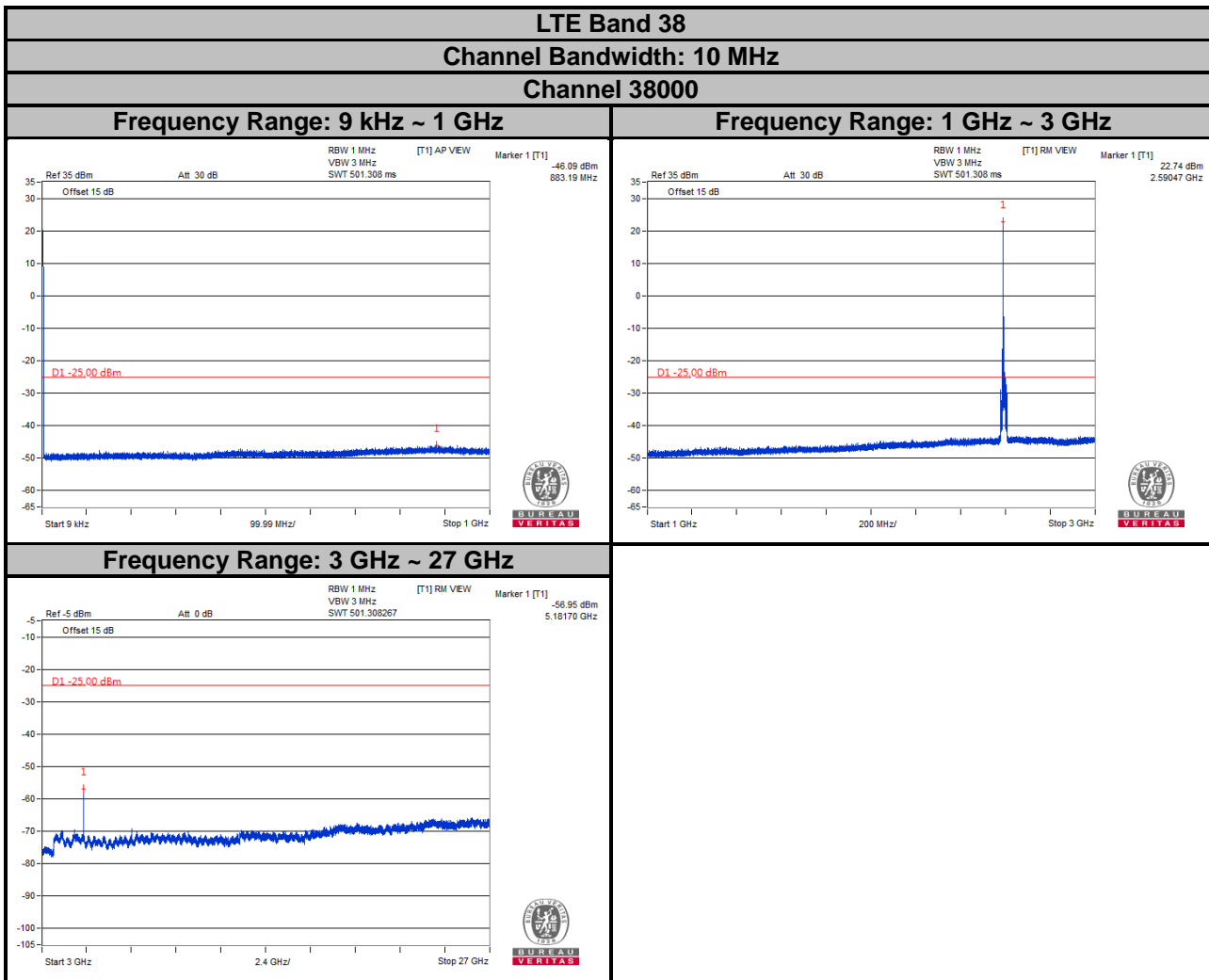

Note: The signal over the limit in 9 kHz is from spectrum analyzer.

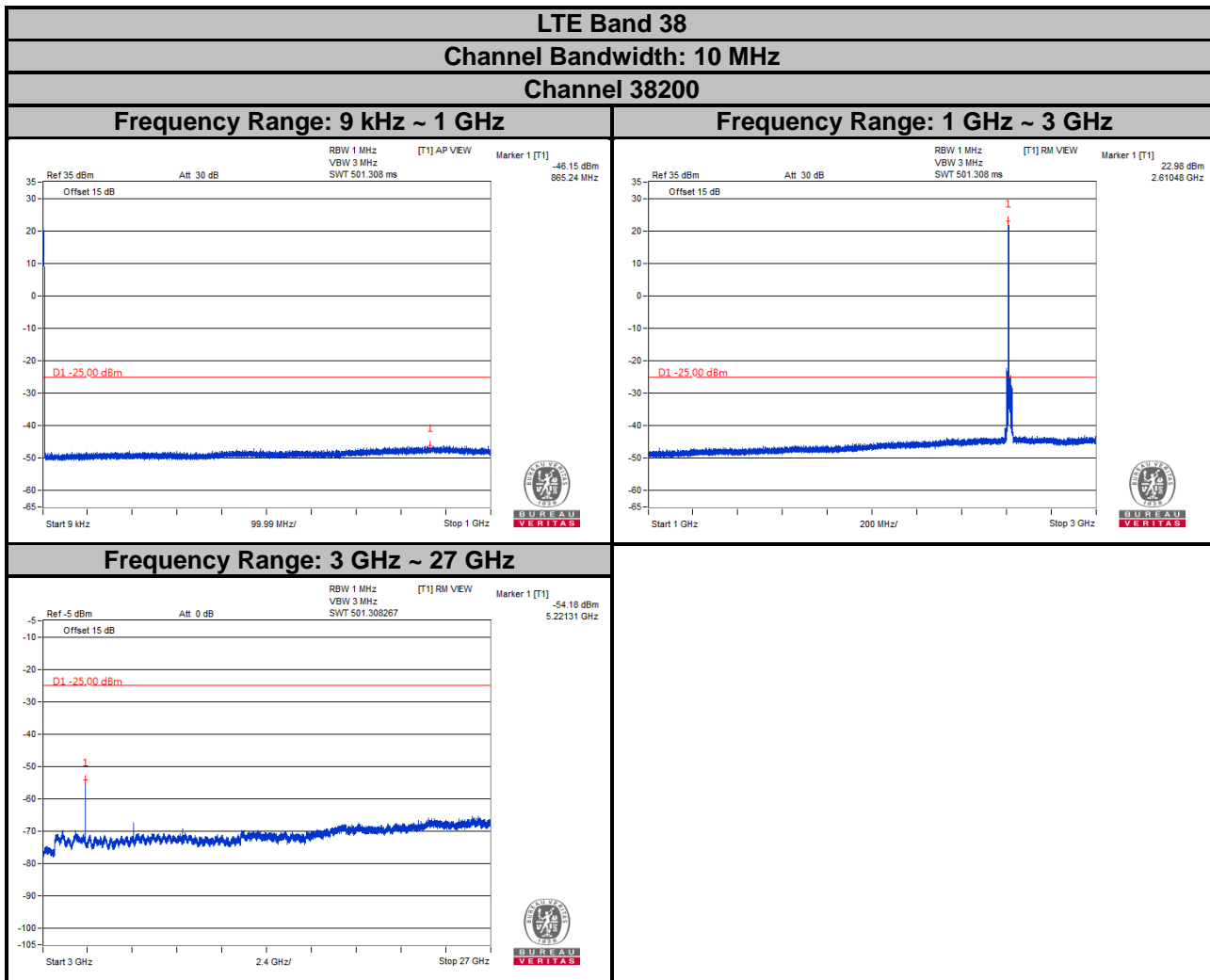

Note: The signal over the limit in 9 kHz is from spectrum analyzer.

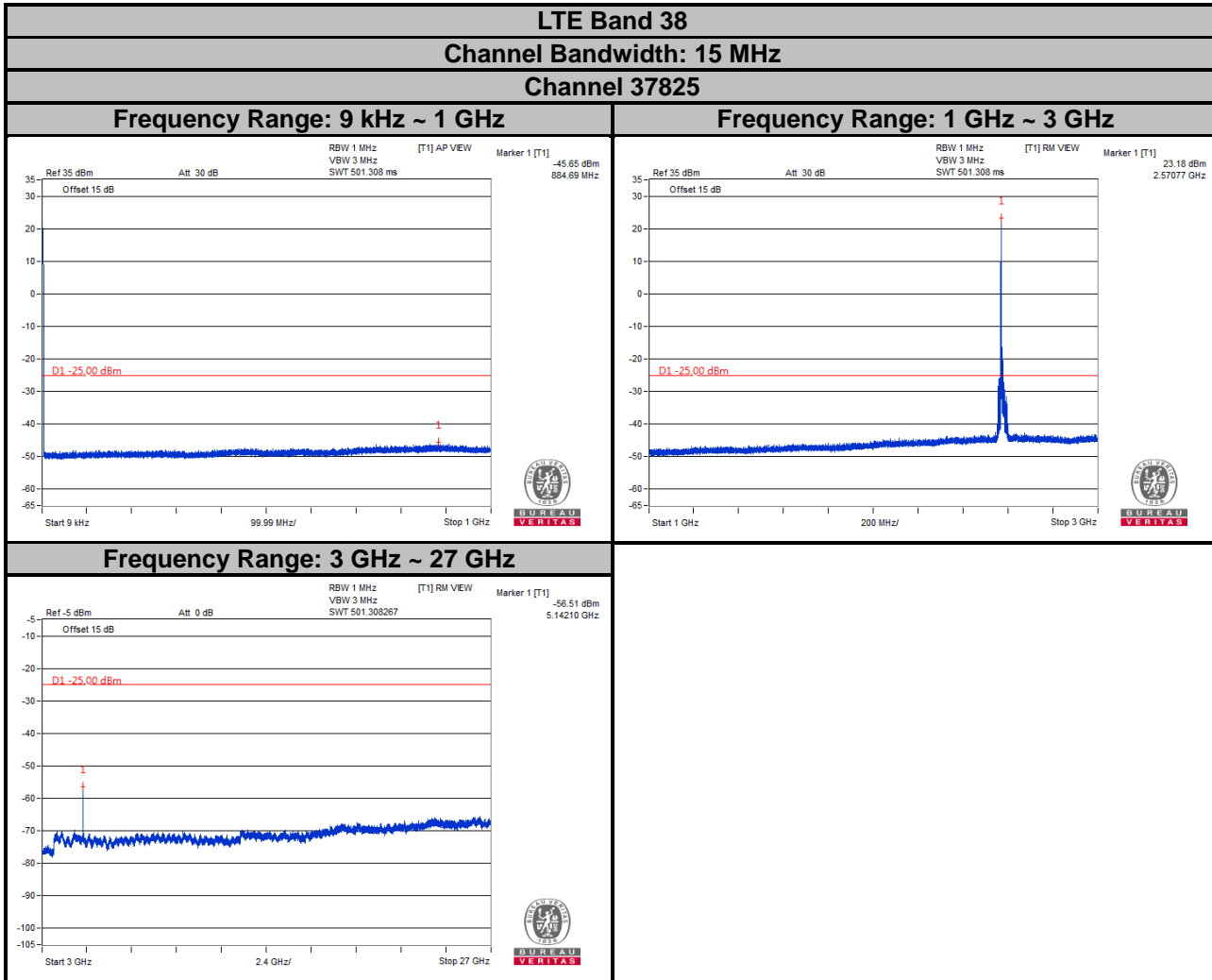

Note: The signal over the limit in 9 kHz is from spectrum analyzer.



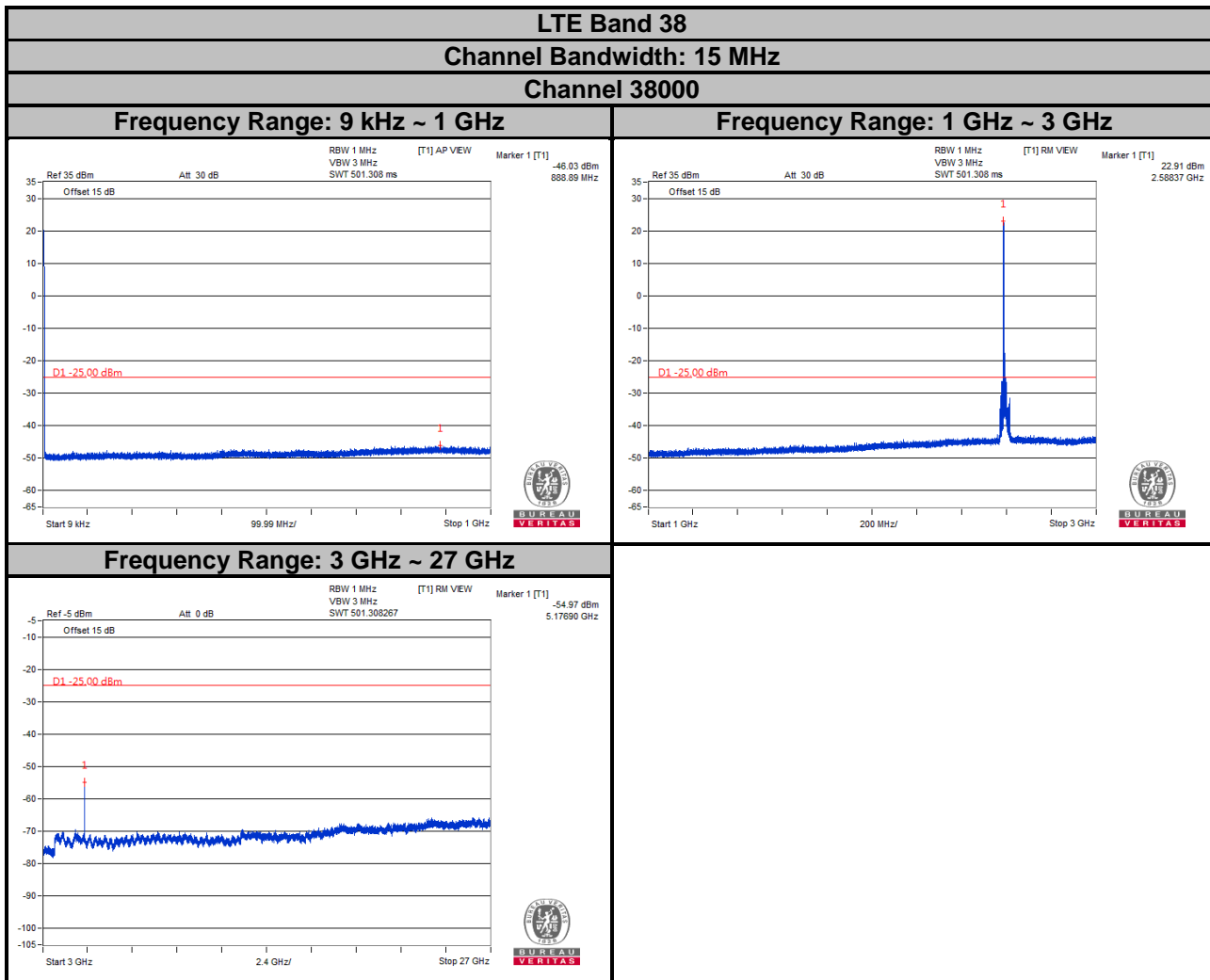

Note: The signal over the limit in 9 kHz is from spectrum analyzer.

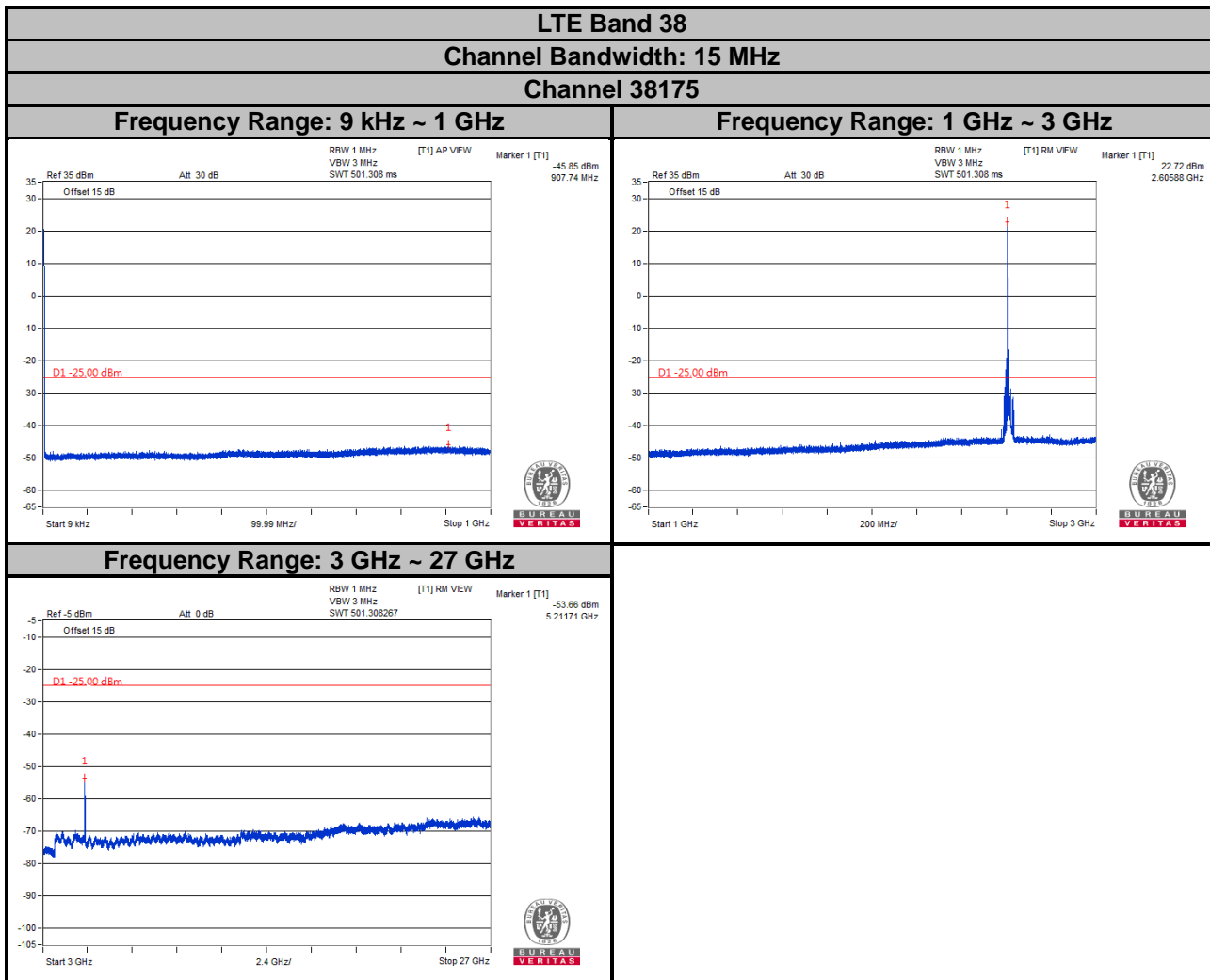

Note: The signal over the limit in 9 kHz is from spectrum analyzer.

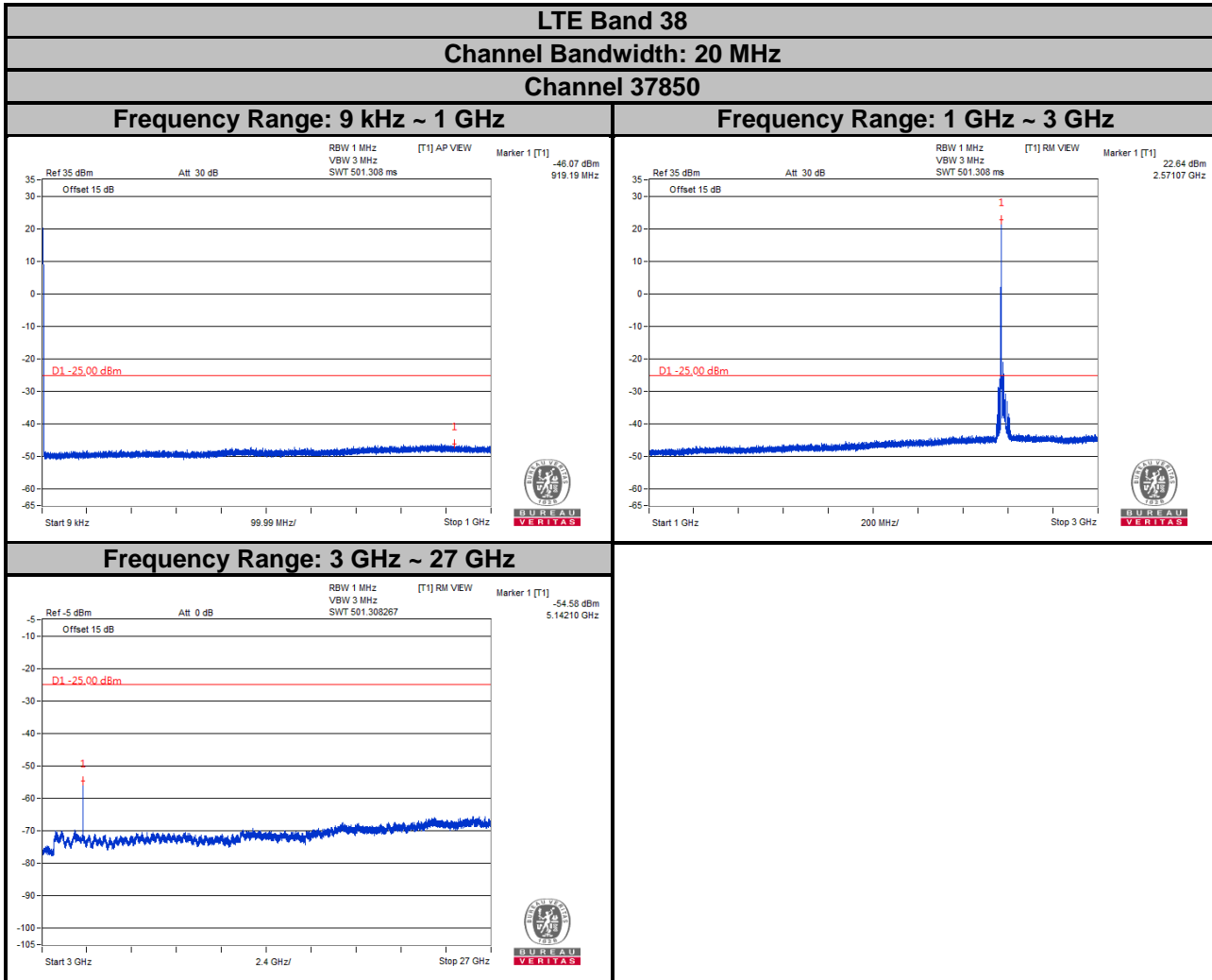

Note: The signal over the limit in 9 kHz is from spectrum analyzer.

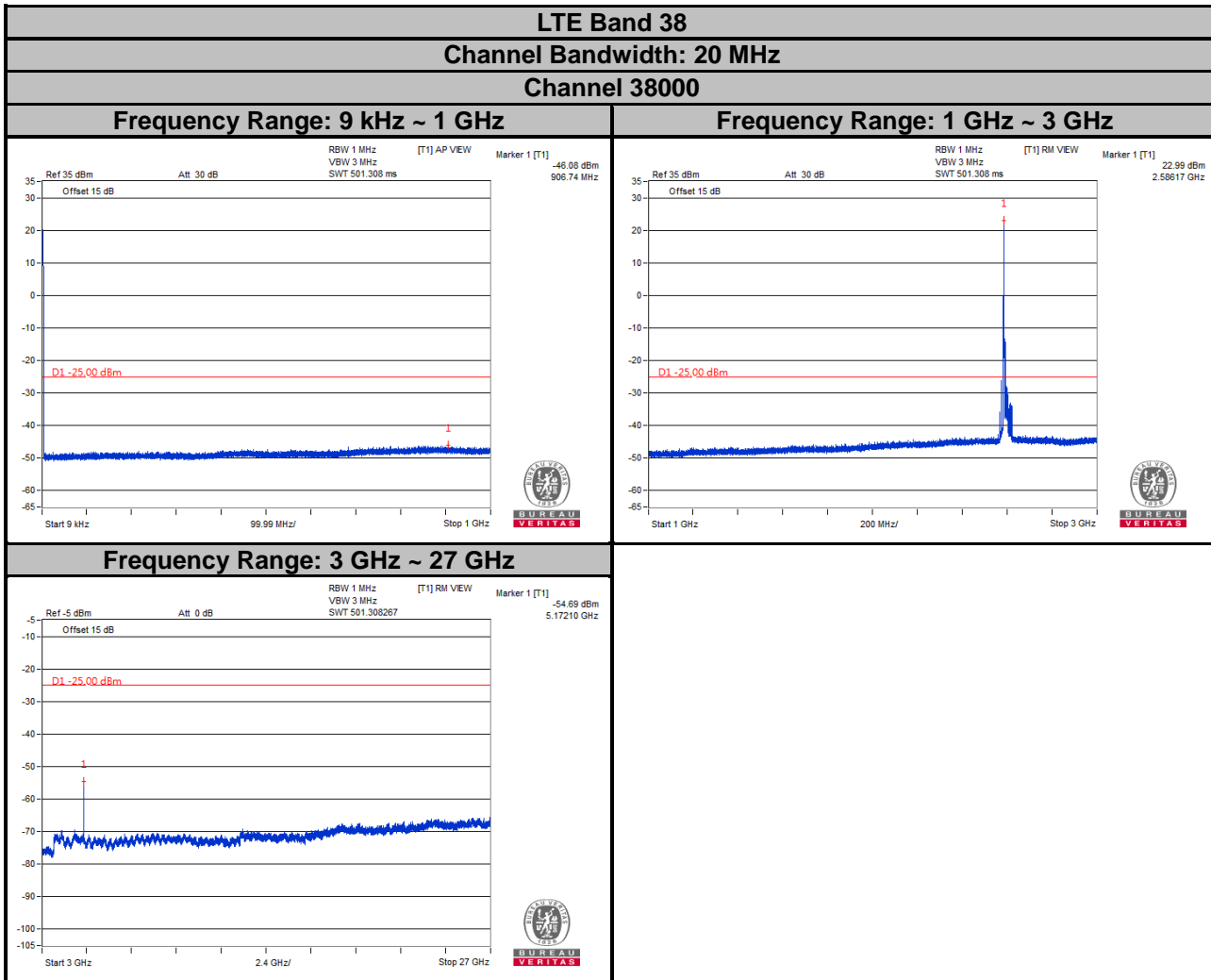

Note: The signal over the limit in 9 kHz is from spectrum analyzer.

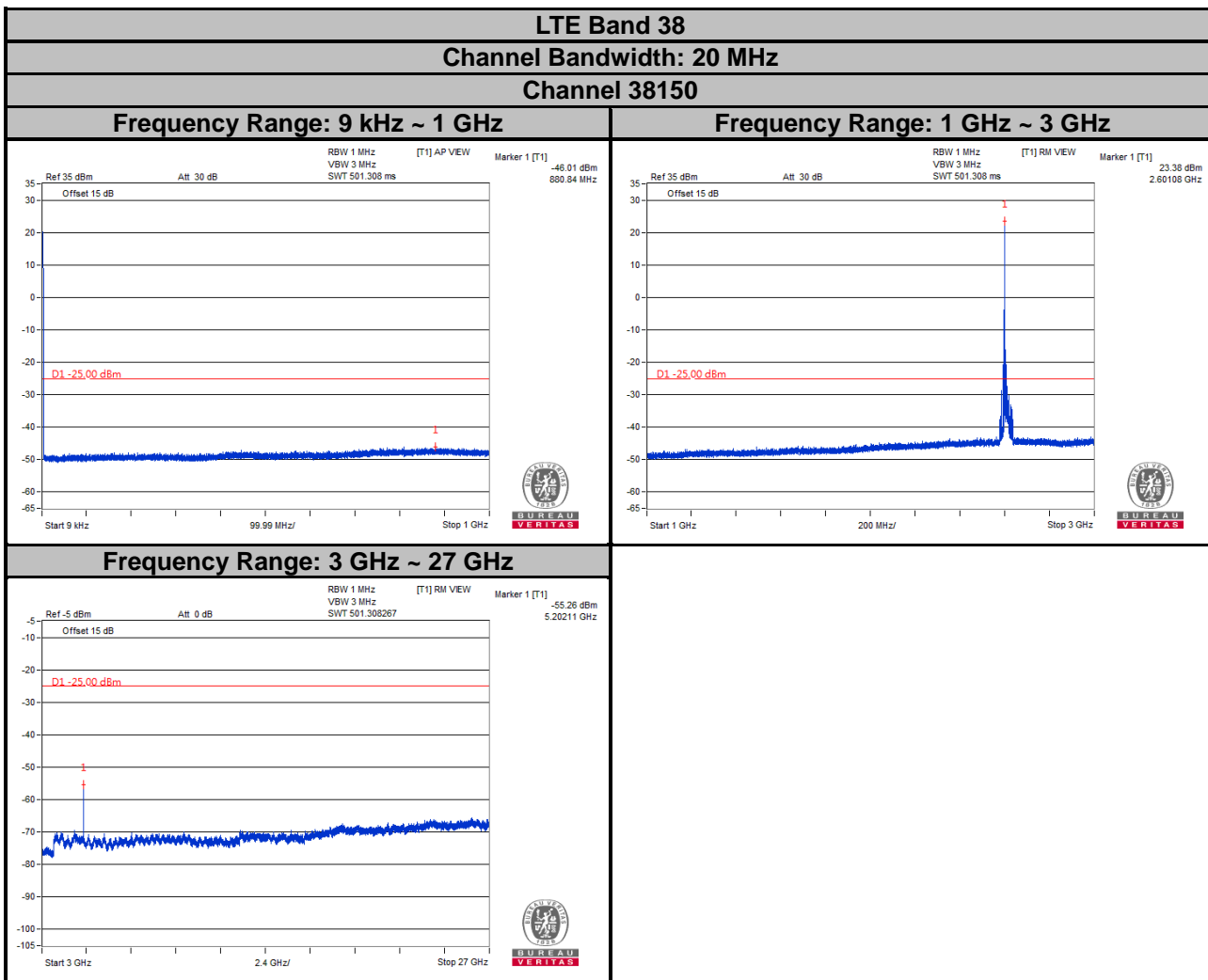

Note: The signal over the limit in 9 kHz is from spectrum analyzer.

CA Mode

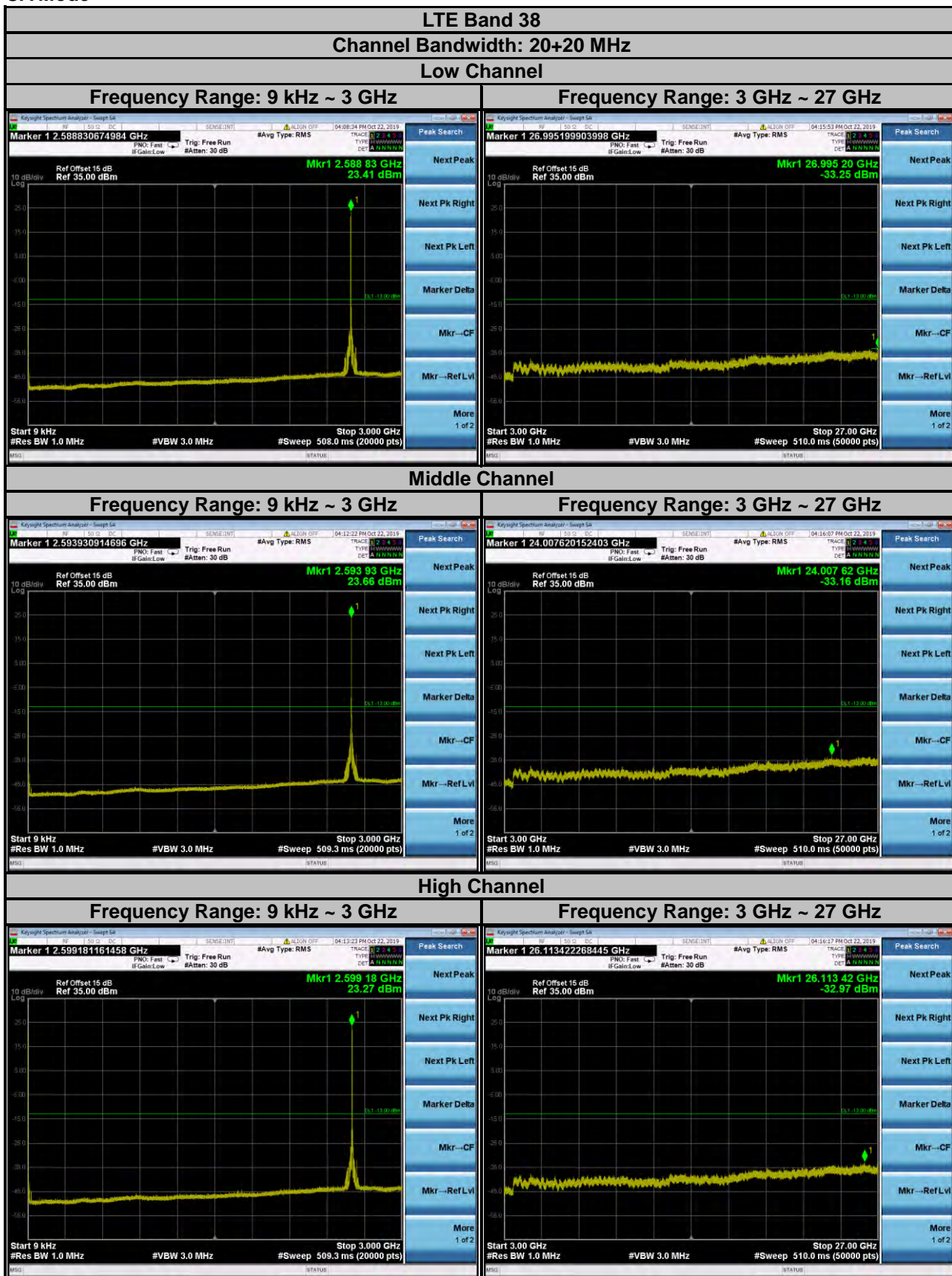

Note: The signal over the limit in 9 kHz is from spectrum analyzer.



## 4.8 Radiated Emission Measurement

### 4.8.1 Limits of Radiated Emission Measurement

The power of any emission outside a licensee's frequency block shall be attenuated below the transmitter power (P) by at least  $55 + 10 \log (P)$  dB. The limit of emission is equal to -25 dBm.

### 4.8.2 Test Procedure

- a. Substitution method is used for E.I.R.P measurement. In the semi-anechoic chamber, EUT placed on the 0.8 m (below or equal 1 GHz) and/or 1.5 m (above 1 GHz) height of Turn Table, rotated the table around 360 degrees to search the maximum radiation power and receiver antenna shall be rotated vertical and horizontal polarization and moved height from 1 m to 4 m to find the maximum polar radiated power. The "Read Value" is the spectrum reading the maximum power value.
- b. The substitution horn antenna is substituted for EUT at the same position and signals generator export the CW signal to the substitution antenna via a TX cable. Rotated the Turn Table and moved receiving antenna to find the maximum radiation power. Adjust output power level of S.G to get a Value of spectrum reading equal to "Read Value" of step a. Record the power level of S.G.
- c. EIRP = Output power level of S.G – TX cable loss + Antenna gain of substitution horn.
- d. E.R.P power can be calculated form E.I.R.P power by subtracting the gain of dipole, E.R.P power = E.I.R.P power - 2.15 dB.

**NOTE:** The resolution bandwidth of spectrum analyzer is 1 MHz and the video bandwidth is 3 MHz.

### 4.8.3 Deviation from Test Standard

No deviation.

4.8.4 Test Setup

<Radiated Emission below or equal 1 GHz>

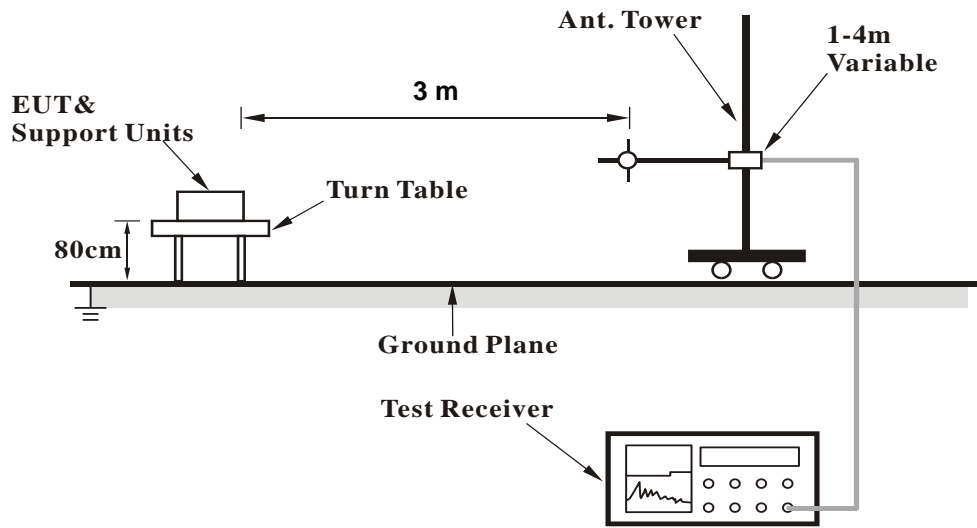

<Radiated Emission above 1 GHz>

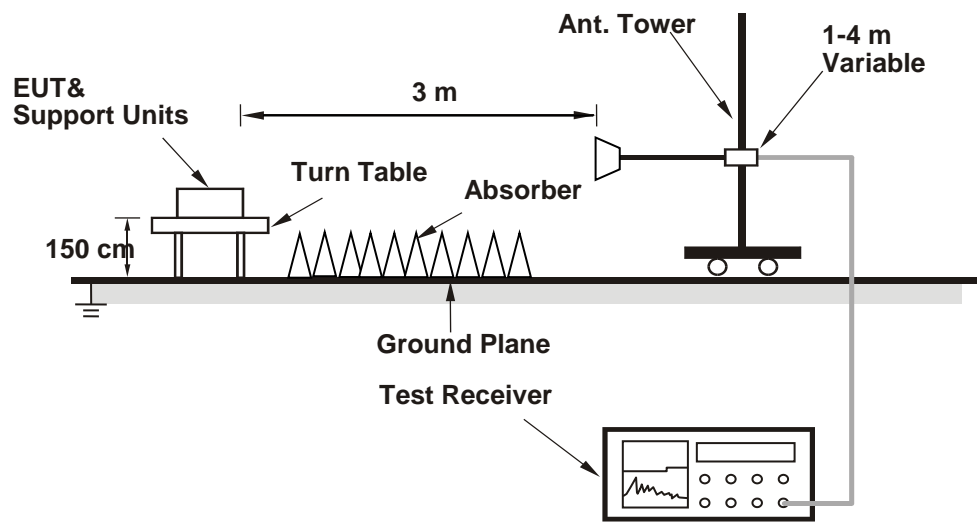

For the actual test configuration, please refer to the attached file (Test Setup Photo).

4.8.5 Test Results

LTE Band 7

Channel Bandwidth: 5 MHz / QPSK

Low Channel



Bureau Veritas Consumer Products Services Ltd., Taoyuan Branch

A D T

Data: 3

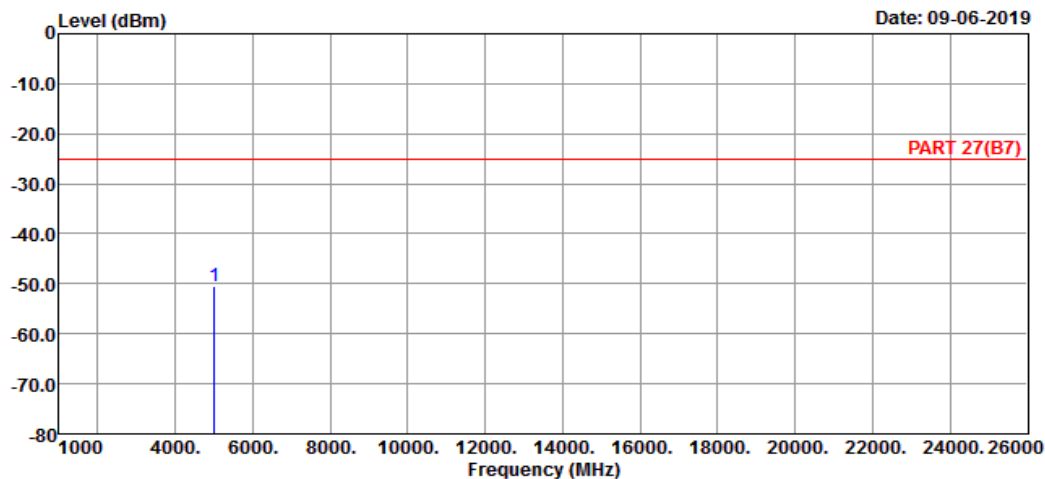

Site : 966 Chamber 5  
 Condition: PART 27(B7) HORIZONTAL  
 Remak : LTE Band 7 QPSK\_5M Link\_L-CH  
 Tested by: Thomas Wei

Freq	Level	Read Level	Limit	Line Factor	Over Limit	Remark
MHz	dBm	dBm	dBm	dB	dB	
1 pp 5005.00	-50.62	-48.16	-25.00	-2.46	-25.62	Peak



Bureau Veritas Consumer Products Services Ltd., Taoyuan Branch

A D T

Data: 4

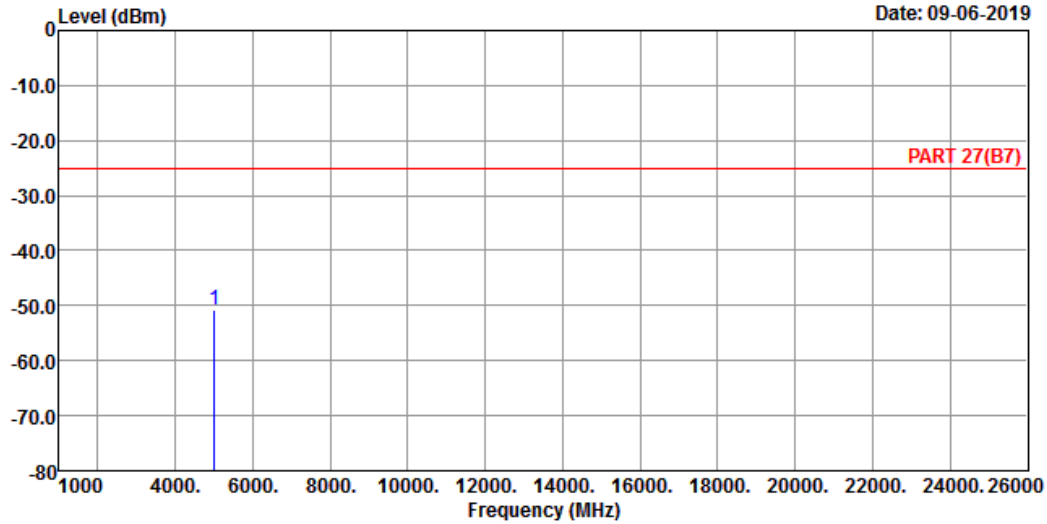

Date: 09-06-2019

Site : 966 Chamber 5  
 Condition: PART 27(B7) VERTICAL  
 Remak : LTE Band 7 QPSK\_5M Link\_L-CH  
 Tested by: Thomas Wei

Freq	Level	Read Level	Limit	Line Factor	Over Limit	Remark
MHz	dBm	dBm	dBm	dB	dB	
1 pp 5005.00	-50.68	-48.22	-25.00	-2.46	-25.68	Peak

Middle Channel



Bureau Veritas Consumer Products Services Ltd., Taoyuan Branch

A D T

Data: 3

Date: 09-06-2019

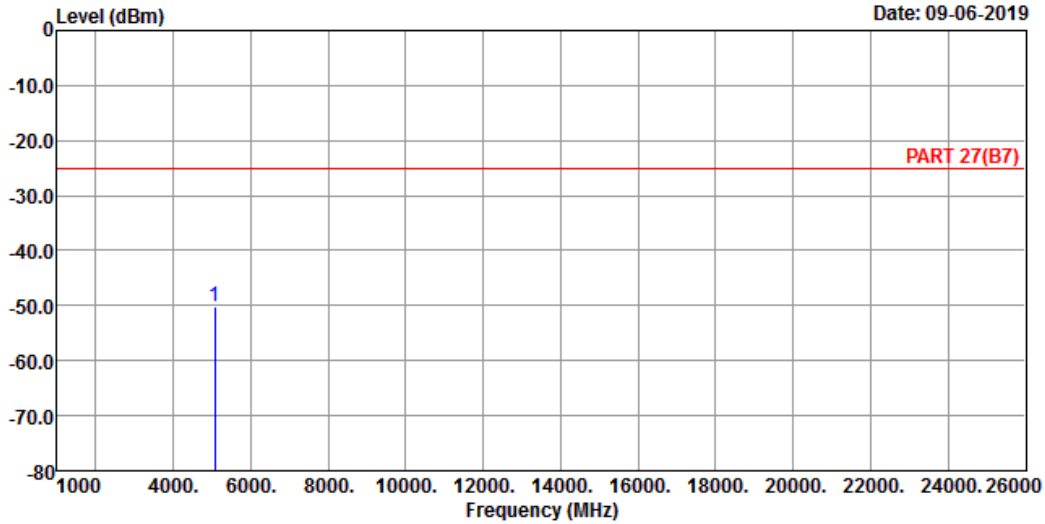

Site : 966 Chamber 5  
 Condition: PART 27(B7) HORIZONTAL  
 Remak : LTE Band 7 QPSK\_5M Link\_M-CH  
 Tested by: Thomas Wei

Freq	Level	Read Level	Limit	Line Factor	Over Limit	Remark
MHz	dBm	dBm	dBm	dB	dB	

1 pp 5070.00 -50.29 -48.42 -25.00 -1.87 -25.29 Peak



Bureau Veritas Consumer Products Services Ltd., Taoyuan Branch

A D T

Data: 4

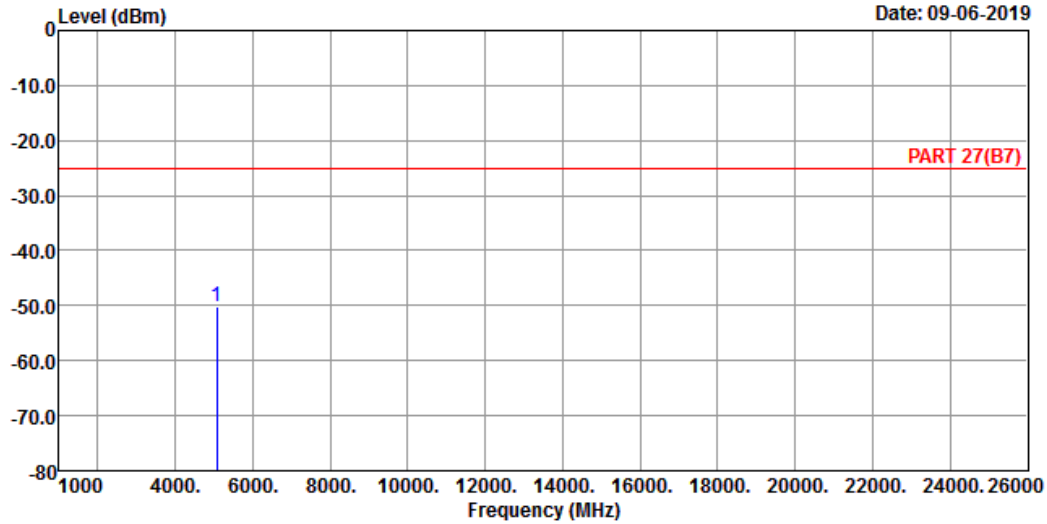

Site : 966 Chamber 5  
 Condition: PART 27(B7) VERTICAL  
 Remak : LTE Band 7 QPSK\_5M Link\_M-CH  
 Tested by: Thomas Wei

Freq	Level	Read Level	Limit	Line Factor	Over Limit	Remark
MHz	dBm	dBm	dBm	dB	dB	
1 pp 5070.00	-50.17	-48.30	-25.00	-1.87	-25.17	Peak

# High Channel



Bureau Veritas Consumer Products Services Ltd., Taoyuan Branch

A D T

Data: 3

Date: 09-06-2019

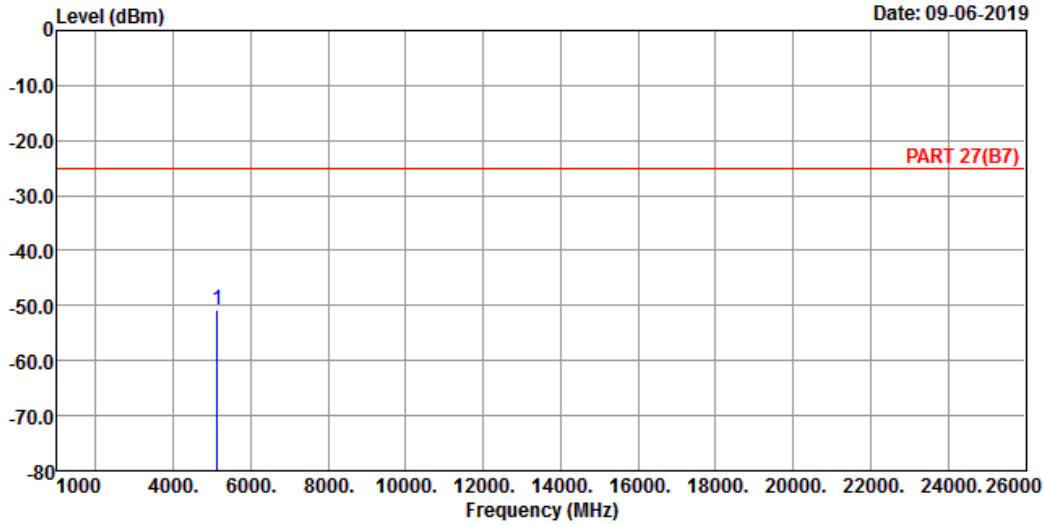

Site : 966 Chamber 5  
 Condition: PART 27(B7) HORIZONTAL  
 Remak : LTE Band 7 QPSK\_5M Link\_H-CH  
 Tested by: Thomas Wei

Freq	Level	Read Level	Limit	Line Factor	Over Limit	Remark
MHz	dBm	dBm	dBm	dB	dB	

1 pp 5135.00 -50.83 -49.09 -25.00 -1.74 -25.83 Peak





Bureau Veritas Consumer Products Services Ltd., Taoyuan Branch

A D T

Data: 4

Date: 09-06-2019

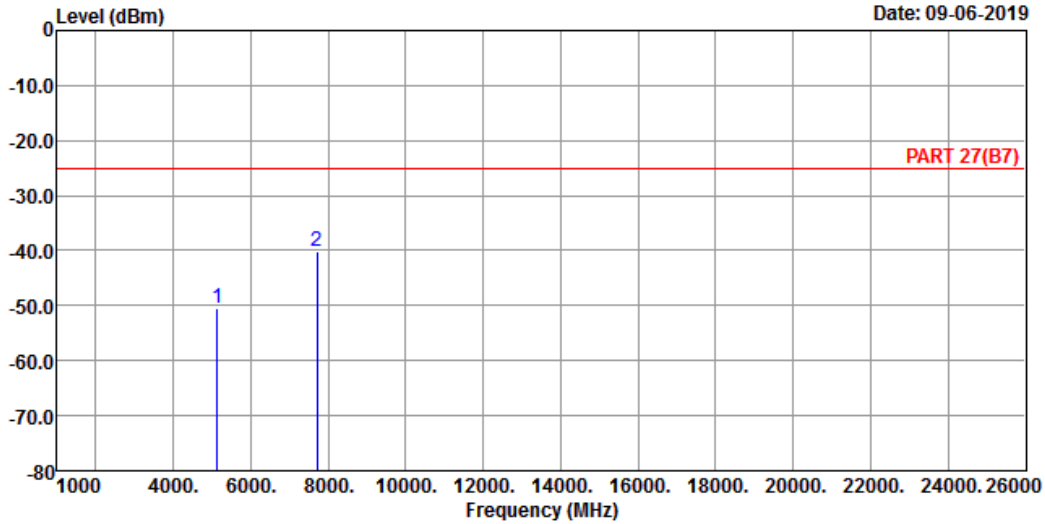

Site : 966 Chamber 5  
 Condition: PART 27(B7) VERTICAL  
 Remak : LTE Band 7 QPSK\_5M Link\_H-CH  
 Tested by: Thomas Wei

	Freq	Level	Read Level	Limit	Line Factor	Over Limit	Remark
	MHz	dBm	dBm	dBm	dB	dB	
1	5135.00	-50.36	-48.62	-25.00	-1.74	-25.36	Peak
2 pp	7702.50	-40.01	-44.63	-25.00	4.62	-15.01	Peak

Channel Bandwidth: 20 MHz / QPSK  
Low Channel



Bureau Veritas Consumer Products Services Ltd., Taoyuan Branch

A D T

Data: 3

Date: 09-06-2019

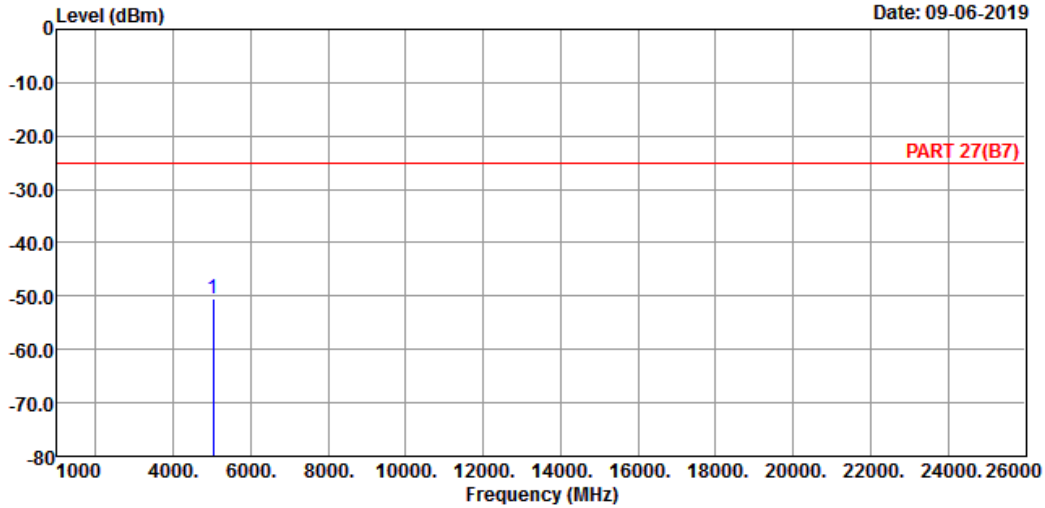

Site : 966 Chamber 5  
Condition: PART 27(B7) HORIZONTAL  
Remak : LTE Band 7 QPSK\_20M Link\_L-CH  
Tested by: Thomas Wei

Freq	Level	Read Level	Limit	Over	Remark
MHz	dBm	dBm	dBm	dB	dB
1 pp 5020.00	-50.49	-48.17	-25.00	-2.32	-25.49 Peak



Bureau Veritas Consumer Products Services Ltd., Taoyuan Branch

A D T

Data: 4

Date: 09-06-2019

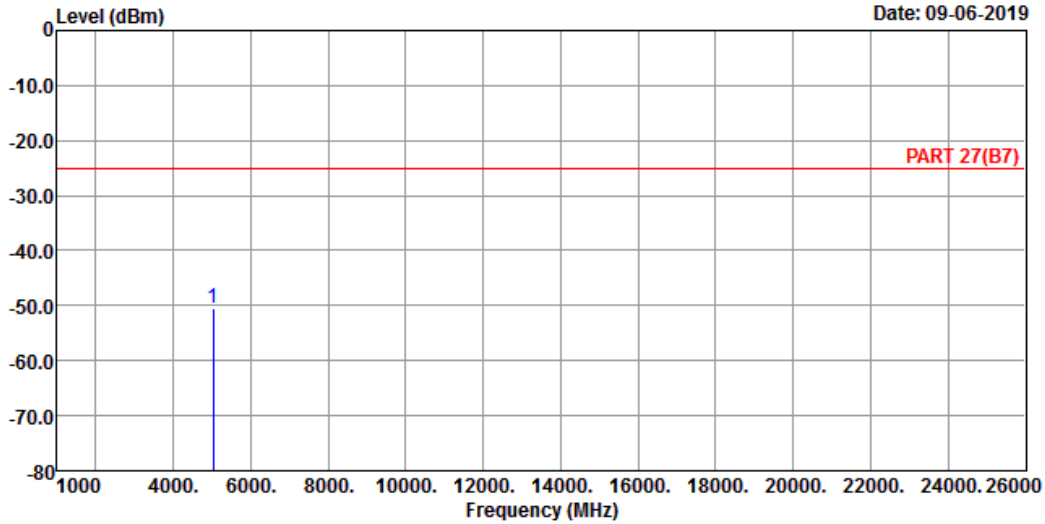

Site : 966 Chamber 5  
 Condition: PART 27(B7) VERTICAL  
 Remak : LTE Band 7 QPSK\_20M Link\_L-CH  
 Tested by: Thomas Wei

Freq	Level	Read Level	Limit	Line Factor	Over Limit	Remark
MHz	dBm	dBm	dBm	dB	dB	
1 pp 5020.00	-50.56	-48.24	-25.00	-2.32	-25.56	Peak

Middle Channel



Bureau Veritas Consumer Products Services Ltd., Taoyuan Branch

A D T

Data: 3

Date: 08-15-2019

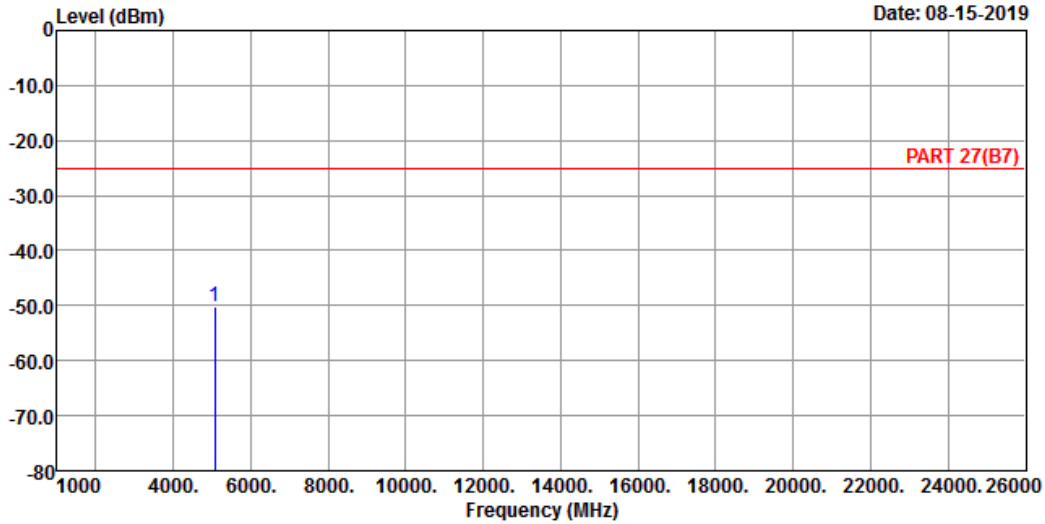

Site : 966 Chamber 5  
 Condition: PART 27(B7) HORIZONTAL  
 Remak : LTE Band 7 QPSK\_20M Link\_M-CH  
 Tested by: Thomas Wei

Freq	Level	Read Level	Limit	Line Factor	Over Limit	Remark
MHz	dBm	dBm	dBm	dB	dB	

1 pp 5070.00 -50.18 -48.31 -25.00 -1.87 -25.18 Peak



Bureau Veritas Consumer Products Services Ltd., Taoyuan Branch

A D T

Data: 4

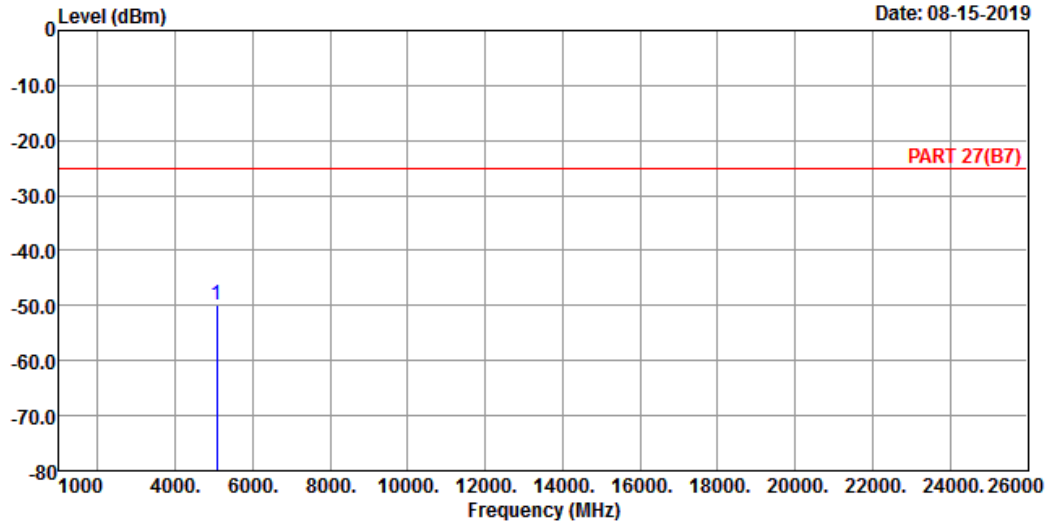

Date: 08-15-2019

Site : 966 Chamber 5  
 Condition: PART 27(B7) VERTICAL  
 Remak : LTE Band 7 QPSK\_20M Link\_M-CH  
 Tested by: Thomas Wei

Freq	Level	Read Level	Limit	Line Factor	Over Limit	Remark
MHz	dBm	dBm	dBm	dB	dB	
1 pp 5070.00	-49.91	-48.04	-25.00	-1.87	-24.91	Peak

# High Channel



Bureau Veritas Consumer Products Services Ltd., Taoyuan Branch

A D T

Data: 5

Date: 09-06-2019

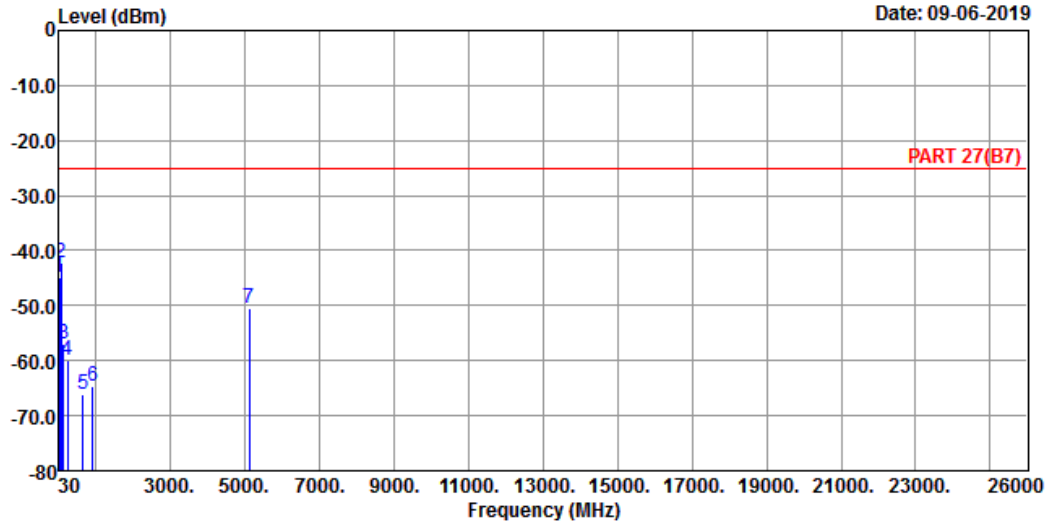

Site : 966 Chamber 5  
 Condition: PART 27(B7) HORIZONTAL  
 Remak : LTE Band 7 QPSK\_20M Link\_H-CH  
 Tested by: Thomas Wei

	Freq	Level	Read Level	Limit	Line Factor	Over Limit	Remark
	MHz	dBm	dBm	dBm	dB	dB	
1	42.61	-44.86	-43.92	-25.00	-0.94	-19.86	Peak
2 pp	78.50	-42.21	-31.78	-25.00	-10.43	-17.21	Peak
3	135.73	-57.03	-48.36	-25.00	-8.67	-32.03	Peak
4	243.40	-59.91	-53.64	-25.00	-6.27	-34.91	Peak
5	663.41	-66.22	-65.55	-25.00	-0.67	-41.22	Peak
6	919.49	-64.64	-65.69	-25.00	1.05	-39.64	Peak
7	5120.00	-50.62	-48.96	-25.00	-1.66	-25.62	Peak



Bureau Veritas Consumer Products Services Ltd., Taoyuan Branch

A D T

Data: 6

Date: 09-06-2019

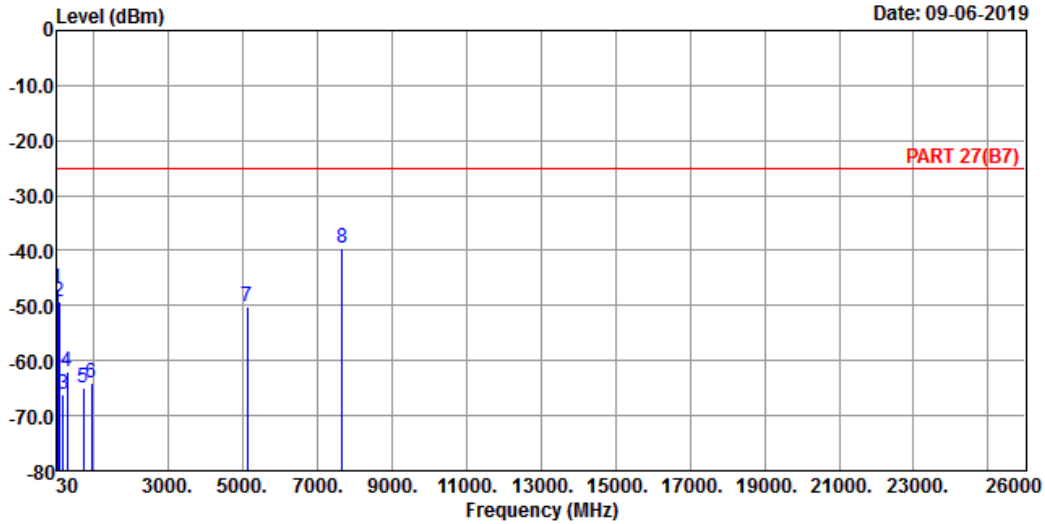

Site : 966 Chamber 5  
 Condition: PART 27(B7) VERTICAL  
 Remak : LTE Band 7 QPSK\_20M Link\_H-CH  
 Tested by: Thomas Wei

	Freq	Level	Read Level	Limit	Line Factor	Over Limit	Remark
	MHz	dBm	dBm	dBm	dB	dB	
1	36.79	-47.01	-46.02	-25.00	-0.99	-22.01	Peak
2	77.53	-49.38	-39.18	-25.00	-10.20	-24.38	Peak
3	185.20	-66.14	-58.90	-25.00	-7.24	-41.14	Peak
4	289.96	-62.07	-55.26	-25.00	-6.81	-37.07	Peak
5	736.16	-65.08	-65.69	-25.00	0.61	-40.08	Peak
6	958.29	-64.13	-66.24	-25.00	2.11	-39.13	Peak
7	5120.00	-50.08	-48.42	-25.00	-1.66	-25.08	Peak
8 pp	7680.00	-39.65	-44.27	-25.00	4.62	-14.65	Peak



LTE Band 38  
 Channel Bandwidth: 5 MHz / QPSK  
 Low Channel



Bureau Veritas Consumer Products Services Ltd., Taoyuan Branch

A D T

Data: 3

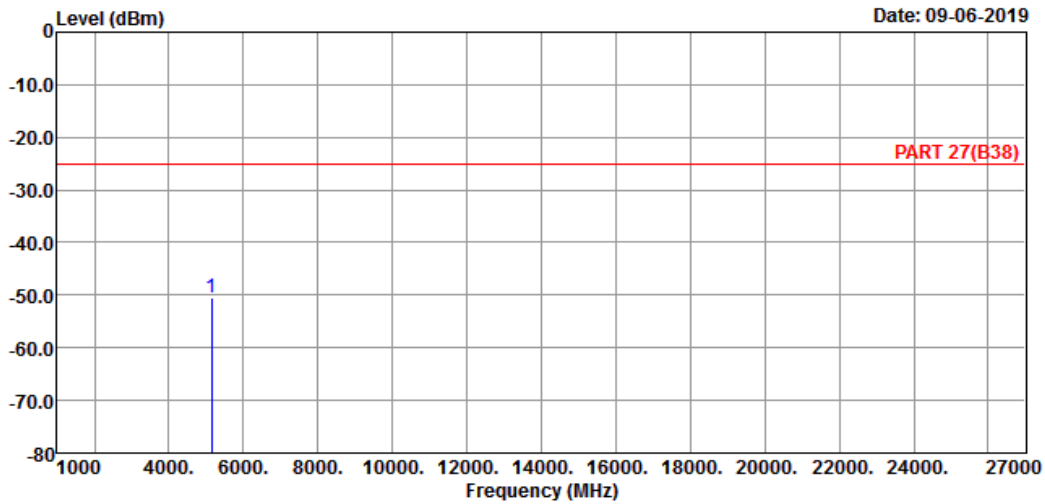

Site : 966 Chamber 5  
 Condition: PART 27(B38) HORIZONTAL  
 Remak : LTE Band 38 QPSK\_5M Link\_L-CH  
 Tested by: Thomas Wei

Freq	Level	Read Level	Limit	Line Factor	Over Limit	Remark
MHz	dBm	dBm	dBm	dB	dB	

1 pp 5145.00 -50.50 -48.67 -25.00 -1.83 -25.50 Peak



Bureau Veritas Consumer Products Services Ltd., Taoyuan Branch

A D T

Data: 4

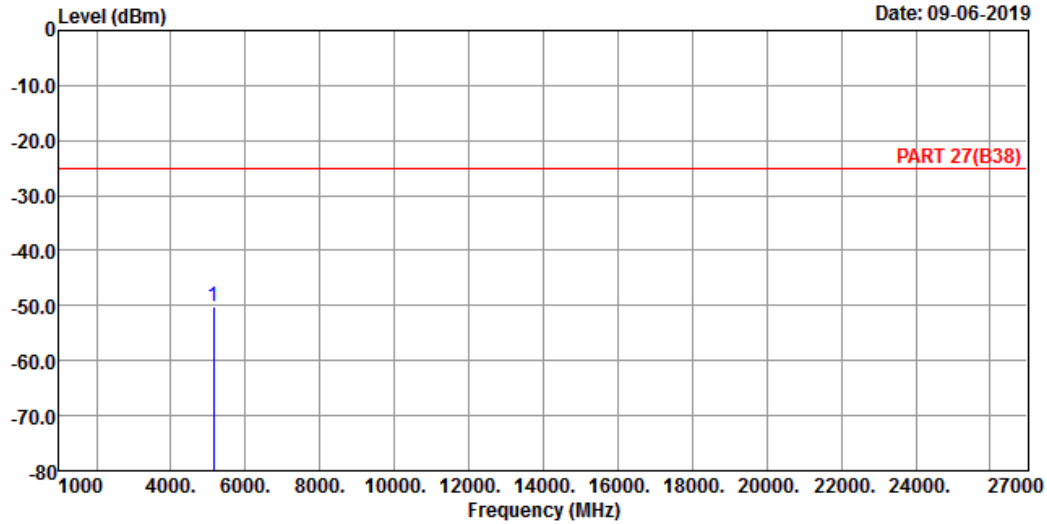

Site : 966 Chamber 5  
 Condition: PART 27(B38) VERTICAL  
 Remak : LTE Band 38 QPSK\_5M Link\_L-CH  
 Tested by: Thomas Wei

Freq	Level	Read Level	Limit	Line Factor	Over Limit	Remark
MHz	dBm	dBm	dBm	dB	dB	
1 pp 5145.00	-50.29	-48.46	-25.00	-1.83	-25.29	Peak

Middle Channel



Bureau Veritas Consumer Products Services Ltd., Taoyuan Branch

A D T

Data: 3

Date: 09-06-2019

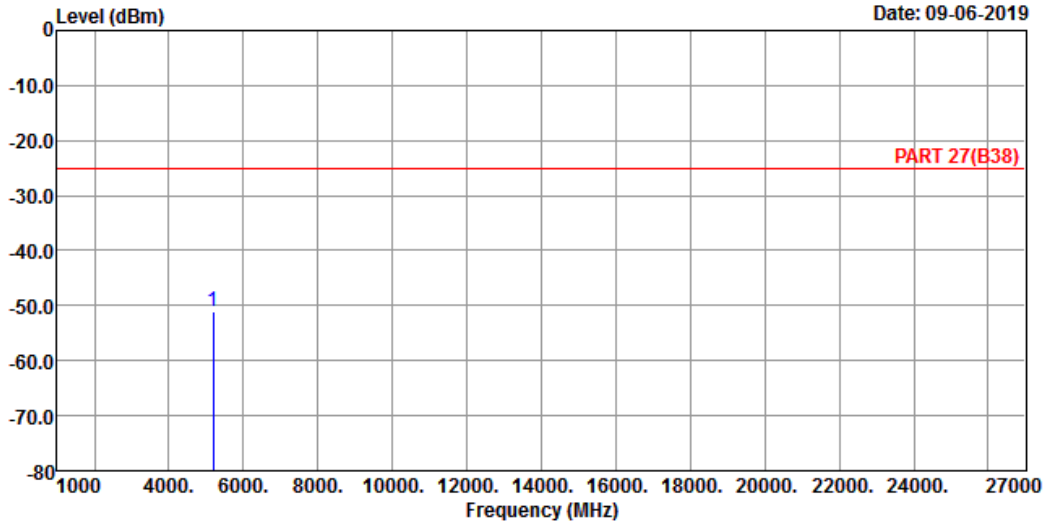

Site : 966 Chamber 5  
 Condition: PART 27(B38) HORIZONTAL  
 Remak : LTE Band 38 QPSK\_5M Link\_M-CH  
 Tested by: Thomas Wei

Freq	Level	Read Level	Limit	Line Factor	Over Limit	Remark
MHz	dBm	dBm	dBm	dB	dB	

1 pp 5190.00 -51.17 -49.10 -25.00 -2.07 -26.17 Peak



Bureau Veritas Consumer Products Services Ltd., Taoyuan Branch

A D T

Data: 4

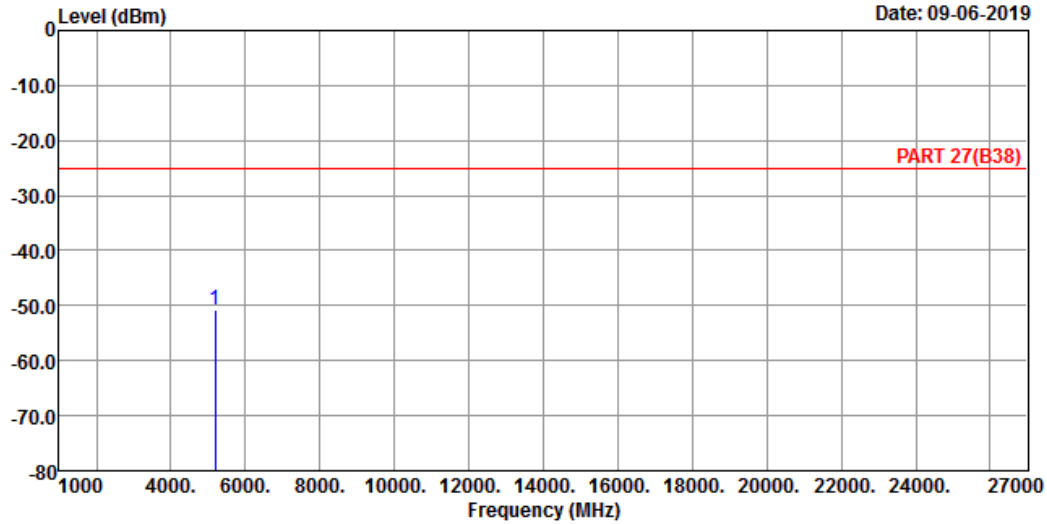

Site : 966 Chamber 5  
 Condition: PART 27(B38) VERTICAL  
 Remak : LTE Band 38 QPSK\_5M Link\_M-CH  
 Tested by: Thomas Wei

Freq	Level	Read Level	Limit	Line Factor	Over Limit	Remark
MHz	dBm	dBm	dBm	dB	dB	
1 pp 5190.00	-50.83	-48.76	-25.00	-2.07	-25.83	Peak

# High Channel



Bureau Veritas Consumer Products Services Ltd., Taoyuan Branch

A D T

Data: 3

Date: 09-06-2019

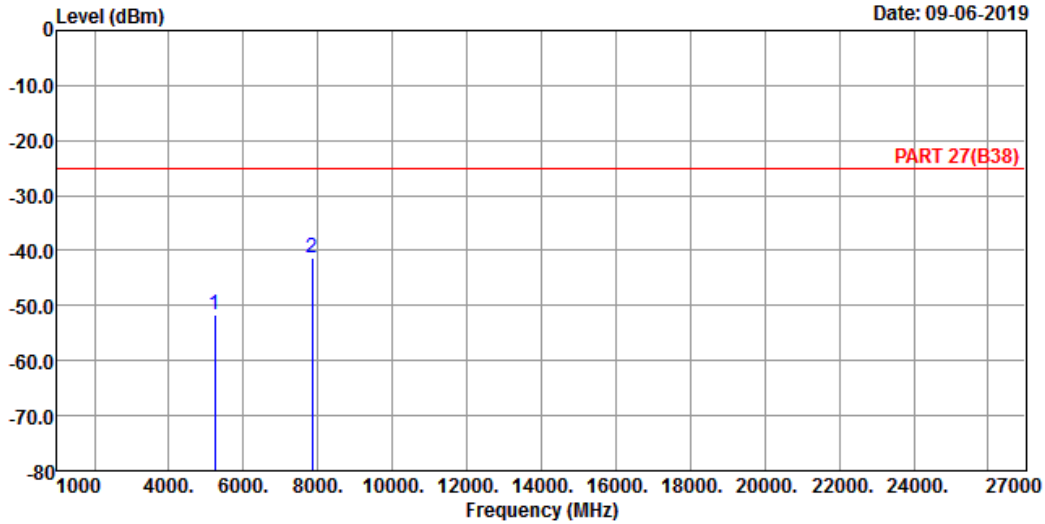

Site : 966 Chamber 5  
 Condition: PART 27(B38) HORIZONTAL  
 Remak : LTE Band 38 QPSK\_5M Link\_H-CH  
 Tested by: Thomas Wei

	Freq	Level	Read Level	Limit	Line Factor	Over Limit	Remark
	MHz	dBm	dBm	dBm	dB	dB	
1	5235.00	-51.77	-49.36	-25.00	-2.41	-26.77	Peak
2 pp	7852.50	-41.21	-46.18	-25.00	4.97	-16.21	Peak



Bureau Veritas Consumer Products Services Ltd., Taoyuan Branch

A D T

Data: 4

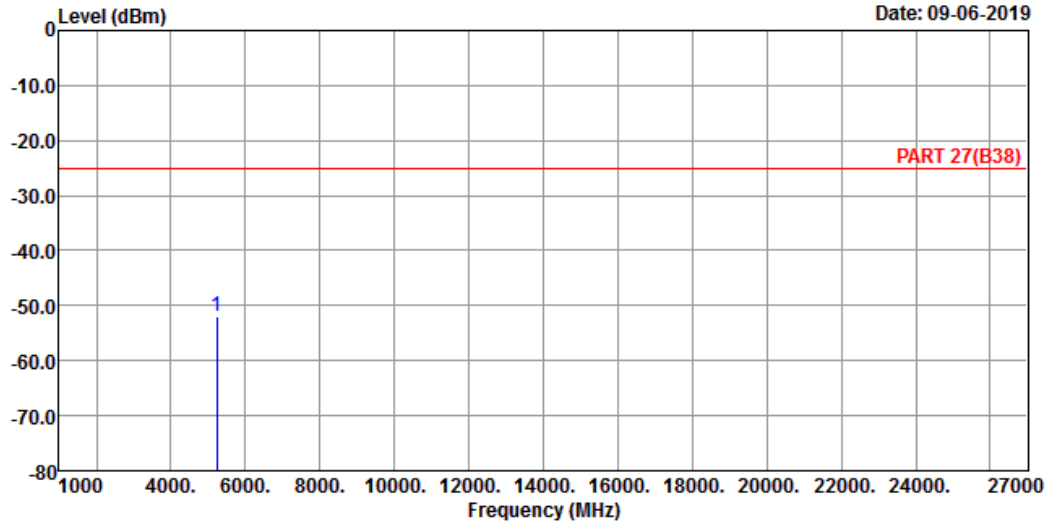

Site : 966 Chamber 5  
 Condition: PART 27(B38) VERTICAL  
 Remak : LTE Band 38 QPSK\_5M Link\_H-CH  
 Tested by: Thomas Wei

Freq	Level	Read Level	Limit	Over	Remark
MHz	dBm	dBm	dBm	dB	
1 pp 5235.00	-51.82	-49.41	-25.00	-2.41	-26.82 Peak

Channel Bandwidth: 20 MHz / QPSK  
Low Channel



Bureau Veritas Consumer Products Services Ltd., Taoyuan Branch

A D T

Data: 3

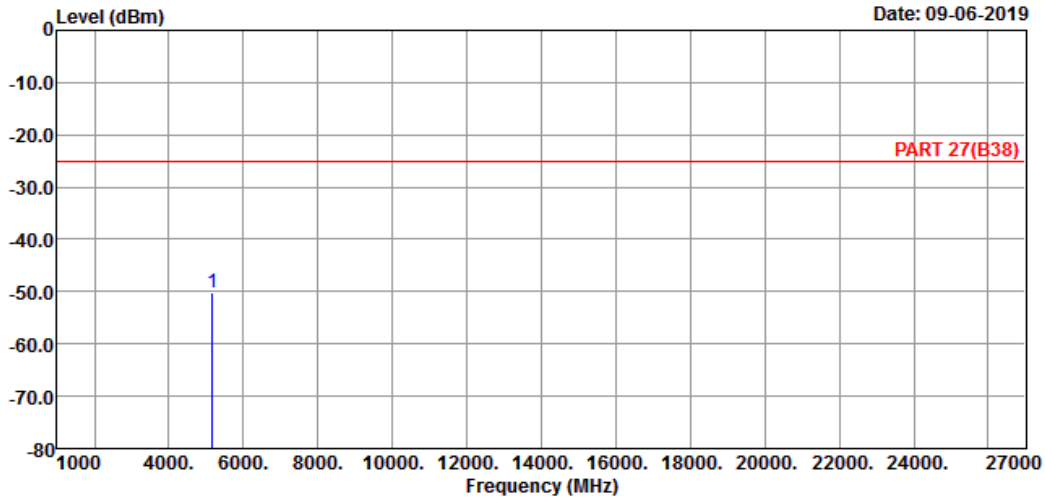

Site : 966 Chamber 5  
Condition: PART 27(B38) HORIZONTAL  
Remak : LTE Band 38 QPSK\_20M Link\_L-CH  
Tested by: Thomas Wei

Freq	Level	Read Level	Limit	Line Factor	Over Limit	Remark
MHz	dBm	dBm	dBm	dB	dB	
5160.00	-50.28	-48.37	-25.00	-1.91	-25.28	Peak





Bureau Veritas Consumer Products Services Ltd., Taoyuan Branch

A D T

Data: 4

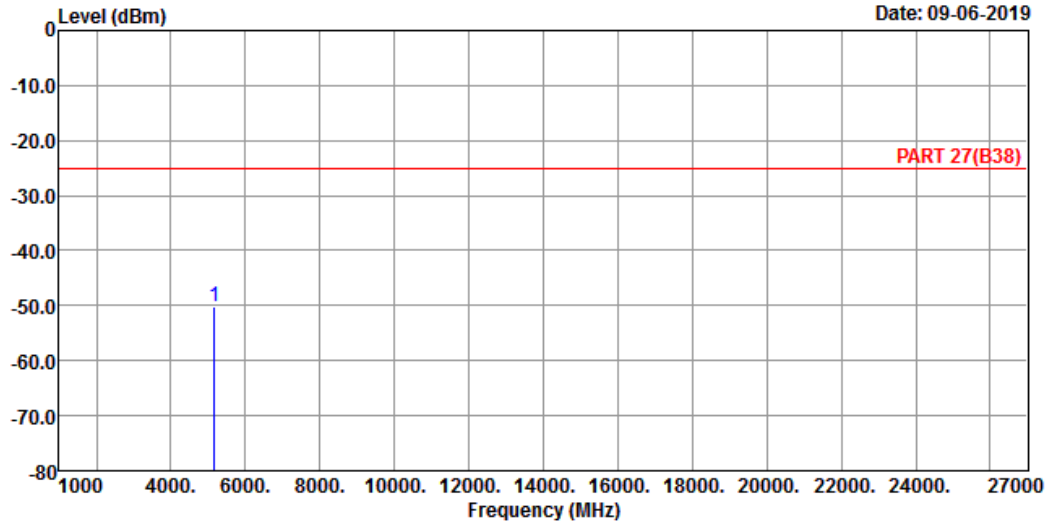

Site : 966 Chamber 5  
 Condition: PART 27(B38) VERTICAL  
 Remark : LTE Band 38 QPSK\_20M Link\_L-CH  
 Tested by: Thomas Wei

Freq	Level	Read Level	Limit	Line Factor	Over Limit	Remark
MHz	dBm	dBm	dBm	dB	dB	
1 pp 5160.00	-50.15	-48.24	-25.00	-1.91	-25.15	Peak

Middle Channel



Bureau Veritas Consumer Products Services Ltd., Taoyuan Branch

A D T

Data: 3

Date: 08-15-2019

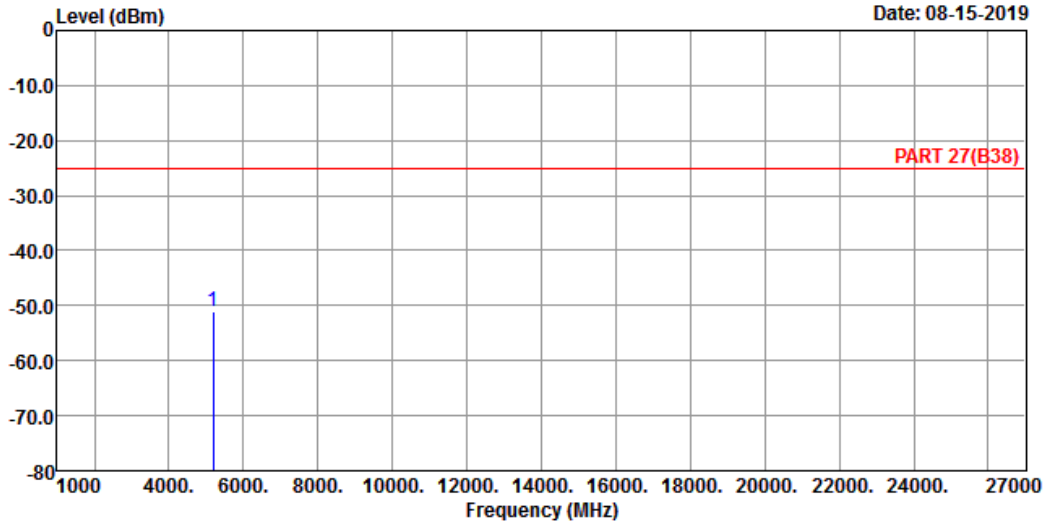

Site : 966 Chamber 5  
 Condition: PART 27(B38) HORIZONTAL  
 Remak : LTE Band 38 QPSK\_20M Link\_M-CH  
 Tested by: Thomas Wei

Freq	Level	Read Level	Limit	Line Factor	Over Limit	Remark
MHz	dBm	dBm	dBm	dB	dB	

1 pp 5190.00 -50.93 -48.86 -25.00 -2.07 -25.93 Peak



Bureau Veritas Consumer Products Services Ltd., Taoyuan Branch

A D T

Data: 4

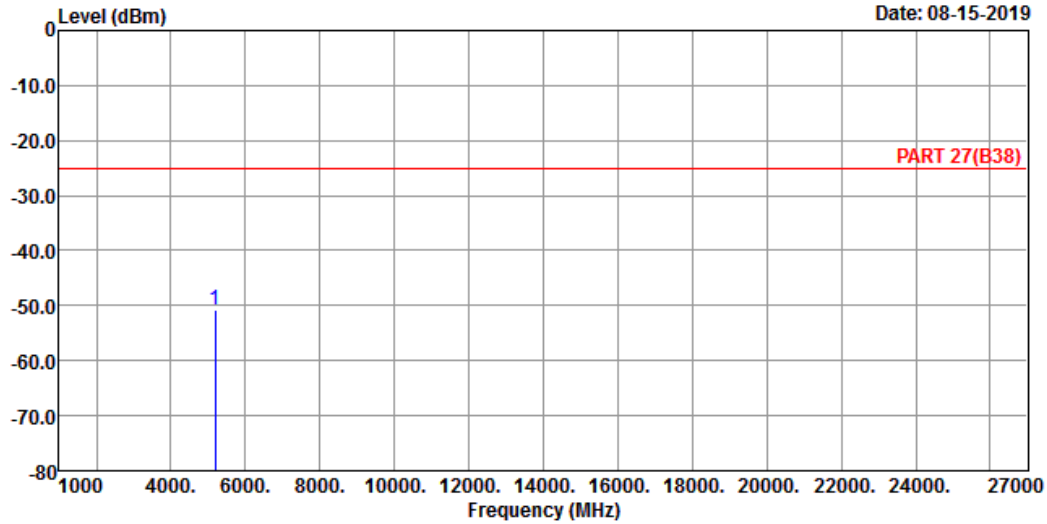

Site : 966 Chamber 5  
 Condition: PART 27(B38) VERTICAL  
 Remak : LTE Band 38 QPSK\_20M Link\_M-CH  
 Tested by: Thomas Wei

Freq	Level	Read Level	Limit	Line Factor	Over Limit	Remark
MHz	dBm	dBm	dBm	dB	dB	
1 pp 5190.00	-50.69	-48.62	-25.00	-2.07	-25.69	Peak

# High Channel



Bureau Veritas Consumer Products Services Ltd., Taoyuan Branch

A D T

Data: 5

Date: 09-06-2019

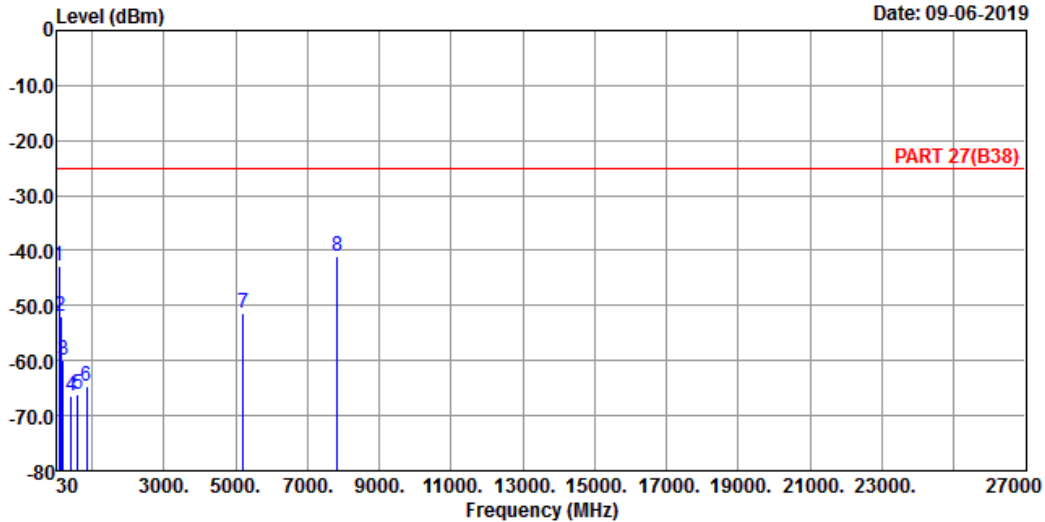

Site : 966 Chamber 5  
 Condition: PART 27(B38) HORIZONTAL  
 Remak : LTE Band 38 QPSK\_20M Link\_H-CH  
 Tested by: Thomas Wei

	Freq	Level	Read Level	Limit	Line Factor	Over Limit	Remark
	MHz	dBm	dBm	dBm	dB	dB	
1	77.53	-42.68	-32.48	-25.00	-10.20	-17.68	Peak
2	135.73	-52.08	-43.41	-25.00	-8.67	-27.08	Peak
3	194.90	-59.89	-52.34	-25.00	-7.55	-34.89	Peak
4	419.94	-66.44	-60.65	-25.00	-5.79	-41.44	Peak
5	596.48	-66.08	-65.17	-25.00	-0.91	-41.08	Peak
6	845.77	-64.72	-65.05	-25.00	0.33	-39.72	Peak
7	5220.00	-51.50	-49.20	-25.00	-2.30	-26.50	Peak
8 pp	7830.00	-40.95	-45.82	-25.00	4.87	-15.95	Peak



Bureau Veritas Consumer Products Services Ltd., Taoyuan Branch

A D T

Data: 6

Date: 09-06-2019

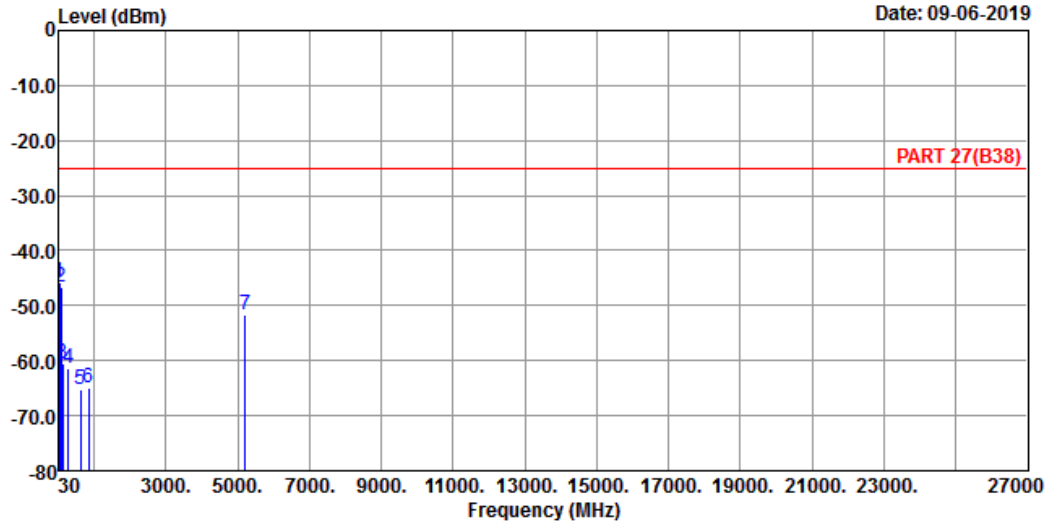

Site : 966 Chamber 5  
 Condition: PART 27(B38) VERTICAL  
 Remak : LTE Band 38 QPSK\_20M Link\_H-CH  
 Tested by: Thomas Wei

	Freq	Level	Read Level	Limit	Line Factor	Over Limit	Remark
	MHz	dBm	dBm	dBm	dB	dB	
1 pp	43.58	-45.65	-44.18	-25.00	-1.47	-20.65	Peak
2	75.59	-46.55	-36.80	-25.00	-9.75	-21.55	Peak
3	133.79	-60.40	-51.72	-25.00	-8.68	-35.40	Peak
4	289.96	-61.50	-54.69	-25.00	-6.81	-36.50	Peak
5	632.37	-65.32	-64.48	-25.00	-0.84	-40.32	Peak
6	848.68	-64.86	-65.16	-25.00	0.30	-39.86	Peak
7	5220.00	-51.60	-49.30	-25.00	-2.30	-26.60	Peak

CA Mode  
 LTE Band 7 + Band 7  
 Channel Bandwidth: 20+20 MHz / QPSK  
 Channel 20850+21048



Bureau Veritas Consumer Products Services Ltd., Taoyuan Branch

A D T

Data: 5

Date: 09-12-2019

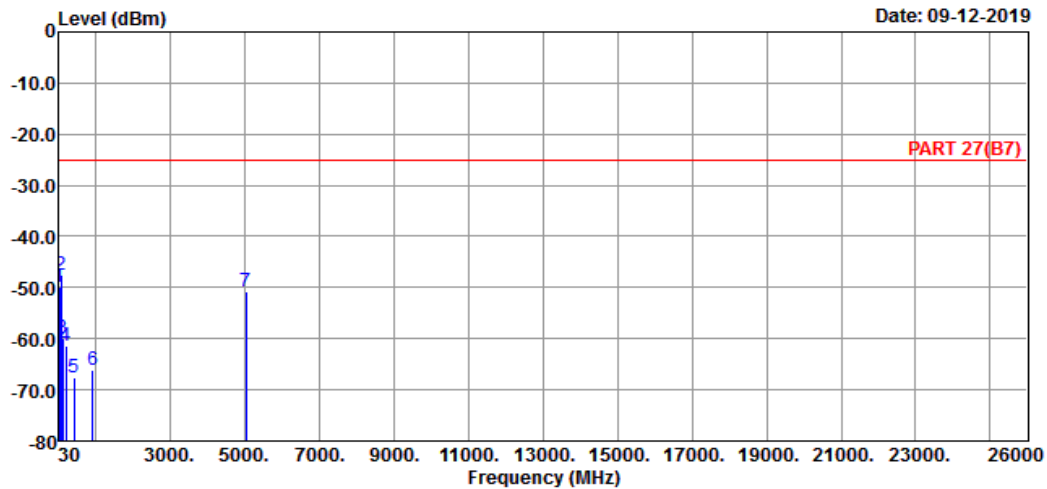

Site : 966 Chamber 5  
 Condition: PART 27(B7) HORIZONTAL  
 Remak : LTE Band 7 QPSK\_40M Link\_CH20850+21048  
 Tested by: Thomas Wei

	Freq	Level	Read Level	Limit	Line Factor	Over Limit	Remark
	MHz	dBm	dBm	dBm	dB	dB	
1	45.52	-49.94	-47.44	-25.00	-2.50	-24.94	Peak
2 pp	81.41	-47.44	-36.53	-25.00	-10.91	-22.44	Peak
3	122.15	-60.06	-50.44	-25.00	-9.62	-35.06	Peak
4	200.72	-61.30	-53.32	-25.00	-7.98	-36.30	Peak
5	420.91	-67.52	-61.74	-25.00	-5.78	-42.52	Peak
6	927.25	-66.11	-67.36	-25.00	1.25	-41.11	Peak
7	5040.00	-50.71	-48.54	-25.00	-2.17	-25.71	Peak



Bureau Veritas Consumer Products Services Ltd., Taoyuan Branch

A D T

Data: 6

Date: 09-12-2019

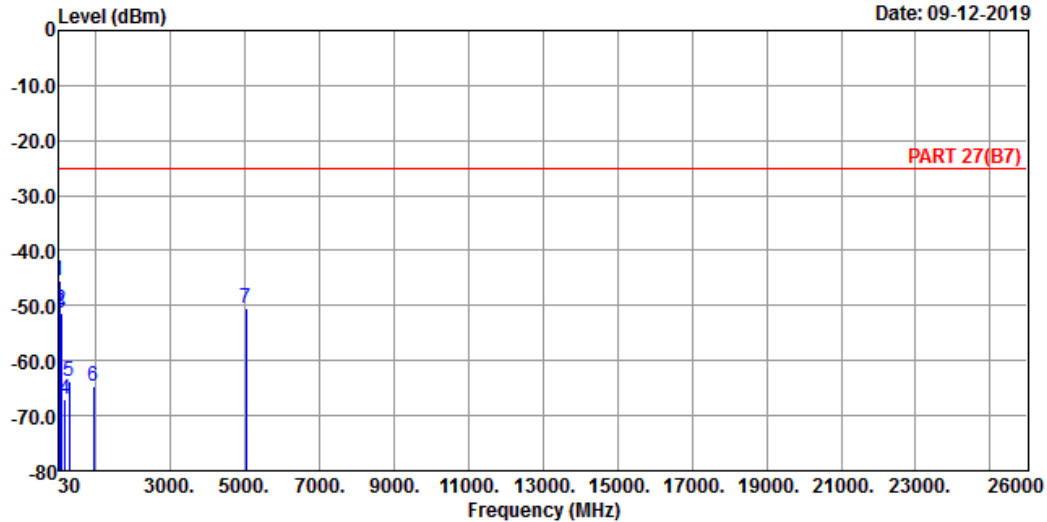

Site : 966 Chamber 5  
 Condition: PART 27(B7) VERTICAL  
 Remak : LTE Band 7 QPSK\_40M Link\_CH20850+21048  
 Tested by: Thomas Wei

	Freq	Level	Read Level	Limit	Line Factor	Over Limit	Remark
	MHz	dBm	dBm	dBm	dB	dB	
1 pp	30.00	-45.33	-45.71	-25.00	0.38	-20.33	Peak
2	54.25	-50.89	-44.82	-25.00	-6.07	-25.89	Peak
3	75.59	-51.38	-41.63	-25.00	-9.75	-26.38	Peak
4	180.35	-67.15	-59.75	-25.00	-7.40	-42.15	Peak
5	293.84	-63.64	-56.75	-25.00	-6.89	-38.64	Peak
6	955.38	-64.70	-66.70	-25.00	2.00	-39.70	Peak
7	5040.00	-50.54	-48.37	-25.00	-2.17	-25.54	Peak



LTE Band 7 + Band 7  
 Channel Bandwidth: 20+20 MHz / QPSK  
 Channel 21001+21199



Bureau Veritas Consumer Products Services Ltd., Taoyuan Branch

A D T

Data: 5

Date: 09-12-2019

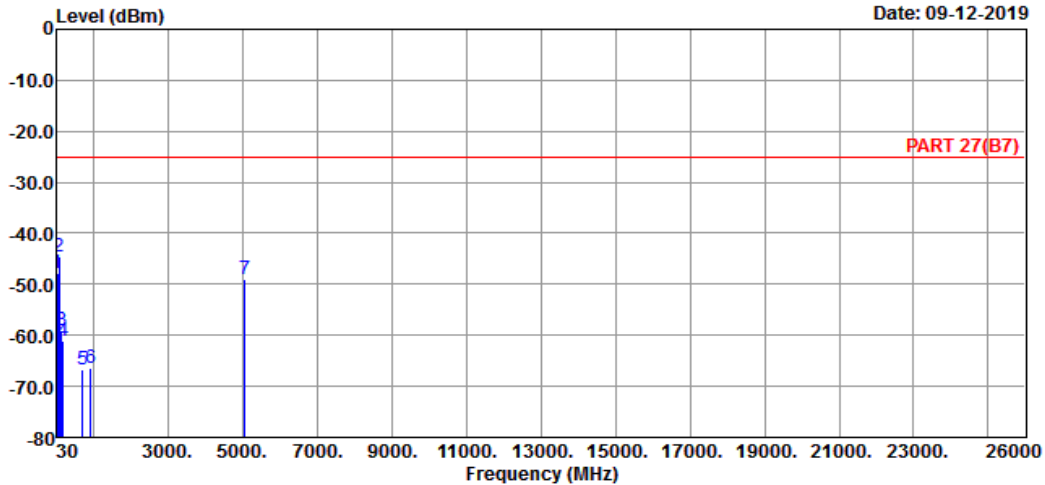

Site : 966 Chamber 5  
 Condition: PART 27(B7) HORIZONTAL  
 Remak : LTE Band 7 QPSK\_40M Link\_CH21001+ 21199  
 Tested by: Thomas Wei

	Freq	Level	Read Level	Limit	Over	Over	Remark
	MHz	dBm	dBm	dBm	dB	dB	
1	43.58	-47.93	-46.46	-25.00	-1.47	-22.93	Peak
2 pp	75.59	-44.46	-34.71	-25.00	-9.75	-19.46	Peak
3	137.67	-58.92	-50.26	-25.00	-8.66	-33.92	Peak
4	186.17	-61.08	-53.87	-25.00	-7.21	-36.08	Peak
5	716.76	-66.65	-66.88	-25.00	0.23	-41.65	Peak
6	935.01	-66.43	-67.87	-25.00	1.44	-41.43	Peak
7	5070.20	-48.87	-47.00	-25.00	-1.87	-23.87	Peak



Bureau Veritas Consumer Products Services Ltd., Taoyuan Branch

A D T

Data: 6

Date: 09-12-2019

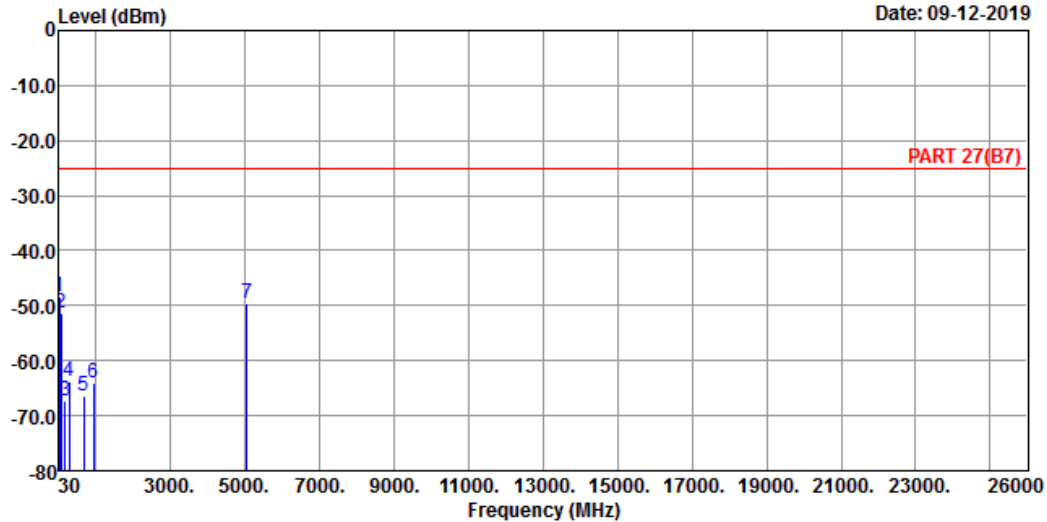

Site : 966 Chamber 5  
 Condition: PART 27(B7) VERTICAL  
 Remak : LTE Band 7 QPSK\_40M Link\_CH21001+ 21199  
 Tested by: Thomas Wei

	Read	Limit	Over			
Freq	Level	Level	Line	Factor	Limit	Remark
MHz	dBm	dBm	dBm	dB	dB	
1 pp	35.82	-48.29	-46.76	-25.00	-1.53	-23.29 Peak
2	75.59	-51.38	-41.63	-25.00	-9.75	-26.38 Peak
3	179.38	-67.42	-60.19	-25.00	-7.23	-42.42 Peak
4	293.84	-63.64	-56.75	-25.00	-6.89	-38.64 Peak
5	683.78	-66.30	-65.94	-25.00	-0.36	-41.30 Peak
6	958.29	-64.13	-66.24	-25.00	2.11	-39.13 Peak
7	5070.20	-49.66	-47.79	-25.00	-1.87	-24.66 Peak

LTE Band 7 + Band 7  
 Channel Bandwidth: 20+20 MHz / QPSK  
 Channel 21152+21350



Bureau Veritas Consumer Products Services Ltd., Taoyuan Branch

A D T

Data: 5

Date: 09-12-2019

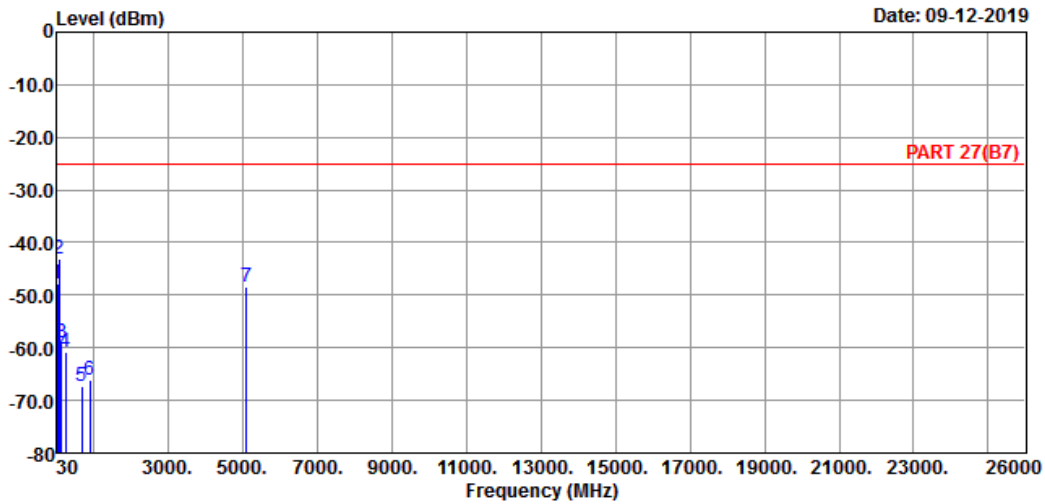

Site : 966 Chamber 5  
 Condition: PART 27(B7) HORIZONTAL  
 Remak : LTE Band 7 QPSK\_40M Link\_CH21152+21350  
 Tested by: Thomas Wei

	Freq	Level	Read Level	Limit	Line Factor	Over Limit	Remark
	MHz	dBm	dBm	dBm	dB	dB	
1	43.58	-47.93	-46.46	-25.00	-1.47	-22.93	Peak
2 pp	76.56	-43.06	-33.08	-25.00	-9.98	-18.06	Peak
3	137.67	-58.92	-50.26	-25.00	-8.66	-33.92	Peak
4	245.34	-60.84	-54.65	-25.00	-6.19	-35.84	Peak
5	699.30	-67.30	-67.19	-25.00	-0.11	-42.30	Peak
6	912.70	-66.17	-67.05	-25.00	0.88	-41.17	Peak
7	5100.00	-48.38	-46.80	-25.00	-1.58	-23.38	Peak



Bureau Veritas Consumer Products Services Ltd., Taoyuan Branch

A D T

Data: 6

Date: 09-12-2019

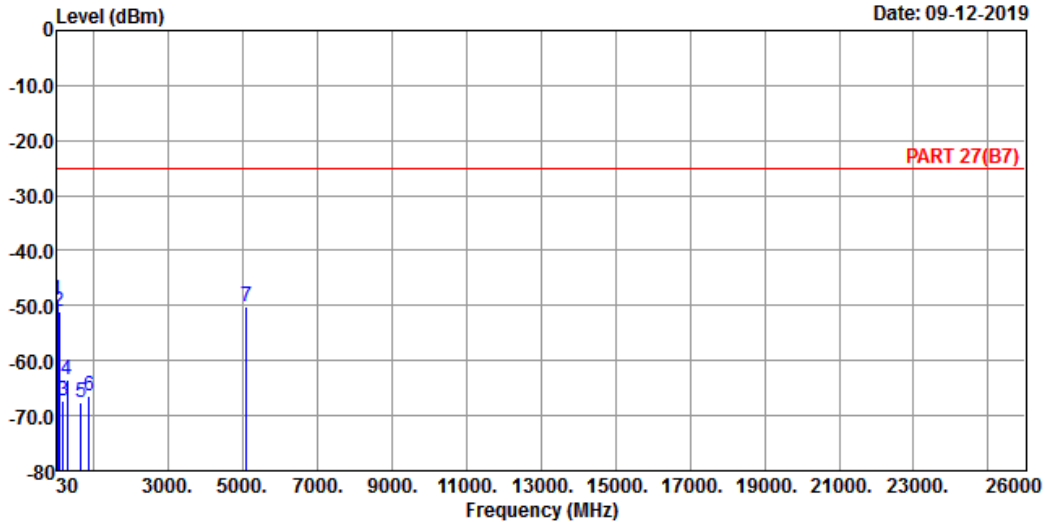

Site : 966 Chamber 5  
 Condition: PART 27(B7) VERTICAL  
 Remak : LTE Band 7 QPSK\_40M Link\_CH21152+21350  
 Tested by: Thomas Wei

	Read	Limit	Over			
Freq	Level	Level	Line	Factor	Limit	Remark
MHz	dBm	dBm	dBm	dB	dB	
1 pp	37.76	-49.14	-48.70	-25.00	-0.44	-24.14 Peak
2	78.50	-50.96	-40.53	-25.00	-10.43	-25.96 Peak
3	178.41	-67.27	-60.21	-25.00	-7.06	-42.27 Peak
4	295.78	-63.54	-56.61	-25.00	-6.93	-38.54 Peak
5	676.02	-67.48	-67.00	-25.00	-0.48	-42.48 Peak
6	891.36	-66.43	-66.95	-25.00	0.52	-41.43 Peak
7	5100.00	-50.15	-48.57	-25.00	-1.58	-25.15 Peak

LTE Band 38 + Band 38  
 Channel Bandwidth: 20+20 MHz / QPSK  
 Channel 37850+38048



Bureau Veritas Consumer Products Services Ltd., Taoyuan Branch

A D T

Data: 5

Date: 09-12-2019

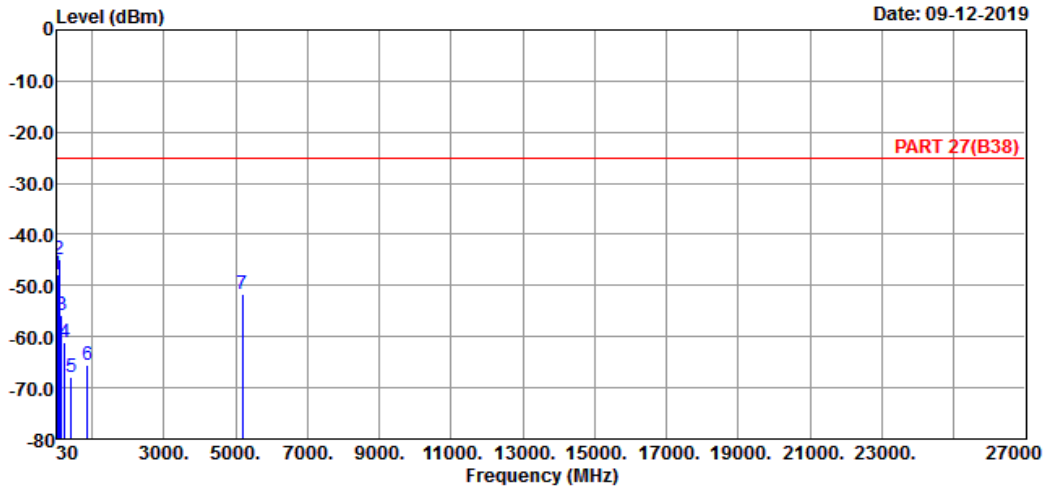

Site : 966 Chamber 5  
 Condition: PART 27(B38) HORIZONTAL  
 Remak : LTE Band 38 QPSK\_40M Link\_CH37850+38048  
 Tested by: Thomas Wei

	Freq	Level	Read Level	Limit	Over	Over	Remark
	MHz	dBm	dBm	dBm	dB	dB	
1	33.88	-47.71	-46.13	-25.00	-1.58	-22.71	Peak
2	74.62	-44.90	-35.37	-25.00	-9.53	-19.90	Peak
3	138.64	-55.70	-47.04	-25.00	-8.66	-30.70	Peak
4	243.40	-61.02	-54.75	-25.00	-6.27	-36.02	Peak
5	423.82	-67.96	-62.20	-25.00	-5.76	-42.96	Peak
6	876.81	-65.64	-66.08	-25.00	0.44	-40.64	Peak
7	5179.60	-51.75	-49.76	-25.00	-1.99	-26.75	Peak



Bureau Veritas Consumer Products Services Ltd., Taoyuan Branch

A D T

Data: 6

Date: 09-12-2019

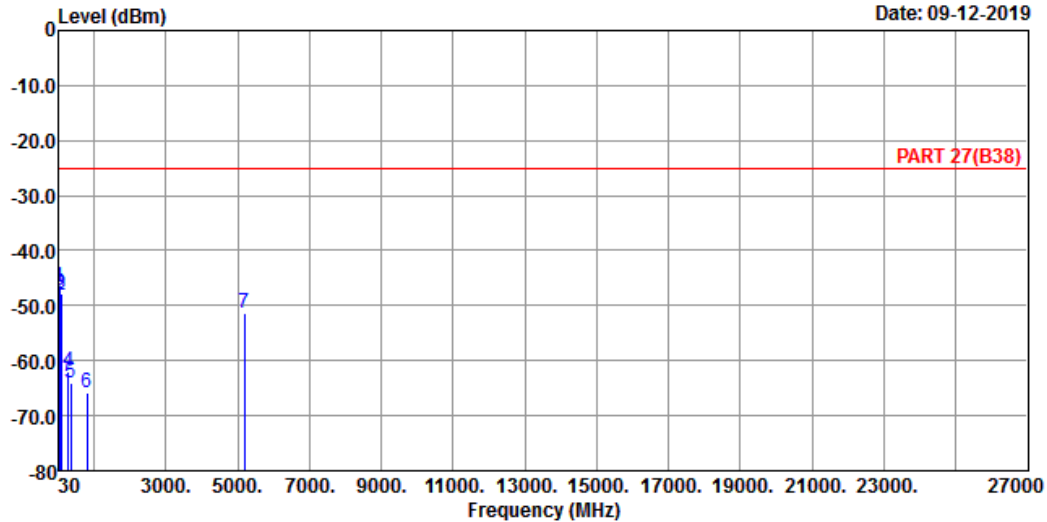

Site : 966 Chamber 5  
 Condition: PART 27(B38) VERTICAL  
 Remak : LTE Band 38 QPSK\_40M Link\_CH37850+38048  
 Tested by: Thomas Wei

	Freq	Level	Read Level	Limit	Line Factor	Over Limit	Remark
	MHz	dBm	dBm	dBm	dB	dB	
1 pp	32.91	-46.73	-45.64	-25.00	-1.09	-21.73	Peak
2	52.31	-48.17	-42.63	-25.00	-5.54	-23.17	Peak
3	79.47	-47.72	-37.06	-25.00	-10.66	-22.72	Peak
4	286.08	-61.90	-55.17	-25.00	-6.73	-36.90	Peak
5	347.19	-64.14	-57.86	-25.00	-6.28	-39.14	Peak
6	812.79	-65.89	-66.51	-25.00	0.62	-40.89	Peak
7	5179.60	-51.43	-49.44	-25.00	-1.99	-26.43	Peak

LTE Band 38 + Band 38  
 Channel Bandwidth: 20+20 MHz / QPSK  
 Channel 37901+38099



Bureau Veritas Consumer Products Services Ltd., Taoyuan Branch

A D T

Data: 5

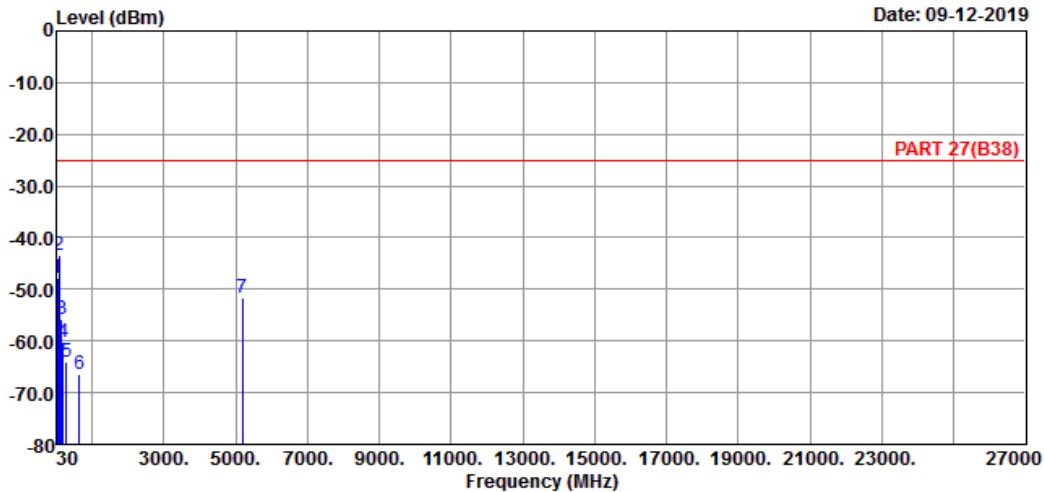

Site : 966 Chamber 5  
 Condition: PART 27(B38) HORIZONTAL  
 Remak : LTE Band 38 QPSK\_40M Link\_CH37901+38099  
 Tested by: Thomas Wei

	Freq	Level	Read Level	Limit	Line Factor	Over Limit	Remark
	MHz	dBm	dBm	dBm	dB	dB	
1	43.58	-47.70	-46.23	-25.00	-1.47	-22.70	Peak
2 pp	79.47	-43.34	-32.68	-25.00	-10.66	-18.34	Peak
3	138.64	-55.70	-47.04	-25.00	-8.66	-30.70	Peak
4	187.14	-60.14	-52.96	-25.00	-7.18	-35.14	Peak
5	286.08	-63.95	-57.22	-25.00	-6.73	-38.95	Peak
6	652.74	-66.29	-65.45	-25.00	-0.84	-41.29	Peak
7	5190.00	-51.56	-49.49	-25.00	-2.07	-26.56	Peak



Bureau Veritas Consumer Products Services Ltd., Taoyuan Branch

A D T

Data: 6

Date: 09-12-2019

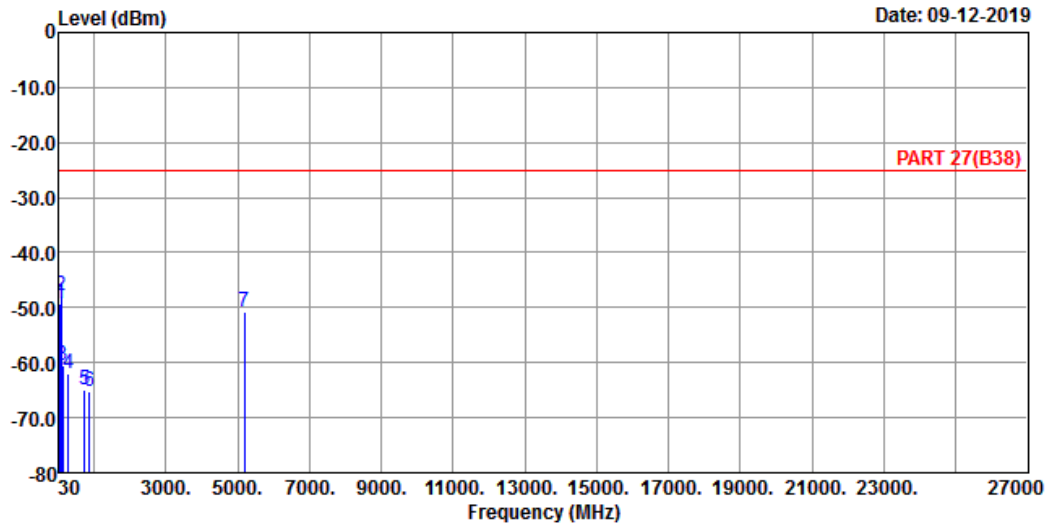

Site : 966 Chamber 5  
 Condition: PART 27(B38) VERTICAL  
 Remak : LTE Band 38 QPSK\_40M Link\_CH37901+38099  
 Tested by: Thomas Wei

	Freq	Level	Read Level	Limit Line	Over Factor	Over Limit	Remark
	MHz	dBm	dBm	dBm	dB	dB	
1	54.25	-49.29	-43.22	-25.00	-6.07	-24.29	Peak
2	74.62	-47.72	-38.19	-25.00	-9.53	-22.72	Peak
3	135.73	-60.61	-51.94	-25.00	-8.67	-35.61	Peak
4	286.08	-61.90	-55.17	-25.00	-6.73	-36.90	Peak
5	728.40	-64.92	-65.38	-25.00	0.46	-39.92	Peak
6	883.60	-65.30	-65.78	-25.00	0.48	-40.30	Peak
7	5190.00	-50.90	-48.83	-25.00	-2.07	-25.90	Peak



LTE Band 38 + Band 38  
 Channel Bandwidth: 20+20 MHz / QPSK  
 Channel 37952+38150



Bureau Veritas Consumer Products Services Ltd., Taoyuan Branch

A D T

Data: 5

Date: 09-12-2019

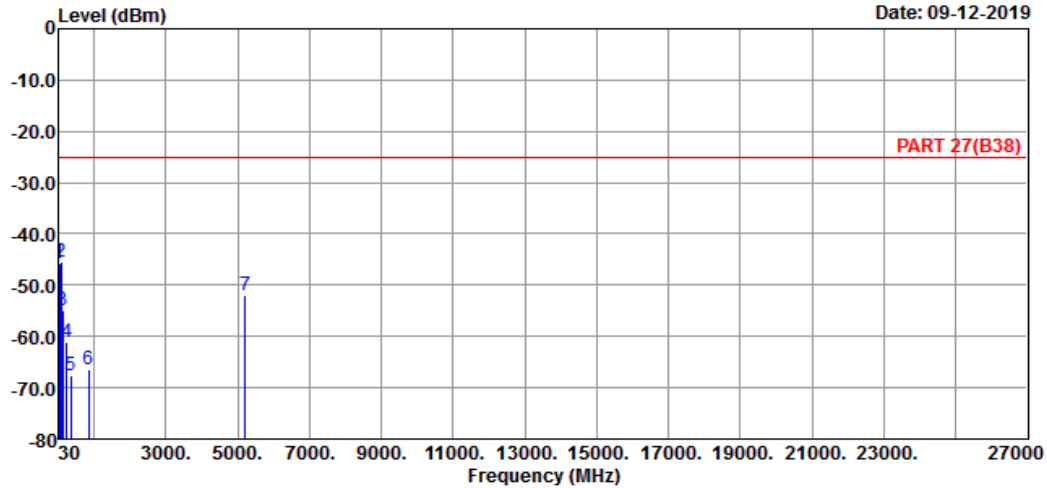

Site : 966 Chamber 5  
 Condition: PART 27(B38) HORIZONTAL  
 Remak : LTE Band 38 QPSK\_40M Link\_CH37952+38150  
 Tested by: Thomas Wei

	Freq	Level	Read Level	Limit	Over		
	MHz	dBm	dBm	dBm	dB	dB	Remark
1	31.94	-45.72	-45.12	-25.00	-0.60	-20.72	Peak
2 pp	80.44	-45.38	-34.50	-25.00	-10.88	-20.38	Peak
3	133.79	-54.97	-46.29	-25.00	-8.68	-29.97	Peak
4	243.40	-61.02	-54.75	-25.00	-6.27	-36.02	Peak
5	353.98	-67.59	-61.37	-25.00	-6.22	-42.59	Peak
6	856.44	-66.40	-66.73	-25.00	0.33	-41.40	Peak
7	5200.40	-52.06	-49.99	-25.00	-2.07	-27.06	Peak



Bureau Veritas Consumer Products Services Ltd., Taoyuan Branch

A D T

Data: 6

Date: 09-12-2019

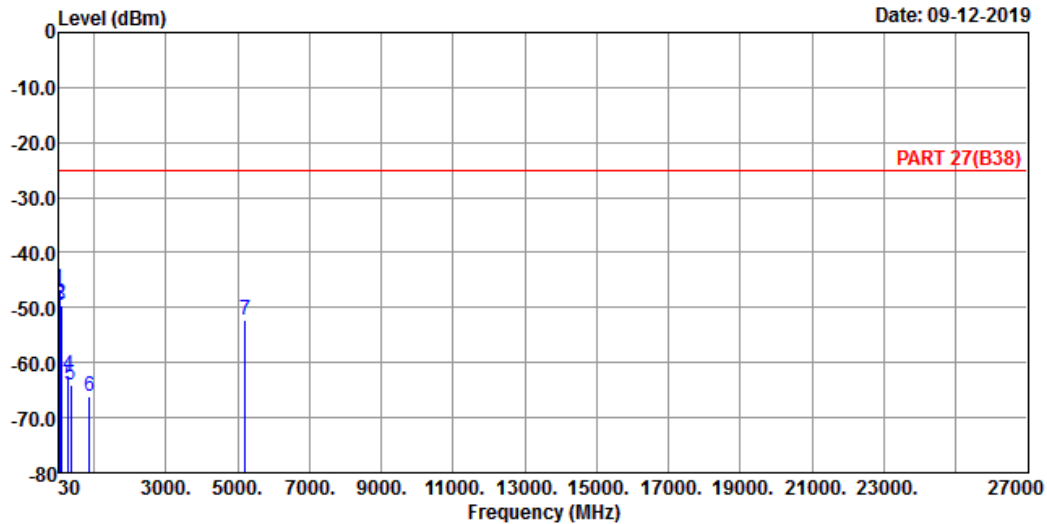

Site : 966 Chamber 5  
 Condition: PART 27(B38) VERTICAL  
 Remak : LTE Band 38 QPSK\_40M Link\_CH37952+38150  
 Tested by: Thomas Wei

	Freq	Level	Read Level	Limit	Line Factor	Over Limit	Remark
	MHz	dBm	dBm	dBm	dB	dB	
1 pp	32.91	-46.73	-45.64	-25.00	-1.09	-21.73	Peak
2	54.25	-49.29	-43.22	-25.00	-6.07	-24.29	Peak
3	73.65	-49.63	-40.33	-25.00	-9.30	-24.63	Peak
4	296.75	-62.26	-55.31	-25.00	-6.95	-37.26	Peak
5	347.19	-64.14	-57.86	-25.00	-6.28	-39.14	Peak
6	864.20	-66.05	-66.42	-25.00	0.37	-41.05	Peak
7	5200.40	-52.28	-50.21	-25.00	-2.07	-27.28	Peak

## 5 Pictures of Test Arrangements

Please refer to the attached file (Test Setup Photo).

## Appendix – Information of the Testing Laboratories

We, Bureau Veritas Consumer Products Services (H.K.) Ltd., Taoyuan Branch, were founded in 1988 to provide our best service in EMC, Radio, Telecom and Safety consultation. Our laboratories are FCC recognized accredited test firms and accredited according to ISO/IEC 17025.

If you have any comments, please feel free to contact us at the following:

**Lin Kou EMC/RF Lab**

Tel: 886-2-26052180

Fax: 886-2-26051924

**Hsin Chu EMC/RF/Telecom Lab**

Tel: 886-3-6668565

Fax: 886-3-6668323

**Hwa Ya EMC/RF/Safety Lab**

Tel: 886-3-3183232

Fax: 886-3-3270892

**Email:** [service.adt@tw.bureauveritas.com](mailto:service.adt@tw.bureauveritas.com)

**Web Site:** [www.bureauveritas-adt.com](http://www.bureauveritas-adt.com)

The address and road map of all our labs can be found in our web site also.

--- END ---