

FCC Test Report

(PART 22)

Report No.: RF190723C05-5

FCC ID: ZL5S52E

Test Model: S52

Received Date: Jul. 23, 2019

Test Date: Aug. 12 ~ Sep. 06, 2019

Issued Date: Oct. 08, 2019

Applicant: Bullitt Group

Address: One Valpy, Valpy Street, Reading, RG1 1AR, Berkshire, UK

Issued By: Bureau Veritas Consumer Products Services (H.K.) Ltd., Taoyuan Branch
Lin Kou Laboratories

Lab Address: No. 47-2, 14th Ling, Chia Pau Vil., Lin Kou Dist., New Taipei City, Taiwan

Test Location: No.19, Hwa Ya 2nd Rd., Wen Hwa Vil., Kwei Shan Dist., Taoyuan City
33383, Taiwan

**FCC Registration /
Designation Number:** 788550 / TW0003



This report is for your exclusive use. Any copying or replication of this report to or for any other person or entity, or use of our name or trademark, is permitted only with our prior written permission. This report sets forth our findings solely with respect to the test samples identified herein. The results set forth in this report are not indicative or representative of the quality or characteristics of the lot from which a test sample was taken or any similar or identical product unless specifically and expressly noted. Our report includes all of the tests requested by you and the results thereof based upon the information that you provided to us. You have 60 days from date of issuance of this report to notify us of any material error or omission caused by our negligence, provided, however, that such notice shall be in writing and shall specifically address the issue you wish to raise. A failure to raise such issue within the prescribed time shall constitute your unqualified acceptance of the completeness of this report, the tests conducted and the correctness of the report contents. Unless specific mention, the uncertainty of measurement has been explicitly taken into account to declare the compliance or non-compliance to the specification. The report must not be used by the client to claim product certification, approval, or endorsement by TAF or any government agencies

Table of Contents

Release Control Record	4
1 Certificate of Conformity	5
2 Summary of Test Results	6
2.1 Measurement Uncertainty	6
2.2 Test Site and Instruments	7
3 General Information	8
3.1 General Description of EUT	8
3.2 Configuration of System under Test	10
3.2.1 Description of Support Units	10
3.3 Test Mode Applicability and Tested Channel Detail	11
3.4 EUT Operating Conditions	13
3.5 General Description of Applied Standards	13
4 Test Types and Results	14
4.1 Output Power Measurement	14
4.1.1 Limits of Output Power Measurement	14
4.1.2 Test Procedures	14
4.1.3 Test Setup	15
4.1.4 Test Results	16
4.2 Modulation Characteristics Measurement	23
4.2.1 Limits of Modulation Characteristics	23
4.2.2 Test Setup	23
4.2.3 Test Procedure	23
4.2.4 Test Results	24
4.3 Frequency Stability Measurement	26
4.3.1 Limits of Frequency Stability Measurement	26
4.3.2 Test Procedure	26
4.3.3 Test Setup	26
4.3.4 Test Results	27
4.4 Occupied Bandwidth Measurement	34
4.4.1 Test Procedure	34
4.4.2 Test Setup	34
4.4.3 Test Result	35
4.5 Band Edge Measurement	39
4.5.1 Limits of Band Edge Measurement	39
4.5.2 Test Setup	39
4.5.3 Test Procedures	39
4.5.4 Test Results	40
4.6 Peak to Average Ratio	45
4.6.1 Limits of Peak to Average Ratio Measurement	45
4.6.2 Test Setup	45
4.6.3 Test Procedures	45
4.6.4 Test Results	46
4.7 Conducted Spurious Emissions	49
4.7.1 Limits of Conducted Spurious Emissions Measurement	49
4.7.2 Test Setup	49
4.7.3 Test Procedure	49
4.7.4 Test Results	50
4.8 Radiated Emission Measurement	57
4.8.1 Limits of Radiated Emission Measurement	57
4.8.2 Test Procedure	57
4.8.3 Deviation from Test Standard	57
4.8.4 Test Setup	58
4.8.5 Test Results	59

5 Pictures of Test Arrangements.....	95
Appendix – Information of the Testing Laboratories	96

Release Control Record

Issue No.	Description	Date Issued
RF190723C05-5	Original Release	Oct. 08, 2019

1 Certificate of Conformity

Product: Rugged Smart Phone

Brand: CAT

Test Model: S52

Sample Status: Identical Prototype

Applicant: Bullitt Group

Test Date: Aug. 12 ~ Sep. 06, 2019

Standards: FCC Part 22, Subpart H

The above equipment has been tested by **Bureau Veritas Consumer Products Services (H.K.) Ltd., Taoyuan Branch**, and found compliance with the requirement of the above standards. The test record, data evaluation & Equipment Under Test (EUT) configurations represented herein are true and accurate accounts of the measurements of the sample's RF characteristics under the conditions specified in this report.

Prepared by : Gina Liu, **Date:** Oct. 08, 2019
Gina Liu / Specialist

Approved by : Dylan Chiou, **Date:** Oct. 08, 2019
Dylan Chiou / Project Engineer

2 Summary of Test Results

Applied Standard: FCC Part 22 & Part 2			
FCC Clause	Test Item	Result	Remarks
2.1046 22.913 (a)	Effective Radiated Power	Pass	Meet the requirement of limit.
2.1047	Modulation Characteristics	Pass	Meet the requirement.
2.1046 22.913 (d)	Peak to Average Ratio	Pass	Meet the requirement of limit.
2.1055 22.355	Frequency Stability	Pass	Meet the requirement of limit.
2.1049	Occupied Bandwidth	Pass	Meet the requirement of limit.
22.917	Band Edge Measurements	Pass	Meet the requirement of limit.
2.1051 22.917	Conducted Spurious Emissions	Pass	Meet the requirement of limit.
2.1053 22.917	Radiated Spurious Emissions	Pass	Meet the requirement of limit. Minimum passing margin is -24.14 dB at 2546.40 MHz.

Note: Determining compliance based on the results of the compliance measurement, not taking into account measurement instrumentation uncertainty.

2.1 Measurement Uncertainty

Where relevant, the following measurement uncertainty levels have been estimated for tests performed on the EUT as specified in CISPR 16-4-2:

Measurement	Frequency	Expanded Uncertainty (k=2) (\pm)
Radiated Emissions up to 1 GHz	9 kHz ~ 30 MHz	3.04 dB
	30 MHz ~ 200 MHz	2.93 dB
	200 MHz ~ 1000 MHz	2.95 dB
Radiated Emissions above 1 GHz	1 GHz ~ 18 GHz	2.26 dB
	18 GHz ~ 40 GHz	1.94 dB

2.2 Test Site and Instruments

Description & Manufacturer	Model No.	Serial No.	Date of Calibration	Due Date of Calibration
Test Receiver Agilent	N9038A	MY51210203	Mar. 18, 2019	Mar. 17, 2020
Spectrum Analyzer Agilent	N9010A	MY52220314	Dec. 13, 2018	Dec. 12, 2019
Spectrum Analyzer ROHDE & SCHWARZ	FSU43	101261	Apr. 15, 2019	Apr. 14, 2020
Spectrum Analyzer ROHDE & SCHWARZ	FSW26	102023	Oct. 11, 2018	Oct. 10, 2019
HORN Antenna SCHWARZBECK	BBHA 9120D	9120D-969	Nov. 25, 2018	Nov. 24, 2019
BILOG Antenna SCHWARZBECK	VULB 9168	9168-472	Nov. 23, 2018	Nov. 22, 2019
HORN Antenna SCHWARZBECK	BBHA 9170	148	Nov. 25, 2018	Nov. 24, 2019
BILOG Antenna	VULB9168	9168-153	Nov. 23, 2018	Nov. 22, 2019
Fixed Attenuator WOKEN	MDCS18N-10	MDCS18N-10-01	Apr. 15, 2019	Apr. 14, 2020
MXG Vector signal generator Agilent	N5182B	MY53050430	Nov. 19, 2018	Nov. 18, 2019
Preamplifier EMCI	EMC 012645	980115	Oct. 12, 2018	Oct. 11, 2019
Preamplifier EMCI	EMC 330H	980112	Oct. 12, 2018	Oct. 11, 2019
RF Coaxial Cable HUBER+SUHNNER	EMC104-SM-SM-800 0&3000	140811+170717	Oct. 12, 2018	Oct. 11, 2019
RF Coaxial Cable HUBER+SUHNNER	SUCOFLEX 104	EMC104-SM-SM-1 000(140807)	Oct. 12, 2018	Oct. 11, 2019
RF Coaxial Cable WOKEN	8D-FB	Cable-Ch10-01	Oct. 12, 2018	Oct. 11, 2019
Boresight Antenna Fixture	FBA-01	FBA-SIP01	NA	NA
Software BV ADT	E3 6.120103	NA	NA	NA
Antenna Tower MF	MFA-440H	NA	NA	NA
Turn Table MF	MFT-201SS	NA	NA	NA
Antenna Tower & Turn Table Controller MF	MF-7802	NA	NA	NA
Radio Communication Analyzer Anritsu	MT8821C	6201462755	Jan. 16, 2019	Jan. 15, 2020
Radio Communication Analyzer Anritsu	MT8820C	6201300640	Aug. 16, 2017	Aug. 15, 2019
			Aug. 19, 2019	Aug. 18, 2020
Temperature & Humidity Chamber	GTH-120-40-CP-AR	MAA1306-019	Sep. 05, 2018	Sep. 04, 2019
			Sep. 06, 2019	Sep. 05, 2020
DC Power Supply Keysight	U8002A	MY56330015	NA	NA

Note: 1. The calibration interval of the above test instruments is 12 / 24 months and the calibrations are traceable to NML/ROC and NIST/USA.

2. The test was performed in HwaYa Chamber 10.

3 General Information

3.1 General Description of EUT

Product	Rugged Smart Phone	
Brand	CAT	
Test Model	S52	
Status of EUT	Identical Prototype	
Power Supply Rating	5-8 Vdc / 8.5-10 Vdc / 10-12 Vdc (adapter 1) 5.0 Vdc / 9.0 Vdc / 12.0 Vdc (adapter 2) 3.8 Vdc (Li-ion battery)	
Modulation Type	GSM/GPRS	GMSK
	EDGE	GMSK, 8PSK
	WCDMA	QPSK
	LTE	QPSK, 16QAM, 64QAM
Frequency Range	GSM/GPRS/EDGE	824.2 ~ 848.8 MHz
	WCDMA	826.4 ~ 846.6 MHz
	LTE 5 (Channel Bandwidth: 1.4 MHz)	824.7 ~ 848.3 MHz
	LTE 5 (Channel Bandwidth: 3 MHz)	825.5 ~ 847.5 MHz
	LTE 5 (Channel Bandwidth: 5 MHz)	826.5 ~ 846.5 MHz
	LTE 5 (Channel Bandwidth: 10 MHz)	829 ~ 844 MHz
Max. ERP Power	GSM/GPRS	227.51 mW
	EDGE	65.92 mW
	WCDMA	28.91 mW
	LTE 5 (Channel Bandwidth: 1.4 MHz)	27.16 mW
	LTE 5 (Channel Bandwidth: 3 MHz)	28.77 mW
	LTE 5 (Channel Bandwidth: 5 MHz)	30.55 mW
	LTE 5 (Channel Bandwidth: 10 MHz)	32.21 mW
Emission Designator	GSM/GPRS	247KGXW
	EDGE	248KG7W
	WCDMA	4M19F9W
	LTE 5 (Channel Bandwidth: 1.4 MHz)	1M09D7W
	LTE 5 (Channel Bandwidth: 3 MHz)	2M70G7D
	LTE 5 (Channel Bandwidth: 5 MHz)	4M50D7W
	LTE 5 (Channel Bandwidth: 10 MHz)	8M98D7W
Antenna Type	Loop Antenna with -6 dBi gain PIFA Antenna with -7 dBi gain	
Accessory Device	Refer to Note as below	
Data Cable Supplied	Refer to Note as below	

Note:

1. The EUT details of the sample are as follows.

Sample	Description
DS	Dual SIM
SS	Single SIM
* The samples have the same layout, circuit, and components, but different SIM tray.	

After pre-tested with the EUT, only the worst sample (Dual SIM) was chosen for the final test.

2. The EUT contains following accessory devices.

Product	Manufacture	Model	Description
Adapter 1	Lucent Trans Electronics Co., LTD.	1M52	I/P: 100-240 Vac, 50-60 Hz, 500 mA O/P: 5Vdc-8Vdc, 2.0A / 8.5Vdc-10Vdc, 1.7A / 10Vdc-12Vdc, 1.5A
Adapter 2	Jiangsu Chenyang Electron Co., LTD.	CK18W02U	I/P: 100-240 Vac, 50-60 Hz, 500 mA O/P: 5 Vdc, 3.0A / 9Vdc, 2.0A / 12Vdc, 1.5A
Battery	Apack Technology Co., LTD.	APP00307	3.8 Vdc, 3000 mAh
Earphone	Ganet Global LTD.	HF-AC04D-03 HF	1.2m non-shielded cable with core
USB Cable	Saibao (Jiangxi) Communication Industrial Co., LTD.	SRB-A001A	1.2m shielded cable with core

3. The above EUT information is declared by manufacturer and for more detailed features description, please refers to the manufacturer's specifications or user's manual.

3.2 Configuration of System under Test

<Radiated Emission Test>

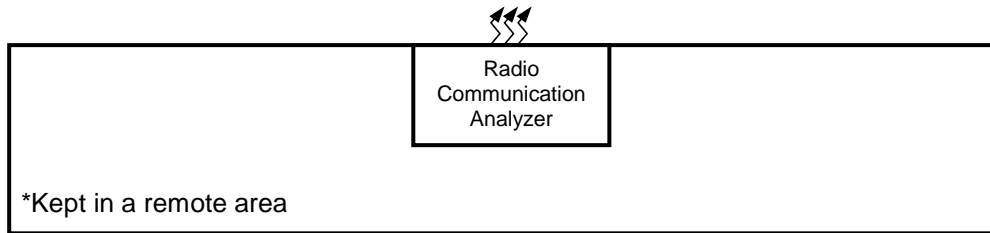
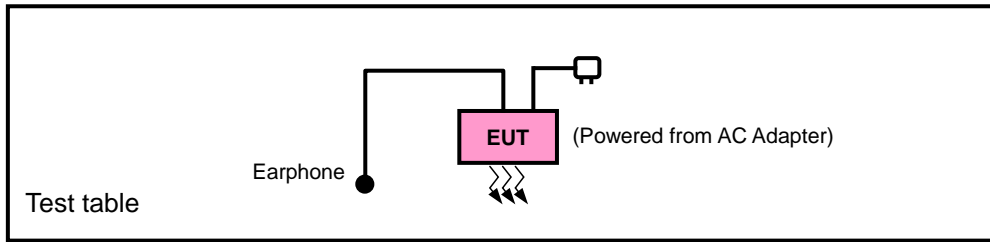

<E.R.P. Test>

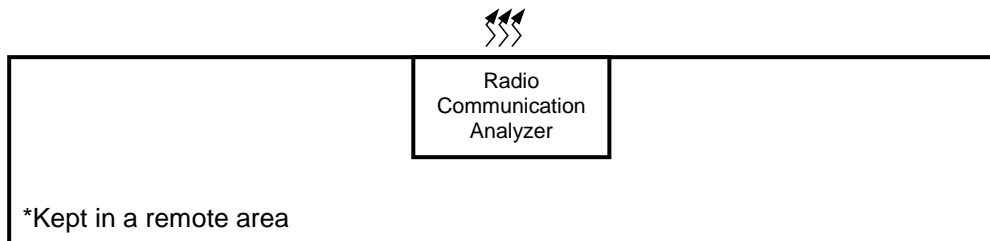
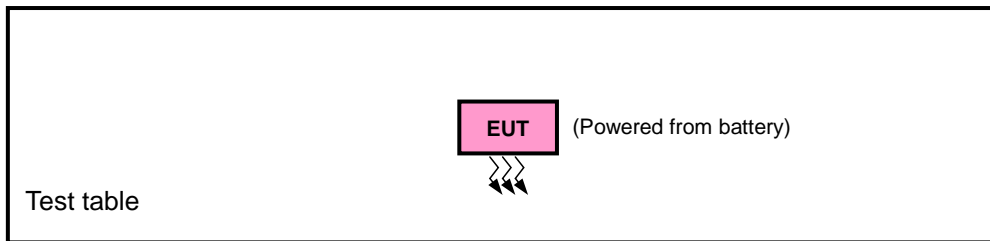

3.2.1 Description of Support Units

The EUT has been tested as an independent unit together with other necessary accessories or support units.

3.3 Test Mode Applicability and Tested Channel Detail

Pre-Scan has been conducted to determine the worst-case mode from all possible combinations between available modulations, data rates, XYZ axis, and antenna ports.

The worst case was found when positioned as the table below. Following channel(s) was (were) selected for the final test as listed below:

Band	ERP	Radiated Emission
GSM	Z-plane	X-axis
EDGE	Z-plane	X-axis
WCDMA	Z-plane	X-axis
LTE Band 5	Z-plane	X-axis

GSM

EUT Configure Mode	Test Item	Available Channel	Tested Channel	Mode
-	ERP	128 to 251	128, 189, 251	GSM, EDGE
-	Modulation Characteristics	128 to 251	189	GSM, EDGE
-	Frequency Stability	128 to 251	128, 251	GSM, EDGE
-	Occupied Bandwidth	128 to 251	128, 189, 251	GSM, EDGE
-	Band Edge	128 to 251	128, 251	GSM, EDGE
-	Peak to Average Ratio	128 to 251	128, 189, 251	GSM, EDGE
-	Conducted Emission	128 to 251	128, 189, 251	GSM, EDGE
-	Radiated Emission	128 to 251	128, 189, 251	GSM, EDGE

WCDMA

EUT Configure Mode	Test Item	Available Channel	Tested Channel	Mode
-	ERP	4132 to 4233	4132, 4182, 4233	WCDMA
-	Modulation Characteristics	4132 to 4233	4182	WCDMA
-	Frequency Stability	4132 to 4233	4132, 4233	WCDMA
-	Occupied Bandwidth	4132 to 4233	4132, 4182, 4233	WCDMA
-	Band Edge	4132 to 4233	4132, 4233	WCDMA
-	Peak to Average Ratio	4132 to 4233	4132, 4182, 4233	WCDMA
-	Conducted Emission	4132 to 4233	4132, 4182, 4233	WCDMA
-	Radiated Emission	4132 to 4233	4132, 4182, 4233	WCDMA

LTE Band 5

EUT Configure Mode	Test Item	Available Channel	Tested Channel	Channel Bandwidth	Modulation	Mode		
-	ERP	20407 to 20643	20407, 20525, 20643	1.4 MHz	QPSK, 16QAM, 64QAM	1 RB / 0 RB Offset		
		20415 to 20635	20415, 20525, 20635	3 MHz	QPSK, 16QAM, 64QAM	1 RB / 0 RB Offset		
		20425 to 20625	20425, 20525, 20625	5 MHz	QPSK, 16QAM, 64QAM	1 RB / 24 RB Offset		
		20450 to 20600	20450, 20525, 20600	10 MHz	QPSK, 16QAM, 64QAM	1 RB / 0 RB Offset		
-	Modulation Characteristics	20450 to 20600	20525	10 MHz	QPSK, 16QAM, 64QAM	50 RB / 0 RB Offset		
-	Frequency Stability	20407 to 20643	20407, 20643	1.4 MHz	QPSK	1 RB / 0 RB Offset		
		20415 to 20635	20415, 20635	3 MHz	QPSK	1 RB / 0 RB Offset		
		20425 to 20625	20425, 20625	5 MHz	QPSK	1 RB / 0 RB Offset		
		20450 to 20600	20450, 20600	10 MHz	QPSK	1 RB / 0 RB Offset		
-	Occupied Bandwidth	20407 to 20643	20407, 20525, 20643	1.4 MHz	QPSK, 16QAM, 64QAM	6 RB / 0 RB Offset		
		20415 to 20635	20415, 20525, 20635	3 MHz	QPSK, 16QAM, 64QAM	15 RB / 0 RB Offset		
		20425 to 20625	20425, 20525, 20625	5 MHz	QPSK, 16QAM, 64QAM	25 RB / 0 RB Offset		
		20450 to 20600	20450, 20525, 20600	10 MHz	QPSK, 16QAM, 64QAM	50 RB / 0 RB Offset		
-	Band Edge	20407 to 20643	20407	1.4MHz	QPSK	1 RB / 0 RB Offset 6 RB / 0 RB Offset		
			20643	1.4MHz	QPSK	1 RB / 5 RB Offset 6 RB / 0 RB Offset		
		20415 to 20635	20415	3 MHz	QPSK	1 RB / 0 RB Offset 15 RB / 0 RB Offset		
			20635	3 MHz	QPSK	1 RB / 14 RB Offset 15 RB / 0 RB Offset		
		20425 to 20625	20425	5 MHz	QPSK	1 RB / 0 RB Offset 25 RB / 0 RB Offset		
			20625	5 MHz	QPSK	1 RB / 24 RB Offset 25 RB / 0 RB Offset		
		20450 to 20600	20450	10 MHz	QPSK	1 RB / 0 RB Offset 50 RB / 0 RB Offset		
			20600	10 MHz	QPSK	1 RB / 49 RB Offset 50 RB / 0 RB Offset		
		-	Peak to Average Ratio	20407 to 20643	20407, 20525, 20643	1.4 MHz	QPSK, 16QAM, 64QAM	1 RB / 0 RB Offset
				20415 to 20635	20415, 20525, 20635	3 MHz	QPSK, 16QAM, 64QAM	1 RB / 0 RB Offset
				20425 to 20625	20425, 20525, 20625	5 MHz	QPSK, 16QAM, 64QAM	1 RB / 24 RB Offset
				20450 to 20600	20450, 20525, 20600	10 MHz	QPSK, 16QAM, 64QAM	1 RB / 0 RB Offset

EUT Configure Mode	Test Item	Available Channel	Tested Channel	Channel Bandwidth	Modulation	Mode
-	Conducted Emission	20407 to 20643	20407, 20525, 20643	1.4 MHz	QPSK	1 RB / 0 RB Offset
		20415 to 20635	20415, 20525, 20635	3 MHz	QPSK	1 RB / 0 RB Offset
		20425 to 20625	20425, 20525, 20625	5 MHz	QPSK	1 RB / 24 RB Offset
		20450 to 20600	20450, 20525, 20600	10 MHz	QPSK	1 RB / 0 RB Offset
-	Radiated Emission	20407 to 20643	20407, 20525, 20643	1.4 MHz	QPSK	1 RB / 0 RB Offset
		20425 to 20625	20425, 20525, 20625	5 MHz	QPSK	1 RB / 24 RB Offset
		20450 to 20600	20450, 20525, 20600	10 MHz	QPSK	1 RB / 0 RB Offset

Note:

1. This device was tested under all bandwidths, RB configurations and modulations. The worst case was found in QPSK modulation.
2. For radiated emission above 1 GHz, according to 3GPP 36.521 Section 6.6.3.1.4, choose the lowest, 5 MHz & highest channel bandwidth for final test.

Test Condition:

Test Item	Environmental Conditions	Input Power	Tested By
ERP	25 deg. C, 65 % RH	3.8 Vdc	Thomas Wei
Modulation Characteristics	25 deg. C, 65 % RH	3.8 Vdc	Wayne Lin
Frequency Stability	25 deg. C, 65 % RH	3.8 Vdc	Wayne Lin
Occupied Bandwidth	25 deg. C, 65 % RH	3.8 Vdc	Wayne Lin
Band Edge	25 deg. C, 65 % RH	3.8 Vdc	Wayne Lin
Peak to Average Ratio	25 deg. C, 65 % RH	3.8 Vdc	Wayne Lin
Conducted Emission	25 deg. C, 65 % RH	3.8 Vdc	Wayne Lin
Radiated Emission	25 deg. C, 65 % RH	120 Vac, 60 Hz	Thomas Wei

3.4 EUT Operating Conditions

The EUT makes a call to the communication simulator. The communication simulator station system controlled a EUT to export maximum output power under transmission mode and specific channel frequency.

3.5 General Description of Applied Standards

The EUT is a RF Product. According to the specifications of the manufacturer, it must comply with the requirements of the following standards:

FCC 47 CFR Part 2

FCC 47 CFR Part 22

KDB 971168 D01 Power Meas License Digital Systems v03r01

ANSI/TIA/EIA-603-E 2016

ANSI 63.26-2015

Note: All test items have been performed and recorded as per the above standards.

4 Test Types and Results

4.1 Output Power Measurement

4.1.1 Limits of Output Power Measurement

Mobile / Portable station are limited to 7 watts e.r.p.

4.1.2 Test Procedures

EIRP / ERP Measurement:

- a. All measurements were done at low, middle and high operational frequency range. RBW and VBW is 1 MHz for GSM, GPRS & EDGE, and 5 MHz for WCDMA, and 10 MHz for LTE mode.
- b. Substitution method is used for E.I.R.P measurement. In the semi-anechoic chamber, EUT placed on the 0.8 m (below or equal 1 GHz) and/or 1.5 m (above 1 GHz) height of Turn Table, rotated the table around 360 degrees to search the maximum radiation power and receiver antenna shall be rotated vertical and horizontal polarization and moved height from 1 m to 4 m to find the maximum polar radiated power. The "Read Value" is the spectrum reading the maximum power value.
- c. The substitution horn antenna is substituted for EUT at the same position and signals generator export the CW signal to the substitution antenna via a tx cable. Rotated the Turn Table and moved receiving antenna to find the maximum radiation power. Adjust output power level of S.G to get a Value of spectrum reading equal to "Read Value" of step b. Record the power level of S.G.
- d. $EIRP = \text{Output power level of S.G} - \text{TX cable loss} + \text{Antenna gain of substitution horn}$. E.R.P power can be calculated form E.I.R.P power by subtracting the gain of dipole, $E.R.P \text{ power} = E.I.R.P \text{ power} - 2.15 \text{ dB}$.

Conducted Power Measurement:

The EUT was set up for the maximum power with GSM, GPRS, EDGE, WCDMA, and LTE link data modulation and link up with simulator. Set the EUT to transmit under low, middle and high channel and record the power level shown on simulator.

4.1.3 Test Setup

EIRP / ERP Measurement:

<Radiated Emission below or equal 1 GHz>

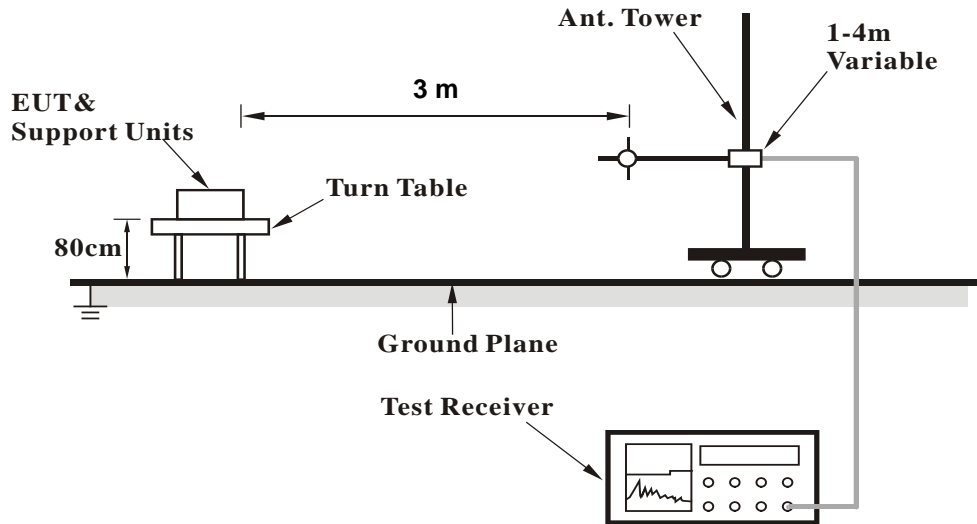

<Radiated Emission above 1 GHz>

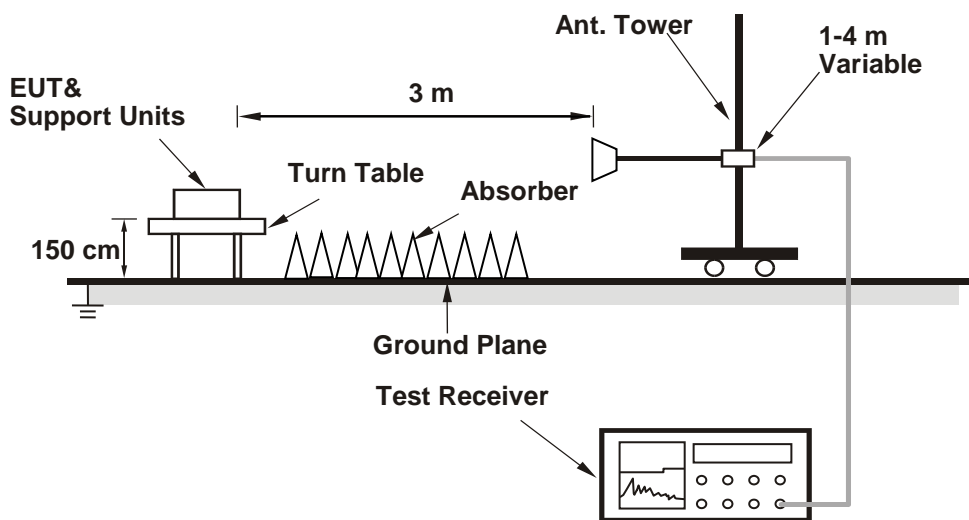

For the actual test configuration, please refer to the attached file (Test Setup Photo).

Conducted Power Measurement:

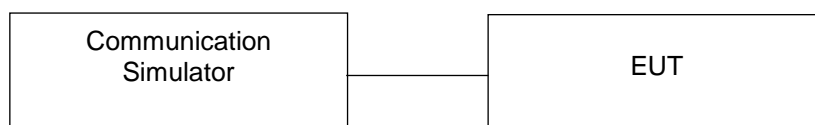

4.1.4 Test Results

Conducted Output Power (dBm)

Band	GSM850		
	128	189	251
Channel	128	189	251
Frequency (MHz)	824.2	836.4	848.8
GSM (GMSK, 1Tx-slot)	32.12	32.16	32.17
GPRS (GMSK, 1Tx-slot)	32.20	32.21	32.23
GPRS (GMSK, 2Tx-slot)	29.93	29.98	29.99
GPRS (GMSK, 3Tx-slot)	27.85	27.92	27.93
GPRS (GMSK, 4Tx-slot)	26.89	26.96	26.98
EDGE (8PSK, 1Tx-slot)	26.80	26.77	26.71
EDGE (8PSK, 2Tx-slot)	25.67	25.62	25.55
EDGE (8PSK, 3Tx-slot)	26.10	26.01	25.98
EDGE (8PSK, 4Tx-slot)	25.54	25.56	25.55

Band	WCDMA V		
	4132	4182	4233
Channel	4132	4182	4233
Frequency (MHz)	826.4	836.4	846.6
RMC 12.2K	23.29	23.33	23.28
HSDPA Subtest-1	22.17	22.19	22.13
HSDPA Subtest-2	22.10	22.13	22.07
HSDPA Subtest-3	21.69	21.71	21.65
HSDPA Subtest-4	21.70	21.73	21.67
DC-HSDPA Subtest-1	22.14	22.16	22.10
DC-HSDPA Subtest-2	22.09	22.10	22.04
DC-HSDPA Subtest-3	21.66	21.68	21.62
DC-HSDPA Subtest-4	21.68	21.70	21.65
HSUPA Subtest-1	21.67	21.71	21.68
HSUPA Subtest-2	20.16	20.18	20.12
HSUPA Subtest-3	21.19	21.22	21.16
HSUPA Subtest-4	19.69	19.72	19.66
HSUPA Subtest-5	21.08	21.13	21.07

LTE Band 5																	
BW	MCS Index	RB Size	RB Offset	Low	Mid	High	3GPP MPR (dB)	BW	MCS Index	RB Size	RB Offset	Low	Mid	High	3GPP MPR (dB)		
		Channel		20450	20525	20600				Channel		20425	20525	20625			
		Frequency (MHz)		829.0	836.5	844.0				Frequency (MHz)		826.5	836.5	846.5			
10M	QPSK	1	0	23.50	23.56	23.53	0	5M	QPSK	1	0	23.33	23.38	23.38	0		
		1	24	23.43	23.49	23.46	0			1	12	23.26	23.45	23.24	0		
		1	49	23.40	23.46	23.43	0			1	24	23.19	23.45	23.31	0		
		25	0	22.43	22.49	22.46	1			12	0	22.38	22.39	22.19	1		
		25	12	22.40	22.46	22.43	1			12	6	22.21	22.25	22.16	1		
		25	25	22.36	22.42	22.39	1			12	13	22.27	22.23	22.30	1		
	16QAM	50	0	22.45	22.51	22.48	1		25	0	22.34	22.39	22.33	1			
		1	0	22.44	22.50	22.47	1		16QAM	1	0	22.42	22.46	22.29	1		
		1	24	22.41	22.47	22.44	1			1	12	22.32	22.26	22.35	1		
		1	49	22.30	22.36	22.33	1			1	24	22.12	22.28	22.19	1		
		25	0	21.46	21.52	21.49	2			12	0	21.31	21.40	21.35	2		
		25	12	21.37	21.43	21.40	2			12	6	21.23	21.29	21.35	2		
	25	25	21.31	21.37	21.34	2	12			13	21.22	21.24	21.32	2			
	64QAM	50	0	21.46	21.52	21.49	2		25	0	21.28	21.39	21.29	2			
		1	0	21.48	21.54	21.51	2		64QAM	1	0	21.28	21.43	21.50	2		
		1	24	21.44	21.50	21.47	2			1	12	21.23	21.47	21.38	2		
		1	49	21.40	21.46	21.43	2			1	24	21.24	21.40	21.25	2		
		25	0	20.51	20.57	20.54	3			12	0	20.29	20.41	20.43	3		
		25	12	20.47	20.53	20.50	3			12	6	20.43	20.46	20.41	3		
	25	25	20.43	20.49	20.46	3	12			13	20.27	20.29	20.35	3			
					20.42	20.48	20.45		3	25	0	20.30	20.40	20.29	3		
	BW	MCS Index	RB Size	RB Offset	Low	Mid	High		3GPP MPR (dB)	BW	MCS Index	RB Size	RB Offset	Low	Mid	High	3GPP MPR (dB)
			Channel		20415	20525	20635					Channel		20407	20525	20643	
			Frequency (MHz)		825.5	836.5	847.5					Frequency (MHz)		824.7	836.5	848.3	
3M	QPSK	1	0	23.31	23.47	23.44	0	1.4M	QPSK	1	0	23.43	23.46	23.47	0		
		1	7	23.26	23.34	23.29	0			1	2	23.22	23.42	23.40	0		
		1	14	23.34	23.34	23.19	0			1	5	23.34	23.37	23.25	0		
		8	0	22.31	22.44	22.27	1			3	0	23.29	23.44	23.33	0		
		8	3	22.22	22.32	22.28	1			3	1	23.27	23.41	23.34	0		
		8	7	22.27	22.24	22.31	1			3	3	23.24	23.27	23.39	0		
	16QAM	15	0	22.29	22.40	22.37	1		6	0	22.32	22.38	22.40	1			
		1	0	22.30	22.45	22.38	1		16QAM	1	0	22.26	22.42	22.40	1		
		1	7	22.27	22.30	22.30	1			1	2	22.35	22.42	22.28	1		
		1	14	22.16	22.29	22.16	1			1	5	22.10	22.24	22.10	1		
		8	0	21.26	21.33	21.38	2			3	0	22.23	22.44	22.30	1		
		8	3	21.26	21.36	21.23	2			3	1	22.36	22.23	22.36	1		
	8	7	21.22	21.20	21.19	2	3			3	22.23	22.28	22.28	1			
	64QAM	15	0	21.45	21.33	21.49	2		6	0	21.31	21.46	21.29	2			
		1	0	21.44	21.40	21.39	2		64QAM	1	0	21.44	21.43	21.39	2		
		1	7	21.43	21.47	21.28	2			1	2	21.30	21.37	21.39	2		
		1	14	21.25	21.33	21.28	2			1	5	21.20	21.38	21.22	2		
		8	0	20.39	20.48	20.37	3			3	0	21.45	21.38	21.34	2		
		8	3	20.32	20.50	20.40	3			3	1	21.35	21.46	21.27	2		
	8	7	20.31	20.33	20.32	3	3			3	21.41	21.26	21.43	2			
					20.37	20.30	20.21		3	6	0	20.29	20.36	20.34	3		

ERP Power (dBm)

GSM							
Plane	Channel	Frequency (MHz)	Reading (dBm)	Correction Factor (dB)	ERP (dBm)	ERP (mW)	Polarization (H/V)
Z	128	824.2	-14.11	32.62	16.36	43.25	H
	189	836.4	-13.93	32.52	16.44	44.06	
	251	848.8	-14.22	32.65	16.28	42.46	
	128	824.2	-7.11	32.76	23.50	223.87	V
	189	836.4	-6.67	32.39	23.57	227.51	
	251	848.8	-6.97	32.54	23.42	219.79	

Note: ERP (dBm) = Reading (dBm) + Correction Factor (dB) – 2.15

EDGE							
Plane	Channel	Frequency (MHz)	Reading (dBm)	Correction Factor (dB)	ERP (dBm)	ERP (mW)	Polarization (H/V)
Z	128	824.2	-18.50	32.62	11.97	15.74	H
	189	836.4	-18.47	32.52	11.90	15.49	
	251	848.8	-18.69	32.65	11.81	15.17	
	128	824.2	-12.42	32.76	18.19	65.92	V
	189	836.4	-12.13	32.39	18.11	64.71	
	251	848.8	-12.34	32.54	18.05	63.83	

Note: ERP (dBm) = Reading (dBm) + Correction Factor (dB) – 2.15

WCDMA							
Plane	Channel	Frequency (MHz)	Reading (dBm)	Correction Factor (dB)	ERP (dBm)	ERP (mW)	Polarization (H/V)
Z	4132	826.4	-21.61	32.62	8.86	7.69	H
	4182	836.4	-21.33	32.52	9.04	8.02	
	4233	846.6	-21.57	32.65	8.93	7.82	
	4132	826.4	-16.12	32.76	14.49	28.12	V
	4182	836.4	-15.63	32.39	14.61	28.91	
	4233	846.6	-15.84	32.54	14.55	28.51	

Note: ERP (dBm) = Reading (dBm) + Correction Factor (dB) – 2.15

LTE Band 5							
Channel Bandwidth: 1.4 MHz / QPSK							
Plane	Channel	Frequency (MHz)	Reading (dBm)	Correction Factor (dB)	ERP (dBm)	ERP (mW)	Polarization (H/V)
Z	20407	824.7	-21.64	32.62	8.83	7.64	H
	20525	836.5	-21.42	32.52	8.95	7.85	
	20643	848.3	-21.77	32.65	8.73	7.46	
	20407	824.7	-16.43	32.76	14.18	26.18	V
	20525	836.5	-15.90	32.39	14.34	27.16	
	20643	848.3	-16.33	32.54	14.06	25.47	
Channel Bandwidth: 1.4 MHz / 16QAM							
Z	20407	824.7	-22.48	32.62	7.99	6.30	H
	20525	836.5	-22.28	32.52	8.09	6.44	
	20643	848.3	-22.84	32.65	7.66	5.83	
	20407	824.7	-17.55	32.76	13.06	20.23	V
	20525	836.5	-17.02	32.39	13.22	20.99	
	20643	848.3	-17.39	32.54	13.00	19.95	
Channel Bandwidth: 1.4 MHz / 64QAM							
Z	20407	824.7	-23.61	32.62	6.86	4.85	H
	20525	836.5	-23.39	32.52	6.98	4.99	
	20643	848.3	-23.95	32.65	6.55	4.52	
	20407	824.7	-18.43	32.76	12.18	16.52	V
	20525	836.5	-17.95	32.39	12.29	16.94	
	20643	848.3	-18.45	32.54	11.94	15.63	

Note: ERP (dBm) = Reading (dBm) + Correction Factor (dB) – 2.15

LTE Band 5							
Channel Bandwidth: 3 MHz / QPSK							
Plane	Channel	Frequency (MHz)	Reading (dBm)	Correction Factor (dB)	ERP (dBm)	ERP (mW)	Polarization (H/V)
Z	20415	825.5	-21.31	32.62	9.16	8.24	H
	20525	836.5	-21.08	32.52	9.29	8.49	
	20635	847.5	-21.47	32.65	9.03	8.00	
	20415	825.5	-16.16	32.76	14.45	27.86	V
	20525	836.5	-15.65	32.39	14.59	28.77	
	20635	847.5	-15.98	32.54	14.41	27.61	
Channel Bandwidth: 3 MHz / 16QAM							
Z	20415	825.5	-22.24	32.62	8.23	6.65	H
	20525	836.5	-22.06	32.52	8.31	6.78	
	20635	847.5	-22.60	32.65	7.90	6.17	
	20415	825.5	-17.24	32.76	13.37	21.73	V
	20525	836.5	-16.79	32.39	13.45	22.13	
	20635	847.5	-17.15	32.54	13.24	21.09	
Channel Bandwidth: 3 MHz / 64QAM							
Z	20415	825.5	-23.31	32.62	7.16	5.20	H
	20525	836.5	-23.07	32.52	7.30	5.37	
	20635	847.5	-23.66	32.65	6.84	4.83	
	20415	825.5	-18.19	32.76	12.42	17.46	V
	20525	836.5	-17.71	32.39	12.53	17.91	
	20635	847.5	-18.16	32.54	12.23	16.71	

Note: ERP (dBm) = Reading (dBm) + Correction Factor (dB) – 2.15

LTE Band 5							
Channel Bandwidth: 5 MHz / QPSK							
Plane	Channel	Frequency (MHz)	Reading (dBm)	Correction Factor (dB)	ERP (dBm)	ERP (mW)	Polarization (H/V)
Z	20425	826.5	-20.98	32.62	9.49	8.89	H
	20525	836.5	-20.80	32.52	9.57	9.06	
	20625	846.5	-21.17	32.65	9.33	8.57	
	20425	826.5	-15.87	32.76	14.74	29.79	V
	20525	836.5	-15.39	32.39	14.85	30.55	
	20625	846.5	-15.76	32.54	14.63	29.04	
Channel Bandwidth: 5 MHz / 16QAM							
Z	20425	826.5	-22.00	32.62	8.47	7.03	H
	20525	836.5	-21.82	32.52	8.55	7.16	
	20625	846.5	-22.34	32.65	8.16	6.55	
	20425	826.5	-16.93	32.76	13.68	23.33	V
	20525	836.5	-16.48	32.39	13.76	23.77	
	20625	846.5	-16.83	32.54	13.56	22.70	
Channel Bandwidth: 5 MHz / 64QAM							
Z	20425	826.5	-23.09	32.62	7.38	5.47	H
	20525	836.5	-22.82	32.52	7.55	5.69	
	20625	846.5	-23.35	32.65	7.15	5.19	
	20425	826.5	-17.94	32.76	12.67	18.49	V
	20525	836.5	-17.45	32.39	12.79	19.01	
	20625	846.5	-17.88	32.54	12.51	17.82	

Note: ERP (dBm) = Reading (dBm) + Correction Factor (dB) – 2.15

LTE Band 5							
Channel Bandwidth: 10 MHz / QPSK							
Plane	Channel	Frequency (MHz)	Reading (dBm)	Correction Factor (dB)	ERP (dBm)	ERP (mW)	Polarization (H/V)
Z	20450	829.0	-20.76	32.62	9.71	9.35	H
	20525	836.5	-20.60	32.52	9.77	9.48	
	20600	844.0	-20.86	32.65	9.64	9.20	
	20450	829.0	-15.66	32.76	14.95	31.26	V
	20525	836.5	-15.16	32.39	15.08	32.21	
	20600	844.0	-15.52	32.54	14.87	30.69	
Channel Bandwidth: 10 MHz / 16QAM							
Z	20425	826.5	-21.75	32.62	8.72	7.45	H
	20525	836.5	-21.55	32.52	8.82	7.62	
	20625	846.5	-22.04	32.65	8.46	7.01	
	20425	826.5	-16.62	32.76	13.99	25.06	V
	20525	836.5	-16.19	32.39	14.05	25.41	
	20625	846.5	-16.57	32.54	13.82	24.10	
Channel Bandwidth: 10 MHz / 64QAM							
Z	20450	829.0	-22.79	32.62	7.68	5.86	H
	20525	836.5	-22.60	32.52	7.77	5.98	
	20600	844.0	-23.09	32.65	7.41	5.51	
	20450	829.0	-17.67	32.76	12.94	19.68	V
	20525	836.5	-17.25	32.39	12.99	19.91	
	20600	844.0	-17.67	32.54	12.72	18.71	

Note: ERP (dBm) = Reading (dBm) + Correction Factor (dB) – 2.15

4.2 Modulation Characteristics Measurement

4.2.1 Limits of Modulation Characteristics

N/A

4.2.2 Test Setup



4.2.3 Test Procedure

Connect the EUT to Communication Simulator via the antenna connector. The frequency band is set as EUT supported Modulation and Channels, the EUT output is matched with 50 ohm load, the waveform quality and constellation of the EUT was tested.

4.2.4 Test Results

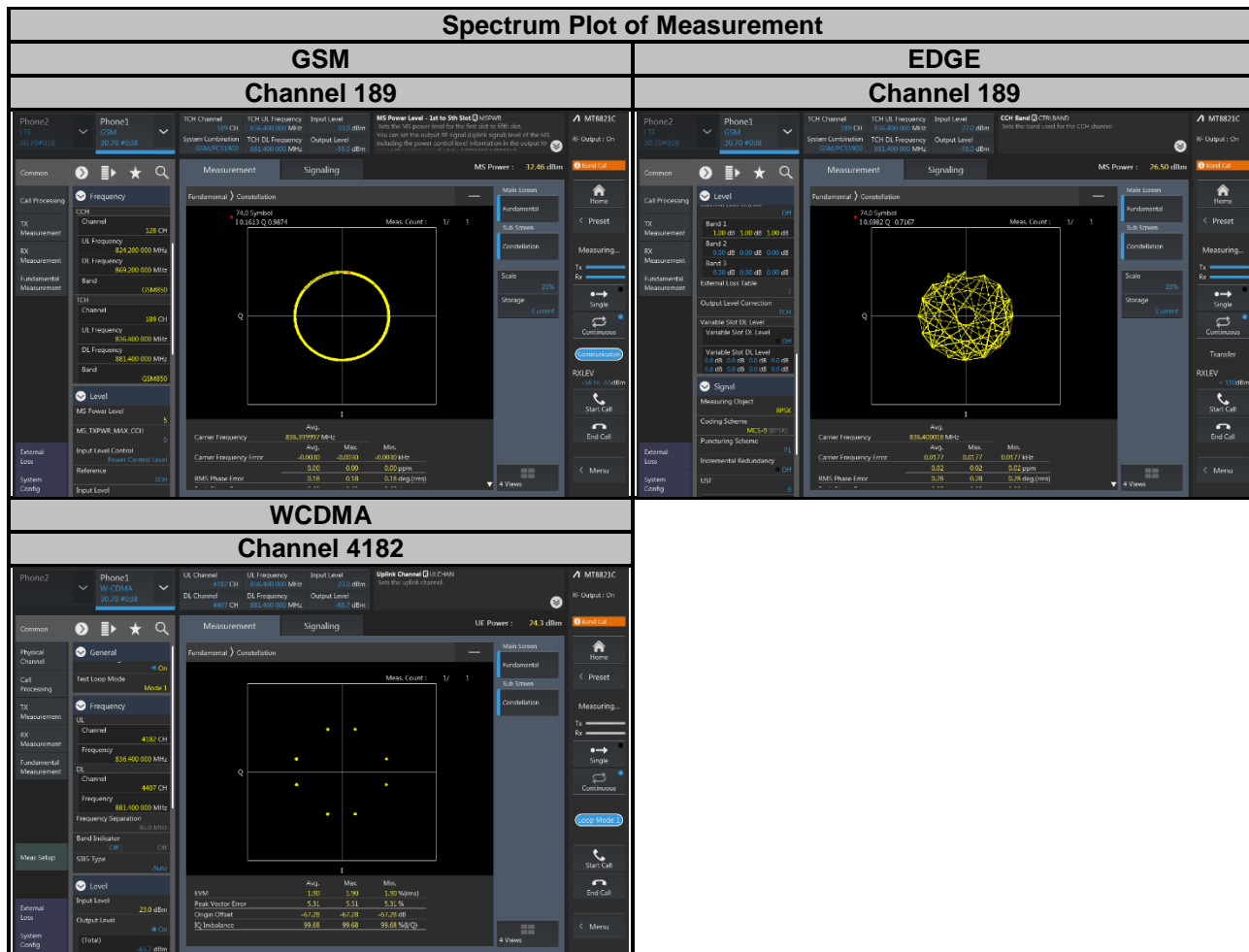

Spectrum Plot of Measurement

LTE Band 5

Channel 20525

QPSK

16QAM

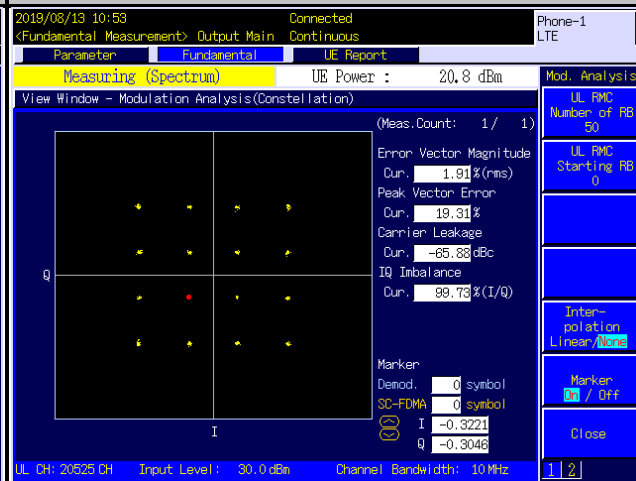
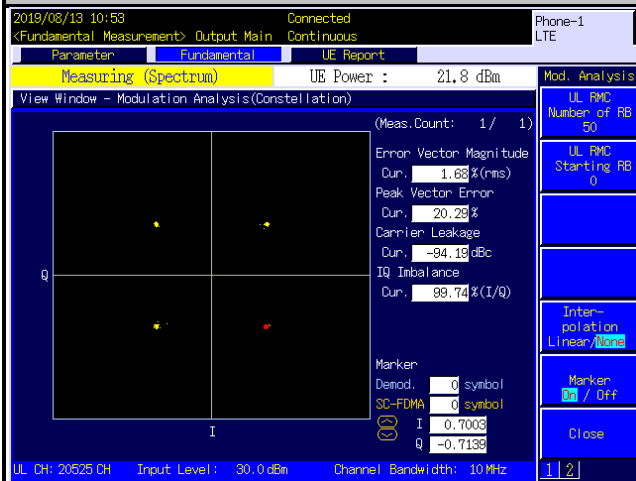

64QAM

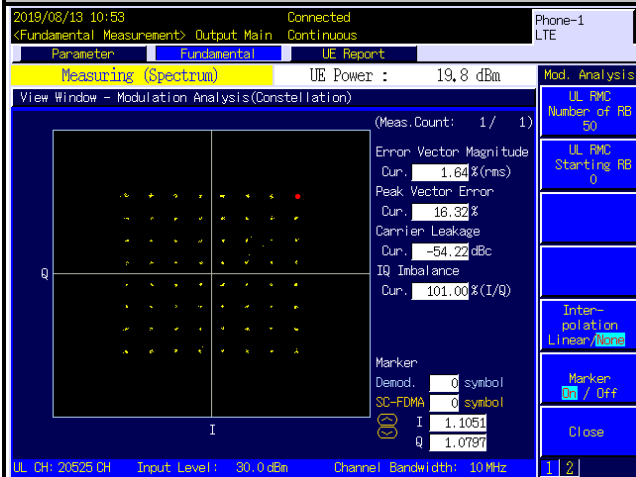

4.3 Frequency Stability Measurement

4.3.1 Limits of Frequency Stability Measurement

1.5 ppm is for base and fixed station. 2.5 ppm is for mobile station.

4.3.2 Test Procedure

- a. Device is placed at the oven room. The oven room could control the temperatures and humidity. Power warm up is at least 15 min and power applied should perform before recording frequency error.
- b. EUT is connected the external power supply to control the DC input power. The test voltage range is from minimum to maximum working voltage. Each step shall be record the frequency error rate.
- c. The temperature range step is 10 degrees in this test items. All temperature levels shall be hold the ± 0.5 °C during the measurement testing. The each temperature step shall be at least 0.5 hours, consider the EUT could be test under the stability condition.

NOTE: The frequency error was recorded frequency error from the communication simulator.

4.3.3 Test Setup

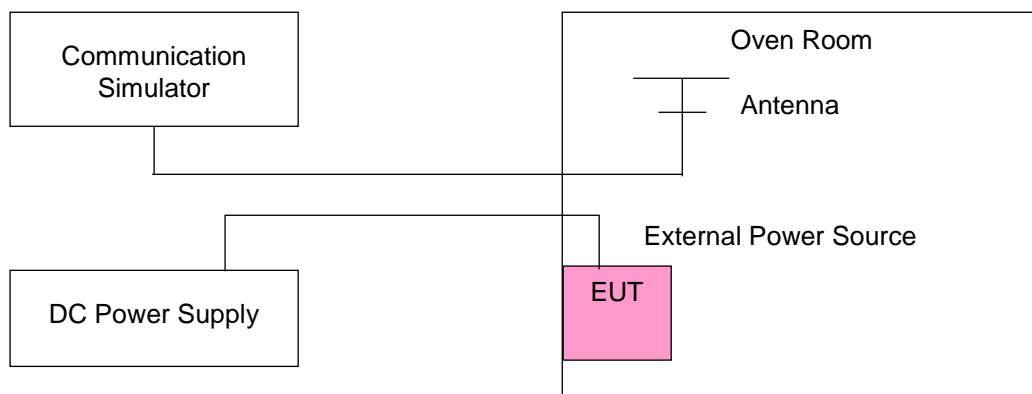

4.3.4 Test Results

Frequency Error vs. Voltage

Voltage (Volts)	GSM				Limit (ppm)
	Low Channel		High Channel		
	Frequency (MHz)	Frequency Error (ppm)	Frequency (MHz)	Frequency Error (ppm)	
3.8	824.200002	0.003	848.800004	0.004	2.5
3.4	824.200001	0.001	848.800003	0.003	2.5
4.35	824.200003	0.003	848.800002	0.002	2.5

Note: The applicant defined the normal working voltage of the battery is from 3.4 Vdc to 4.35 Vdc.

Frequency Error vs. Temperature

Temp. (°C)	GSM				Limit (ppm)
	Low Channel		High Channel		
	Frequency (MHz)	Frequency Error (ppm)	Frequency (MHz)	Frequency Error (ppm)	
-25	824.200003	0.004	848.800002	0.003	2.5
-20	824.200002	0.002	848.800002	0.002	2.5
-10	824.200003	0.004	848.800003	0.003	2.5
0	824.200003	0.003	848.800003	0.003	2.5
10	824.200003	0.004	848.800002	0.002	2.5
20	824.199998	-0.003	848.799996	-0.004	2.5
30	824.199997	-0.004	848.799996	-0.004	2.5
40	824.199998	-0.002	848.799998	-0.002	2.5
50	824.199998	-0.003	848.799997	-0.004	2.5
55	824.199999	-0.002	848.799998	-0.002	2.5

Note:

1. The applicant declared that the normal operating temperature of the EUT is from -25°C to 55°C.
2. The EUT would shut down automatically as below -25°C.

Frequency Error vs. Voltage

Voltage (Volts)	EDGE				Limit (ppm)
	Low Channel		High Channel		
	Frequency (MHz)	Frequency Error (ppm)	Frequency (MHz)	Frequency Error (ppm)	
3.8	824.200002	0.002	848.800002	0.002	2.5
3.4	824.200001	0.001	848.800003	0.004	2.5
4.35	824.200003	0.004	848.800004	0.004	2.5

Note: The applicant defined the normal working voltage of the battery is from 3.4 Vdc to 4.35 Vdc.

Frequency Error vs. Temperature

Temp. (°C)	EDGE				Limit (ppm)
	Low Channel		High Channel		
	Frequency (MHz)	Frequency Error (ppm)	Frequency (MHz)	Frequency Error (ppm)	
-25	824.200002	0.003	848.800001	0.002	2.5
-20	824.200004	0.005	848.800002	0.002	2.5
-10	824.200001	0.001	848.800002	0.003	2.5
0	824.200001	0.002	848.800002	0.002	2.5
10	824.200004	0.004	848.800004	0.004	2.5
20	824.199996	-0.005	848.799997	-0.003	2.5
30	824.199998	-0.003	848.799998	-0.003	2.5
40	824.199998	-0.003	848.799999	-0.001	2.5
50	824.199996	-0.005	848.799999	-0.001	2.5
55	824.199996	-0.005	848.799998	-0.003	2.5

Note:

1. The applicant declared that the normal operating temperature of the EUT is from -25°C to 55°C.
2. The EUT would shut down automatically as below -25°C.

Frequency Error vs. Voltage

Voltage (Volts)	WCDMA				Limit (ppm)
	Low Channel		High Channel		
	Frequency (MHz)	Frequency Error (ppm)	Frequency (MHz)	Frequency Error (ppm)	
3.8	826.400004	0.005	846.600001	0.001	2.5
3.4	826.400004	0.005	846.600003	0.003	2.5
4.35	826.400001	0.001	846.600002	0.002	2.5

Note: The applicant defined the normal working voltage of the battery is from 3.4 Vdc to 4.35 Vdc.

Frequency Error vs. Temperature

Temp. (°C)	WCDMA				Limit (ppm)
	Low Channel		High Channel		
	Frequency (MHz)	Frequency Error (ppm)	Frequency (MHz)	Frequency Error (ppm)	
-25	826.400004	0.005	846.600002	0.002	2.5
-20	826.400003	0.004	846.600003	0.004	2.5
-10	826.400001	0.001	846.600001	0.002	2.5
0	826.400002	0.002	846.600002	0.002	2.5
10	826.400002	0.003	846.600002	0.002	2.5
20	826.399999	-0.002	846.599997	-0.003	2.5
30	826.399997	-0.004	846.599999	-0.001	2.5
40	826.399997	-0.004	846.599997	-0.004	2.5
50	826.399999	-0.001	846.599996	-0.004	2.5
55	826.399998	-0.002	846.599998	-0.003	2.5

Note:

1. The applicant declared that the normal operating temperature of the EUT is from -25°C to 55°C.
2. The EUT would shut down automatically as below -25°C.

Frequency Error vs. Voltage

Voltage (Volts)	LTE Band 5				Limit (ppm)
	Channel Bandwidth: 1.4 MHz				
	Low Channel		High Channel		
	Frequency (MHz)	Frequency Error (ppm)	Frequency (MHz)	Frequency Error (ppm)	
3.8	824.700001	0.001	848.300003	0.003	2.5
3.4	824.700004	0.005	848.300003	0.004	2.5
4.35	824.700003	0.003	848.300001	0.001	2.5

Note: The applicant defined the normal working voltage of the battery is from 3.4 Vdc to 4.35 Vdc.

Frequency Error vs. Temperature

Temp. (°C)	LTE Band 5				Limit (ppm)
	Channel Bandwidth: 1.4 MHz				
	Low Channel		High Channel		
	Frequency (MHz)	Frequency Error (ppm)	Frequency (MHz)	Frequency Error (ppm)	
-25	824.700003	0.004	848.300004	0.005	2.5
-20	824.700003	0.004	848.300001	0.001	2.5
-10	824.700004	0.005	848.300003	0.003	2.5
0	824.700004	0.004	848.300004	0.005	2.5
10	824.700003	0.003	848.300002	0.002	2.5
20	824.699996	-0.005	848.299997	-0.004	2.5
30	824.699998	-0.003	848.299998	-0.003	2.5
40	824.699998	-0.003	848.299997	-0.003	2.5
50	824.699996	-0.004	848.299996	-0.005	2.5
55	824.699999	-0.001	848.299998	-0.002	2.5

Note:

1. The applicant declared that the normal operating temperature of the EUT is from -25°C to 55°C.
2. The EUT would shut down automatically as below -25°C.

Frequency Error vs. Voltage

Voltage (Volts)	LTE Band 5				Limit (ppm)
	Channel Bandwidth: 3 MHz				
	Low Channel		High Channel		
	Frequency (MHz)	Frequency Error (ppm)	Frequency (MHz)	Frequency Error (ppm)	
3.8	825.500003	0.004	847.500003	0.004	2.5
3.4	825.500003	0.004	847.500002	0.003	2.5
4.35	825.500003	0.003	847.500001	0.001	2.5

Note: The applicant defined the normal working voltage of the battery is from 3.4 Vdc to 4.35 Vdc.

Frequency Error vs. Temperature

Temp. (°C)	LTE Band 5				Limit (ppm)
	Channel Bandwidth: 3 MHz				
	Low Channel		High Channel		
	Frequency (MHz)	Frequency Error (ppm)	Frequency (MHz)	Frequency Error (ppm)	
-25	825.500003	0.003	847.500003	0.003	2.5
-20	825.500002	0.003	847.500002	0.002	2.5
-10	825.500002	0.003	847.500002	0.003	2.5
0	825.500002	0.002	847.500003	0.004	2.5
10	825.500004	0.005	847.500002	0.002	2.5
20	825.499996	-0.004	847.499997	-0.004	2.5
30	825.499999	-0.002	847.499998	-0.002	2.5
40	825.499997	-0.004	847.499996	-0.005	2.5
50	825.499997	-0.004	847.499997	-0.004	2.5
55	825.499998	-0.003	847.499998	-0.002	2.5

Note:

1. The applicant declared that the normal operating temperature of the EUT is from -25°C to 55°C.
2. The EUT would shut down automatically as below -25°C.

Frequency Error vs. Voltage

Voltage (Volts)	LTE Band 5				Limit (ppm)
	Channel Bandwidth: 5 MHz				
	Low Channel		High Channel		
	Frequency (MHz)	Frequency Error (ppm)	Frequency (MHz)	Frequency Error (ppm)	
3.8	826.500003	0.004	846.500001	0.002	2.5
3.4	826.500001	0.002	846.500002	0.002	2.5
4.35	826.500001	0.001	846.500002	0.002	2.5

Note: The applicant defined the normal working voltage of the battery is from 3.4 Vdc to 4.35 Vdc.

Frequency Error vs. Temperature

Temp. (°C)	LTE Band 5				Limit (ppm)
	Channel Bandwidth: 5 MHz				
	Low Channel		High Channel		
	Frequency (MHz)	Frequency Error (ppm)	Frequency (MHz)	Frequency Error (ppm)	
-25	826.500003	0.004	846.500002	0.002	2.5
-20	826.500002	0.003	846.500001	0.001	2.5
-10	826.500002	0.002	846.500003	0.003	2.5
0	826.500002	0.002	846.500001	0.001	2.5
10	826.500004	0.005	846.500001	0.002	2.5
20	826.499998	-0.002	846.499999	-0.001	2.5
30	826.499998	-0.002	846.499996	-0.005	2.5
40	826.499999	-0.001	846.499999	-0.002	2.5
50	826.499996	-0.004	846.499998	-0.003	2.5
55	826.499996	-0.005	846.499999	-0.002	2.5

Note:

1. The applicant declared that the normal operating temperature of the EUT is from -25°C to 55°C.
2. The EUT would shut down automatically as below -25°C.

Frequency Error vs. Voltage

Voltage (Volts)	LTE Band 5				Limit (ppm)
	Channel Bandwidth: 10 MHz				
	Low Channel		High Channel		
	Frequency (MHz)	Frequency Error (ppm)	Frequency (MHz)	Frequency Error (ppm)	
3.8	829.000002	0.002	844.000002	0.002	2.5
3.4	829.000001	0.001	844.000001	0.002	2.5
4.35	829.000004	0.004	844.000002	0.002	2.5

Note: The applicant defined the normal working voltage of the battery is from 3.4 Vdc to 4.35 Vdc.

Frequency Error vs. Temperature

Temp. (°C)	LTE Band 5				Limit (ppm)
	Channel Bandwidth: 10 MHz				
	Low Channel		High Channel		
	Frequency (MHz)	Frequency Error (ppm)	Frequency (MHz)	Frequency Error (ppm)	
-25	829.000002	0.003	844.000002	0.002	2.5
-20	829.000004	0.004	844.000003	0.004	2.5
-10	829.000004	0.005	844.000001	0.002	2.5
0	829.000003	0.004	844.000003	0.003	2.5
10	829.000003	0.003	844.000001	0.002	2.5
20	828.999997	-0.003	843.999997	-0.004	2.5
30	828.999997	-0.003	843.999996	-0.005	2.5
40	828.999997	-0.004	843.999999	-0.002	2.5
50	828.999997	-0.003	843.999997	-0.004	2.5
55	828.999999	-0.002	843.999998	-0.002	2.5

Note:

1. The applicant declared that the normal operating temperature of the EUT is from -25°C to 55°C.
2. The EUT would shut down automatically as below -25°C.

4.4 Occupied Bandwidth Measurement

4.4.1 Test Procedure

The EUT makes a call to the communication simulator. All measurements were done at low, middle and high operational frequency range. The communication simulator station system controlled a EUT to export maximum output power under transmission mode and specific channel frequency. Use OBW measurement function of Spectrum analyzer to measure 99 % occupied bandwidth.

4.4.2 Test Setup

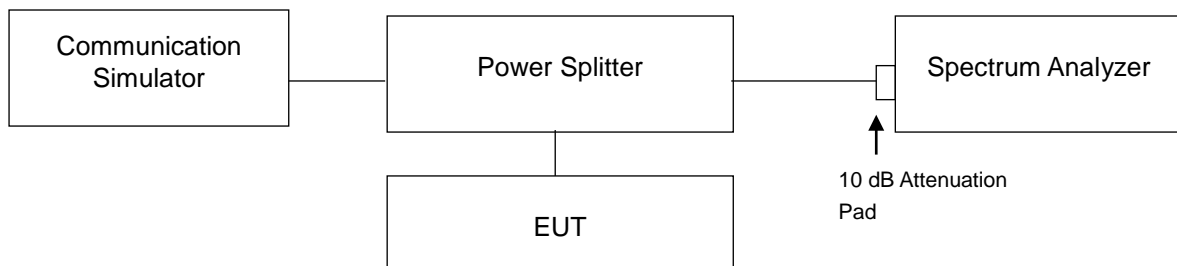

4.4.3 Test Result

GSM				EDGE			
Channel	Frequency (MHz)	99 % Occupied Bandwidth (kHz)	26 dB Bandwidth (kHz)	Channel	Frequency (MHz)	99 % Occupied Bandwidth (kHz)	26 dB Bandwidth (kHz)
128	824.2	247.25	309.70	128	824.2	247.86	311.80
189	836.4	247.03	316.90	189	836.4	248.44	320.30
251	848.8	245.88	316.10	251	848.8	247.20	311.60

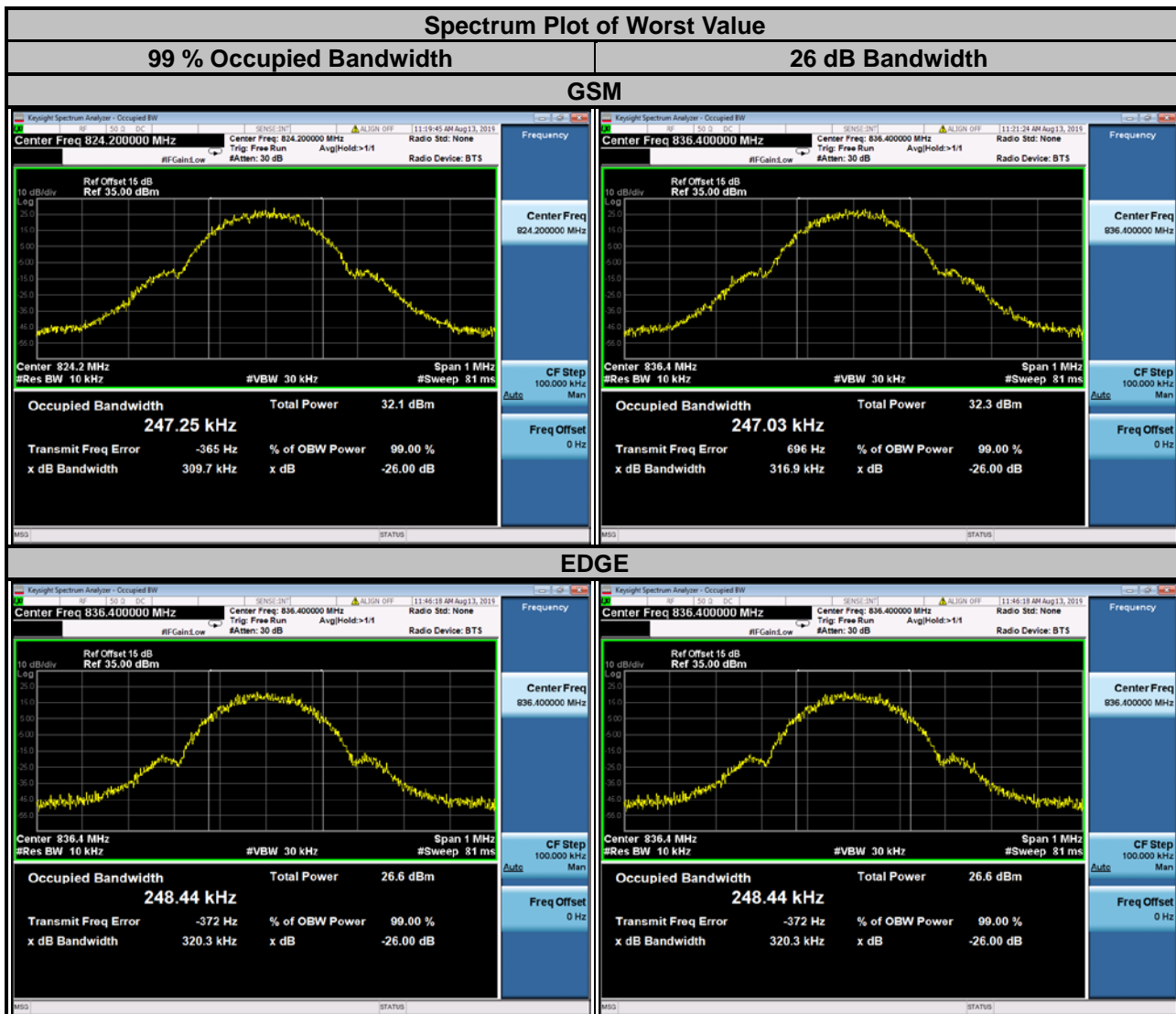

WCDMA			
Channel	Frequency (MHz)	99 % Occupied Bandwidth (MHz)	26 dB Bandwidth (MHz)
4132	826.4	4.186	4.720
4182	836.4	4.181	4.720
4233	846.6	4.192	4.740

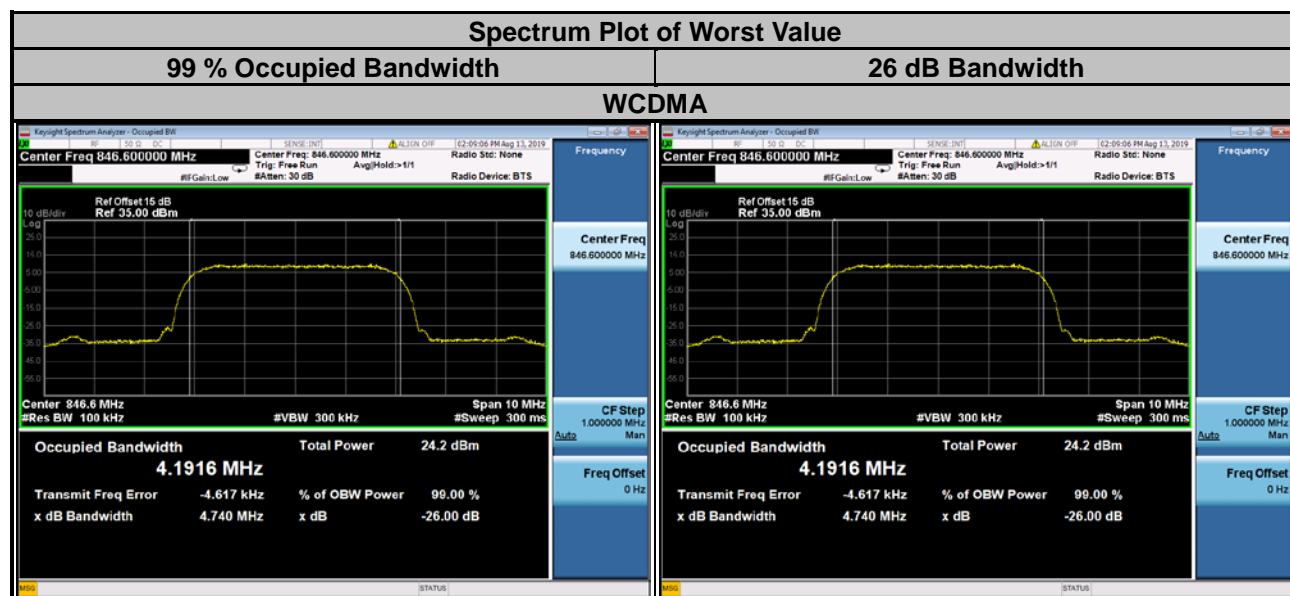

LTE Band 5							
Channel Bandwidth: 1.4 MHz							
Channel	Frequency (MHz)	99 % Occupied Bandwidth (MHz)			26 dB Bandwidth (MHz)		
		QPSK	16QAM	64QAM	QPSK	16QAM	64QAM
20407	824.7	1.087	1.088	1.086	1.233	1.252	1.257
20525	836.5	1.088	1.087	1.088	1.245	1.256	1.250
20643	848.3	1.087	1.090	1.087	1.248	1.252	1.258

Channel Bandwidth: 3 MHz							
Channel	Frequency (MHz)	99 % Occupied Bandwidth (MHz)			26 dB Bandwidth (MHz)		
		QPSK	16QAM	64QAM	QPSK	16QAM	64QAM
20415	825.5	2.696	2.689	2.693	2.863	2.870	2.858
20525	836.5	2.697	2.691	2.693	2.870	2.873	2.866
20635	847.5	2.698	2.692	2.694	2.869	2.872	2.861

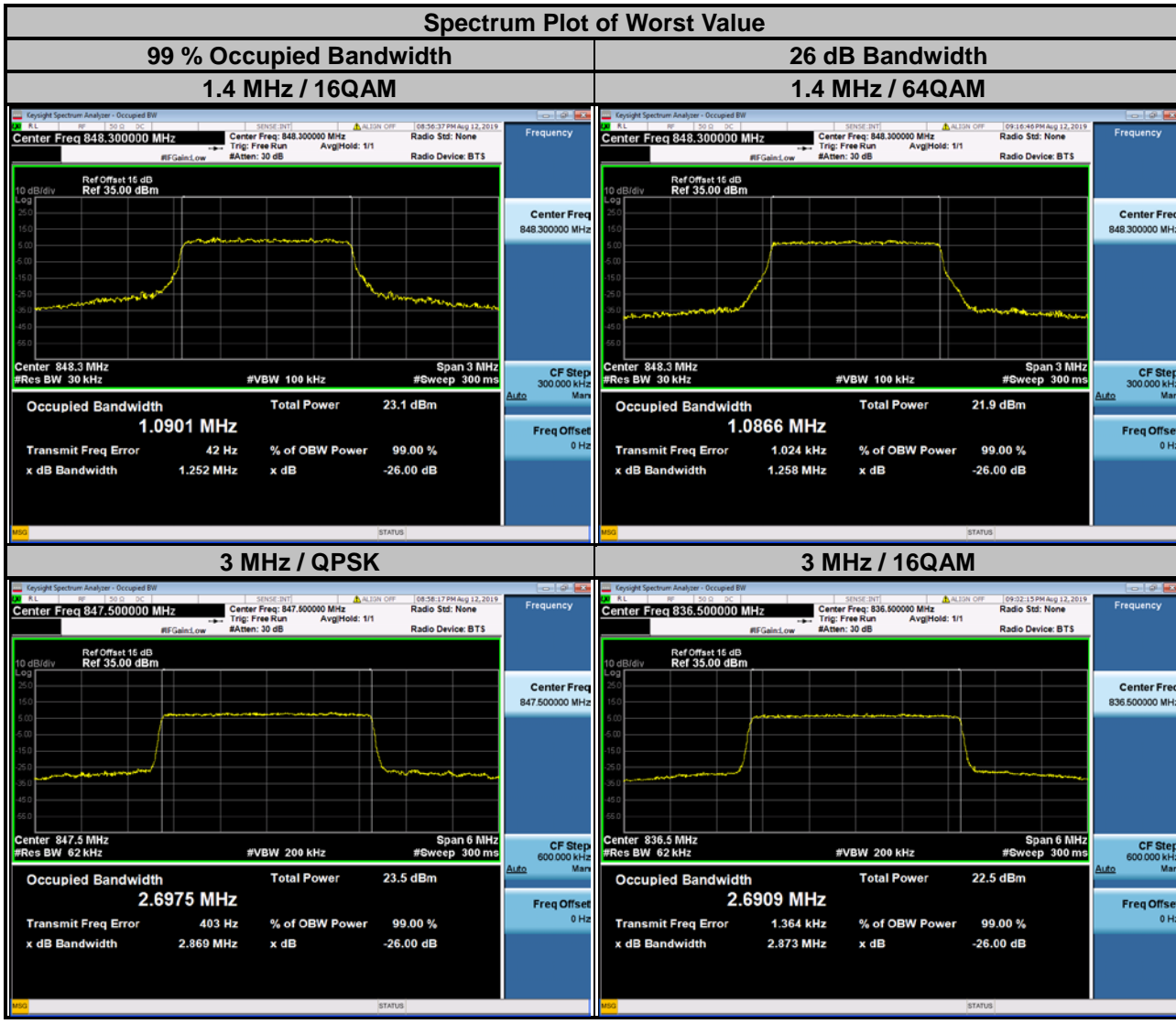

LTE Band 5

Channel Bandwidth: 5 MHz

Channel	Frequency (MHz)	99 % Occupied Bandwidth (MHz)			26 dB Bandwidth (MHz)		
		QPSK	16QAM	64QAM	QPSK	16QAM	64QAM
20425	826.5	4.486	4.490	4.495	4.761	4.765	4.795
20525	836.5	4.492	4.494	4.498	4.769	4.777	4.779
20625	846.5	4.492	4.494	4.501	4.769	4.769	4.787

Channel Bandwidth: 10 MHz

Channel	Frequency (MHz)	99 % Occupied Bandwidth (MHz)			26 dB Bandwidth (MHz)		
		QPSK	16QAM	64QAM	QPSK	16QAM	64QAM
20450	829.0	8.978	8.984	8.982	9.491	9.498	9.504
20525	836.5	8.974	8.980	8.979	9.490	9.490	9.502
20600	844.0	8.975	8.975	8.980	9.475	9.497	9.508

Spectrum Plot of Worst Value

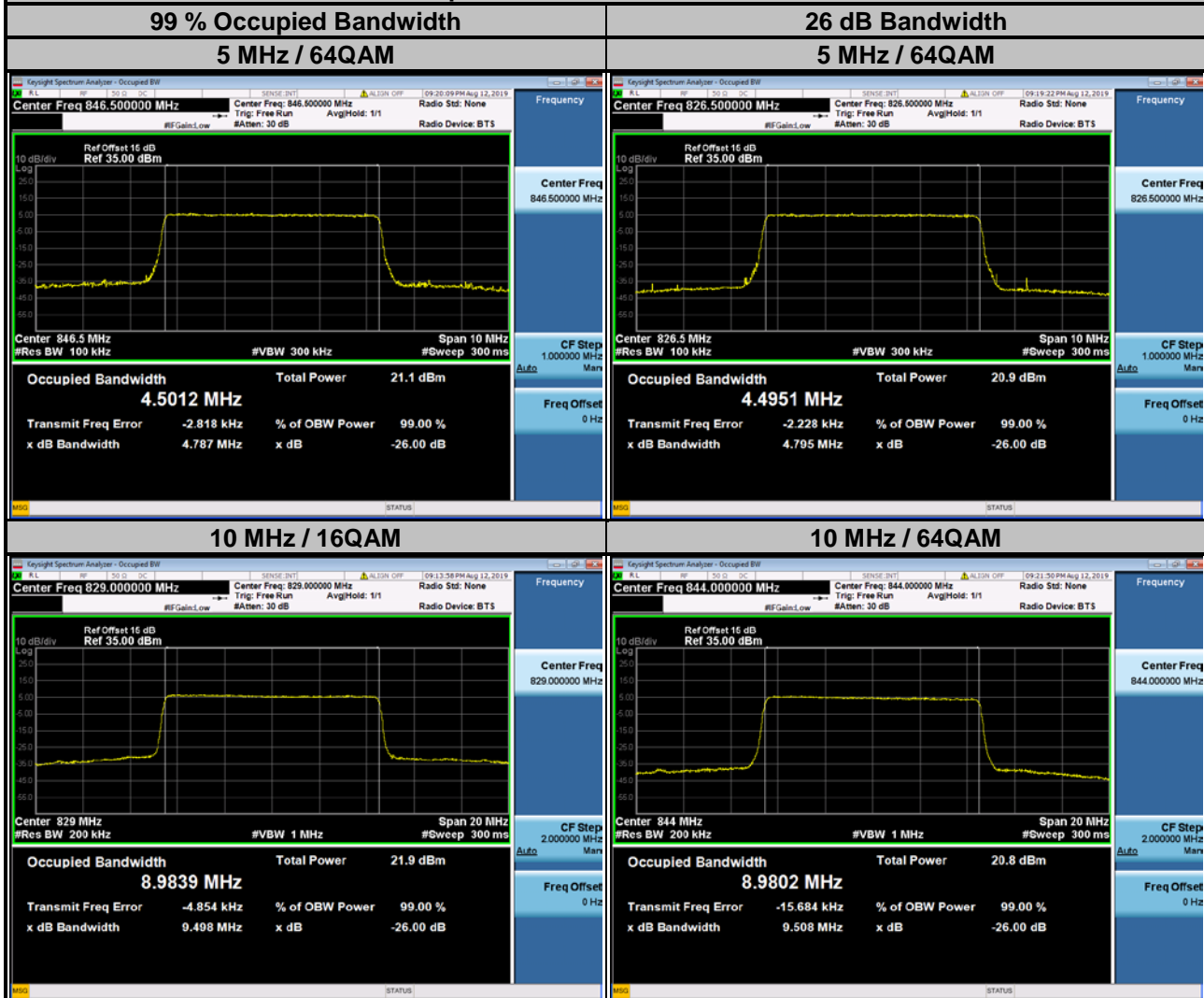

4.5 Band Edge Measurement

4.5.1 Limits of Band Edge Measurement

Power of any emission outside of the authorized operating frequency ranges must be attenuated below the transmitting power (P) by a factor of at least $43 + 10 \log(P)$ dB. In the 1 MHz bands immediately outside and adjacent to the frequency block a resolution bandwidth of at least one percent of the emission bandwidth of the fundamental emission of the transmitter may be employed.

4.5.2 Test Setup

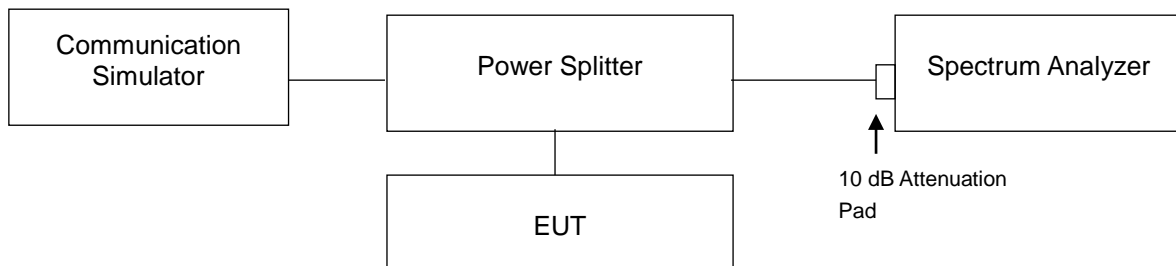

4.5.3 Test Procedures

- a. All measurements were done at low and high operational frequency range.
- b. The center frequency of spectrum is the band edge frequency and span is 1 MHz. RB of the spectrum is 3.9 kHz and VB of the spectrum is 12 kHz (GSM/GPRS/EDGE).
- c. The center frequency of spectrum is the band edge frequency and span is 5 MHz. RB of the spectrum is 51 kHz and VB of the spectrum is 160 kHz (WCDMA).
- d. The center frequency of spectrum is the band edge frequency and span is 1 MHz. RB of the spectrum is 15 kHz and VB of the spectrum is 51 kHz (LTE Bandwidth 1.4 MHz).
- e. The center frequency of spectrum is the band edge frequency and span is 1 MHz. RB of the spectrum is 30 kHz and VB of the spectrum is 100 kHz (LTE Bandwidth 3 MHz).
- f. The center frequency of spectrum is the band edge frequency and span is 1 MHz. RB of the spectrum is 51 kHz and VB of the spectrum is 160 kHz (LTE Bandwidth 5 MHz).
- g. The center frequency of spectrum is the band edge frequency and span is 1 MHz. RB of the spectrum is 100 kHz and VB of the spectrum is 300 kHz (LTE Bandwidth 10 MHz).
- h. Record the max trace plot into the test report.

4.5.4 Test Results

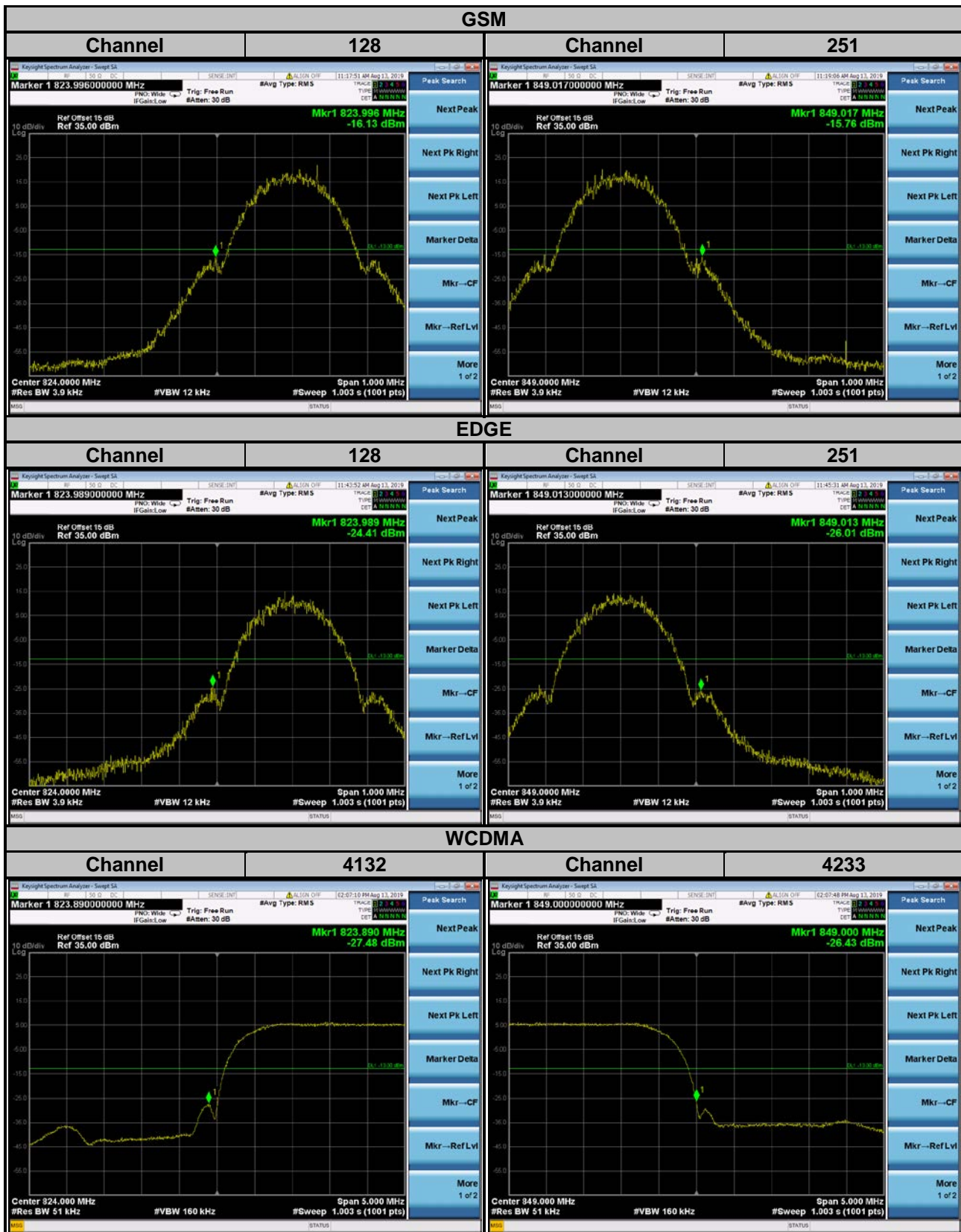

LTE Band 5

Channel Bandwidth: 1.4 MHz

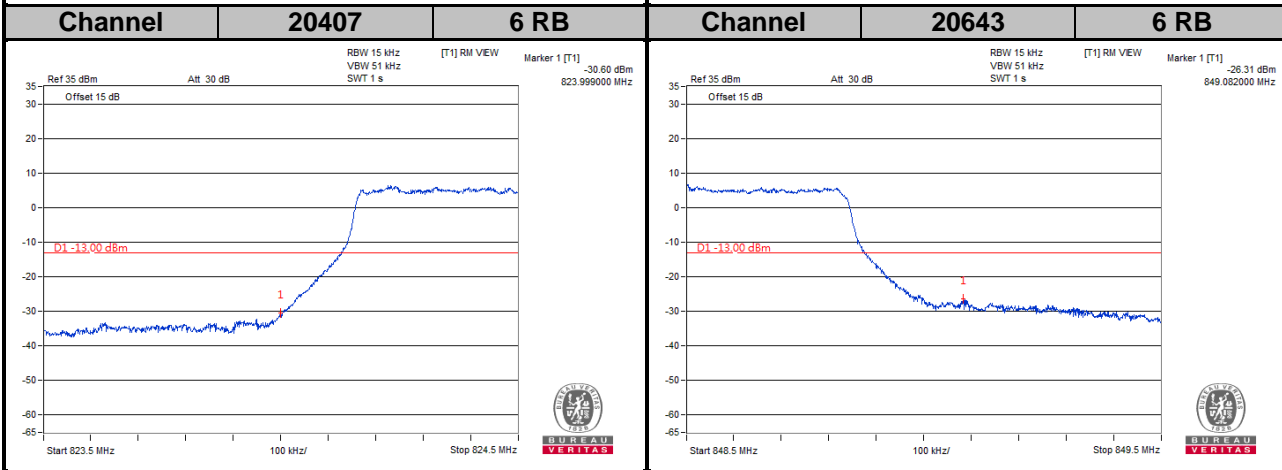
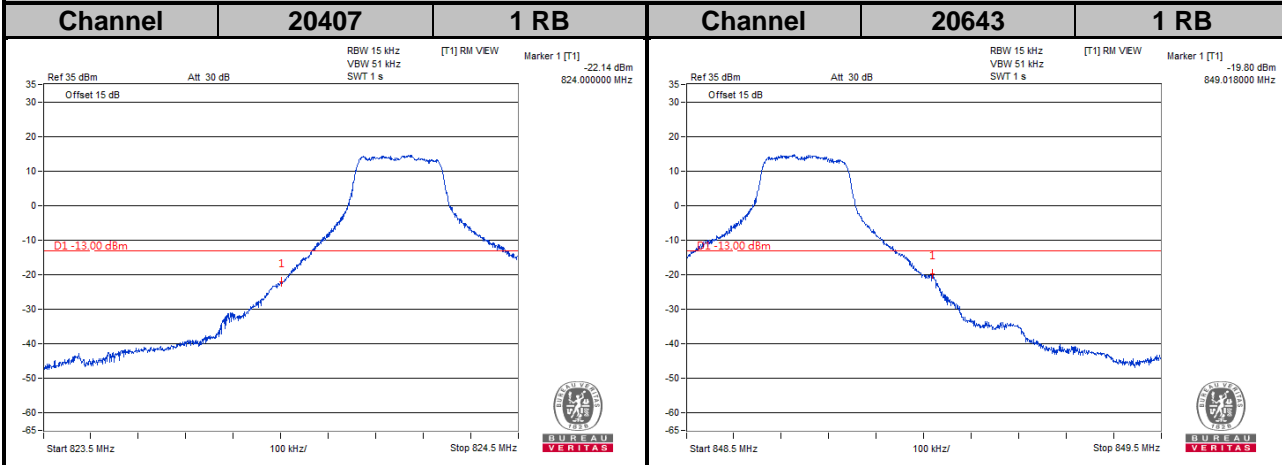

LTE Band 5
Channel Bandwidth: 3 MHz

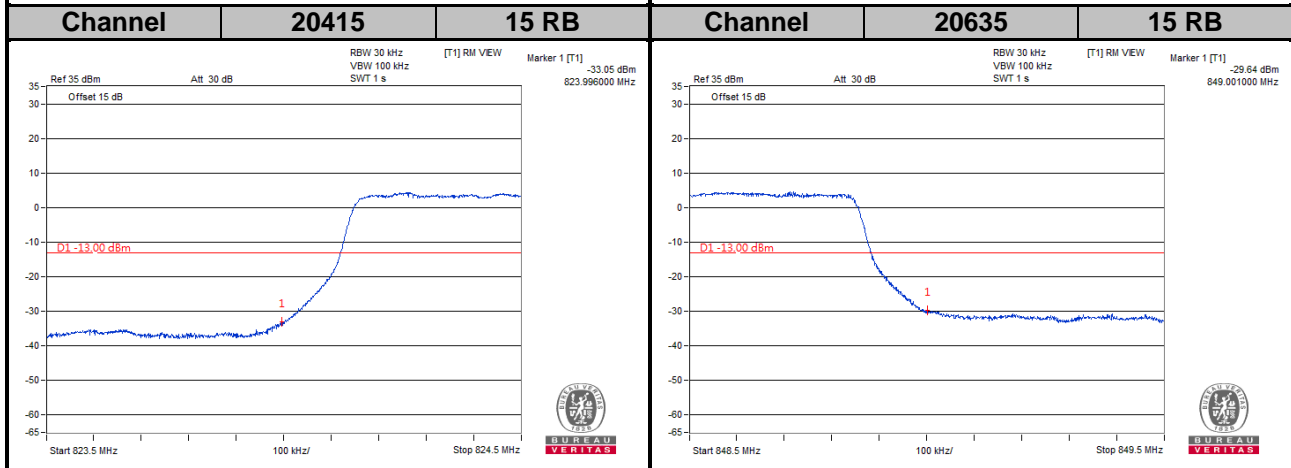
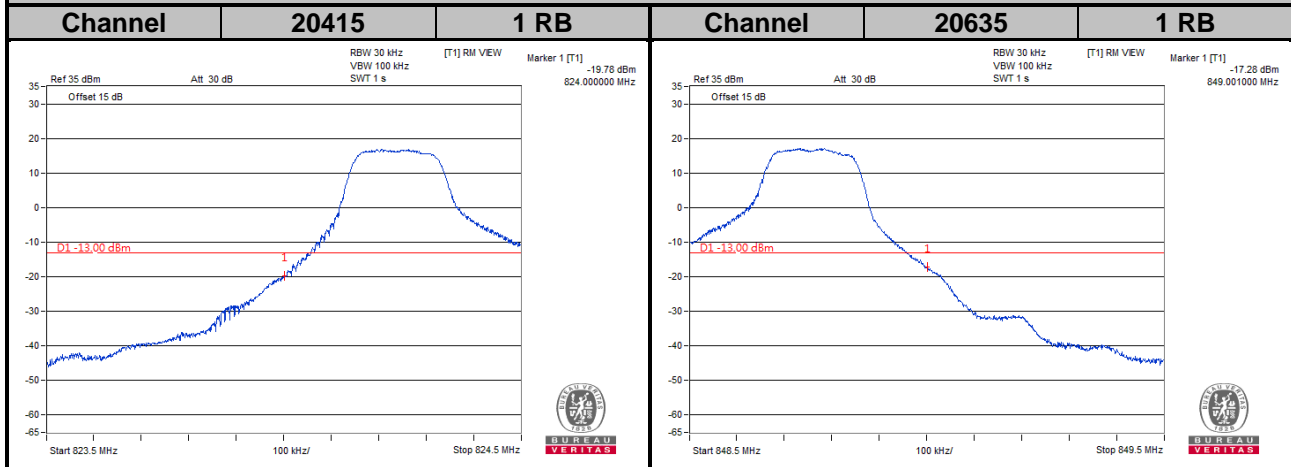

LTE Band 5

Channel Bandwidth: 5 MHz

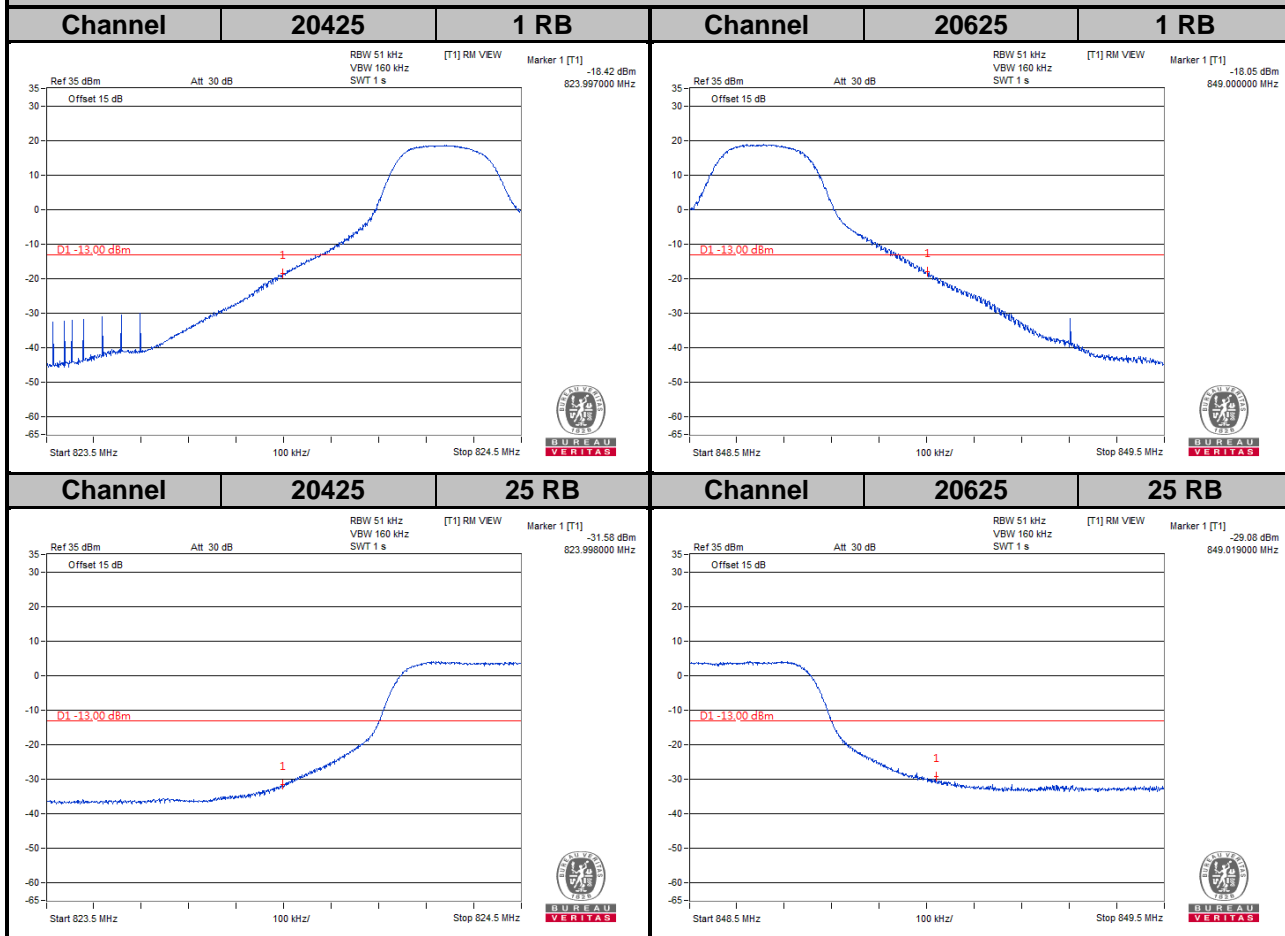

LTE Band 5

Channel Bandwidth: 10 MHz

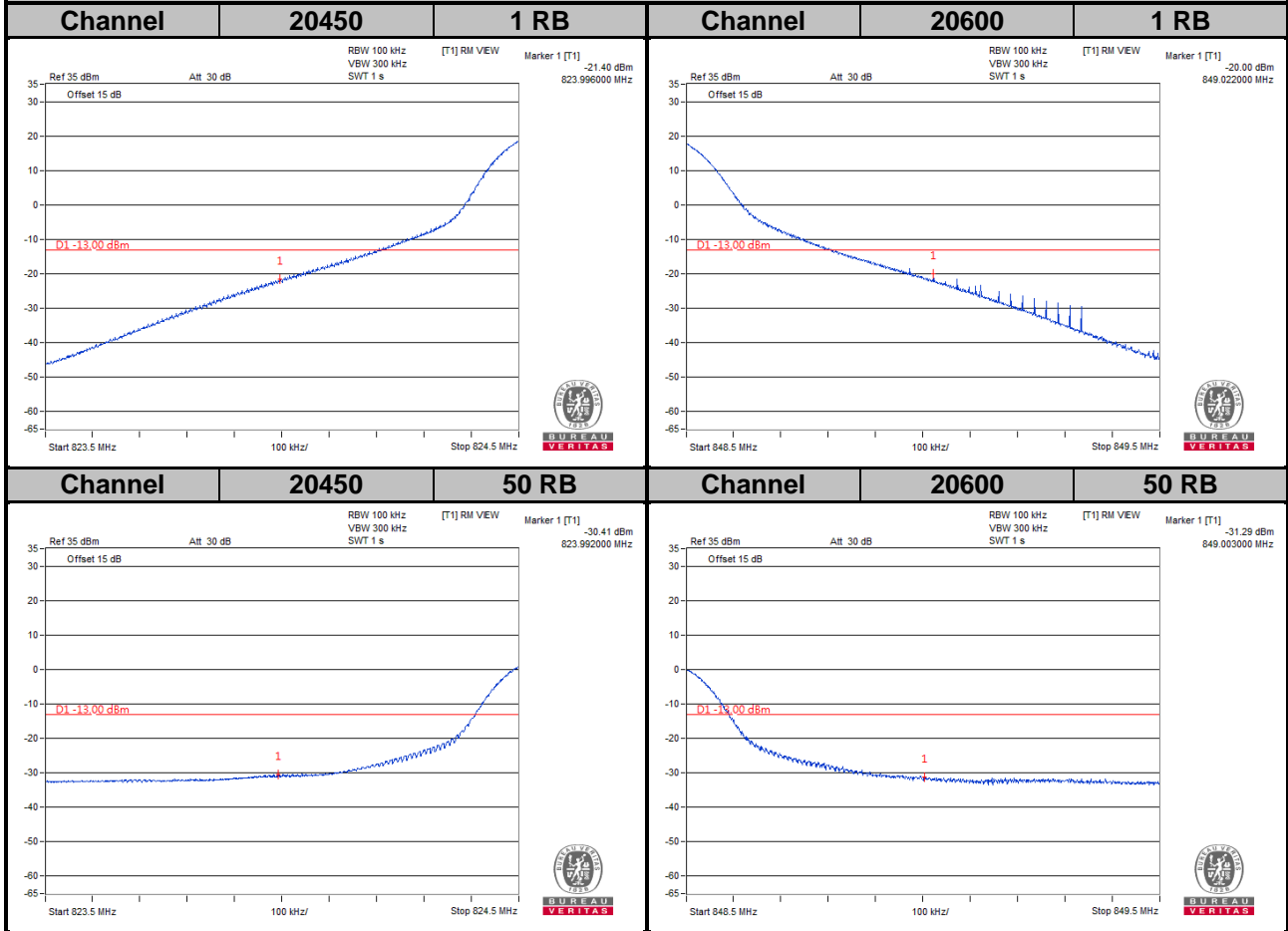

4.6 Peak to Average Ratio

4.6.1 Limits of Peak to Average Ratio Measurement

In measuring transmissions in this band using an average power technique, the peak to-average ratio (PAR) of the transmission may not exceed 13 dB.

4.6.2 Test Setup

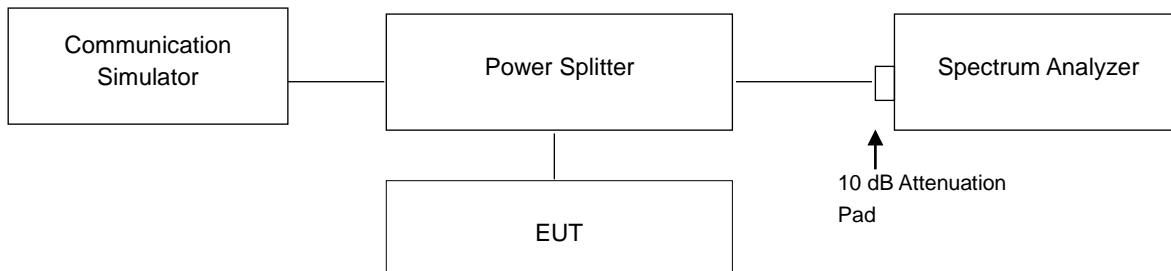

4.6.3 Test Procedures

1. Set resolution/measurement bandwidth \geq signal's occupied bandwidth;
2. Set the number of counts to a value that stabilizes the measured CCDF curve;
3. Record the maximum PAPR level associated with a probability of 0.1 %.

4.6.4 Test Results

Channel	Frequency (MHz)	Peak to Average Ratio (dB)		Channel	Frequency (MHz)	Peak to Average Ratio (dB)
		GSM	EDGE			WCDMA
128	824.2	0.07	3.31	4132	826.4	2.91
189	836.4	0.07	3.31	4182	836.4	3.04
251	848.8	0.08	3.27	4233	846.6	2.77



LTE Band 5

Channel Bandwidth: 1.4 MHz					Channel Bandwidth: 3 MHz				
Channel	Frequency (MHz)	Peak to Average Ratio (dB)			Channel	Frequency (MHz)	Peak to Average Ratio (dB)		
		QPSK	16QAM	64QAM			QPSK	16QAM	64QAM
20407	824.7	4.36	5.34	6.02	20415	825.5	4.34	5.20	6.02
20525	836.5	4.74	5.67	6.37	20525	836.5	4.69	5.49	6.35
20643	848.3	3.60	4.64	5.42	20635	847.5	3.70	4.57	5.51

Spectrum Plot of Worst Value

1.4 MHz / 64QAM

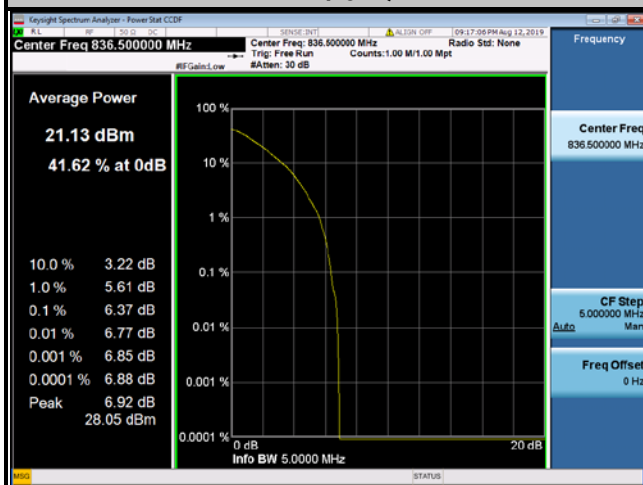

3 MHz / 64QAM

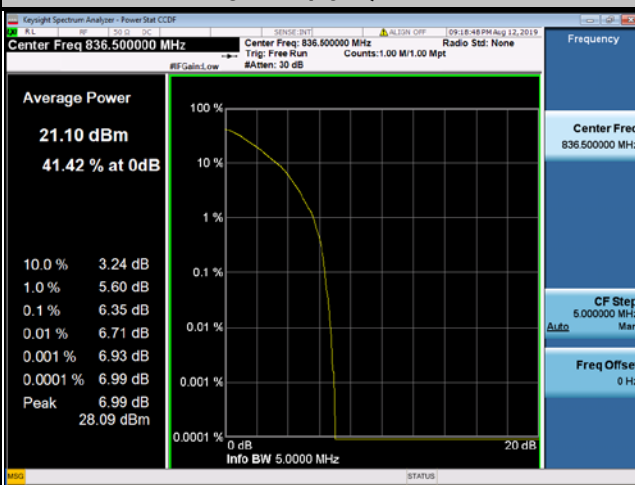

LTE Band 5

Channel Bandwidth: 5 MHz					Channel Bandwidth: 10 MHz				
Channel	Frequency (MHz)	Peak to Average Ratio (dB)			Channel	Frequency (MHz)	Peak to Average Ratio (dB)		
		QPSK	16QAM	64QAM			QPSK	16QAM	64QAM
20425	826.5	4.45	5.37	6.07	20450	829.0	4.40	5.30	6.06
20525	836.5	4.90	5.74	6.45	20525	836.5	4.79	5.66	6.37
20625	846.5	3.94	4.87	5.61	20600	844.0	4.32	5.26	6.02

Spectrum Plot of Worst Value

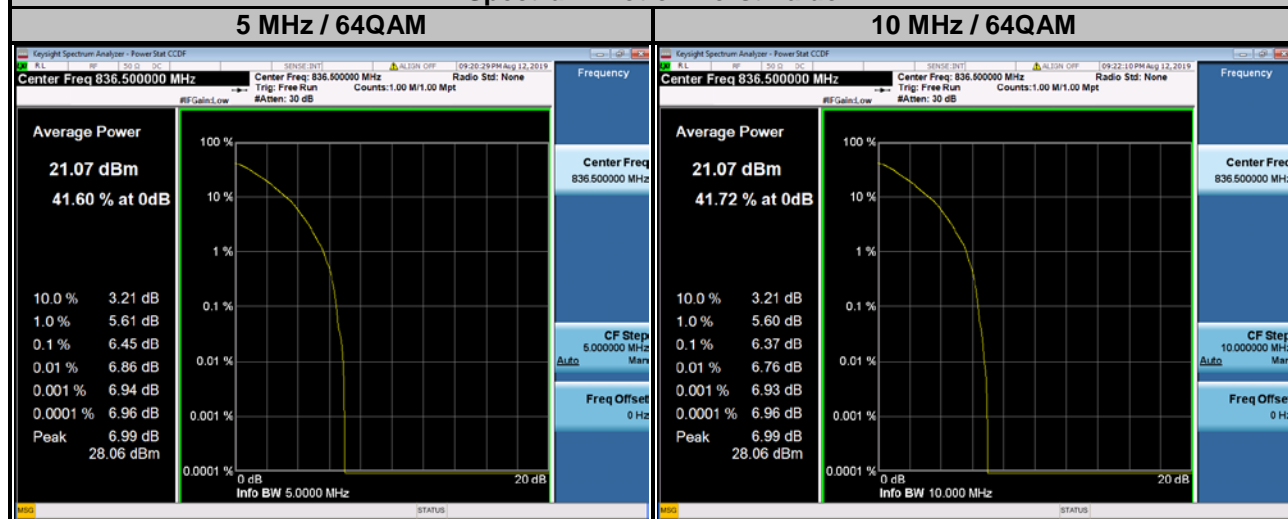

4.7 Conducted Spurious Emissions

4.7.1 Limits of Conducted Spurious Emissions Measurement

The power of any emission outside of the authorized operating frequency ranges must be attenuated below the transmitting power (P) by a factor of at least $43 + 10 \log(P)$ dB. The emission limit equal to -13 dBm.

4.7.2 Test Setup

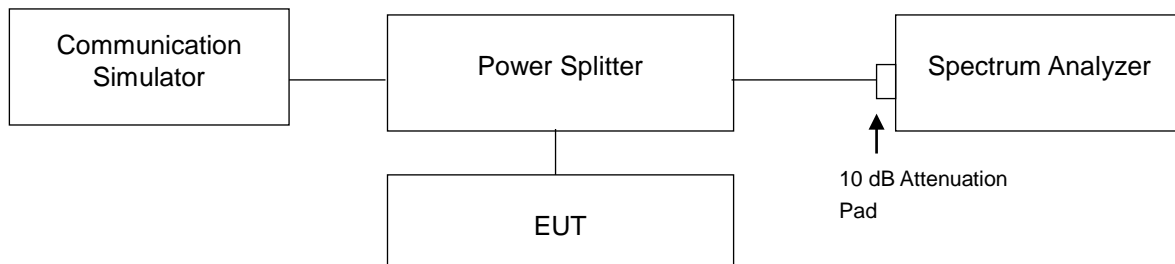

4.7.3 Test Procedure

- The EUT makes a phone call to the communication simulator. All measurements were done at low, middle and high operational frequency range.
- Measuring frequency range is from 9 kHz to 1 GHz. 10 dB attenuation pad is connected with spectrum. RBW = 100 kHz and VBW = 300 kHz is used for conducted emission measurement.
- Measuring frequency range is from 1 GHz to 9 GHz. 10 dB attenuation pad is connected with spectrum. RBW = 1 MHz and VBW = 3 MHz is used for conducted emission measurement.

4.7.4 Test Results



Note: The signal over the limit in 9 kHz is from spectrum analyzer.

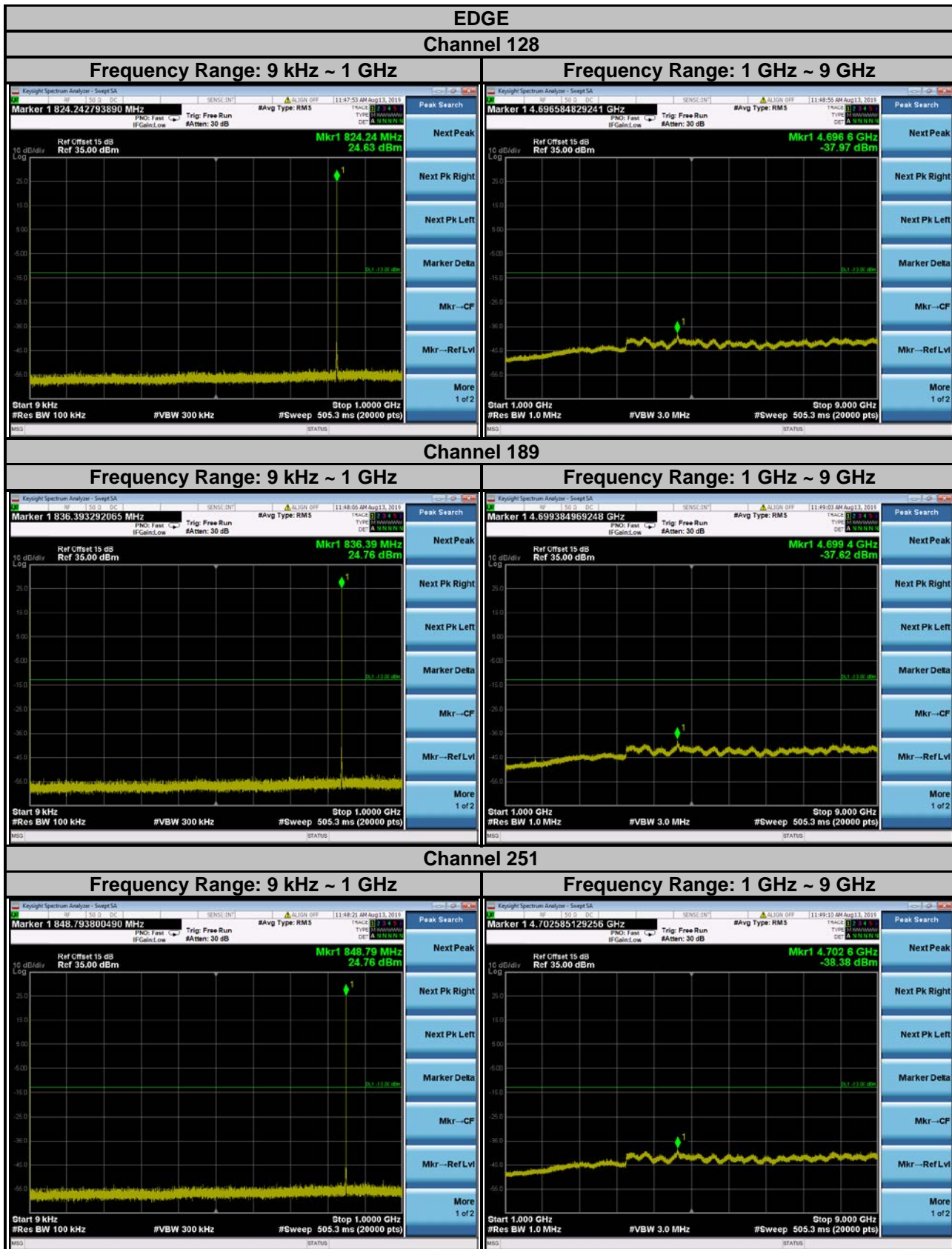

Note: The signal over the limit in 9 kHz is from spectrum analyzer.

WCDMA Channel 4132

Frequency Range: 9 kHz ~ 1 GHz

Frequency Range: 1 GHz ~ 9 GHz

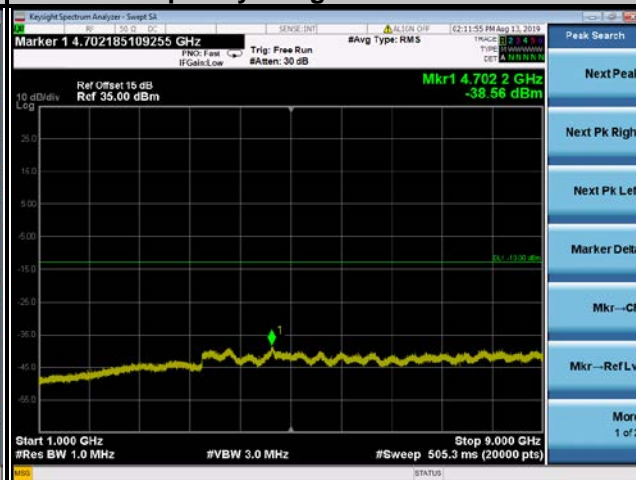
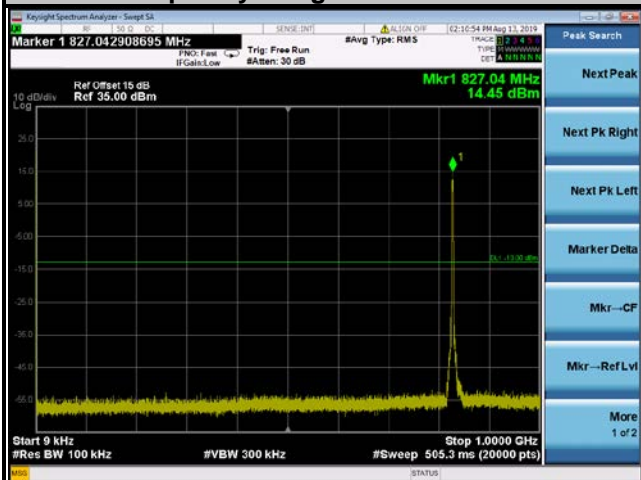

Channel 4182

Frequency Range: 9 kHz ~ 1 GHz

Frequency Range: 1 GHz ~ 9 GHz

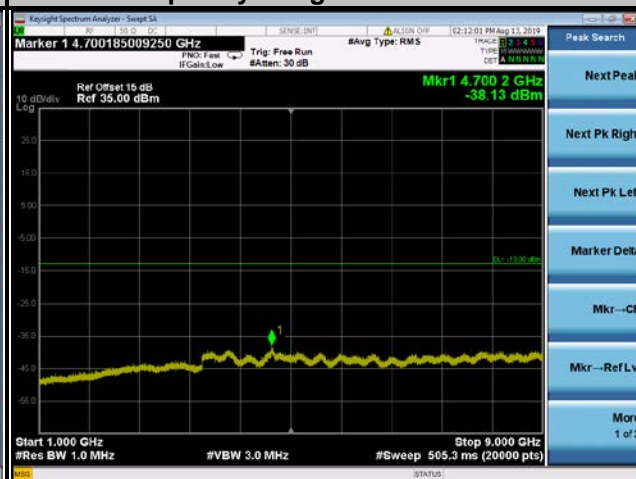
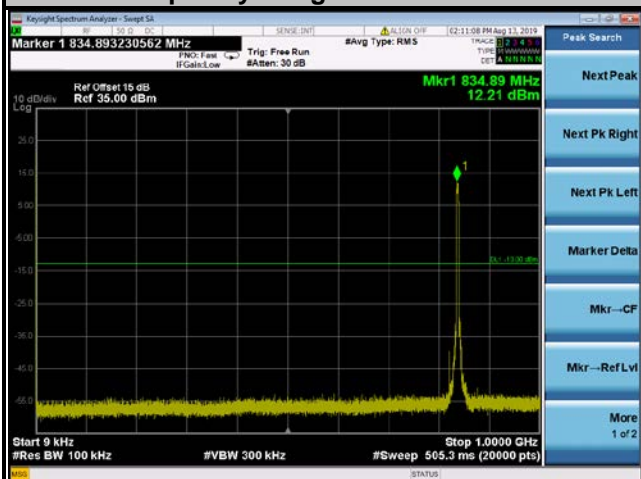

Channel 4233

Frequency Range: 9 kHz ~ 1 GHz

Frequency Range: 1 GHz ~ 9 GHz

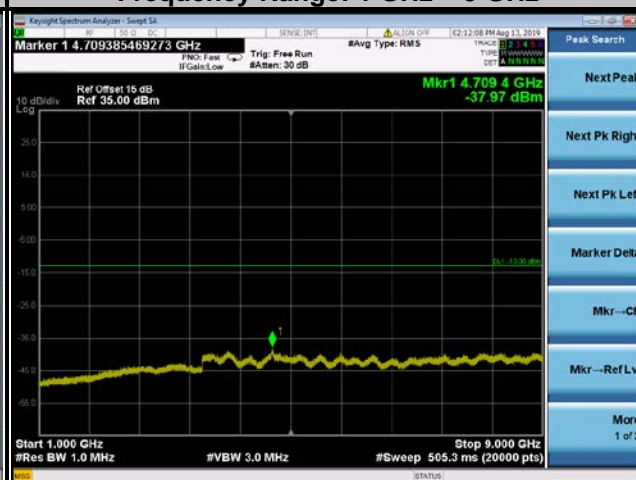
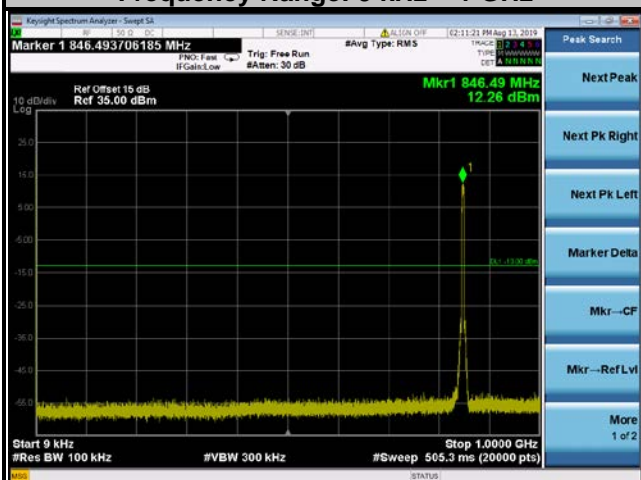

Note: The signal over the limit in 9 kHz is from spectrum analyzer.

LTE Band 5
Channel Bandwidth: 1.4 MHz
Channel 20407

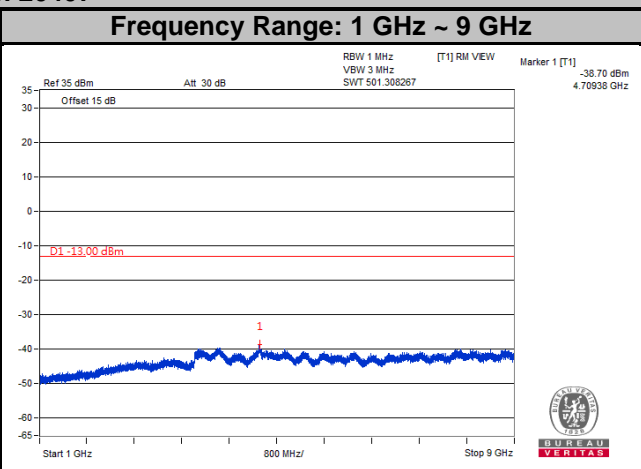
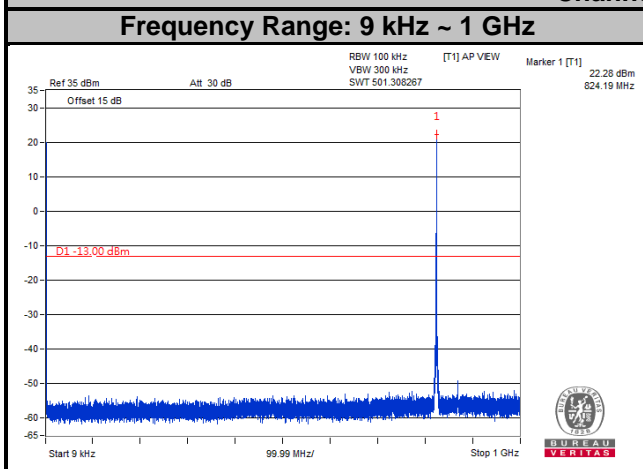

Channel 20525

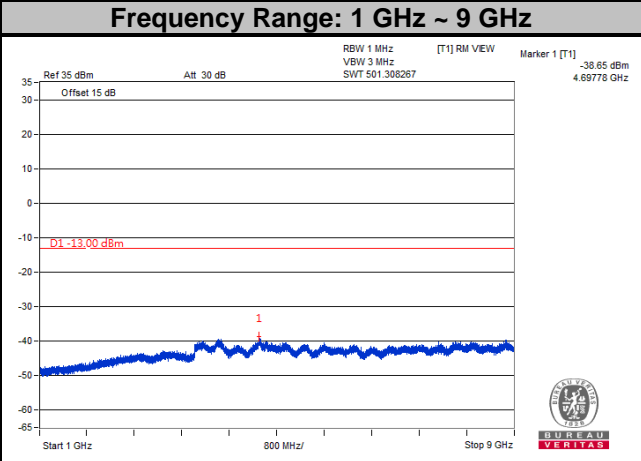
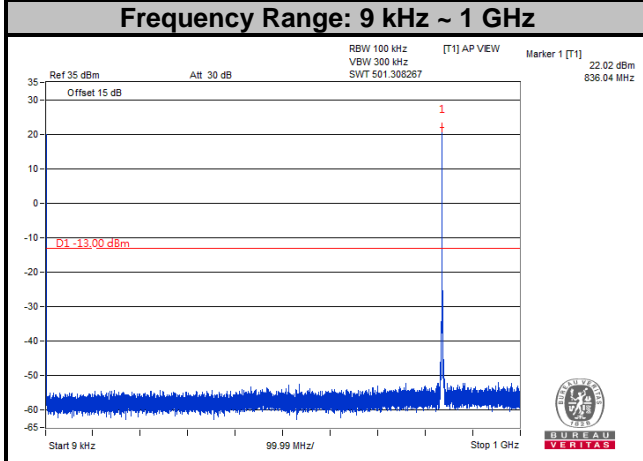

Channel 20643

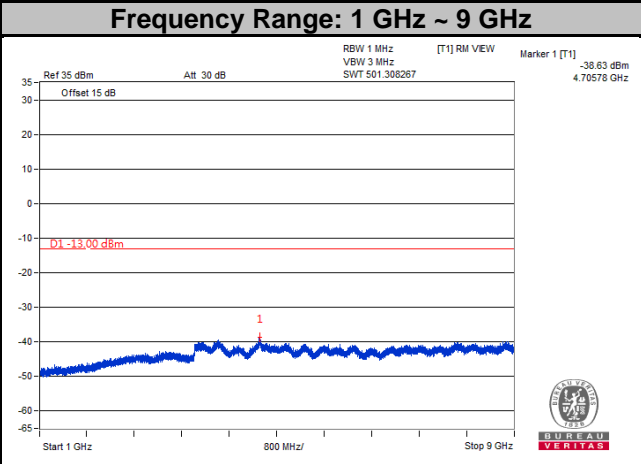
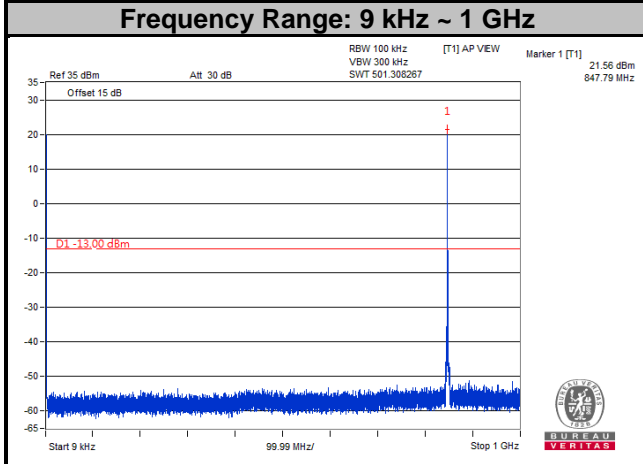

Note: The signal over the limit in 9 kHz is from spectrum analyzer.

LTE Band 5
Channel Bandwidth: 3 MHz
Channel 20415

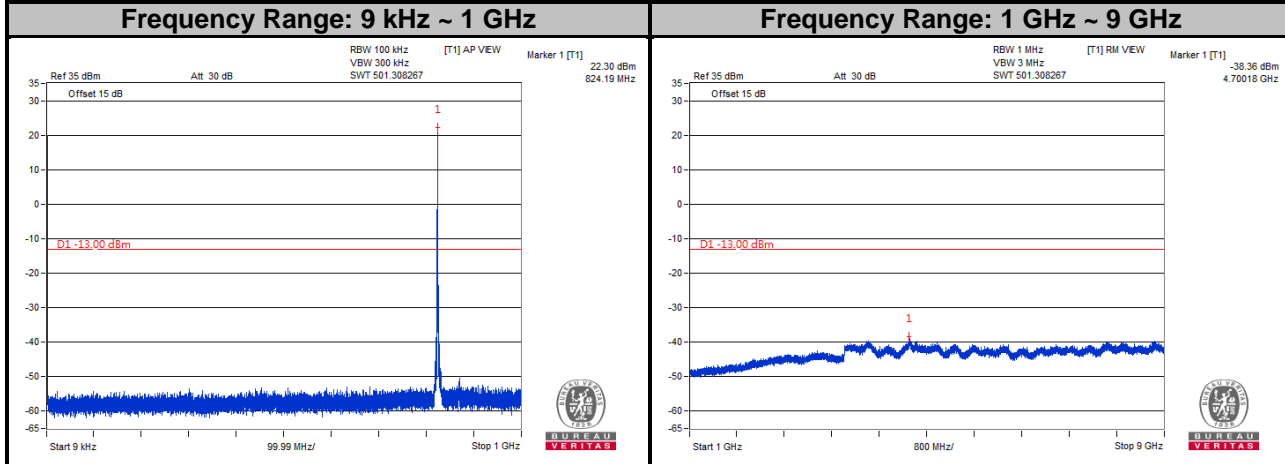

Channel 20525

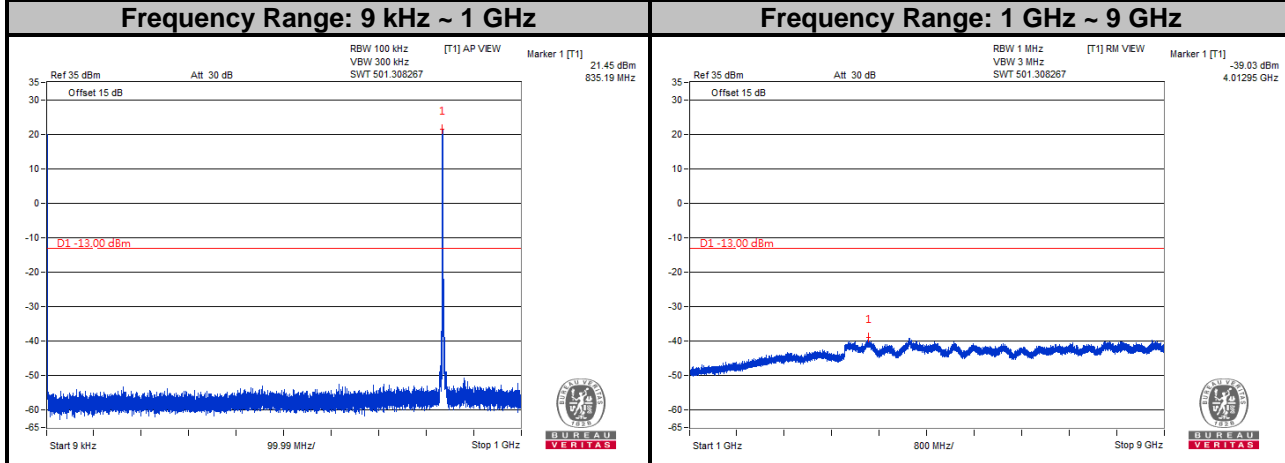

Channel 20635

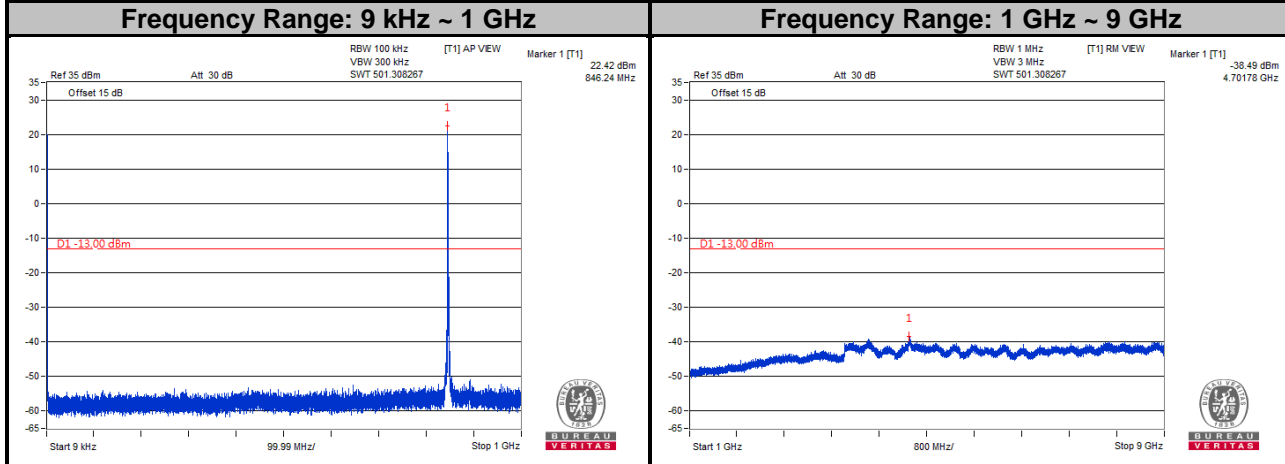

Note: The signal over the limit in 9 kHz is from spectrum analyzer.

LTE Band 5
Channel Bandwidth: 5 MHz
Channel 20425

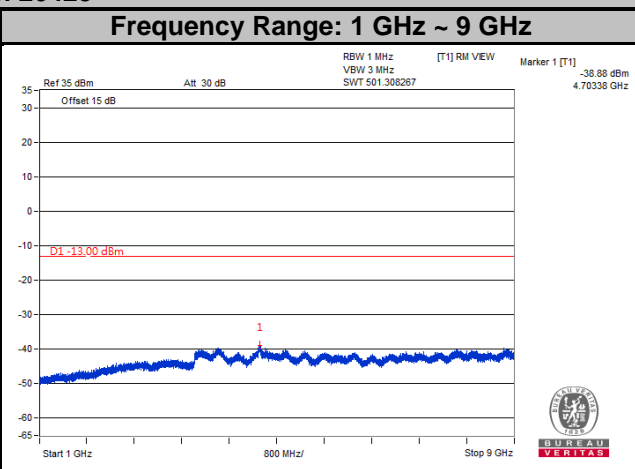
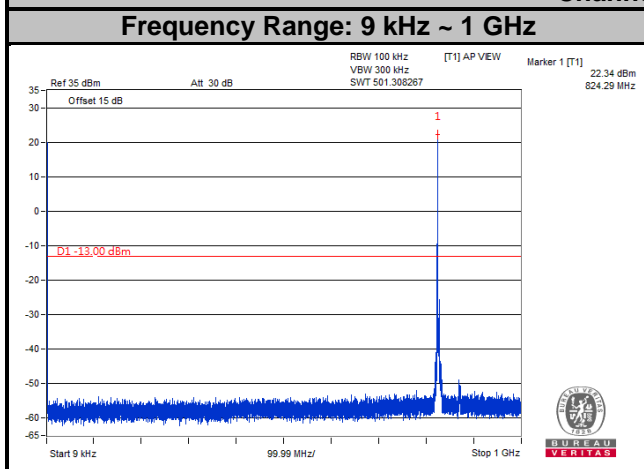

Channel 20525

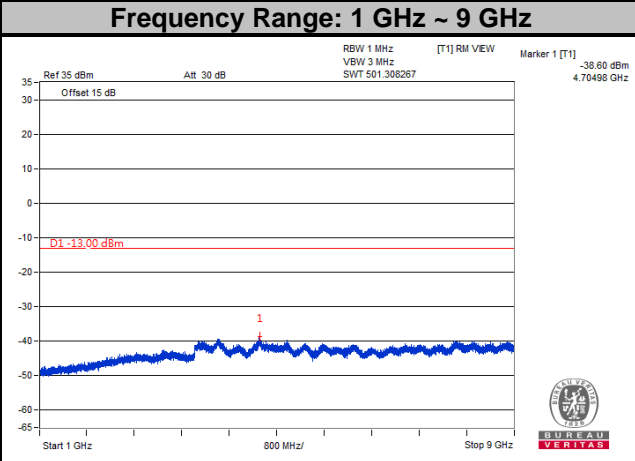
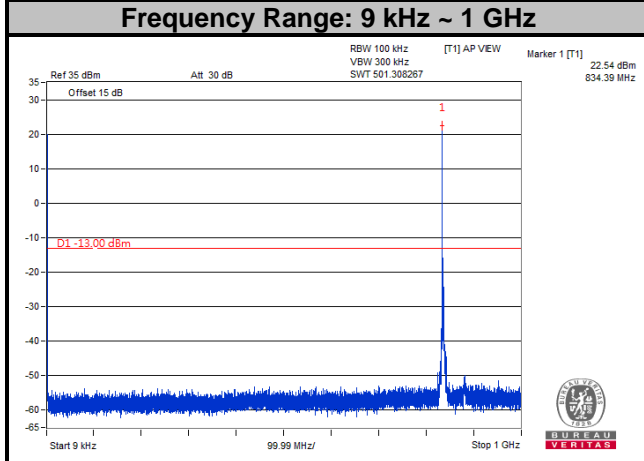

Channel 20625

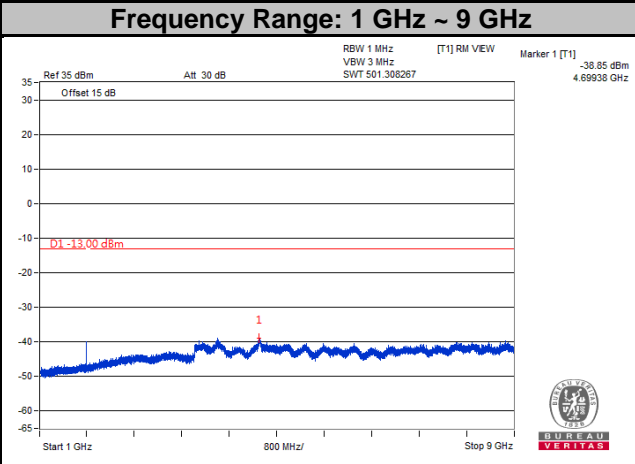
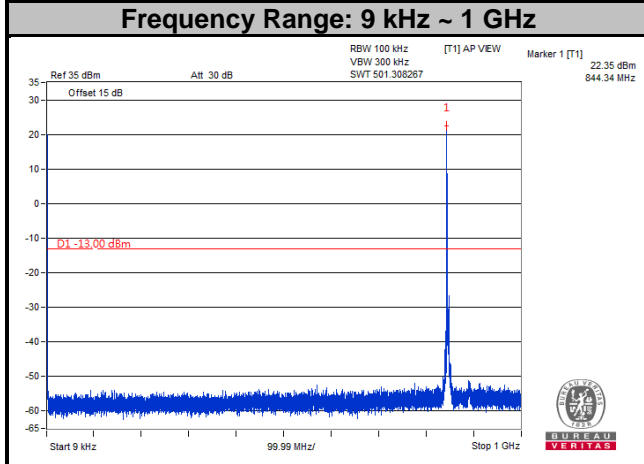

Note: The signal over the limit in 9 kHz is from spectrum analyzer.

LTE Band 5
Channel Bandwidth: 10 MHz
Channel 20450

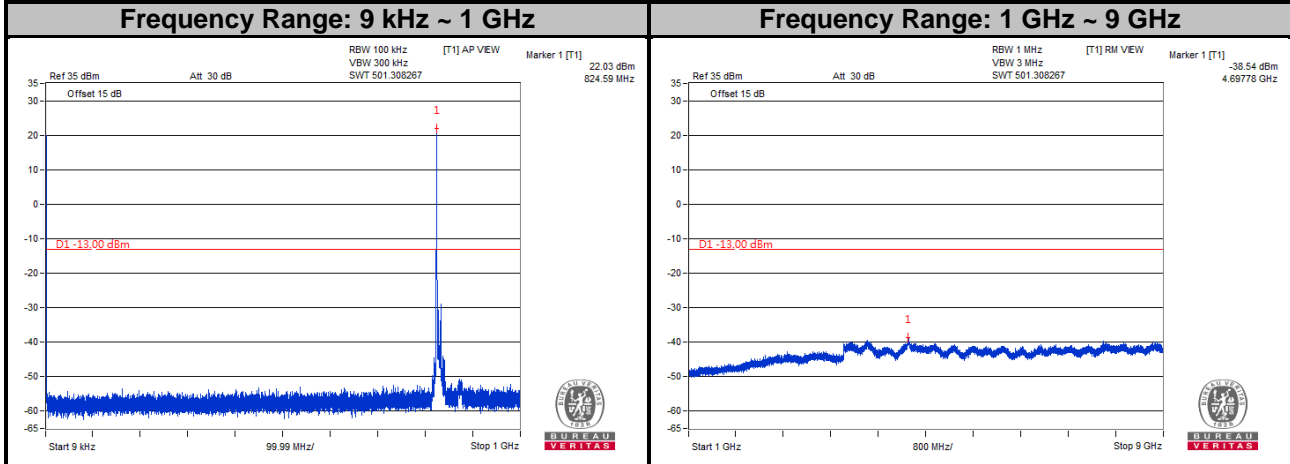

Channel 20525

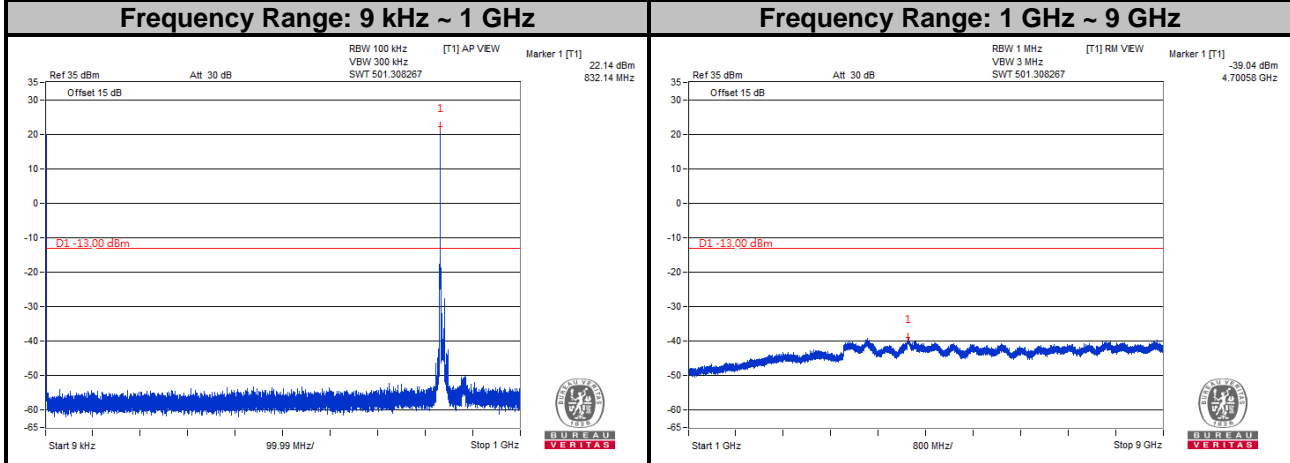

Channel 20600

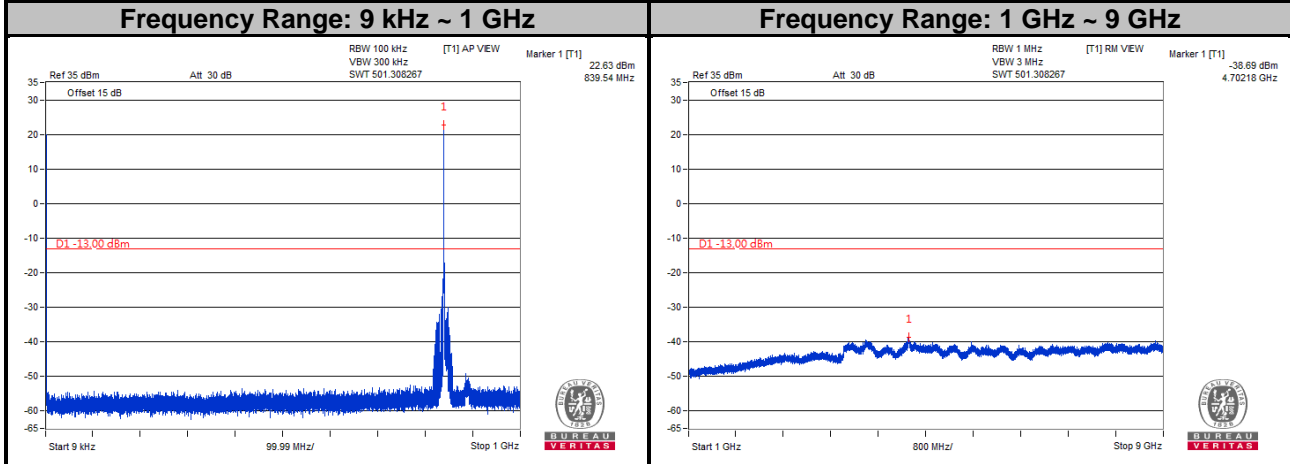

Note: The signal over the limit in 9 kHz is from spectrum analyzer.

4.8 Radiated Emission Measurement

4.8.1 Limits of Radiated Emission Measurement

The power of any emission outside of the authorized operating frequency ranges must be attenuated below the transmitting power (P) by a factor of at least $43 + 10 \log(P)$ dB. The emission limit is equal to -13 dBm.

4.8.2 Test Procedure

- a. Substitution method is used for E.I.R.P measurement. In the semi-anechoic chamber, EUT placed on the 0.8 m (below or equal 1 GHz) and/or 1.5 m (above 1 GHz) height of Turn Table, rotated the table around 360 degrees to search the maximum radiation power and receiver antenna shall be rotated vertical and horizontal polarization and moved height from 1 m to 4 m to find the maximum polar radiated power. The "Read Value" is the spectrum reading the maximum power value.
- b. The substitution horn antenna is substituted for EUT at the same position and signals generator export the CW signal to the substitution antenna via a TX cable. Rotated the Turn Table and moved receiving antenna to find the maximum radiation power. Adjust output power level of S.G to get a Value of spectrum reading equal to "Read Value" of step a. Record the power level of S.G
- c. EIRP = Output power level of S.G – TX cable loss + Antenna gain of substitution horn.
- d. E.R.P power can be calculated form E.I.R.P power by subtracting the gain of dipole, E.R.P power = E.I.R.P power - 2.15 dB.

NOTE: The resolution bandwidth and video bandwidth of test receiver/spectrum analyzer is 1 MHz/3 MHz.

4.8.3 Deviation from Test Standard

No deviation.

4.8.4 Test Setup

<Radiated Emission below or equal 1 GHz>

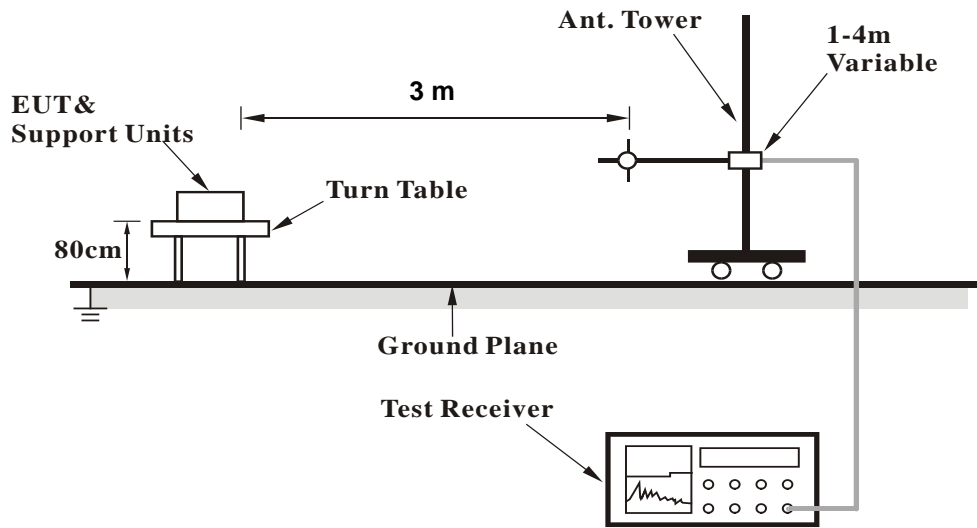

<Radiated Emission above 1 GHz>

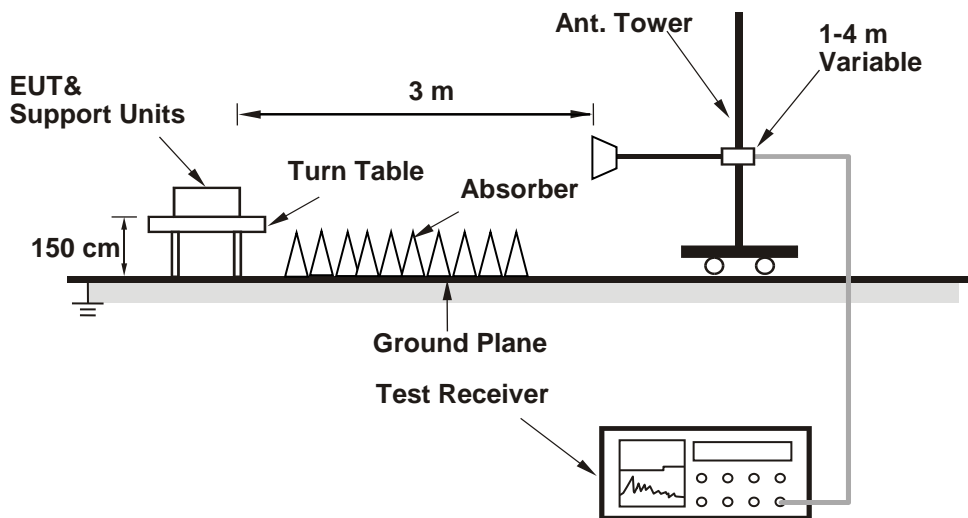

For the actual test configuration, please refer to the attached file (Test Setup Photo).

4.8.5 Test Results

GSM:
Low Channel



Bureau Veritas Consumer Products Services Ltd., Taoyuan Branch

A D T

Data: 3

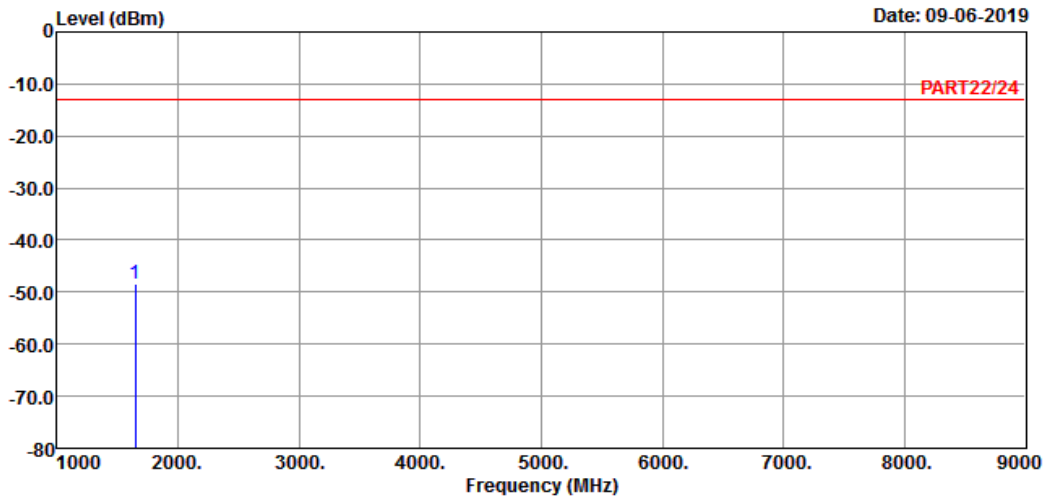

Site : 966 Chamber 5
Condition: PART22/24 HORIZONTAL
Remak : GSM 850 Link_L-CH
Tested by: Thomas Wei

Freq	Level	Read Level	Limit	Line Factor	Over Limit	Remark
MHz	dBm	dBm	dBm	dB	dB	
1 pp 1648.40	-48.45	-34.71	-13.00	-13.74	-35.45	Peak



Bureau Veritas Consumer Products Services Ltd., Taoyuan Branch

A D T

Data: 4

Date: 09-06-2019

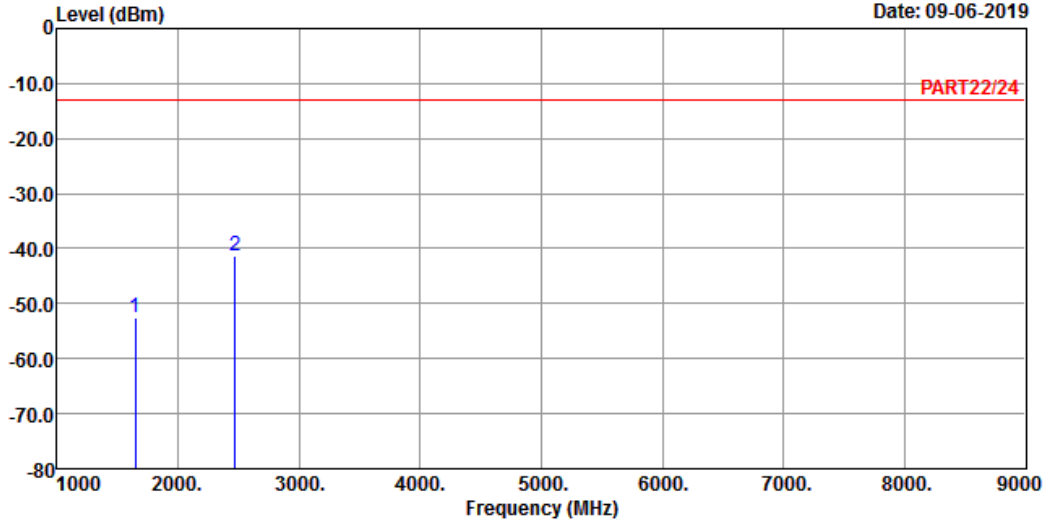

Site : 966 Chamber 5
 Condition: PART22/24 VERTICAL
 Remak : GSM 850 Link_L-CH
 Tested by: Thomas Wei

	Freq	Level	Read Level	Limit	Line Factor	Over Limit	Remark
	MHz	dBm	dBm	dBm	dB	dB	
1	1648.40	-52.57	-38.83	-13.00	-13.74	-39.57	Peak
2	2472.60	-41.46	-31.44	-13.00	-10.02	-28.46	Peak

Middle Channel



Bureau Veritas Consumer Products Services Ltd., Taoyuan Branch

A D T

Data: 3

Date: 08-14-2019

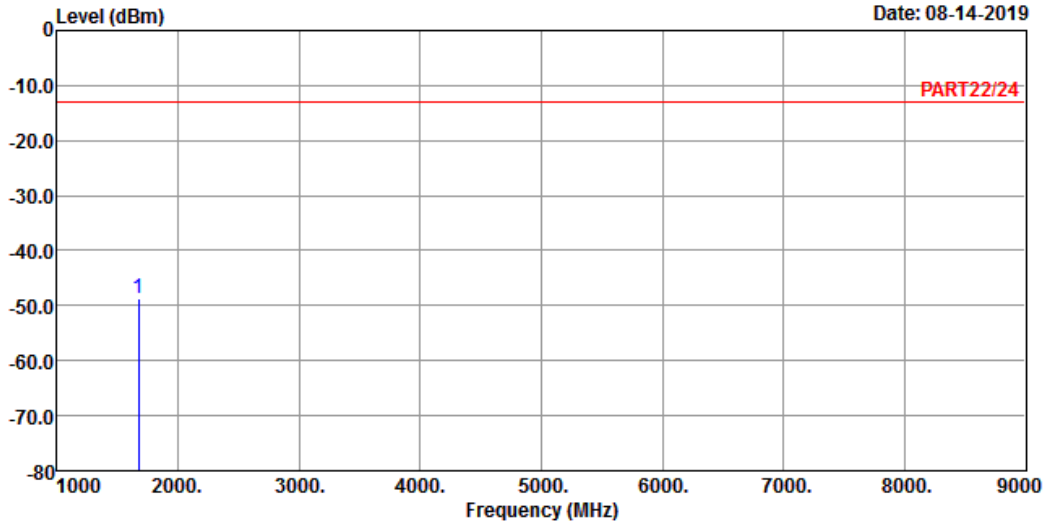

Site : 966 Chamber 5
 Condition: PART22/24 HORIZONTAL
 Remak : GSM 850 Link_M-CH
 Tested by: Thomas Wei

Freq	Level	Read Level	Limit	Line Factor	Over Limit	Remark
MHz	dBm	dBm	dBm	dB	dB	

1 pp 1672.80 -48.62 -34.72 -13.00 -13.90 -35.62 Peak



Bureau Veritas Consumer Products Services Ltd., Taoyuan Branch

A D T

Data: 4

Date: 08-14-2019

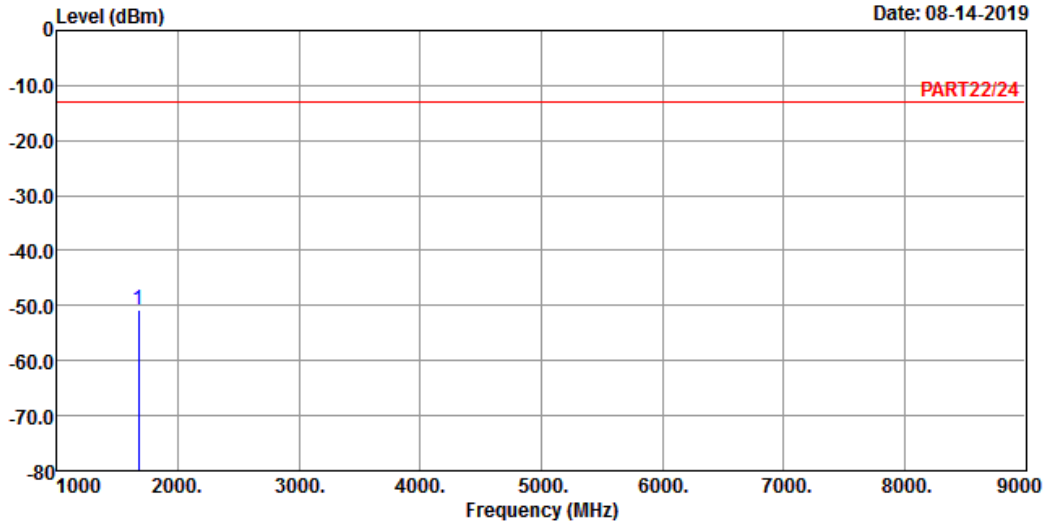

Site : 966 Chamber 5
 Condition: PART22/24 VERTICAL
 Remak : GSM 850 Link_M-CH
 Tested by: Thomas Wei

Freq	Level	Read Level	Limit	Line Factor	Over Limit	Remark
MHz	dBm	dBm	dBm	dB	dB	
1 pp 1672.80	-50.85	-36.95	-13.00	-13.90	-37.85	Peak

High Channel



Bureau Veritas Consumer Products Services Ltd., Taoyuan Branch

A D T

Data: 3

Date: 09-06-2019

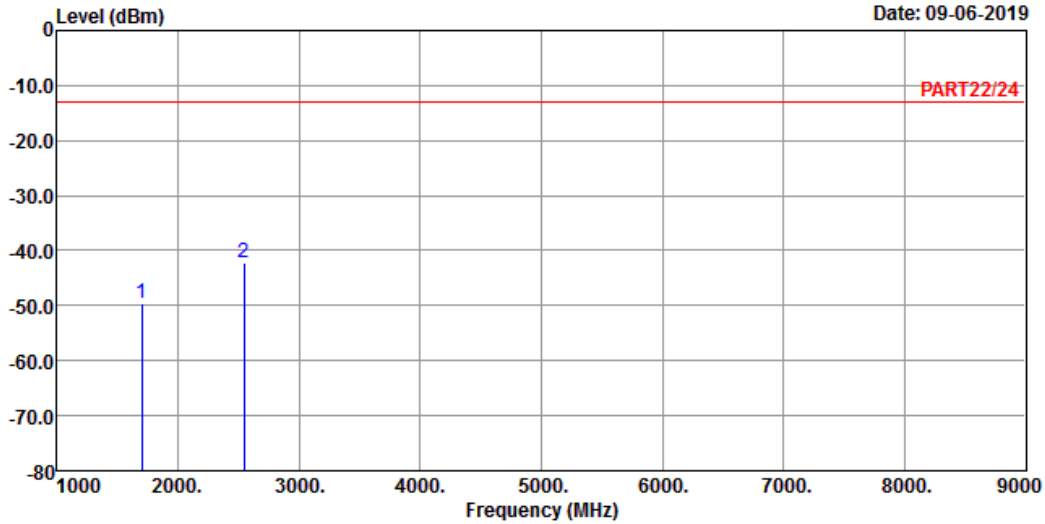

Site : 966 Chamber 5
 Condition: PART22/24 HORIZONTAL
 Remak : GSM 850 Link_H-CH
 Tested by: Thomas Wei

	Freq	Level	Read Level	Limit	Line Factor	Over Limit	Remark
	MHz	dBm	dBm	dBm	dB	dB	
1	1697.60	-49.62	-35.57	-13.00	-14.05	-36.62	Peak
2 pp	2546.40	-42.31	-32.25	-13.00	-10.06	-29.31	Peak



Bureau Veritas Consumer Products Services Ltd., Taoyuan Branch

A D T

Data: 4

Date: 09-06-2019

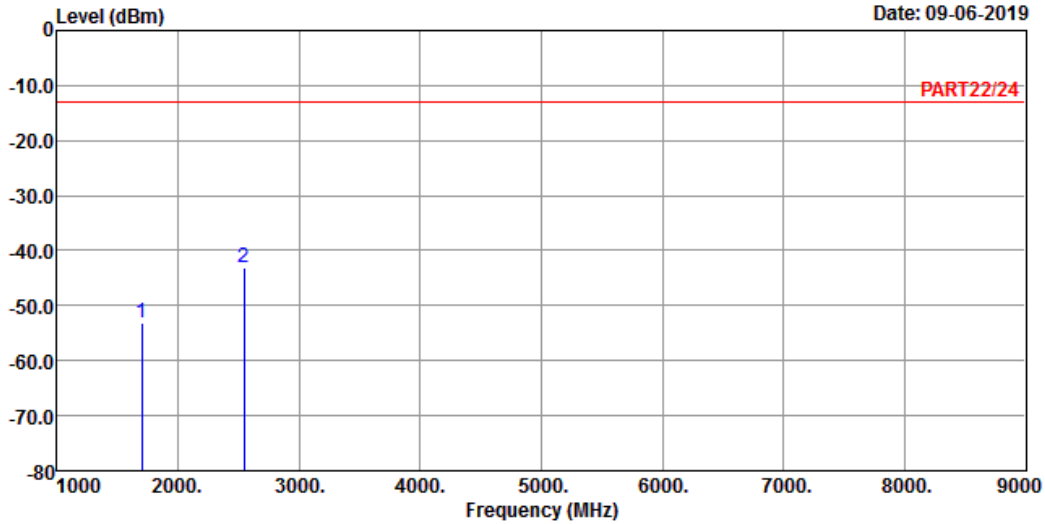

Site : 966 Chamber 5
 Condition: PART22/24 VERTICAL
 Remak : GSM 850 Link_H-CH
 Tested by: Thomas Wei

	Freq	Level	Read Level	Limit	Line Factor	Over Limit	Remark
	MHz	dBm	dBm	dBm	dB	dB	
1	1697.60	-53.18	-39.13	-13.00	-14.05	-40.18	Peak
2	2546.40	-43.14	-33.08	-13.00	-10.06	-30.14	Peak

EDGE:
Low Channel



Bureau Veritas Consumer Products Services Ltd., Taoyuan Branch

A D T

Data: 3

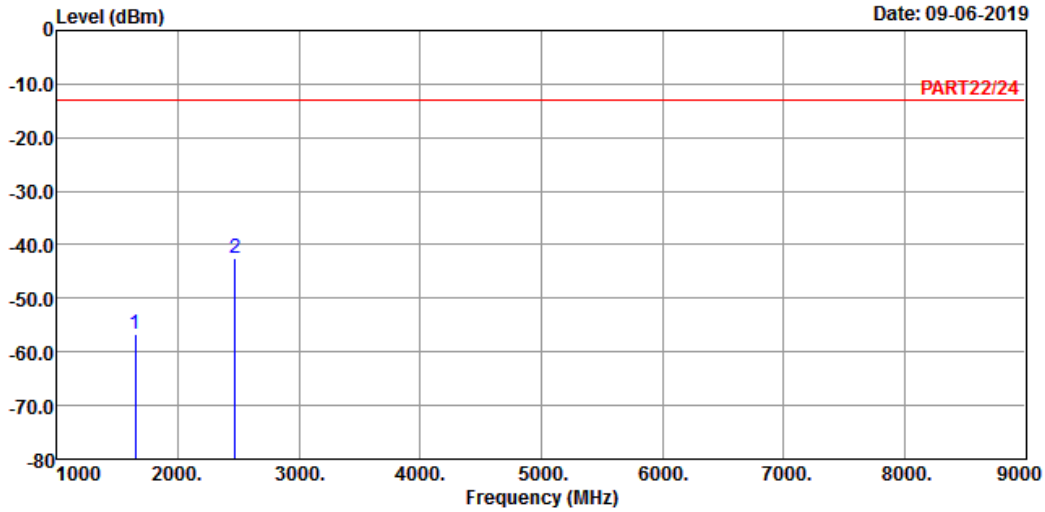

Site : 966 Chamber 5
Condition: PART22/24 HORIZONTAL
Remark : EDGE 850 Link_L-CH
Tested by: Thomas Wei

	Freq	Level	Read Level	Limit	Line Factor	Over Limit	Remark
	MHz	dBm	dBm	dBm	dB	dB	
1	1648.40	-56.65	-42.91	-13.00	-13.74	-43.65	Peak
2 pp	2472.60	-42.57	-32.55	-13.00	-10.02	-29.57	Peak



Bureau Veritas Consumer Products Services Ltd., Taoyuan Branch

A D T

Data: 4

Date: 09-06-2019

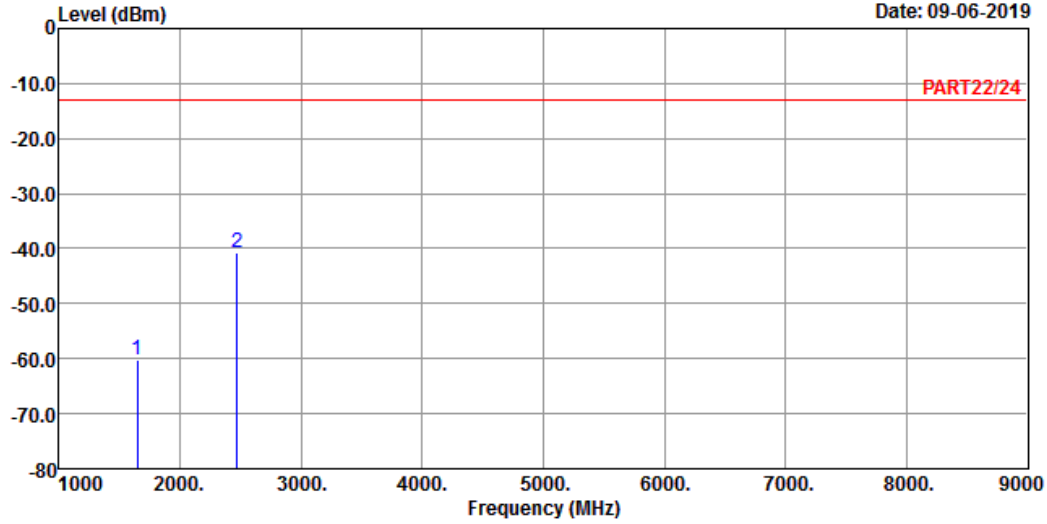

Site : 966 Chamber 5
 Condition: PART22/24 VERTICAL
 Remark : EDGE 850 Link_L-CH
 Tested by: Thomas Wei

	Freq	Level	Read Level	Limit	Line Factor	Over Limit	Remark
	MHz	dBm	dBm	dBm	dB	dB	
1	1648.40	-60.08	-46.34	-13.00	-13.74	-47.08	Peak
2 pp	2472.60	-40.82	-30.80	-13.00	-10.02	-27.82	Peak

Middle Channel



Bureau Veritas Consumer Products Services Ltd., Taoyuan Branch

A D T

Data: 3

Date: 08-14-2019

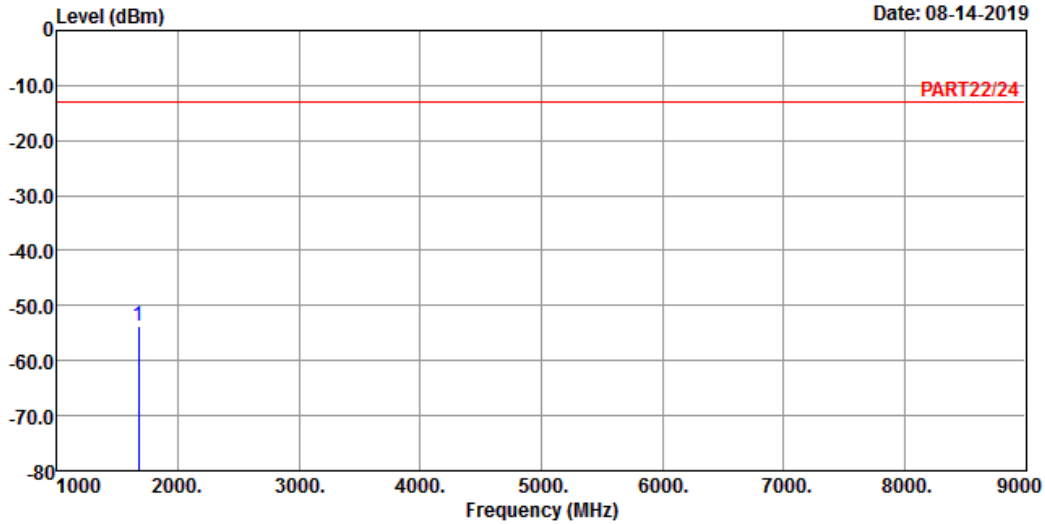

Site : 966 Chamber 5
 Condition: PART22/24 HORIZONTAL
 Remark : EDGE 850 Link_M-CH
 Tested by: Thomas Wei

Freq	Level	Read Level	Limit	Line Factor	Over Limit	Remark
MHz	dBm	dBm	dBm	dB	dB	

1 pp 1672.80 -53.66 -39.76 -13.00 -13.90 -40.66 Peak



Bureau Veritas Consumer Products Services Ltd., Taoyuan Branch

A D T

Data: 4

Date: 08-14-2019

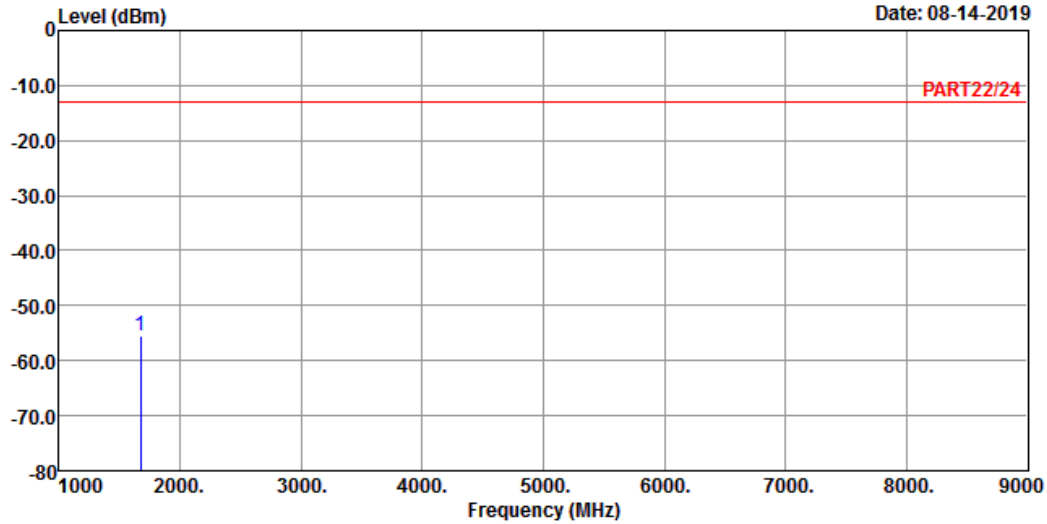

Site : 966 Chamber 5
 Condition: PART22/24 VERTICAL
 Remark : EDGE 850 Link_M-CH
 Tested by: Thomas Wei

Freq	Level	Read Level	Limit	Line Factor	Over Limit	Remark
MHz	dBm	dBm	dBm	dB	dB	
1 pp 1672.80	-55.43	-41.53	-13.00	-13.90	-42.43	Peak

High Channel



Bureau Veritas Consumer Products Services Ltd., Taoyuan Branch

A D T

Data: 5

Date: 09-06-2019

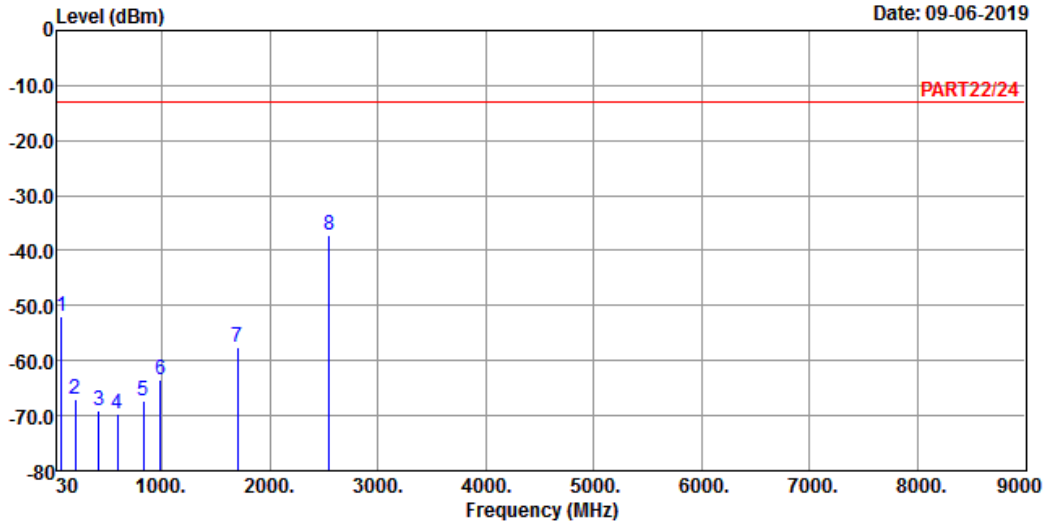

Site : 966 Chamber 5
 Condition: PART22/24 HORIZONTAL
 Remark : EDGE 850 Link_H-CH
 Tested by: Thomas Wei

	Freq	Level	Read Level	Limit	Line Factor	Over Limit	Remark
	MHz	dBm	dBm	dBm	dB	dB	
1	72.68	-51.90	-42.83	-13.00	-9.07	-38.90	Peak
2	198.78	-67.06	-59.13	-13.00	-7.93	-54.06	Peak
3	413.15	-69.05	-63.21	-13.00	-5.84	-56.05	Peak
4	589.69	-69.78	-68.58	-13.00	-1.20	-56.78	Peak
5	830.25	-67.26	-67.73	-13.00	0.47	-54.26	Peak
6	983.51	-63.48	-66.48	-13.00	3.00	-50.48	Peak
7	1697.60	-57.53	-43.48	-13.00	-14.05	-44.53	Peak
8 pp	2546.40	-37.14	-27.08	-13.00	-10.06	-24.14	Peak



Bureau Veritas Consumer Products Services Ltd., Taoyuan Branch

A D T

Data: 6

Date: 09-06-2019

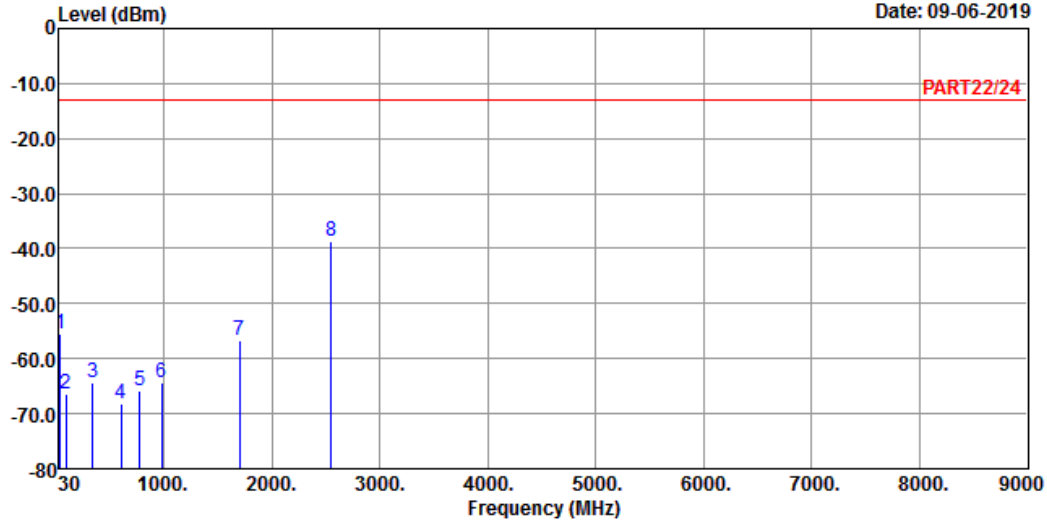

Site : 966 Chamber 5
 Condition: PART22/24 VERTICAL
 Remark : EDGE 850 Link_H-CH
 Tested by: Thomas Wei

	Freq	Level	Read Level	Limit Line	Over Factor	Over Limit	Remark
	MHz	dBm	dBm	dBm	dB	dB	
1	40.67	-55.40	-55.52	-13.00	0.12	-42.40	Peak
2	94.02	-66.55	-55.66	-13.00	-10.89	-53.55	Peak
3	339.43	-64.48	-58.08	-13.00	-6.40	-51.48	Peak
4	603.27	-68.20	-67.44	-13.00	-0.76	-55.20	Peak
5	776.90	-65.69	-66.49	-13.00	0.80	-52.69	Peak
6	980.60	-64.28	-67.17	-13.00	2.89	-51.28	Peak
7	1697.60	-56.67	-42.62	-13.00	-14.05	-43.67	Peak
8 pp	2546.40	-38.55	-28.49	-13.00	-10.06	-25.55	Peak

WCDMA:
Low Channel



Bureau Veritas Consumer Products Services Ltd., Taoyuan Branch

A D T

Data: 3

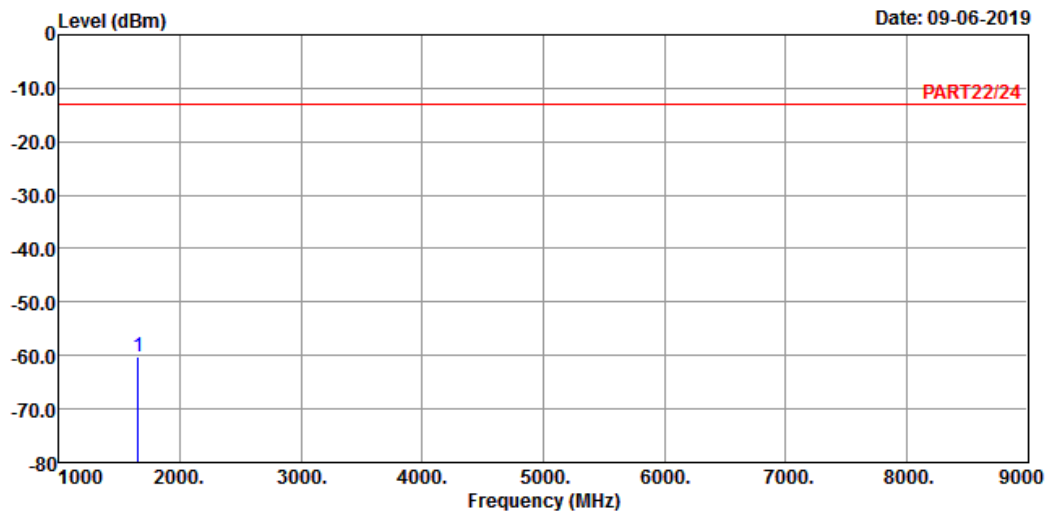

Site : 966 Chamber 5
 Condition: PART22/24 HORIZONTAL
 Remark : WCDMA Band V Link_L-CH
 Tested by: Thomas Wei

Freq	Level	Read Level	Limit	Over	Remark
MHz	dBm	dBm	dBm	dB	
1 pp 1652.80	-60.13	-46.36	-13.00	-13.77	-47.13 Peak



Bureau Veritas Consumer Products Services Ltd., Taoyuan Branch

A D T

Data: 4

Date: 09-06-2019

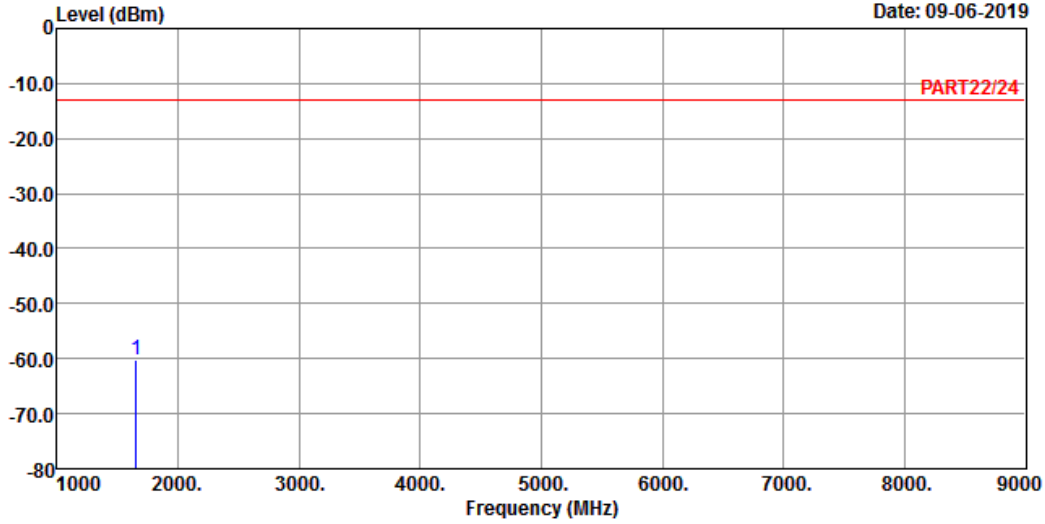

Site : 966 Chamber 5
 Condition: PART22/24 VERTICAL
 Remark : WCDMA Band V Link_L-CH
 Tested by: Thomas Wei

Freq	Level	Read Level	Limit	Line Factor	Over Limit	Remark
MHz	dBm	dBm	dBm	dB	dB	
1 pp 1652.80	-60.22	-46.45	-13.00	-13.77	-47.22	Peak

Middle Channel



Bureau Veritas Consumer Products Services Ltd., Taoyuan Branch

A D T

Data: 3

Date: 08-15-2019

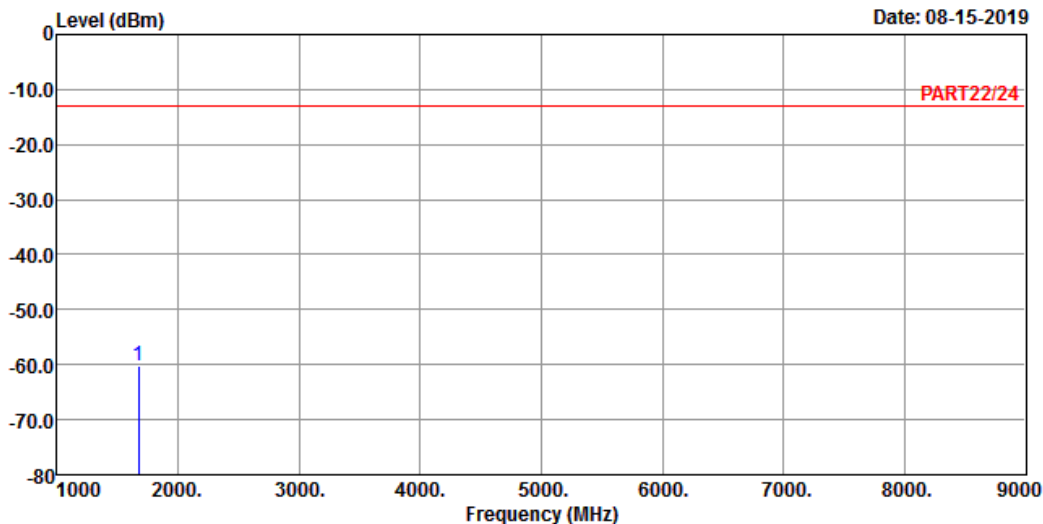

Site : 966 Chamber 5
 Condition: PART22/24 HORIZONTAL
 Remak : WCDMA Band 5 Link_M-CH
 Tested by: Thomas Wei

Freq	Level	Read Level	Limit	Line Factor	Over Limit	Remark
MHz	dBm	dBm	dBm	dB	dB	

1 pp 1672.80 -60.16 -46.26 -13.00 -13.90 -47.16 Peak



Bureau Veritas Consumer Products Services Ltd., Taoyuan Branch

A D T

Data: 4

Date: 08-15-2019

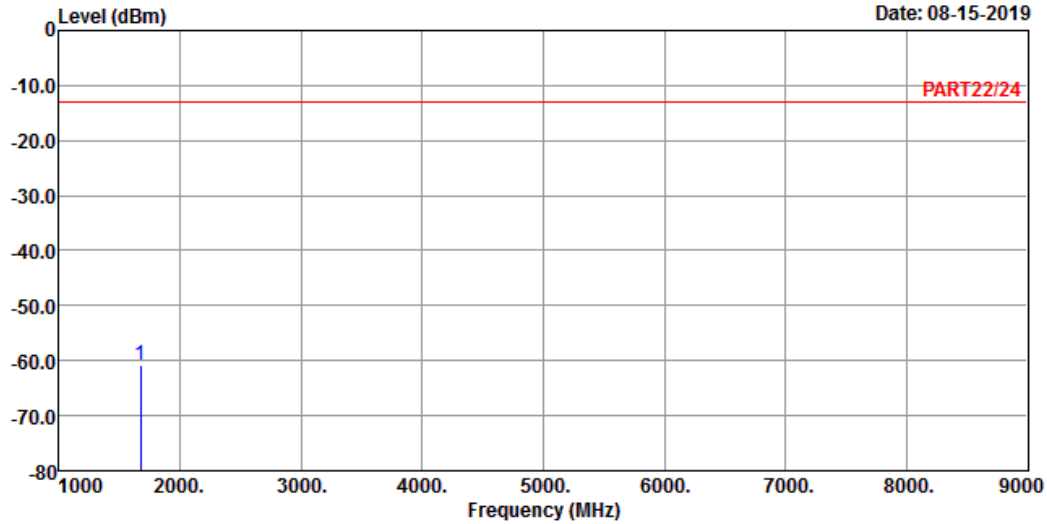

Site : 966 Chamber 5
 Condition: PART22/24 VERTICAL
 Remak : WCDMA Band 5 Link_M-CH
 Tested by: Thomas Wei

Freq	Level	Read Level	Limit	Line Factor	Over Limit	Remark
MHz	dBm	dBm	dBm	dB	dB	
1 pp 1672.80	-60.78	-46.88	-13.00	-13.90	-47.78	Peak

High Channel



Bureau Veritas Consumer Products Services Ltd., Taoyuan Branch

A D T

Data: 3

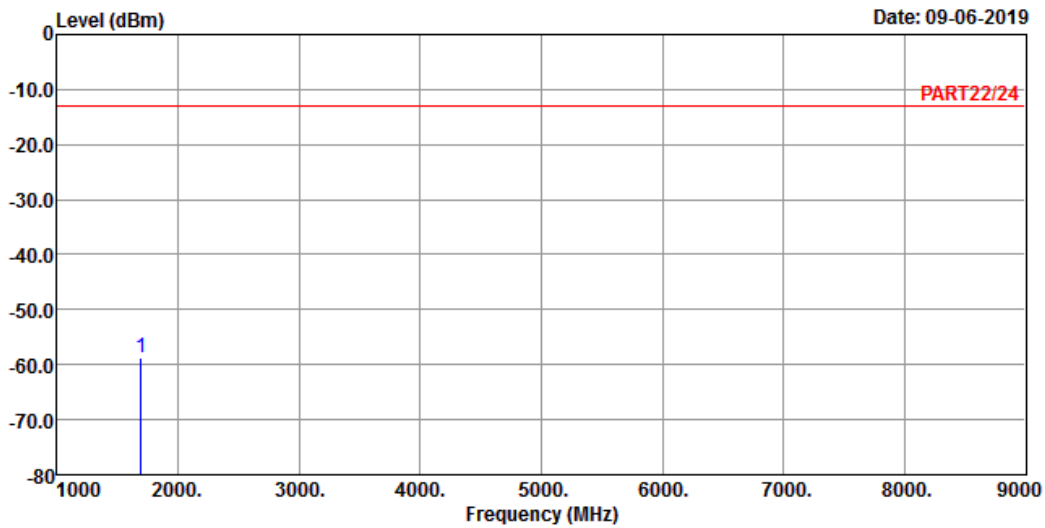

Site : 966 Chamber 5
 Condition: PART22/24 HORIZONTAL
 Remark : WCDMA Band V Link_H-CH
 Tested by: Thomas Wei

Freq	Level	Read Level	Limit	Line Factor	Over Limit	Remark
MHz	dBm	dBm	dBm	dB	dB	

1 pp 1693.20 -58.72 -44.70 -13.00 -14.02 -45.72 Peak



Bureau Veritas Consumer Products Services Ltd., Taoyuan Branch

A D T

Data: 4

Date: 09-06-2019

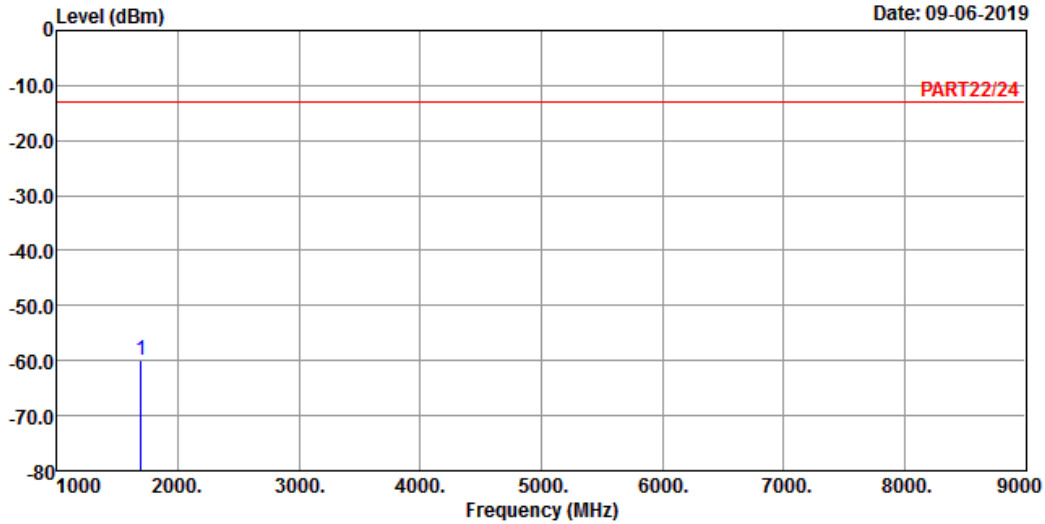

Site : 966 Chamber 5
 Condition: PART22/24 VERTICAL
 Remark : WCDMA Band V Link_H-CH
 Tested by: Thomas Wei

Freq	Level	Read Level	Limit	Line Factor	Over Limit	Remark
MHz	dBm	dBm	dBm	dB	dB	
1 pp 1693.20	-60.00	-45.98	-13.00	-14.02	-47.00	Peak

LTE Band 5
 Channel Bandwidth: 1.4 MHz / QPSK
 Low Channel



Bureau Veritas Consumer Products Services Ltd., Taoyuan Branch

A D T

Data: 3

Date: 09-06-2019

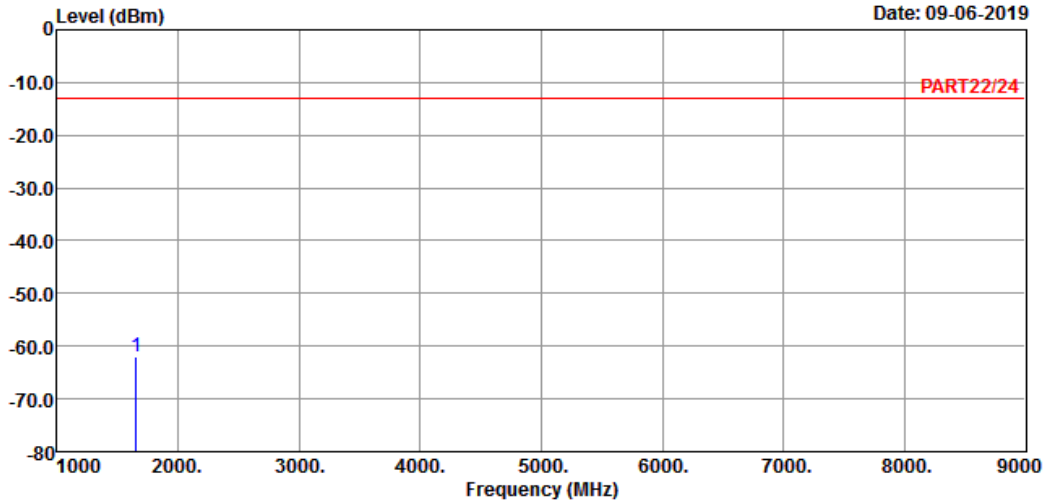

Site : 966 Chamber 5
 Condition: PART22/24 HORIZONTAL
 Remak : LTE Band 5 QPSK_1.4M Link_L-CH
 Tested by: Thomas Wei

Freq	Level	Read Level	Limit	Line Factor	Over Limit	Remark
MHz	dBm	dBm	dBm	dB	dB	
1 pp 1649.40	-62.04	-48.30	-13.00	-13.74	-49.04	Peak



Bureau Veritas Consumer Products Services Ltd., Taoyuan Branch

A D T

Data: 4

Date: 09-06-2019

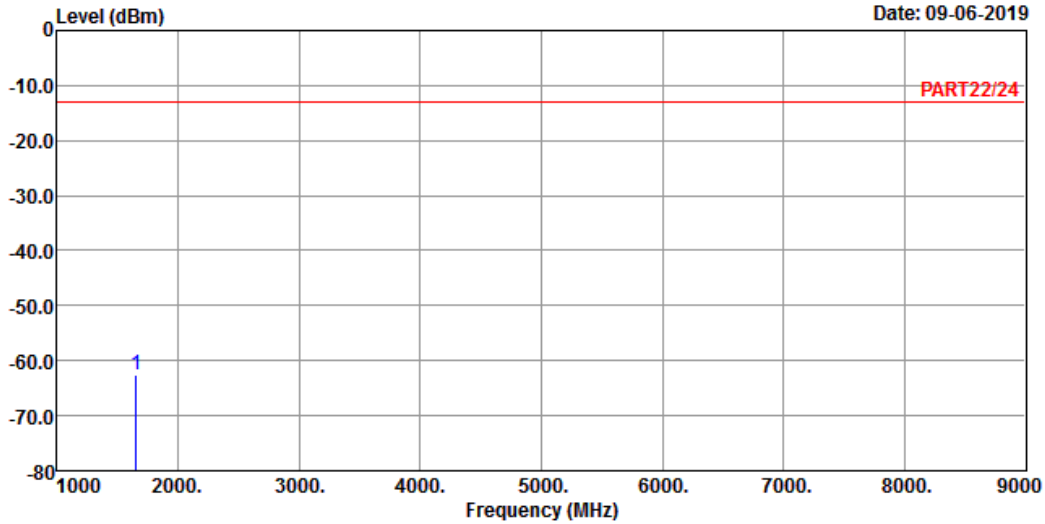

Site : 966 Chamber 5
 Condition: PART22/24 VERTICAL
 Remak : LTE Band 5 QPSK_1.4M Link_L-CH
 Tested by: Thomas Wei

Freq	Level	Read Level	Limit	Line Factor	Over Limit	Remark
MHz	dBm	dBm	dBm	dB	dB	
1 pp 1649.40	-62.45	-48.71	-13.00	-13.74	-49.45	Peak

Middle Channel



Bureau Veritas Consumer Products Services Ltd., Taoyuan Branch

A D T

Data: 3

Date: 09-06-2019

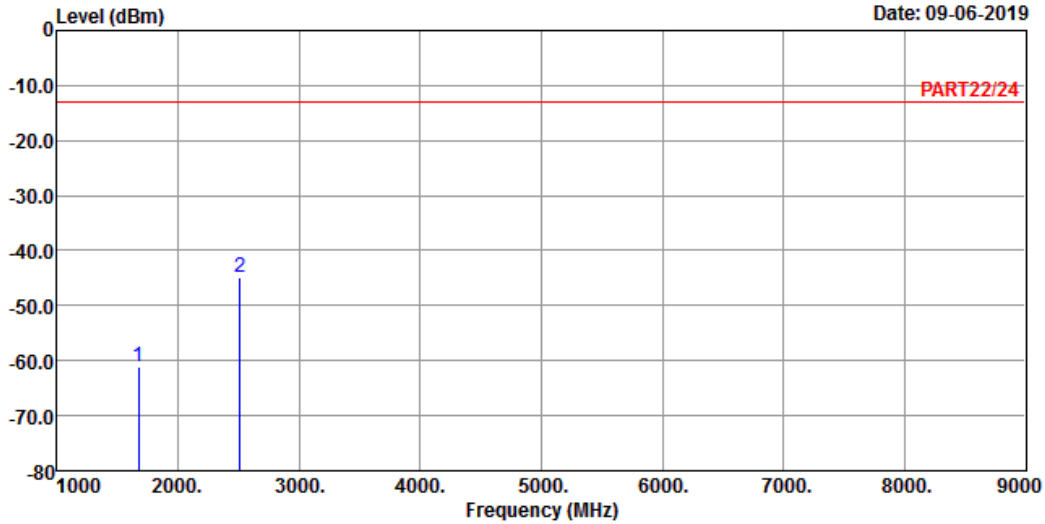

Site : 966 Chamber 5
 Condition: PART22/24 HORIZONTAL
 Remak : LTE Band 5 QPSK_1.4M Link_M-CH
 Tested by: Thomas Wei

	Freq	Level	Read Level	Limit	Line Factor	Over Limit	Remark
	MHz	dBm	dBm	dBm	dB	dB	
1	1673.00	-61.22	-47.32	-13.00	-13.90	-48.22	Peak
2 pp	2509.50	-44.80	-34.72	-13.00	-10.08	-31.80	Peak



Bureau Veritas Consumer Products Services Ltd., Taoyuan Branch

A D T

Data: 4

Date: 09-06-2019

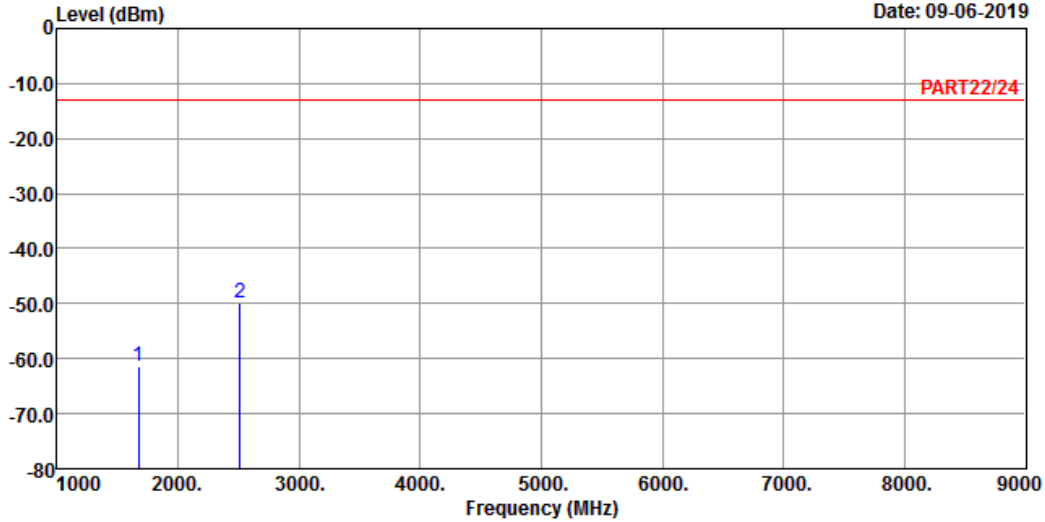

Site : 966 Chamber 5
 Condition: PART22/24 VERTICAL
 Remak : LTE Band 5 QPSK_1.4M Link_M-CH
 Tested by: Thomas Wei

	Freq	Level	Read Level	Limit	Line Factor	Over Limit	Remark
	MHz	dBm	dBm	dBm	dB	dB	
1	1673.00	-61.33	-47.43	-13.00	-13.90	-48.33	Peak
2	2509.50	-49.98	-39.90	-13.00	-10.08	-36.98	Peak

High Channel



Bureau Veritas Consumer Products Services Ltd., Taoyuan Branch

A D T

Data: 3

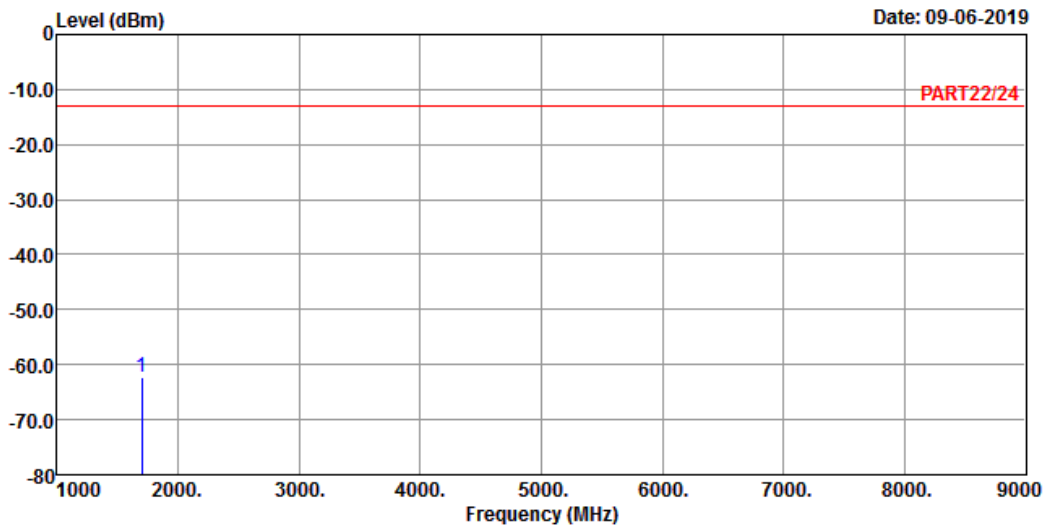

Site : 966 Chamber 5
 Condition: PART22/24 HORIZONTAL
 Remak : LTE Band 5 QPSK_1.4M Link_H-CH
 Tested by: Thomas Wei

Freq	Level	Read Level	Limit	Line Factor	Over Limit	Remark
MHz	dBm	dBm	dBm	dB	dB	

1 pp 1696.60 -62.26 -48.24 -13.00 -14.02 -49.26 Peak



Bureau Veritas Consumer Products Services Ltd., Taoyuan Branch

A D T

Data: 4

Date: 09-06-2019

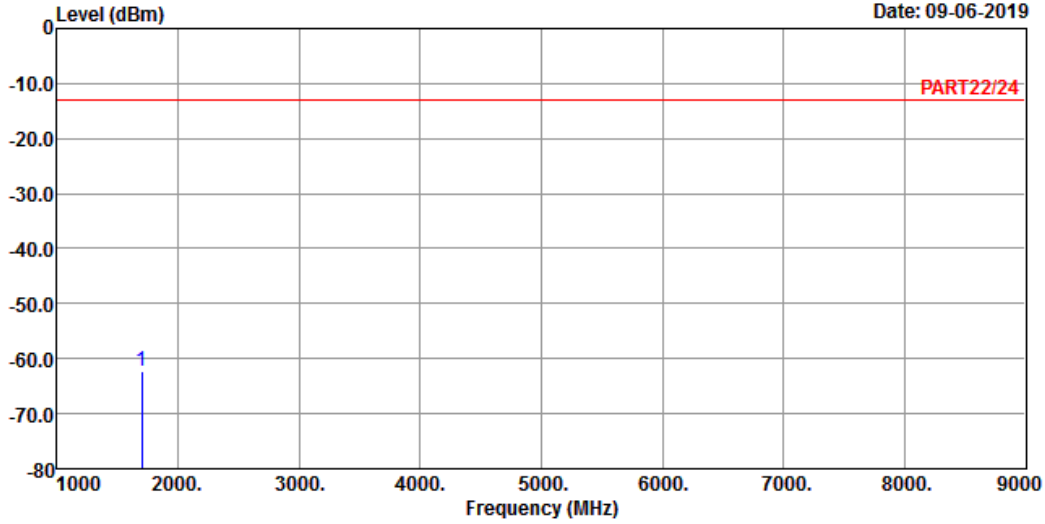

Site : 966 Chamber 5
 Condition: PART22/24 VERTICAL
 Remak : LTE Band 5 QPSK_1.4M Link_H-CH
 Tested by: Thomas Wei

Freq	Level	Read Level	Limit	Line Factor	Over Limit	Remark
MHz	dBm	dBm	dBm	dB	dB	
1 pp 1696.60	-62.34	-48.32	-13.00	-14.02	-49.34	Peak

Channel Bandwidth: 5 MHz / QPSK
 Low Channel



Bureau Veritas Consumer Products Services Ltd., Taoyuan Branch

A D T

Data: 3

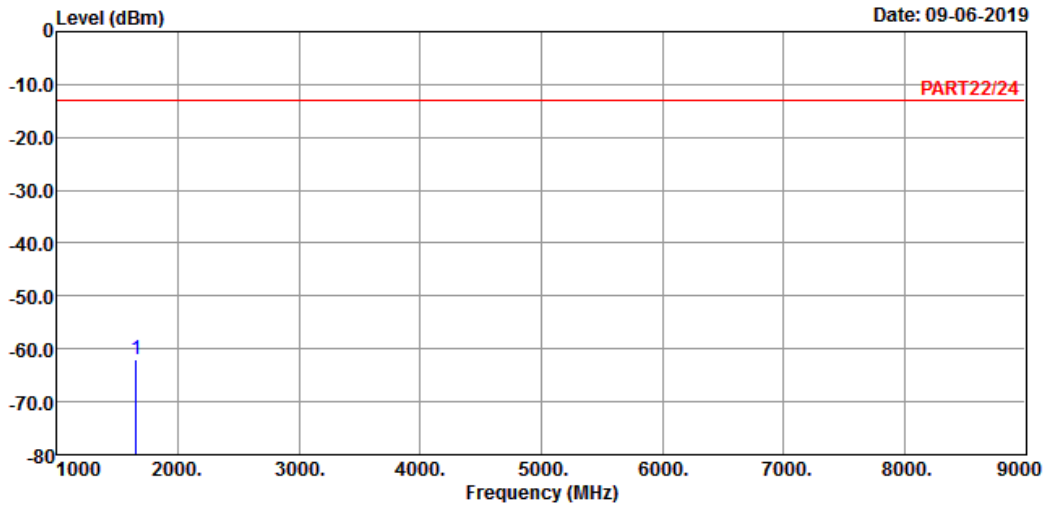

Site : 966 Chamber 5
 Condition: PART22/24 HORIZONTAL
 Remak : LTE Band 5 QPSK_5M Link_L-CH
 Tested by: Thomas Wei

Freq	Level	Read Level	Limit	Line Factor	Over Limit	Remark
MHz	dBm	dBm	dBm	dB	dB	

1 pp 1653.00 -61.97 -48.20 -13.00 -13.77 -48.97 Peak



Bureau Veritas Consumer Products Services Ltd., Taoyuan Branch

A D T

Data: 4

Date: 09-06-2019

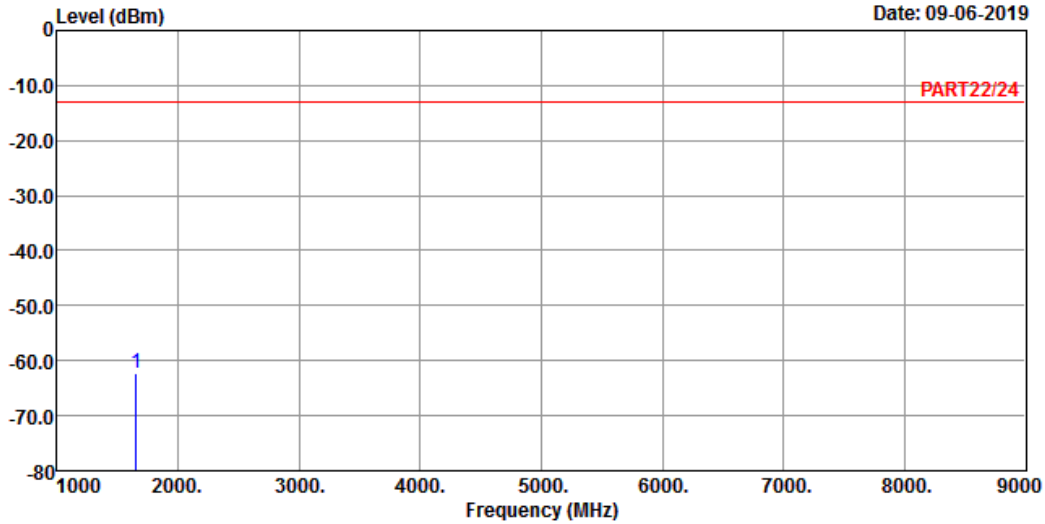

Site : 966 Chamber 5
 Condition: PART22/24 VERTICAL
 Remak : LTE Band 5 QPSK_5M Link_L-CH
 Tested by: Thomas Wei

Freq	Level	Read Level	Limit	Line Factor	Over Limit	Remark
MHz	dBm	dBm	dBm	dB	dB	
1 pp 1653.00	-62.39	-48.62	-13.00	-13.77	-49.39	Peak

Middle Channel



Bureau Veritas Consumer Products Services Ltd., Taoyuan Branch

A D T

Data: 3

Date: 09-06-2019

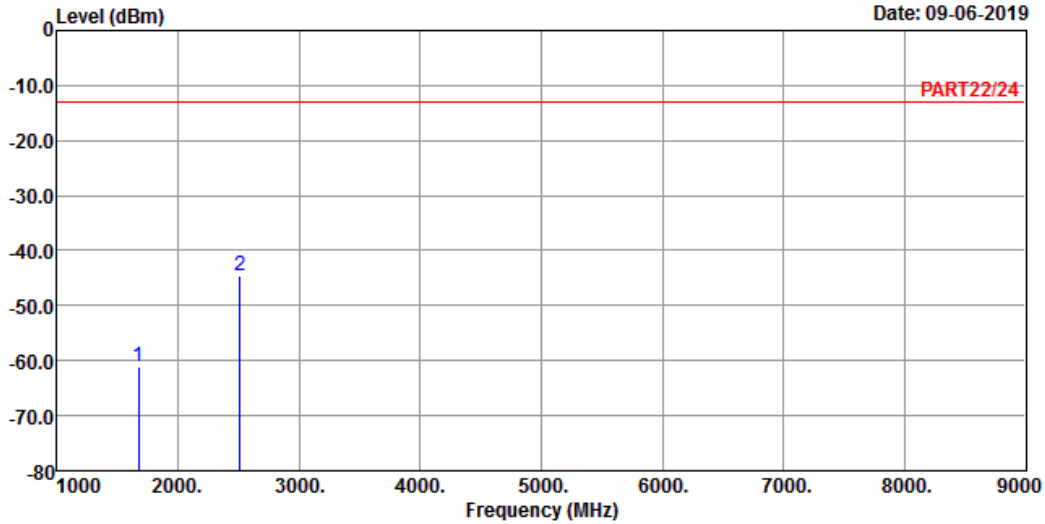

Site : 966 Chamber 5
 Condition: PART22/24 HORIZONTAL
 Remak : LTE Band 5 QPSK_5M Link_M-CH
 Tested by: Thomas Wei

	Freq	Level	Read Level	Limit	Line Factor	Over Limit	Remark
	MHz	dBm	dBm	dBm	dB	dB	
1	1673.00	-61.17	-47.27	-13.00	-13.90	-48.17	Peak
2 pp	2509.50	-44.57	-34.49	-13.00	-10.08	-31.57	Peak



Bureau Veritas Consumer Products Services Ltd., Taoyuan Branch

A D T

Data: 4

Date: 09-06-2019

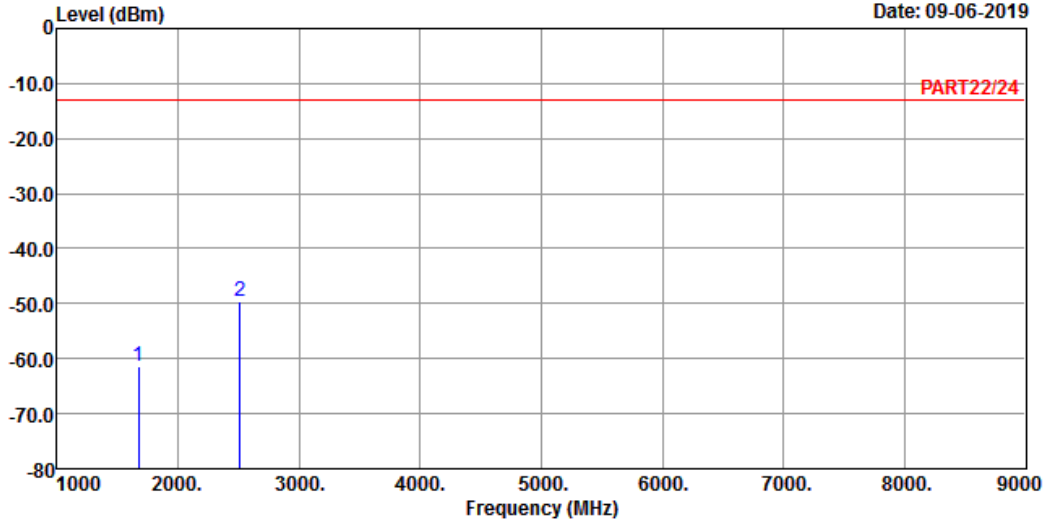

Site : 966 Chamber 5
 Condition: PART22/24 VERTICAL
 Remak : LTE Band 5 QPSK_5M Link_M-CH
 Tested by: Thomas Wei

	Freq	Level	Read Level	Limit	Line Factor	Over Limit	Remark
	MHz	dBm	dBm	dBm	dB	dB	
1	1673.00	-61.29	-47.39	-13.00	-13.90	-48.29	Peak
2	2509.50	-49.72	-39.64	-13.00	-10.08	-36.72	Peak

High Channel



Bureau Veritas Consumer Products Services Ltd., Taoyuan Branch

A D T

Data: 3

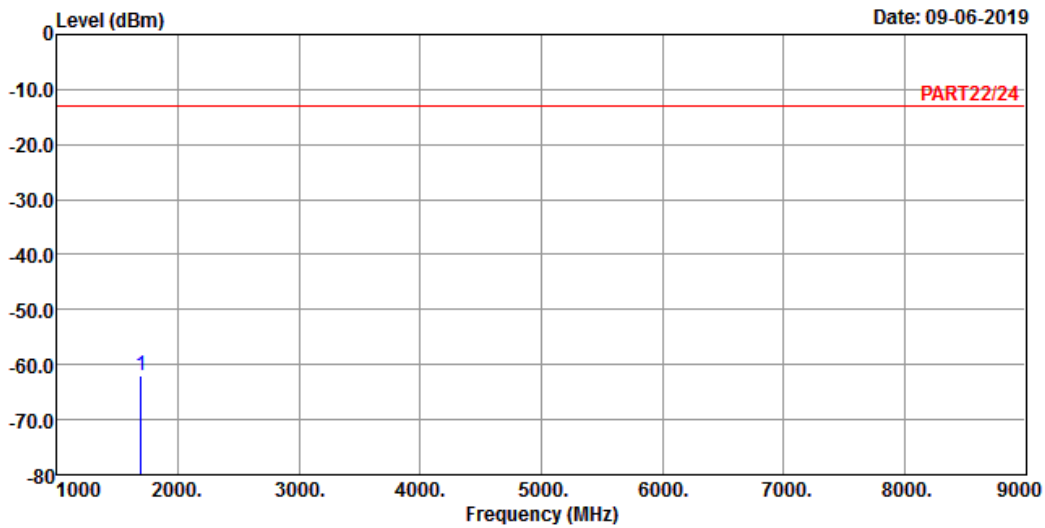

Site : 966 Chamber 5
 Condition: PART22/24 HORIZONTAL
 Remak : LTE Band 5 QPSK_5M Link_H-CH
 Tested by: Thomas Wei

Freq	Level	Read Level	Limit	Line Factor	Over Limit	Remark
MHz	dBm	dBm	dBm	dB	dB	

1 pp 1693.00 -62.13 -48.11 -13.00 -14.02 -49.13 Peak



Bureau Veritas Consumer Products Services Ltd., Taoyuan Branch

A D T

Data: 4

Date: 09-06-2019

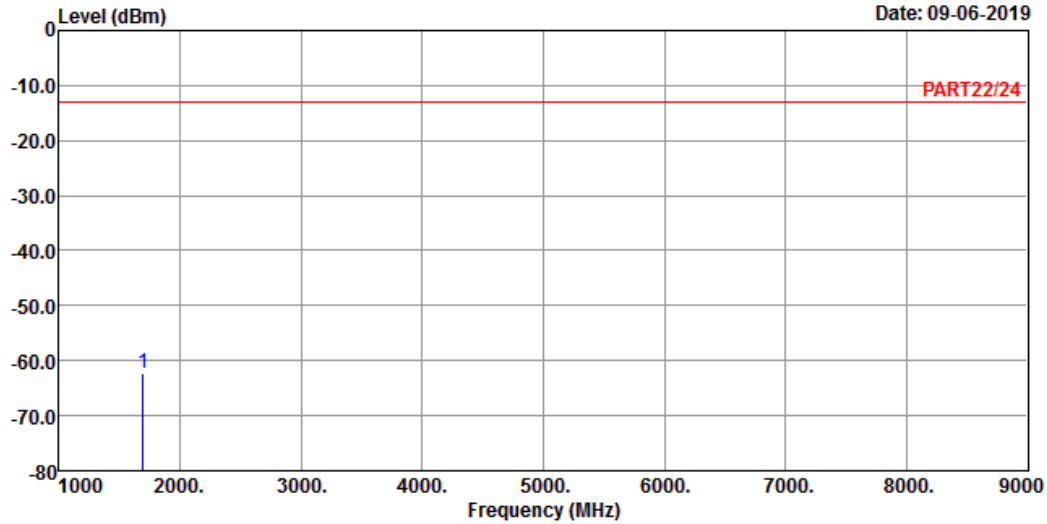

Site : 966 Chamber 5
 Condition: PART22/24 VERTICAL
 Remak : LTE Band 5 QPSK_5M Link_H-CH
 Tested by: Thomas Wei

Freq	Level	Read Level	Limit	Line Factor	Over Limit	Remark
MHz	dBm	dBm	dBm	dB	dB	
1 pp 1693.00	-62.26	-48.24	-13.00	-14.02	-49.26	Peak

Channel Bandwidth: 10 MHz / QPSK
Low Channel



Bureau Veritas Consumer Products Services Ltd., Taoyuan Branch

A D T

Data: 3

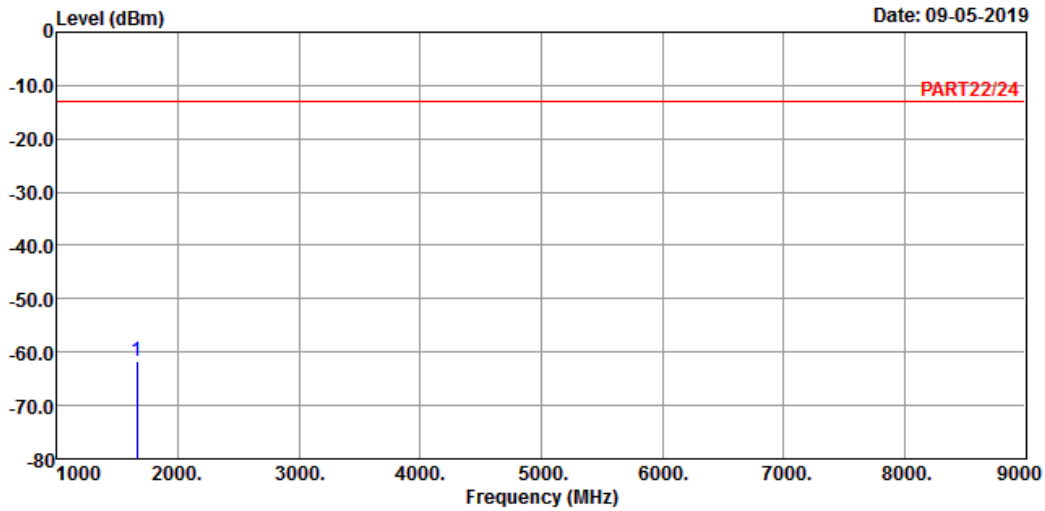

Site : 966 Chamber 5
Condition: PART22/24 HORIZONTAL
Remak : LTE Band 5 QPSK_10M Link_L-CH
Tested by: Thomas Wei

Freq	Level	Read Level	Limit	Over	Remark
MHz	dBm	dBm	dBm	dB	dB

1 pp 1658.00 -61.82 -48.02 -13.00 -13.80 -48.82 Peak



Bureau Veritas Consumer Products Services Ltd., Taoyuan Branch

A D T

Data: 4

Date: 09-05-2019

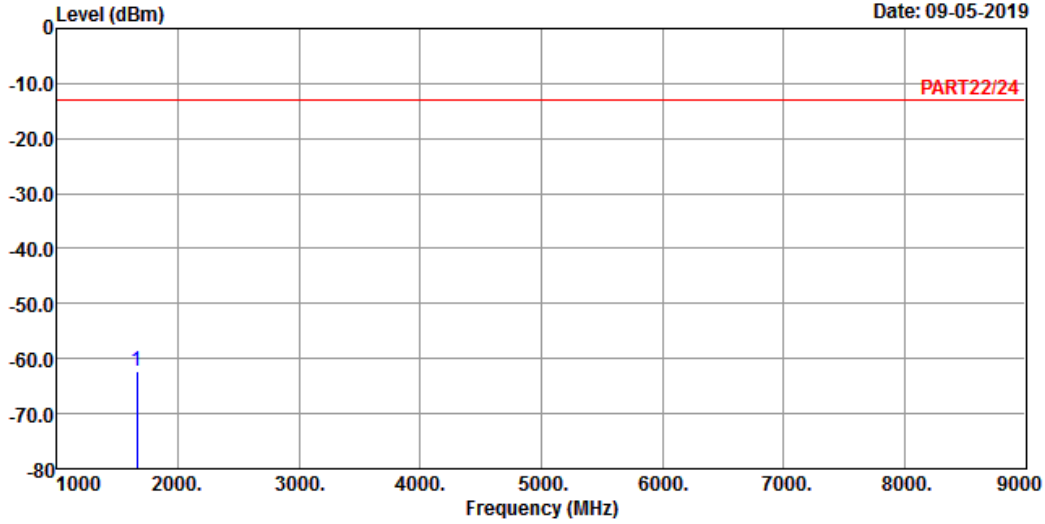

Site : 966 Chamber 5
 Condition: PART22/24 VERTICAL
 Remak : LTE Band 5 QPSK_10M Link_L-CH
 Tested by: Thomas Wei

Freq	Level	Read Level	Limit	Line Factor	Over Limit	Remark
MHz	dBm	dBm	dBm	dB	dB	
1 pp 1658.00	-62.22	-48.42	-13.00	-13.80	-49.22	Peak

Middle Channel



Bureau Veritas Consumer Products Services Ltd., Taoyuan Branch

A D T

Data: 5

Date: 08-15-2019

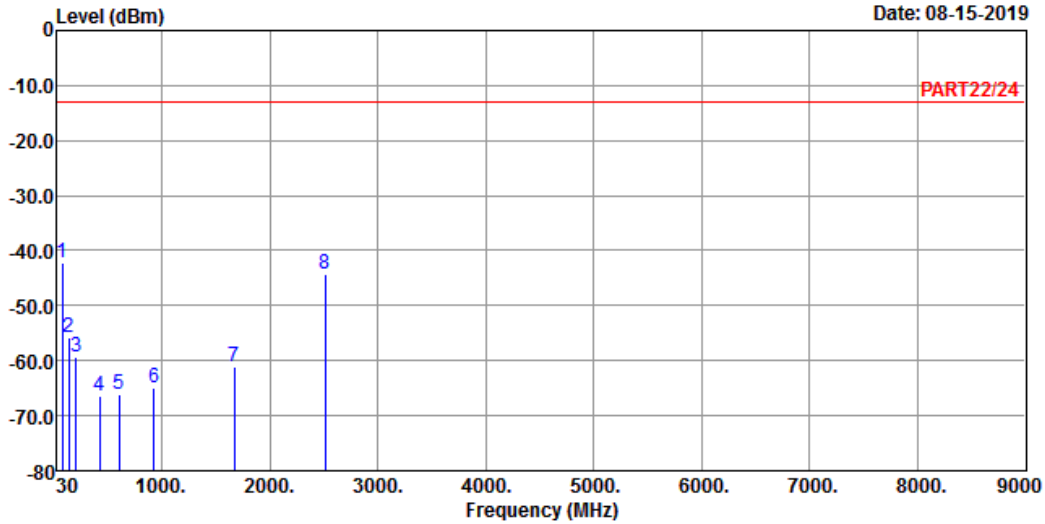

Site : 966 Chamber 5
 Condition: PART22/24 HORIZONTAL
 Remak : LTE Band 5 QPSK_10M Link_M-CH
 Tested by: Thomas Wei

	Read	Limit	Over			
Freq	Level	Level	Line	Factor	Limit	Remark
MHz	dBm	dBm	dBm	dB	dB	
1 pp	78.50	-42.11	-31.68	-13.00	-10.43	-29.11 Peak
2	136.70	-55.66	-47.00	-13.00	-8.66	-42.66 Peak
3	203.63	-59.20	-51.34	-13.00	-7.86	-46.20 Peak
4	422.85	-66.55	-60.79	-13.00	-5.76	-53.55 Peak
5	607.15	-66.03	-65.26	-13.00	-0.77	-53.03 Peak
6	924.34	-64.90	-66.07	-13.00	1.17	-51.90 Peak
7	1673.00	-61.05	-47.15	-13.00	-13.90	-48.05 Peak
8	2509.50	-44.30	-34.22	-13.00	-10.08	-31.30 Peak



Bureau Veritas Consumer Products Services Ltd., Taoyuan Branch

A D T

Data: 6

Date: 08-15-2019

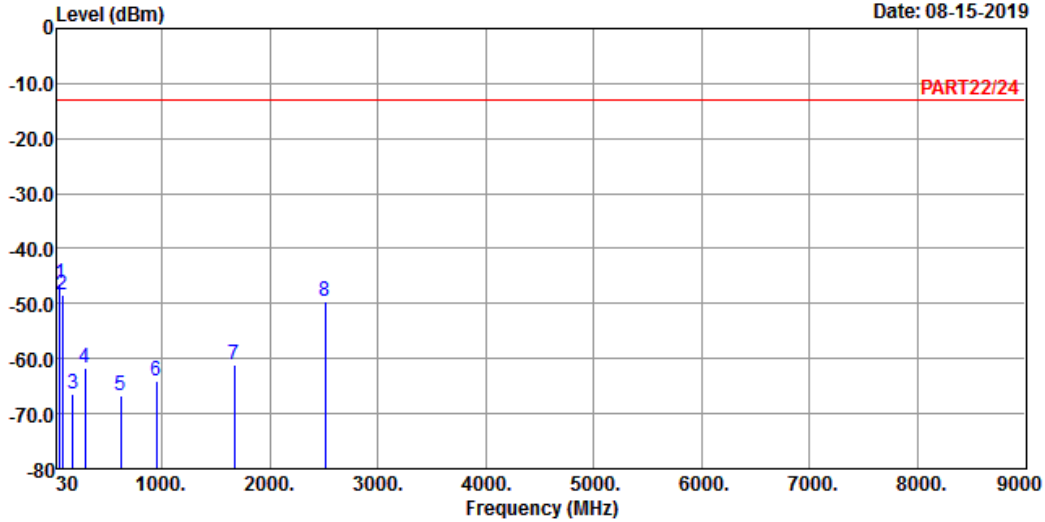

Site : 966 Chamber 5
 Condition: PART22/24 VERTICAL
 Remak : LTE Band 5 QPSK_10M Link_M-CH
 Tested by: Thomas Wei

	Freq	Level	Read Level	Limit Line	Factor	Over Limit	Remark
	MHz	dBm	dBm	dBm	dB	dB	
1 pp	53.28	-46.34	-40.53	-13.00	-5.81	-33.34	Peak
2	77.53	-48.44	-38.24	-13.00	-10.20	-35.44	Peak
3	177.44	-66.50	-59.61	-13.00	-6.89	-53.50	Peak
4	289.96	-61.67	-54.86	-13.00	-6.81	-48.67	Peak
5	614.91	-66.59	-65.80	-13.00	-0.79	-53.59	Peak
6	952.47	-64.06	-65.96	-13.00	1.90	-51.06	Peak
7	1673.00	-61.24	-47.34	-13.00	-13.90	-48.24	Peak
8	2509.50	-49.47	-39.39	-13.00	-10.08	-36.47	Peak

High Channel



Bureau Veritas Consumer Products Services Ltd., Taoyuan Branch

A D T

Data: 4

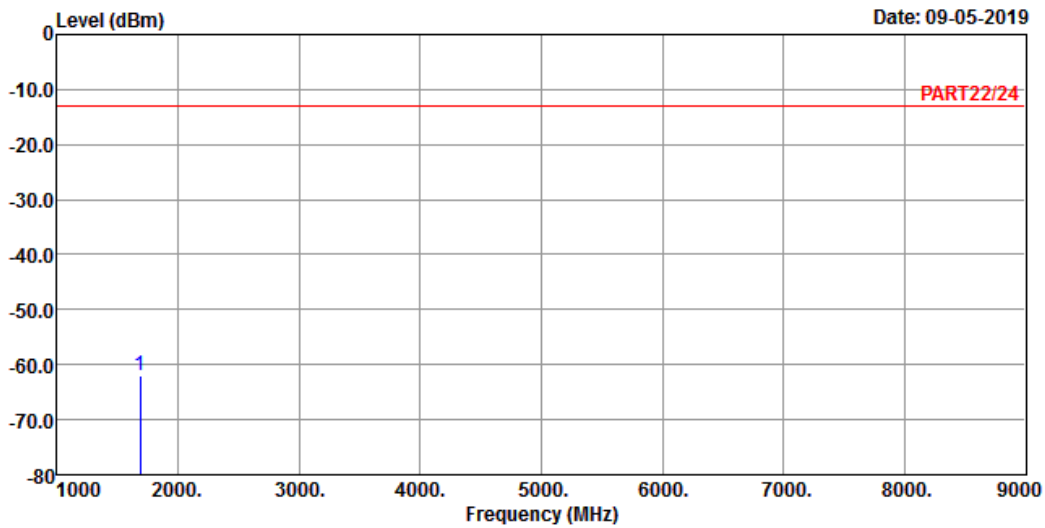

Site : 966 Chamber 5
 Condition: PART22/24 VERTICAL
 Remak : LTE Band 5 QPSK_10M Link_H-CH
 Tested by: Thomas Wei

Freq	Level	Read Level	Limit	Line Factor	Over Limit	Remark
MHz	dBm	dBm	dBm	dB	dB	

1 pp 1688.00 -62.12 -48.13 -13.00 -13.99 -49.12 Peak



Bureau Veritas Consumer Products Services Ltd., Taoyuan Branch

A D T

Data: 3

Date: 09-05-2019

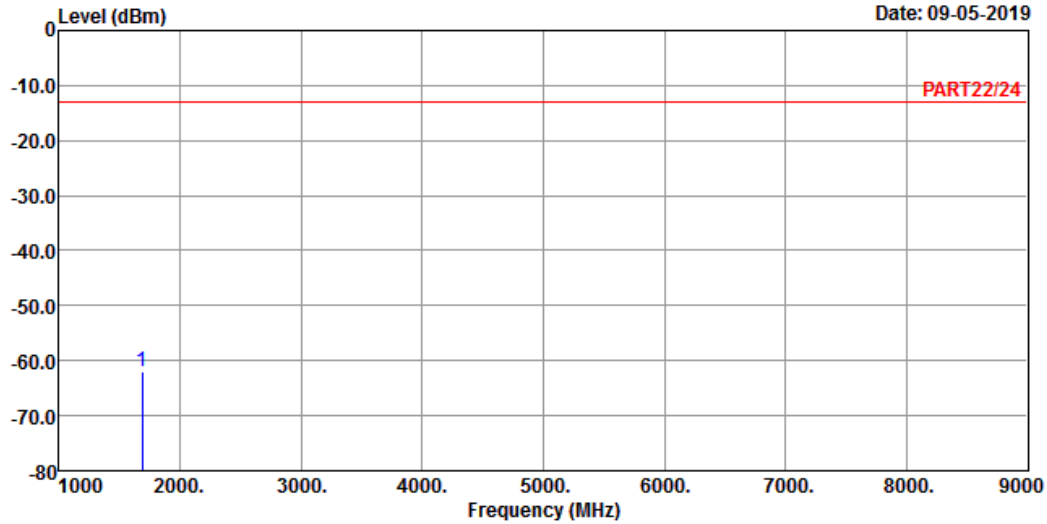

Site : 966 Chamber 5
 Condition: PART22/24 HORIZONTAL
 Remak : LTE Band 5 QPSK_10M Link_H-CH
 Tested by: Thomas Wei

Freq	Level	Read Level	Limit	Line Factor	Over Limit	Remark
MHz	dBm	dBm	dBm	dB	dB	
1 pp 1688.00	-62.07	-48.08	-13.00	-13.99	-49.07	Peak

5 Pictures of Test Arrangements

Please refer to the attached file (Test Setup Photo).

Appendix – Information of the Testing Laboratories

We, Bureau Veritas Consumer Products Services (H.K.) Ltd., Taoyuan Branch, were founded in 1988 to provide our best service in EMC, Radio, Telecom and Safety consultation. Our laboratories are FCC recognized accredited test firms and accredited according to ISO/IEC 17025.

If you have any comments, please feel free to contact us at the following:

Lin Kou EMC/RF Lab

Tel: 886-2-26052180

Fax: 886-2-26051924

Hsin Chu EMC/RF/Telecom Lab

Tel: 886-3-6668565

Fax: 886-3-6668323

Hwa Ya EMC/RF/Safety Lab

Tel: 886-3-3183232

Fax: 886-3-3270892

Email: service.adt@tw.bureauveritas.com

Web Site: www.bureauveritas-adt.com

The address and road map of all our labs can be found in our web site also.

--- END ---