



FCC TEST REPORT (NFC)

REPORT NO.: RF150318C06-7
MODEL NO.: S50c
FCC ID: ZL5S50C
RECEIVED: Mar. 18, 2015
TESTED: Mar. 27, 2015 ~ Apr. 03, 2015
ISSUED: Apr. 21, 2015

APPLICANT: Bullitt Group

ADDRESS: No. 4, The Aquarium, King Street, Reading, RG1 2AN
United Kingdom

ISSUED BY: Bureau Veritas Consumer Products Services (H.K.)
Ltd., Taoyuan Branch

LAB ADDRESS: No. 47-2, 14th Ling, Chia Pau Vil., Lin Kou Dist., New
Taipei City, Taiwan, R.O.C.

TEST LOCATION: No. 19, Hwa Ya 2nd Rd, Wen Hwa Vil., Kwei Shan
Dist., Taoyuan City 333, Taiwan, R.O.C.

This report should not be used by the client to claim
product certification, approval, or endorsement by
TAF or any government agencies.



This report is for your exclusive use. Any copying or replication of this report to or for any other person or entity, or use of our name or trademark, is permitted only with our prior written permission. This report sets forth our findings solely with respect to the test samples identified herein. The results set forth in this report are not indicative or representative of the quality or characteristics of the lot from which a test sample was taken or any similar or identical product unless specifically and expressly noted. Our report includes all of the tests requested by you and the results thereof based upon the information that you provided to us. You have 60 days from date of issuance of this report to notify us of any material error or omission caused by our negligence, provided, however, that such notice shall be in writing and shall specifically address the issue you wish to raise. A failure to raise such issue within the prescribed time shall constitute your unqualified acceptance of the completeness of this report, the tests conducted and the correctness of the report contents. Unless specific mention, the uncertainty of measurement has been explicitly taken into account to declare the compliance or non-compliance to the specification.



Table of Contents

RELEASE CONTROL RECORD.....	3
1. CERTIFICATION	4
2. SUMMARY OF TEST RESULTS.....	5
2.1 MEASUREMENT UNCERTAINTY	5
3. GENERAL INFORMATION	6
3.1 GENERAL DESCRIPTION OF EUT.....	6
3.2 DESCRIPTION OF TEST MODES.....	7
3.2.1 TEST MODE APPLICABILITY AND TESTED CHANNEL DETAIL	7
3.3 DESCRIPTION OF SUPPORT UNITS.....	9
3.3.1 CONFIGURATION OF SYSTEM UNDER TEST.....	9
3.4 GENERAL DESCRIPTION OF APPLIED STANDARDS	10
4. TEST TYPES AND RESULTS.....	11
4.1 RADIATED EMISSION MEASUREMENT	11
4.1.1 LIMITS OF RADIATED EMISSION MEASUREMENT	11
4.1.2 TEST INSTRUMENTS	12
4.1.3 TEST PROCEDURES.....	13
4.1.4 DEVIATION FROM TEST STANDARD	13
4.1.5 TEST SETUP	14
4.1.6 EUT OPERATING CONDITIONS.....	14
4.1.7 TEST RESULTS	15
4.2 CONDUCTED EMISSION MEASUREMENT	21
4.2.1 LIMITS OF CONDUCTED EMISSION MEASUREMENT	21
4.2.2 TEST INSTRUMENTS	21
4.2.3 TEST PROCEDURES.....	22
4.2.4 DEVIATION FROM TEST STANDARD	22
4.2.5 TEST SETUP	22
4.2.6 EUT OPERATING CONDITIONS.....	22
4.2.7 TEST RESULTS	23
4.3 FREQUENCY STABILITY	25
4.3.1 LIMITS OF FREQUENCY STABILITY MEASUREMENT	25
4.3.2 TEST INSTRUMENTS	25
4.3.3 TEST PROCEDURE	25
4.3.4 DEVIATION FROM TEST STANDARD	25
4.3.5 TEST SETUP	26
4.3.6 EUT OPERATING CONDITION	26
4.3.7 TEST RESULTS	27
4.4 20dB BANDWIDTH.....	28
4.4.1 LIMITS OF 20dB BANDWIDTH MEASUREMENT	28
4.4.2 TEST INSTRUMENTS	28
4.4.3 TEST PROCEDURE	28
4.4.4 DEVIATION FROM TEST STANDARD	28
4.4.5 TEST SETUP	28
4.4.6 EUT OPERATING CONDITION	28
4.4.7 TEST RESULTS	29
5. PHOTOGRAPHS OF THE TEST CONFIGURATION	30
6. INFORMATION ON THE TESTING LABORATORIES	31
7. APPENDIX A - MODIFICATIONS RECORDERS FOR ENGINEERING CHANGES TO THE EUT BY THE LAB.....	32



RELEASE CONTROL RECORD

ISSUE NO.	REASON FOR CHANGE	DATE ISSUED
RF150318C06-7	Original release	Apr. 21, 2015

1. CERTIFICATION

PRODUCT: Rugged Smart Phone

MODEL: S50c

BRAND: CAT

APPLICANT: Bullitt Group

TESTED: Mar. 27, 2015 ~ Apr. 03, 2015

TEST SAMPLE: Identical Prototype

STANDARDS: **FCC Part 15, Subpart C (Section 15.225)**

FCC Part 15, Subpart C (Section 15.215)

ANSI C63.10-2013

The above equipment (model: S50c) has been tested by **Bureau Veritas Consumer Products Services (H.K.) Ltd., Taoyuan Branch**. The test record, data evaluation & Equipment Under Test (EUT) configurations represented herein are true and accurate accounts of the measurements of the sample's EMC characteristics under the conditions specified in this report.

PREPARED BY :  , **DATE :** Apr. 21, 2015
Ivonne Wu / Supervisor

APPROVED BY :  , **DATE :** Apr. 21, 2015
Sam Chen / Senior Project Engineer

2. SUMMARY OF TEST RESULTS

The EUT has been tested according to the following specifications:

APPLIED STANDARD: FCC PART 15, SUBPART C (SECTION 15.225, 15.215)			
STANDARD SECTION	TEST TYPE AND LIMIT	RESULT	REMARK
15.207	Conducted emission test	PASS	Meet the requirement of limit. Minimum passing margin is -9.36dB at 13.56130MHz.
15.225 (a)	The field strength of any emissions within the band 13.553-13.567 MHz	PASS	Meet the requirement of limit. Minimum passing margin is -72.68dB at 13.56MHz.
15.225 (d)	The field strength of any emissions appearing outside of the 13.110-14.010 MHz band	PASS	Meet the requirement of limit. Minimum passing margin is -3.3dB at 174.53MHz.
15.225 (e)	The frequency tolerance	PASS	Meet the requirement of limit.
15.215 (c)	20dB Bandwidth	PASS	Meet the requirement of limit.

2.1 MEASUREMENT UNCERTAINTY

Where relevant, the following measurement uncertainty levels have been estimated for tests performed on the EUT as specified in CISPR 16-4-2:

MEASUREMENT	FREQUENCY	UNCERTAINTY
Conducted emissions	9kHz~30MHz	2.44 dB
Radiated emissions	30MHz ~ 200MHz	2.93 dB
	200MHz ~1000MHz	2.95 dB

This uncertainty represents an expanded uncertainty expressed at approximately the 95% confidence level using a coverage factor of k=2.

3. GENERAL INFORMATION

3.1 GENERAL DESCRIPTION OF EUT

EUT	Rugged Smart Phone
MODEL NO.	S50c
POWER SUPPLY	5.0Vdc (adapter or host equipment) 3.75Vdc (Li-ion battery)
MODULATION TYPE	ASK
OPERATING FREQUENCY	13.56MHz
ANTENNA TYPE	Loop Antenna
DATA CABLE	Refer to Note
I/O PORTS	Refer to user's manual
ACCESSORY DEVICES	Refer to Note

NOTE:

- The EUT contains following accessory devices.

ITEM	BRAND	MODEL	SPECIFICATION
Adapter	Liteon	PA-1050-05L3	I/P: 100-240Vac, 0.3A O/P: 5Vdc, 1A
Battery	Simplo Technology	A09TA008H	3.75Vdc, 2680Ah
USB Cable	BING CHUANG	BC-1.1M-AMCR5P	1m cable
LCD Panel	Truly	BTFTSZ0192	--
Photo Camera	Chicony	CBAE821	--
Video Camera	Chicony	CIFDF31-1	--
Main Board	AT&S	14H08	--
eMMC	Hynix	H26M41103HPR	8GB
CPU	Qualcomm	MSM 8926	Pin: 784

- The above EUT information is declared by the manufacturer and for more detailed features description, please refer to the manufacturer's specifications or User's Manual.

3.2 DESCRIPTION OF TEST MODES

3.2.1 TEST MODE APPLICABILITY AND TESTED CHANNEL DETAIL

EUT CONFIGURE MODE	APPLICABLE TO				DESCRIPTION
	RE	PLC	FS	BW	
-	√	√	√	√	-

Where **RE:** Radiated Emission **PLC:** Power Line Conducted Emission
FS: Frequency Stability **BW:** 20dB Bandwidth

NOTE:

The EUT had been pre-tested on the positioned of each 3 axis. The worst case was found when positioned on **Z-plane**.

RADIATED EMISSION TEST:

- Pre-Scan has been conducted to determine the worst-case mode from all possible combinations between available modulations antenna ports (if EUT with antenna diversity architecture).
- Following channel(s) was (were) selected for the final test as listed below.

EUT CONFIGURE MODE	AVAILABLE CHANNEL	TESTED CHANNEL	MODULATION TYPE
-	1	1	ASK

POWER LINE CONDUCTED EMISSION TEST:

- Pre-Scan has been conducted to determine the worst-case mode from all possible combinations between available modulations antenna ports (if EUT with antenna diversity architecture).
- Following channel(s) was (were) selected for the final test as listed below.

EUT CONFIGURE MODE	AVAILABLE CHANNEL	TESTED CHANNEL	MODULATION TYPE
-	1	1	ASK

FREQUENCY STABILITY:

- Pre-Scan has been conducted to determine the worst-case mode from all possible combinations between available modulations and antenna ports (if EUT with antenna diversity architecture).
- Following channel(s) was (were) selected for the final test as listed below.

EUT CONFIGURE MODE	AVAILABLE CHANNEL	TESTED CHANNEL	MODULATION TYPE
-	1	1	ASK



A D T

20dB BANDWIDTH:

- Pre-Scan has been conducted to determine the worst-case mode from all possible combinations between available modulations, antenna ports (if EUT with antenna diversity architecture).
- Following channel(s) was (were) selected for the final test as listed below.

EUT CONFIGURE MODE	AVAILABLE CHANNEL	TESTED CHANNEL	MODULATION TYPE
-	1	1	ASK

TEST CONDITION:

APPLICABLE TO	ENVIRONMENTAL CONDITIONS	INPUT POWER	TESTED BY
RE	25deg. C, 65%RH	120Vac, 60Hz	Gavin Wu
FS	25deg. C, 65%RH	120Vac, 60Hz	Howard Kao
PLC	25deg. C, 65%RH	120Vac, 60Hz	Anson Lin
BW	25deg. C, 65%RH	120Vac, 60Hz	Howard Kao

3.3 DESCRIPTION OF SUPPORT UNITS

The EUT has been tested as an independent unit together with other necessary accessories or support units. The following support units or accessories were used to form a representative test configuration during the tests.

NO.	PRODUCT	BRAND	MODEL NO.	SERIAL NO.	FCC ID
1	Earphone	Funkey	N/A	N/A	N/A
2	Wireless Charger	Engrgizer	IC 2B	N/A	N/A

NO.	SIGNAL CABLE DESCRIPTION OF THE ABOVE SUPPORT UNITS
1	N/A
2	N/A

NOTE:

1. All power cords of the above support units are non shielded (1.8m).

3.3.1 CONFIGURATION OF SYSTEM UNDER TEST

<EUT charged by adapter>

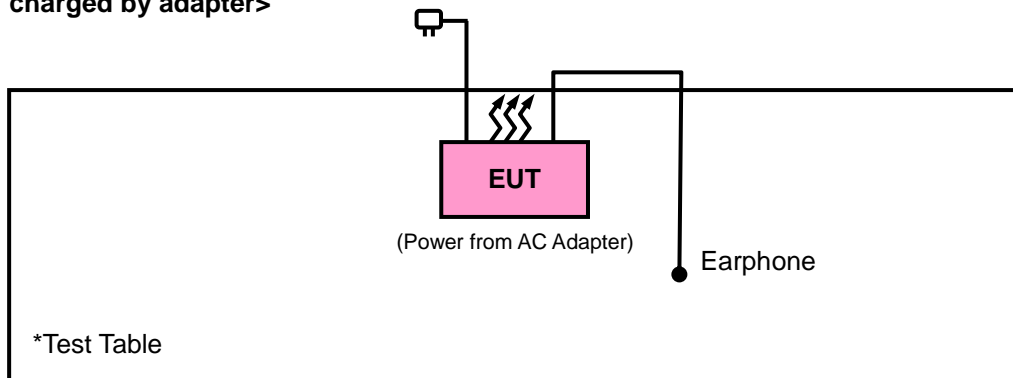

<EUT charged by wireless charger>

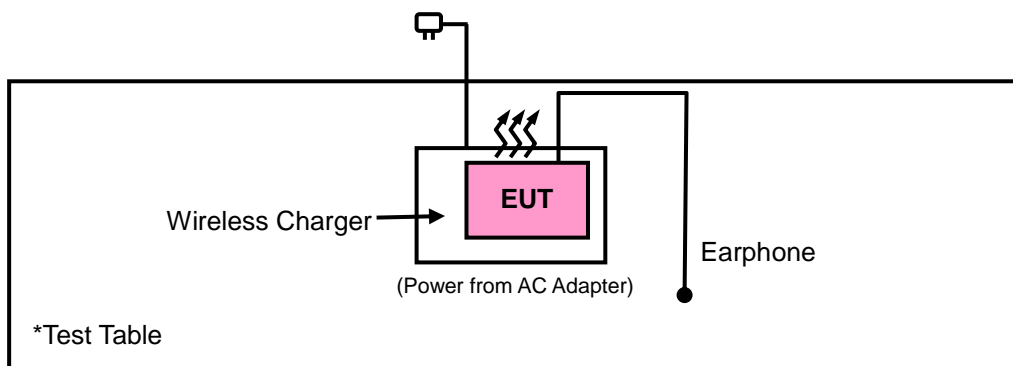

3.4 GENERAL DESCRIPTION OF APPLIED STANDARDS

The EUT is a RFID Product. According to the specifications of the manufacturer, it must comply with the requirements of the following standards:

FCC Part 15, Subpart C (15.225)

FCC Part 15, Subpart C (15.215)

ANSI C63.10-2013

All test items have been performed and recorded as per the above standards.

NOTE: The EUT has been verified to comply with the requirements of FCC Part 15, Subpart B, Class B. The test report has been issued separately.

4. TEST TYPES AND RESULTS

4.1 RADIATED EMISSION MEASUREMENT

4.1.1 LIMITS OF RADIATED EMISSION MEASUREMENT

The field strength of any emissions within the band 13.553-13.567 MHz shall not exceed 15,848 microvolts/meter at 30 meters.

The field strength of any emissions appearing outside of the 13.110-14.010 MHz band shall not exceed the general radiated emission limits in § 15.209.

FREQUENCIES (MHz)	FIELD STRENGTH (microvolts/meter)	MEASUREMENT DISTANCE (meters)
0.009 ~ 0.490	2400/F(kHz)	300
0.490 ~ 1.705	24000/F(kHz)	30
1.705 ~ 30.0	30	30
30 ~ 88	100	3
88 ~ 216	150	3
216 ~ 960	200	3
Above 960	500	3

NOTE:

1. The lower limit shall apply at the transition frequencies.
2. Emission level (dBuV/m) = 20 log Emission level (uV/m).
3. As shown in 15.35(b), for frequencies above 1000MHz, the field strength limits are based on average detector, however, the peak field strength of any emission shall not exceed the maximum permitted average limits, specified above by more than 20dB under any condition of modulation.

4.1.2 TEST INSTRUMENTS

DESCRIPTION & MANUFACTURER	MODEL NO.	SERIAL NO.	DATE OF CALIBRATION	DUE DATE OF CALIBRATION
Test Receiver Agilent	N9038A	MY51210203	Jan. 21, 2015	Jan. 21, 2016
Spectrum Analyzer Agilent	N9010A	MY52220314	Sep. 03, 2014	Sep. 02, 2015
Spectrum Analyzer ROHDE & SCHWARZ	FSU43	101261	Dec. 10, 2014	Dec. 09, 2015
BILOG Antenna SCHWARZBECK	VULB9168	9168-472	Feb. 04, 2015	Feb. 04, 2016
HORN Antenna SCHWARZBECK	BBHA 9120 D	9120D-969	Feb. 09, 2015	Feb. 09, 2016
HORN Antenna SCHWARZBECK	BBHA 9170	9170-480	Feb. 04, 2015	Feb. 04, 2016
Loop Antenna	EM-6879	269	Aug. 13, 2014	Aug. 12, 2015
Pre-amplifier EMCI	EMC 012645	980115	Dec. 12, 2014	Dec. 11, 2015
Pre-amplifier EMCI	EMC 184045	980116	Jan. 09, 2015	Jan. 08, 2016
Pre-amplifier EMCI	EMC 330H	980112	Dec. 27, 2014	Dec. 26, 2015
Power Meter Anritsu	ML2495A	1232002	Sep. 17, 2014	Sep. 16, 2015
Power Sensor Anritsu	MA2411B	1207325	Sep. 17, 2014	Sep. 16, 2015
RF signal cable HUBER+SUHNNER	SUCOFLEX 104	309219/4 2950114	Oct. 18, 2014	Oct. 17, 2015
RF signal cable HUBER+SUHNNER	SUCOFLEX 104	250130/4	Oct. 18, 2014	Oct. 17, 2015
RF Coaxial Cable Worken	8D-FB	Cable-Ch10-01	Nov. 07, 2014	Nov. 06, 2015
Software BV ADT	E3 6.120103	NA	NA	NA
Antenna Tower MF	MFA-440H	NA	NA	NA
Turn Table MF	MFT-201SS	NA	NA	NA
Antenna Tower & Turn Table Controller MF	MF-7802	NA	NA	NA

- NOTE:**
1. The calibration interval of the above test instruments is 12 months and the calibrations are traceable to NML/ROC and NIST/USA.
 2. The test was performed in HwaYa Chamber 10.
 3. The horn antenna and HP pre-amplifier (model: 8449B) are used only for the measurement of emission frequency above 1GHz if tested.
 4. The FCC Site Registration No. is 690701.
 5. The IC Site Registration No. is IC 7450F-10.

4.1.3 TEST PROCEDURES

- a. The EUT was placed on the top of a rotating table 0.8 meters above the ground at a 3 meter semi-anechoic chamber. The table was rotated 360 degrees to determine the position of the highest radiation.
- b. The EUT was set 3 meters away from the interference-receiving antenna, which was mounted on the top of a variable-height antenna tower.
- c. The antenna is a broadband antenna, and its height is varied from one meter to four meters above the ground to determine the maximum value of the field strength. Both horizontal and vertical polarizations of the antenna are set to make the measurement.
- d. For each suspected emission, the EUT was arranged to its worst case and then the antenna was tuned to heights from 1 meter to 4 meters and the rotatable table was turned from 0 degrees to 360 degrees to find the maximum reading.
- e. The test-receiver system was set to Peak Detect Function and Specified Bandwidth with Maximum Hold Mode.
- f. If the emission level of the EUT in peak mode was lower than the limit specified, then testing could be stopped and the peak values of the EUT would be reported. Otherwise the emissions would be re-tested one by one using peak, quasi-peak or average method as specified and then reported in a data sheet.

NOTE:

1. The resolution bandwidth and video bandwidth of test receiver/spectrum analyzer is 120kHz for Quasi-peak detection at frequency below 1GHz.
2. The resolution bandwidth of test receiver/spectrum analyzer is 1MHz and video bandwidth is 3MHz for Peak detection at frequency above 1GHz.
3. All modes of operation were investigated and the worst-case emissions are reported.

4.1.4 DEVIATION FROM TEST STANDARD

No deviation.

4.1.5 TEST SETUP

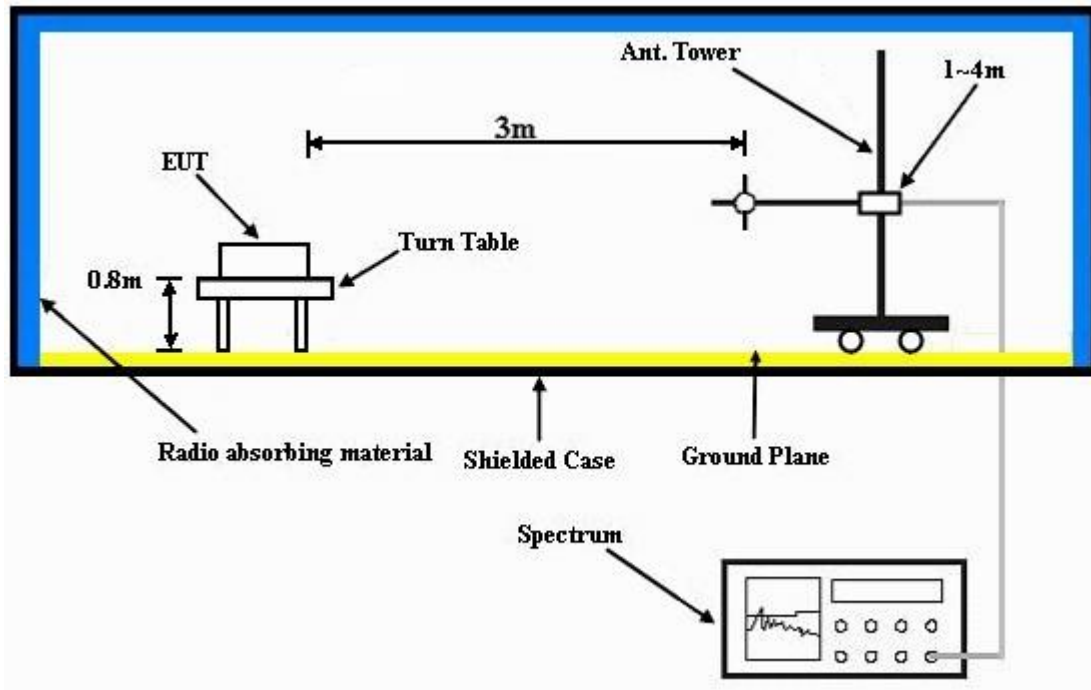

For the actual test configuration, please refer to the attached file (Test Setup Photo).

4.1.6 EUT OPERATING CONDITIONS

Set the EUT under transmission condition continuously at specific channel frequency.

4.1.7 TEST RESULTS

EUT TEST CONDITION		MEASUREMENT DETAIL	
CHANNEL	Channel 1	FREQUENCY RANGE	13.553 ~ 13.567MHz
INPUT POWER	120Vac, 60Hz	DETECTOR FUNCTION	Peak (PK)
ENVIRONMENTAL CONDITIONS	25deg. C, 65%RH	TESTED BY	Gavin Wu

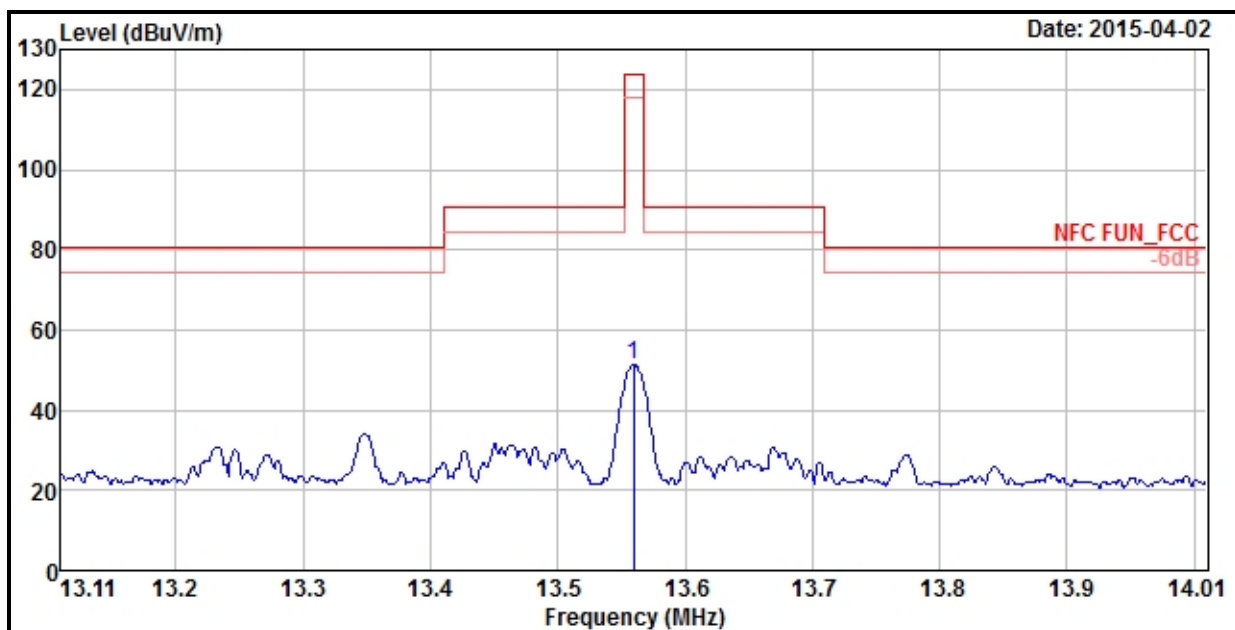

ANTENNA POLARITY & TEST DISTANCE: LOOP ANTENNA OPEN AT 3M										
FREQ. (MHz)	EMISSION LEVEL (dBuV/m)	READ LEVEL (dBuV)	LIMIT (dBuV/m)	MARGIN (dB)	ANTENNA FACTOR (dB/m)	CABLE LOSS (dB)	PREAMP FACTOR (dB)	ANTENNA HEIGHT (cm)	TABLE ANGLE (Degree)	REMARK
13.56	51.32	54.70	124.00	-72.68	37.67	0.31	41.36	100	360	Peak

- REMARKS:**
1. Emission level(dBuV/m)= Read Level (dBuV) + Correction Factor (dB/m)
 2. Correction Factor (dB/m) = Antenna Factor + Cable Loss (dB) – Preamp Factor (dB)
 3. The other emission levels were very low against the limit.
 4. Margin value = Emission level – Limit value.
 5. Above limits have been translated by the formula

The measured field strength was extrapolated to distance 30 meters, using the formula that the limit of field strength varies as the inverse distance square (40dB per decade of distance)

Example:

$$\begin{aligned}
 13.56\text{MHz} &= 15848\mu\text{V/m} && 30\text{m} \\
 &= 84\text{dBuV/m} && 30\text{m} \\
 &= 84+20\log(30/3)^2 && 3\text{m} \\
 &= 124\text{dBuV/m}
 \end{aligned}$$



A D T

EUT TEST CONDITION		MEASUREMENT DETAIL	
CHANNEL	Channel 1	FREQUENCY RANGE	13.553 ~ 13.567MHz
INPUT POWER	120Vac, 60Hz	DETECTOR FUNCTION	Peak (PK)
ENVIRONMENTAL CONDITIONS	25deg. C, 65%RH	TESTED BY	Gavin Wu

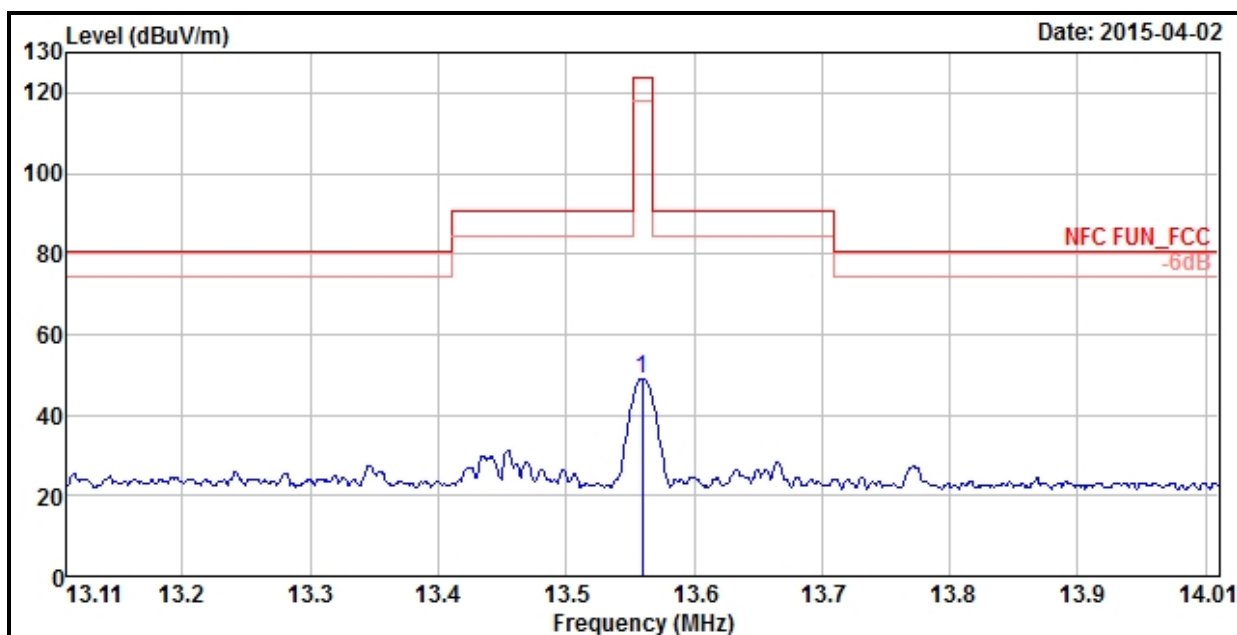

ANTENNA POLARITY & TEST DISTANCE: LOOP ANTENNA CLOSE AT 3M										
FREQ. (MHz)	EMISSION LEVEL (dBuV/m)	READ LEVEL (dBuV)	LIMIT (dBuV/m)	MARGIN (dB)	ANTENNA FACTOR (dB/m)	CABLE LOSS (dB)	PREAMP FACTOR (dB)	ANTENNA HEIGHT (cm)	TABLE ANGLE (Degree)	REMARK
13.56	49.14	52.52	124.00	-74.86	37.67	0.31	41.36	100	0	Peak

- REMARKS:**
1. Emission level(dBuV/m)= Read Level (dBuV) + Correction Factor (dB/m)
 2. Correction Factor (dB/m) = Antenna Factor + Cable Loss (dB) – Preamp Factor (dB)
 3. The other emission levels were very low against the limit.
 4. Margin value = Emission level – Limit value.
 5. Above limits have been translated by the formula

The measured field strength was extrapolated to distance 30 meters, using the formula that the limit of field strength varies as the inverse distance square (40dB per decade of distance)

Example:

$$\begin{aligned}
 13.56\text{MHz} &= 15848\mu\text{V/m} && 30\text{m} \\
 &= 84\text{dBuV/m} && 30\text{m} \\
 &= 84+20\log(30/3)^2 && 3\text{m} \\
 &= 124\text{dBuV/m}
 \end{aligned}$$



A D T

EUT TEST CONDITION		MEASUREMENT DETAIL	
CHANNEL	Channel 1	FREQUENCY RANGE	Below 30MHz
INPUT POWER	120Vac, 60Hz	DETECTOR FUNCTION	Peak (PK)
ENVIRONMENTAL CONDITIONS	25deg. C, 65%RH	TESTED BY	Gavin Wu

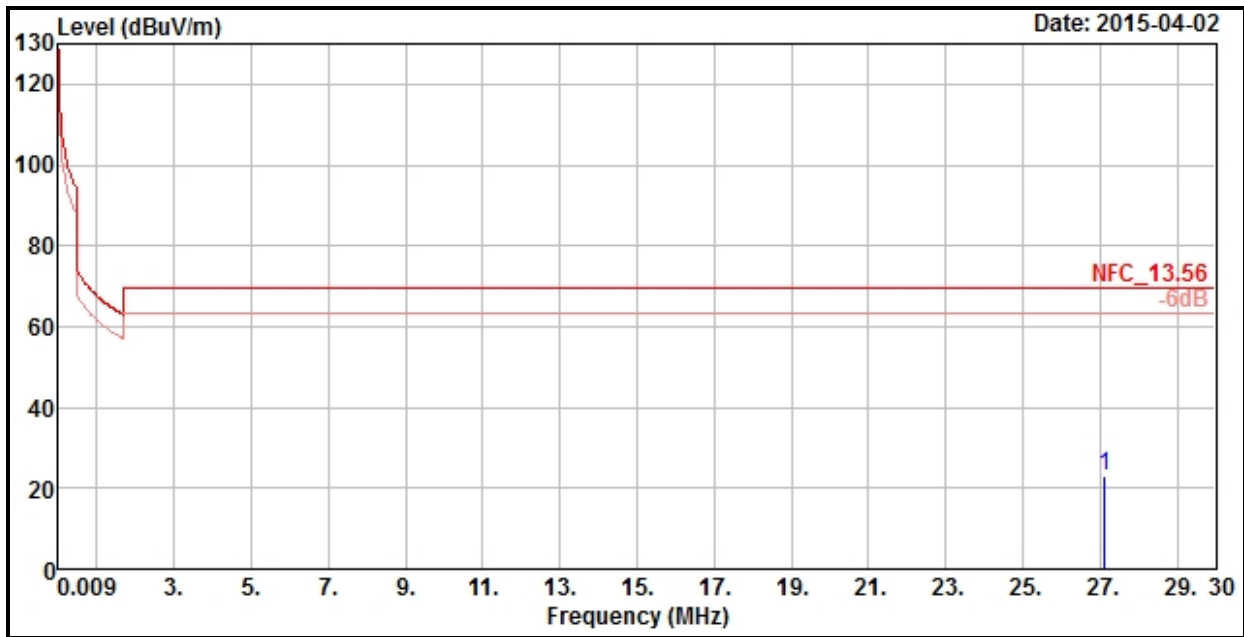

ANTENNA POLARITY & TEST DISTANCE: LOOP ANTENNA OPEN AT 3M										
FREQ. (MHz)	EMISSION LEVEL (dBuV/m)	READ LEVEL (dBuV)	LIMIT (dBuV/m)	MARGIN (dB)	ANTENNA FACTOR (dB/m)	CABLE LOSS (dB)	PREAMP FACTOR (dB)	ANTENNA HEIGHT (cm)	TABLE ANGLE (Degree)	REMARK
27.121	23.01	28.41	69.54	-46.53	35.55	0.38	41.33	100	360	Peak

REMARKS:

1. Emission level(dBuV/m)= Read Level (dBuV) + Correction Factor (dB/m)
2. Correction Factor (dB/m) = Antenna Factor + Cable Loss (dB) – Preamp Factor (dB)
3. The other emission levels were very low against the limit.
4. Margin value = Emission level – Limit value.



A D T

EUT TEST CONDITION		MEASUREMENT DETAIL	
CHANNEL	Channel 1	FREQUENCY RANGE	Below 30MHz
INPUT POWER	120Vac, 60Hz	DETECTOR FUNCTION	Peak (PK)
ENVIRONMENTAL CONDITIONS	25deg. C, 65%RH	TESTED BY	Gavin Wu

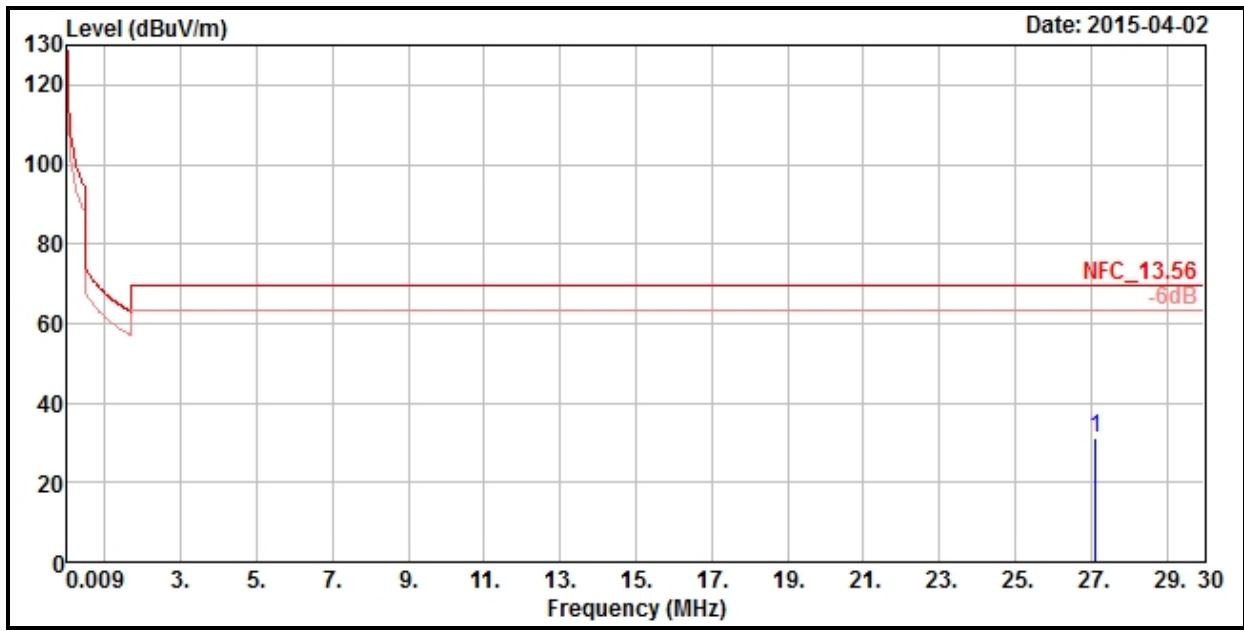

ANTENNA POLARITY & TEST DISTANCE: LOOP ANTENNA CLOSE AT 3M										
FREQ. (MHz)	EMISSION LEVEL (dBuV/m)	READ LEVEL (dBuV)	LIMIT (dBuV/m)	MARGIN (dB)	ANTENNA FACTOR (dB/m)	CABLE LOSS (dB)	PREAMP FACTOR (dB)	ANTENNA HEIGHT (cm)	TABLE ANGLE (Degree)	REMARK
27.121	31.02	36.42	69.54	-38.52	35.55	0.38	41.33	100	0	Peak

REMARKS:

1. Emission level(dBuV/m)= Read Level (dBuV) + Correction Factor (dB/m)
2. Correction Factor (dB/m) = Antenna Factor + Cable Loss (dB) – Preamp Factor (dB)
3. The other emission levels were very low against the limit.
4. Margin value = Emission level – Limit value.



A D T

EUT TEST CONDITION		MEASUREMENT DETAIL	
CHANNEL	Channel 1	FREQUENCY RANGE	30MHz ~ 1GHz
INPUT POWER	120Vac, 60 Hz	DETECTOR FUNCTION	Peak (PK) Quasi-peak (QP)
ENVIRONMENTAL CONDITIONS	25deg. C, 65%RH	TESTED BY	Gavin Wu

HORIZONTAL

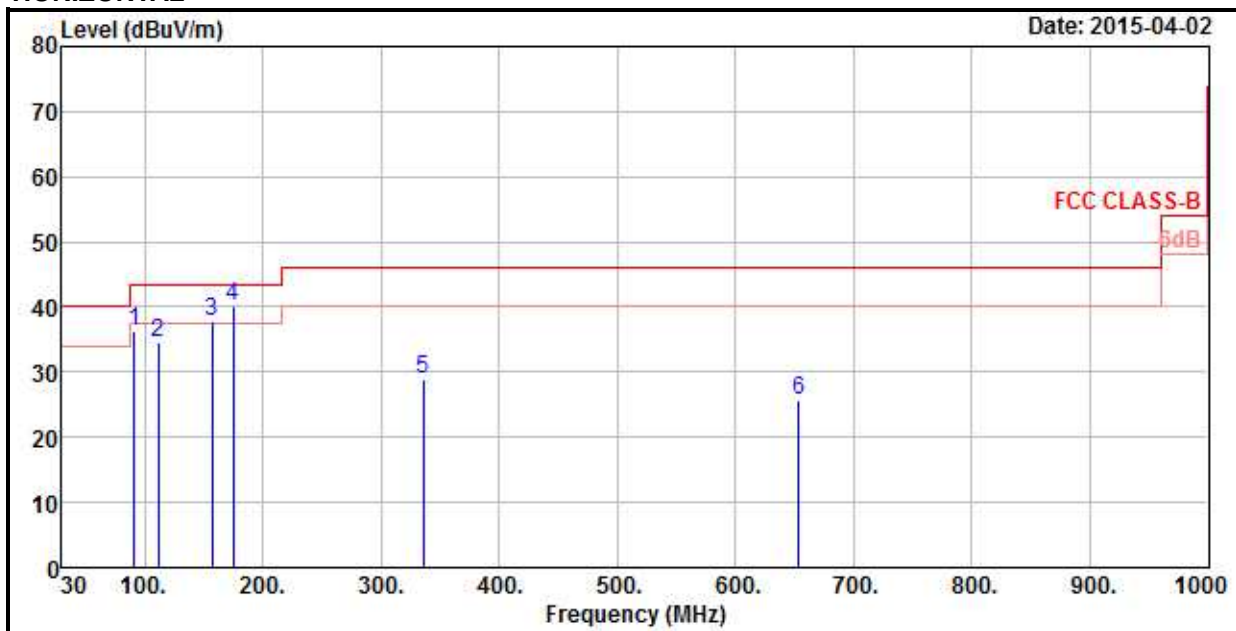

VERTICAL

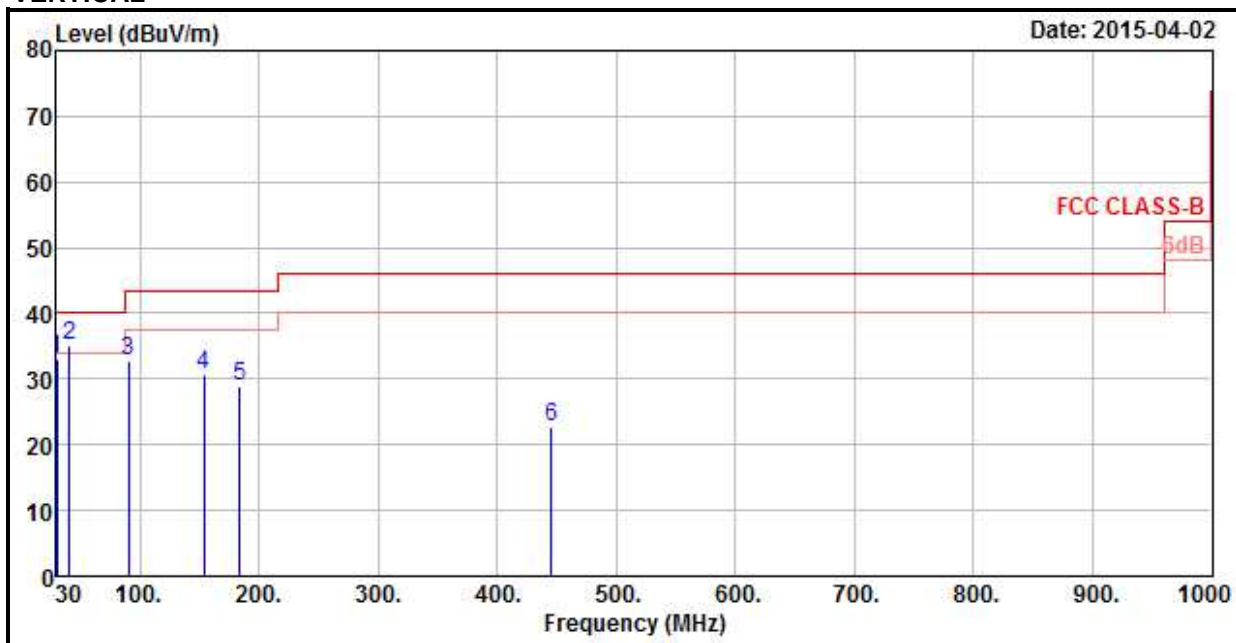



A D T

ANTENNA POLARITY & TEST DISTANCE: HORIZONTAL AT 3 M										
FREQ. (MHz)	EMISSION LEVEL (dBuV/m)	READ LEVEL (dBuV)	LIMIT (dBuV/m)	MARGIN (dB)	ANTENNA FACTOR (dB/m)	CABLE LOSS (dB)	PREAMP FACTOR (dB)	ANTENNA HEIGHT (cm)	TABLE ANGLE (Degree)	REMARK
91.11	36.22	58.77	43.5	-7.28	8.38	1.03	31.96	108	155	Peak
111.48	34.68	55.21	43.5	-8.82	10.18	1.14	31.85	120	136	Peak
157.07	37.71	55.41	43.5	-5.79	12.72	1.38	31.8	100	207	Peak
174.53	40.2	59.23	43.5	-3.3	11.28	1.47	31.78	221	360	Peak
335.55	28.86	44.7	46	-17.14	13.8	2.18	31.82	100	199	Peak
653.71	25.65	34.12	46	-20.35	20.26	3.26	31.99	168	204	Peak
ANTENNA POLARITY & TEST DISTANCE: VERTICAL AT 3 M										
FREQ. (MHz)	EMISSION LEVEL (dBuV/m)	READ LEVEL (dBuV)	LIMIT (dBuV/m)	MARGIN (dB)	ANTENNA FACTOR (dB/m)	CABLE LOSS (dB)	PREAMP FACTOR (dB)	ANTENNA HEIGHT (cm)	TABLE ANGLE (Degree)	REMARK
30	33.08	51.67	40	-6.92	11.98	0.57	31.14	100	158	Peak
40.67	35.14	51.94	40	-4.86	13.55	0.67	31.02	132	196	Peak
90.14	32.86	55.5	43.5	-10.64	8.3	1.02	31.96	100	182	Peak
154.16	30.63	48.27	43.5	-12.87	12.72	1.36	31.72	100	98	Peak
184.23	28.81	48.6	43.5	-14.69	10.46	1.52	31.77	102	105	Peak
445.16	22.83	35.99	46	-23.17	16.23	2.6	31.99	170	169	Peak

REMARKS:

1. Emission Level = Read Level + Antenna Factor + Cable Loss - Preamp Factor

Margin value = Emission level – Limit value.

4.2 CONDUCTED EMISSION MEASUREMENT

4.2.1 LIMITS OF CONDUCTED EMISSION MEASUREMENT

FREQUENCY OF EMISSION (MHz)	CONDUCTED LIMIT (dBµV)	
	Quasi-peak	Average
0.15 ~ 0.5	66 to 56	56 to 46
0.5 ~ 5	56	46
5 ~ 30	60	50

NOTE:

1. The lower limit shall apply at the transition frequencies.
2. The limit decreases in line with the logarithm of the frequency in the range of 0.15 to 0.50 MHz.
3. All emanations from a class A/B digital device or system, including any network of conductors and apparatus connected thereto, shall not exceed the level of field strengths specified above.

4.2.2 TEST INSTRUMENTS

DESCRIPTION & MANUFACTURER	MODEL NO.	SERIAL NO.	DATE OF CALIBRATION	DUE DATE OF CALIBRATION
Test Receiver ROHDE & SCHWARZ	ESCI	100613	Nov. 11, 2014	Nov. 10, 2015
RF signal cable Woken	5D-FB	Cable-HYC01-01	Dec. 26, 2014	Dec. 25, 2015
LISN ROHDE & SCHWARZ (EUT)	ESH3-Z5	835239/001	Mar. 02, 2015	Mar. 01, 2016
LISN ROHDE & SCHWARZ (Peripheral)	ESH3-Z5	100311	Jul. 21, 2014	Jul. 20, 2015
Software ADT	BV ADT_Cond_ V7.3.7.3	NA	NA	NA

NOTE:

1. The calibration interval of the above test instruments is 12 months and the calibrations are traceable to NML/ROC and NIST/USA.
2. The test was performed in HwaYa Shielded Room 1.
3. The VCCI Site Registration No. is C-2040.

4.2.3 TEST PROCEDURES

- The EUT was placed 0.4 meters from the conducting wall of the shielded room with EUT being connected to the power mains through a line impedance stabilization network (LISN). Other support units were connected to the power mains through another LISN. The two LISNs provide 50 ohm/ 50uH of coupling impedance for the measuring instrument.
- Both lines of the power mains connected to the EUT were checked for maximum conducted interference.
- The frequency range from 150kHz to 30MHz was searched. Emission levels under (Limit - 20dB) was not recorded.

NOTE: All modes of operation were investigated and the worst-case emissions are reported.

4.2.4 DEVIATION FROM TEST STANDARD

No deviation.

4.2.5 TEST SETUP

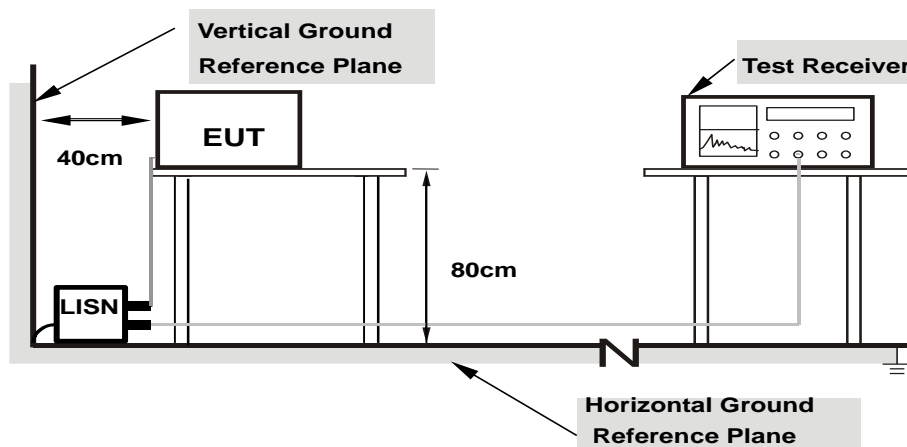

- Note:**
- Support units were connected to second LISN.
 - Both of LISNs (AMN) are 80 cm from EUT and at least 80 from other units and other metal planes

For the actual test configuration, please refer to the attached file (Test Setup Photo).

4.2.6 EUT OPERATING CONDITIONS

Same as item 4.1.6.

4.2.7 TEST RESULTS

Frequency Range	150kHz ~ 30MHz	Detector Function & Resolution Bandwidth	Quasi-Peak (QP) / Average (AV), 9kHz
Input Power	120Vac, 60Hz	Environmental Conditions	25°C, 65%RH
Tested by	Anson Lin	Test Date	2015/3/27

Phase Of Power : Line (L)										
No	Frequency (MHz)	Correction Factor (dB)	Reading Value (dBuV)		Emission Level (dBuV)		Limit (dBuV)		Margin (dB)	
			Q.P.	AV.	Q.P.	AV.	Q.P.	AV.	Q.P.	AV.
1	0.48626	0.06	38.90	26.89	38.96	26.95	56.23	46.23	-17.27	-19.28
2	0.82252	0.07	38.38	26.20	38.45	26.27	56.00	46.00	-17.55	-19.73
3	1.04930	0.08	38.50	27.72	38.58	27.80	56.00	46.00	-17.42	-18.20
4	1.29954	0.09	36.13	27.89	36.22	27.98	56.00	46.00	-19.78	-18.02
5	3.53215	0.17	34.28	24.39	34.45	24.56	56.00	46.00	-21.55	-21.44
6	13.55739	0.61	44.21	39.86	44.82	40.47	60.00	50.00	-15.18	-9.53

Remarks:

1. Q.P. and AV. are abbreviations of quasi-peak and average individually.
2. The emission levels of other frequencies were very low against the limit.
3. Margin value = Emission level – Limit value
4. Correction factor = Insertion loss + Cable loss
5. Emission Level = Correction Factor + Reading Value

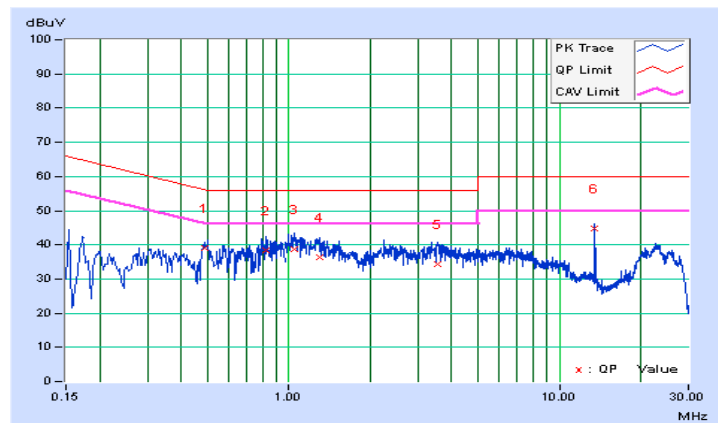

Frequency Range	150kHz ~ 30MHz	Detector Function & Resolution Bandwidth	Quasi-Peak (QP) / Average (AV), 9kHz
Input Power	120Vac, 60Hz	Environmental Conditions	25°C, 65%RH
Tested by	Anson Lin	Test Date	2015/3/27

Phase Of Power : Neutral (N)										
No	Frequency (MHz)	Correction Factor (dB)	Reading Value (dBuV)		Emission Level (dBuV)		Limit (dBuV)		Margin (dB)	
			Q.P.	AV.	Q.P.	AV.	Q.P.	AV.	Q.P.	AV.
1	0.40055	0.06	40.75	23.53	40.81	23.59	57.84	47.84	-17.03	-24.25
2	0.50581	0.06	41.47	26.10	41.53	26.16	56.00	46.00	-14.47	-19.84
3	0.78733	0.07	38.86	26.77	38.93	26.84	56.00	46.00	-17.07	-19.16
4	1.15487	0.08	37.69	26.60	37.77	26.68	56.00	46.00	-18.23	-19.32
5	13.56130	0.53	45.74	40.11	46.27	40.64	60.00	50.00	-13.73	-9.36
6	23.31675	0.78	41.41	28.72	42.19	29.50	60.00	50.00	-17.81	-20.50

Remarks:

1. Q.P. and AV. are abbreviations of quasi-peak and average individually.
2. The emission levels of other frequencies were very low against the limit.
3. Margin value = Emission level – Limit value
4. Correction factor = Insertion loss + Cable loss
5. Emission Level = Correction Factor + Reading Value

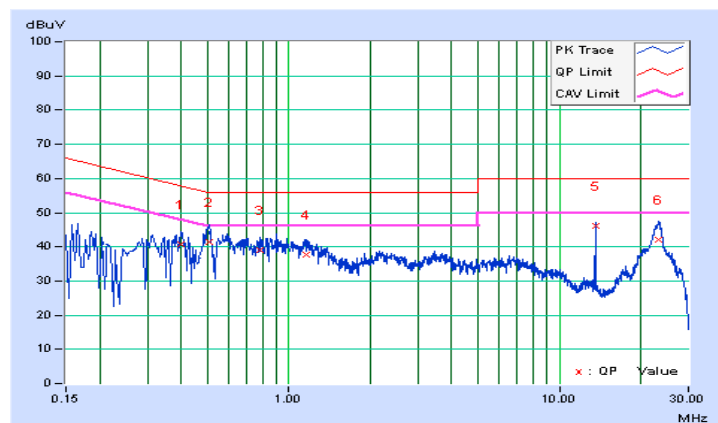

4.3 FREQUENCY STABILITY

4.3.1 LIMITS OF FREQUENCY STABILITY MEASUREMENT

The frequency tolerance of the carrier signal shall be maintained within +/- 0.01% of the operating frequency over a temperature variation of -20 degrees to 50 degrees C at normal supply voltage, and for a variation in the primary supply voltage from 85% to 115% of the rated supply voltage at a temperature of 20 degrees C.

4.3.2 TEST INSTRUMENTS

DESCRIPTION & MANUFACTURER	MODEL NO.	SERIAL NO.	DATE OF CALIBRATION	DUE DATE OF CALIBRATION
Temperature & Humidity Chamber	GTH-120-40-CP-AR	MAA1306-019	Sep. 01, 2014	Aug. 31, 2015

NOTE: The calibration interval of the above test instruments is 12 months and the calibrations are traceable to NML/ROC and NIST/USA.

4.3.3 TEST PROCEDURE

- a. The EUT was placed inside the environmental test chamber and powered by nominal DC voltage.
- b. Turn the EUT on and couple its output to a spectrum analyzer.
- c. Turn the EUT off and set the chamber to the highest temperature specified.
- d. Allow sufficient time (approximately 30 min) for the temperature of the chamber to stabilize, turn the EUT on and measure the operating frequency after 2, 5, and 10 minutes.
- e. Repeat step 2 and 3 with the temperature chamber set to the lowest temperature.
- f. The test chamber was allowed to stabilize at +20 degree C for a minimum of 30 minutes. The supply voltage was then adjusted on the EUT from 85% to 115% range and the frequency record.

4.3.4 DEVIATION FROM TEST STANDARD

No deviation.

4.3.5 TEST SETUP

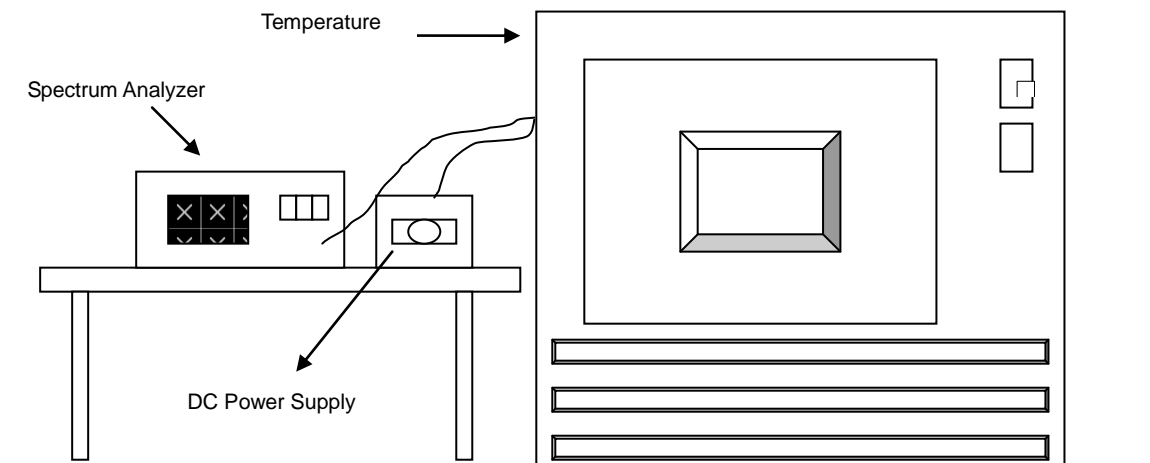

4.3.6 EUT OPERATING CONDITION

Same as item 4.1.6.



4.3.7 TEST RESULTS

FREQUENCY STABILITY VERSUS TEMP.									
TEMP. (°C)	POWER SUPPLY (Vdc)	0 MINUTE		2 MINUTE		5 MINUTE		10 MINUTE	
		Measured Frequency	Frequency Drift	Measured Frequency	Frequency Drift	Measured Frequency	Frequency Drift	Measured Frequency	Frequency Drift
		(MHz)	%	(MHz)	%	(MHz)	%	(MHz)	%
60	3.8	13.559968	-0.0002	13.559982	-0.0001	13.559966	-0.0003	13.559996	0.0000
50	3.8	13.559988	-0.00009	13.559978	-0.00016	13.559992	-0.00006	13.559997	-0.00002
40	3.8	13.560046	0.00034	13.560041	0.00030	13.560034	0.00025	13.560031	0.00023
30	3.8	13.560052	0.00038	13.56005	0.00037	13.560043	0.00032	13.560045	0.00033
20	3.8	13.560067	0.00049	13.560053	0.00039	13.560059	0.00044	13.560067	0.00049
10	3.8	13.559982	-0.00013	13.559987	-0.00010	13.559991	-0.00007	13.559981	-0.00014
0	3.8	13.559937	-0.00046	13.559947	-0.00039	13.559937	-0.00046	13.559942	-0.00043
-10	3.8	13.56003	0.00022	13.560015	0.00011	13.560022	0.00016	13.560024	0.00018
-20	3.8	13.559992	-0.00006	13.559978	-0.00016	13.559979	-0.00015	13.559992	-0.00006

FREQUENCY STABILITY VERSUS VOLTAGE									
TEMP. (°C)	POWER SUPPLY (Vdc)	0 MINUTE		2 MINUTE		5 MINUTE		10 MINUTE	
		Measured Frequency	Frequency Drift	Measured Frequency	Frequency Drift	Measured Frequency	Frequency Drift	Measured Frequency	Frequency Drift
		(MHz)	%	(MHz)	%	(MHz)	%	(MHz)	%
20	4.2	13.560064	0.00047	13.560055	0.00041	13.560058	0.00043	13.560063	0.00046
	3.8	13.560067	0.00049	13.560053	0.00039	13.560059	0.00044	13.560067	0.00049
	3.6	13.560067	0.00049	13.560056	0.00041	13.560055	0.00041	13.560063	0.00046

4.4 20dB BANDWIDTH

4.4.1 LIMITS OF 20dB BANDWIDTH MEASUREMENT

The 20dB bandwidth shall be specified in operating frequency band.

4.4.2 TEST INSTRUMENTS

Same as item 4.1.2.

4.4.3 TEST PROCEDURE

The bandwidth of the fundamental frequency was measured by spectrum analyzer with 1kHz RBW and 3kHz VBW. The 20dB bandwidth is defined as the total spectrum the power of which is higher than peak power minus 20dB.

4.4.4 DEVIATION FROM TEST STANDARD

No deviation.

4.4.5 TEST SETUP

Same as item 4.1.5.

4.4.6 EUT OPERATING CONDITION

Same as item 4.1.6.



A D T

4.4.7 TEST RESULTS

20dBc point (Low)	20dBc point (High)	Operating frequency band (MHz)	PASS/FAIL
13.558461538 MHz	13.561057692 MHz	13.553~13.567	PASS

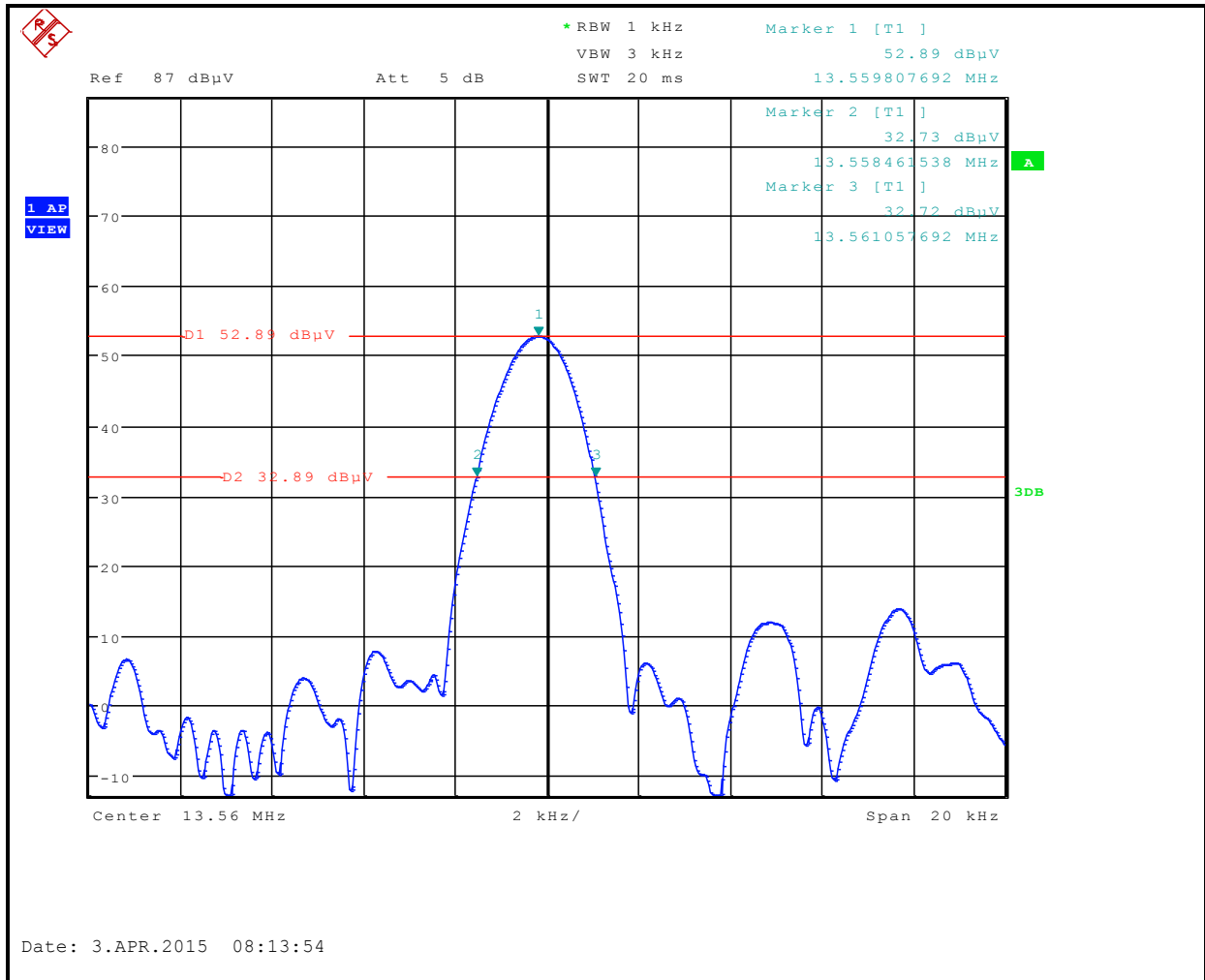

5. PHOTOGRAPHS OF THE TEST CONFIGURATION

Please refer to the attached file (Test Setup Photo).

6. INFORMATION ON THE TESTING LABORATORIES

We, Bureau Veritas Consumer Products Services (H.K.) Ltd., Taoyuan Branch, were founded in 1988 to provide our best service in EMC, Radio, Telecom and Safety consultation. Our laboratories are accredited and approved according to ISO/IEC 17025.

If you have any comments, please feel free to contact us at the following:

Linko EMC/RF Lab:

Tel: 886-2-26052180

Fax: 886-2-26051924

Hsin Chu EMC/RF/Telecom Lab:

Tel: 886-3-5935343

Fax: 886-3-5935342

Hwa Ya EMC/RF/Safety Lab:

Tel: 886-3-3183232

Fax: 886-3-3270892

Email: service.adt@tw.bureauveritas.com

Web Site: www.bureauveritas-adt.com

The address and road map of all our labs can be found in our web site also.

7. APPENDIX A - MODIFICATIONS RECORDERS FOR ENGINEERING CHANGES TO THE EUT BY THE LAB

No any modifications are made to the EUT by the lab during the test.

--- END ---