



FCC TEST REPORT (15.407)

REPORT NO.: RF150318C06-6
MODEL NO.: S50c
FCC ID: ZL5S50C
RECEIVED: Mar. 18, 2015
TESTED: Mar. 27, 2015 ~ Apr. 08, 2015
ISSUED: Apr. 21, 2015

APPLICANT: Bullitt Group

ADDRESS: No. 4, The Aquarium, King Street, Reading, RG1
2AN United Kingdom

ISSUED BY: Bureau Veritas Consumer Products Services
(H.K.) Ltd., Taoyuan Branch

LAB ADDRESS: No. 47-2, 14th Ling, Chia Pau Vil., Lin Kou Dist.,
New Taipei City, Taiwan (R.O.C)

TEST LOCATION: No. 19, Hwa Ya 2nd Rd, Wen Hwa Vil., Kwei
Shan Dist., Taoyuan City 333, Taiwan, R.O.C.

This report should not be used by the client to claim product certification, approval, or endorsement by TAF or any government agencies.



This report is for your exclusive use. Any copying or replication of this report to or for any other person or entity, or use of our name or trademark, is permitted only with our prior written permission. This report sets forth our findings solely with respect to the test samples identified herein. The results set forth in this report are not indicative or representative of the quality or characteristics of the lot from which a test sample was taken or any similar or identical product unless specifically and expressly noted. Our report includes all of the tests requested by you and the results thereof based upon the information that you provided to us. You have 60 days from date of issuance of this report to notify us of any material error or omission caused by our negligence, provided, however, that such notice shall be in writing and shall specifically address the issue you wish to raise. A failure to raise such issue within the prescribed time shall constitute your unqualified acceptance of the completeness of this report, the tests conducted and the correctness of the report contents. Unless specific mention, the uncertainty of measurement has been explicitly taken into account to declare the compliance or non-compliance to the specification.



TABLE OF CONTENTS

RELEASE CONTROL RECORD	4
1. CERTIFICATION.....	5
2. SUMMARY OF TEST RESULTS	6
2.1 MEASUREMENT UNCERTAINTY.....	6
3. GENERAL INFORMATION	7
3.1 GENERAL DESCRIPTION OF EUT	7
3.2 DESCRIPTION OF TEST MODES.....	9
3.2.1 TEST MODE APPLICABILITY AND TESTED CHANNEL DETAIL.....	11
3.3 DESCRIPTION OF SUPPORT UNITS.....	14
3.3.1 CONFIGURATION OF SYSTEM UNDER TEST	14
3.4 DUTY CYCLE TEST SIGNAL.....	15
3.5 GENERAL DESCRIPTION OF APPLIED STANDARDS.....	19
4. TEST TYPES AND RESULTS	20
4.1 RADIATED EMISSION AND BANDEDGE MEASUREMENT	20
4.1.1 LIMITS OF RADIATED EMISSION AND BANDEDGE MEASUREMENT	20
4.1.2 LIMITS OF UNWANTED EMISSION OUT OF THE RESTRICTED BANDS	20
4.1.3 TEST INSTRUMENTS.....	21
4.1.4 TEST PROCEDURES	22
4.1.5 DEVIATION FROM TEST STANDARD	22
4.1.6 TEST SETUP	23
4.1.7 EUT OPERATING CONDITIONS	23
4.1.8 TEST RESULTS.....	24
4.2 CONDUCTED EMISSION MEASUREMENT	61
4.2.1 LIMITS OF CONDUCTED EMISSION MEASUREMENT	61
4.2.2 TEST INSTRUMENTS.....	61
4.2.3 TEST PROCEDURES	62
4.2.4 DEVIATION FROM TEST STANDARD	62
4.2.5 TEST SETUP	63
4.2.6 EUT OPERATING CONDITIONS	63
4.2.7 TEST RESULTS.....	64
4.3 TRANSMIT POWER MEASUREMENT.....	68
4.3.1 LIMITS OF TRANSMIT POWER MEASUREMENT	68
4.3.2 TEST SETUP	68
4.3.3 TEST INSTRUMENTS.....	68
4.3.4 TEST PROCEDURE	69
4.3.5 DEVIATION FROM TEST STANDARD	69
4.3.6 EUT OPERATING CONDITIONS	69
4.3.7 TEST RESULTS.....	70
4.4 PEAK POWER SPECTRAL DENSITY MEASUREMENT	75
4.4.1 LIMITS OF PEAK POWER SPECTRAL DENSITY MEASUREMENT	75
4.4.2 TEST SETUP	75
4.4.3 TEST INSTRUMENTS.....	75
4.4.4 TEST PROCEDURES	76
4.4.5 DEVIATION FROM TEST STANDARD	76
4.4.6 EUT OPERATING CONDITIONS	76
4.4.7 TEST RESULTS.....	77
4.5 FREQUENCY STABILITY	81
4.5.1 LIMITS OF FREQUENCY STABILITY MEASUREMENT	81
4.5.2 TEST SETUP	81
4.5.3 TEST INSTRUMENTS.....	81
4.5.4 TEST PROCEDURE	82
4.5.5 DEVIATION FROM TEST STANDARD	82



A D T

4.5.6	EUT OPERATING CONDITION.....	82
4.5.7	TEST RESULTS.....	83
4.6	6dB BANDWIDTH MEASUREMENT	84
4.6.1	LIMITS OF 6dB BANDWIDTH MEASUREMENT	84
4.6.2	TEST SETUP	84
4.6.3	TEST INSTRUMENTS	84
4.6.4	TEST PROCEDURE	84
4.6.5	DEVIATION FROM TEST STANDARD	84
4.6.6	EUT OPERATING CONDITIONS	84
4.6.7	TEST RESULTS.....	85
5.	PHOTOGRAPHS OF THE TEST CONFIGURATION.....	87
6.	INFORMATION ON THE TESTING LABORATORIES	88
7.	APPENDIX A - MODIFICATIONS RECORDERS FOR ENGINEERING CHANGES TO THE EUT BY THE LAB	89



A D T

RELEASE CONTROL RECORD

ISSUE NO.	REASON FOR CHANGE	DATE ISSUED
RF150318C06-6	Original release	Apr. 21, 2015



1. CERTIFICATION

PRODUCT: Rugged Smart Phone
MODEL NO.: S50c
BRAND: CAT
APPLICANT: Bullitt Group
TESTED: Mar. 27, 2015 ~ Apr. 08, 2015
TEST SAMPLE: Identical Prototype
STANDARDS: **FCC Part 15, Subpart E (Section 15.407)**
ANSI C63.10-2013

The above equipment (model: S50c) has been tested by **Bureau Veritas Consumer Products Services (H.K.) Ltd., Taoyuan Branch**, and found compliance with the requirement of the above standards. The test record, data evaluation & Equipment Under Test (EUT) configurations represented herein are true and accurate accounts of the measurements of the sample's EMC characteristics under the conditions specified in this report.

PREPARED BY : Ivonne Wu , **DATE** : Apr. 21, 2015
Ivonne Wu / Supervisor

APPROVED BY : Sam Chen , **DATE** : Apr. 21, 2015
Sam Chen / Senior Project Engineer

2. SUMMARY OF TEST RESULTS

The EUT has been tested according to the following specifications:

APPLIED STANDARD: FCC PART 15, SUBPART E (SECTION 15.407)			
STANDARD SECTION	TEST TYPE	RESULT	REMARK
15.407(b)(6)	AC Power Conducted Emission	PASS	Meet the requirement of limit. Minimum passing margin is -5.19dB at 0.32595MHz.
15.407(b/1/2/3) (b)(6)	Radiated Emissions	PASS	Meet the requirement of limit. Minimum passing margin is -6.13dB at 5470.00MHz.
15.407(a/1/2/3)	Max Average Transmit Power	PASS	Meet the requirement of limit.
15.407(a/1/2/3)	Peak Power Spectral Density	PASS	Meet the requirement of limit.
15.407(e)	6dB bandwidth	PASS	Meet the requirement of limit. (U-NII-3 Band only)
15.407(g)	Frequency Stability	PASS	Meet the requirement of limit.
15.203	Antenna Requirement	PASS	No antenna connector is used.

2.1 MEASUREMENT UNCERTAINTY

Where relevant, the following measurement uncertainty levels have been estimated for tests performed on the EUT as specified in CISPR 16-4-2:

MEASUREMENT	FREQUENCY	UNCERTAINTY
Conducted emissions	9kHz~30MHz	2.44 dB
Radiated emissions	30MHz ~ 200MHz	2.93 dB
	200MHz ~1000MHz	2.95 dB
	1GHz ~ 18GHz	2.26 dB
	18GHz ~ 40GHz	1.94 dB

This uncertainty represents an expanded uncertainty expressed at approximately the 95% confidence level using a coverage factor of $k = 2$.

3. GENERAL INFORMATION

3.1 GENERAL DESCRIPTION OF EUT

EUT	Rugged Smart Phone
MODEL NO.	S50c
POWER SUPPLY	5.0Vdc (adapter or host equipment) 3.75Vdc (Li-ion battery)
MODULATION TYPE	64QAM, 16QAM, QPSK, BPSK
MODULATION TECHNOLOGY	OFDM
TRANSFER RATE	802.11a: 54.0/ 48.0/ 36.0/ 24.0/ 18.0/ 12.0/ 9.0/ 6.0Mbps 802.11n: up to MCS7
OPERATING FREQUENCY	5180 ~ 5240MHz, 5260 ~ 5320MHz, 5500 ~ 5700MHz, 5745 ~ 5825MHz
NUMBER OF CHANNEL	5180 ~ 5240MHz: 4 for 802.11a, 802.11n (20MHz) 2 for 802.11n (40MHz) 5260 ~ 5320MHz: 4 for 802.11a, 802.11n (20MHz) 2 for 802.11n (40MHz) 5500 ~ 5700MHz: 11 for 802.11a, 802.11n (20MHz) 5 for 802.11n (40MHz) 5745 ~ 5825MHz: 5 for 802.11a, 802.11n (20MHz) 2 for 802.11n (40MHz)
OUTPUT POWER	7.85mW for 5180 ~ 5240MHz 7.91mW for 5260 ~ 5320MHz 7.74mW for 5500 ~ 5700MHz 7.36mW for 5745 ~ 5825MHz
ANTENNA TYPE	PIFA antenna with 0.61dBi gain (5180 ~ 5240MHz) PIFA antenna with 0.61dBi gain (5260 ~ 5320MHz) PIFA antenna with 1.51dBi gain (5500 ~ 5700MHz) PIFA antenna with 1.35dBi gain (5745 ~ 5825MHz)
ANTENNA CONNECTOR	NA
DATA CABLE	Refer to Note as below
I/O PORTS	Refer to user's manual
ACCESSORY DEVICES	Refer to Note as below



A D T

NOTE:

1. The EUT contains following accessory devices.

ITEM	BRAND	MODEL	SPECIFICATION
Adapter	Liteon	PA-1050-05L3	I/P: 100-240Vac, 0.3A O/P: 5Vdc, 1A
Battery	Simplo Technology	A09TA008H	3.75Vdc, 2680Ah
USB Cable	BING CHUANG	BC-1.1M-AMCR5P	1m cable
LCD Panel	Truly	BTFTSZ0192	--
Photo Camera	Chicony	CBAE821	--
Video Camera	Chicony	CIFDF31-1	--
Main Board	AT&S	14H08	--
eMMC	Hynix	H26M41103HPR	8GB
CPU	Qualcomm	MSM 8926	Pin: 784

2. The above EUT information is declared by the manufacturer and for more detailed features description, please refer to the manufacturer's specifications or User's Manual.



A D T

3.2 DESCRIPTION OF TEST MODES

WLAN 5180 ~ 5240MHz

4 channels are provided for 802.11a, 802.11n (20MHz):

CHANNEL	FREQUENCY	CHANNEL	FREQUENCY
36	5180 MHz	44	5220 MHz
40	5200 MHz	48	5240 MHz

2 channels are provided for 802.11n (40MHz):

CHANNEL	FREQUENCY	CHANNEL	FREQUENCY
38	5190 MHz	46	5230 MHz

FOR 5260 ~ 5320MHz

4 channels are provided for 802.11a, 802.11n (20MHz):

CHANNEL	FREQUENCY	CHANNEL	FREQUENCY
52	5260 MHz	60	5300 MHz
56	5280 MHz	64	5320 MHz

2 channels are provided for 802.11n (40MHz):

CHANNEL	FREQUENCY	CHANNEL	FREQUENCY
54	5270 MHz	62	5310 MHz

1 channel is provided for 802.11ac (80MHz):

CHANNEL	FREQUENCY
58	5290MHz

WLAN 5500 ~ 5700MHz

11 channels are provided for 802.11a, 802.11n (20MHz):

CHANNEL	FREQUENCY	CHANNEL	FREQUENCY
100	5500MHz	124	5620MHz
104	5520MHz	128	5640MHz
108	5540MHz	132	5660MHz
112	5560MHz	136	5680MHz
116	5580MHz	140	5700MHz
120	5600MHz		

5 channels are provided for 802.11n (40MHz):

CHANNEL	FREQUENCY	CHANNEL	FREQUENCY
102	5510MHz	126	5630MHz
110	5550MHz	134	5670MHz
118	5590MHz		

FOR 5.0GHz (5745 ~ 5825MHz):

5 channels are provided for 802.11a, 802.11n (20MHz):

CHANNEL	FREQUENCY	CHANNEL	FREQUENCY
149	5745MHz	161	5805MHz
153	5765MHz	165	5825MHz
157	5785MHz		

2 channels are provided for 802.11n (40MHz):

CHANNEL	FREQUENCY	CHANNEL	FREQUENCY
151	5755MHz	159	5795MHz

3.2.1 TEST MODE APPLICABILITY AND TESTED CHANNEL DETAIL

EUT CONFIGURE MODE	APPLICABLE TO				DESCRIPTION
	RE \geq 1G	RE $<$ 1G	PLC	APCM	
A	√	√	√	√	EUT charged by adapter
B	-	-	√	-	EUT charged by wireless charger

Where **RE \geq 1G**: Radiated Emission above 1GHz **RE $<$ 1G**: Radiated Emission below 1GHz
PLC: Power Line Conducted Emission **APCM**: Antenna Port Conducted Measurement

NOTE: The EUT had been pre-tested on the positioned of each 3 axis. The worst case was found when positioned on **Z-plane**.

RADIATED EMISSION TEST (ABOVE 1GHz):

Pre-Scan has been conducted to determine the worst-case mode from all possible combinations between available modulations, data rates and antenna ports (if EUT with antenna diversity architecture).

Following channel(s) was (were) selected for the final test as listed below.

EUT CONFIGURE MODE	MODE	FREQ. BAND (MHz)	AVAILABLE CHANNEL	TESTED CHANNEL	MODULATION TECHNOLOGY	MODULATION TYPE	DATA RATE (Mbps)
A	802.11a	5180-5240	36 to 48	36, 44, 48	OFDM	BPSK	6.0
	802.11n (20MHz)		36 to 48	36, 44, 48	OFDM	BPSK	MCS0
	802.11n (40MHz)		38 to 46	38, 46	OFDM	BPSK	MCS0
	802.11a	5260-5320	52 to 64	52, 60, 64	OFDM	BPSK	6.0
	802.11n (20MHz)		52 to 64	52, 60, 64	OFDM	BPSK	MCS0
	802.11n (40MHz)		54 to 62	54, 62	OFDM	BPSK	MCS0
	802.11a	5500-5700	100 to 140	100, 116, 140	OFDM	BPSK	6.0
	802.11n (20MHz)		100 to 140	100, 116, 140	OFDM	BPSK	MCS0
	802.11n (40MHz)		102 to 134	102, 110, 134	OFDM	BPSK	MCS0
	802.11a	5745-5825	149 to 165	149, 157, 165	OFDM	BPSK	6.0
	802.11n (20MHz)		149 to 165	149, 157, 165	OFDM	BPSK	MCS0
	802.11n (40MHz)		151 to 159	151, 159	OFDM	BPSK	MCS0

RADIATED EMISSION TEST (BELOW 1GHz):

Pre-Scan has been conducted to determine the worst-case mode from all possible combinations between available modulations, data rates and antenna ports (if EUT with antenna diversity architecture).

Following channel(s) was (were) selected for the final test as listed below.

EUT CONFIGURE MODE	MODE	FREQ. BAND (MHz)	AVAILABLE CHANNEL	TESTED CHANNEL	MODULATION TECHNOLOGY	MODULATION TYPE	DATA RATE (Mbps)
A	802.11n (20MHz)	5180-5240	36 to 48	36	OFDM	BPSK	MCS0
	802.11n (20MHz)	5260-5320	52 to 64	64	OFDM	BPSK	MCS0
	802.11n (40MHz)	5500-5700	102 to 134	102, 110, 134	OFDM	BPSK	MCS0
	802.11n (20MHz)	5745-5825	149 to 165	149	OFDM	BPSK	MCS0



A D T

POWER LINE CONDUCTED EMISSION TEST:

EUT CONFIGURE MODE	MODE	FREQ. BAND (MHz)	AVAILABLE CHANNEL	TESTED CHANNEL	MODULATION TECHNOLOGY	MODULATION TYPE	DATA RATE (Mbps)
A, B	802.11n (40MHz)	5500-5700	102 to 134	102, 110, 134	OFDM	BPSK	MCS0

BANDEDGE MEASUREMENT:

Pre-Scan has been conducted to determine the worst-case mode from all possible combinations between available modulations, data rates and antenna ports (if EUT with antenna diversity architecture).

Following channel(s) was (were) selected for the final test as listed below.

EUT CONFIGURE MODE	MODE	FREQ. BAND (MHz)	AVAILABLE CHANNEL	TESTED CHANNEL	MODULATION TECHNOLOGY	MODULATION TYPE	DATA RATE (Mbps)
A	802.11a	5180-5240	36 to 48	36, 44, 48	OFDM	BPSK	6.0
	802.11n (20MHz)		36 to 48	36, 44, 48	OFDM	BPSK	MCS0
	802.11n (40MHz)		38 to 46	38, 46	OFDM	BPSK	MCS0
	802.11a	5260-5320	52 to 64	52, 60, 64	OFDM	BPSK	6.0
	802.11n (20MHz)		52 to 64	52, 60, 64	OFDM	BPSK	MCS0
	802.11n (40MHz)		54 to 62	54, 62	OFDM	BPSK	MCS0
	802.11a	5500-5700	100 to 140	100, 116, 140	OFDM	BPSK	6.0
	802.11n (20MHz)		100 to 140	100, 116, 140	OFDM	BPSK	MCS0
	802.11n (40MHz)		102 to 134	102, 110, 134	OFDM	BPSK	MCS0
	802.11a	5745-5825	149 to 165	149, 157, 165	OFDM	BPSK	6.0
	802.11n (20MHz)		149 to 165	149, 157, 165	OFDM	BPSK	MCS0
	802.11n (40MHz)		151 to 159	151, 159	OFDM	BPSK	MCS0



A D T

ANTENNA PORT CONDUCTED MEASUREMENT:

- This item includes all test value of each mode, but only includes spectrum plot of worst value of each mode.
- Pre-Scan has been conducted to determine the worst-case mode from all possible combinations between available modulations, data rates and antenna ports (if EUT with antenna diversity architecture).
- Following channel(s) was (were) selected for the final test as listed below.

EUT CONFIGURE MODE	MODE	FREQ. BAND (MHz)	AVAILABLE CHANNEL	TESTED CHANNEL	MODULATION TECHNOLOGY	MODULATION TYPE	DATA RATE (Mbps)
A	802.11a	5180-5240	36 to 48	36, 44, 48	OFDM	BPSK	6.0
	802.11n (20MHz)		36 to 48	36, 44, 48	OFDM	BPSK	MCS0
	802.11n (40MHz)		38 to 46	38, 46	OFDM	BPSK	MCS0
	802.11a	5260-5320	52 to 64	52, 60, 64	OFDM	BPSK	6.0
	802.11n (20MHz)		52 to 64	52, 60, 64	OFDM	BPSK	MCS0
	802.11n (40MHz)		54 to 62	54, 62	OFDM	BPSK	MCS0
	802.11a	5500-5700	100 to 140	100, 116, 140	OFDM	BPSK	6.0
	802.11n (20MHz)		100 to 140	100, 116, 140	OFDM	BPSK	MCS0
	802.11n (40MHz)		102 to 134	102, 110, 134	OFDM	BPSK	MCS0
	802.11a	5745-5825	149 to 165	149, 157, 165	OFDM	BPSK	6.0
	802.11n (20MHz)		149 to 165	149, 157, 165	OFDM	BPSK	MCS0
	802.11n (40MHz)		151 to 159	151, 159	OFDM	BPSK	MCS0

TEST CONDITION:

APPLICABLE TO	ENVIRONMENTAL CONDITIONS	INPUT POWER	TESTED BY
RE≥1G	25deg. C, 65%RH	120Vac, 60Hz	Will Chen
RE<1G	25deg. C, 65%RH	120Vac, 60Hz	Will Chen
PLC	25deg. C, 65%RH	120Vac, 60Hz	Anson Lin
APCM	25deg. C, 65%RH	120Vac, 60Hz	Howard Kao

3.3 DESCRIPTION OF SUPPORT UNITS

The EUT has been tested as an independent unit together with other necessary accessories or support units. The following support units or accessories were used to form a representative test configuration during the tests.

NO.	PRODUCT	BRAND	MODEL NO.	SERIAL NO.	FCC ID
1	Earphone	Funkey	N/A	N/A	N/A
2	Wireless Charger	Engrgizer	IC 2B	N/A	N/A

NO.	SIGNAL CABLE DESCRIPTION OF THE ABOVE SUPPORT UNITS
1	N/A
2	N/A

NOTE: 1. All power cords of the above support units are non shielded (1.8m).

3.3.1 CONFIGURATION OF SYSTEM UNDER TEST

<EUT charged by adapter>

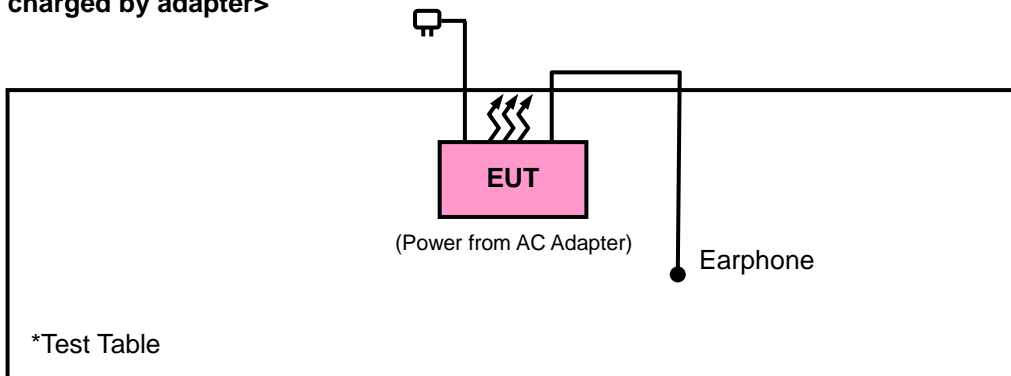

<EUT charged by wireless charger>

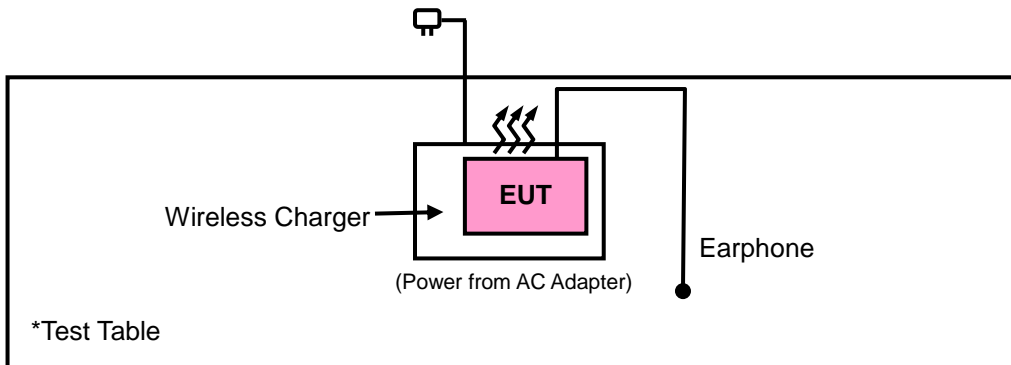



A D T

3.4 DUTY CYCLE TEST SIGNAL

MODULATION TYPE: BPSK

If duty cycle is < 98%, duty factor shall be considered.

802.11a: Duty cycle = 1.360/1.568 = 0.867, Duty factor = $10 * \log(1/0.867) = 0.62$

802.11n (20MHz): Duty cycle = 1.271/1.480 = 0.859, Duty factor = $10 * \log(1/0.859) = 0.66$

802.11n (40MHz): Duty cycle = 606.41/838.78 = 0.723, Duty factor = $10 * \log(1/0.723) = 1.41$

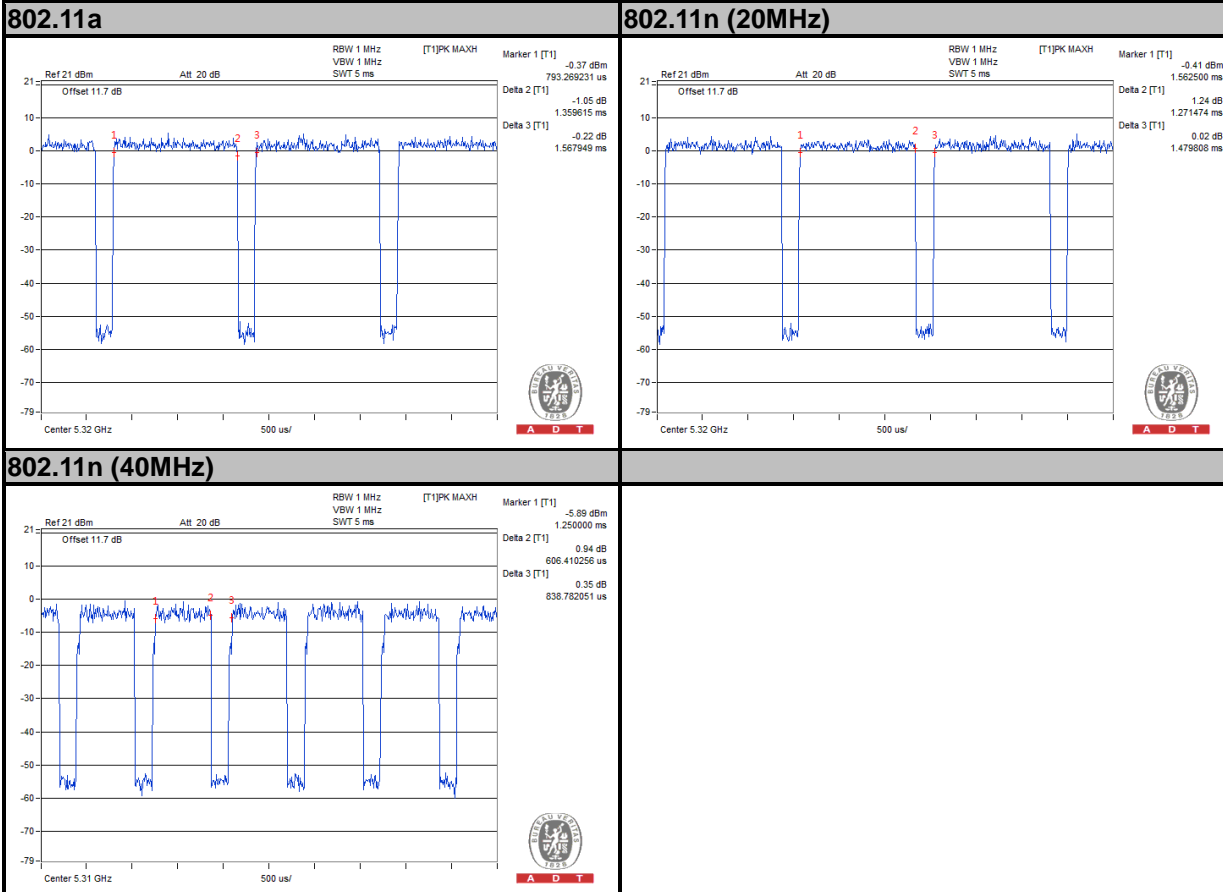



A D T

MODULATION TYPE: QPSK

If duty cycle is < 98%, duty factor shall be considered.

802.11a: Duty cycle = 689.10/889.42 = 0.775, Duty factor = 10 * log(1/0.775) = 1.11

802.11n (20MHz): Duty cycle = 650.64/858.97 = 0.757, Duty factor = 10 * log(1/0.757) = 1.21

802.11n (40MHz): Duty cycle = 306.09/535.26 = 0.572, Duty factor = 10 * log(1/0.572) = 2.43

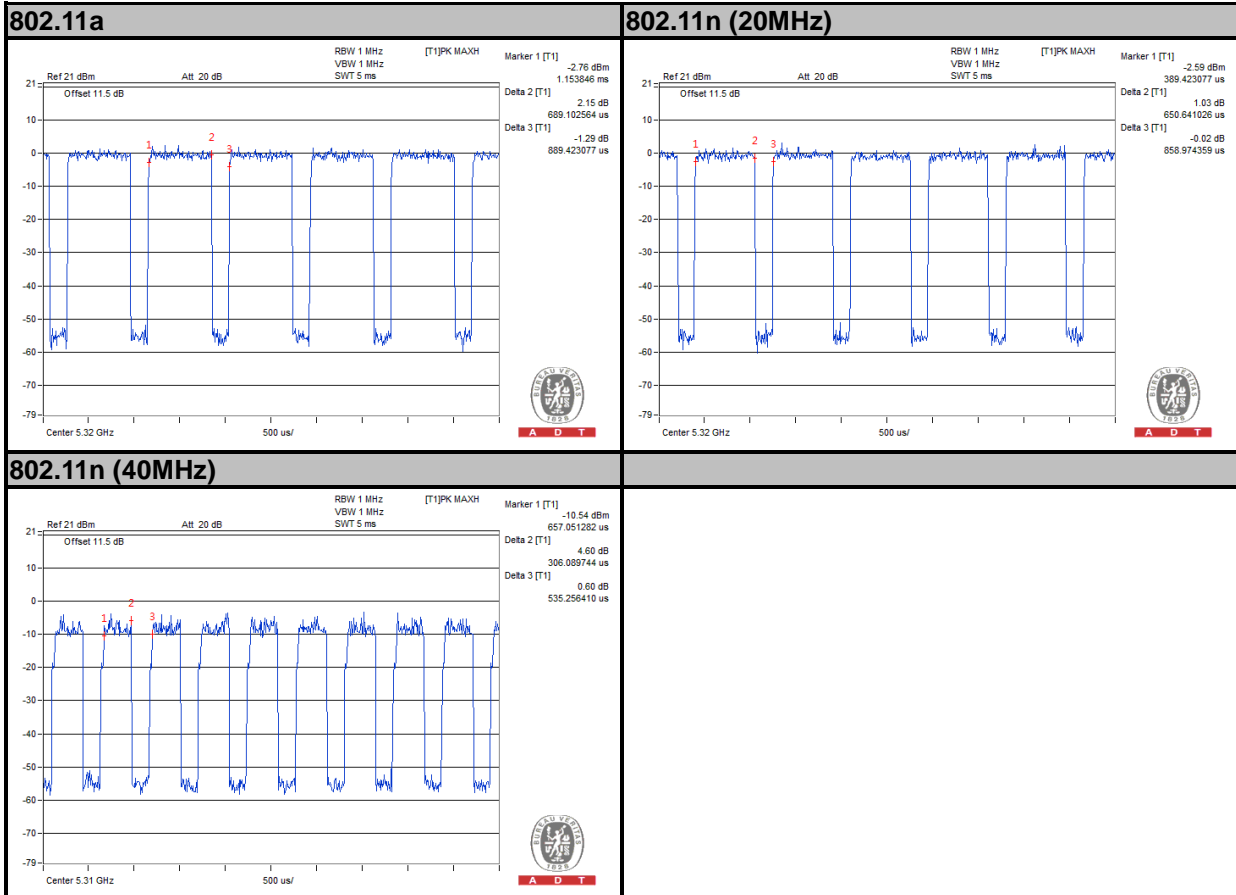



A D T

MODULATION TYPE: 16QAM

If duty cycle is < 98%, duty factor shall be considered.

802.11a: Duty cycle = $344.55/552.88 = 0.623$, Duty factor = $10 * \log(1/0.623) = 2.06$

802.11n (20MHz): Duty cycle = $338.14/548.08 = 0.617$, Duty factor = $10 * \log(1/0.617) = 2.10$

802.11n (40MHz): Duty cycle = $155.45/387.82 = 0.401$, Duty factor = $10 * \log(1/0.401) = 3.97$





A D T

MODULATION TYPE: 64QAM

If duty cycle is < 98%, duty factor shall be considered.

802.11a: Duty cycle = 177.88/386.22 = 0.461, Duty factor = 10 * log(1/0.461) = 3.36

802.11n (20MHz): Duty cycle = 185.90/391.03 = 0.475, Duty factor = 10 * log(1/0.475) = 3.23

802.11n (40MHz): Duty cycle = 110.58/314.10 = 0.352, Duty factor = 10 * log(1/0.352) = 4.53

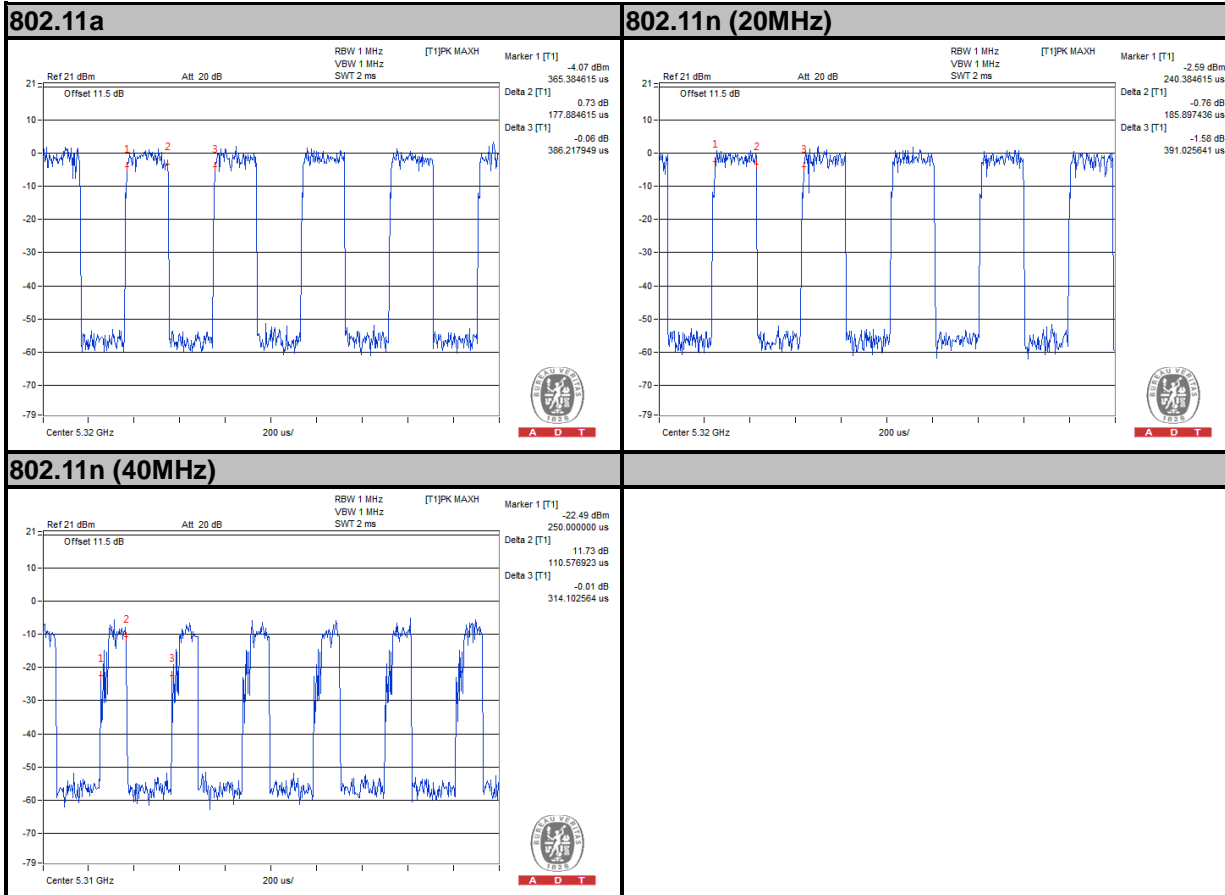



A D T

3.5 GENERAL DESCRIPTION OF APPLIED STANDARDS

The EUT is a RF Product. According to the specifications of the manufacturer, it must comply with the requirements of the following standards:

FCC Part 15, Subpart E (15.407)

789033 D02 General UNII Test Procedures New Rules v01

ANSI C63.10-2013

All test items have been performed and recorded as per the above standards.

NOTE: The EUT has been verified to comply with the requirements of FCC Part 15, Subpart B, Class B (DoC). The test report has been issued separately.

4. TEST TYPES AND RESULTS

4.1 RADIATED EMISSION AND BANDEDGE MEASUREMENT

4.1.1 LIMITS OF RADIATED EMISSION AND BANDEDGE MEASUREMENT

Radiated emissions which fall in the restricted bands must comply with the radiated emission limits specified as below table:

FREQUENCIES (MHz)	FIELD STRENGTH (microvolts/meter)	MEASUREMENT DISTANCE (meters)
0.009 ~ 0.490	2400/F(kHz)	300
0.490 ~ 1.705	24000/F(kHz)	30
1.705 ~ 30.0	30	30
30 ~ 88	100	3
88 ~ 216	150	3
216 ~ 960	200	3
Above 960	500	3

NOTE:

1. The lower limit shall apply at the transition frequencies.
2. Emission level (dBuV/m) = 20 log Emission level (uV/m).
3. For frequencies above 1000MHz, the field strength limits are based on average detector, however, the peak field strength of any emission shall not exceed the maximum permitted average limits, specified above by more than 20dB under any condition of modulation.

4.1.2 LIMITS OF UNWANTED EMISSION OUT OF THE RESTRICTED BANDS

APPLICABLE TO	LIMIT	
789033 D02 General UNII Test Procedures New Rules v01	FIELD STRENGTH AT 3m	
	PK: 74 (dBµV/m)	AV: 54 (dBµV/m)
APPLICABLE TO	EIRP LIMIT	EQUIVALENT FIELD STRENGTH AT 3m
15.407(b)(1)	PK: -27 (dBm/MHz)	PK: 68.2 (dBµV/m)
15.407(b)(2)		
15.407(b)(3)		
15.407(b)(4)	PK: -27 (dBm/MHz) ^{*1} PK: -17 (dBm/MHz) ^{*2}	PK: 68.2 (dBµV/m) ^{*1} PK: 78.2 (dBµV/m) ^{*2}

NOTE: ^{*1} beyond 10MHz of the band edge ^{*2} within 10 MHz of band edge

The following formula is used to convert the equipment isotropic radiated power (eirp) to field strength:

$$E = \frac{1000000\sqrt{30P}}{3} \mu\text{V/m, where P is the eirp (Watts).}$$



A D T

4.1.3 TEST INSTRUMENTS

DESCRIPTION & MANUFACTURER	MODEL NO.	SERIAL NO.	DATE OF CALIBRATION	DUE DATE OF CALIBRATION
Test Receiver Agilent	N9038A	MY51210203	Jan. 21, 2015	Jan. 21, 2016
Spectrum Analyzer Agilent	N9010A	MY52220314	Sep. 03, 2014	Sep. 02, 2015
Spectrum Analyzer ROHDE & SCHWARZ	FSU43	101261	Dec. 10, 2014	Dec. 09, 2015
BILOG Antenna SCHWARZBECK	VULB9168	9168-472	Feb. 04, 2015	Feb. 04, 2016
HORN Antenna SCHWARZBECK	BBHA 9120 D	9120D-969	Feb. 09, 2015	Feb. 09, 2016
HORN Antenna SCHWARZBECK	BBHA 9170	9170-480	Feb. 04, 2015	Feb. 04, 2016
Loop Antenna	EM-6879	269	Aug. 13, 2014	Aug. 12, 2015
Preamplifier EMCI	EMC 012645	980115	Dec. 12, 2014	Dec. 11, 2015
Preamplifier EMCI	EMC 184045	980116	Jan. 09, 2015	Jan. 08, 2016
Preamplifier EMCI	EMC 330H	980112	Dec. 27, 2014	Dec. 26, 2015
Power Meter Anritsu	ML2495A	1232002	Sep. 17, 2014	Sep. 16, 2015
Power Sensor Anritsu	MA2411B	1207325	Sep. 17, 2014	Sep. 16, 2015
RF signal cable HUBER+SUHNNER	SUCOFLEX 104	309219/4 2950114	Oct. 18, 2014	Oct. 17, 2015
RF signal cable HUBER+SUHNNER	SUCOFLEX 104	250130/4	Oct. 18, 2014	Oct. 17, 2015
RF Coaxial Cable Worken	8D-FB	Cable-Ch10-01	Nov. 07, 2014	Nov. 06, 2015
Software BV ADT	E3 6.120103	NA	NA	NA
Antenna Tower MF	MFA-440H	NA	NA	NA
Turn Table MF	MFT-201SS	NA	NA	NA
Antenna Tower & Turn Table Controller MF	MF-7802	NA	NA	NA
Bluetooth Tester	CBT	100980	Apr. 18, 2013	Apr. 17, 2015

NOTE: 1. The calibration interval of the above test instruments is 12 months and the calibrations are traceable to NML/ROC and NIST/USA.

2. The test was performed in HwaYa Chamber 10.

3. The horn antenna and HP preamplifier (model: 8449B) are used only for the measurement of emission frequency above 1GHz if tested.

4. The FCC Site Registration No. is 690701.

5. The IC Site Registration No. is IC 7450F-10.

4.1.4 TEST PROCEDURES

- a. The EUT was placed on the top of a rotating table 0.8 meters (for below 1GHz) / 1.5 meters (for above 1GHz) above the ground at 3 meter chamber room for test. The table was rotated 360 degrees to determine the position of the highest radiation.
- b. The EUT was set 3 meters away from the interference-receiving antenna, which was mounted on the top of a variable-height antenna tower.
- c. The antenna is a broadband antenna, and its height is varied from one meter to four meters above the ground to determine the maximum value of the field strength. Both horizontal and vertical polarizations of the antenna are set to make the measurement.
- d. For each suspected emission, the EUT was arranged to its worst case and then the antenna was tuned to heights from 1 meter to 4 meters and the rotatable table was turned from 0 degrees to 360 degrees to find the maximum reading.
- e. The test-receiver system was set to Peak Detect Function and Specified Bandwidth with Maximum Hold Mode.
- f. If the emission level of the EUT in peak mode was 10dB lower than the limit specified, then testing could be stopped and the peak values of the EUT would be reported. Otherwise the emissions that did not have 10dB margin would be re-tested one by one using peak, quasi-peak or average method as specified and then reported in a data sheet.

NOTE:

1. The resolution bandwidth and video bandwidth of test receiver/spectrum analyzer is 120kHz for Peak detection (PK) and Quasi-peak detection (QP) at frequency below 1GHz.
2. The resolution bandwidth of test receiver/spectrum analyzer is 1MHz and video bandwidth is 3MHz for Peak detection at frequency above 1GHz.
3. The resolution bandwidth of test receiver/spectrum analyzer is 1MHz and the video bandwidth is 1kHz (Duty cycle < 98%) or 10Hz (Duty cycle > 98%) for Average detection (AV) at frequency above 1GHz.
4. All modes of operation were investigated and the worst-case emissions are reported.

4.1.5 DEVIATION FROM TEST STANDARD

No deviation.

4.1.6 TEST SETUP

<Frequency Range 30MHz ~ 1GHz>

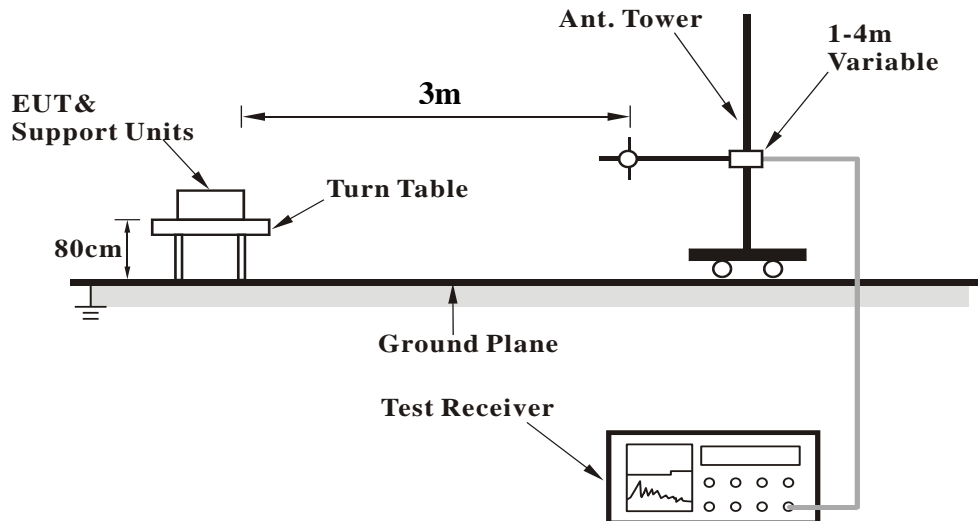

<Frequency Range above 1GHz>

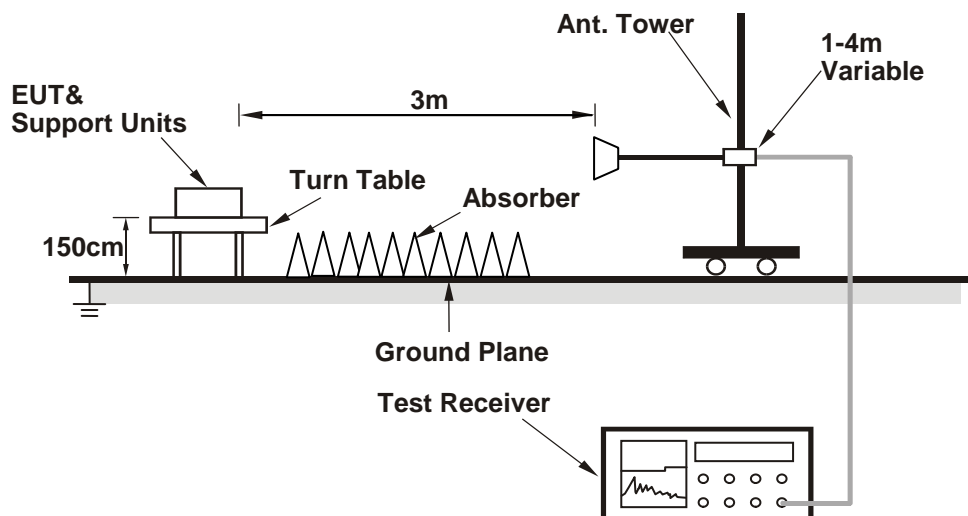

For the actual test configuration, please refer to the attached file (Test Setup Photo).

4.1.7 EUT OPERATING CONDITIONS

- Placed the EUT on a testing table.
- Use the software to control the EUT under transmission condition continuously at specific channel frequency.



A D T

4.1.8 TEST RESULTS

ABOVE 1GHz WORST-CASE DATA

802.11a

EUT TEST CONDITION		MEASUREMENT DETAIL	
CHANNEL	Channel 36	FREQUENCY RANGE	1GHz ~ 40GHz
INPUT POWER	120Vac, 60 Hz	DETECTOR FUNCTION	Peak (PK) Average (AV)
ENVIRONMENTAL CONDITIONS	25deg. C, 65%RH	TESTED BY	Will Chen

ANTENNA POLARITY & TEST DISTANCE: HORIZONTAL AT 3 M

FREQ. (MHz)	EMISSION LEVEL (dBuV/m)	READ LEVEL (dBuV)	LIMIT (dBuV/m)	MARGIN (dB)	ANTENNA FACTOR (dB/m)	CABLE LOSS (dB)	PREAMP FACTOR (dB)	ANTENNA HEIGHT (cm)	TABLE ANGLE (Degree)	REMARK
5084	44.8	36.64	54	-9.2	34.07	8.07	33.98	200	301	Average
5084	58.47	50.31	74	-15.53	34.07	8.07	33.98	200	301	Peak
5180	96.71	88.4			34.15	8.16	34	200	301	Average
5180	105.24	96.93			34.15	8.16	34	200	301	Peak
5456	43.1	34.28	54	-10.9	34.36	8.51	34.05	200	301	Average
5456	57.22	48.4	74	-16.78	34.36	8.51	34.05	200	301	Peak

ANTENNA POLARITY & TEST DISTANCE: VERTICAL AT 3 M

FREQ. (MHz)	EMISSION LEVEL (dBuV/m)	READ LEVEL (dBuV)	LIMIT (dBuV/m)	MARGIN (dB)	ANTENNA FACTOR (dB/m)	CABLE LOSS (dB)	PREAMP FACTOR (dB)	ANTENNA HEIGHT (cm)	TABLE ANGLE (Degree)	REMARK
5126	44.9	36.68	54	-9.1	34.11	8.1	33.99	175	244	Average
5126	57.8	49.58	74	-16.2	34.11	8.1	33.99	175	244	Peak
5180	99.61	91.3			34.15	8.16	34	175	244	Average
5180	107.97	99.66			34.15	8.16	34	175	244	Peak
5460	43.15	34.33	54	-10.85	34.36	8.51	34.05	175	244	Average
5460	57.23	48.41	74	-16.77	34.36	8.51	34.05	175	244	Peak

REMARKS:

- Emission Level = Read Level + Antenna Factor + Cable Loss - Preamp Factor
Margin value = Emission level – Limit value
- 5180MHz: Fundamental frequency.



A D T

EUT TEST CONDITION		MEASUREMENT DETAIL	
CHANNEL	Channel 44	FREQUENCY RANGE	1GHz ~ 40GHz
INPUT POWER	120Vac, 60 Hz	DETECTOR FUNCTION	Peak (PK) Average (AV)
ENVIRONMENTAL CONDITIONS	25deg. C, 65%RH	TESTED BY	Will Chen

ANTENNA POLARITY & TEST DISTANCE: HORIZONTAL AT 3 M										
FREQ. (MHz)	EMISSION LEVEL (dBuV/m)	READ LEVEL (dBuV)	LIMIT (dBuV/m)	MARGIN (dB)	ANTENNA FACTOR (dB/m)	CABLE LOSS (dB)	PREAMP FACTOR (dB)	ANTENNA HEIGHT (cm)	TABLE ANGLE (Degree)	REMARK
5090	42.79	34.62	54	-11.21	34.08	8.07	33.98	200	301	Average
5090	56.59	48.42	74	-17.41	34.08	8.07	33.98	200	301	Peak
5220	98.19	89.8			34.17	8.22	34	200	301	Average
5220	105.74	97.35			34.17	8.22	34	200	301	Peak
5400	43.05	34.33	54	-10.95	34.32	8.44	34.04	200	301	Average
5400	57.11	48.39	74	-16.89	34.32	8.44	34.04	200	301	Peak
ANTENNA POLARITY & TEST DISTANCE: VERTICAL AT 3 M										
FREQ. (MHz)	EMISSION LEVEL (dBuV/m)	READ LEVEL (dBuV)	LIMIT (dBuV/m)	MARGIN (dB)	ANTENNA FACTOR (dB/m)	CABLE LOSS (dB)	PREAMP FACTOR (dB)	ANTENNA HEIGHT (cm)	TABLE ANGLE (Degree)	REMARK
5048	42.76	34.7	54	-11.24	34.04	8	33.98	176	233	Average
5048	57.23	49.17	74	-16.77	34.04	8	33.98	176	233	Peak
5220	99.5	91.11			34.17	8.22	34	176	233	Average
5220	107.43	99.04			34.17	8.22	34	176	233	Peak
5380	42.98	34.3	54	-11.02	34.31	8.41	34.04	176	233	Average
5380	56.94	48.26	74	-17.06	34.31	8.41	34.04	176	233	Peak

REMARKS:

- Emission Level = Read Level + Antenna Factor + Cable Loss - Preamp Factor
Margin value = Emission level – Limit value
- 5220MHz: Fundamental frequency.



A D T

EUT TEST CONDITION		MEASUREMENT DETAIL	
CHANNEL	Channel 48	FREQUENCY RANGE	1GHz ~ 40GHz
INPUT POWER	120Vac, 60 Hz	DETECTOR FUNCTION	Peak (PK) Average (AV)
ENVIRONMENTAL CONDITIONS	25deg. C, 65%RH	TESTED BY	Will Chen

ANTENNA POLARITY & TEST DISTANCE: HORIZONTAL AT 3 M										
FREQ. (MHz)	EMISSION LEVEL (dBuV/m)	READ LEVEL (dBuV)	LIMIT (dBuV/m)	MARGIN (dB)	ANTENNA FACTOR (dB/m)	CABLE LOSS (dB)	PREAMP FACTOR (dB)	ANTENNA HEIGHT (cm)	TABLE ANGLE (Degree)	REMARK
5132	42.9	34.68	54	-11.1	34.11	8.1	33.99	189	302	Average
5132	57.47	49.25	74	-16.53	34.11	8.1	33.99	189	302	Peak
5240	97.84	89.4			34.19	8.26	34.01	189	302	Average
5240	105.44	97			34.19	8.26	34.01	189	302	Peak
5434	43.06	34.27	54	-10.94	34.35	8.48	34.04	189	302	Average
5434	57.5	48.71	74	-16.5	34.35	8.48	34.04	189	302	Peak
ANTENNA POLARITY & TEST DISTANCE: VERTICAL AT 3 M										
FREQ. (MHz)	EMISSION LEVEL (dBuV/m)	READ LEVEL (dBuV)	LIMIT (dBuV/m)	MARGIN (dB)	ANTENNA FACTOR (dB/m)	CABLE LOSS (dB)	PREAMP FACTOR (dB)	ANTENNA HEIGHT (cm)	TABLE ANGLE (Degree)	REMARK
5102	42.73	34.57	54	-11.27	34.08	8.07	33.99	167	234	Average
5102	57.35	49.19	74	-16.65	34.08	8.07	33.99	167	234	Peak
5240	99.34	90.9			34.19	8.26	34.01	167	234	Average
5240	107.21	98.77			34.19	8.26	34.01	167	234	Peak
5370	42.98	34.31	54	-11.02	34.29	8.41	34.03	167	234	Average
5370	57.69	49.02	74	-16.31	34.29	8.41	34.03	167	234	Peak

REMARKS:

- Emission Level = Read Level + Antenna Factor + Cable Loss - Preamp Factor
Margin value = Emission level – Limit value
- 5240MHz: Fundamental frequency.



A D T

EUT TEST CONDITION		MEASUREMENT DETAIL	
CHANNEL	Channel 52	FREQUENCY RANGE	1GHz ~ 40GHz
INPUT POWER	120Vac, 60 Hz	DETECTOR FUNCTION	Peak (PK) Average (AV)
ENVIRONMENTAL CONDITIONS	25deg. C, 65%RH	TESTED BY	Will Chen

ANTENNA POLARITY & TEST DISTANCE: HORIZONTAL AT 3 M										
FREQ. (MHz)	EMISSION LEVEL (dBuV/m)	READ LEVEL (dBuV)	LIMIT (dBuV/m)	MARGIN (dB)	ANTENNA FACTOR (dB/m)	CABLE LOSS (dB)	PREAMP FACTOR (dB)	ANTENNA HEIGHT (cm)	TABLE ANGLE (Degree)	REMARK
5102	42.8	34.64	54	-11.2	34.08	8.07	33.99	200	309	Average
5102	57.96	49.8	74	-16.04	34.08	8.07	33.99	200	309	Peak
5260	97.37	88.91			34.21	8.26	34.01	200	309	Average
5260	105.26	96.8			34.21	8.26	34.01	200	309	Peak
5450	43.15	34.33	54	-10.85	34.36	8.51	34.05	200	309	Average
5450	57.52	48.7	74	-16.48	34.36	8.51	34.05	200	309	Peak
ANTENNA POLARITY & TEST DISTANCE: VERTICAL AT 3 M										
FREQ. (MHz)	EMISSION LEVEL (dBuV/m)	READ LEVEL (dBuV)	LIMIT (dBuV/m)	MARGIN (dB)	ANTENNA FACTOR (dB/m)	CABLE LOSS (dB)	PREAMP FACTOR (dB)	ANTENNA HEIGHT (cm)	TABLE ANGLE (Degree)	REMARK
5092	42.81	34.64	54	-11.19	34.08	8.07	33.98	100	252	Average
5092	58.07	49.9	74	-15.93	34.08	8.07	33.98	100	252	Peak
5260	98.97	90.51			34.21	8.26	34.01	100	252	Average
5260	107.01	98.55			34.21	8.26	34.01	100	252	Peak
5444	43.06	34.27	54	-10.94	34.35	8.48	34.04	100	252	Average
5444	57.49	48.7	74	-16.51	34.35	8.48	34.04	100	252	Peak

REMARKS:

- Emission Level = Read Level + Antenna Factor + Cable Loss - Preamp Factor
Margin value = Emission level – Limit value
- 5260MHz: Fundamental frequency.



A D T

EUT TEST CONDITION		MEASUREMENT DETAIL	
CHANNEL	Channel 60	FREQUENCY RANGE	1GHz ~ 40GHz
INPUT POWER	120Vac, 60 Hz	DETECTOR FUNCTION	Peak (PK) Average (AV)
ENVIRONMENTAL CONDITIONS	25deg. C, 65%RH	TESTED BY	Will Chen

ANTENNA POLARITY & TEST DISTANCE: HORIZONTAL AT 3 M										
FREQ. (MHz)	EMISSION LEVEL (dBuV/m)	READ LEVEL (dBuV)	LIMIT (dBuV/m)	MARGIN (dB)	ANTENNA FACTOR (dB/m)	CABLE LOSS (dB)	PREAMP FACTOR (dB)	ANTENNA HEIGHT (cm)	TABLE ANGLE (Degree)	REMARK
5048	42.71	34.65	54	-11.29	34.04	8	33.98	204	307	Average
5048	57.2	49.14	74	-16.8	34.04	8	33.98	204	307	Peak
5300	97.74	89.2			34.24	8.32	34.02	204	307	Average
5300	105.74	97.2			34.24	8.32	34.02	204	307	Peak
5374	44.77	36.11	54	-9.23	34.29	8.41	34.04	204	307	Average
5374	58.36	49.7	74	-15.64	34.29	8.41	34.04	204	307	Peak
ANTENNA POLARITY & TEST DISTANCE: VERTICAL AT 3 M										
FREQ. (MHz)	EMISSION LEVEL (dBuV/m)	READ LEVEL (dBuV)	LIMIT (dBuV/m)	MARGIN (dB)	ANTENNA FACTOR (dB/m)	CABLE LOSS (dB)	PREAMP FACTOR (dB)	ANTENNA HEIGHT (cm)	TABLE ANGLE (Degree)	REMARK
5028	42.61	34.58	54	-11.39	34.03	7.97	33.97	100	252	Average
5028	57.13	49.1	74	-16.87	34.03	7.97	33.97	100	252	Peak
5300	99.38	90.84			34.24	8.32	34.02	100	252	Average
5300	107.22	98.68			34.24	8.32	34.02	100	252	Peak
5368	44.6	35.93	54	-9.4	34.29	8.41	34.03	100	252	Average
5368	58.04	49.37	74	-15.96	34.29	8.41	34.03	100	252	Peak

REMARKS:

- Emission Level = Read Level + Antenna Factor + Cable Loss - Preamp Factor
Margin value = Emission level – Limit value
- 5300MHz: Fundamental frequency.



A D T

EUT TEST CONDITION		MEASUREMENT DETAIL	
CHANNEL	Channel 64	FREQUENCY RANGE	1GHz ~ 40GHz
INPUT POWER	120Vac, 60 Hz	DETECTOR FUNCTION	Peak (PK) Average (AV)
ENVIRONMENTAL CONDITIONS	25deg. C, 65%RH	TESTED BY	Will Chen

ANTENNA POLARITY & TEST DISTANCE: HORIZONTAL AT 3 M										
FREQ. (MHz)	EMISSION LEVEL (dBuV/m)	READ LEVEL (dBuV)	LIMIT (dBuV/m)	MARGIN (dB)	ANTENNA FACTOR (dB/m)	CABLE LOSS (dB)	PREAMP FACTOR (dB)	ANTENNA HEIGHT (cm)	TABLE ANGLE (Degree)	REMARK
5142	42.9	34.64	54	-11.1	34.12	8.13	33.99	202	309	Average
5142	57.39	49.13	74	-16.61	34.12	8.13	33.99	202	309	Peak
5320	97.95	89.37			34.25	8.35	34.02	202	309	Average
5320	105.79	97.21			34.25	8.35	34.02	202	309	Peak
5410	44.82	36.1	54	-9.18	34.32	8.44	34.04	202	309	Average
5410	57.73	49.01	74	-16.27	34.32	8.44	34.04	202	309	Peak
ANTENNA POLARITY & TEST DISTANCE: VERTICAL AT 3 M										
FREQ. (MHz)	EMISSION LEVEL (dBuV/m)	READ LEVEL (dBuV)	LIMIT (dBuV/m)	MARGIN (dB)	ANTENNA FACTOR (dB/m)	CABLE LOSS (dB)	PREAMP FACTOR (dB)	ANTENNA HEIGHT (cm)	TABLE ANGLE (Degree)	REMARK
5060	42.72	34.62	54	-11.28	34.05	8.03	33.98	105	254	Average
5060	57.77	49.67	74	-16.23	34.05	8.03	33.98	105	254	Peak
5320	99	90.42			34.25	8.35	34.02	105	254	Average
5320	107.41	98.83			34.25	8.35	34.02	105	254	Peak
5436	45.43	36.64	54	-8.57	34.35	8.48	34.04	105	254	Average
5436	58.13	49.34	74	-15.87	34.35	8.48	34.04	105	254	Peak

REMARKS:

- Emission Level = Read Level + Antenna Factor + Cable Loss - Preamp Factor
Margin value = Emission level – Limit value
- 5320MHz: Fundamental frequency.



A D T

EUT TEST CONDITION		MEASUREMENT DETAIL	
CHANNEL	Channel 100	FREQUENCY RANGE	1GHz ~ 40GHz
INPUT POWER	120Vac, 60 Hz	DETECTOR FUNCTION	Peak (PK) Average (AV)
ENVIRONMENTAL CONDITIONS	25deg. C, 65%RH	TESTED BY	Will Chen

ANTENNA POLARITY & TEST DISTANCE: HORIZONTAL AT 3 M										
FREQ. (MHz)	EMISSION LEVEL (dBuV/m)	READ LEVEL (dBuV)	LIMIT (dBuV/m)	MARGIN (dB)	ANTENNA FACTOR (dB/m)	CABLE LOSS (dB)	PREAMP FACTOR (dB)	ANTENNA HEIGHT (cm)	TABLE ANGLE (Degree)	REMARK
5402	44.08	35.36	54	-9.92	34.32	8.44	34.04	184	326	Average
5402	57.26	48.54	74	-16.74	34.32	8.44	34.04	184	326	Peak
5470	55.9	47.07	68.2	-12.3	34.37	8.51	34.05	184	326	Peak
5500	97.08	88.16			34.4	8.57	34.05	184	326	Average
5500	105.36	96.44			34.4	8.57	34.05	184	326	Peak
5725	56.71	47.55	68.2	-11.49	34.62	8.65	34.11	184	326	Peak
ANTENNA POLARITY & TEST DISTANCE: VERTICAL AT 3 M										
FREQ. (MHz)	EMISSION LEVEL (dBuV/m)	READ LEVEL (dBuV)	LIMIT (dBuV/m)	MARGIN (dB)	ANTENNA FACTOR (dB/m)	CABLE LOSS (dB)	PREAMP FACTOR (dB)	ANTENNA HEIGHT (cm)	TABLE ANGLE (Degree)	REMARK
5460	45.87	37.05	54	-8.13	34.36	8.51	34.05	171	234	Average
5460	58.03	49.21	74	-15.97	34.36	8.51	34.05	171	234	Peak
5470	56.85	48.02	68.2	-11.35	34.37	8.51	34.05	171	234	Peak
5500	100.07	91.15			34.4	8.57	34.05	171	234	Average
5500	107.63	98.71			34.4	8.57	34.05	171	234	Peak
5725	57.52	48.36	68.2	-10.68	34.62	8.65	34.11	171	234	Peak

REMARKS:

- Emission Level = Read Level + Antenna Factor + Cable Loss - Preamp Factor
Margin value = Emission level – Limit value
- 5500MHz: Fundamental frequency.
- 5470MHz & 5725MHz: Out of restricted band



A D T

EUT TEST CONDITION		MEASUREMENT DETAIL	
CHANNEL	Channel 116	FREQUENCY RANGE	1GHz ~ 40GHz
INPUT POWER	120Vac, 60 Hz	DETECTOR FUNCTION	Peak (PK) Average (AV)
ENVIRONMENTAL CONDITIONS	25deg. C, 65%RH	TESTED BY	Will Chen

ANTENNA POLARITY & TEST DISTANCE: HORIZONTAL AT 3 M										
FREQ. (MHz)	EMISSION LEVEL (dBuV/m)	READ LEVEL (dBuV)	LIMIT (dBuV/m)	MARGIN (dB)	ANTENNA FACTOR (dB/m)	CABLE LOSS (dB)	PREAMP FACTOR (dB)	ANTENNA HEIGHT (cm)	TABLE ANGLE (Degree)	REMARK
5456	43.01	34.19	54	-10.99	34.36	8.51	34.05	184	327	Average
5456	57.76	48.94	74	-16.24	34.36	8.51	34.05	184	327	Peak
5470	57.74	48.91	68.2	-10.46	34.37	8.51	34.05	184	327	Peak
5580	97.91	88.92			34.47	8.6	34.08	184	327	Average
5580	105.67	96.68			34.47	8.6	34.08	184	327	Peak
5725	56.57	47.41	68.2	-11.63	34.62	8.65	34.11	184	327	Peak
ANTENNA POLARITY & TEST DISTANCE: VERTICAL AT 3 M										
FREQ. (MHz)	EMISSION LEVEL (dBuV/m)	READ LEVEL (dBuV)	LIMIT (dBuV/m)	MARGIN (dB)	ANTENNA FACTOR (dB/m)	CABLE LOSS (dB)	PREAMP FACTOR (dB)	ANTENNA HEIGHT (cm)	TABLE ANGLE (Degree)	REMARK
5384	43.07	34.39	54	-10.93	34.31	8.41	34.04	184	218	Average
5384	57.62	48.94	74	-16.38	34.31	8.41	34.04	184	218	Peak
5470	57.06	48.23	68.2	-11.14	34.37	8.51	34.05	184	218	Peak
5580	99.92	90.93			34.47	8.6	34.08	184	218	Average
5580	107.75	98.76			34.47	8.6	34.08	184	218	Peak
5725	56.55	47.39	68.2	-11.65	34.62	8.65	34.11	184	218	Peak

REMARKS:

- Emission Level = Read Level + Antenna Factor + Cable Loss - Preamp Factor
Margin value = Emission level – Limit value
- 5580MHz: Fundamental frequency.
- 5470MHz & 5725MHz: Out of restricted band



A D T

EUT TEST CONDITION		MEASUREMENT DETAIL	
CHANNEL	Channel 140	FREQUENCY RANGE	1GHz ~ 40GHz
INPUT POWER	120Vac, 60 Hz	DETECTOR FUNCTION	Peak (PK) Average (AV)
ENVIRONMENTAL CONDITIONS	25deg. C, 65%RH	TESTED BY	Will Chen

ANTENNA POLARITY & TEST DISTANCE: HORIZONTAL AT 3 M										
FREQ. (MHz)	EMISSION LEVEL (dBuV/m)	READ LEVEL (dBuV)	LIMIT (dBuV/m)	MARGIN (dB)	ANTENNA FACTOR (dB/m)	CABLE LOSS (dB)	PREAMP FACTOR (dB)	ANTENNA HEIGHT (cm)	TABLE ANGLE (Degree)	REMARK
5352	42.91	34.28	54	-11.09	34.28	8.38	34.03	178	327	Average
5352	57.32	48.69	74	-16.68	34.28	8.38	34.03	178	327	Peak
5470	56.12	47.29	68.2	-12.08	34.37	8.51	34.05	178	327	Peak
5700	97.91	88.78			34.59	8.64	34.1	178	327	Average
5700	105.47	96.34			34.59	8.64	34.1	178	327	Peak
5725	56.77	47.61	68.2	-11.43	34.62	8.65	34.11	178	327	Peak
ANTENNA POLARITY & TEST DISTANCE: VERTICAL AT 3 M										
FREQ. (MHz)	EMISSION LEVEL (dBuV/m)	READ LEVEL (dBuV)	LIMIT (dBuV/m)	MARGIN (dB)	ANTENNA FACTOR (dB/m)	CABLE LOSS (dB)	PREAMP FACTOR (dB)	ANTENNA HEIGHT (cm)	TABLE ANGLE (Degree)	REMARK
5368	43.02	34.35	54	-10.98	34.29	8.41	34.03	178	234	Average
5368	57.74	49.07	74	-16.26	34.29	8.41	34.03	178	234	Peak
5470	57.93	49.1	68.2	-10.27	34.37	8.51	34.05	178	234	Peak
5700	100.33	91.2			34.59	8.64	34.1	178	234	Average
5700	107.77	98.64			34.59	8.64	34.1	178	234	Peak
5725	57.16	48	68.2	-11.04	34.62	8.65	34.11	178	234	Peak

REMARKS:

- Emission Level = Read Level + Antenna Factor + Cable Loss - Preamp Factor
Margin value = Emission level – Limit value
- 5700MHz: Fundamental frequency.
- 5470MHz & 5725MHz: Out of restricted band



A D T

EUT TEST CONDITION		MEASUREMENT DETAIL	
CHANNEL	Channel 149	FREQUENCY RANGE	1GHz ~ 40GHz
INPUT POWER	120Vac, 60 Hz	DETECTOR FUNCTION	Peak (PK) Average (AV)
ENVIRONMENTAL CONDITIONS	25deg. C, 65%RH	TESTED BY	Will Chen

ANTENNA POLARITY & TEST DISTANCE: HORIZONTAL AT 3 M										
FREQ. (MHz)	EMISSION LEVEL (dBuV/m)	READ LEVEL (dBuV)	LIMIT (dBuV/m)	MARGIN (dB)	ANTENNA FACTOR (dB/m)	CABLE LOSS (dB)	PREAMP FACTOR (dB)	ANTENNA HEIGHT (cm)	TABLE ANGLE (Degree)	REMARK
*5712	57.62	48.47	68.2	-10.58	34.61	8.65	34.11	193	319	Peak
*5724	65.28	56.12	78.2	-12.92	34.62	8.65	34.11	193	319	Peak
5745	97	87.81			34.64	8.66	34.11	193	319	Average
5745	105.31	96.12			34.64	8.66	34.11	193	319	Peak
*5854	58.72	49.4	78.2	-19.48	34.76	8.7	34.14	193	319	Peak
*5868	56.46	47.13	68.2	-11.74	34.76	8.71	34.14	193	319	Peak
ANTENNA POLARITY & TEST DISTANCE: VERTICAL AT 3 M										
FREQ. (MHz)	EMISSION LEVEL (dBuV/m)	READ LEVEL (dBuV)	LIMIT (dBuV/m)	MARGIN (dB)	ANTENNA FACTOR (dB/m)	CABLE LOSS (dB)	PREAMP FACTOR (dB)	ANTENNA HEIGHT (cm)	TABLE ANGLE (Degree)	REMARK
*5714	57.01	47.86	68.2	-11.19	34.61	8.65	34.11	177	233	Peak
*5724	68.45	59.29	78.2	-9.75	34.62	8.65	34.11	177	233	Peak
5745	99.96	90.77			34.64	8.66	34.11	177	233	Average
5745	107.71	98.52			34.64	8.66	34.11	177	233	Peak
*5858	58.21	48.89	78.2	-19.99	34.76	8.7	34.14	177	233	Peak
*5870	57.37	48.04	68.2	-10.83	34.76	8.71	34.14	177	233	Peak

REMARKS:

- Emission Level = Read Level + Antenna Factor + Cable Loss - Preamp Factor
Margin value = Emission level – Limit value
- 5745MHz: Fundamental frequency.
- :: Out of restricted band



A D T

EUT TEST CONDITION		MEASUREMENT DETAIL	
CHANNEL	Channel 157	FREQUENCY RANGE	1GHz ~ 40GHz
INPUT POWER	120Vac, 60 Hz	DETECTOR FUNCTION	Peak (PK) Average (AV)
ENVIRONMENTAL CONDITIONS	25deg. C, 65%RH	TESTED BY	Will Chen

ANTENNA POLARITY & TEST DISTANCE: HORIZONTAL AT 3 M

FREQ. (MHz)	EMISSION LEVEL (dBuV/m)	READ LEVEL (dBuV)	LIMIT (dBuV/m)	MARGIN (dB)	ANTENNA FACTOR (dB/m)	CABLE LOSS (dB)	PREAMP FACTOR (dB)	ANTENNA HEIGHT (cm)	TABLE ANGLE (Degree)	REMARK
*5708	57.41	48.26	68.2	-10.79	34.61	8.65	34.11	203	319	Peak
*5722	57.11	47.95	78.2	-21.09	34.62	8.65	34.11	203	319	Peak
5785	97.49	88.26			34.68	8.68	34.13	203	319	Average
5785	105.33	96.1			34.68	8.68	34.13	203	319	Peak
*5854	56.94	47.62	78.2	-21.26	34.76	8.7	34.14	203	319	Peak
*5870	58.35	49.02	68.2	-9.85	34.76	8.71	34.14	203	319	Peak

ANTENNA POLARITY & TEST DISTANCE: VERTICAL AT 3 M

FREQ. (MHz)	EMISSION LEVEL (dBuV/m)	READ LEVEL (dBuV)	LIMIT (dBuV/m)	MARGIN (dB)	ANTENNA FACTOR (dB/m)	CABLE LOSS (dB)	PREAMP FACTOR (dB)	ANTENNA HEIGHT (cm)	TABLE ANGLE (Degree)	REMARK
*5708	57.21	48.06	68.2	-10.99	34.61	8.65	34.11	170	213	Peak
*5722	56.52	47.36	78.2	-21.68	34.62	8.65	34.11	170	213	Peak
5785	99.17	89.94			34.68	8.68	34.13	170	213	Average
5785	107.37	98.14			34.68	8.68	34.13	170	213	Peak
*5860	57.15	47.83	78.2	-21.05	34.76	8.7	34.14	170	213	Peak
*5868	57.33	48	68.2	-10.87	34.76	8.71	34.14	170	213	Peak

REMARKS:

- Emission Level = Read Level + Antenna Factor + Cable Loss - Preamp Factor
Margin value = Emission level – Limit value
- 5785MHz: Fundamental frequency.
- *: Out of restricted band



A D T

EUT TEST CONDITION		MEASUREMENT DETAIL	
CHANNEL	Channel 165	FREQUENCY RANGE	1GHz ~ 40GHz
INPUT POWER	120Vac, 60 Hz	DETECTOR FUNCTION	Peak (PK) Average (AV)
ENVIRONMENTAL CONDITIONS	25deg. C, 65%RH	TESTED BY	Will Chen

ANTENNA POLARITY & TEST DISTANCE: HORIZONTAL AT 3 M

FREQ. (MHz)	EMISSION LEVEL (dBuV/m)	READ LEVEL (dBuV)	LIMIT (dBuV/m)	MARGIN (dB)	ANTENNA FACTOR (dB/m)	CABLE LOSS (dB)	PREAMP FACTOR (dB)	ANTENNA HEIGHT (cm)	TABLE ANGLE (Degree)	REMARK
*5712	57.57	48.42	68.2	-10.63	34.61	8.65	34.11	201	312	Peak
*5720	57.6	48.44	78.2	-20.6	34.62	8.65	34.11	201	312	Peak
5825	96.86	87.57			34.73	8.69	34.13	201	312	Average
5825	105.03	95.74			34.73	8.69	34.13	201	312	Peak
*5860	57.97	48.65	78.2	-20.23	34.76	8.7	34.14	201	312	Peak
*5866	57.34	48.01	68.2	-10.86	34.76	8.71	34.14	201	312	Peak

ANTENNA POLARITY & TEST DISTANCE: VERTICAL AT 3 M

FREQ. (MHz)	EMISSION LEVEL (dBuV/m)	READ LEVEL (dBuV)	LIMIT (dBuV/m)	MARGIN (dB)	ANTENNA FACTOR (dB/m)	CABLE LOSS (dB)	PREAMP FACTOR (dB)	ANTENNA HEIGHT (cm)	TABLE ANGLE (Degree)	REMARK
*5708	57.73	48.58	68.2	-10.47	34.61	8.65	34.11	183	235	Peak
*5716	57.22	48.07	78.2	-20.98	34.61	8.65	34.11	183	235	Peak
5825	99.42	90.13			34.73	8.69	34.13	183	235	Average
5825	107.78	98.49			34.73	8.69	34.13	183	235	Peak
*5856	57.22	47.9	78.2	-20.98	34.76	8.7	34.14	183	235	Peak
*5868	57.56	48.23	68.2	-10.64	34.76	8.71	34.14	183	235	Peak

REMARKS:

- Emission Level = Read Level + Antenna Factor + Cable Loss - Preamp Factor
Margin value = Emission level – Limit value
- 5825MHz: Fundamental frequency.
- *: Out of restricted band



A D T

802.11n (20MHz)

EUT TEST CONDITION		MEASUREMENT DETAIL	
CHANNEL	Channel 36	FREQUENCY RANGE	1GHz ~ 40GHz
INPUT POWER	120Vac, 60 Hz	DETECTOR FUNCTION	Peak (PK) Average (AV)
ENVIRONMENTAL CONDITIONS	25deg. C, 65%RH	TESTED BY	Will Chen

ANTENNA POLARITY & TEST DISTANCE: HORIZONTAL AT 3 M										
FREQ. (MHz)	EMISSION LEVEL (dBuV/m)	READ LEVEL (dBuV)	LIMIT (dBuV/m)	MARGIN (dB)	ANTENNA FACTOR (dB/m)	CABLE LOSS (dB)	PREAMP FACTOR (dB)	ANTENNA HEIGHT (cm)	TABLE ANGLE (Degree)	REMARK
5090	45.3	37.13	54	-8.7	34.08	8.07	33.98	200	301	Average
5090	58.25	50.08	74	-15.75	34.08	8.07	33.98	200	301	Peak
5180	97.51	89.2			34.15	8.16	34	200	301	Average
5180	105.16	96.85			34.15	8.16	34	200	301	Peak
5386	43.01	34.33	54	-10.99	34.31	8.41	34.04	200	301	Average
5386	56.85	48.17	74	-17.15	34.31	8.41	34.04	200	301	Peak
ANTENNA POLARITY & TEST DISTANCE: VERTICAL AT 3 M										
FREQ. (MHz)	EMISSION LEVEL (dBuV/m)	READ LEVEL (dBuV)	LIMIT (dBuV/m)	MARGIN (dB)	ANTENNA FACTOR (dB/m)	CABLE LOSS (dB)	PREAMP FACTOR (dB)	ANTENNA HEIGHT (cm)	TABLE ANGLE (Degree)	REMARK
5086	45.31	37.15	54	-8.69	34.07	8.07	33.98	175	244	Average
5086	57.35	49.19	74	-16.65	34.07	8.07	33.98	175	244	Peak
5180	99.51	91.2			34.15	8.16	34	175	244	Average
5180	107.51	99.2			34.15	8.16	34	175	244	Peak
5442	43.14	34.35	54	-10.86	34.35	8.48	34.04	175	244	Average
5442	57.46	48.67	74	-16.54	34.35	8.48	34.04	175	244	Peak

REMARKS:

- Emission Level = Read Level + Antenna Factor + Cable Loss - Preamp Factor
Margin value = Emission level – Limit value
- 5180MHz: Fundamental frequency.



A D T

EUT TEST CONDITION		MEASUREMENT DETAIL	
CHANNEL	Channel 44	FREQUENCY RANGE	1GHz ~ 40GHz
INPUT POWER	120Vac, 60 Hz	DETECTOR FUNCTION	Peak (PK) Average (AV)
ENVIRONMENTAL CONDITIONS	25deg. C, 65%RH	TESTED BY	Will Chen

ANTENNA POLARITY & TEST DISTANCE: HORIZONTAL AT 3 M										
FREQ. (MHz)	EMISSION LEVEL (dBuV/m)	READ LEVEL (dBuV)	LIMIT (dBuV/m)	MARGIN (dB)	ANTENNA FACTOR (dB/m)	CABLE LOSS (dB)	PREAMP FACTOR (dB)	ANTENNA HEIGHT (cm)	TABLE ANGLE (Degree)	REMARK
5122	42.84	34.64	54	-11.16	34.09	8.1	33.99	200	301	Average
5122	56.8	48.6	74	-17.2	34.09	8.1	33.99	200	301	Peak
5220	97.9	89.51			34.17	8.22	34	200	301	Average
5220	105.94	97.55			34.17	8.22	34	200	301	Peak
5400	43.04	34.32	54	-10.96	34.32	8.44	34.04	200	301	Average
5400	57.4	48.68	74	-16.6	34.32	8.44	34.04	200	301	Peak
ANTENNA POLARITY & TEST DISTANCE: VERTICAL AT 3 M										
FREQ. (MHz)	EMISSION LEVEL (dBuV/m)	READ LEVEL (dBuV)	LIMIT (dBuV/m)	MARGIN (dB)	ANTENNA FACTOR (dB/m)	CABLE LOSS (dB)	PREAMP FACTOR (dB)	ANTENNA HEIGHT (cm)	TABLE ANGLE (Degree)	REMARK
5122	42.97	34.77	54	-11.03	34.09	8.1	33.99	176	233	Average
5122	57.27	49.07	74	-16.73	34.09	8.1	33.99	176	233	Peak
5220	99.3	90.91			34.17	8.22	34	176	233	Average
5220	107.4	99.01			34.17	8.22	34	176	233	Peak
5452	43.29	34.47	54	-10.71	34.36	8.51	34.05	176	233	Average
5452	57.26	48.44	74	-16.74	34.36	8.51	34.05	176	233	Peak

REMARKS:

- Emission Level = Read Level + Antenna Factor + Cable Loss - Preamp Factor
Margin value = Emission level – Limit value
- 5220MHz: Fundamental frequency.



A D T

EUT TEST CONDITION		MEASUREMENT DETAIL	
CHANNEL	Channel 48	FREQUENCY RANGE	1GHz ~ 40GHz
INPUT POWER	120Vac, 60 Hz	DETECTOR FUNCTION	Peak (PK) Average (AV)
ENVIRONMENTAL CONDITIONS	25deg. C, 65%RH	TESTED BY	Will Chen

ANTENNA POLARITY & TEST DISTANCE: HORIZONTAL AT 3 M										
FREQ. (MHz)	EMISSION LEVEL (dBuV/m)	READ LEVEL (dBuV)	LIMIT (dBuV/m)	MARGIN (dB)	ANTENNA FACTOR (dB/m)	CABLE LOSS (dB)	PREAMP FACTOR (dB)	ANTENNA HEIGHT (cm)	TABLE ANGLE (Degree)	REMARK
5044	42.71	34.65	54	-11.29	34.04	8	33.98	189	302	Average
5044	56.7	48.64	74	-17.3	34.04	8	33.98	189	302	Peak
5240	97.54	89.1			34.19	8.26	34.01	189	302	Average
5240	105.29	96.85			34.19	8.26	34.01	189	302	Peak
5388	43.1	34.42	54	-10.9	34.31	8.41	34.04	189	302	Average
5388	57.41	48.73	74	-16.59	34.31	8.41	34.04	189	302	Peak
ANTENNA POLARITY & TEST DISTANCE: VERTICAL AT 3 M										
FREQ. (MHz)	EMISSION LEVEL (dBuV/m)	READ LEVEL (dBuV)	LIMIT (dBuV/m)	MARGIN (dB)	ANTENNA FACTOR (dB/m)	CABLE LOSS (dB)	PREAMP FACTOR (dB)	ANTENNA HEIGHT (cm)	TABLE ANGLE (Degree)	REMARK
5076	42.91	34.79	54	-11.09	34.07	8.03	33.98	167	234	Average
5076	57.02	48.9	74	-16.98	34.07	8.03	33.98	167	234	Peak
5240	100.04	91.6			34.19	8.26	34.01	167	234	Average
5240	107.8	99.36			34.19	8.26	34.01	167	234	Peak
5442	43.09	34.3	54	-10.91	34.35	8.48	34.04	167	234	Average
5442	58.64	49.85	74	-15.36	34.35	8.48	34.04	167	234	Peak

REMARKS:

- Emission Level = Read Level + Antenna Factor + Cable Loss - Preamp Factor
Margin value = Emission level – Limit value
- 5240MHz: Fundamental frequency.



A D T

EUT TEST CONDITION		MEASUREMENT DETAIL	
CHANNEL	Channel 52	FREQUENCY RANGE	1GHz ~ 40GHz
INPUT POWER	120Vac, 60 Hz	DETECTOR FUNCTION	Peak (PK) Average (AV)
ENVIRONMENTAL CONDITIONS	25deg. C, 65%RH	TESTED BY	Will Chen

ANTENNA POLARITY & TEST DISTANCE: HORIZONTAL AT 3 M										
FREQ. (MHz)	EMISSION LEVEL (dBuV/m)	READ LEVEL (dBuV)	LIMIT (dBuV/m)	MARGIN (dB)	ANTENNA FACTOR (dB/m)	CABLE LOSS (dB)	PREAMP FACTOR (dB)	ANTENNA HEIGHT (cm)	TABLE ANGLE (Degree)	REMARK
5148	43	34.75	54	-11	34.12	8.13	34	200	307	Average
5148	57.56	49.31	74	-16.44	34.12	8.13	34	200	307	Peak
5260	97.19	88.73			34.21	8.26	34.01	200	307	Average
5260	105.03	96.57			34.21	8.26	34.01	200	307	Peak
5356	43.06	34.43	54	-10.94	34.28	8.38	34.03	200	307	Average
5356	57.83	49.2	74	-16.17	34.28	8.38	34.03	200	307	Peak
ANTENNA POLARITY & TEST DISTANCE: VERTICAL AT 3 M										
FREQ. (MHz)	EMISSION LEVEL (dBuV/m)	READ LEVEL (dBuV)	LIMIT (dBuV/m)	MARGIN (dB)	ANTENNA FACTOR (dB/m)	CABLE LOSS (dB)	PREAMP FACTOR (dB)	ANTENNA HEIGHT (cm)	TABLE ANGLE (Degree)	REMARK
5130	42.92	34.7	54	-11.08	34.11	8.1	33.99	113	253	Average
5130	57.33	49.11	74	-16.67	34.11	8.1	33.99	113	253	Peak
5260	99.67	91.21			34.21	8.26	34.01	113	253	Average
5260	107.76	99.3			34.21	8.26	34.01	113	253	Peak
5362	42.94	34.3	54	-11.06	34.29	8.38	34.03	113	253	Average
5362	58.26	49.62	74	-15.74	34.29	8.38	34.03	113	253	Peak

REMARKS:

- Emission Level = Read Level + Antenna Factor + Cable Loss - Preamp Factor
Margin value = Emission level – Limit value
- 5260MHz: Fundamental frequency.



A D T

EUT TEST CONDITION		MEASUREMENT DETAIL	
CHANNEL	Channel 60	FREQUENCY RANGE	1GHz ~ 40GHz
INPUT POWER	120Vac, 60 Hz	DETECTOR FUNCTION	Peak (PK) Average (AV)
ENVIRONMENTAL CONDITIONS	25deg. C, 65%RH	TESTED BY	Will Chen

ANTENNA POLARITY & TEST DISTANCE: HORIZONTAL AT 3 M										
FREQ. (MHz)	EMISSION LEVEL (dBuV/m)	READ LEVEL (dBuV)	LIMIT (dBuV/m)	MARGIN (dB)	ANTENNA FACTOR (dB/m)	CABLE LOSS (dB)	PREAMP FACTOR (dB)	ANTENNA HEIGHT (cm)	TABLE ANGLE (Degree)	REMARK
5068	42.69	34.59	54	-11.31	34.05	8.03	33.98	203	308	Average
5068	58.94	50.84	74	-15.06	34.05	8.03	33.98	203	308	Peak
5300	98.31	89.77			34.24	8.32	34.02	203	308	Average
5300	105.82	97.28			34.24	8.32	34.02	203	308	Peak
5358	45.23	36.6	54	-8.77	34.28	8.38	34.03	203	308	Average
5358	58.32	49.69	74	-15.68	34.28	8.38	34.03	203	308	Peak
ANTENNA POLARITY & TEST DISTANCE: VERTICAL AT 3 M										
FREQ. (MHz)	EMISSION LEVEL (dBuV/m)	READ LEVEL (dBuV)	LIMIT (dBuV/m)	MARGIN (dB)	ANTENNA FACTOR (dB/m)	CABLE LOSS (dB)	PREAMP FACTOR (dB)	ANTENNA HEIGHT (cm)	TABLE ANGLE (Degree)	REMARK
5082	42.8	34.64	54	-11.2	34.07	8.07	33.98	100	252	Average
5082	57.39	49.23	74	-16.61	34.07	8.07	33.98	100	252	Peak
5300	99.04	90.5			34.24	8.32	34.02	100	252	Average
5300	107.26	98.72			34.24	8.32	34.02	100	252	Peak
5448	45.19	36.36	54	-8.81	34.36	8.51	34.04	100	252	Average
5448	58.39	49.56	74	-15.61	34.36	8.51	34.04	100	252	Peak

REMARKS:

- Emission Level = Read Level + Antenna Factor + Cable Loss - Preamp Factor
Margin value = Emission level – Limit value
- 5300MHz: Fundamental frequency.



A D T

EUT TEST CONDITION		MEASUREMENT DETAIL	
CHANNEL	Channel 64	FREQUENCY RANGE	1GHz ~ 40GHz
INPUT POWER	120Vac, 60 Hz	DETECTOR FUNCTION	Peak (PK) Average (AV)
ENVIRONMENTAL CONDITIONS	25deg. C, 65%RH	TESTED BY	Will Chen

ANTENNA POLARITY & TEST DISTANCE: HORIZONTAL AT 3 M

FREQ. (MHz)	EMISSION LEVEL (dBuV/m)	READ LEVEL (dBuV)	LIMIT (dBuV/m)	MARGIN (dB)	ANTENNA FACTOR (dB/m)	CABLE LOSS (dB)	PREAMP FACTOR (dB)	ANTENNA HEIGHT (cm)	TABLE ANGLE (Degree)	REMARK
5084	42.73	34.57	54	-11.27	34.07	8.07	33.98	202	308	Average
5084	57.39	49.23	74	-16.61	34.07	8.07	33.98	202	308	Peak
5320	97.78	89.2			34.25	8.35	34.02	202	308	Average
5320	105.5	96.92			34.25	8.35	34.02	202	308	Peak
5442	45.4	36.61	54	-8.6	34.35	8.48	34.04	202	308	Average
5442	57.45	48.66	74	-16.55	34.35	8.48	34.04	202	308	Peak

ANTENNA POLARITY & TEST DISTANCE: VERTICAL AT 3 M

FREQ. (MHz)	EMISSION LEVEL (dBuV/m)	READ LEVEL (dBuV)	LIMIT (dBuV/m)	MARGIN (dB)	ANTENNA FACTOR (dB/m)	CABLE LOSS (dB)	PREAMP FACTOR (dB)	ANTENNA HEIGHT (cm)	TABLE ANGLE (Degree)	REMARK
5122	42.8	34.6	54	-11.2	34.09	8.1	33.99	119	253	Average
5122	57.13	48.93	74	-16.87	34.09	8.1	33.99	119	253	Peak
5320	99.81	91.23			34.25	8.35	34.02	119	253	Average
5320	107.69	99.11			34.25	8.35	34.02	119	253	Peak
5422	45.87	37.1	54	-8.13	34.33	8.48	34.04	119	253	Average
5422	57.85	49.08	74	-16.15	34.33	8.48	34.04	119	253	Peak

REMARKS:

- Emission Level = Read Level + Antenna Factor + Cable Loss - Preamp Factor
Margin value = Emission level – Limit value
- 5320MHz: Fundamental frequency.



A D T

EUT TEST CONDITION		MEASUREMENT DETAIL	
CHANNEL	Channel 100	FREQUENCY RANGE	1GHz ~ 40GHz
INPUT POWER	120Vac, 60 Hz	DETECTOR FUNCTION	Peak (PK) Average (AV)
ENVIRONMENTAL CONDITIONS	25deg. C, 65%RH	TESTED BY	Will Chen

ANTENNA POLARITY & TEST DISTANCE: HORIZONTAL AT 3 M										
FREQ. (MHz)	EMISSION LEVEL (dBuV/m)	READ LEVEL (dBuV)	LIMIT (dBuV/m)	MARGIN (dB)	ANTENNA FACTOR (dB/m)	CABLE LOSS (dB)	PREAMP FACTOR (dB)	ANTENNA HEIGHT (cm)	TABLE ANGLE (Degree)	REMARK
5448	44.62	35.79	54	-9.38	34.36	8.51	34.04	182	325	Average
5448	58.38	49.55	74	-15.62	34.36	8.51	34.04	182	325	Peak
5470	56.84	48.01	68.2	-11.36	34.37	8.51	34.05	182	325	Peak
5500	97.88	88.96			34.4	8.57	34.05	182	325	Average
5500	105.91	96.99			34.4	8.57	34.05	182	325	Peak
5725	57.17	48.01	68.2	-11.03	34.62	8.65	34.11	182	325	Peak
ANTENNA POLARITY & TEST DISTANCE: VERTICAL AT 3 M										
FREQ. (MHz)	EMISSION LEVEL (dBuV/m)	READ LEVEL (dBuV)	LIMIT (dBuV/m)	MARGIN (dB)	ANTENNA FACTOR (dB/m)	CABLE LOSS (dB)	PREAMP FACTOR (dB)	ANTENNA HEIGHT (cm)	TABLE ANGLE (Degree)	REMARK
5448	46.22	37.39	54	-7.78	34.36	8.51	34.04	171	234	Average
5448	58.61	49.78	74	-15.39	34.36	8.51	34.04	171	234	Peak
5470	56.08	47.25	68.2	-12.12	34.37	8.51	34.05	171	234	Peak
5500	99.88	90.96			34.4	8.57	34.05	171	234	Average
5500	107.47	98.55			34.4	8.57	34.05	171	234	Peak
5725	56.68	47.52	68.2	-11.52	34.62	8.65	34.11	171	234	Peak

REMARKS:

- Emission Level = Read Level + Antenna Factor + Cable Loss - Preamp Factor
Margin value = Emission level – Limit value
- 5500MHz: Fundamental frequency.
- 5470MHz & 5725MHz: Out of restricted band



A D T

EUT TEST CONDITION		MEASUREMENT DETAIL	
CHANNEL	Channel 116	FREQUENCY RANGE	1GHz ~ 40GHz
INPUT POWER	120Vac, 60 Hz	DETECTOR FUNCTION	Peak (PK) Average (AV)
ENVIRONMENTAL CONDITIONS	25deg. C, 65%RH	TESTED BY	Will Chen

ANTENNA POLARITY & TEST DISTANCE: HORIZONTAL AT 3 M										
FREQ. (MHz)	EMISSION LEVEL (dBuV/m)	READ LEVEL (dBuV)	LIMIT (dBuV/m)	MARGIN (dB)	ANTENNA FACTOR (dB/m)	CABLE LOSS (dB)	PREAMP FACTOR (dB)	ANTENNA HEIGHT (cm)	TABLE ANGLE (Degree)	REMARK
5398	42.95	34.23	54	-11.05	34.32	8.44	34.04	184	327	Average
5398	58.65	49.93	74	-15.35	34.32	8.44	34.04	184	327	Peak
5470	57.04	48.21	68.2	-11.16	34.37	8.51	34.05	184	327	Peak
5580	97.68	88.69			34.47	8.6	34.08	184	327	Average
5580	105.88	96.89			34.47	8.6	34.08	184	327	Peak
5725	56.8	47.64	68.2	-11.4	34.62	8.65	34.11	184	327	Peak
ANTENNA POLARITY & TEST DISTANCE: VERTICAL AT 3 M										
FREQ. (MHz)	EMISSION LEVEL (dBuV/m)	READ LEVEL (dBuV)	LIMIT (dBuV/m)	MARGIN (dB)	ANTENNA FACTOR (dB/m)	CABLE LOSS (dB)	PREAMP FACTOR (dB)	ANTENNA HEIGHT (cm)	TABLE ANGLE (Degree)	REMARK
5442	43	34.21	54	-11	34.35	8.48	34.04	184	232	Average
5442	57.75	48.96	74	-16.25	34.35	8.48	34.04	184	232	Peak
5470	56.21	47.38	68.2	-11.99	34.37	8.51	34.05	184	232	Peak
5580	99.63	90.64			34.47	8.6	34.08	184	232	Average
5580	107.19	98.2			34.47	8.6	34.08	184	232	Peak
5725	56.36	47.2	68.2	-11.84	34.62	8.65	34.11	184	232	Peak

REMARKS:

- Emission Level = Read Level + Antenna Factor + Cable Loss - Preamp Factor
Margin value = Emission level – Limit value
- 5580MHz: Fundamental frequency.
- 5470MHz & 5725MHz: Out of restricted band



A D T

EUT TEST CONDITION		MEASUREMENT DETAIL	
CHANNEL	Channel 140	FREQUENCY RANGE	1GHz ~ 40GHz
INPUT POWER	120Vac, 60 Hz	DETECTOR FUNCTION	Peak (PK) Average (AV)
ENVIRONMENTAL CONDITIONS	25deg. C, 65%RH	TESTED BY	Will Chen

ANTENNA POLARITY & TEST DISTANCE: HORIZONTAL AT 3 M										
FREQ. (MHz)	EMISSION LEVEL (dBuV/m)	READ LEVEL (dBuV)	LIMIT (dBuV/m)	MARGIN (dB)	ANTENNA FACTOR (dB/m)	CABLE LOSS (dB)	PREAMP FACTOR (dB)	ANTENNA HEIGHT (cm)	TABLE ANGLE (Degree)	REMARK
5422	42.84	34.07	54	-11.16	34.33	8.48	34.04	164	326	Average
5422	57.56	48.79	74	-16.44	34.33	8.48	34.04	164	326	Peak
5470	57.31	48.48	68.2	-10.89	34.37	8.51	34.05	164	326	Peak
5700	98.04	88.91			34.59	8.64	34.1	164	326	Average
5700	105.55	96.42			34.59	8.64	34.1	164	326	Peak
5725	56.08	46.92	68.2	-12.12	34.62	8.65	34.11	164	326	Peak
ANTENNA POLARITY & TEST DISTANCE: VERTICAL AT 3 M										
FREQ. (MHz)	EMISSION LEVEL (dBuV/m)	READ LEVEL (dBuV)	LIMIT (dBuV/m)	MARGIN (dB)	ANTENNA FACTOR (dB/m)	CABLE LOSS (dB)	PREAMP FACTOR (dB)	ANTENNA HEIGHT (cm)	TABLE ANGLE (Degree)	REMARK
5446	43.07	34.24	54	-10.93	34.36	8.51	34.04	179	234	Average
5446	58.31	49.48	74	-15.69	34.36	8.51	34.04	179	234	Peak
5470	56.25	47.42	68.2	-11.95	34.37	8.51	34.05	179	234	Peak
5700	100.32	91.19			34.59	8.64	34.1	179	234	Average
5700	107.99	98.86			34.59	8.64	34.1	179	234	Peak
5725	58.38	49.22	68.2	-9.82	34.62	8.65	34.11	179	234	Peak

REMARKS:

- Emission Level = Read Level + Antenna Factor + Cable Loss - Preamp Factor
Margin value = Emission level – Limit value
- 5700MHz: Fundamental frequency.
- 5470MHz & 5725MHz: Out of restricted band



A D T

EUT TEST CONDITION		MEASUREMENT DETAIL	
CHANNEL	Channel 149	FREQUENCY RANGE	1GHz ~ 40GHz
INPUT POWER	120Vac, 60 Hz	DETECTOR FUNCTION	Peak (PK) Average (AV)
ENVIRONMENTAL CONDITIONS	25deg. C, 65%RH	TESTED BY	Will Chen

ANTENNA POLARITY & TEST DISTANCE: HORIZONTAL AT 3 M										
FREQ. (MHz)	EMISSION LEVEL (dBuV/m)	READ LEVEL (dBuV)	LIMIT (dBuV/m)	MARGIN (dB)	ANTENNA FACTOR (dB/m)	CABLE LOSS (dB)	PREAMP FACTOR (dB)	ANTENNA HEIGHT (cm)	TABLE ANGLE (Degree)	REMARK
*5714	56.71	47.56	68.2	-11.49	34.61	8.65	34.11	193	319	Peak
*5724	65.73	56.57	78.2	-12.47	34.62	8.65	34.11	193	319	Peak
5745	97.6	88.41			34.64	8.66	34.11	193	319	Average
5745	105.91	96.72			34.64	8.66	34.11	193	319	Peak
*5858	56.81	47.49	78.2	-21.39	34.76	8.7	34.14	193	319	Peak
*5870	57.22	47.89	68.2	-10.98	34.76	8.71	34.14	193	319	Peak
ANTENNA POLARITY & TEST DISTANCE: VERTICAL AT 3 M										
FREQ. (MHz)	EMISSION LEVEL (dBuV/m)	READ LEVEL (dBuV)	LIMIT (dBuV/m)	MARGIN (dB)	ANTENNA FACTOR (dB/m)	CABLE LOSS (dB)	PREAMP FACTOR (dB)	ANTENNA HEIGHT (cm)	TABLE ANGLE (Degree)	REMARK
*5710	58.09	48.94	68.2	-10.11	34.61	8.65	34.11	177	230	Peak
*5724	70.2	61.04	78.2	-8	34.62	8.65	34.11	177	230	Peak
5745	99.34	90.15			34.64	8.66	34.11	177	230	Average
5745	107.15	97.96			34.64	8.66	34.11	177	230	Peak
*5860	58.31	48.99	78.2	-19.89	34.76	8.7	34.14	177	230	Peak
*5866	58.46	49.13	68.2	-9.74	34.76	8.71	34.14	177	230	Peak

REMARKS:

- Emission Level = Read Level + Antenna Factor + Cable Loss - Preamp Factor
Margin value = Emission level – Limit value
- 5745MHz: Fundamental frequency.
- *: Out of restricted band



A D T

EUT TEST CONDITION		MEASUREMENT DETAIL	
CHANNEL	Channel 157	FREQUENCY RANGE	1GHz ~ 40GHz
INPUT POWER	120Vac, 60 Hz	DETECTOR FUNCTION	Peak (PK) Average (AV)
ENVIRONMENTAL CONDITIONS	25deg. C, 65%RH	TESTED BY	Will Chen

ANTENNA POLARITY & TEST DISTANCE: HORIZONTAL AT 3 M

FREQ. (MHz)	EMISSION LEVEL (dBuV/m)	READ LEVEL (dBuV)	LIMIT (dBuV/m)	MARGIN (dB)	ANTENNA FACTOR (dB/m)	CABLE LOSS (dB)	PREAMP FACTOR (dB)	ANTENNA HEIGHT (cm)	TABLE ANGLE (Degree)	REMARK
*5708	57.41	48.26	68.2	-10.79	34.61	8.65	34.11	203	319	Peak
*5722	57.11	47.95	78.2	-21.09	34.62	8.65	34.11	203	319	Peak
5785	97.49	88.26			34.68	8.68	34.13	203	319	Average
5785	105.33	96.1			34.68	8.68	34.13	203	319	Peak
*5854	56.94	47.62	78.2	-21.26	34.76	8.7	34.14	203	319	Peak
*5870	58.35	49.02	68.2	-9.85	34.76	8.71	34.14	203	319	Peak

ANTENNA POLARITY & TEST DISTANCE: VERTICAL AT 3 M

FREQ. (MHz)	EMISSION LEVEL (dBuV/m)	READ LEVEL (dBuV)	LIMIT (dBuV/m)	MARGIN (dB)	ANTENNA FACTOR (dB/m)	CABLE LOSS (dB)	PREAMP FACTOR (dB)	ANTENNA HEIGHT (cm)	TABLE ANGLE (Degree)	REMARK
*5708	57.21	48.06	68.2	-10.99	34.61	8.65	34.11	170	213	Peak
*5722	56.52	47.36	78.2	-21.68	34.62	8.65	34.11	170	213	Peak
5785	99.17	89.94			34.68	8.68	34.13	170	213	Average
5785	107.37	98.14			34.68	8.68	34.13	170	213	Peak
*5860	57.15	47.83	78.2	-21.05	34.76	8.7	34.14	170	213	Peak
*5868	57.33	48	68.2	-10.87	34.76	8.71	34.14	170	213	Peak

REMARKS:

- Emission Level = Read Level + Antenna Factor + Cable Loss - Preamp Factor
Margin value = Emission level – Limit value
- 5785MHz: Fundamental frequency.
- *: Out of restricted band



A D T

EUT TEST CONDITION		MEASUREMENT DETAIL	
CHANNEL	Channel 165	FREQUENCY RANGE	1GHz ~ 40GHz
INPUT POWER	120Vac, 60 Hz	DETECTOR FUNCTION	Peak (PK) Average (AV)
ENVIRONMENTAL CONDITIONS	25deg. C, 65%RH	TESTED BY	Will Chen

ANTENNA POLARITY & TEST DISTANCE: HORIZONTAL AT 3 M

FREQ. (MHz)	EMISSION LEVEL (dBuV/m)	READ LEVEL (dBuV)	LIMIT (dBuV/m)	MARGIN (dB)	ANTENNA FACTOR (dB/m)	CABLE LOSS (dB)	PREAMP FACTOR (dB)	ANTENNA HEIGHT (cm)	TABLE ANGLE (Degree)	REMARK
*5712	57.57	48.42	68.2	-10.63	34.61	8.65	34.11	201	312	Peak
*5720	57.6	48.44	78.2	-20.6	34.62	8.65	34.11	201	312	Peak
5825	96.86	87.57			34.73	8.69	34.13	201	312	Average
5825	105.03	95.74			34.73	8.69	34.13	201	312	Peak
*5860	57.97	48.65	78.2	-20.23	34.76	8.7	34.14	201	312	Peak
*5866	57.34	48.01	68.2	-10.86	34.76	8.71	34.14	201	312	Peak

ANTENNA POLARITY & TEST DISTANCE: VERTICAL AT 3 M

FREQ. (MHz)	EMISSION LEVEL (dBuV/m)	READ LEVEL (dBuV)	LIMIT (dBuV/m)	MARGIN (dB)	ANTENNA FACTOR (dB/m)	CABLE LOSS (dB)	PREAMP FACTOR (dB)	ANTENNA HEIGHT (cm)	TABLE ANGLE (Degree)	REMARK
*5708	57.73	48.58	68.2	-10.47	34.61	8.65	34.11	183	235	Peak
*5716	57.22	48.07	78.2	-20.98	34.61	8.65	34.11	183	235	Peak
5825	99.42	90.13			34.73	8.69	34.13	183	235	Average
5825	107.78	98.49			34.73	8.69	34.13	183	235	Peak
*5856	57.22	47.9	78.2	-20.98	34.76	8.7	34.14	183	235	Peak
*5868	57.56	48.23	68.2	-10.64	34.76	8.71	34.14	183	235	Peak

REMARKS:

- Emission Level = Read Level + Antenna Factor + Cable Loss - Preamp Factor
Margin value = Emission level – Limit value
- 5825MHz: Fundamental frequency.
- *: Out of restricted band



A D T

802.11n (40MHz)

EUT TEST CONDITION		MEASUREMENT DETAIL	
CHANNEL	Channel 38	FREQUENCY RANGE	1GHz ~ 40GHz
INPUT POWER	120Vac, 60 Hz	DETECTOR FUNCTION	Peak (PK) Average (AV)
ENVIRONMENTAL CONDITIONS	25deg. C, 65%RH	TESTED BY	Will Chen

ANTENNA POLARITY & TEST DISTANCE: HORIZONTAL AT 3 M										
FREQ. (MHz)	EMISSION LEVEL (dBuV/m)	READ LEVEL (dBuV)	LIMIT (dBuV/m)	MARGIN (dB)	ANTENNA FACTOR (dB/m)	CABLE LOSS (dB)	PREAMP FACTOR (dB)	ANTENNA HEIGHT (cm)	TABLE ANGLE (Degree)	REMARK
5074	43.98	35.86	54	-10.02	34.07	8.03	33.98	200	301	Average
5074	57.03	48.91	74	-16.97	34.07	8.03	33.98	200	301	Peak
5190	98.34	90			34.15	8.19	34	200	301	Average
5190	105.82	97.48			34.15	8.19	34	200	301	Peak
5436	43.44	34.65	54	-10.56	34.35	8.48	34.04	200	301	Average
5436	57.89	49.1	74	-16.11	34.35	8.48	34.04	200	301	Peak
ANTENNA POLARITY & TEST DISTANCE: VERTICAL AT 3 M										
FREQ. (MHz)	EMISSION LEVEL (dBuV/m)	READ LEVEL (dBuV)	LIMIT (dBuV/m)	MARGIN (dB)	ANTENNA FACTOR (dB/m)	CABLE LOSS (dB)	PREAMP FACTOR (dB)	ANTENNA HEIGHT (cm)	TABLE ANGLE (Degree)	REMARK
5080	44.2	36.08	54	-9.8	34.07	8.03	33.98	175	244	Average
5080	57.34	49.22	74	-16.66	34.07	8.03	33.98	175	244	Peak
5190	100.04	91.7			34.15	8.19	34	175	244	Average
5190	107.53	99.19			34.15	8.19	34	175	244	Peak
5442	43.45	34.66	54	-10.55	34.35	8.48	34.04	175	244	Average
5442	57.48	48.69	74	-16.52	34.35	8.48	34.04	175	244	Peak

REMARKS:

- Emission Level = Read Level + Antenna Factor + Cable Loss - Preamp Factor
Margin value = Emission level – Limit value
- 5190MHz: Fundamental frequency.



A D T

EUT TEST CONDITION		MEASUREMENT DETAIL	
CHANNEL	Channel 46	FREQUENCY RANGE	1GHz ~ 40GHz
INPUT POWER	120Vac, 60 Hz	DETECTOR FUNCTION	Peak (PK) Average (AV)
ENVIRONMENTAL CONDITIONS	25deg. C, 65%RH	TESTED BY	Will Chen

ANTENNA POLARITY & TEST DISTANCE: HORIZONTAL AT 3 M										
FREQ. (MHz)	EMISSION LEVEL (dBuV/m)	READ LEVEL (dBuV)	LIMIT (dBuV/m)	MARGIN (dB)	ANTENNA FACTOR (dB/m)	CABLE LOSS (dB)	PREAMP FACTOR (dB)	ANTENNA HEIGHT (cm)	TABLE ANGLE (Degree)	REMARK
5108	43.91	35.71	54	-10.09	34.09	8.1	33.99	200	302	Average
5108	56.74	48.54	74	-17.26	34.09	8.1	33.99	200	302	Peak
5230	97.41	89.01			34.19	8.22	34.01	200	302	Average
5230	105.64	97.24			34.19	8.22	34.01	200	302	Peak
5454	43.53	34.71	54	-10.47	34.36	8.51	34.05	200	302	Average
5454	57.75	48.93	74	-16.25	34.36	8.51	34.05	200	302	Peak
ANTENNA POLARITY & TEST DISTANCE: VERTICAL AT 3 M										
FREQ. (MHz)	EMISSION LEVEL (dBuV/m)	READ LEVEL (dBuV)	LIMIT (dBuV/m)	MARGIN (dB)	ANTENNA FACTOR (dB/m)	CABLE LOSS (dB)	PREAMP FACTOR (dB)	ANTENNA HEIGHT (cm)	TABLE ANGLE (Degree)	REMARK
5040	43.66	35.59	54	-10.34	34.04	8	33.97	167	233	Average
5040	56.76	48.69	74	-17.24	34.04	8	33.97	167	233	Peak
5230	99.61	91.21			34.19	8.22	34.01	167	233	Average
5230	107.92	99.52			34.19	8.22	34.01	167	233	Peak
5362	43.28	34.64	54	-10.72	34.29	8.38	34.03	167	233	Average
5362	57.77	49.13	74	-16.23	34.29	8.38	34.03	167	233	Peak

REMARKS:

- Emission Level = Read Level + Antenna Factor + Cable Loss - Preamp Factor
Margin value = Emission level – Limit value
- 5230MHz: Fundamental frequency.



A D T

EUT TEST CONDITION		MEASUREMENT DETAIL	
CHANNEL	Channel 54	FREQUENCY RANGE	1GHz ~ 40GHz
INPUT POWER	120Vac, 60 Hz	DETECTOR FUNCTION	Peak (PK) Average (AV)
ENVIRONMENTAL CONDITIONS	25deg. C, 65%RH	TESTED BY	Will Chen

ANTENNA POLARITY & TEST DISTANCE: HORIZONTAL AT 3 M										
FREQ. (MHz)	EMISSION LEVEL (dBuV/m)	READ LEVEL (dBuV)	LIMIT (dBuV/m)	MARGIN (dB)	ANTENNA FACTOR (dB/m)	CABLE LOSS (dB)	PREAMP FACTOR (dB)	ANTENNA HEIGHT (cm)	TABLE ANGLE (Degree)	REMARK
5114	42.8	34.6	54	-11.2	34.09	8.1	33.99	200	307	Average
5114	58.6	50.4	74	-15.4	34.09	8.1	33.99	200	307	Peak
5270	97.4	88.91			34.21	8.29	34.01	200	307	Average
5270	105.95	97.46			34.21	8.29	34.01	200	307	Peak
5394	43.42	34.71	54	-10.58	34.31	8.44	34.04	200	307	Average
5394	57.62	48.91	74	-16.38	34.31	8.44	34.04	200	307	Peak
ANTENNA POLARITY & TEST DISTANCE: VERTICAL AT 3 M										
FREQ. (MHz)	EMISSION LEVEL (dBuV/m)	READ LEVEL (dBuV)	LIMIT (dBuV/m)	MARGIN (dB)	ANTENNA FACTOR (dB/m)	CABLE LOSS (dB)	PREAMP FACTOR (dB)	ANTENNA HEIGHT (cm)	TABLE ANGLE (Degree)	REMARK
5076	42.66	34.54	54	-11.34	34.07	8.03	33.98	100	252	Average
5076	57.76	49.64	74	-16.24	34.07	8.03	33.98	100	252	Peak
5270	99.04	90.55			34.21	8.29	34.01	100	252	Average
5270	107.43	98.94			34.21	8.29	34.01	100	252	Peak
5402	43.35	34.63	54	-10.65	34.32	8.44	34.04	100	252	Average
5402	57.5	48.78	74	-16.5	34.32	8.44	34.04	100	252	Peak

REMARKS:

- Emission Level = Read Level + Antenna Factor + Cable Loss - Preamp Factor
Margin value = Emission level – Limit value
- 5270MHz: Fundamental frequency.



A D T

EUT TEST CONDITION		MEASUREMENT DETAIL	
CHANNEL	Channel 62	FREQUENCY RANGE	1GHz ~ 40GHz
INPUT POWER	120Vac, 60 Hz	DETECTOR FUNCTION	Peak (PK) Average (AV)
ENVIRONMENTAL CONDITIONS	25deg. C, 65%RH	TESTED BY	Will Chen

ANTENNA POLARITY & TEST DISTANCE: HORIZONTAL AT 3 M										
FREQ. (MHz)	EMISSION LEVEL (dBuV/m)	READ LEVEL (dBuV)	LIMIT (dBuV/m)	MARGIN (dB)	ANTENNA FACTOR (dB/m)	CABLE LOSS (dB)	PREAMP FACTOR (dB)	ANTENNA HEIGHT (cm)	TABLE ANGLE (Degree)	REMARK
5088	42.82	34.66	54	-11.18	34.07	8.07	33.98	202	308	Average
5088	57.47	49.31	74	-16.53	34.07	8.07	33.98	202	308	Peak
5310	97.85	89.3			34.25	8.32	34.02	202	308	Average
5310	105.43	96.88			34.25	8.32	34.02	202	308	Peak
5454	43.89	35.07	54	-10.11	34.36	8.51	34.05	202	308	Average
5454	57.96	49.14	74	-16.04	34.36	8.51	34.05	202	308	Peak
ANTENNA POLARITY & TEST DISTANCE: VERTICAL AT 3 M										
FREQ. (MHz)	EMISSION LEVEL (dBuV/m)	READ LEVEL (dBuV)	LIMIT (dBuV/m)	MARGIN (dB)	ANTENNA FACTOR (dB/m)	CABLE LOSS (dB)	PREAMP FACTOR (dB)	ANTENNA HEIGHT (cm)	TABLE ANGLE (Degree)	REMARK
5074	42.61	34.49	54	-11.39	34.07	8.03	33.98	100	252	Average
5074	57.54	49.42	74	-16.46	34.07	8.03	33.98	100	252	Peak
5310	99.47	90.92			34.25	8.32	34.02	100	252	Average
5310	107.88	99.33			34.25	8.32	34.02	100	252	Peak
5350	43.59	34.96	54	-10.41	34.28	8.38	34.03	100	252	Average
5350	58.47	49.84	74	-15.53	34.28	8.38	34.03	100	252	Peak

REMARKS:

- Emission Level = Read Level + Antenna Factor + Cable Loss - Preamp Factor
Margin value = Emission level – Limit value
- 5310MHz: Fundamental frequency.



A D T

EUT TEST CONDITION		MEASUREMENT DETAIL	
CHANNEL	Channel 102	FREQUENCY RANGE	1GHz ~ 40GHz
INPUT POWER	120Vac, 60 Hz	DETECTOR FUNCTION	Peak (PK) Average (AV)
ENVIRONMENTAL CONDITIONS	25deg. C, 65%RH	TESTED BY	Will Chen

ANTENNA POLARITY & TEST DISTANCE: HORIZONTAL AT 3 M										
FREQ. (MHz)	EMISSION LEVEL (dBuV/m)	READ LEVEL (dBuV)	LIMIT (dBuV/m)	MARGIN (dB)	ANTENNA FACTOR (dB/m)	CABLE LOSS (dB)	PREAMP FACTOR (dB)	ANTENNA HEIGHT (cm)	TABLE ANGLE (Degree)	REMARK
5460	43.15	34.33	54	-10.85	34.36	8.51	34.05	179	327	Average
5460	57.9	49.08	74	-16.1	34.36	8.51	34.05	179	327	Peak
5470	59.15	50.32	68.2	-9.05	34.37	8.51	34.05	179	327	Peak
5510	97.97	89.06			34.4	8.57	34.06	179	327	Average
5510	105.66	96.75			34.4	8.57	34.06	179	327	Peak
5725	57.01	47.85	68.2	-11.19	34.62	8.65	34.11	179	327	Peak
ANTENNA POLARITY & TEST DISTANCE: VERTICAL AT 3 M										
FREQ. (MHz)	EMISSION LEVEL (dBuV/m)	READ LEVEL (dBuV)	LIMIT (dBuV/m)	MARGIN (dB)	ANTENNA FACTOR (dB/m)	CABLE LOSS (dB)	PREAMP FACTOR (dB)	ANTENNA HEIGHT (cm)	TABLE ANGLE (Degree)	REMARK
5416	43.48	34.75	54	-10.52	34.33	8.44	34.04	171	234	Average
5416	57.58	48.85	74	-16.42	34.33	8.44	34.04	171	234	Peak
5470	62.07	53.24	68.2	-6.13	34.37	8.51	34.05	171	234	Peak
5510	98.84	89.93			34.4	8.57	34.06	171	234	Average
5510	106.96	98.05			34.4	8.57	34.06	171	234	Peak
5725	55.59	46.43	68.2	-12.61	34.62	8.65	34.11	171	234	Peak

REMARKS:

- Emission Level = Read Level + Antenna Factor + Cable Loss - Preamp Factor
Margin value = Emission level – Limit value
- 5510MHz: Fundamental frequency.
- 5470MHz & 5725MHz: Out of restricted band



A D T

EUT TEST CONDITION		MEASUREMENT DETAIL	
CHANNEL	Channel 110	FREQUENCY RANGE	1GHz ~ 40GHz
INPUT POWER	120Vac, 60 Hz	DETECTOR FUNCTION	Peak (PK) Average (AV)
ENVIRONMENTAL CONDITIONS	25deg. C, 65%RH	TESTED BY	Will Chen

ANTENNA POLARITY & TEST DISTANCE: HORIZONTAL AT 3 M										
FREQ. (MHz)	EMISSION LEVEL (dBuV/m)	READ LEVEL (dBuV)	LIMIT (dBuV/m)	MARGIN (dB)	ANTENNA FACTOR (dB/m)	CABLE LOSS (dB)	PREAMP FACTOR (dB)	ANTENNA HEIGHT (cm)	TABLE ANGLE (Degree)	REMARK
5438	43.16	34.37	54	-10.84	34.35	8.48	34.04	184	327	Average
5438	57.49	48.7	74	-16.51	34.35	8.48	34.04	184	327	Peak
5470	56.15	47.32	68.2	-12.05	34.37	8.51	34.05	184	327	Peak
5550	97.79	88.82			34.45	8.59	34.07	184	327	Average
5550	105.25	96.28			34.45	8.59	34.07	184	327	Peak
5725	55.55	46.39	68.2	-12.65	34.62	8.65	34.11	184	327	Peak
ANTENNA POLARITY & TEST DISTANCE: VERTICAL AT 3 M										
FREQ. (MHz)	EMISSION LEVEL (dBuV/m)	READ LEVEL (dBuV)	LIMIT (dBuV/m)	MARGIN (dB)	ANTENNA FACTOR (dB/m)	CABLE LOSS (dB)	PREAMP FACTOR (dB)	ANTENNA HEIGHT (cm)	TABLE ANGLE (Degree)	REMARK
5384	43.79	35.11	54	-10.21	34.31	8.41	34.04	184	224	Average
5384	58.97	50.29	74	-15.03	34.31	8.41	34.04	184	224	Peak
5470	56.31	47.48	68.2	-11.89	34.37	8.51	34.05	184	224	Peak
5550	98.93	89.96			34.45	8.59	34.07	184	224	Average
5550	106.85	97.88			34.45	8.59	34.07	184	224	Peak
5725	56.68	47.52	68.2	-11.52	34.62	8.65	34.11	184	224	Peak

REMARKS:

- Emission Level = Read Level + Antenna Factor + Cable Loss - Preamp Factor
Margin value = Emission level – Limit value
- 5550MHz: Fundamental frequency.
- 5470MHz & 5725MHz: Out of restricted band



A D T

EUT TEST CONDITION		MEASUREMENT DETAIL	
CHANNEL	Channel 134	FREQUENCY RANGE	1GHz ~ 40GHz
INPUT POWER	120Vac, 60 Hz	DETECTOR FUNCTION	Peak (PK) Average (AV)
ENVIRONMENTAL CONDITIONS	25deg. C, 65%RH	TESTED BY	Will Chen

ANTENNA POLARITY & TEST DISTANCE: HORIZONTAL AT 3 M										
FREQ. (MHz)	EMISSION LEVEL (dBuV/m)	READ LEVEL (dBuV)	LIMIT (dBuV/m)	MARGIN (dB)	ANTENNA FACTOR (dB/m)	CABLE LOSS (dB)	PREAMP FACTOR (dB)	ANTENNA HEIGHT (cm)	TABLE ANGLE (Degree)	REMARK
5416	43.04	34.31	54	-10.96	34.33	8.44	34.04	179	326	Average
5416	57.84	49.11	74	-16.16	34.33	8.44	34.04	179	326	Peak
5470	57.18	48.35	68.2	-11.02	34.37	8.51	34.05	179	326	Peak
5670	98.14	89.04			34.57	8.63	34.1	179	326	Average
5670	105.87	96.77			34.57	8.63	34.1	179	326	Peak
5725	56.75	47.59	68.2	-11.45	34.62	8.65	34.11	179	326	Peak
ANTENNA POLARITY & TEST DISTANCE: VERTICAL AT 3 M										
FREQ. (MHz)	EMISSION LEVEL (dBuV/m)	READ LEVEL (dBuV)	LIMIT (dBuV/m)	MARGIN (dB)	ANTENNA FACTOR (dB/m)	CABLE LOSS (dB)	PREAMP FACTOR (dB)	ANTENNA HEIGHT (cm)	TABLE ANGLE (Degree)	REMARK
5446	43.16	34.33	54	-10.84	34.36	8.51	34.04	189	232	Average
5446	57.56	48.73	74	-16.44	34.36	8.51	34.04	189	232	Peak
5470	55.77	46.94	68.2	-12.43	34.37	8.51	34.05	189	232	Peak
5670	98.55	89.45			34.57	8.63	34.1	189	232	Average
5670	106.53	97.43			34.57	8.63	34.1	189	232	Peak
5725	57.06	47.9	68.2	-11.14	34.62	8.65	34.11	189	232	Peak

REMARKS:

- Emission Level = Read Level + Antenna Factor + Cable Loss - Preamp Factor
Margin value = Emission level – Limit value
- 5670MHz: Fundamental frequency.
- 5470MHz & 5725MHz: Out of restricted band



A D T

EUT TEST CONDITION		MEASUREMENT DETAIL	
CHANNEL	Channel 151	FREQUENCY RANGE	1GHz ~ 40GHz
INPUT POWER	120Vac, 60 Hz	DETECTOR FUNCTION	Peak (PK) Average (AV)
ENVIRONMENTAL CONDITIONS	25deg. C, 65%RH	TESTED BY	Will Chen

ANTENNA POLARITY & TEST DISTANCE: HORIZONTAL AT 3 M

FREQ. (MHz)	EMISSION LEVEL (dBuV/m)	READ LEVEL (dBuV)	LIMIT (dBuV/m)	MARGIN (dB)	ANTENNA FACTOR (dB/m)	CABLE LOSS (dB)	PREAMP FACTOR (dB)	ANTENNA HEIGHT (cm)	TABLE ANGLE (Degree)	REMARK
*5714	57.98	48.83	68.2	-10.22	34.61	8.65	34.11	193	319	Peak
*5724	67.1	57.94	78.2	-11.1	34.62	8.65	34.11	193	319	Peak
5755	97.25	88.04			34.66	8.66	34.11	193	319	Average
5755	105	95.79			34.66	8.66	34.11	193	319	Peak
*5860	58.13	48.81	78.2	-20.07	34.76	8.7	34.14	193	319	Peak
*5868	57.71	48.38	68.2	-10.49	34.76	8.71	34.14	193	319	Peak

ANTENNA POLARITY & TEST DISTANCE: VERTICAL AT 3 M

FREQ. (MHz)	EMISSION LEVEL (dBuV/m)	READ LEVEL (dBuV)	LIMIT (dBuV/m)	MARGIN (dB)	ANTENNA FACTOR (dB/m)	CABLE LOSS (dB)	PREAMP FACTOR (dB)	ANTENNA HEIGHT (cm)	TABLE ANGLE (Degree)	REMARK
*5706	58.5	49.35	68.2	-9.7	34.61	8.65	34.11	177	230	Peak
*5724	67.8	58.64	78.2	-10.4	34.62	8.65	34.11	177	230	Peak
5755	99.01	89.8			34.66	8.66	34.11	177	230	Average
5755	106.61	97.4			34.66	8.66	34.11	177	230	Peak
*5856	57.98	48.66	78.2	-20.22	34.76	8.7	34.14	177	230	Peak
*5864	57.83	48.5	68.2	-10.37	34.76	8.71	34.14	177	230	Peak

REMARKS:

- Emission Level = Read Level + Antenna Factor + Cable Loss - Preamp Factor
Margin value = Emission level – Limit value
- 5755MHz: Fundamental frequency.
- *: Out of restricted band



A D T

EUT TEST CONDITION		MEASUREMENT DETAIL	
CHANNEL	Channel 159	FREQUENCY RANGE	1GHz ~ 40GHz
INPUT POWER	120Vac, 60 Hz	DETECTOR FUNCTION	Peak (PK) Average (AV)
ENVIRONMENTAL CONDITIONS	25deg. C, 65%RH	TESTED BY	Will Chen

ANTENNA POLARITY & TEST DISTANCE: HORIZONTAL AT 3 M

FREQ. (MHz)	EMISSION LEVEL (dBuV/m)	READ LEVEL (dBuV)	LIMIT (dBuV/m)	MARGIN (dB)	ANTENNA FACTOR (dB/m)	CABLE LOSS (dB)	PREAMP FACTOR (dB)	ANTENNA HEIGHT (cm)	TABLE ANGLE (Degree)	REMARK
*5708	57.63	48.48	68.2	-10.57	34.61	8.65	34.11	199	311	Peak
*5718	56.74	47.58	78.2	-21.46	34.62	8.65	34.11	199	311	Peak
5795	97.01	87.77			34.69	8.68	34.13	199	311	Average
5795	105.55	96.31			34.69	8.68	34.13	199	311	Peak
*5856	58.29	48.97	78.2	-19.91	34.76	8.7	34.14	199	311	Peak
*5868	57.3	47.97	68.2	-10.9	34.76	8.71	34.14	199	311	Peak

ANTENNA POLARITY & TEST DISTANCE: VERTICAL AT 3 M

FREQ. (MHz)	EMISSION LEVEL (dBuV/m)	READ LEVEL (dBuV)	LIMIT (dBuV/m)	MARGIN (dB)	ANTENNA FACTOR (dB/m)	CABLE LOSS (dB)	PREAMP FACTOR (dB)	ANTENNA HEIGHT (cm)	TABLE ANGLE (Degree)	REMARK
*5710	57.4	48.25	68.2	-10.8	34.61	8.65	34.11	178	213	Peak
*5724	56.83	47.67	78.2	-21.37	34.62	8.65	34.11	178	213	Peak
5795	98.58	89.34			34.69	8.68	34.13	178	213	Average
5795	106.89	97.65			34.69	8.68	34.13	178	213	Peak
*5860	56.9	47.58	78.2	-21.3	34.76	8.7	34.14	178	213	Peak
*5864	56.99	47.66	68.2	-11.21	34.76	8.71	34.14	178	213	Peak

REMARKS:

- Emission Level = Read Level + Antenna Factor + Cable Loss - Preamp Factor
Margin value = Emission level – Limit value
- 5795MHz: Fundamental frequency.
- *: Out of restricted band



A D T

BELOW 1GHz WORST-CASE DATA:

802.11n (20MHz)

EUT TEST CONDITION		MEASUREMENT DETAIL	
CHANNEL	Channel 36	FREQUENCY RANGE	30MHz ~ 1GHz
INPUT POWER	120Vac, 60 Hz	DETECTOR FUNCTION	Peak (PK)
ENVIRONMENTAL CONDITIONS	25deg. C, 65%RH	TESTED BY	Will Chen

ANTENNA POLARITY & TEST DISTANCE: HORIZONTAL AT 3 M

FREQ. (MHz)	EMISSION LEVEL (dBuV/m)	READ LEVEL (dBuV)	LIMIT (dBuV/m)	MARGIN (dB)	ANTENNA FACTOR (dB/m)	CABLE LOSS (dB)	PREAMP FACTOR (dB)	ANTENNA HEIGHT (cm)	TABLE ANGLE (Degree)	REMARK
96.96	19.99	41.35	43.5	-23.51	9.46	1.28	32.1	149	279	Peak
142.86	27.12	48.46	43.5	-16.38	9.55	1.38	32.27	159	225	Peak
233.58	19.35	37.41	46	-26.65	12.25	1.85	32.16	122	99	Peak
332.9	26.56	40.83	46	-19.44	15.63	2.19	32.09	184	215	Peak
470.1	22.19	33.04	46	-23.81	18.72	2.56	32.13	113	351	Peak
938.4	28.86	30.24	46	-17.14	26.2	3.62	31.2	149	278	Peak

ANTENNA POLARITY & TEST DISTANCE: VERTICAL AT 3 M

FREQ. (MHz)	EMISSION LEVEL (dBuV/m)	READ LEVEL (dBuV)	LIMIT (dBuV/m)	MARGIN (dB)	ANTENNA FACTOR (dB/m)	CABLE LOSS (dB)	PREAMP FACTOR (dB)	ANTENNA HEIGHT (cm)	TABLE ANGLE (Degree)	REMARK
35.67	29.25	46.86	40	-10.75	13.88	0.74	32.23	115	208	Peak
47.82	27.62	50.46	40	-12.38	8.48	0.9	32.22	142	349	Peak
159.06	17.76	37.77	43.5	-25.74	10.74	1.52	32.27	119	283	Peak
326.6	20.01	34.71	46	-25.99	15.29	2.11	32.1	112	325	Peak
467.3	21.2	32.14	46	-24.8	18.63	2.56	32.13	143	247	Peak
800.5	26.19	30.33	46	-19.81	24.6	3.32	32.06	159	29	Peak

REMARKS: Emission Level = Read Level + Antenna Factor + Cable Loss - Preamp Factor

Margin value = Emission level – Limit value



A D T

802.11n (20MHz)

EUT TEST CONDITION		MEASUREMENT DETAIL	
CHANNEL	Channel 64	FREQUENCY RANGE	30MHz ~ 1GHz
INPUT POWER	120Vac, 60 Hz	DETECTOR FUNCTION	Peak (PK)
ENVIRONMENTAL CONDITIONS	25deg. C, 65%RH	TESTED BY	Will Chen

ANTENNA POLARITY & TEST DISTANCE: HORIZONTAL AT 3 M										
FREQ. (MHz)	EMISSION LEVEL (dBuV/m)	READ LEVEL (dBuV)	LIMIT (dBuV/m)	MARGIN (dB)	ANTENNA FACTOR (dB/m)	CABLE LOSS (dB)	PREAMP FACTOR (dB)	ANTENNA HEIGHT (cm)	TABLE ANGLE (Degree)	REMARK
103.98	20.33	41.73	43.5	-23.17	9.58	1.28	32.26	185	178	Peak
142.32	26.12	47.53	43.5	-17.38	9.48	1.38	32.27	189	251	Peak
227.37	18.99	37.31	46	-27.01	12.02	1.85	32.19	119	263	Peak
329.4	27.4	41.84	46	-18.6	15.46	2.19	32.09	156	328	Peak
431.6	22.25	34.23	46	-23.75	17.78	2.41	32.17	121	162	Peak
805.4	25.63	29.96	46	-20.37	24.38	3.32	32.03	197	329	Peak
ANTENNA POLARITY & TEST DISTANCE: VERTICAL AT 3 M										
FREQ. (MHz)	EMISSION LEVEL (dBuV/m)	READ LEVEL (dBuV)	LIMIT (dBuV/m)	MARGIN (dB)	ANTENNA FACTOR (dB/m)	CABLE LOSS (dB)	PREAMP FACTOR (dB)	ANTENNA HEIGHT (cm)	TABLE ANGLE (Degree)	REMARK
31.62	28.42	43.37	40	-11.58	16.57	0.74	32.26	141	302	Peak
48.09	27.64	50.56	40	-12.36	8.4	0.9	32.22	164	185	Peak
154.74	18.24	38.54	43.5	-25.26	10.45	1.52	32.27	156	306	Peak
326.6	20.82	35.52	46	-25.18	15.29	2.11	32.1	149	262	Peak
473.6	20.65	31.4	46	-25.35	18.81	2.56	32.12	179	118	Peak
729.1	24.89	30.48	46	-21.11	23.37	3.16	32.12	138	242	Peak

REMARKS: Emission Level = Read Level + Antenna Factor + Cable Loss - Preamp Factor

Margin value = Emission level – Limit value



A D T

802.11n (40MHz)

EUT TEST CONDITION		MEASUREMENT DETAIL	
CHANNEL	Channel 102	FREQUENCY RANGE	30MHz ~ 1GHz
INPUT POWER	120Vac, 60 Hz	DETECTOR FUNCTION	Peak (PK)
ENVIRONMENTAL CONDITIONS	25deg. C, 65%RH	TESTED BY	Will Chen

ANTENNA POLARITY & TEST DISTANCE: HORIZONTAL AT 3 M										
FREQ. (MHz)	EMISSION LEVEL (dBuV/m)	READ LEVEL (dBuV)	LIMIT (dBuV/m)	MARGIN (dB)	ANTENNA FACTOR (dB/m)	CABLE LOSS (dB)	PREAMP FACTOR (dB)	ANTENNA HEIGHT (cm)	TABLE ANGLE (Degree)	REMARK
98.31	20.5	41.83	43.5	-23	9.54	1.28	32.15	134	254	Peak
138.27	26.49	48.1	43.5	-17.01	9.28	1.38	32.27	156	295	Peak
278.4	19.92	36.27	46	-26.08	13.74	2.03	32.12	105	243	Peak
332.9	26.27	40.54	46	-19.73	15.63	2.19	32.09	167	199	Peak
689.2	24.91	30.73	46	-21.09	23.23	3.05	32.1	109	64	Peak
928.6	29.29	30.74	46	-16.71	26.2	3.62	31.27	161	165	Peak
ANTENNA POLARITY & TEST DISTANCE: VERTICAL AT 3 M										
FREQ. (MHz)	EMISSION LEVEL (dBuV/m)	READ LEVEL (dBuV)	LIMIT (dBuV/m)	MARGIN (dB)	ANTENNA FACTOR (dB/m)	CABLE LOSS (dB)	PREAMP FACTOR (dB)	ANTENNA HEIGHT (cm)	TABLE ANGLE (Degree)	REMARK
31.89	28.06	43.25	40	-11.94	16.33	0.74	32.26	154	43	Peak
47.82	27.23	50.07	40	-12.77	8.48	0.9	32.22	175	283	Peak
143.13	18.16	39.5	43.5	-25.34	9.55	1.38	32.27	164	358	Peak
326.6	21	35.7	46	-25	15.29	2.11	32.1	117	331	Peak
680.1	24.94	30.69	46	-21.06	23.31	3.05	32.11	101	176	Peak
927.9	28.73	30.18	46	-17.27	26.2	3.62	31.27	172	76	Peak

REMARKS: Emission Level = Read Level + Antenna Factor + Cable Loss - Preamp Factor

Margin value = Emission level – Limit value



A D T

802.11n (20MHz)

EUT TEST CONDITION		MEASUREMENT DETAIL	
CHANNEL	Channel 149	FREQUENCY RANGE	30MHz ~ 1GHz
INPUT POWER	120Vac, 60 Hz	DETECTOR FUNCTION	Peak (PK)
ENVIRONMENTAL CONDITIONS	25deg. C, 65%RH	TESTED BY	Will Chen

ANTENNA POLARITY & TEST DISTANCE: HORIZONTAL AT 3 M										
FREQ. (MHz)	EMISSION LEVEL (dBuV/m)	READ LEVEL (dBuV)	LIMIT (dBuV/m)	MARGIN (dB)	ANTENNA FACTOR (dB/m)	CABLE LOSS (dB)	PREAMP FACTOR (dB)	ANTENNA HEIGHT (cm)	TABLE ANGLE (Degree)	REMARK
98.04	20.12	41.45	43.5	-23.38	9.54	1.28	32.15	112	332	Peak
142.32	26.31	47.72	43.5	-17.19	9.48	1.38	32.27	188	108	Peak
278.4	19.68	36.03	46	-26.32	13.74	2.03	32.12	103	128	Peak
329.4	26.71	41.15	46	-19.29	15.46	2.19	32.09	142	315	Peak
431.6	22.96	34.94	46	-23.04	17.78	2.41	32.17	158	299	Peak
673.8	24.99	30.66	46	-21.01	23.4	3.05	32.12	171	91	Peak
ANTENNA POLARITY & TEST DISTANCE: VERTICAL AT 3 M										
FREQ. (MHz)	EMISSION LEVEL (dBuV/m)	READ LEVEL (dBuV)	LIMIT (dBuV/m)	MARGIN (dB)	ANTENNA FACTOR (dB/m)	CABLE LOSS (dB)	PREAMP FACTOR (dB)	ANTENNA HEIGHT (cm)	TABLE ANGLE (Degree)	REMARK
31.62	28.27	43.22	40	-11.73	16.57	0.74	32.26	128	179	Peak
48.09	27.75	50.67	40	-12.25	8.4	0.9	32.22	167	311	Peak
158.25	17.95	38.02	43.5	-25.55	10.68	1.52	32.27	142	169	Peak
326.6	20.14	34.84	46	-25.86	15.29	2.11	32.1	105	118	Peak
535.2	22.23	31.18	46	-23.77	20.52	2.7	32.17	129	9	Peak
942.6	28.43	29.77	46	-17.57	26.2	3.62	31.16	135	242	Peak

REMARKS: Emission Level = Read Level + Antenna Factor + Cable Loss - Preamp Factor

Margin value = Emission level – Limit value

4.2 CONDUCTED EMISSION MEASUREMENT

4.2.1 LIMITS OF CONDUCTED EMISSION MEASUREMENT

FREQUENCY OF EMISSION (MHz)	CONDUCTED LIMIT (dB μ V)	
	Quasi-peak	Average
0.15 ~ 0.5	66 to 56	56 to 46
0.5 ~ 5	56	46
5 ~ 30	60	50

NOTE:

1. The lower limit shall apply at the transition frequencies.
2. The limit decreases in line with the logarithm of the frequency in the range of 0.15 to 0.50MHz.
3. All emanations from a class A/B digital device or system, including any network of conductors and apparatus connected thereto, shall not exceed the level of field strengths specified above.

4.2.2 TEST INSTRUMENTS

DESCRIPTION & MANUFACTURER	MODEL NO.	SERIAL NO.	DATE OF CALIBRATION	DUE DATE OF CALIBRATION
Test Receiver ROHDE & SCHWARZ	ESCI	100613	Nov. 11, 2014	Nov. 10, 2015
RF signal cable Woken	5D-FB	Cable-HYC01-01	Dec. 26, 2014	Dec. 25, 2015
LISN ROHDE & SCHWARZ (EUT)	ESH3-Z5	835239/001	Mar. 02, 2015	Mar. 01, 2016
LISN ROHDE & SCHWARZ (Peripheral)	ESH3-Z5	100311	Jul. 21, 2014	Jul. 20, 2015
Software ADT	BV ADT_Cond_ V7.3.7.3	NA	NA	NA

- NOTE:**
1. The calibration interval of the above test instruments is 12 months and the calibrations are traceable to NML/ROC and NIST/USA.
 2. The test was performed in HwaYa Shielded Room 1.
 3. The VCCI Site Registration No. is C-2040.

4.2.3 TEST PROCEDURES

- a. The EUT was placed 0.4 meters from the conducting wall of the shielded room with EUT being connected to the power mains through a line impedance stabilization network (LISN). Other support units were connected to the power mains through another LISN. The two LISNs provide 50 ohm/ 50uH of coupling impedance for the measuring instrument.
- b. Both lines of the power mains connected to the EUT were checked for maximum conducted interference.
- c. The frequency range from 150kHz to 30MHz was searched. Emission levels under (Limit - 20dB) was not recorded.

NOTE: All modes of operation were investigated and the worst-case emissions are reported.

4.2.4 DEVIATION FROM TEST STANDARD

No deviation.

4.2.5 TEST SETUP

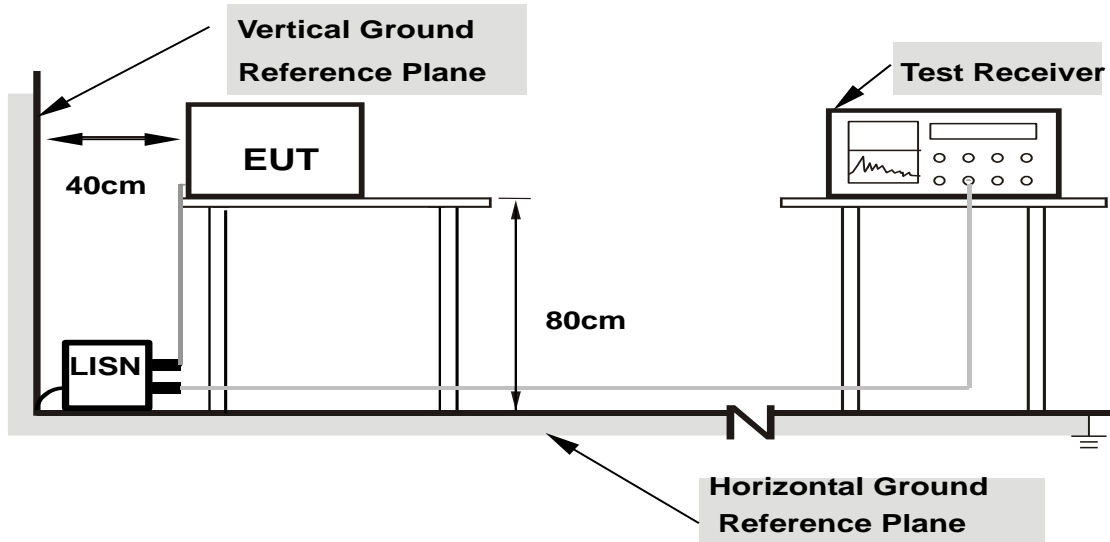

- Note:**
1. Support units were connected to second LISN.
 2. Both of LISNs (AMN) are 80 cm from EUT and at least 80 from other units and other metal planes

For the actual test configuration, please refer to the attached file (Test Setup Photo).

4.2.6 EUT OPERATING CONDITIONS

Same as section 4.1.6.

4.2.7 TEST RESULTS

CONDUCTED WORST-CASE DATA :

MODE A

Frequency Range	150kHz ~ 30MHz	Detector Function & Resolution Bandwidth	Quasi-Peak (QP) / Average (AV), 9kHz
Input Power	120Vac, 60Hz	Environmental Conditions	25°C, 65%RH
Tested by	Anson Lin	Test Date	2015/3/27

Phase Of Power : Line (L)										
No	Frequency (MHz)	Correction Factor (dB)	Reading Value (dBuV)		Emission Level (dBuV)		Limit (dBuV)		Margin (dB)	
			Q.P.	AV.	Q.P.	AV.	Q.P.	AV.	Q.P.	AV.
1	0.19305	0.06	35.10	14.22	35.16	14.28	63.90	53.90	-28.75	-39.63
2	0.22434	0.06	34.23	14.85	34.29	14.91	62.66	52.66	-28.37	-37.75
3	0.52130	0.06	40.59	27.94	40.65	28.00	56.00	46.00	-15.35	-18.00
4	0.89290	0.08	39.04	29.04	39.12	29.12	56.00	46.00	-16.88	-16.88
5	1.28781	0.09	36.87	27.34	36.96	27.43	56.00	46.00	-19.04	-18.57
6	2.97302	0.15	32.67	20.51	32.82	20.66	56.00	46.00	-23.18	-25.34

Remarks:

1. Q.P. and AV. are abbreviations of quasi-peak and average individually.
2. The emission levels of other frequencies were very low against the limit.
3. Margin value = Emission level – Limit value
4. Correction factor = Insertion loss + Cable loss
5. Emission Level = Correction Factor + Reading Value

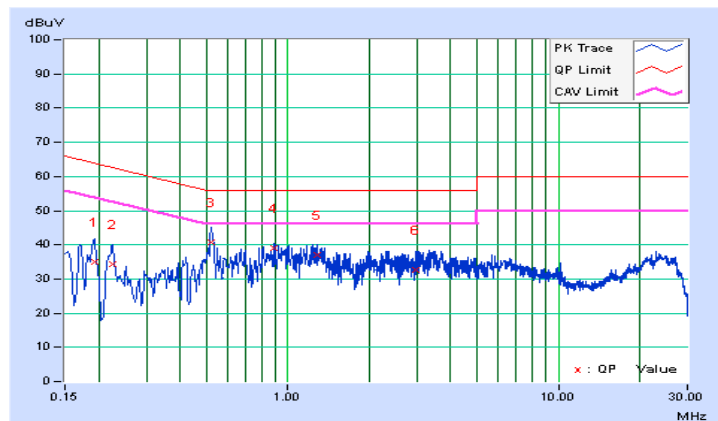



A D T

Frequency Range	150kHz ~ 30MHz	Detector Function & Resolution Bandwidth	Quasi-Peak (QP) / Average (AV), 9kHz
Input Power	120Vac, 60Hz	Environmental Conditions	25°C, 65%RH
Tested by	Anson Lin	Test Date	2015/3/27

Phase Of Power : Neutral (N)										
No	Frequency (MHz)	Correction Factor (dB)	Reading Value (dBuV)		Emission Level (dBuV)		Limit (dBuV)		Margin (dB)	
			Q.P.	AV.	Q.P.	AV.	Q.P.	AV.	Q.P.	AV.
1	0.16967	0.05	39.31	16.95	39.36	17.00	64.98	54.98	-25.62	-37.98
2	0.25166	0.05	34.26	12.53	34.31	12.58	61.70	51.70	-27.39	-39.12
3	0.53381	0.06	38.20	21.94	38.26	22.00	56.00	46.00	-17.74	-24.00
4	0.92027	0.08	30.54	18.97	30.62	19.05	56.00	46.00	-25.38	-26.95
5	2.40607	0.13	30.86	20.08	30.99	20.21	56.00	46.00	-25.01	-25.79
6	23.36758	0.78	37.47	24.04	38.25	24.82	60.00	50.00	-21.75	-25.18

Remarks:

1. Q.P. and AV. are abbreviations of quasi-peak and average individually.
2. The emission levels of other frequencies were very low against the limit.
3. Margin value = Emission level – Limit value
4. Correction factor = Insertion loss + Cable loss
5. Emission Level = Correction Factor + Reading Value

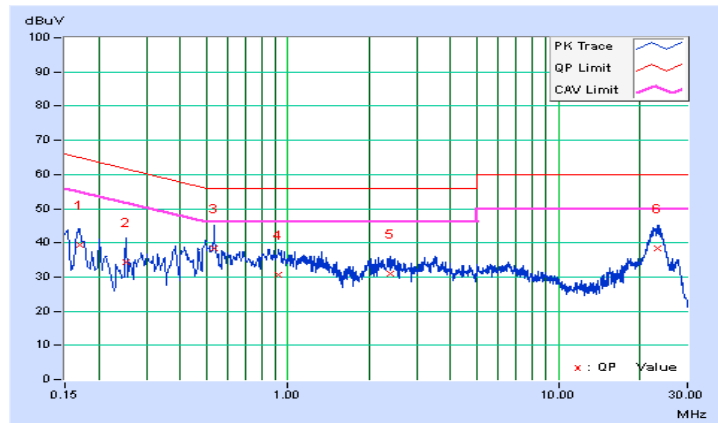



A D T

MODE B

Frequency Range	150kHz ~ 30MHz	Detector Function & Resolution Bandwidth	Quasi-Peak (QP) / Average (AV), 9kHz
Input Power	120Vac, 60Hz	Environmental Conditions	25°C, 65%RH
Tested by	Anson Lin	Test Date	2015/4/3

Phase Of Power : Line (L)										
No	Frequency (MHz)	Correction Factor (dB)	Reading Value (dBuV)		Emission Level (dBuV)		Limit (dBuV)		Margin (dB)	
			Q.P.	AV.	Q.P.	AV.	Q.P.	AV.	Q.P.	AV.
1	0.17328	0.05	45.89	28.79	45.94	28.84	64.80	54.80	-18.86	-25.96
2	0.25166	0.06	46.69	34.60	46.75	34.66	61.70	51.70	-14.95	-17.04
3	4.68063	0.22	42.89	37.34	43.11	37.56	56.00	46.00	-12.89	-8.44
4	5.33075	0.25	48.20	42.86	48.45	43.11	60.00	50.00	-11.55	-6.89
5	6.42129	0.29	44.06	37.46	44.35	37.75	60.00	50.00	-15.65	-12.25
6	12.51733	0.56	40.95	38.01	41.51	38.57	60.00	50.00	-18.49	-11.43

Remarks:

1. Q.P. and AV. are abbreviations of quasi-peak and average individually.
2. The emission levels of other frequencies were very low against the limit.
3. Margin value = Emission level – Limit value
4. Correction factor = Insertion loss + Cable loss
5. Emission Level = Correction Factor + Reading Value

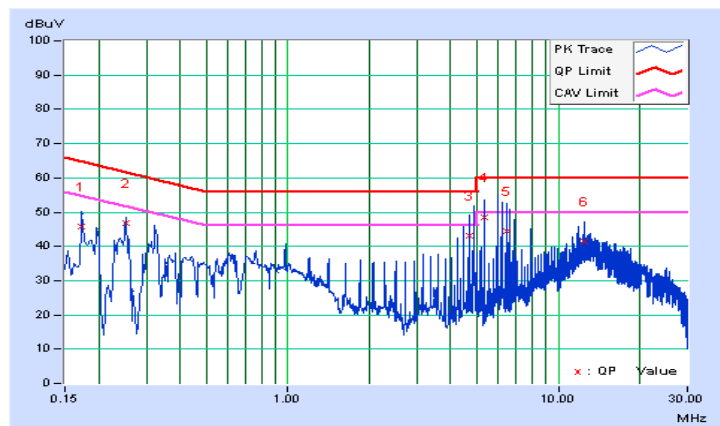



A D T

Frequency Range	150kHz ~ 30MHz	Detector Function & Resolution Bandwidth	Quasi-Peak (QP) / Average (AV), 9kHz
Input Power	120Vac, 60Hz	Environmental Conditions	25°C, 65%RH
Tested by	Anson Lin	Test Date	2015/4/3

Phase Of Power : Neutral (N)										
No	Frequency (MHz)	Correction Factor (dB)	Reading Value (dBuV)		Emission Level (dBuV)		Limit (dBuV)		Margin (dB)	
			Q.P.	AV.	Q.P.	AV.	Q.P.	AV.	Q.P.	AV.
1	0.17512	0.05	39.96	26.95	40.01	27.00	64.71	54.71	-24.70	-27.71
2	0.32595	0.06	45.83	44.31	45.89	44.37	59.55	49.55	-13.67	-5.19
3	1.63189	0.10	34.74	33.79	34.84	33.89	56.00	46.00	-21.16	-12.11
4	6.20507	0.27	45.44	37.94	45.71	38.21	60.00	50.00	-14.29	-11.79
5	6.42164	0.28	44.33	37.41	44.61	37.69	60.00	50.00	-15.39	-12.31
6	12.72847	0.50	37.73	32.55	38.23	33.05	60.00	50.00	-21.77	-16.95

Remarks:

1. Q.P. and AV. are abbreviations of quasi-peak and average individually.
2. The emission levels of other frequencies were very low against the limit.
3. Margin value = Emission level – Limit value
4. Correction factor = Insertion loss + Cable loss
5. Emission Level = Correction Factor + Reading Value

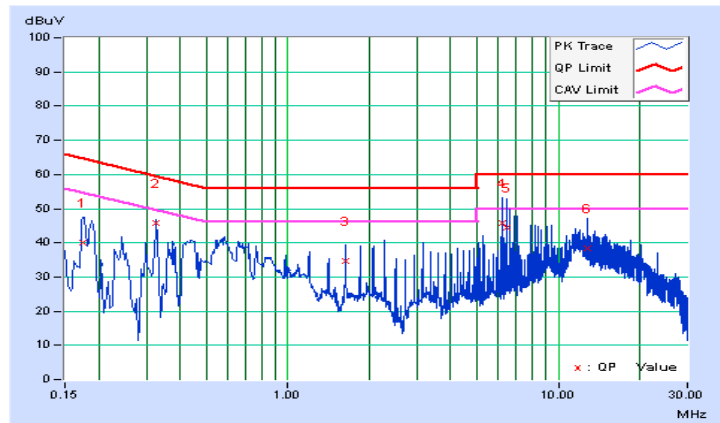

4.3 TRANSMIT POWER MEASUREMENT

4.3.1 LIMITS OF TRANSMIT POWER MEASUREMENT

OPERATION BAND	EUT CATEGORY		LIMIT
U-NII-1		Outdoor Access Point	1 Watt (30 dBm) (Max. e.i.r.p \leq 125mW(21 dBm) at any elevation angle above 30 degrees as measured from the horizon)
		Fixed point-to-point Access Point	1 Watt (30 dBm)
		Indoor Access Point	1 Watt (30 dBm)
	√	Mobile and Portable client device	250mW (24 dBm)
U-NII-2A	√	---	250mW (24 dBm) or 11 dBm+10 log B*
U-NII-2C	√	---	250mW (24 dBm) or 11 dBm+10 log B*
U-NII-3	√	---	1 Watt (30 dBm)

NOTE: Where B is the 26dB emission bandwidth in MHz.

4.3.2 TEST SETUP

FOR POWER OUTPUT MEASUREMENT

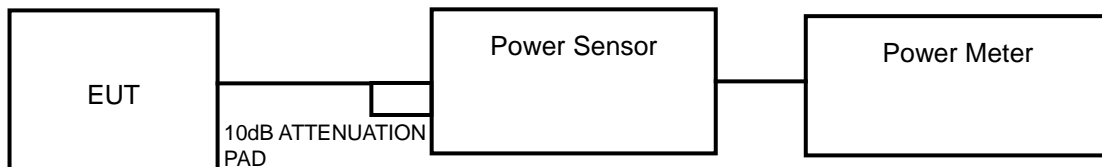

FOR 26dB BANDWIDTH

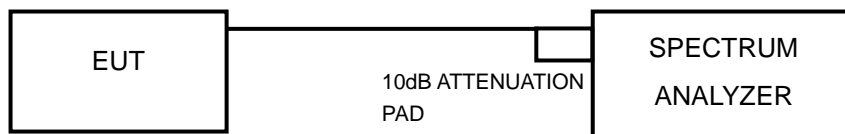

4.3.3 TEST INSTRUMENTS

Refer to section 4.1.3 to get information of above instrument.

4.3.4 TEST PROCEDURE

FOR AVERAGE POWER MEASUREMENT

<802.11a, 802.11n (20MHz), 802.11n (40MHz)>

Method PM is used to perform output power measurement, trigger and gating function of wide band power meter is enabled to measure max output power of TX on burst. Duty factor is not added to measured value.

FOR 26dB BANDWIDTH

- 1) Set RBW = approximately 1% of the emission bandwidth.
- 2) Set the VBW > RBW.
- 3) Detector = Peak.
- 4) Trace mode = max hold.
- 5) Measure the maximum width of the emission that is 26 dB down from the peak of the emission.
Compare this with the RBW setting of the analyzer. Readjust RBW and repeat measurement as needed until the RBW/EBW ratio is approximately 1%.

4.3.5 DEVIATION FROM TEST STANDARD

No deviation.

4.3.6 EUT OPERATING CONDITIONS

The software provided by client to enable the EUT under transmission condition continuously at specific channel frequencies individually.



A D T

4.3.7 TEST RESULTS

POWER OUTPUT

802.11a

CHANNEL	CHANNEL FREQUENCY (MHz)	MAX. CONDUCTED POWER (mW)	MAX. CONDUCTED POWER (dBm)	POWER LIMIT (dBm)	PASS/FAIL
36	5180	7.55	8.78	24	PASS
44	5220	7.83	8.94	24	PASS
48	5240	7.64	8.83	24	PASS
52	5260	7.76	8.90	24	PASS
60	5300	7.91	8.98	24	PASS
64	5320	7.85	8.95	24	PASS
100	5500	7.66	8.84	24	PASS
116	5580	7.53	8.77	24	PASS
140	5700	7.14	8.54	24	PASS
149	5745	7.24	8.6	30	PASS
157	5785	7.31	8.64	30	PASS
165	5825	6.92	8.4	30	PASS

NOTE:

For U-NII-2A, U-NII-2C Band:

1. $11\text{dBm} + 10\log(22.53) = 24.53\text{ dBm} > 24\text{dBm}$.
2. $11\text{dBm} + 10\log(22.56) = 24.53\text{ dBm} > 24\text{dBm}$.
3. $11\text{dBm} + 10\log(22.67) = 24.55\text{ dBm} > 24\text{dBm}$.
4. $11\text{dBm} + 10\log(22.76) = 24.57\text{ dBm} > 24\text{dBm}$.
5. $11\text{dBm} + 10\log(22.44) = 24.51\text{ dBm} > 24\text{dBm}$.
6. $11\text{dBm} + 10\log(22.61) = 24.54\text{ dBm} > 24\text{dBm}$.



A D T

802.11n (20MHz)

CHANNEL	CHANNEL FREQUENCY (MHz)	MAX. CONDUCTED POWER (mW)	MAX. CONDUCTED POWER (dBm)	POWER LIMIT (dBm)	PASS/FAIL
36	5180	7.53	8.77	24	PASS
44	5220	7.85	8.95	24	PASS
48	5240	7.67	8.85	24	PASS
52	5260	7.60	8.81	24	PASS
60	5300	7.74	8.89	24	PASS
64	5320	7.89	8.97	24	PASS
100	5500	7.74	8.89	24	PASS
116	5580	7.59	8.80	24	PASS
140	5700	7.11	8.52	24	PASS
149	5745	7.36	8.67	30	PASS
157	5785	7.18	8.56	30	PASS
165	5825	6.90	8.39	30	PASS

NOTE:

For U-NII-2A, U-NII-2C Band:

1. $11\text{dBm} + 10\log(23.18) = 24.65\text{ dBm} > 24\text{dBm}$.
2. $11\text{dBm} + 10\log(22.90) = 24.60\text{ dBm} > 24\text{dBm}$.
3. $11\text{dBm} + 10\log(22.74) = 24.57\text{ dBm} > 24\text{dBm}$.
4. $11\text{dBm} + 10\log(22.76) = 24.57\text{ dBm} > 24\text{dBm}$.
5. $11\text{dBm} + 10\log(22.81) = 24.58\text{ dBm} > 24\text{dBm}$.
6. $11\text{dBm} + 10\log(22.77) = 24.57\text{ dBm} > 24\text{dBm}$.



A D T

802.11n (40MHz)

CHANNEL	CHANNEL FREQUENCY (MHz)	MAX. CONDUCTED POWER (mW)	MAX. CONDUCTED POWER (dBm)	POWER LIMIT (dBm)	PASS/FAIL
38	5190	5.97	7.76	24	PASS
46	5230	6.15	7.89	24	PASS
54	5270	6.12	7.87	24	PASS
62	5310	6.40	8.06	24	PASS
102	5510	6.05	7.82	24	PASS
110	5550	5.85	7.67	24	PASS
134	5670	5.82	7.65	24	PASS
151	5755	5.55	7.44	30	PASS
159	5795	5.60	7.48	30	PASS

NOTE:

For U-NII-2A, U-NII-2C Band:

1. $11\text{dBm} + 10\log(45.89) = 27.62\text{ dBm} > 24\text{dBm}$.
2. $11\text{dBm} + 10\log(46.87) = 27.71\text{ dBm} > 24\text{dBm}$.
3. $11\text{dBm} + 10\log(47.09) = 27.73\text{ dBm} > 24\text{dBm}$.
4. $11\text{dBm} + 10\log(48.01) = 27.81\text{ dBm} > 24\text{dBm}$.
5. $11\text{dBm} + 10\log(45.74) = 27.60\text{ dBm} > 24\text{dBm}$.



A D T

26dB BANDWIDTH

802.11a

CHANNEL	CHANNEL FREQUENCY (MHz)	26dBc BANDWIDTH (MHz)	PASS / FAIL
52	5260	22.53	PASS
60	5300	22.56	PASS
64	5320	22.67	PASS
100	5500	22.76	PASS
116	5580	22.44	PASS
140	5700	22.61	PASS

802.11n (20MHz)

CHANNEL	CHANNEL FREQUENCY (MHz)	26dBc BANDWIDTH (MHz)	PASS / FAIL
52	5260	23.18	PASS
60	5300	22.90	PASS
64	5320	22.74	PASS
100	5500	22.76	PASS
116	5580	22.81	PASS
140	5700	22.77	PASS

802.11n (40MHz)

CHANNEL	CHANNEL FREQUENCY (MHz)	26dBc BANDWIDTH (MHz)	PASS / FAIL
54	5270	45.89	PASS
62	5310	46.87	PASS
102	5510	47.09	PASS
110	5550	48.01	PASS
134	5670	45.74	PASS



A D T

SPECTRUM PLOT OF WORST VALUE

802.11a

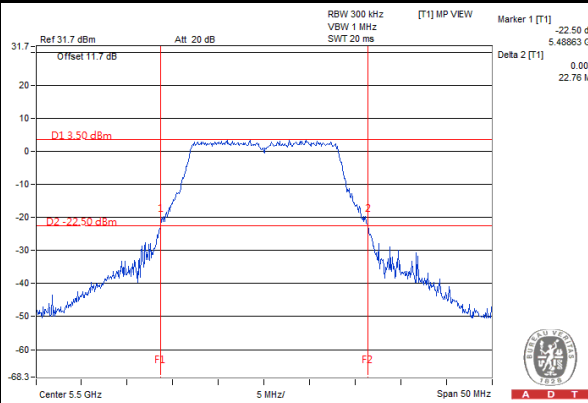

802.11n (20MHz)

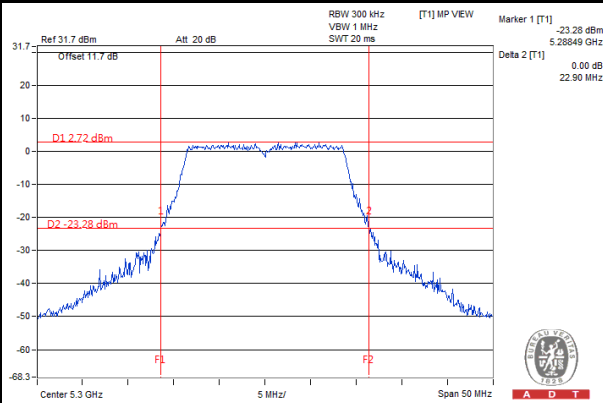

802.11n (40MHz)

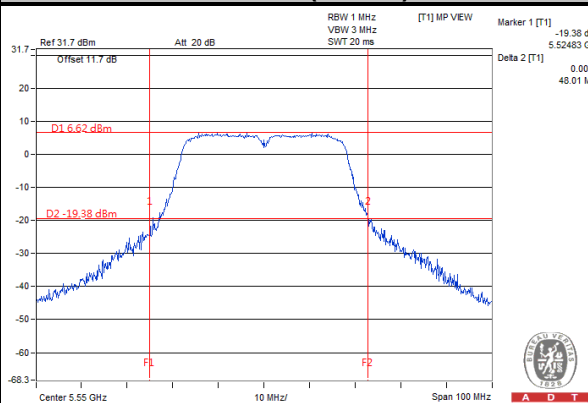

4.4 PEAK POWER SPECTRAL DENSITY MEASUREMENT

4.4.1 LIMITS OF PEAK POWER SPECTRAL DENSITY MEASUREMENT

Operation Band	EUT Category		LIMIT
U-NII-1		Outdoor Access Point	17dBm/ MHz
		Fixed point-to-point Access Point	
		Indoor Access Point	
	√	Mobile and Portable client device	11dBm/ MHz
U-NII-2A	√	---	11dBm/ MHz
U-NII-2C	√	---	11dBm/ MHz
U-NII-3	√	---	30dBm/ 500kHz

4.4.2 TEST SETUP

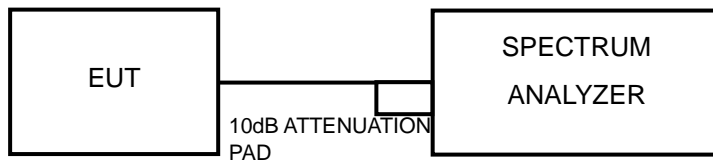

4.4.3 TEST INSTRUMENTS

Refer to section 4.1.3 to get information of above instrument.



A D T

4.4.4 TEST PROCEDURES

For U-NII-1, U-NII-2A, U-NII-2C band:

Using method SA-2 alternative

- 1) Set span to encompass the entire emission bandwidth (EBW) of the signal.
- 2) Set RBW = 30 kHz, Set VBW \geq 1 MHz, Detector = RMS
- 3) Set Channel power measure = 1MHz
- 4) Sweep time = 4 second.
- 5) Perform a single sweep.
- 6) Record the max value and add 10 log (1/duty cycle)

For U-NII-3 band:

- 1) Set span to encompass the entire emission bandwidth (EBW) of the signal.
- 2) Set RBW = 500 kHz, Set VBW \geq 3 RBW, Detector = RMS
- 3) Sweep time = auto, trigger set to "free run".
- 4) Trace average at least 100 traces in power averaging mode.
- 5) Record the max value and add 10 log (1/duty cycle)

4.4.5 DEVIATION FROM TEST STANDARD

No deviation.

4.4.6 EUT OPERATING CONDITIONS

Same as Item 4.3.6.



A D T

4.4.7 TEST RESULTS

For U-NII-1, U-NII-2A, U-NII-2C Band

802.11a

CHANNEL	FREQUENCY (MHz)	PSD W/O DUTY FACTOR (dBm)	DUTY FACTOR	PSD WITH DUTY FACTOR (dBm)	MAXIMUM LIMIT (dBm)	PASS/FAIL
36	5180	-4.04	0.62	-3.42	11	PASS
44	5220	-3.86	0.62	-3.24	11	PASS
48	5240	-4.08	0.62	-3.46	11	PASS
52	5260	-3.83	0.62	-3.21	11	PASS
60	5300	-3.70	0.62	-3.08	11	PASS
64	5320	-3.69	0.62	-3.07	11	PASS
100	5500	-4.11	0.62	-3.49	11	PASS
116	5580	-3.96	0.62	-3.34	11	PASS
140	5700	-4.02	0.62	-3.40	11	PASS

NOTE: Refer to section 3.3 for duty cycle spectrum plot.

802.11n (20MHz)

CHANNEL	FREQUENCY (MHz)	PSD W/O DUTY FACTOR (dBm)	DUTY FACTOR	PSD WITH DUTY FACTOR (dBm)	MAXIMUM LIMIT (dBm)	PASS/FAIL
36	5180	-4.19	0.66	-3.53	11	PASS
44	5220	-4.14	0.66	-3.48	11	PASS
48	5240	-4.20	0.66	-3.54	11	PASS
52	5260	-4.15	0.66	-3.49	11	PASS
60	5300	-3.95	0.66	-3.29	11	PASS
64	5320	-4.02	0.66	-3.36	11	PASS
100	5500	-4.20	0.66	-3.54	11	PASS
116	5580	-4.16	0.66	-3.50	11	PASS
140	5700	-4.31	0.66	-3.65	11	PASS

NOTE: Refer to section 3.3 for duty cycle spectrum plot.



A D T

802.11n (40MHz)

CHANNEL	FREQUENCY (MHz)	PSD W/O DUTY FACTOR (dBm)	DUTY FACTOR	PSD WITH DUTY FACTOR (dBm)	MAXIMUM LIMIT (dBm)	PASS/FAIL
38	5190	-8.65	1.41	-7.24	11	PASS
46	5230	-8.62	1.41	-7.21	11	PASS
54	5270	-8.73	1.41	-7.32	11	PASS
62	5310	-8.36	1.41	-6.95	11	PASS
102	5510	-8.75	1.41	-7.34	11	PASS
110	5550	-8.93	1.41	-7.52	11	PASS
134	5670	-8.64	1.41	-7.23	11	PASS

NOTE: Refer to section 3.3 for duty cycle spectrum plot.

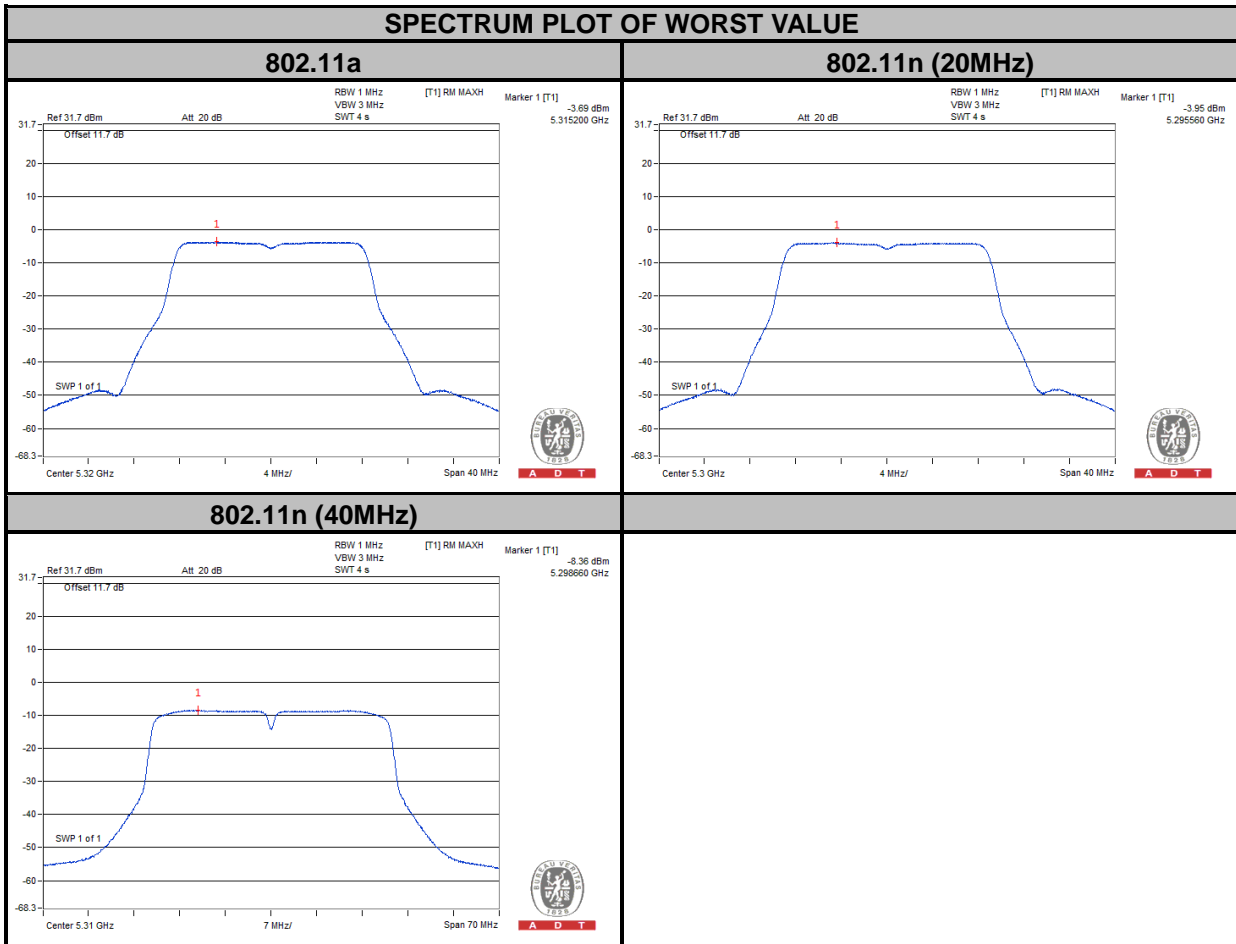



For U-NII-3 Band

802.11a

CHANNEL	FREQUENCY (MHz)	PSD W/O DUTY FACTOR (dBm)	DUTY FACTOR	PSD WITH DUTY FACTOR (dBm)	LIMIT (dBm/500kHz)	PASS/FAIL
149	5745	-7.58	0.62	-6.96	30	PASS
157	5785	-7.76	0.62	-7.14	30	PASS
165	5825	-7.61	0.62	-6.99	30	PASS

NOTE: Refer to section 3.3 for duty cycle spectrum plot.

802.11n (20MHz)

CHANNEL	FREQUENCY (MHz)	PSD W/O DUTY FACTOR (dBm)	DUTY FACTOR	PSD WITH DUTY FACTOR (dBm)	LIMIT (dBm/500kHz)	PASS/FAIL
149	5745	-7.79	0.66	-7.13	30	PASS
157	5785	-7.99	0.66	-7.33	30	PASS
165	5825	-7.95	0.66	-7.29	30	PASS

NOTE: Refer to section 3.3 for duty cycle spectrum plot.

802.11n (40MHz)

CHANNEL	FREQUENCY (MHz)	PSD W/O DUTY FACTOR (dBm)	DUTY FACTOR	PSD WITH DUTY FACTOR (dBm)	LIMIT (dBm/500kHz)	PASS/FAIL
151	5755	-12.38	1.41	-10.97	30	PASS
159	5795	-12.73	1.41	-11.32	30	PASS

NOTE: Refer to section 3.3 for duty cycle spectrum plot.



A D T

SPECTRUM PLOT OF WORST VALUE

802.11a

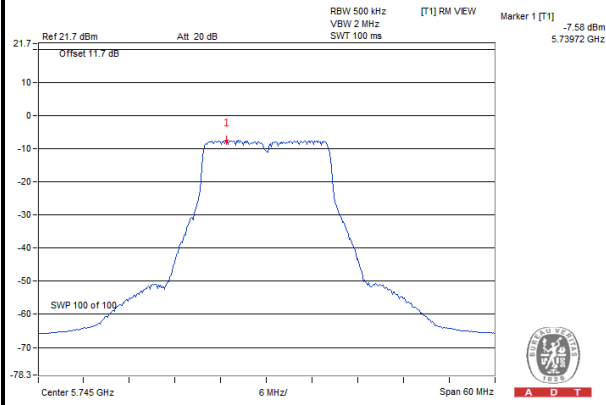

802.11n (20MHz)

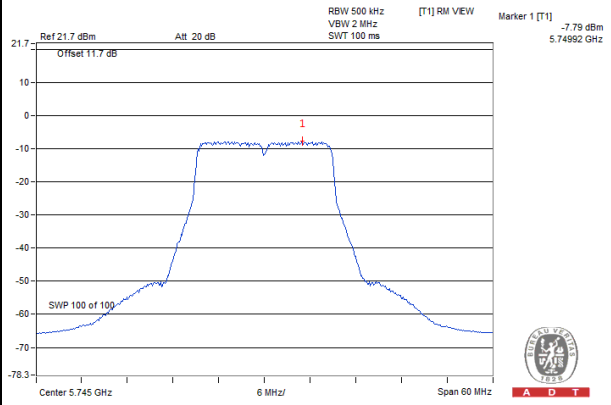

802.11n (40MHz)

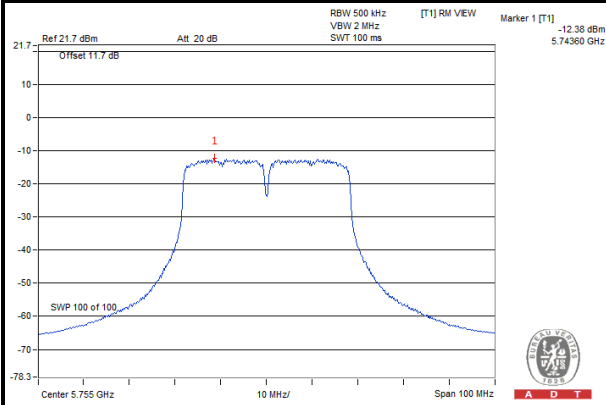

4.5 FREQUENCY STABILITY

4.5.1 LIMITS OF FREQUENCY STABILITY MEASUREMENT

The frequency of the carrier signal shall be maintained within band of operation.

4.5.2 TEST SETUP

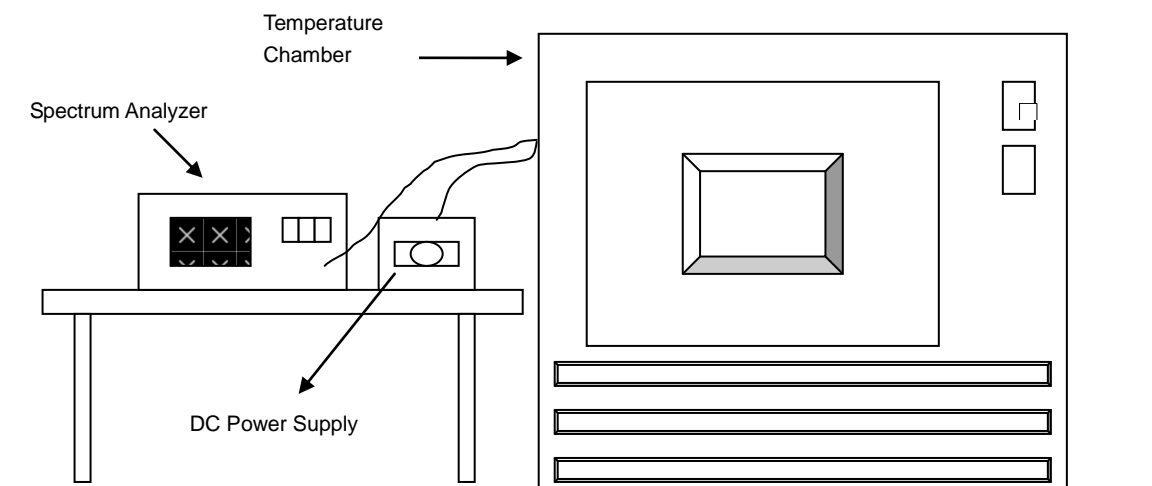

4.5.3 TEST INSTRUMENTS

Refer to section 4.1.3 to get information of above instrument.

4.5.4 TEST PROCEDURE

- a. To ensure emission at the band edge is maintained within the authorized band, those values shall be measured by radiation emissions at upper and lower frequency points, and finally compensated by frequency deviation as procedures below.
- b. The EUT was operated at the maximum output power, and connected to the spectrum analyzer, which is set to maximum hold function and peak detector. The peak value of the power envelope was measured and noted. The upper and lower frequency points were respectively measured relatively 10dB lower than the measured peak value.
- c. The frequency deviation was calculated by adding the upper frequency point and the lower frequency point divided by two. Those detailed values of frequency deviation are provided in table below.

4.5.5 DEVIATION FROM TEST STANDARD

No deviation.

4.5.6 EUT OPERATING CONDITION

Set the EUT transmit at un-modulation mode to test frequency stability.



4.5.7 TEST RESULTS

FREQUENCY STABILITY VERSUS TEMP.									
OPERATING FREQUENCY: 5320MHz									
TEMP. (°C)	POWER SUPPLY (Vdc)	0 MINUTE		2 MINUTE		5 MINUTE		10 MINUTE	
		Measured Frequency (MHz)	Frequency Drift (ppm)	Measured Frequency (MHz)	Frequency Drift (ppm)	Measured Frequency (MHz)	Frequency Drift (ppm)	Measured Frequency (MHz)	Frequency Drift (ppm)
60	3.8	5320.015576	2.928	5320.014921	2.805	5320.015698	2.951	5320.015475	2.909
50	3.8	5320.016145	3.035	5320.015991	3.006	5320.016088	3.024	5320.016064	3.020
40	3.8	5320.016077	3.022	5320.015694	2.950	5320.015739	2.958	5320.015571	2.927
30	3.8	5320.017440	3.278	5320.016956	3.187	5320.016949	3.186	5320.017051	3.205
20	3.8	5320.017897	3.364	5320.018204	3.422	5320.018211	3.423	5320.017963	3.377
10	3.8	5320.019337	3.635	5320.019921	3.745	5320.019206	3.610	5320.019709	3.705
0	3.8	5320.018300	3.440	5320.018424	3.463	5320.018200	3.421	5320.017944	3.373
-10	3.8	5320.016479	3.098	5320.016897	3.176	5320.016735	3.146	5320.016406	3.084
-20	3.8	5320.015847	2.979	5320.015812	2.972	5320.015982	3.004	5320.016419	3.086

FREQUENCY STABILITY VERSUS VOLTAGE									
OPERATING FREQUENCY: 5320MHz									
TEMP. (°C)	POWER SUPPLY (Vdc)	0 MINUTE		2 MINUTE		5 MINUTE		10 MINUTE	
		Measured Frequency (MHz)	Frequency Drift (ppm)	Measured Frequency (MHz)	Frequency Drift (ppm)	Measured Frequency (MHz)	Frequency Drift (ppm)	Measured Frequency (MHz)	Frequency Drift (ppm)
20	3.6	5320.017465	3.283	5320.017869	3.359	5320.017974	3.379	5320.017750	3.336
	3.8	5320.017897	3.364	5320.018204	3.422	5320.018211	3.423	5320.017963	3.377
	4.20	5320.019556	3.676	5320.019242	3.617	5320.019341	3.636	5320.019815	3.725

4.6 6dB BANDWIDTH MEASUREMENT

4.6.1 LIMITS OF 6dB BANDWIDTH MEASUREMENT

The minimum of 6dB Bandwidth Measurement is 0.5MHz.

4.6.2 TEST SETUP

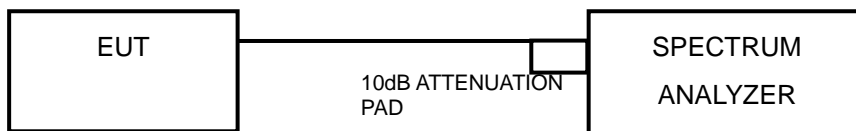

4.6.3 TEST INSTRUMENTS

Refer to section 4.1.3 to get information of above instrument.

4.6.4 TEST PROCEDURE

- Set resolution bandwidth (RBW) = 100kHz
- Set the video bandwidth (VBW) $\geq 3 \times$ RBW, Detector = Peak.
- Trace mode = max hold.
- Sweep = auto couple.
- Measure the maximum width of the emission that is constrained by the frequencies associated with the two amplitude points (upper and lower) that are attenuated by 6 dB relative to the maximum level measured in the fundamental emission.

4.6.5 DEVIATION FROM TEST STANDARD

No deviation.

4.6.6 EUT OPERATING CONDITIONS

The software provided by client to enable the EUT under transmission condition continuously at lowest, middle and highest channel frequencies individually.



A D T

4.6.7 TEST RESULTS

802.11a

CHANNEL	FREQUENCY (MHz)	6dB BANDWIDTH (MHz)	MINIMUM LIMIT (MHz)	PASS / FAIL
149	5745	16.40	0.5	PASS
157	5785	16.39	0.5	PASS
165	5825	16.41	0.5	PASS

802.11n (20MHz)

CHANNEL	FREQUENCY (MHz)	6dB BANDWIDTH (MHz)	MINIMUM LIMIT (MHz)	PASS / FAIL
149	5745	17.62	0.5	PASS
157	5785	17.62	0.5	PASS
165	5825	17.63	0.5	PASS

802.11n (40MHz)

CHANNEL	FREQUENCY (MHz)	6dB BANDWIDTH (MHz)	MINIMUM LIMIT (MHz)	PASS / FAIL
151	5755	35.28	0.5	PASS
159	5795	35.28	0.5	PASS



A D T

SPECTRUM PLOT OF WORST VALUE

802.11a

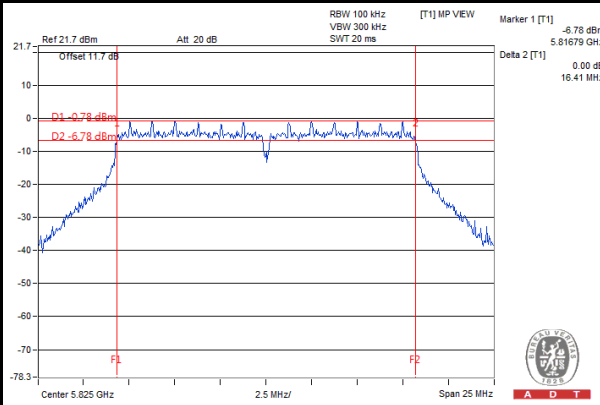

802.11n (20MHz)

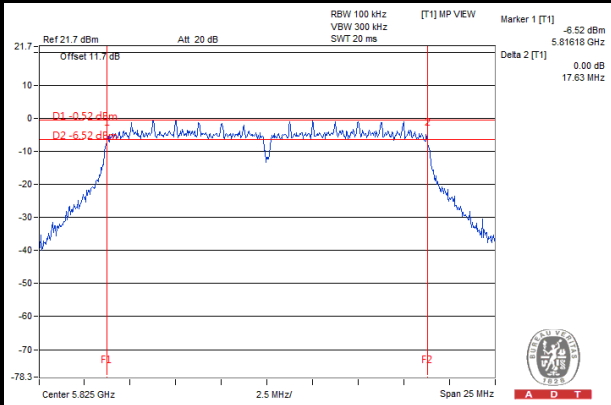

802.11n (40MHz)

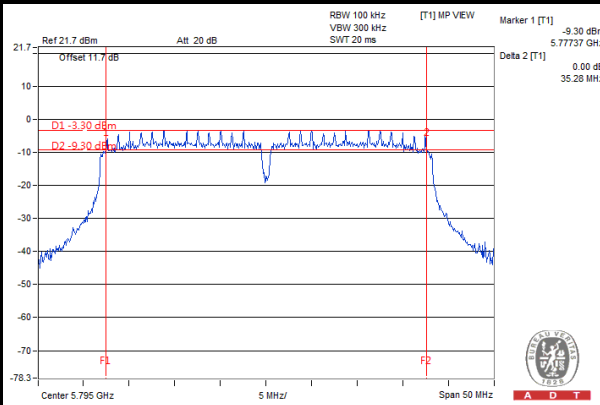



A D T

5. PHOTOGRAPHS OF THE TEST CONFIGURATION

Please refer to the attached file (Test Setup Photo).



6. INFORMATION ON THE TESTING LABORATORIES

We, Bureau Veritas Consumer Products Services (H.K.) Ltd., Taoyuan Branch, were founded in 1988 to provide our best service in EMC, Radio, Telecom and Safety consultation. Our laboratories are accredited and approved according to ISO/IEC 17025.

If you have any comments, please feel free to contact us at the following:

Linko EMC/RF Lab:

Tel: 886-2-26052180

Fax: 886-2-26051924

Hsin Chu EMC/RF/Telecom Lab:

Tel: 886-3-5935343

Fax: 886-3-5935342

Hwa Ya EMC/RF/Safety Lab:

Tel: 886-3-3183232

Fax: 886-3-3270892

Email: service.adt@tw.bureauveritas.com

Web Site: www.bureauveritas-adt.com

The address and road map of all our labs can be found in our web site also.



A D T

7. APPENDIX A - MODIFICATIONS RECORDERS FOR ENGINEERING CHANGES TO THE EUT BY THE LAB

No any modifications are made to the EUT by the lab during the test.

---END---