



FCC RF Test Report

APPLICANT : Bullitt Group
EQUIPMENT : Rugged Smart Phone
BRAND NAME : CAT
MODEL NAME : S50
FCC ID : ZL5S50
STANDARD : FCC Part 15 Subpart C §15.247
CLASSIFICATION : (DTS) Digital Transmission System

The product was received on Jun. 30, 2014 and testing was completed on Aug. 06, 2014. We, SPORTON INTERNATIONAL INC., would like to declare that the tested sample has been evaluated in accordance with the test procedures and has been in compliance with the applicable technical standards.

The test results in this report apply exclusively to the tested model / sample. Without written approval of SPORTON INTERNATIONAL INC., the test report shall not be reproduced except in full.

Reviewed by: Joseph Lin / Supervisor

Approved by: Jones Tsai / Manager



SPORTON INTERNATIONAL INC.

No. 52, Hwa Ya 1st Rd., Hwa Ya Technology Park, Kwei-Shan Hsiang, Tao Yuan Hsien, Taiwan, R.O.C.



TABLE OF CONTENTS

REVISION HISTORY.....3

SUMMARY OF TEST RESULT4

1 GENERAL DESCRIPTION.....5

1.1 Applicant.....5

1.2 Manufacturer.....5

1.3 Product Feature of Equipment Under Test.....5

1.4 Product Specification subjective to this standard6

1.5 Modification of EUT6

1.6 Testing Location7

1.7 Applicable Standards.....7

2 TEST CONFIGURATION OF EQUIPMENT UNDER TEST.....8

2.1 Carrier Frequency Channel8

2.2 Pre-Scanned RF Power.....9

2.3 Test Mode.....10

2.4 Connection Diagram of Test System.....12

2.5 Support Unit used in test configuration and system13

2.6 EUT Operation Test Setup13

2.7 Measurement Results Explanation Example.....14

3 TEST RESULT.....15

3.1 6dB and 99% Bandwidth Measurement15

3.2 Output Power Measurement.....18

3.3 Power Spectral Density Measurement21

3.4 Conducted Band Edges and Spurious Emission Measurement24

3.5 Radiated Band Edges and Spurious Emission Measurement42

3.6 AC Conducted Emission Measurement.....75

3.7 Antenna Requirements.....79

4 LIST OF MEASURING EQUIPMENT.....80

5 UNCERTAINTY OF EVALUATION.....81

APPENDIX A. SETUP PHOTOGRAPHS



REVISION HISTORY

REPORT NO.	VERSION	DESCRIPTION	ISSUED DATE
FR463004C	Rev. 01	Initial issue of report	Aug. 19, 2014

**SUMMARY OF TEST RESULT**

Report Section	FCC Rule	IC Rule	Description	Limit	Result	Remark
3.1	15.247(a)(2)	RSS-210 A8.2(a)	6dB Bandwidth	$\geq 0.5\text{MHz}$	Pass	-
3.1	-	RSS-Gen 4.6.1	99% Bandwidth	-	Pass	-
3.2	15.247(b)	RSS-210 A8.4	Power Output Measurement	$\leq 30\text{dBm}$	Pass	-
3.3	15.247(e)	RSS-210 A8.2(b)	Power Spectral Density	$\leq 8\text{dBm}/3\text{kHz}$	Pass	-
3.4	15.247(d)	RSS-210 A8.5	Conducted Band Edges	$\leq 20\text{dBc}$	Pass	-
			Conducted Spurious Emission		Pass	-
3.5	15.247(d)	RSS-210 A8.5	Radiated Band Edges and Radiated Spurious Emission	15.209(a) & 15.247(d)	Pass	Under limit 5.40 dB at 83.730 MHz
3.6	15.207	RSS-Gen 7.2.4	AC Conducted Emission	15.207(a)	Pass	Under limit 6.80 dB at 0.190 MHz
3.7	15.203 & 15.247(b)	RSS-210 A8.4	Antenna Requirement	N/A	Pass	-



1 General Description

1.1 Applicant

Bullitt Group

No. 4, The Aquarium, King Street, Reading, RG1 2AN United Kingdom

1.2 Manufacturer

Compal Electronics, INC.

No. 385, Yangguang St. Neihu District, Taipei City 11491, Taiwan, R.O.C

1.3 Product Feature of Equipment Under Test

Product Feature	
Equipment	Rugged Smart Phone
Brand Name	CAT
Model Name	S50
FCC ID	ZL5S50
EUT supports Radios application	GSM/EGPRS/WCDMA/HSPA/LTE/NFC WLAN 11b/g/n HT20 WLAN 11a/n HT20/HT40 Bluetooth v4.0 EDR/LE
HW Version	DVT1
SW Version	LTE_S0201121.0_S50_0.006.00
EUT Stage	Identical Prototype

Remark: The above EUT's information was declared by manufacturer. Please refer to the specifications or user's manual for more detailed description.



1.4 Product Specification subjective to this standard

Product Specification subjective to this standard	
Tx/Rx Channel Frequency Range	802.11b/g/n : 2412 MHz ~ 2462 MHz 802.11a/n: 5745~5825MHz.
Maximum (Peak) Output Power to Antenna	<2412 MHz ~ 2462 MHz> 802.11b : 17.64 dBm (0.0581 W) 802.11g : 20.07 dBm (0.1016 W) 802.11n HT20 : 19.25 dBm (0.0841 W) <5745 MHz ~ 5825 MHz> 802.11a : 17.28 dBm (0.0535 W) 802.11n HT20 : 17.31 dBm (0.0538 W) 802.11n HT40 : 16.92 dBm (0.0492 W)
99% Occupied Bandwidth	<2412 MHz ~ 2462 MHz> 802.11b : 13.90MHz 802.11g : 18.30MHz 802.11n HT20 : 19.00MHz <5745 MHz ~ 5825 MHz> 802.11a : 18.50MHz 802.11n HT20 : 19.30MHz 802.11n HT40 : 36.90MHz
Antenna Type	802.11b/g/n: PIFA Antenna type with gain 1.73 dBi 802.11a/n : PIFA Antenna type with gain -0.74 dBi
Type of Modulation	802.11b : DSSS (DBPSK / DQPSK / CCK) 802.11a/g/n : OFDM (BPSK / QPSK / 16QAM / 64QAM)

1.5 Modification of EUT

No modifications are made to the EUT during all test items.



1.6 Testing Location

Sporton Lab is accredited to ISO 17025 by Taiwan Accreditation Foundation (TAF code : 1190) and the FCC designation No. TW1022 under the FCC 2.948(e) by Mutual Recognition Agreement (MRA) in FCC Test.

Test Site	SPORTON INTERNATIONAL INC.		
Test Site Location	No. 52, Hwa Ya 1 st Rd., Hwa Ya Technology Park, Kwei-Shan Hsiang, Tao Yuan Hsien, Taiwan, R.O.C. TEL: +886-3-327-3456 FAX: +886-3-328-4978		
Test Site No.	Sporton Site No.		
	TH02-HY	CO05-HY	03CH07-HY

1.7 Applicable Standards

According to the specifications of the manufacturer, the EUT must comply with the requirements of the following standards:

- ♦ FCC Part 15 Subpart C §15.247
- ♦ FCC KDB Publication No. 558074 D01 DTS Meas. Guidance v03r02
- ♦ ANSI C63.4-2003

Remark:

1. All test items were verified and recorded according to the standards and without any deviation during the test.
2. This EUT has also been tested and complied with the requirements of FCC Part 15, Subpart B, recorded in a separate test report.



2 Test Configuration of Equipment Under Test

The EUT has been associated with peripherals and configuration operated in a manner tended to maximize its emission characteristics in a typical application. Frequency range investigated: conducted emission (150 kHz to 30 MHz) and radiated emission (9 kHz to the 10th harmonic of the highest fundamental frequency or to 40 GHz, whichever is lower). For radiated measurement, pre-scanned in three orthogonal panels, X, Y, Z. The worst cases (Z plane) were recorded in this report.

The final configuration from all the combinations and the worst-case data rates were investigated by measuring the maximum power across all the data rates and modulation modes under section 2.2.

Based on the worst configuration found above, the RF power setting is set individually to meet FCC compliance limit for the final conducted and radiated tests shown in section 2.3.

2.1 Carrier Frequency Channel

Frequency Band	Channel	Freq. (MHz)	Channel	Freq. (MHz)
2400-2483.5 MHz	1	2412	7	2442
	2	2417	8	2447
	3	2422	9	2452
	4	2427	10	2457
	5	2432	11	2462
	6	2437	-	-

Frequency Band	Channel	Freq. (MHz)	Channel	Freq. (MHz)
5725-5850 MHz Band 4	149	5745	157	5785
	151	5755	159	5795
	153	5765	161	5805
	155	5775	165	5825



2.2 Pre-Scanned RF Power

Preliminary tests were performed in different data rate and data rate associated with the highest power were chosen for full test shown in the following tables.

2.4GHz 802.11b mode				
Data Rate (MHz)	1M bps	2M bps	5.5M bps	11M bps
Peak Power (dBm)	17.64	17.59	17.55	17.60

2.4GHz 802.11g mode								
Data Rate (MHz)	6M bps	9M bps	12M bps	18M bps	24M bps	36M bps	48M bps	54M bps
Peak Power (dBm)	20.07	20.03	19.94	19.92	19.85	19.78	19.82	19.97

2.4GHz 802.11n HT20 mode								
Data Rate (MHz)	MCS0	MCS1	MCS2	MCS3	MCS4	MCS5	MCS6	MCS7
Peak Power (dBm)	19.25	19.13	19.17	19.09	19.22	19.11	19.05	19.14

5GHz 802.11a mode								
Data Rate (MHz)	6M bps	9M bps	12M bps	18M bps	24M bps	36M bps	48M bps	54M bps
Peak Power (dBm)	17.28	17.14	17.21	17.23	17.19	17.16	17.20	17.08

5GHz 802.11n HT20 mode								
Data Rate (MHz)	MCS0	MCS1	MCS2	MCS3	MCS4	MCS5	MCS6	MCS7
Peak Power (dBm)	17.31	17.24	17.19	17.28	17.30	17.16	17.25	17.15

5GHz 802.11n HT40 mode								
Data Rate (MHz)	MCS0	MCS1	MCS2	MCS3	MCS4	MCS5	MCS6	MCS7
Peak Power (dBm)	16.92	16.87	16.76	16.85	16.83	16.79	16.88	16.66



2.3 Test Mode

Final results of test modes, data rates and test channels are shown as following table.

<2.4GHz>

Test Cases				
	Test Items	Mode	Data Rate	Test Channel
Conducted TCs	6dB and 99% BW Power Spectral Density Output Power	802.11b	1 Mbps	1/6/11
		802.11g	6 Mbps	1/6/11
		802.11n HT20	MCS0	1/6/11
	Conducted Band Edge	802.11b	1 Mbps	1/11
		802.11g	6 Mbps	1/11
		802.11n HT20	MCS0	1/6/11
	Conducted Spurious Emission	802.11b	1 Mbps	1/6/11
		802.11g	6 Mbps	1/6/11
		802.11n HT20	MCS0	1/6/11
Radiated TCs	Radiated Band Edge	802.11b	1 Mbps	1/11
		802.11g	6 Mbps	1/11
		802.11n HT20	MCS0	1/6/11
		802.11n HT20 WPC Mode	MCS0	11
	Radiated Spurious Emission	802.11b	1 Mbps	1/6/11
		802.11g	6 Mbps	1/6/11
		802.11n HT20	MCS0	1/6/11
		802.11n HT20 WPC Mode	MCS0	11



<5GHz>

Test Cases				
	Test Items	Mode	Data Rate	Test Channel
Conducted TCs	6dB and 99% BW Power Spectral Density Output Power	802.11a	6 Mbps	149/157/165
		802.11n HT20	MCS0	149/157/165
		802.11n HT40	MCS0	151/159
	Conducted Band Edge	802.11a	6 Mbps	149/165
		802.11n HT20	MCS0	149/157/165
		802.11n HT40	MCS0	151/159
	Conducted Spurious Emission	802.11a	6 Mbps	149/157/165
		802.11n HT20	MCS0	149/157/165
		802.11n HT40	MCS0	151/159
Radiated TCs	Radiated Spurious Emission	802.11a	6 Mbps	149/157/165
		802.11n HT20	MCS0	149/157/165
		802.11n HT40	MCS0	151/159

Test Cases	
AC Conducted Emission	Mode 1 : GSM1900 Idle + WLAN Link + Bluetooth Link + Earphone + USB Cable (Data Link with Notebook) + GPS Rx + Battery

2.4 Connection Diagram of Test System

<WLAN Tx Mode>

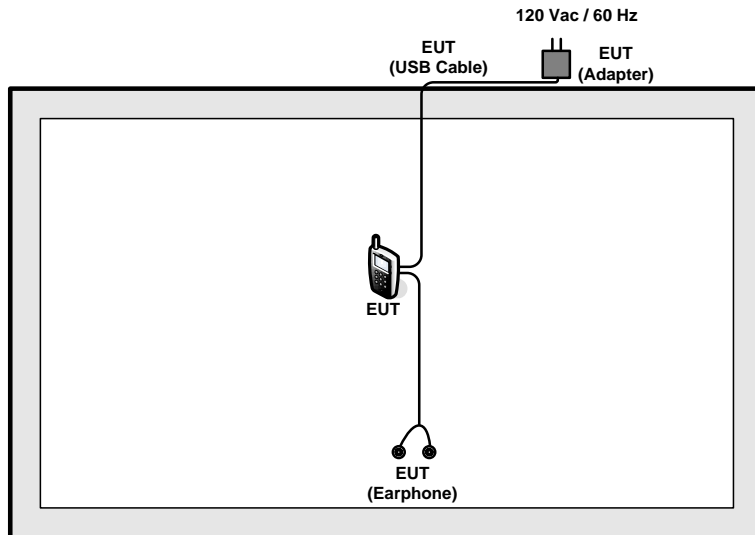

< WLAN Tx Mode with WPC Charging >

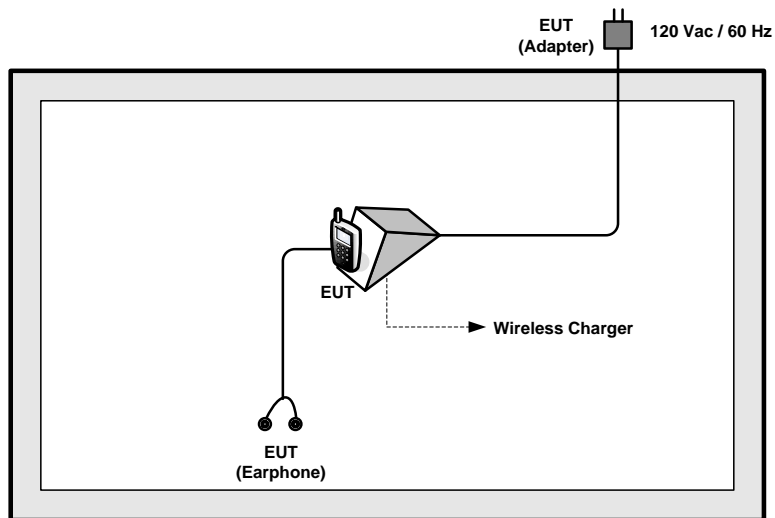

<AC Conducted Emission Mode>

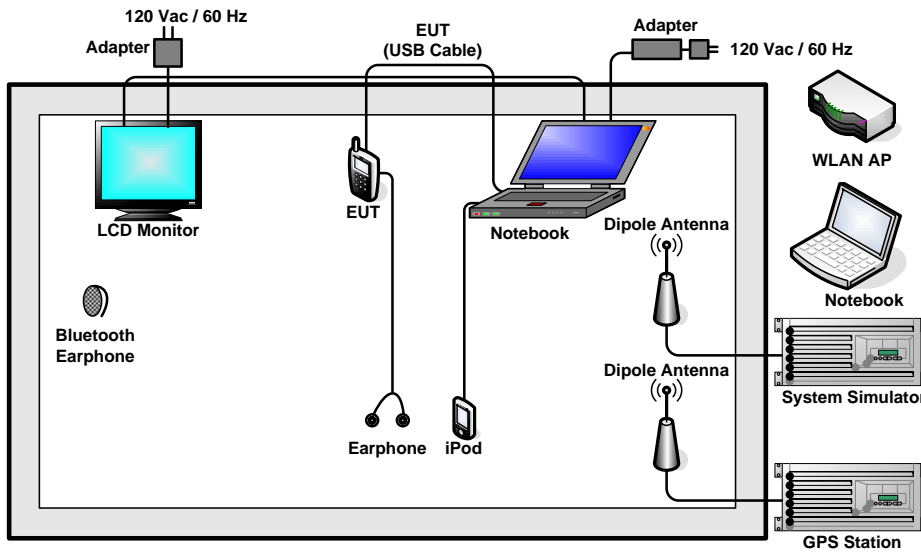

2.5 Support Unit used in test configuration and system

Item	Equipment	Trade Name	Model Name	FCC ID	Data Cable	Power Cord
1.	System Simulator	R&S	CMU 200	N/A	N/A	Unshielded, 1.8 m
2.	GPS Station	Pendulum	GSG-54	N/A	N/A	Unshielded, 1.8 m
3.	Bluetooth Earphone	Sony Ericsson	MW600	PY7DDA-2029	N/A	N/A
4.	WLAN AP	D-Link	DIR-628	KA2DIR628A2	N/A	Unshielded, 1.8 m
5.	Notebook	DELL	Latitude E6320	FCC DoC/ Contains FCC ID: QDS-BRCM1054	N/A	AC I/P: Unshielded, 1.2 m DC O/P: Shielded, 1.8 m
6.	iPod	Apple	A1285	FCC DoC	Shielded, 1.0 m	N/A
7.	LCD Monitor	DELL	U2410	FCC DoC	Shielded, 1.6 m	Unshielded, 1.8 m
8.	SD Card	SanDisk	MicroSD HC	FCC DoC	N/A	N/A

2.6 EUT Operation Test Setup

For WLAN function, programmed RF utility, "QRCT" installed in the notebook make the EUT provide functions like channel selection and power level for continuous transmitting and receiving signals.



2.7 Measurement Results Explanation Example

For all conducted test items:

The offset level is set in the spectrum analyzer to compensate the RF cable loss and attenuator factor between EUT conducted output port and spectrum analyzer. With the offset compensation, the spectrum analyzer reading level is exactly the EUT RF output level.

Example :

The spectrum analyzer offset is derived from RF cable loss and attenuator factor.

Offset = RF cable loss + attenuator factor.

Following shows an offset computation example with cable loss 4.2 dB and 10dB attenuator.

$$\begin{aligned} \text{Offset(dB)} &= \text{RF cable loss(dB)} + \text{attenuator factor(dB)}. \\ &= 4.2 + 10 = 14.2 \text{ (dB)} \end{aligned}$$

3 Test Result

3.1 6dB and 99% Bandwidth Measurement

3.1.1 Limit of 6dB and 99% Bandwidth

The minimum 6 dB bandwidth shall be at least 500 kHz.

3.1.2 Measuring Instruments

The measuring equipment is listed in the section 4 of this test report.

3.1.3 Test Procedures

1. The testing follows FCC KDB Publication No. 558074 DTS D01 Meas. Guidance v03r02.
2. The RF output of EUT was connected to the spectrum analyzer by RF cable and attenuator. The path loss was compensated to the results for each measurement.
3. Set to the maximum power setting and enable the EUT transmit continuously.
4. Make the measurement with the spectrum analyzer's resolution bandwidth (RBW) = 100 kHz. Set the Video bandwidth (VBW) = 300 kHz. In order to make an accurate measurement. The 6 dB bandwidth must be greater than 500 kHz.
5. For 99% Bandwidth Measurement, the spectrum analyzer's resolution bandwidth (RBW) = 1MHz and set the Video bandwidth (VBW) = 3MHz.
6. Measure and record the results in the test report.

3.1.4 Test Setup





3.1.5 Test Result of 6dB and 99% Occupied Bandwidth

Test Band :	2.4GHz + 5GHz band 4	Temperature :	21~26°C
Test Engineer :	Alen Tsui	Relative Humidity :	45~54%

Mod.	Data Rate	N _{TX}	Channel	Freq. (MHz)	99% Bandwidth (MHz)	6dB Bandwidth (MHz)	6dB Bandwidth Min. Limit (MHz)	Pass/Fail
11b	1Mbps	1	1	2412	13.90	8.56	0.5	Pass
11b	1Mbps	1	6	2437	13.60	8.54	0.5	Pass
11b	1Mbps	1	11	2462	13.70	8.52	0.5	Pass
11g	6Mbps	1	1	2412	18.25	16.32	0.5	Pass
11g	6Mbps	1	6	2437	18.15	16.32	0.5	Pass
11g	6Mbps	1	11	2462	18.30	16.32	0.5	Pass
HT20	MCS0	1	1	2412	18.95	17.56	0.5	Pass
HT20	MCS0	1	6	2437	18.90	17.56	0.5	Pass
HT20	MCS0	1	11	2462	19.00	17.34	0.5	Pass

Mod.	Data Rate	N _{TX}	Channel	Freq. (MHz)	99% Bandwidth (MHz)	6dB Bandwidth (MHz)	6dB Bandwidth Min. Limit (MHz)	Pass/Fail
11a	6Mbps	1	149	5745	18.45	16.32	0.5	Pass
11a	6Mbps	1	157	5785	18.40	16.36	0.5	Pass
11a	6Mbps	1	165	5825	18.50	16.32	0.5	Pass
HT20	MCS0	1	149	5745	19.30	17.56	0.5	Pass
HT20	MCS0	1	157	5785	19.10	17.56	0.5	Pass
HT20	MCS0	1	165	5825	19.15	17.56	0.5	Pass
HT40	MCS0	1	151	5755	36.90	35.20	0.5	Pass
HT40	MCS0	1	159	5795	36.70	35.52	0.5	Pass

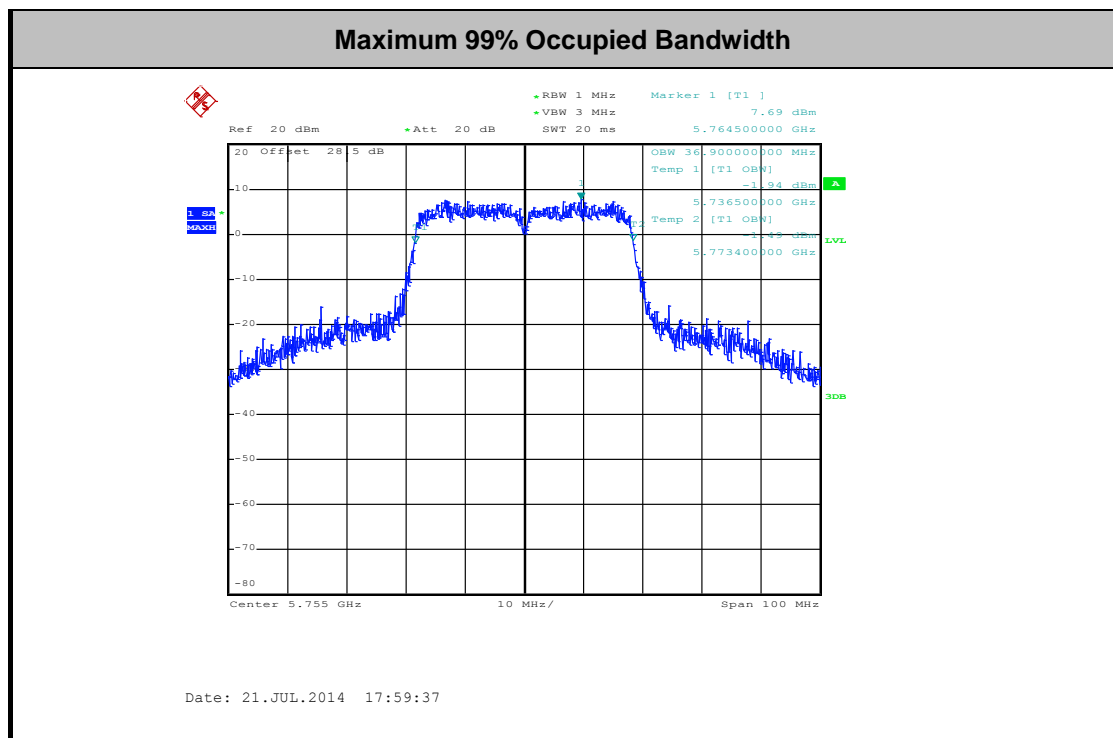
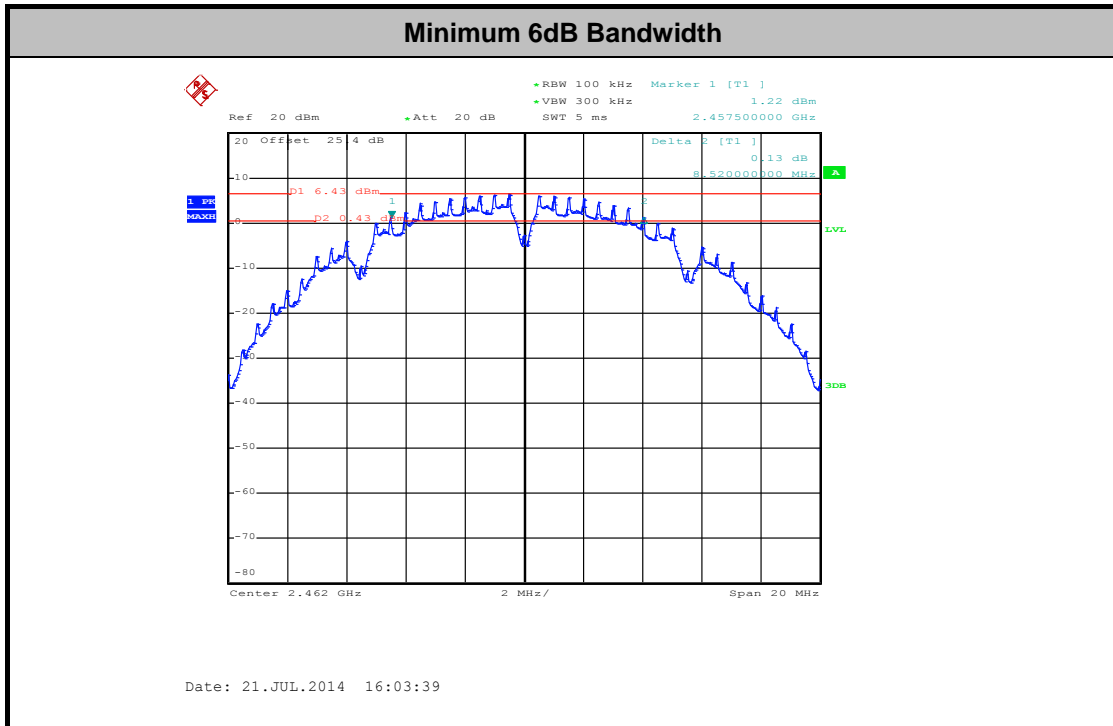

Note : The occupied channel bandwidth is maintained within the band of operation for all of the modulations.

3.2 Output Power Measurement

3.2.1 Limit of Output Power

For systems using digital modulation in the 2400-2483.5MHz and 5725-5850MHz, the limit for peak output power is 30dBm. If transmitting Antenna of directional gain greater than 6dBi are used the peak output power from the intentional radiator shall be reduced below the above stated value by the amount in dB that the directional gain of the Antenna exceeds 6 dBi. In case of point-to-point operation, the limit has to be reduced by 1dB for every 3dB that the directional gain of the Antenna exceeds 6dBi.

3.2.2 Measuring Instruments

The measuring equipment is listed in the section 4 of this test report.

3.2.3 Test Procedures

1. The testing follows the Measurement Procedure of FCC KDB No. 558074 DTS D01 Meas. Guidance v03r02.
2. The RF output of EUT was connected to the power meter by RF cable and attenuator. The path loss was compensated to the results for each measurement.
3. Set to the maximum power setting and enable the EUT transmit continuously.
4. Measure the conducted output power and record the results in the test report.

3.2.4 Test Setup

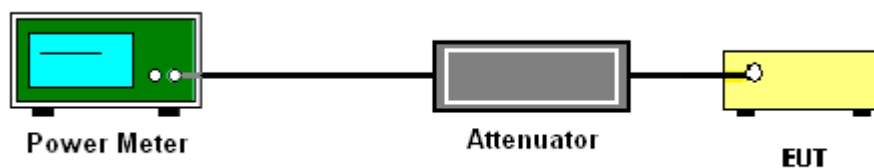



3.2.5 Test Result of Peak Output Power

Test Mode :	2.4GHz + 5GHz band 4	Temperature :	21~26°C
Test Engineer :	Alen Tsui	Relative Humidity :	45~54%

Mod.	Data Rate	N _{TX}	Channel	Freq. (MHz)	RF Output Power (dBm)	Power Limit (dBm)	DG (dBi)	Pass/Fail
11b	1Mbps	1	1	2412	17.64	30	1.73	Pass
11b	1Mbps	1	6	2437	17.54	30	1.73	Pass
11b	1Mbps	1	11	2462	17.35	30	1.73	Pass
11g	6Mbps	1	1	2412	19.77	30	1.73	Pass
11g	6Mbps	1	6	2437	20.07	30	1.73	Pass
11g	6Mbps	1	11	2462	19.86	30	1.73	Pass
HT20	MCS0	1	1	2412	19.17	30	1.73	Pass
HT20	MCS0	1	6	2437	19.25	30	1.73	Pass
HT20	MCS0	1	11	2462	19.16	30	1.73	Pass

Mod.	Data Rate	N _{TX}	Channel	Freq. (MHz)	RF Output Power (dBm)	Power Limit (dBm)	DG (dBi)	Pass/Fail
11a	6Mbps	1	149	5745	17.28	30	-0.74	Pass
11a	6Mbps	1	157	5785	17.22	30	-0.74	Pass
11a	6Mbps	1	165	5825	17.21	30	-0.74	Pass
HT20	MCS0	1	149	5745	17.31	30	-0.74	Pass
HT20	MCS0	1	157	5785	17.27	30	-0.74	Pass
HT20	MCS0	1	165	5825	17.23	30	-0.74	Pass
HT40	MCS0	1	151	5755	16.81	30	-0.74	Pass
HT40	MCS0	1	159	5795	16.92	30	-0.74	Pass



3.2.6 Test Result of Average output Power (Reporting Only)

Test Mode :	2.4GHz + 5GHz band 4	Temperature :	21~26°C
Test Engineer :	Alen Tsui	Relative Humidity :	45~54%

Mod.	Data Rate	N _{TX}	Channel	Freq. (MHz)	Duty Factor (dB)	Average Output Power (dBm)	Power Limit (dBm)	DG (dBi)	Pass/Fail
11b	1Mbps	1	1	2412	0.10	15.25	30	1.73	Pass
11b	1Mbps	1	6	2437	0.10	15.04	30	1.73	Pass
11b	1Mbps	1	11	2462	0.10	14.86	30	1.73	Pass
11g	6Mbps	1	1	2412	0.59	10.82	30	1.73	Pass
11g	6Mbps	1	6	2437	0.59	10.92	30	1.73	Pass
11g	6Mbps	1	11	2462	0.59	10.87	30	1.73	Pass
HT20	MCS0	1	1	2412	0.63	10.00	30	1.73	Pass
HT20	MCS0	1	6	2437	0.63	10.07	30	1.73	Pass
HT20	MCS0	1	11	2462	0.63	9.94	30	1.73	Pass

Mod.	Data Rate	N _{TX}	Channel	Freq. (MHz)	Duty Factor (dB)	Average Output Power (dBm)	Power Limit (dBm)	DG (dBi)	Pass/Fail
11a	6Mbps	1	149	5745	0.59	10.18	30	-0.74	Pass
11a	6Mbps	1	157	5785	0.59	10.05	30	-0.74	Pass
11a	6Mbps	1	165	5825	0.59	9.93	30	-0.74	Pass
HT20	MCS0	1	149	5745	0.63	10.15	30	-0.74	Pass
HT20	MCS0	1	157	5785	0.63	9.97	30	-0.74	Pass
HT20	MCS0	1	165	5825	0.63	9.88	30	-0.74	Pass
HT40	MCS0	1	151	5755	1.17	10.18	30	-0.74	Pass
HT40	MCS0	1	159	5795	1.17	10.23	30	-0.74	Pass

Note: Measured power (dBm) has offset with cable loss and duty factor.

3.3 Power Spectral Density Measurement

3.3.1 Limit of Power Spectral Density

The peak power spectral density shall not be greater than 8dBm in any 3kHz band at any time interval of continuous transmission.

3.3.2 Measuring Instruments

The measuring equipment is listed in the section 4 of this test report.

3.3.3 Test Procedures

1. The testing follows Measurement Procedure 10.2 Method PKPSD of FCC KDB Publication No. 558074 D01 DTS Meas. Guidance v03r02
2. The RF output of EUT was connected to the spectrum analyzer by RF cable and attenuator. The path loss was compensated to the results for each measurement.
3. Set to the maximum power setting and enable the EUT transmit continuously.
4. Make the measurement with the spectrum analyzer's resolution bandwidth (RBW) = 3 kHz. Video bandwidth VBW = 10 kHz In order to make an accurate measurement, set the span to 1.5 times DTS Channel Bandwidth. (6dB BW)
5. Detector = peak, Sweep time = auto couple, Trace mode = max hold, Allow trace to fully stabilize. Use the peak marker function to determine the maximum power level.
6. Measure and record the results in the test report.

3.3.4 Test Setup





3.3.5 Test Result of Power Spectral Density

Test Mode :	2.4GHz + 5GHz band 4	Temperature :	21~26°C
Test Engineer :	Alen Tsui	Relative Humidity :	45~54%

Mod.	Data Rate	N _{TX}	Channel	Freq. (MHz)	Peak Power Density (dBm/3kHz)	Max. Limits (dBm/3kHz)	DG (dBi)	Pass/Fail
11b	1Mbps	1	1	2412	-6.36	8	1.73	Pass
11b	1Mbps	1	6	2437	-8.32	8	1.73	Pass
11b	1Mbps	1	11	2462	-8.14	8	1.73	Pass
11g	6Mbps	1	1	2412	-13.03	8	1.73	Pass
11g	6Mbps	1	6	2437	-14.30	8	1.73	Pass
11g	6Mbps	1	11	2462	-14.32	8	1.73	Pass
HT20	MCS0	1	1	2412	-14.98	8	1.73	Pass
HT20	MCS0	1	6	2437	-15.76	8	1.73	Pass
HT20	MCS0	1	11	2462	-14.46	8	1.73	Pass

Mod.	Data Rate	N _{TX}	Channel	Freq. (MHz)	Peak Power Density (dBm/3kHz)	Max. Limits (dBm/3kHz)	DG (dBi)	Pass/Fail
11a	6Mbps	1	149	5745	-11.52	8	-0.74	Pass
11a	6Mbps	1	157	5785	-10.75	8	-0.74	Pass
11a	6Mbps	1	165	5825	-11.69	8	-0.74	Pass
HT20	MCS0	1	149	5745	-11.45	8	-0.74	Pass
HT20	MCS0	1	157	5785	-10.94	8	-0.74	Pass
HT20	MCS0	1	165	5825	-11.94	8	-0.74	Pass
HT40	MCS0	1	151	5755	-14.36	8	-0.74	Pass
HT40	MCS0	1	159	5795	-14.49	8	-0.74	Pass

Note: Measured power density (dBm) has offset with cable loss.

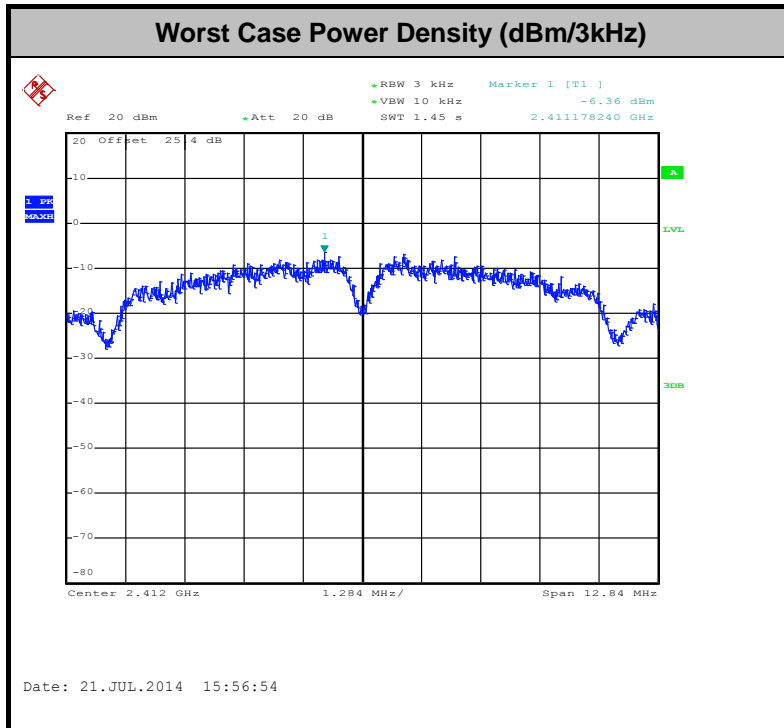

3.4 Conducted Band Edges and Spurious Emission Measurement

3.4.1 Limit of Conducted Band Edges and Spurious Emission Measurement

In any 100 kHz bandwidth outside of the authorized frequency band, the emissions which fall in the non-restricted bands shall be attenuated at least 20 dB / 30dB relative to the maximum PSD level in 100 kHz by RF conducted measurement and radiated emissions which fall in the restricted bands, as defined in Section 15.205(a), must also comply with the radiated emission limits specified in Section 15.209(a).

3.4.2 Measuring Instruments

The measuring equipment is listed in the section 4 of this test report.

3.4.3 Test Procedures

1. The testing follows FCC KDB Publication No. 558074 D01 DTS Meas. Guidance v03r02.
2. The RF output of EUT was connected to the spectrum analyzer by RF cable and attenuator. The path loss was compensated to the results for each measurement.
3. Set to the maximum power setting and enable the EUT transmit continuously.
4. Set RBW = 100 kHz, VBW=300 kHz, Peak Detector. Unwanted Emissions measured in any 100 kHz bandwidth outside of the authorized frequency band shall be attenuated by at least 20 dB relative to the maximum in-band peak PSD level in 100 kHz when maximum peak conducted output power procedure is used. If the transmitter complies with the conducted power limits based on the use of RMS averaging over a time interval, the attenuation required under this paragraph shall be 30 dB instead of 20 dB per 15.247(d).
5. Measure and record the results in the test report.
6. The RF fundamental frequency should be excluded against the limit line in the operating frequency band.

3.4.4 Test Setup

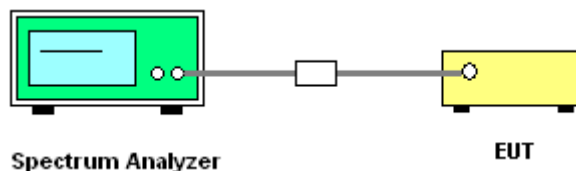



3.4.5 Test Result of Conducted Band Edges and Spurious Emission

Test Mode :	802.11b	Temperature :	21~26°C
Test Band :	2.4GHz Low	Relative Humidity :	45~54%
Test Channel :	01	Test Engineer :	Alen Tsui

WLAN 802.11b Channel 01

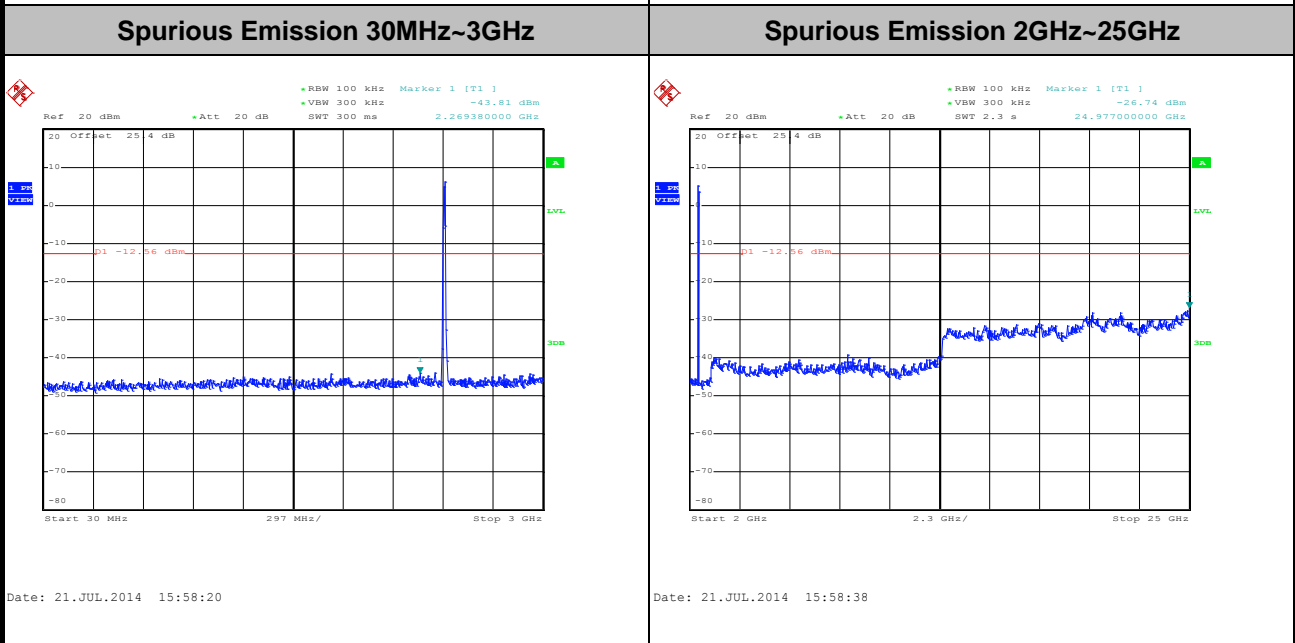
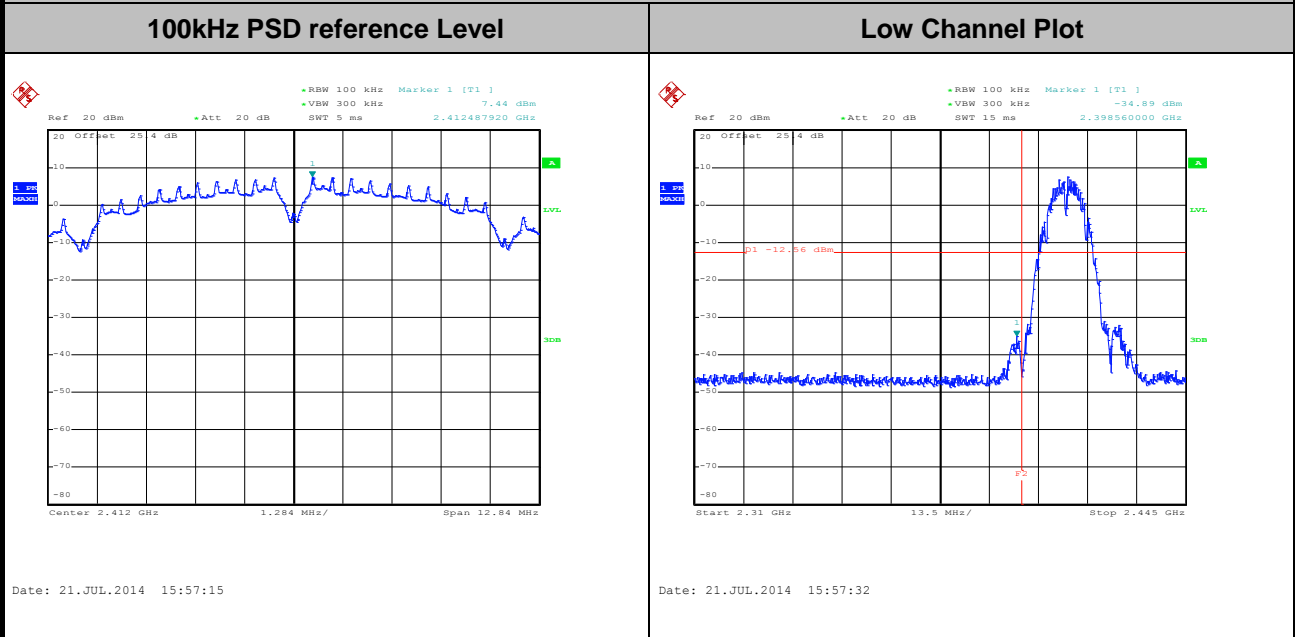



Test Mode :	802.11b	Temperature :	21~26°C
Test Band :	2.4GHz Mid	Relative Humidity :	45~54%
Test Channel :	06	Test Engineer :	Alen Tsui

WLAN 802.11b Channel 06

100kHz PSD reference Level

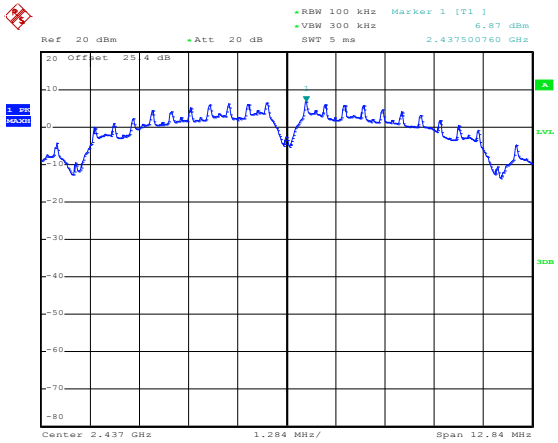

Date: 21.JUL.2014 16:00:24

Spurious Emission 30MHz~3GHz

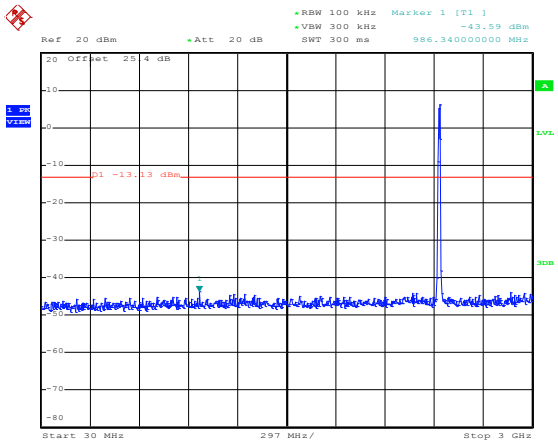

Date: 21.JUL.2014 16:00:46

Spurious Emission 2GHz~25GHz

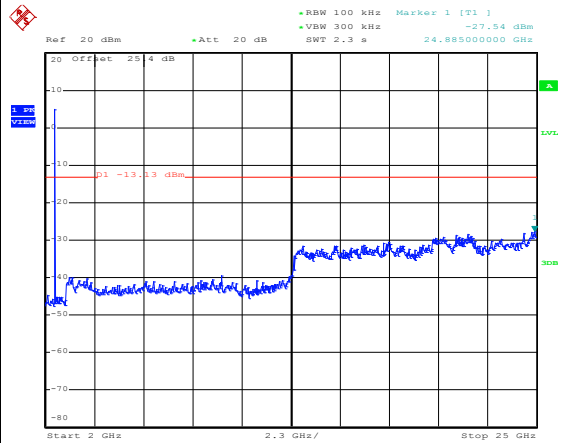

Date: 21.JUL.2014 16:01:04



Test Mode :	802.11b	Temperature :	21~26°C
Test Band :	2.4GHz High	Relative Humidity :	45~54%
Test Channel :	11	Test Engineer :	Alen Tsui

WLAN 802.11b Channel 11

100kHz PSD reference Level

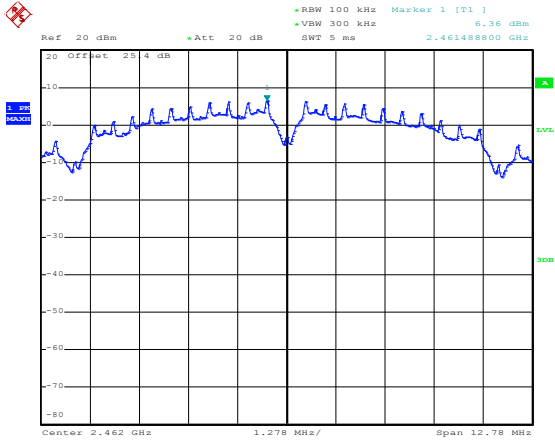

Date: 21.JUL.2014 16:04:25

High Channel Plot

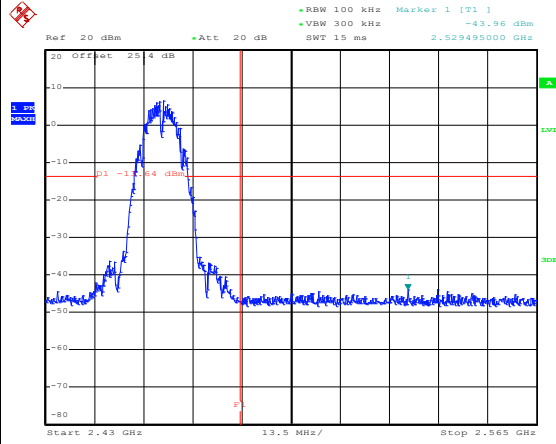

Date: 21.JUL.2014 16:04:42

Spurious Emission 30MHz~3GHz

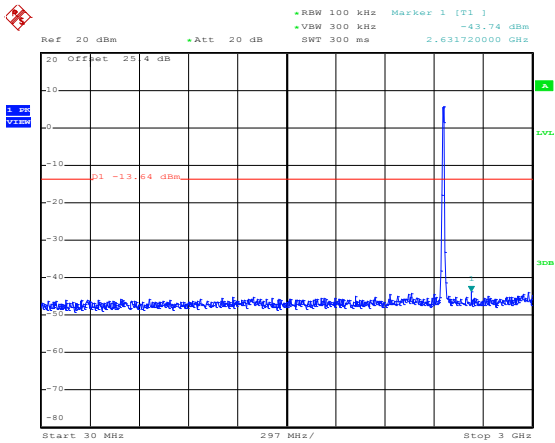

Date: 21.JUL.2014 16:05:03

Spurious Emission 2GHz~25GHz

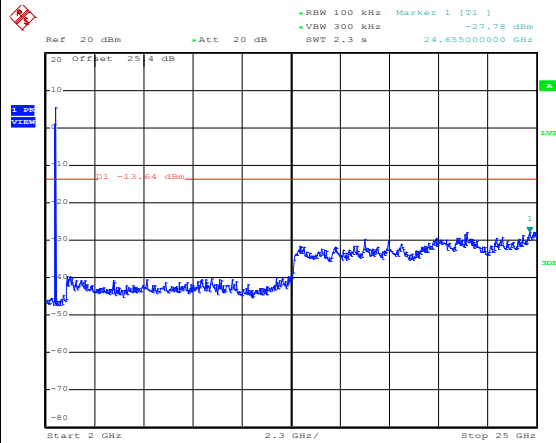

Date: 21.JUL.2014 16:05:21



Test Mode :	802.11g	Temperature :	21~26°C
Test Band :	2.4GHz Low	Relative Humidity :	45~54%
Test Channel :	01	Test Engineer :	Alen Tsui

WLAN 802.11g Channel 01

100kHz PSD reference Level

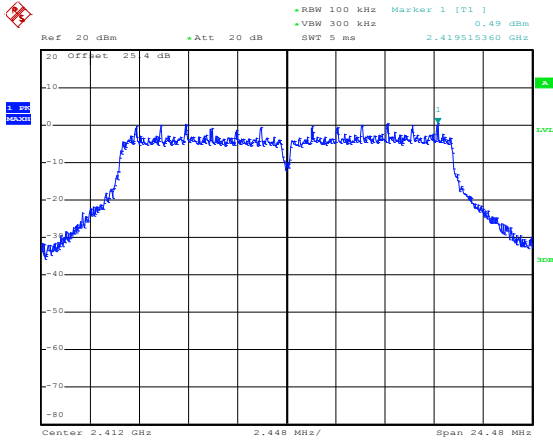

Date: 21.JUL.2014 16:12:55

Low Channel Plot

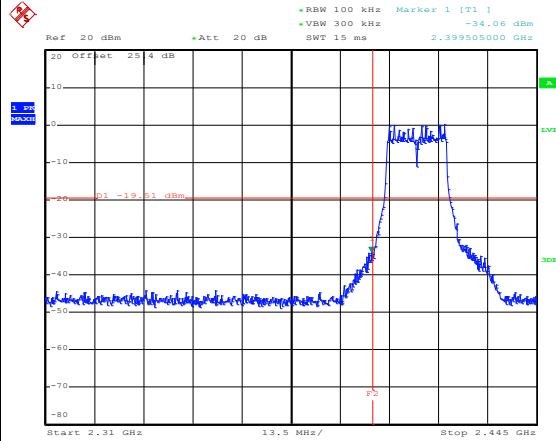

Date: 21.JUL.2014 16:13:28

Spurious Emission 30MHz~3GHz

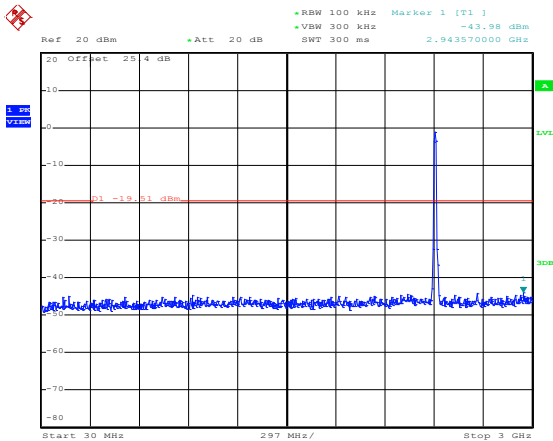

Date: 21.JUL.2014 16:15:47

Spurious Emission 2GHz~25GHz

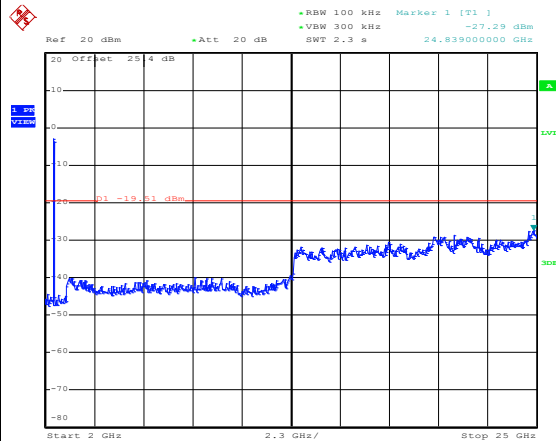

Date: 21.JUL.2014 16:16:05



Test Mode :	802.11g	Temperature :	21~26°C
Test Band :	2.4GHz Mid	Relative Humidity :	45~54%
Test Channel :	06	Test Engineer :	Alen Tsui

WLAN 802.11g Channel 06

100kHz PSD reference Level

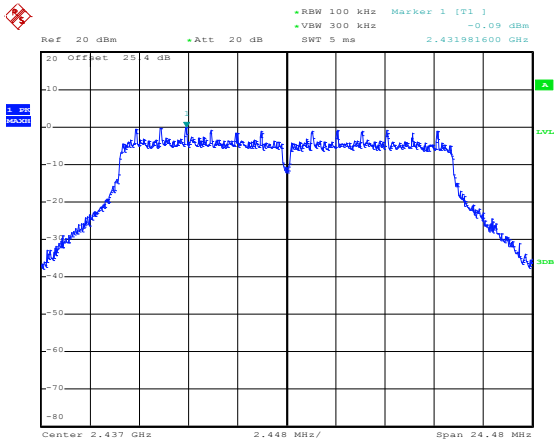

Date: 21.JUL.2014 18:17:34

Spurious Emission 30MHz~3GHz

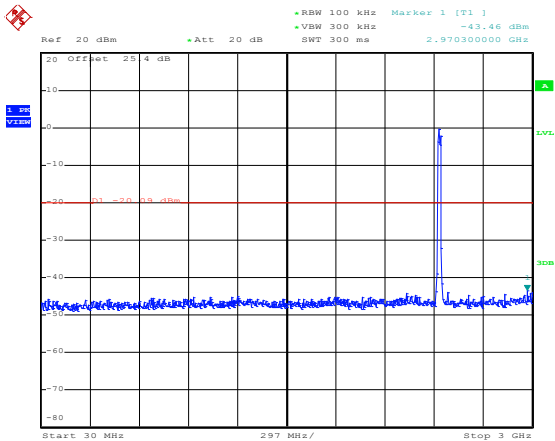

Date: 21.JUL.2014 18:20:02

Spurious Emission 2GHz~25GHz

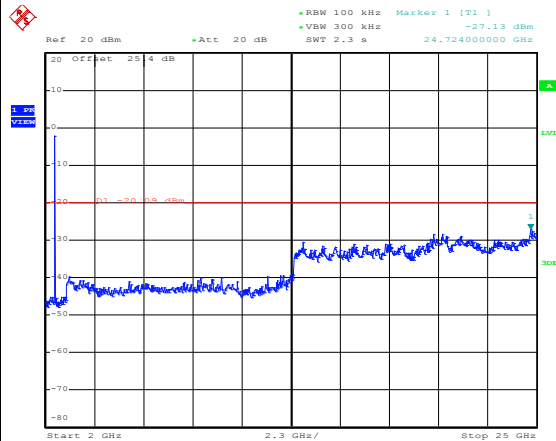

Date: 21.JUL.2014 18:20:20



Test Mode :	802.11g	Temperature :	21~26°C
Test Band :	2.4GHz High	Relative Humidity :	45~54%
Test Channel :	11	Test Engineer :	Alen Tsui

WLAN 802.11g Channel 11

100kHz PSD reference Level

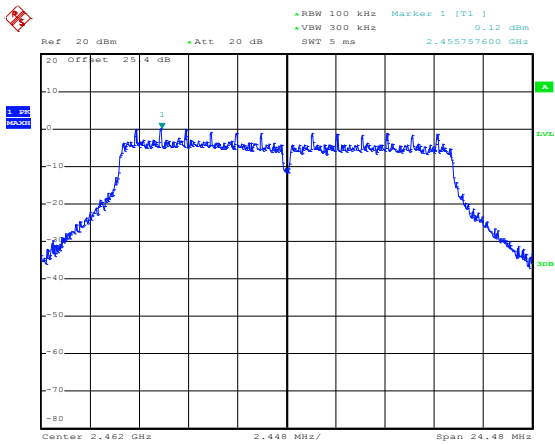

Date: 21.JUL.2014 16:24:30

High Channel Plot

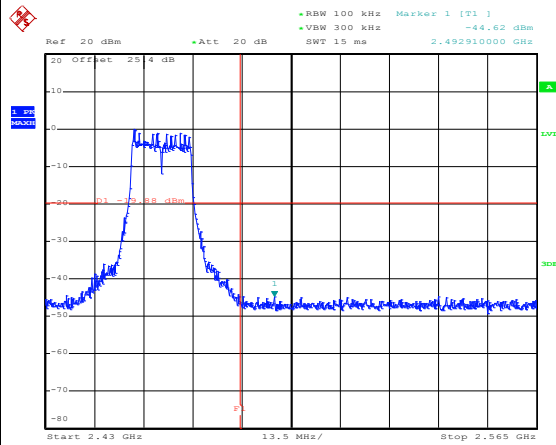

Date: 21.JUL.2014 16:25:24

Spurious Emission 30MHz~3GHz

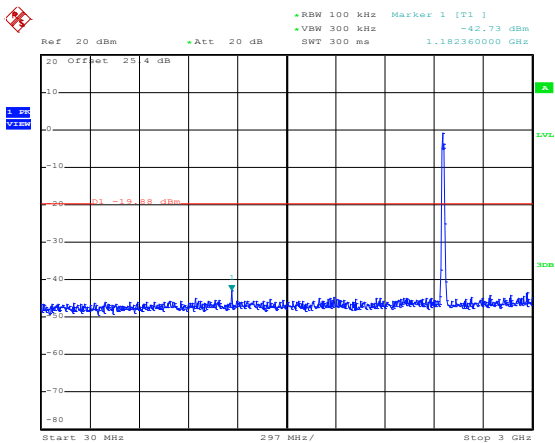

Date: 21.JUL.2014 16:25:46

Spurious Emission 2GHz~25GHz

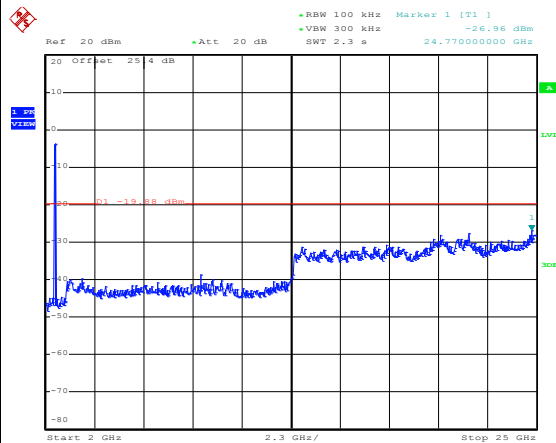

Date: 21.JUL.2014 16:26:04



Test Mode :	802.11n HT20	Temperature :	21~26°C
Test Band :	2.4GHz Low	Relative Humidity :	45~54%
Test Channel :	01	Test Engineer :	Alen Tsui

WLAN 802.11n HT20 Channel 01

100kHz PSD reference Level

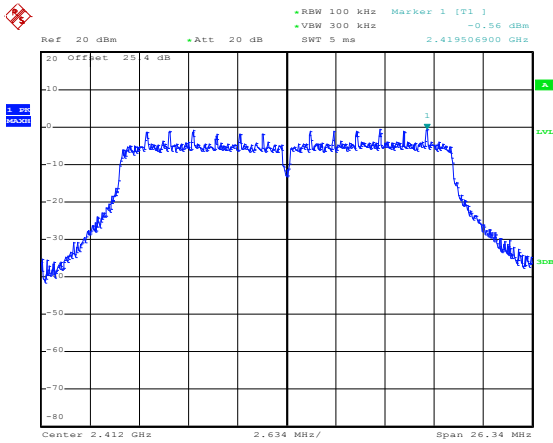

Date: 21.JUL.2014 16:30:44

Low Channel Plot

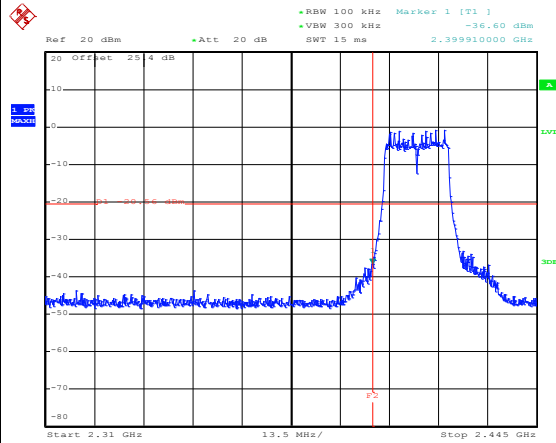

Date: 21.JUL.2014 16:31:56

Spurious Emission 30MHz~3GHz

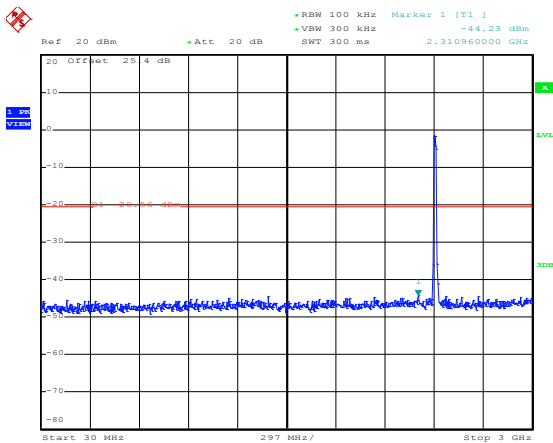

Date: 21.JUL.2014 16:32:17

Spurious Emission 2GHz~25GHz

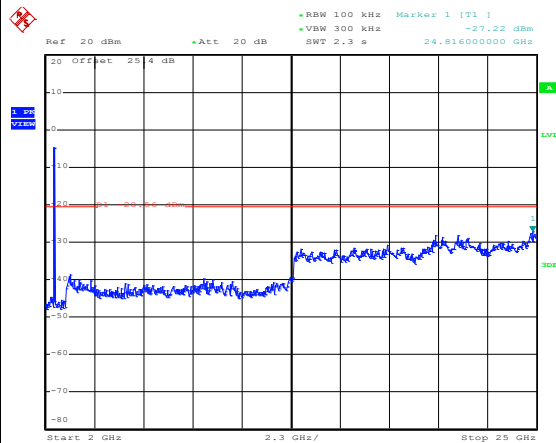

Date: 21.JUL.2014 16:32:35



Test Mode :	802.11n HT20	Temperature :	21~26°C
Test Band :	2.4GHz Mid	Relative Humidity :	45~54%
Test Channel :	06	Test Engineer :	Alen Tsui

WLAN 802.11n HT20 Channel 06

100kHz PSD reference Level

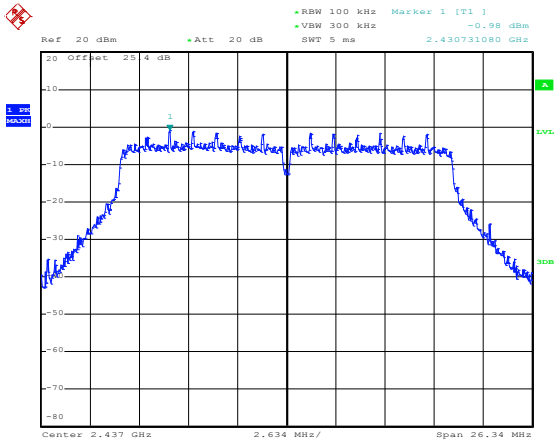

Date: 21.JUL.2014 16:34:43

Spurious Emission 30MHz~3GHz

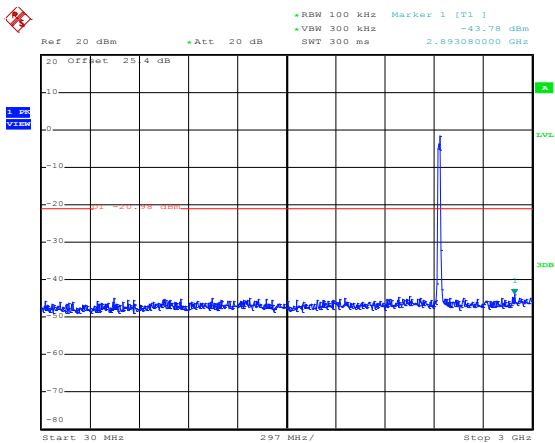

Date: 21.JUL.2014 16:35:04

Spurious Emission 2GHz~25GHz

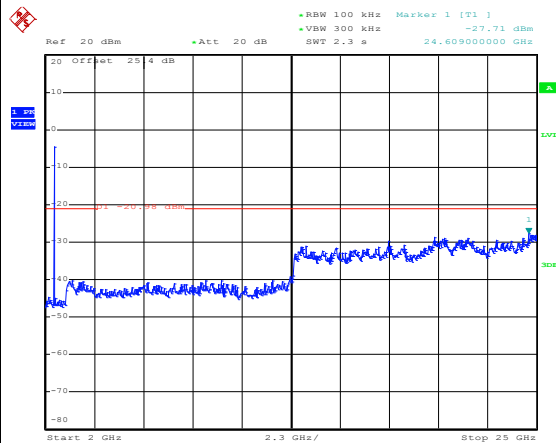

Date: 21.JUL.2014 16:35:22



Test Mode :	802.11n HT20	Temperature :	21~26°C
Test Band :	2.4GHz High	Relative Humidity :	45~54%
Test Channel :	11	Test Engineer :	Alen Tsui

WLAN 802.11n HT20 Channel 11

100kHz PSD reference Level

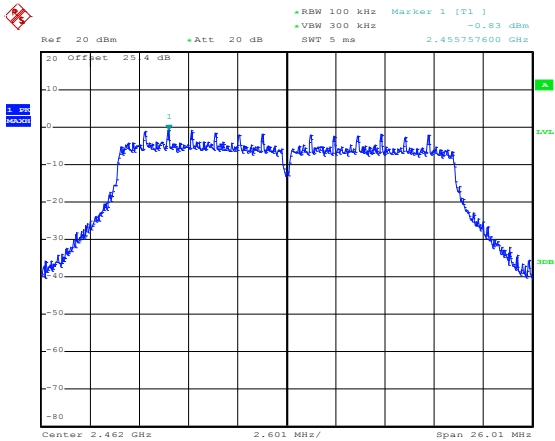

Date: 21.JUL.2014 16:38:13

High Channel Plot

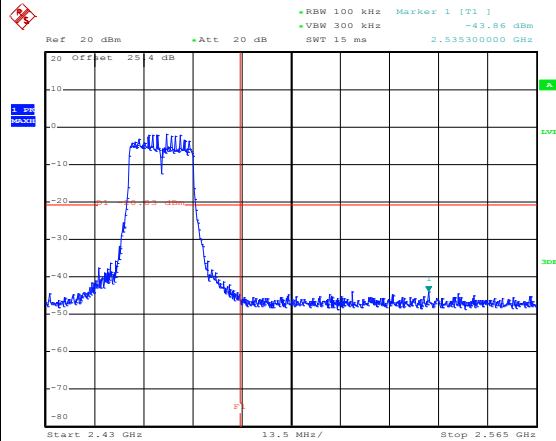

Date: 21.JUL.2014 16:38:29

Spurious Emission 30MHz~3GHz

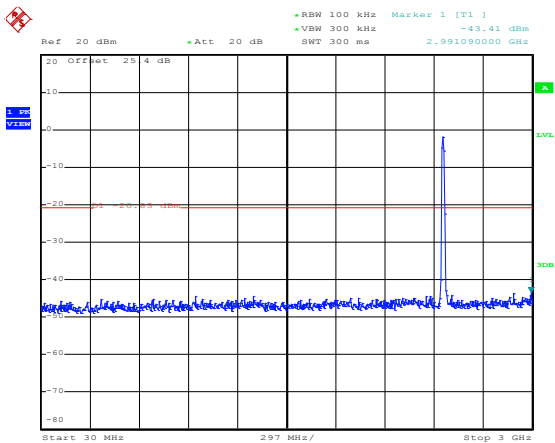

Date: 21.JUL.2014 16:40:21

Spurious Emission 2GHz~25GHz

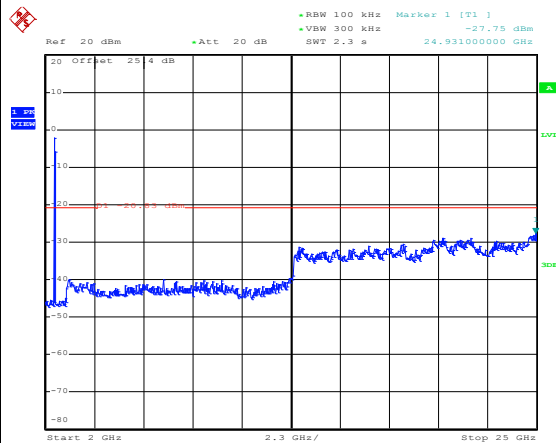

Date: 21.JUL.2014 16:40:39



Test Mode :	802.11a	Temperature :	21~26°C
Test Band :	5GHz Low	Relative Humidity :	45~54%
Test Channel :	149	Test Engineer :	Alen Tsui

WLAN 802.11a Channel 149

100kHz PSD reference Level

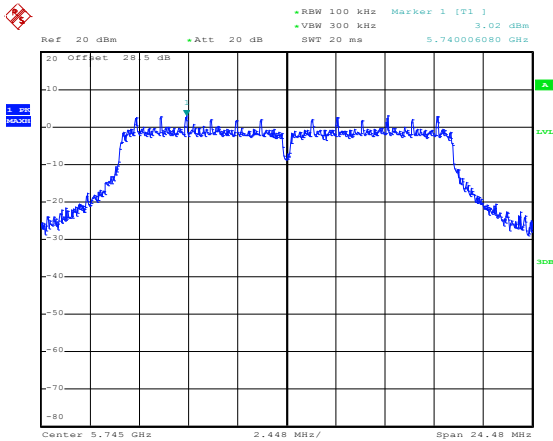

Date: 21.JUL.2014 17:10:08

Low Channel Plot

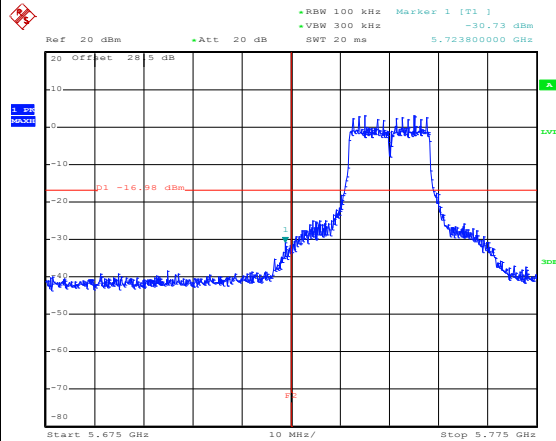

Date: 21.JUL.2014 17:10:24

Spurious Emission 30MHz~6GHz

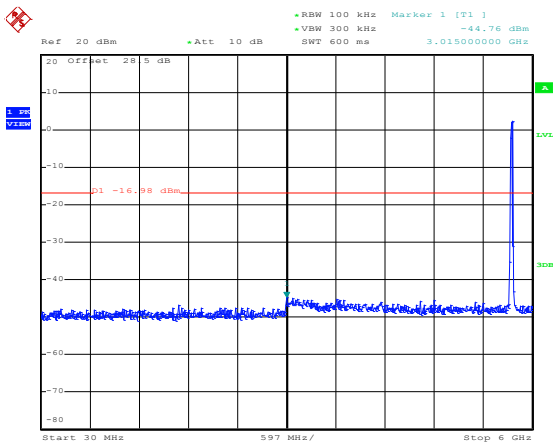

Date: 21.JUL.2014 17:12:22

Spurious Emission 5GHz~40GHz

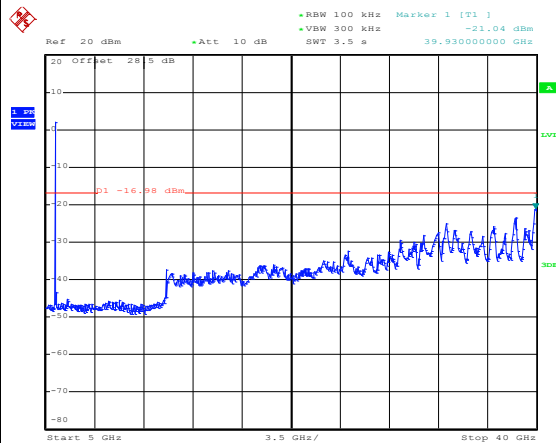

Date: 21.JUL.2014 17:12:40



Test Mode :	802.11a	Temperature :	21~26°C
Test Band :	5GHz Mid	Relative Humidity :	45~54%
Test Channel :	157	Test Engineer :	Alen Tsui

WLAN 802.11a Channel 157

100kHz PSD reference Level

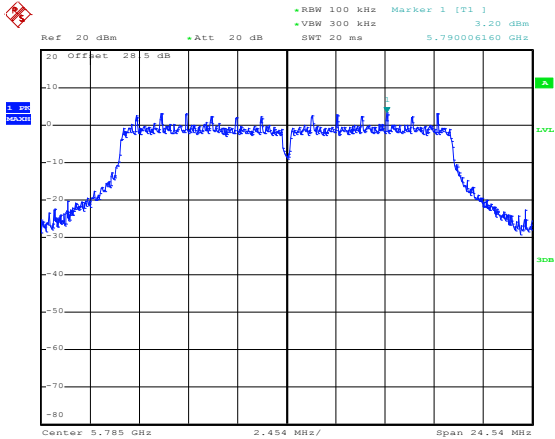

Date: 21.JUL.2014 17:24:56

Spurious Emission 30MHz~6GHz

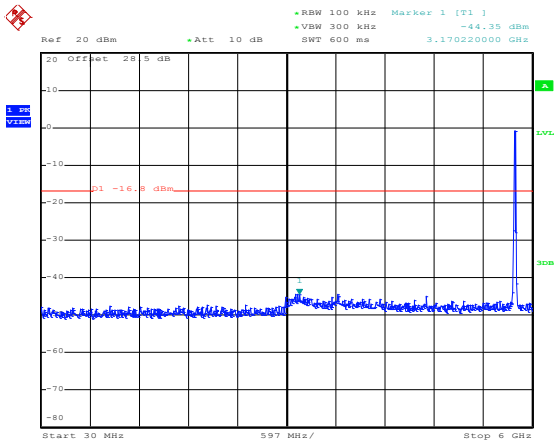

Date: 21.JUL.2014 17:25:17

Spurious Emission 5GHz~40GHz

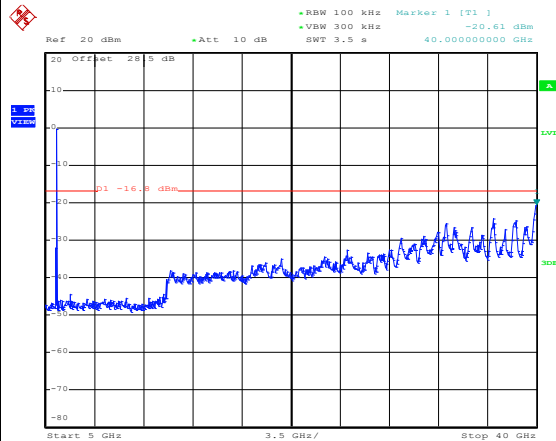

Date: 21.JUL.2014 17:25:35



Test Mode :	802.11a	Temperature :	21~26°C
Test Band :	5GHz High	Relative Humidity :	45~54%
Test Channel :	165	Test Engineer :	Alen Tsui

WLAN 802.11a Channel 165

100kHz PSD reference Level

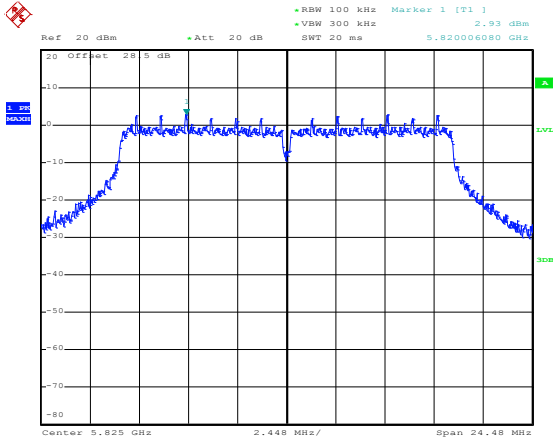

Date: 21.JUL.2014 17:28:50

High Channel Plot

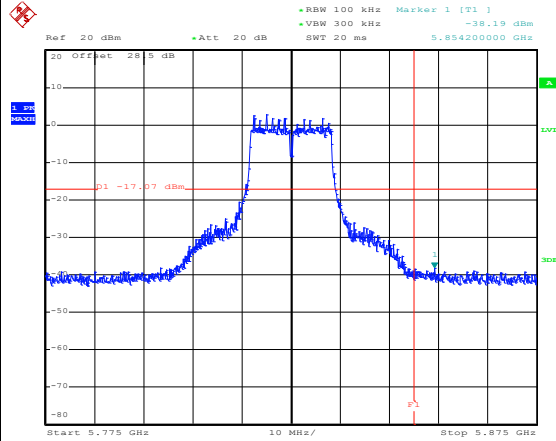

Date: 21.JUL.2014 17:29:06

Spurious Emission 30MHz~6GHz

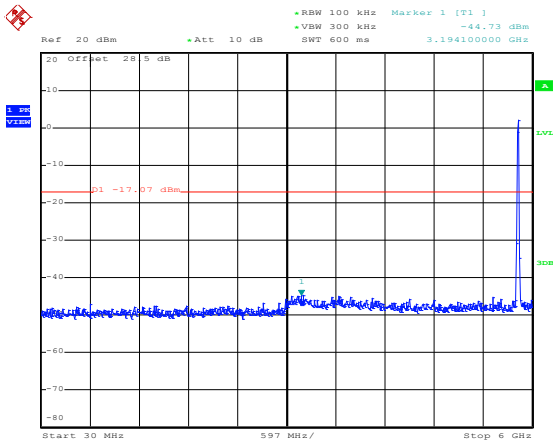

Date: 21.JUL.2014 17:29:27

Spurious Emission 5GHz~40GHz

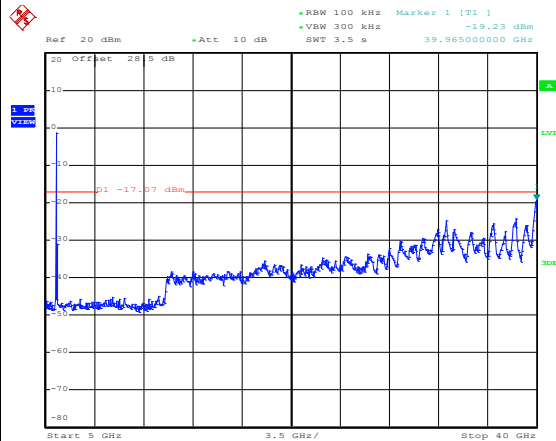

Date: 21.JUL.2014 17:29:45



Test Mode :	802.11n HT20	Temperature :	21~26°C
Test Band :	5GHz Low	Relative Humidity :	45~54%
Test Channel :	149	Test Engineer :	Alen Tsui

WLAN 802.11n HT20 Channel 149

100kHz PSD reference Level

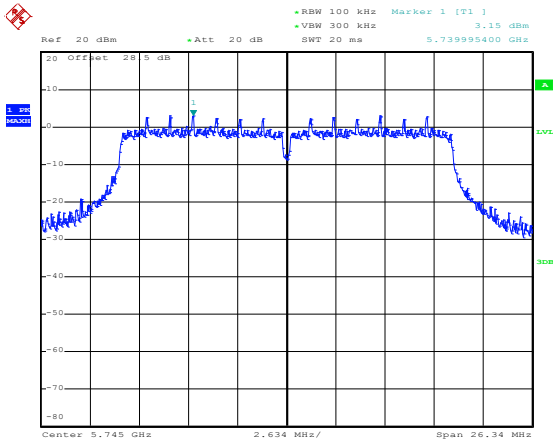

Date: 21.JUL.2014 17:33:26

Low Channel Plot

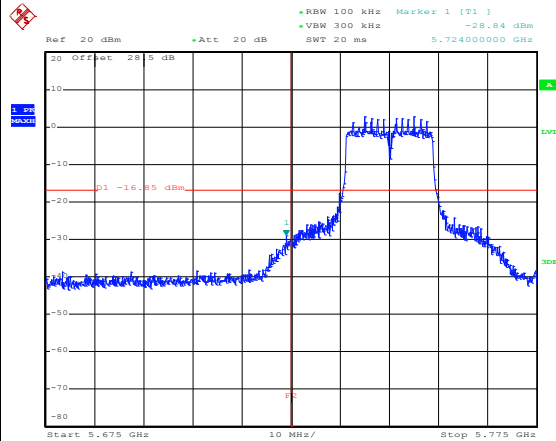

Date: 21.JUL.2014 17:34:04

Spurious Emission 30MHz~6GHz

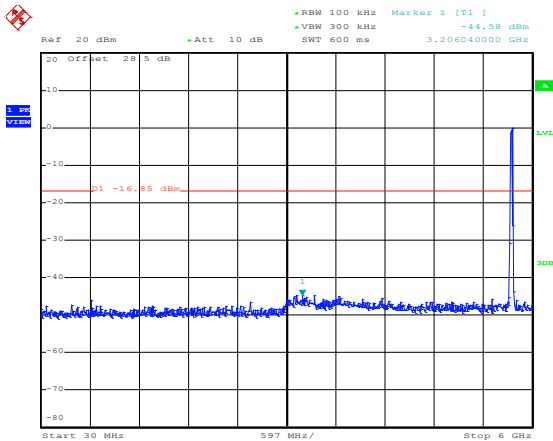

Date: 21.JUL.2014 17:34:26

Spurious Emission 5GHz~40GHz

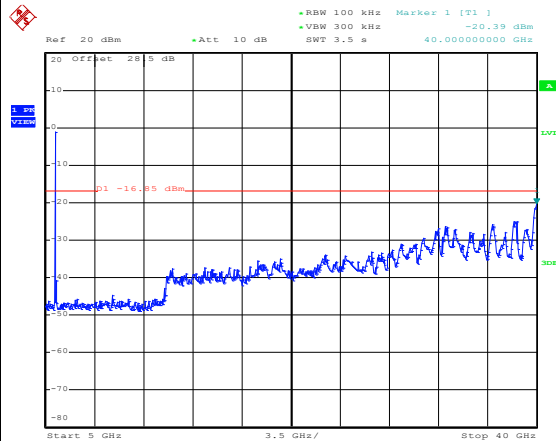

Date: 21.JUL.2014 17:34:44



Test Mode :	802.11n HT20	Temperature :	21~26°C
Test Band :	5GHz Mid	Relative Humidity :	45~54%
Test Channel :	157	Test Engineer :	Alen Tsui

WLAN 802.11n HT20 Channel 157

100kHz PSD reference Level

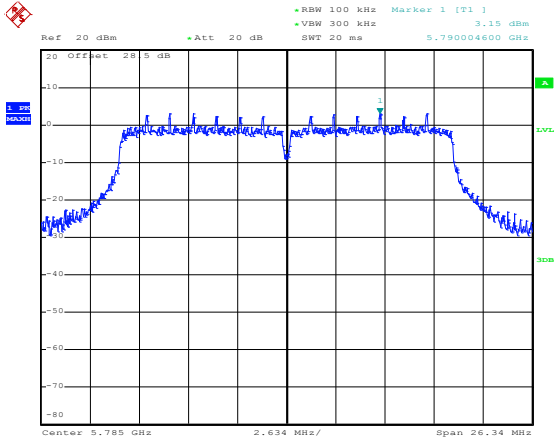

Date: 21.JUL.2014 17:37:44

Spurious Emission 30MHz~6GHz

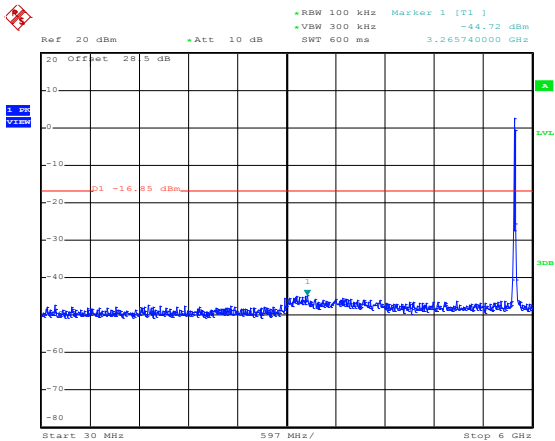

Date: 21.JUL.2014 17:38:17

Spurious Emission 5GHz~40GHz

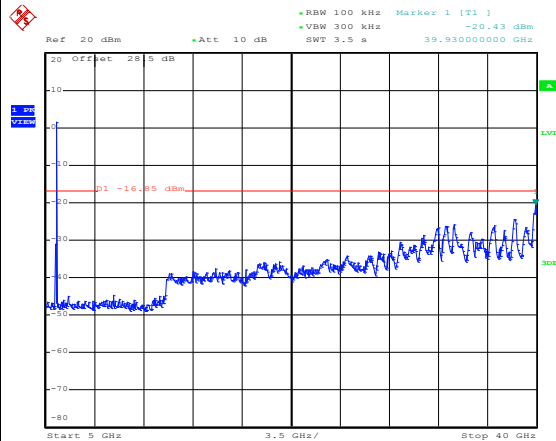

Date: 21.JUL.2014 17:38:35



Test Mode :	802.11n HT20	Temperature :	21~26°C
Test Band :	5GHz High	Relative Humidity :	45~54%
Test Channel :	165	Test Engineer :	Alen Tsui

WLAN 802.11n HT20 Channel 165

100kHz PSD reference Level

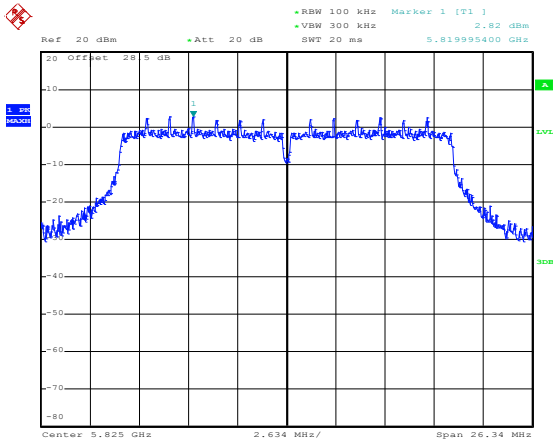

Date: 21.JUL.2014 17:41:46

High Channel Plot

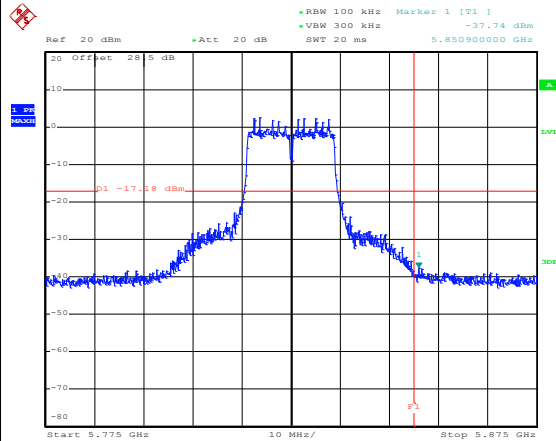

Date: 21.JUL.2014 17:42:29

Spurious Emission 30MHz~6GHz

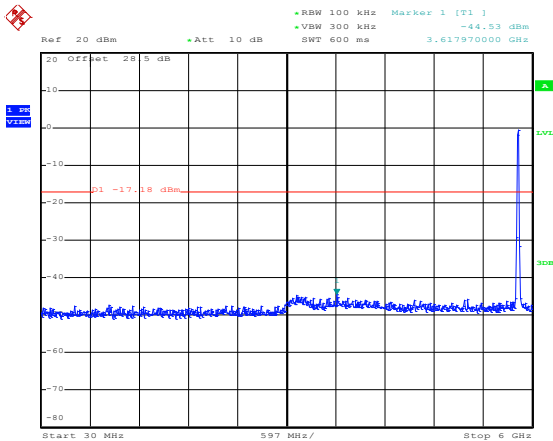

Date: 21.JUL.2014 17:42:50

Spurious Emission 5GHz~40GHz

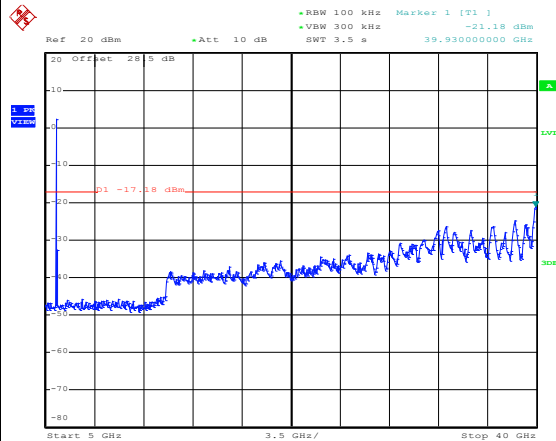

Date: 21.JUL.2014 17:43:08



Test Mode :	802.11n HT40	Temperature :	21~26°C
Test Band :	5GHz Low	Relative Humidity :	45~54%
Test Channel :	151	Test Engineer :	Alen Tsui

WLAN 802.11n HT40 Channel 151

100kHz PSD reference Level

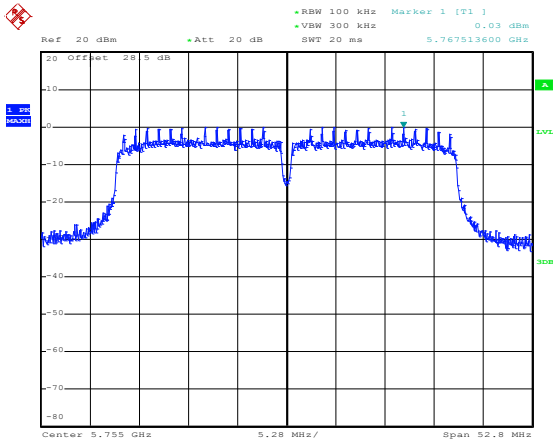

Date: 21.JUL.2014 17:57:13

Low Channel Plot

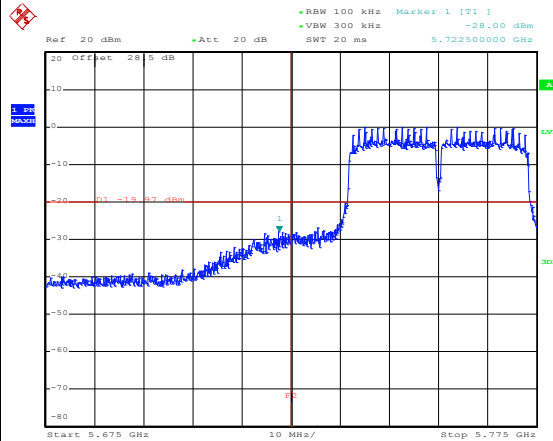

Date: 21.JUL.2014 17:57:50

Spurious Emission 30MHz~6GHz

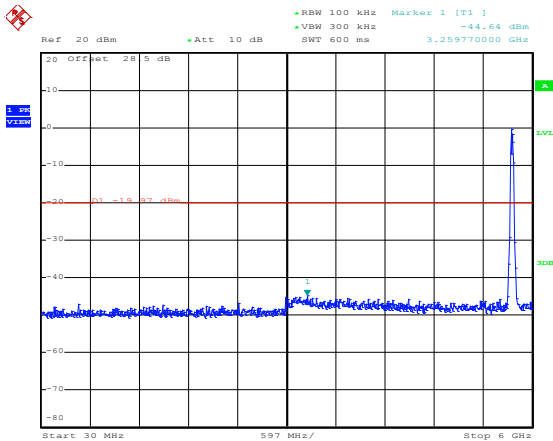

Date: 21.JUL.2014 17:58:56

Spurious Emission 5GHz~40GHz

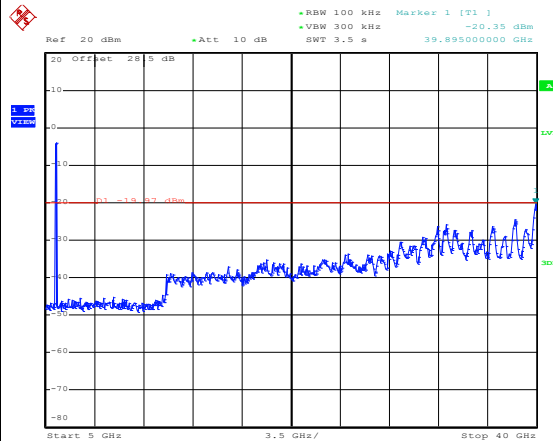

Date: 21.JUL.2014 17:59:14



Test Mode :	802.11n HT40	Temperature :	21~26°C
Test Band :	5GHz High	Relative Humidity :	45~54%
Test Channel :	159	Test Engineer :	Alen Tsui

WLAN 802.11n HT40 Channel 159

100kHz PSD reference Level

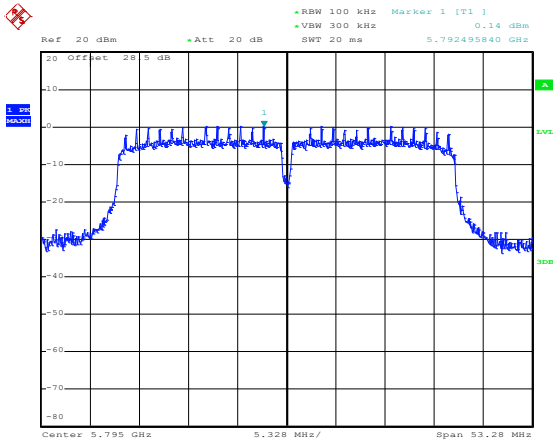

Date: 21.JUL.2014 18:02:12

High Channel Plot

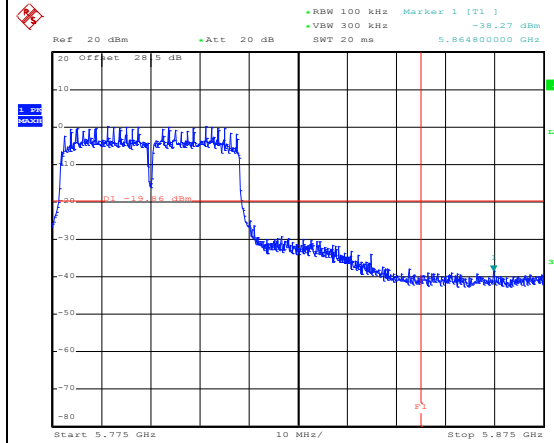

Date: 21.JUL.2014 18:02:28

Spurious Emission 30MHz~6GHz

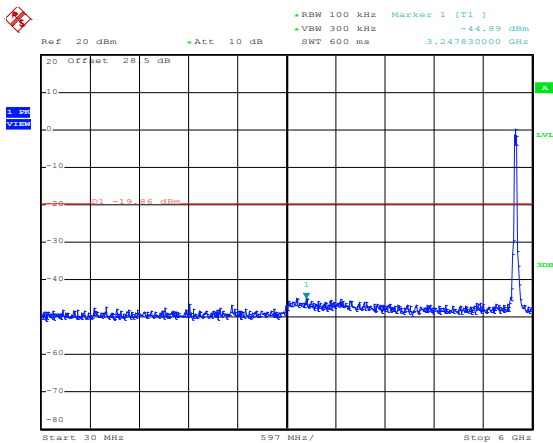

Date: 21.JUL.2014 18:02:49

Spurious Emission 5GHz~40GHz

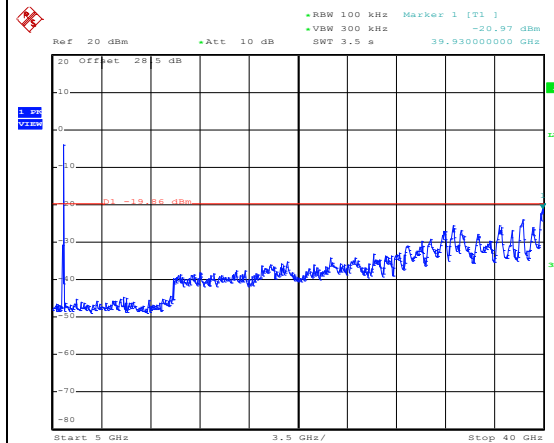

Date: 21.JUL.2014 18:03:07



3.5 Radiated Band Edges and Spurious Emission Measurement

3.5.1 Limit of Radiated band edge and Spurious Emission Measurement

In any 100 kHz bandwidth outside the intentional radiator frequency band, all harmonics/spurious must be at least 20 dB below the highest emission level within the authorized band. If the output power of this device was measured by spectrum analyzer, the attenuation under this paragraph shall be 30 dB instead of 20 dB. In addition, radiated emissions which fall in the restricted bands must also comply with the FCC section 15.209 limits as below.

Frequency (MHz)	Field Strength (microvolts/meter)	Measurement Distance (meters)
0.009 – 0.490	2400/F(kHz)	300
0.490 – 1.705	24000/F(kHz)	30
1.705 – 30.0	30	30
30 – 88	100	3
88 – 216	150	3
216 - 960	200	3
Above 960	500	3

3.5.2 Measuring Instruments

The measuring equipment is listed in the section 4 of this test report.



3.5.3 Test Procedures

1. The testing follows FCC KDB Publication No. 558074 D01 DTS Meas. Guidance v03r02.
2. The EUT was arranged to its worst case and then tune the antenna tower (from 1 m to 4 m) and turntable (from 0 degree to 360 degrees) to find the maximum reading. A pre-amp and a high pass filter are used for the test in order to get better signal level.
3. The EUT was placed on a turntable with 0.8 meter above ground.
4. The EUT was set 3 meters from the interference receiving antenna, which was mounted on the top of a variable height antenna tower.
5. Corrected Reading: Antenna Factor + Cable Loss + Read Level - Preamp Factor = Level
6. For measurement below 1GHz, If the emission level of the EUT measured by the peak detector is 3 dB lower than the applicable limit, the peak emission level will be reported. Otherwise, the emission measurement will be repeated using the quasi-peak detector and reported.
7. Use the following spectrum analyzer settings:
 - (1) Span shall wide enough to fully capture the emission being measured;
 - (2) Set RBW=100 kHz for f < 1 GHz; VBW ≥ RBW; Sweep = auto; Detector function = peak; Trace = max hold;
 - (3) Set RBW = 1 MHz, VBW= 3MHz for f ≥ 1 GHz for peak measurement.

For average measurement:

 - VBW = 10 Hz, when duty cycle is no less than 98 percent.
 - VBW ≥ 1/T, when duty cycle is less than 98 percent where T is the minimum transmission duration over which the transmitter is on and is transmitting at its maximum power control level for the tested mode of operation.

Band	Duty Cycle(%)	T(μs)	1/T(kHz)	VBW Setting
802.11b	97.63	8240	0.12	300Hz
802.11g	87.26	1370	0.73	1kHz
2.4GHz 802.11n HT20	86.49	1280	0.78	1kHz
802.11a	87.26	1370	0.73	1kHz
5GHz 802.11n HT20	86.49	1280	0.78	1kHz
5GHz 802.11n HT40	76.43	642	1.56	3kHz

3.5.4 Test Setup

For radiated emissions below 30MHz



For radiated emissions from 30MHz to 1GHz

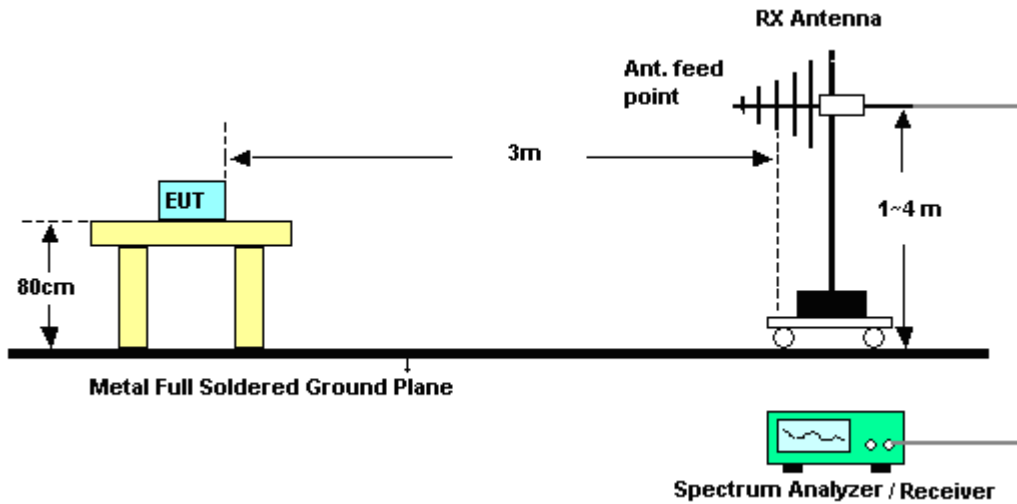

For radiated emissions above 1GHz

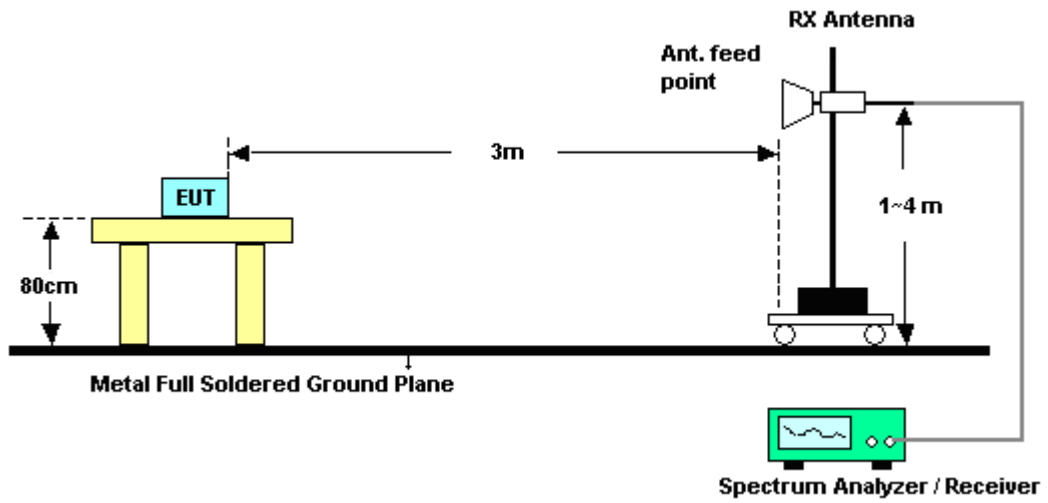



3.5.5 Test Results of Radiated Spurious Emissions (9kHz ~ 30MHz)

Test Mode :	802.11n Tx CH11 with WPC Charging Mode	Temperature :	22~24°C
Test Engineer :	Kyle Jhuang, Abi Lin and Derreck Chen	Relative Humidity :	46~48%
Polarization :	Horizontal		

Frequency (MHz)	Level (dBμV/m)	Over Limit (dB)	Limit Line (dBμV/m)	Read Level (dBμV)	Antenna Factor (dB)	Cable Loss (dB)	Ant Pos (cm)	Table Pos (deg)	Remark
0.01028	31.19	-96.18	127.37	10.62	20.28	0.29	-	-	Average
0.06102	34.87	-77.02	111.89	14.51	20.07	0.29	-	-	Average
0.09244	23.06	-85.23	108.29	2.72	20.05	0.29	-	-	QP
0.11852	58.7	-47.43	106.13	38.39	20.02	0.29	-	-	Average
0.14452	39.68	-64.73	104.41	19.39	20	0.29	-	-	Average
0.3795	46.57	-49.45	96.02	26.36	19.92	0.29	-	-	Average
0.50502	47.1	-26.44	73.54	26.91	19.9	0.29	100	23	QP
12.536	36.03	-33.97	70	15.97	19.66	0.4	-	-	QP
21.292	37.32	-32.68	70	16.77	20.12	0.43	-	-	QP
26.26	37.37	-32.63	70	16.55	20.35	0.47	-	-	QP



Test Mode :	802.11n Tx CH11 with WPC Charging Mode	Temperature :	22~24°C
Test Engineer :	Kyle Jhuang, Abi Lin and Derreck Chen	Relative Humidity :	46~48%
Polarization :	Vertical		

Frequency (MHz)	Level (dBμV/m)	Over Limit (dB)	Limit Line (dBμV/m)	Read Level (dBμV)	Antenna Factor (dB)	Cable Loss (dB)	Ant Pos (cm)	Table Pos (deg)	Remark
0.00946	28.39	-99.7	128.09	7.82	20.28	0.29	-	-	Average
0.06036	32.19	-79.8	111.99	11.83	20.07	0.29	-	-	Average
0.10296	21.78	-85.57	107.35	1.44	20.05	0.29	-	-	QP
0.12808	53.21	-52.24	105.45	32.9	20.02	0.29	-	-	Average
0.14176	23.94	-80.63	104.57	3.63	20.02	0.29	-	-	Average
0.47606	42.98	-51.07	94.05	22.79	19.9	0.29	-	-	Average
1.571	39.28	-24.4	63.68	19.01	19.94	0.33	100	325	QP
15.968	38.79	-31.21	70	18.71	19.67	0.41	-	-	QP
24.766	42.06	-27.94	70	21.3	20.31	0.45	-	-	QP
25.285	42.28	-27.72	70	21.51	20.32	0.45	-	-	QP



3.5.6 Test Result of Radiated Spurious at Band Edges

Test Mode :	802.11b	Temperature :	22~24°C
Test Band :	Low	Relative Humidity :	46~48%
Test Channel :	01	Test Engineer :	Kyle Jhuang, Abi Lin and Derreck Chen

ANTENNA POLARITY : HORIZONTAL										
Frequency (MHz)	Level (dBμV/m)	Over Limit (dB)	Limit Line (dBμV/m)	Read Level (dBμV)	Antenna Factor (dB)	Cable Loss (dB)	Preamp Factor (dB)	Ant Pos (cm)	Table Pos (deg)	Remark
2389.2	41.35	-32.65	74	43.09	27.19	4.24	33.17	100	213	Peak
2389.92	32.16	-21.84	54	33.9	27.19	4.24	33.17	100	213	Average

ANTENNA POLARITY : VERTICAL										
Frequency (MHz)	Level (dBμV/m)	Over Limit (dB)	Limit Line (dBμV/m)	Read Level (dBμV)	Antenna Factor (dB)	Cable Loss (dB)	Preamp Factor (dB)	Ant Pos (cm)	Table Pos (deg)	Remark
2367.06	41.78	-32.22	74	43.61	27.13	4.22	33.18	100	93	Peak
2389.83	31.36	-22.64	54	33.1	27.19	4.24	33.17	100	93	Average

Test Mode :	802.11b	Temperature :	22~24°C
Test Band :	High	Relative Humidity :	46~48%
Test Channel :	11	Test Engineer :	Kyle Jhuang, Abi Lin and Derreck Chen

ANTENNA POLARITY : HORIZONTAL										
Frequency (MHz)	Level (dBμV/m)	Over Limit (dB)	Limit Line (dBμV/m)	Read Level (dBμV)	Antenna Factor (dB)	Cable Loss (dB)	Preamp Factor (dB)	Ant Pos (cm)	Table Pos (deg)	Remark
2483.89	48.2	-25.8	74	49.6	27.45	4.29	33.14	100	340	Peak
2486.38	40.36	-13.64	54	41.75	27.46	4.29	33.14	100	340	Average

ANTENNA POLARITY : VERTICAL										
Frequency (MHz)	Level (dBμV/m)	Over Limit (dB)	Limit Line (dBμV/m)	Read Level (dBμV)	Antenna Factor (dB)	Cable Loss (dB)	Preamp Factor (dB)	Ant Pos (cm)	Table Pos (deg)	Remark
2483.59	47.1	-26.9	74	48.5	27.45	4.29	33.14	101	153	Peak
2486.5	38.9	-15.1	54	40.29	27.46	4.29	33.14	101	153	Average



Test Mode :	802.11g	Temperature :	22~24°C
Test Band :	Low	Relative Humidity :	46~48%
Test Channel :	01	Test Engineer :	Kyle Jhuang, Abi Lin and Derreck Chen

ANTENNA POLARITY : HORIZONTAL										
Frequency (MHz)	Level (dBμV/m)	Over Limit (dB)	Limit Line (dBμV/m)	Read Level (dBμV)	Antenna Factor (dB)	Cable Loss (dB)	Preamp Factor (dB)	Ant Pos (cm)	Table Pos (deg)	Remark
2389.83	55.36	-18.64	74	57.1	27.19	4.24	33.17	100	213	Peak
2389.92	39.19	-14.81	54	40.93	27.19	4.24	33.17	100	213	Average

ANTENNA POLARITY : VERTICAL										
Frequency (MHz)	Level (dBμV/m)	Over Limit (dB)	Limit Line (dBμV/m)	Read Level (dBμV)	Antenna Factor (dB)	Cable Loss (dB)	Preamp Factor (dB)	Ant Pos (cm)	Table Pos (deg)	Remark
2389.83	51.96	-22.04	74	53.7	27.19	4.24	33.17	102	90	Peak
2389.92	36.62	-17.38	54	38.36	27.19	4.24	33.17	102	90	Average

Test Mode :	802.11g	Temperature :	22~24°C
Test Band :	High	Relative Humidity :	46~48%
Test Channel :	11	Test Engineer :	Kyle Jhuang, Abi Lin and Derreck Chen

ANTENNA POLARITY : HORIZONTAL										
Frequency (MHz)	Level (dBμV/m)	Over Limit (dB)	Limit Line (dBμV/m)	Read Level (dBμV)	Antenna Factor (dB)	Cable Loss (dB)	Preamp Factor (dB)	Ant Pos (cm)	Table Pos (deg)	Remark
2484.1	62.08	-11.92	74	63.47	27.46	4.29	33.14	100	214	Peak
2483.5	45.76	-8.24	54	47.16	27.45	4.29	33.14	100	214	Average

ANTENNA POLARITY : VERTICAL										
Frequency (MHz)	Level (dBμV/m)	Over Limit (dB)	Limit Line (dBμV/m)	Read Level (dBμV)	Antenna Factor (dB)	Cable Loss (dB)	Preamp Factor (dB)	Ant Pos (cm)	Table Pos (deg)	Remark
2484.46	57.9	-16.1	74	59.29	27.46	4.29	33.14	102	146	Peak
2483.5	43.11	-10.89	54	44.51	27.45	4.29	33.14	102	146	Average



Test Mode :	802.11n HT20	Temperature :	22~24°C
Test Band :	Low	Relative Humidity :	46~48%
Test Channel :	01	Test Engineer :	Kyle Jhuang, Abi Lin and Derreck Chen

ANTENNA POLARITY : HORIZONTAL										
Frequency (MHz)	Level (dBμV/m)	Over Limit (dB)	Limit Line (dBμV/m)	Read Level (dBμV)	Antenna Factor (dB)	Cable Loss (dB)	Preamp Factor (dB)	Ant Pos (cm)	Table Pos (deg)	Remark
2389.74	50.76	-23.24	74	52.5	27.19	4.24	33.17	100	211	Peak
2389.92	38.83	-15.17	54	40.57	27.19	4.24	33.17	100	211	Average

ANTENNA POLARITY : VERTICAL										
Frequency (MHz)	Level (dBμV/m)	Over Limit (dB)	Limit Line (dBμV/m)	Read Level (dBμV)	Antenna Factor (dB)	Cable Loss (dB)	Preamp Factor (dB)	Ant Pos (cm)	Table Pos (deg)	Remark
2389.92	48.45	-25.55	74	50.19	27.19	4.24	33.17	105	151	Peak
2389.92	35.92	-18.08	54	37.66	27.19	4.24	33.17	105	151	Average

Test Mode :	802.11n HT20	Temperature :	22~24°C
Test Band :	High	Relative Humidity :	46~48%
Test Channel :	11	Test Engineer :	Kyle Jhuang, Abi Lin and Derreck Chen

ANTENNA POLARITY : HORIZONTAL										
Frequency (MHz)	Level (dBμV/m)	Over Limit (dB)	Limit Line (dBμV/m)	Read Level (dBμV)	Antenna Factor (dB)	Cable Loss (dB)	Preamp Factor (dB)	Ant Pos (cm)	Table Pos (deg)	Remark
2485.09	63.92	-10.08	74	65.31	27.46	4.29	33.14	100	195	Peak
2483.71	46.13	-7.87	54	47.53	27.45	4.29	33.14	100	195	Average

ANTENNA POLARITY : VERTICAL										
Frequency (MHz)	Level (dBμV/m)	Over Limit (dB)	Limit Line (dBμV/m)	Read Level (dBμV)	Antenna Factor (dB)	Cable Loss (dB)	Preamp Factor (dB)	Ant Pos (cm)	Table Pos (deg)	Remark
2484.13	60.42	-13.58	74	61.81	27.46	4.29	33.14	103	152	Peak
2483.5	44.53	-9.47	54	45.93	27.45	4.29	33.14	103	152	Average



3.5.7 Test Result of Radiated Spurious Emission (30MHz ~ 10th Harmonic)

Note: Pre-scanned all test modes and only choose the worst case mode recorded in the test report for radiated spurious emission below 1GHz.

Test Mode :	802.11b	Temperature :	22~24°C
Test Channel :	01	Relative Humidity :	46~48%
Test Engineer :	Kyle Jhuang, Abi Lin and Derreck Chen	Polarization :	Horizontal
Remark :	1. 2414 MHz is fundamental signal which can be ignored. 2. Average measurement was not performed if peak level went lower than the average limit.		

Frequency (MHz)	Level (dBμV/m)	Over Limit (dB)	Limit Line (dBμV/m)	Read Level (dBμV)	Antenna Factor (dB)	Cable Loss (dB)	Preamp Factor (dB)	Ant Pos (cm)	Table Pos (deg)	Remark
2414	100.03	-	-	101.67	27.26	4.26	33.16	100	213	Average
2414	106.55	-	-	108.19	27.26	4.26	33.16	100	213	Peak
4824	43.67	-30.33	74	38.28	31.59	6.23	32.43	100	0	Peak

Test Mode :	802.11b	Temperature :	22~24°C
Test Channel :	01	Relative Humidity :	46~48%
Test Engineer :	Kyle Jhuang, Abi Lin and Derreck Chen	Polarization :	Vertical
Remark :	1. 2414 MHz is fundamental signal which can be ignored. 2. Average measurement was not performed if peak level went lower than the average limit.		

Frequency (MHz)	Level (dBμV/m)	Over Limit (dB)	Limit Line (dBμV/m)	Read Level (dBμV)	Antenna Factor (dB)	Cable Loss (dB)	Preamp Factor (dB)	Ant Pos (cm)	Table Pos (deg)	Remark
2414	99.11	-	-	100.75	27.26	4.26	33.16	100	93	Average
2414	102.78	-	-	104.42	27.26	4.26	33.16	100	93	Peak
4824	44.38	-29.62	74	38.99	31.59	6.23	32.43	100	0	Peak



Test Mode :	802.11b	Temperature :	22~24°C
Test Channel :	06	Relative Humidity :	46~48%
Test Engineer :	Kyle Jhuang, Abi Lin and Derreck Chen	Polarization :	Horizontal
Remark :	1. 2438 MHz is fundamental signal which can be ignored. 2. Average measurement was not performed if peak level went lower than the average limit.		

Frequency (MHz)	Level (dBμV/m)	Over Limit (dB)	Limit Line (dBμV/m)	Read Level (dBμV)	Antenna Factor (dB)	Cable Loss (dB)	Preamp Factor (dB)	Ant Pos (cm)	Table Pos (deg)	Remark
2438	100.14	-	-	101.69	27.33	4.27	33.15	100	215	Average
2438	106.23	-	-	107.78	27.33	4.27	33.15	100	215	Peak
4875	41.7	-32.3	74	36.18	31.65	6.29	32.42	100	0	Peak
7311	50.16	-23.84	74	38.85	36.61	8.42	33.72	100	0	Peak

Test Mode :	802.11b	Temperature :	22~24°C
Test Channel :	06	Relative Humidity :	46~48%
Test Engineer :	Kyle Jhuang, Abi Lin and Derreck Chen	Polarization :	Vertical
Remark :	1. 2436 MHz is fundamental signal which can be ignored. 2. Average measurement was not performed if peak level went lower than the average limit.		

Frequency (MHz)	Level (dBμV/m)	Over Limit (dB)	Limit Line (dBμV/m)	Read Level (dBμV)	Antenna Factor (dB)	Cable Loss (dB)	Preamp Factor (dB)	Ant Pos (cm)	Table Pos (deg)	Remark
2436	99.66	-	-	101.23	27.32	4.27	33.16	104	153	Average
2436	104.72	-	-	106.29	27.32	4.27	33.16	104	153	Peak
4875	42.73	-31.27	74	37.21	31.65	6.29	32.42	100	0	Peak
7311	49.75	-24.25	74	38.44	36.61	8.42	33.72	100	0	Peak



Test Mode :	802.11b	Temperature :	22~24°C
Test Channel :	11	Relative Humidity :	46~48%
Test Engineer :	Kyle Jhuang, Abi Lin and Derreck Chen	Polarization :	Horizontal
Remark :	1. 2462 MHz is fundamental signal which can be ignored. 2. Average measurement was not performed if peak level went lower than the average limit.		

Frequency (MHz)	Level (dBμV/m)	Over Limit (dB)	Limit Line (dBμV/m)	Read Level (dBμV)	Antenna Factor (dB)	Cable Loss (dB)	Preamp Factor (dB)	Ant Pos (cm)	Table Pos (deg)	Remark
2462	99.93	-	-	101.41	27.39	4.28	33.15	100	340	Average
2462	104.46	-	-	105.94	27.39	4.28	33.15	100	340	Peak
4923	42.27	-31.73	74	36.63	31.71	6.34	32.41	100	0	Peak
7386	50.09	-23.91	74	38.75	36.8	8.32	33.78	100	0	Peak

Test Mode :	802.11b	Temperature :	22~24°C
Test Channel :	11	Relative Humidity :	46~48%
Test Engineer :	Kyle Jhuang, Abi Lin and Derreck Chen	Polarization :	Vertical
Remark :	1. 2462 MHz is fundamental signal which can be ignored. 2. Average measurement was not performed if peak level went lower than the average limit.		

Frequency (MHz)	Level (dBμV/m)	Over Limit (dB)	Limit Line (dBμV/m)	Read Level (dBμV)	Antenna Factor (dB)	Cable Loss (dB)	Preamp Factor (dB)	Ant Pos (cm)	Table Pos (deg)	Remark
2462	99.55	-	-	101.03	27.39	4.28	33.15	101	153	Average
2462	103.41	-	-	104.89	27.39	4.28	33.15	101	153	Peak
4923	42.95	-31.05	74	37.31	31.71	6.34	32.41	100	0	Peak
7386	49.68	-24.32	74	38.34	36.8	8.32	33.78	100	0	Peak



Test Mode :	802.11g	Temperature :	22~24°C
Test Channel :	01	Relative Humidity :	46~48%
Test Engineer :	Kyle Jhuang, Abi Lin and Derreck Chen	Polarization :	Horizontal
Remark :	1. 2414 MHz is fundamental signal which can be ignored. 2. Average measurement was not performed if peak level went lower than the average limit.		

Frequency (MHz)	Level (dBμV/m)	Over Limit (dB)	Limit Line (dBμV/m)	Read Level (dBμV)	Antenna Factor (dB)	Cable Loss (dB)	Preamp Factor (dB)	Ant Pos (cm)	Table Pos (deg)	Remark
2414	96.83	-	-	98.47	27.26	4.26	33.16	100	213	Average
2414	104.27	-	-	105.91	27.26	4.26	33.16	100	213	Peak
4824	41.27	-32.73	74	35.88	31.59	6.23	32.43	100	0	Peak

Test Mode :	802.11g	Temperature :	22~24°C
Test Channel :	01	Relative Humidity :	46~48%
Test Engineer :	Kyle Jhuang, Abi Lin and Derreck Chen	Polarization :	Vertical
Remark :	1. 2414 MHz is fundamental signal which can be ignored. 2. Average measurement was not performed if peak level went lower than the average limit.		

Frequency (MHz)	Level (dBμV/m)	Over Limit (dB)	Limit Line (dBμV/m)	Read Level (dBμV)	Antenna Factor (dB)	Cable Loss (dB)	Preamp Factor (dB)	Ant Pos (cm)	Table Pos (deg)	Remark
2414	93.67	-	-	95.31	27.26	4.26	33.16	102	90	Average
2414	100.8	-	-	102.44	27.26	4.26	33.16	102	90	Peak
4824	42.24	-31.76	74	36.85	31.59	6.23	32.43	100	0	Peak



Test Mode :	802.11g	Temperature :	22~24°C
Test Channel :	06	Relative Humidity :	46~48%
Test Engineer :	Kyle Jhuang, Abi Lin and Derreck Chen	Polarization :	Horizontal
Remark :	1. 2435 MHz is fundamental signal which can be ignored. 2. Average measurement was not performed if peak level went lower than the average limit.		

Frequency (MHz)	Level (dBμV/m)	Over Limit (dB)	Limit Line (dBμV/m)	Read Level (dBμV)	Antenna Factor (dB)	Cable Loss (dB)	Preamp Factor (dB)	Ant Pos (cm)	Table Pos (deg)	Remark
2435	96.57	-	-	98.14	27.32	4.27	33.16	100	214	Average
2435	103.98	-	-	105.55	27.32	4.27	33.16	100	214	Peak
4875	42.09	-31.91	74	36.57	31.65	6.29	32.42	100	0	Peak
7311	49.7	-24.3	74	38.39	36.61	8.42	33.72	100	0	Peak

Test Mode :	802.11g	Temperature :	22~24°C
Test Channel :	06	Relative Humidity :	46~48%
Test Engineer :	Kyle Jhuang, Abi Lin and Derreck Chen	Polarization :	Vertical
Remark :	1. 2435 MHz is fundamental signal which can be ignored. 2. Average measurement was not performed if peak level went lower than the average limit.		

Frequency (MHz)	Level (dBμV/m)	Over Limit (dB)	Limit Line (dBμV/m)	Read Level (dBμV)	Antenna Factor (dB)	Cable Loss (dB)	Preamp Factor (dB)	Ant Pos (cm)	Table Pos (deg)	Remark
2435	94.35	-	-	95.92	27.32	4.27	33.16	104	153	Average
2435	101.81	-	-	103.38	27.32	4.27	33.16	104	153	Peak
4875	41.77	-32.23	74	36.25	31.65	6.29	32.42	100	0	Peak
7311	49.5	-24.5	74	38.19	36.61	8.42	33.72	100	0	Peak



Test Mode :	802.11g	Temperature :	22~24°C
Test Channel :	11	Relative Humidity :	46~48%
Test Engineer :	Kyle Jhuang, Abi Lin and Derreck Chen	Polarization :	Horizontal
Remark :	1. 2458 MHz is fundamental signal which can be ignored. 2. Average measurement was not performed if peak level went lower than the average limit.		

Frequency (MHz)	Level (dBμV/m)	Over Limit (dB)	Limit Line (dBμV/m)	Read Level (dBμV)	Antenna Factor (dB)	Cable Loss (dB)	Preamp Factor (dB)	Ant Pos (cm)	Table Pos (deg)	Remark
69.96	34.57	-5.43	40	50.01	11.91	0.71	28.06	100	103	Peak
89.4	28.35	-15.15	43.5	47.51	8.19	0.76	28.11	-	-	Peak
236.01	21.43	-24.57	46	36.41	11.96	1.23	28.17	-	-	Peak
357.4	23.33	-22.67	46	34.57	15.36	1.54	28.14	-	-	Peak
716.5	28.26	-17.74	46	32.13	21.56	2.23	27.66	-	-	Peak
958	31.16	-14.84	46	30.91	24.53	2.63	26.91	-	-	Peak
2458	96.27	-	-	97.76	27.38	4.28	33.15	100	214	Average
2458	104.79	-	-	106.28	27.38	4.28	33.15	100	214	Peak
4923	42.78	-31.22	74	37.14	31.71	6.34	32.41	100	0	Peak
7386	50	-24	74	38.66	36.8	8.32	33.78	100	0	Peak



Test Mode :	802.11g	Temperature :	22~24°C
Test Channel :	11	Relative Humidity :	46~48%
Test Engineer :	Kyle Jhuang, Abi Lin and Derreck Chen	Polarization :	Vertical
Remark :	1. 2460 MHz is fundamental signal which can be ignored. 2. Average measurement was not performed if peak level went lower than the average limit.		

Frequency (MHz)	Level (dBμV/m)	Over Limit (dB)	Limit Line (dBμV/m)	Read Level (dBμV)	Antenna Factor (dB)	Cable Loss (dB)	Preamp Factor (dB)	Ant Pos (cm)	Table Pos (deg)	Remark
30	25.85	-14.15	40	39.83	13.6	0.41	27.99	-	-	Peak
61.86	24.01	-15.99	40	37.95	13.45	0.65	28.04	-	-	Peak
195.51	22.66	-20.84	43.5	38.91	10.78	1.13	28.16	-	-	Peak
553.4	26.26	-19.74	46	33.37	18.9	1.9	27.91	-	-	Peak
774.6	28.14	-17.86	46	31.02	22.35	2.31	27.54	-	-	Peak
958	32.81	-13.19	46	32.56	24.53	2.63	26.91	120	330	Peak
2460	93.38	-	-	94.86	27.39	4.28	33.15	102	146	Average
2460	100.67	-	-	102.15	27.39	4.28	33.15	102	146	Peak
4923	41.74	-32.26	74	36.1	31.71	6.34	32.41	100	0	Peak
7386	49.62	-24.38	74	38.28	36.8	8.32	33.78	100	0	Peak



Test Mode :	2.4GHz 802.11n HT20	Temperature :	22~24°C
Test Channel :	01	Relative Humidity :	46~48%
Test Engineer :	Kyle Jhuang, Abi Lin and Derreck Chen	Polarization :	Horizontal
Remark :	1. 2414 MHz is fundamental signal which can be ignored. 2. Average measurement was not performed if peak level went lower than the average limit.		

Frequency (MHz)	Level (dBμV/m)	Over Limit (dB)	Limit Line (dBμV/m)	Read Level (dBμV)	Antenna Factor (dB)	Cable Loss (dB)	Preamp Factor (dB)	Ant Pos (cm)	Table Pos (deg)	Remark
2414	95.93	-	-	97.57	27.26	4.26	33.16	100	211	Average
2414	103.71	-	-	105.35	27.26	4.26	33.16	100	211	Peak
4824	41.85	-32.15	74	36.46	31.59	6.23	32.43	100	0	Peak

Test Mode :	2.4GHz 802.11n HT20	Temperature :	22~24°C
Test Channel :	01	Relative Humidity :	46~48%
Test Engineer :	Kyle Jhuang, Abi Lin and Derreck Chen	Polarization :	Vertical
Remark :	1. 2414 MHz is fundamental signal which can be ignored. 2. Average measurement was not performed if peak level went lower than the average limit.		

Frequency (MHz)	Level (dBμV/m)	Over Limit (dB)	Limit Line (dBμV/m)	Read Level (dBμV)	Antenna Factor (dB)	Cable Loss (dB)	Preamp Factor (dB)	Ant Pos (cm)	Table Pos (deg)	Remark
2414	94.08	-	-	95.72	27.26	4.26	33.16	105	151	Average
2414	101.33	-	-	102.97	27.26	4.26	33.16	105	151	Peak
4824	42.59	-31.41	74	37.2	31.59	6.23	32.43	100	0	Peak



Test Mode :	2.4GHz 802.11n HT20	Temperature :	22~24°C
Test Channel :	06	Relative Humidity :	46~48%
Test Engineer :	Kyle Jhuang, Abi Lin and Derreck Chen	Polarization :	Horizontal
Remark :	1. 2437 MHz is fundamental signal which can be ignored. 2. Average measurement was not performed if peak level went lower than the average limit.		

Frequency (MHz)	Level (dBμV/m)	Over Limit (dB)	Limit Line (dBμV/m)	Read Level (dBμV)	Antenna Factor (dB)	Cable Loss (dB)	Preamp Factor (dB)	Ant Pos (cm)	Table Pos (deg)	Remark
2437	94.95	-	-	96.52	27.32	4.27	33.16	100	196	Average
2437	103.07	-	-	104.64	27.32	4.27	33.16	100	196	Peak
4875	41.74	-32.26	74	36.22	31.65	6.29	32.42	100	0	Peak
7311	49.54	-24.46	74	38.23	36.61	8.42	33.72	100	0	Peak

Test Mode :	2.4GHz 802.11n HT20	Temperature :	22~24°C
Test Channel :	06	Relative Humidity :	46~48%
Test Engineer :	Kyle Jhuang, Abi Lin and Derreck Chen	Polarization :	Vertical
Remark :	1. 2437 MHz is fundamental signal which can be ignored. 2. Average measurement was not performed if peak level went lower than the average limit.		

Frequency (MHz)	Level (dBμV/m)	Over Limit (dB)	Limit Line (dBμV/m)	Read Level (dBμV)	Antenna Factor (dB)	Cable Loss (dB)	Preamp Factor (dB)	Ant Pos (cm)	Table Pos (deg)	Remark
2437	92.07			93.64	27.32	4.27	33.16	100	150	Average
2437	100.49			102.06	27.32	4.27	33.16	100	150	Peak
4875	42.24	-31.76	74	36.72	31.65	6.29	32.42	100	0	Peak
7311	49.25	-24.75	74	37.94	36.61	8.42	33.72	100	0	Peak



Test Mode :	2.4GHz 802.11n HT20	Temperature :	22~24°C
Test Channel :	11	Relative Humidity :	46~48%
Test Engineer :	Kyle Jhuang, Abi Lin and Derreck Chen	Polarization :	Horizontal
Remark :	1. 2462 MHz is fundamental signal which can be ignored. 2. Average measurement was not performed if peak level went lower than the average limit.		

Frequency (MHz)	Level (dBμV/m)	Over Limit (dB)	Limit Line (dBμV/m)	Read Level (dBμV)	Antenna Factor (dB)	Cable Loss (dB)	Preamp Factor (dB)	Ant Pos (cm)	Table Pos (deg)	Remark
48.63	21.99	-18.01	40	35.04	14.35	0.6	28	-	-	Peak
66.72	21.45	-18.55	40	36.3	12.52	0.68	28.05	-	-	Peak
266.79	29.8	-16.2	46	43.59	13.07	1.31	28.17	-	-	Peak
512.1	26.89	-19.11	46	34.75	18.27	1.83	27.96	-	-	Peak
731.2	27.47	-18.53	46	31.07	21.8	2.23	27.63	-	-	Peak
957.3	31.53	-14.47	46	31.29	24.53	2.62	26.91	100	126	Peak
2462	95.54	-	-	97.02	27.39	4.28	33.15	100	195	Average
2462	103.43	-	-	104.91	27.39	4.28	33.15	100	195	Peak
4923	42.72	-31.28	74	37.08	31.71	6.34	32.41	100	0	Peak
7386	49.16	-24.84	74	37.82	36.8	8.32	33.78	100	0	Peak



Test Mode :	2.4GHz 802.11n HT20	Temperature :	22~24°C
Test Channel :	11	Relative Humidity :	46~48%
Test Engineer :	Kyle Jhuang, Abi Lin and Derreck Chen	Polarization :	Vertical
Remark :	1. 2462 MHz is fundamental signal which can be ignored. 2. Average measurement was not performed if peak level went lower than the average limit.		

Frequency (MHz)	Level (dBμV/m)	Over Limit (dB)	Limit Line (dBμV/m)	Read Level (dBμV)	Antenna Factor (dB)	Cable Loss (dB)	Preamp Factor (dB)	Ant Pos (cm)	Table Pos (deg)	Remark
83.73	34.6	-5.4	40	52.91	9.04	0.74	28.09	125	310	Peak
217.65	20.98	-25.02	46	37	10.95	1.19	28.16	-	-	Peak
291.63	19.72	-26.28	46	32.59	13.93	1.38	28.18	-	-	Peak
550.6	27.03	-18.97	46	34.23	18.82	1.89	27.91	-	-	Peak
742.4	27.59	-18.41	46	30.98	21.98	2.24	27.61	-	-	Peak
958	31.84	-14.16	46	31.59	24.53	2.63	26.91	-	-	Peak
2462	93.51	-	-	94.99	27.39	4.28	33.15	103	152	Average
2462	101.47	-	-	102.95	27.39	4.28	33.15	103	152	Peak
4923	42.35	-31.65	74	36.71	31.71	6.34	32.41	100	0	Peak
7386	49.55	-24.45	74	38.21	36.8	8.32	33.78	100	0	Peak



Test Mode :	802.11a	Temperature :	22~24°C
Test Channel :	149	Relative Humidity :	46~48%
Test Engineer :	Kyle Jhuang, Abi Lin and Derreck Chen	Polarization :	Horizontal
Remark :	1. 5745 MHz is fundamental signal which can be ignored. 2. Average measurement was not performed if peak level went lower than the average limit.		

Frequency (MHz)	Level (dBμV/m)	Over Limit (dB)	Limit Line (dBμV/m)	Read Level (dBμV)	Antenna Factor (dB)	Cable Loss (dB)	Preamp Factor (dB)	Ant Pos (cm)	Table Pos (deg)	Remark
5745	96.78	-	-	89.68	32.59	7.04	32.53	108	9	Average
5745	103.4	-	-	96.3	32.59	7.04	32.53	108	9	Peak
11490	46.96	-27.04	74	29.74	40.21	11.53	34.52	100	0	Peak

Test Mode :	802.11a	Temperature :	22~24°C
Test Channel :	149	Relative Humidity :	46~48%
Test Engineer :	Kyle Jhuang, Abi Lin and Derreck Chen	Polarization :	Vertical
Remark :	1. 5745 MHz is fundamental signal which can be ignored. 2. Average measurement was not performed if peak level went lower than the average limit.		

Frequency (MHz)	Level (dBμV/m)	Over Limit (dB)	Limit Line (dBμV/m)	Read Level (dBμV)	Antenna Factor (dB)	Cable Loss (dB)	Preamp Factor (dB)	Ant Pos (cm)	Table Pos (deg)	Remark
5745	96.52	-	-	89.42	32.59	7.04	32.53	101	324	Average
5745	103.83	-	-	96.73	32.59	7.04	32.53	101	324	Peak
11490	44.62	-29.38	74	27.4	40.21	11.53	34.52	100	0	Peak



Test Mode :	802.11a	Temperature :	22~24°C
Test Channel :	157	Relative Humidity :	46~48%
Test Engineer :	Kyle Jhuang, Abi Lin and Derreck Chen	Polarization :	Horizontal
Remark :	1. 5785 MHz is fundamental signal which can be ignored. 2. Average measurement was not performed if peak level went lower than the average limit.		

Frequency (MHz)	Level (dBμV/m)	Over Limit (dB)	Limit Line (dBμV/m)	Read Level (dBμV)	Antenna Factor (dB)	Cable Loss (dB)	Preamp Factor (dB)	Ant Pos (cm)	Table Pos (deg)	Remark
5785	95.19	-	-	88.03	32.64	7.07	32.55	102	60	Average
5785	102.92	-	-	95.76	32.64	7.07	32.55	102	60	Peak
11571	46.06	-27.94	74	28.98	40.06	11.54	34.52	100	0	Peak

Test Mode :	802.11a	Temperature :	22~24°C
Test Channel :	157	Relative Humidity :	46~48%
Test Engineer :	Kyle Jhuang, Abi Lin and Derreck Chen	Polarization :	Vertical
Remark :	1. 5785 MHz is fundamental signal which can be ignored. 2. Average measurement was not performed if peak level went lower than the average limit.		

Frequency (MHz)	Level (dBμV/m)	Over Limit (dB)	Limit Line (dBμV/m)	Read Level (dBμV)	Antenna Factor (dB)	Cable Loss (dB)	Preamp Factor (dB)	Ant Pos (cm)	Table Pos (deg)	Remark
5785	95.57	-	-	88.41	32.64	7.07	32.55	100	320	Average
5785	102.7	-	-	95.54	32.64	7.07	32.55	100	320	Peak
11571	45.01	-28.99	74	27.93	40.06	11.54	34.52	100	0	Peak



Test Mode :	802.11a	Temperature :	22~24°C
Test Channel :	165	Relative Humidity :	46~48%
Test Engineer :	Kyle Jhuang, Abi Lin and Derreck Chen	Polarization :	Horizontal
Remark :	1. 5825 MHz is fundamental signal which can be ignored. 2. Average measurement was not performed if peak level went lower than the average limit.		

Frequency (MHz)	Level (dBμV/m)	Over Limit (dB)	Limit Line (dBμV/m)	Read Level (dBμV)	Antenna Factor (dB)	Cable Loss (dB)	Preamp Factor (dB)	Ant Pos (cm)	Table Pos (deg)	Remark
75.36	23.72	-16.28	40	40.39	10.67	0.73	28.07	-	-	Peak
121.53	23.85	-19.65	43.5	39.43	11.65	0.91	28.14	-	-	Peak
295.95	32.09	-13.91	46	44.86	14.02	1.39	28.18	-	-	Peak
553.4	26.81	-19.19	46	33.92	18.9	1.9	27.91	-	-	Peak
755	27.59	-18.41	46	30.77	22.15	2.25	27.58	-	-	Peak
957.3	33.03	-12.97	46	32.79	24.53	2.62	26.91	110	58	Peak
5825	94.88	-	-	87.68	32.69	7.08	32.57	102	60	Average
5825	102.41	-	-	95.21	32.69	7.08	32.57	102	60	Peak
11652	47.44	-26.56	74	30.51	39.9	11.55	34.52	100	0	Peak



Test Mode :	802.11a	Temperature :	22~24°C
Test Channel :	165	Relative Humidity :	46~48%
Test Engineer :	Kyle Jhuang, Abi Lin and Derreck Chen	Polarization :	Vertical
Remark :	1. 5825 MHz is fundamental signal which can be ignored. 2. Average measurement was not performed if peak level went lower than the average limit.		

Frequency (MHz)	Level (dBμV/m)	Over Limit (dB)	Limit Line (dBμV/m)	Read Level (dBμV)	Antenna Factor (dB)	Cable Loss (dB)	Preamp Factor (dB)	Ant Pos (cm)	Table Pos (deg)	Remark
33.24	26.52	-13.48	40	40.54	13.54	0.43	27.99	100	220	Peak
122.61	21.91	-21.59	43.5	37.38	11.76	0.91	28.14	-	-	Peak
187.14	19.68	-23.82	43.5	35.49	11.26	1.09	28.16	-	-	Peak
559.7	25.49	-20.51	46	32.4	19.07	1.92	27.9	-	-	Peak
732.6	27.36	-18.64	46	30.94	21.82	2.23	27.63	-	-	Peak
957.3	31.98	-14.02	46	31.74	24.53	2.62	26.91	-	-	Peak
5825	94.2	-	-	87	32.69	7.08	32.57	100	321	Average
5825	101.86	-	-	94.66	32.69	7.08	32.57	100	321	Peak
11649	45.6	-28.4	74	28.67	39.9	11.55	34.52	100	0	Peak



Test Mode :	5GHz 802.11n HT20	Temperature :	22~24°C
Test Channel :	149	Relative Humidity :	46~48%
Test Engineer :	Kyle Jhuang, Abi Lin and Derreck Chen	Polarization :	Horizontal
Remark :	1. 5745 MHz is fundamental signal which can be ignored. 2. Average measurement was not performed if peak level went lower than the average limit.		

Frequency (MHz)	Level (dBμV/m)	Over Limit (dB)	Limit Line (dBμV/m)	Read Level (dBμV)	Antenna Factor (dB)	Cable Loss (dB)	Preamp Factor (dB)	Ant Pos (cm)	Table Pos (deg)	Remark
69.15	34.09	-5.91	40	49.39	12.06	0.7	28.06	100	113	Peak
140.16	24.24	-19.26	43.5	37.87	13.5	1.01	28.14	-	-	Peak
296.76	30.65	-15.35	46	43.4	14.04	1.39	28.18	-	-	Peak
352.5	24.6	-21.4	46	35.94	15.26	1.54	28.14	-	-	Peak
825.7	29.34	-16.66	46	31.43	22.91	2.39	27.39	-	-	Peak
957.3	31.85	-14.15	46	31.61	24.53	2.62	26.91	-	-	Peak
5745	96.14	-	-	89.04	32.59	7.04	32.53	108	7	Average
5745	103.28	-	-	96.18	32.59	7.04	32.53	108	7	Peak
11490	47.43	-26.57	74	30.21	40.21	11.53	34.52	100	0	Peak



Test Mode :	5GHz 802.11n HT20	Temperature :	22~24°C
Test Channel :	149	Relative Humidity :	46~48%
Test Engineer :	Kyle Jhuang, Abi Lin and Derreck Chen	Polarization :	Vertical
Remark :	1. 5745 MHz is fundamental signal which can be ignored. 2. Average measurement was not performed if peak level went lower than the average limit.		

Frequency (MHz)	Level (dBμV/m)	Over Limit (dB)	Limit Line (dBμV/m)	Read Level (dBμV)	Antenna Factor (dB)	Cable Loss (dB)	Preamp Factor (dB)	Ant Pos (cm)	Table Pos (deg)	Remark
71.85	34.45	-5.55	40	50.32	11.47	0.72	28.06	100	163	Peak
214.41	26.19	-17.31	43.5	42.28	10.89	1.18	28.16	-	-	Peak
258.69	21.32	-24.68	46	35.46	12.75	1.28	28.17	-	-	Peak
553.4	26.79	-19.21	46	33.9	18.9	1.9	27.91	-	-	Peak
797.7	28.4	-17.6	46	30.94	22.58	2.37	27.49	-	-	Peak
957.3	32.24	-13.76	46	32	24.53	2.62	26.91	-	-	Peak
5745	96.21	-	-	89.11	32.59	7.04	32.53	101	323	Average
5745	103.43	-	-	96.33	32.59	7.04	32.53	101	323	Peak
11490	44.36	-29.64	74	27.14	40.21	11.53	34.52	100	0	Peak



Test Mode :	5GHz 802.11n HT20	Temperature :	22~24°C
Test Channel :	157	Relative Humidity :	46~48%
Test Engineer :	Kyle Jhuang, Abi Lin and Derreck Chen	Polarization :	Horizontal
Remark :	1. 5785 MHz is fundamental signal which can be ignored. 2. Average measurement was not performed if peak level went lower than the average limit.		

Frequency (MHz)	Level (dBμV/m)	Over Limit (dB)	Limit Line (dBμV/m)	Read Level (dBμV)	Antenna Factor (dB)	Cable Loss (dB)	Preamp Factor (dB)	Ant Pos (cm)	Table Pos (deg)	Remark
5785	94.8	-	-	87.64	32.64	7.07	32.55	102	61	Average
5785	102.08	-	-	94.92	32.64	7.07	32.55	102	61	Peak
11571	47.09	-26.91	74	30.01	40.06	11.54	34.52	100	0	Peak

Test Mode :	5GHz 802.11n HT20	Temperature :	22~24°C
Test Channel :	157	Relative Humidity :	46~48%
Test Engineer :	Kyle Jhuang, Abi Lin and Derreck Chen	Polarization :	Vertical
Remark :	1. 5785 MHz is fundamental signal which can be ignored. 2. Average measurement was not performed if peak level went lower than the average limit.		

Frequency (MHz)	Level (dBμV/m)	Over Limit (dB)	Limit Line (dBμV/m)	Read Level (dBμV)	Antenna Factor (dB)	Cable Loss (dB)	Preamp Factor (dB)	Ant Pos (cm)	Table Pos (deg)	Remark
5785	95.33	-	-	88.17	32.64	7.07	32.55	101	324	Average
5785	103.08	-	-	95.92	32.64	7.07	32.55	101	324	Peak
11571	45.42	-28.58	74	28.34	40.06	11.54	34.52	100	0	Peak



Test Mode :	5GHz 802.11n HT20	Temperature :	22~24°C
Test Channel :	165	Relative Humidity :	46~48%
Test Engineer :	Kyle Jhuang, Abi Lin and Derreck Chen	Polarization :	Horizontal
Remark :	1. 5825 MHz is fundamental signal which can be ignored. 2. Average measurement was not performed if peak level went lower than the average limit.		

Frequency (MHz)	Level (dBμV/m)	Over Limit (dB)	Limit Line (dBμV/m)	Read Level (dBμV)	Antenna Factor (dB)	Cable Loss (dB)	Preamp Factor (dB)	Ant Pos (cm)	Table Pos (deg)	Remark
5825	94.58	-	-	87.38	32.69	7.08	32.57	102	61	Average
5825	101.91	-	-	94.71	32.69	7.08	32.57	102	61	Peak
11652	47.07	-26.93	74	30.14	39.9	11.55	34.52	100	0	Peak

Test Mode :	5GHz 802.11n HT20	Temperature :	22~24°C
Test Channel :	165	Relative Humidity :	46~48%
Test Engineer :	Kyle Jhuang, Abi Lin and Derreck Chen	Polarization :	Vertical
Remark :	1. 5825 MHz is fundamental signal which can be ignored. 2. Average measurement was not performed if peak level went lower than the average limit.		

Frequency (MHz)	Level (dBμV/m)	Over Limit (dB)	Limit Line (dBμV/m)	Read Level (dBμV)	Antenna Factor (dB)	Cable Loss (dB)	Preamp Factor (dB)	Ant Pos (cm)	Table Pos (deg)	Remark
5825	93.92	-	-	86.72	32.69	7.08	32.57	100	325	Average
5825	101.5	-	-	94.3	32.69	7.08	32.57	100	325	Peak
11652	44.34	-29.66	74	27.41	39.9	11.55	34.52	100	0	Peak



Test Mode :	5GHz 802.11n HT40	Temperature :	22~24°C
Test Channel :	151	Relative Humidity :	46~48%
Test Engineer :	Kyle Jhuang, Abi Lin and Derreck Chen	Polarization :	Horizontal
Remark :	1. 5755 MHz is fundamental signal which can be ignored. 2. Average measurement was not performed if peak level went lower than the average limit.		

Frequency (MHz)	Level (dBμV/m)	Over Limit (dB)	Limit Line (dBμV/m)	Read Level (dBμV)	Antenna Factor (dB)	Cable Loss (dB)	Preamp Factor (dB)	Ant Pos (cm)	Table Pos (deg)	Remark
74.55	26.23	-13.77	40	42.72	10.85	0.73	28.07	100	143	Peak
236.01	20.87	-25.13	46	35.85	11.96	1.23	28.17	-	-	Peak
273.54	28.07	-17.93	46	41.53	13.38	1.33	28.17	-	-	Peak
550.6	25.64	-20.36	46	32.84	18.82	1.89	27.91	-	-	Peak
694.1	27.31	-18.69	46	31.59	21.21	2.22	27.71	-	-	Peak
932.8	31.48	-14.52	46	31.64	24.26	2.59	27.01	-	-	Peak
5755	93.85	-	-	86.72	32.61	7.05	32.53	107	7	Average
5755	102.26	-	-	95.13	32.61	7.05	32.53	107	7	Peak
11511	45.85	-28.15	74	28.66	40.18	11.53	34.52	100	0	Peak



Test Mode :	5GHz 802.11n HT40	Temperature :	22~24°C
Test Channel :	151	Relative Humidity :	46~48%
Test Engineer :	Kyle Jhuang, Abi Lin and Derreck Chen	Polarization :	Vertical
Remark :	1. 5755 MHz is fundamental signal which can be ignored. 2. Average measurement was not performed if peak level went lower than the average limit.		

Frequency (MHz)	Level (dBμV/m)	Over Limit (dB)	Limit Line (dBμV/m)	Read Level (dBμV)	Antenna Factor (dB)	Cable Loss (dB)	Preamp Factor (dB)	Ant Pos (cm)	Table Pos (deg)	Remark
30	28.7	-11.3	40	42.68	13.6	0.41	27.99	110	263	Peak
69.69	27.98	-12.02	40	43.37	11.96	0.71	28.06	-	-	Peak
160.68	22.76	-20.74	43.5	36.25	13.67	0.99	28.15	-	-	Peak
451.2	22.78	-23.22	46	31.43	17.61	1.78	28.04	-	-	Peak
705.3	27.33	-18.67	46	31.42	21.38	2.22	27.69	-	-	Peak
957.3	31.76	-14.24	46	31.52	24.53	2.62	26.91	-	-	Peak
5755	94.05	-	-	86.92	32.61	7.05	32.53	101	322	Average
5755	101.17	-	-	94.04	32.61	7.05	32.53	101	322	Peak
11514	48.32	-25.68	74	31.14	40.17	11.53	34.52	100	0	Peak



Test Mode :	5GHz 802.11n HT40	Temperature :	22~24°C
Test Channel :	159	Relative Humidity :	46~48%
Test Engineer :	Kyle Jhuang, Abi Lin and Derreck Chen	Polarization :	Horizontal
Remark :	1. 5795 MHz is fundamental signal which can be ignored. 2. Average measurement was not performed if peak level went lower than the average limit.		

Frequency (MHz)	Level (dBμV/m)	Over Limit (dB)	Limit Line (dBμV/m)	Read Level (dBμV)	Antenna Factor (dB)	Cable Loss (dB)	Preamp Factor (dB)	Ant Pos (cm)	Table Pos (deg)	Remark
5795	90.75	-	-	83.57	32.65	7.08	32.55	102	60	Average
5795	101.17	-	-	93.99	32.65	7.08	32.55	102	60	Peak
11592	46.62	-27.38	74	29.58	40.02	11.54	34.52	100	0	Peak

Test Mode :	5GHz 802.11n HT40	Temperature :	22~24°C
Test Channel :	159	Relative Humidity :	46~48%
Test Engineer :	Kyle Jhuang, Abi Lin and Derreck Chen	Polarization :	Vertical
Remark :	1. 5795 MHz is fundamental signal which can be ignored. 2. Average measurement was not performed if peak level went lower than the average limit.		

Frequency (MHz)	Level (dBμV/m)	Over Limit (dB)	Limit Line (dBμV/m)	Read Level (dBμV)	Antenna Factor (dB)	Cable Loss (dB)	Preamp Factor (dB)	Ant Pos (cm)	Table Pos (deg)	Remark
5795	91.09	-	-	83.91	32.65	7.08	32.55	101	322	Average
5795	99.49	-	-	92.31	32.65	7.08	32.55	101	322	Peak
11592	44.76	-29.24	74	27.72	40.02	11.54	34.52	100	0	Peak



Test Mode :	802.11n Tx CH11 with WPC Charging Mode	Temperature :	22~24°C
Test Engineer :	Kyle Jhuang, Abi Lin and Derreck Chen	Relative Humidity :	46~48%
Polarization :	Horizontal		
Remark :	1. 2460 MHz is fundamental signal which can be ignored. 2. Average measurement was not performed if peak level went lower than the average limit.		

Frequency (MHz)	Level (dBμV/m)	Over Limit (dB)	Limit Line (dBμV/m)	Read Level (dBμV)	Antenna Factor (dB)	Cable Loss (dB)	Preamp Factor (dB)	Ant Pos (cm)	Table Pos (deg)	Remark
97.5	29.48	-14.02	43.5	47.98	8.77	0.85	28.12	-	-	Peak
142.05	37.13	-6.37	43.5	50.7	13.56	1.01	28.14	100	41	Peak
189.3	33.7	-9.8	43.5	49.7	11.06	1.1	28.16	-	-	Peak
371.4	24.42	-21.58	46	35.33	15.67	1.55	28.13	-	-	Peak
486.2	25.45	-20.55	46	33.68	17.96	1.8	27.99	-	-	Peak
707.4	27.41	-18.59	46	31.45	21.42	2.22	27.68	-	-	Peak
2460	94.2	-	-	95.68	27.39	4.28	33.15	106	76	Average
2460	100.23	-	-	101.71	27.39	4.28	33.15	106	76	Peak
4923	41.6	-32.4	74	35.96	31.71	6.34	32.41	100	0	Peak
7386	48.63	-25.37	74	37.29	36.8	8.32	33.78	100	0	Peak



Test Mode :	802.11n Tx CH11 with WPC Charging Mode	Temperature :	22~24°C
Test Engineer :	Kyle Jhuang, Abi Lin and Derreck Chen	Relative Humidity :	46~48%
Polarization :	Vertical		
Remark :	1. 2460 MHz is fundamental signal which can be ignored. 2. Average measurement was not performed if peak level went lower than the average limit.		

Frequency (MHz)	Level (dBμV/m)	Over Limit (dB)	Limit Line (dBμV/m)	Read Level (dBμV)	Antenna Factor (dB)	Cable Loss (dB)	Preamp Factor (dB)	Ant Pos (cm)	Table Pos (deg)	Remark
46.47	33.38	-6.62	40	46.53	14.26	0.59	28	100	139	Peak
88.59	33.45	-10.05	43.5	52.48	8.31	0.76	28.1	-	-	Peak
172.29	36.04	-7.46	43.5	50.26	12.9	1.03	28.15	-	-	Peak
479.9	27.83	-18.17	46	36.13	17.9	1.8	28	-	-	Peak
734	27.34	-18.66	46	30.9	21.84	2.23	27.63	-	-	Peak
957.3	34.74	-11.26	46	34.5	24.53	2.62	26.91	-	-	Peak
2460	87.05	-	-	88.53	27.39	4.28	33.15	112	110	Average
2460	93.5	-	-	94.99	27.38	4.28	33.15	112	110	Peak
4923	41.07	-32.93	74	35.43	31.71	6.34	32.41	100	0	Peak
7386	46.1	-27.9	74	34.76	36.8	8.32	33.78	100	0	Peak



3.6 AC Conducted Emission Measurement

3.6.1 Limit of AC Conducted Emission

For equipment that is designed to be connected to the public utility (AC) power line, the radio frequency voltage that is conducted back onto the AC power line on any frequency or frequencies within the band 150 kHz to 30 MHz shall not exceed the limits in the following table.

Frequency of Emission (MHz)	Conducted Limit (dB μ V)	
	Quasi-Peak	Average
0.15-0.5	66 to 56*	56 to 46*
0.5-5	56	46
5-30	60	50

*Decreases with the logarithm of the frequency.

3.6.2 Measuring Instruments

The measuring equipment is listed in the section 4 of this test report.

3.6.3 Test Procedures

1. The EUT was placed 0.4 meter from the conducting wall of the shielding room, and it was kept at least 80 centimeters from any other grounded conducting surface.
2. Connect EUT to the power mains through a line impedance stabilization network (LISN).
3. All the support units are connecting to the other LISN.
4. The LISN provides 50 ohm coupling impedance for the measuring instrument.
5. The FCC states that a 50 ohm, 50 microhenry LISN should be used.
6. Both sides of AC line were checked for maximum conducted interference.
7. The frequency range from 150 kHz to 30 MHz was searched.
8. Set the test-receiver system to Peak Detect Function and specified bandwidth (IF bandwidth = 9kHz) with Maximum Hold Mode.

3.6.4 Test Setup

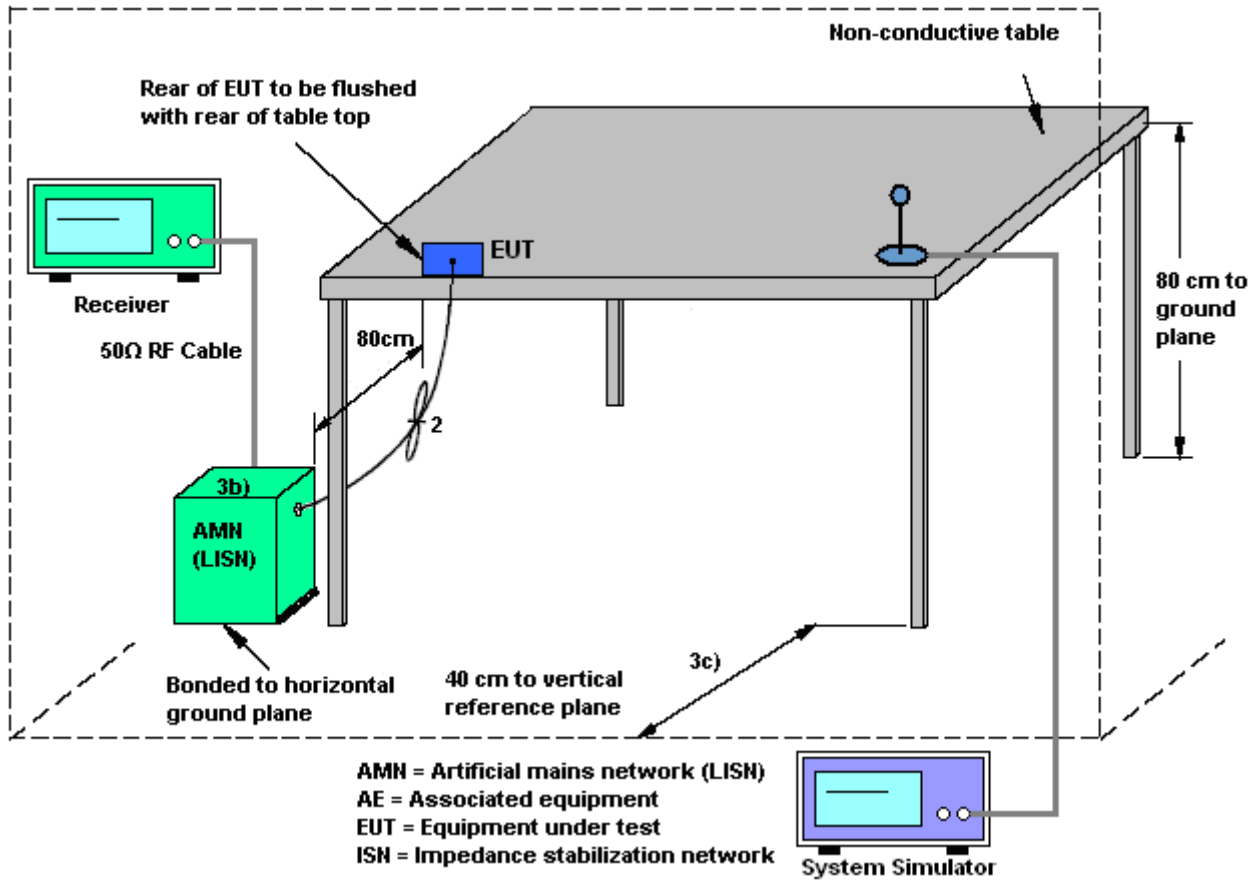



3.6.5 Test Result of AC Conducted Emission

Test Mode :	Mode 1	Temperature :	20~22°C
Test Engineer :	Cosmo Xu	Relative Humidity :	45~47%
Test Voltage :	120Vac / 60Hz	Phase :	Line
Function Type :	GSM1900 Idle + WLAN Link + Bluetooth Link + Earphone + USB Cable (Data Link with Notebook) + GPS Rx + Battery		

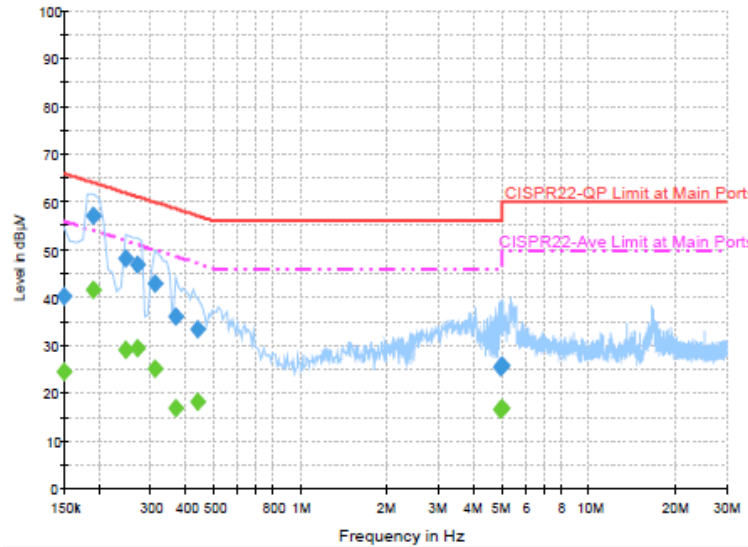

Final Result : Quasi-Peak

Frequency (MHz)	Quasi-Peak (dBµV)	Filter	Line	Corr. (dB)	Margin (dB)	Limit (dBµV)
0.150000	40.2	Off	L1	19.3	25.8	66.0
0.190000	57.2	Off	L1	19.3	6.8	64.0
0.246000	48.1	Off	L1	19.4	13.8	61.9
0.270000	46.9	Off	L1	19.4	14.2	61.1
0.310000	42.9	Off	L1	19.4	17.1	60.0
0.366000	36.1	Off	L1	19.4	22.5	58.6
0.438000	33.4	Off	L1	19.4	23.7	57.1
4.886000	25.4	Off	L1	19.6	30.6	56.0
4.950000	25.9	Off	L1	19.6	30.1	56.0

Final Result : Average

Frequency (MHz)	Average (dBµV)	Filter	Line	Corr. (dB)	Margin (dB)	Limit (dBµV)
0.150000	24.3	Off	L1	19.3	31.7	56.0
0.190000	41.6	Off	L1	19.3	12.4	54.0
0.246000	29.0	Off	L1	19.4	22.9	51.9
0.270000	29.4	Off	L1	19.4	21.7	51.1
0.310000	25.2	Off	L1	19.4	24.8	50.0
0.366000	16.7	Off	L1	19.4	31.9	48.6
0.438000	18.3	Off	L1	19.4	28.8	47.1
4.886000	16.7	Off	L1	19.6	29.3	46.0
4.950000	16.7	Off	L1	19.6	29.3	46.0



Test Mode :	Mode 1	Temperature :	20~22
Test Engineer :	Cosmo Xu	Relative Humidity :	45~47
Test Voltage :	120Vac / 60Hz	Phase :	Neutral
Function Type :	GSM1900 Idle + WLAN Link + Bluetooth Link + Earphone + USB Cable (Data Link with Notebook) + GPS Rx + Battery		

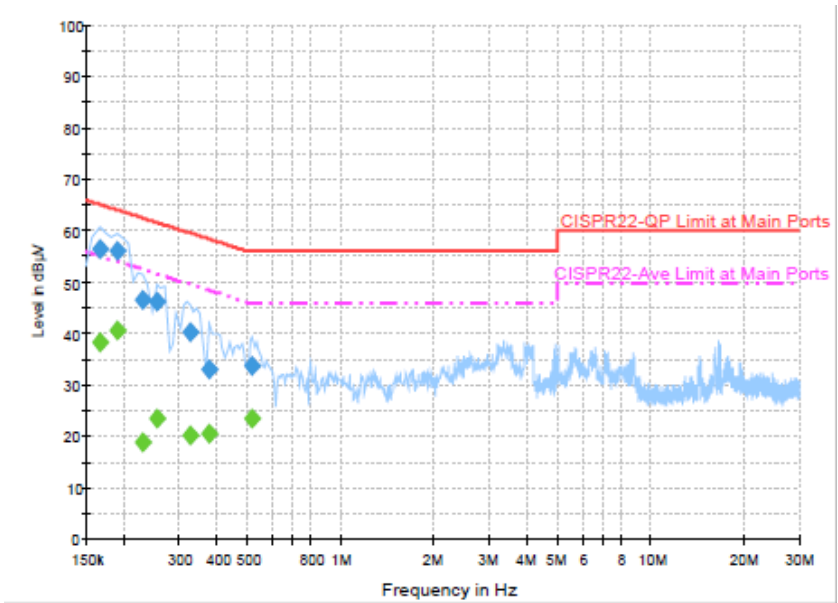

Final Result : Quasi-Peak

Frequency (MHz)	Quasi-Peak (dBµV)	Filter	Line	Corr. (dB)	Margin (dB)	Limit (dBµV)
0.166000	56.5	Off	N	19.3	8.7	65.2
0.190000	56.2	Off	N	19.3	7.8	64.0
0.230000	46.6	Off	N	19.4	15.8	62.4
0.254000	46.1	Off	N	19.4	15.5	61.6
0.326000	40.2	Off	N	19.4	19.4	59.6
0.374000	33.0	Off	N	19.4	25.4	58.4
0.518000	33.6	Off	N	19.4	22.4	56.0

Final Result : Average

Frequency (MHz)	Average (dBµV)	Filter	Line	Corr. (dB)	Margin (dB)	Limit (dBµV)
0.166000	38.4	Off	N	19.3	16.8	55.2
0.190000	40.6	Off	N	19.3	13.4	54.0
0.230000	18.9	Off	N	19.4	33.5	52.4
0.254000	23.4	Off	N	19.4	28.2	51.6
0.326000	20.2	Off	N	19.4	29.4	49.6
0.374000	20.5	Off	N	19.4	27.9	48.4
0.518000	23.4	Off	N	19.4	22.6	46.0



3.7 Antenna Requirements

3.7.1 Standard Applicable

If directional gain of transmitting antennas is greater than 6dBi, the power shall be reduced by the same level in dB comparing to gain minus 6dBi. For the fixed point-to-point operation, the power shall be reduced by one dB for every 3 dB that the directional gain of the antenna exceeds 6 dBi. The use of a permanently attached antenna or of an antenna that uses a unique coupling to the intentional radiator shall be considered sufficient to comply with the FCC rule.

3.7.2 Antenna Anti-Replacement Construction

An embedded-in antenna design is used.

3.7.3 Antenna Gain

The antenna peak gain of EUT is less than 6 dBi. Therefore, it is not necessary to reduce maximum peak output power limit.



4 List of Measuring Equipment

Instrument	Manufacturer	Model No.	Serial No.	Characteristics	Calibration Date	Test Date	Due Date	Remark
Spectrum Analyzer	Rohde & Schwarz	FSP40	100055	9kHz~40GHz	Jun. 09, 2014	Jul.18, 2014~ Aug. 06, 2014	Jun. 08, 2015	Conducted (TH02-HY)
Power Meter	Anritsu	ML2495A	1036004	300MHz~40GHz	Aug. 17, 2013	Jul.18, 2014~ Aug. 06, 2014	Aug. 16, 2014	Conducted (TH02-HY)
Power Sensor	Anritsu	MA2411B	1027253	300MHz~40GHz	Aug. 17, 2013	Jul.18, 2014~ Aug. 06, 2014	Aug. 16, 2014	Conducted (TH02-HY)
EMI Test Receiver	Rohde & Schwarz	ESCI 7	100724	9 kHz~7 GHz	Sep. 06, 2013	Jul. 19, 2014~ Jul. 26, 2014	Sep. 05, 2014	Radiation (03CH07-HY)
Spectrum Analyzer	Rohde & Schwarz	FSV30	101749	10Hz ~ 30GHz	Feb. 10, 2014	Jul. 19, 2014~ Jul. 26, 2014	Feb. 09, 2015	Radiation (03CH07-HY)
Loop Antenna	TESEQ	HLA 6120	31244	9 kHz~30 MhZ	Dec. 02, 2012	Jul. 19, 2014~ Jul. 26, 2014	Dec. 03, 2014	Radiation (03CH07-HY)
Bilog Antenna	Schaffner	CBL6111C	2726	30 MHz ~ 1 GHz	Oct. 10, 2013	Jul. 19, 2014~ Jul. 26, 2014	Oct. 09, 2014	Radiation (03CH07-HY)
Double Ridge Horn Antenna	ESCO	3117	75962	1 GHz~18 GHz	Aug. 22, 2013	Jul. 19, 2014~ Jul. 26, 2014	Aug. 21, 2014	Radiation (03CH07-HY)
SHF-EHF Horn Antenna	SCHWARZBECK	BBHA 9170	BBHA9170 251	15 GHz- 40 GHz	Oct. 03, 2013	Jul. 19, 2014~ Jul. 26, 2014	Oct. 02, 2014	Radiation (03CH07-HY)
Preamplifier	COM-POWER	PA-103A	161241	10 MHz ~ 1 GHz	Mar. 17, 2014	Jul. 19, 2014~ Jul. 26, 2014	Mar. 16, 2015	Radiation (03CH07-HY)
Preamplifier	Agilent	8449B	3008A023 62	1 GHz~26.5 GHz	Nov. 29, 2013	Jul. 19, 2014~ Jul. 26, 2014	Nov. 28, 2014	Radiation (03CH07-HY)
Preamplifier	MITEQ	AMF-7D-0010 1800-30-10P	1865802	18GHz ~ 40GHz	Jun. 09, 2014	Jul. 19, 2014~ Jul. 26, 2014	Jun. 08, 2015	Radiation (03CH07-HY)
Preamplifier	MITEQ	AMF-7D-0010 1800-30-10P	159075	1 GHz ~18 GHz	Apr. 21, 2014	Jul. 19, 2014~ Jul. 26, 2014	Apr. 20, 2015	Radiation (03CH07-HY)
Turn Table	ChainTek	ChainTek 3000	N/A	0 ~ 360 degree	N/A	Jul. 19, 2014~ Jul. 26, 2014	N/A	Radiation (03CH07-HY)
Antenna Mast	ChainTek	ChainTek 3000	N/A	N/A	N/A	Jul. 19, 2014~ Jul. 26, 2014	N/A	Radiation (03CH07-HY)
EMI Test Receiver	Rohde & Schwarz	ESCS 30	100356	9kHz ~ 2.75GHz	Nov. 15, 2013	Jul. 31, 2014	Nov. 14, 2014	Conduction (CO05-HY)
LISN (for auxiliary equipment)	Rohde & Schwarz	ENV216	100081	9kHz ~ 30MHz	Dec. 12, 2013	Jul. 31, 2014	Dec. 11, 2014	Conduction (CO05-HY)
LISN	Rohde & Schwarz	ENV216	100080	9kHz ~ 30MHz	Dec. 04, 2013	Jul. 31, 2014	Dec. 03, 2014	Conduction (CO05-HY)
AC Power Source	ChainTek	APC-1000W	N/A	N/A	N/A	Jul. 31, 2014	N/A	Conduction (CO05-HY)



5 Uncertainty of Evaluation

Uncertainty of Conducted Emission Measurement (150kHz ~ 30MHz)

Measuring Uncertainty for a Level of Confidence of 95% ($U = 2Uc(y)$)	2.26
---	------

Uncertainty of Radiated Emission Measurement (30 MHz ~ 1000 MHz)

Measuring Uncertainty for a Level of Confidence of 95% ($U = 2Uc(y)$)	4.50
---	------



Appendix A. Photographs of EUT

Please refer to Sporton report number EPxxxxxx as below.