



FCC RF Test Report

APPLICANT : Bullitt Group
EQUIPMENT : Rugged Smart Phone
BRAND NAME : CAT
MODEL NAME : S50
FCC ID : ZL5S50
STANDARD : FCC Part 15 Subpart E §15.407
CLASSIFICATION : (NII) Unlicensed National Information Infrastructure

The product was received on Jun. 30, 2014 and testing was completed on Aug. 06, 2014. We, SPORTON INTERNATIONAL INC., would like to declare that the tested sample has been evaluated in accordance with the test procedures and has been in compliance with the applicable technical standards.

The test results in this report apply exclusively to the tested model / sample. Without written approval of SPORTON INTERNATIONAL INC., the test report shall not be reproduced except in full.

Reviewed by: Joseph Lin / Supervisor

Approved by: Jones Tsai / Manager



SPORTON INTERNATIONAL INC.

No. 52, Hwa Ya 1st Rd., Hwa Ya Technology Park, Kwei-Shan Hsiang, Tao Yuan Hsien, Taiwan, R.O.C.



TABLE OF CONTENTS

REVISION HISTORY.....3

SUMMARY OF TEST RESULT4

1 GENERAL DESCRIPTION5

 1.1 Applicant5

 1.2 Manufacturer.....5

 1.3 Feature of Equipment Under Test5

 1.4 Product Specification of Equipment Under Test.....6

 1.5 Modification of EUT6

 1.6 Testing Location7

 1.7 Applicable Standards.....7

2 TEST CONFIGURATION OF EQUIPMENT UNDER TEST8

 2.1 Carrier Frequency Channel9

 2.2 Pre-Scanned RF Power.....10

 2.3 Test Mode.....11

 2.4 Connection Diagram of Test System.....13

 2.5 Support Unit used in test configuration and system14

 2.6 EUT Operation Test Setup15

 2.7 Measurement Results Explanation Example.....15

3 TEST RESULT.....16

 3.1 26dB & 99% Occupied Bandwidth Measurement16

 3.2 Maximum Conducted Output Power Measurement24

 3.3 Power Spectral Density Measurement29

 3.4 Peak Excursion Ratio Measurement33

 3.5 Unwanted Radiated Emission Measurement35

 3.6 AC Conducted Emission Measurement.....90

 3.7 Frequency Stability Measurement.....96

 3.8 Automatically Discontinue Transmission98

 3.9 Antenna Requirements.....99

4 LIST OF MEASURING EQUIPMENTS100

5 UNCERTAINTY OF EVALUATION101

APPENDIX A. SETUP PHOTOGRAPHS

**SUMMARY OF TEST RESULT**

Report Section	FCC Rule	IC Rule	Description	Limit	Result	Remark
3.1	2.1049 15.403(i)	RSS-210 A9.2	26dB & 99% Bandwidth	-	Pass	-
3.2	15.407(a)	RSS-210 A9.2	Maximum Conducted Output Power	≤ 17, 24, 30 dBm (depend on band)	Pass	-
3.3	15.407(a)	RSS-210 A9.2	Power Spectral Density	≤ 4, 11, 17 dBm (depend on band)	Pass	-
3.4	15.407(a)(6)	RSS-210 A9.3	Peak Excursion Ratio	≤ 13dB	Pass	-
3.5	15.407(b)	RSS-210 A9.3	Unwanted Emissions	≤ -17, -27 dBm (depend on band)&15.209(a)	Pass	Under limit 1.01 dB at 5350.990 MHz
3.6	15.207	RSS-Gen 7.2.4	AC Conducted Emission	15.207(a)	Pass	Under limit 7.40 dB at 0.150 MHz
3.7	15.407(g)	-	Frequency Stability	Within Operation Band	Pass	-
3.8	15.407(c)	RSS-210 A9.4	Automatically Discontinue Transmission	Discontinue Transmission	Pass	-
3.9	15.203 & 15.407(a)	RSS-210 A9.2	Antenna Requirement	N/A	Pass	-



1 General Description

1.1 Applicant

Bullitt Group

No. 4, The Aquarium, King Street, Reading, RG1 2AN United Kingdom

1.2 Manufacturer

Compal Electronics, INC.

No. 385, Yangguang St. Neihu District, Taipei City 11491, Taiwan, R.O.C

1.3 Feature of Equipment Under Test

Product Feature	
Equipment	Rugged Smart Phone
Brand Name	CAT
Model Name	S50
FCC ID	ZL5S50
EUT supports Radios application	GSM/EGPRS/WCDMA/HSPA/LTE/NFC WLAN 11b/g/n HT20 WLAN 11a/n HT20/HT40 Bluetooth v4.0 EDR/LE
HW Version	DVT1
SW Version	LTE_S0201121.0_S50_0.006.00
EUT Stage	Identical Prototype

Remark: The above EUT's information was declared by manufacturer. Please refer to the specifications or user's manual for more detailed description.



1.4 Product Specification of Equipment Under Test

Product Specification subjective to this standard	
Tx/Rx Frequency Range	5180 MHz ~ 5240 MHz 5260 MHz ~ 5320 MHz 5500 MHz ~ 5580 MHz 5660 MHz ~ 5700 MHz
Maximum Output Power to Antenna	<5180 MHz ~ 5240 MHz> 802.11a : 9.81 dBm / 0.0096 W 802.11n HT20 : 9.88 dBm / 0.0097 W 802.11n HT40 : 9.94 dBm / 0.0099 W <5260 MHz ~ 5320 MHz> 802.11a : 9.76 dBm / 0.0095 W 802.11n HT20 : 9.93 dBm / 0.0098 W 802.11n HT40 : 9.91 dBm / 0.0098 W <5500 MHz ~ 5580 MHz and 5660 MHz ~ 5700 MHz > 802.11a : 9.31 dBm / 0.0085 W 802.11n HT20 : 9.60 dBm / 0.0091 W 802.11n HT40 : 9.52 dBm / 0.0090 W
99% Occupied Bandwidth	802.11a : 18.20 MHz 802.11n HT20 : 19.10 MHz 802.11n HT40 : 36.70 MHz
Antenna Type & Antenna Gain	<5180 MHz ~ 5240 MHz> PIFA Antenna with gain 1.16 dBi <5260 MHz ~ 5320 MHz> PIFA Antenna with gain 0.25 dBi <5500 MHz ~ 5580 MHz and 5660 MHz ~ 5700 MHz> PIFA Antenna with gain 0.74 dBi
Type of Modulation	OFDM (BPSK / QPSK / 16QAM / 64QAM)

1.5 Modification of EUT

No modifications are made to the EUT during all test items.



1.6 Testing Location

Sporton Lab is accredited to ISO 17025 by Taiwan Accreditation Foundation (TAF code : 1190) and the FCC designation No. TW1022 under the FCC 2.948(e) by Mutual Recognition Agreement (MRA) in FCC Test.

Test Site	SPORTON INTERNATIONAL INC.		
Test Site Location	No. 52, Hwa Ya 1 st Rd., Hwa Ya Technology Park, Kwei-Shan Hsiang, Tao Yuan Hsien, Taiwan, R.O.C. TEL: +886-3-3273456 / FAX: +886-3-3284978		
Test Site No.	Sporton Site No.		
	TH02-HY	CO05-HY	03CH07-HY

1.7 Applicable Standards

According to the specifications of the manufacturer, the EUT must comply with the requirements of the following standards:

- FCC Part 15 Subpart E
- FCC KDB 789033 D01 General UNII Test Procedures Old Rules v01r04
- ANSI C63.4-2003

Remark:

1. All test items were verified and recorded according to the standards and without any deviation during the test.
2. This EUT has also been tested and complied with the requirements of FCC Part 15, Subpart B, recorded in a separate test report.



2 Test Configuration of Equipment Under Test

The EUT has been associated with peripherals and configuration operated in a manner tended to maximize its emission characteristics in a typical application. Frequency range investigated: conducted emission (150 kHz to 30 MHz) and radiated emission (9 kHz to the 10th harmonic of the highest fundamental frequency or to 40 GHz, whichever is lower). For radiated measurement, pre-scanned in three orthogonal panels, X, Y, Z. The worst cases (Y plane) were recorded in this report.

The final configuration from all the combinations and the worst-case data rates were investigated by measuring the maximum power across all the data rates and modulation modes under section 2.2.

Based on the worst configuration found above, the RF power setting is set individually to meet FCC compliance limit for the final conducted and radiated tests shown in section 2.3.



2.1 Carrier Frequency Channel

Frequency Band	Channel	Freq. (MHz)	Channel	Freq. (MHz)
5150-5250 MHz Band 1 (U-NII-1)	36	5180	44	5220
	38	5190	46	5230
	40	5200	48	5240

Frequency Band	Channel	Freq. (MHz)	Channel	Freq. (MHz)
5250-5350 MHz Band 2 (U-NII-2A)	52	5260	60	5300
	54	5270	62	5310
	56	5280	64	5320

Frequency Band	Channel	Freq. (MHz)	Channel	Freq. (MHz)
5470-5600 MHz and 5650-5725 MHz Band 3 (U-NII-2C)	100	5500	116	5580
	102	5510	132	5660
	104	5520	134	5670
	108	5540	136	5680
	110	5550	140	5700
	112	5560		

Note: The above Frequency and Channel in boldface were 802.11n HT40.



2.2 Pre-Scanned RF Power

Preliminary tests were performed in different data rate and data rate associated with the highest power were chosen for full test in the following tables.

5GHz 802.11a mode								
Data Rate (MHz)	6M bps	9M bps	12M bps	18M bps	24M bps	36M bps	48M bps	54M bps
<5180 MHz ~ 5240 MHz> Average Power (dBm)	9.81	9.68	9.63	9.79	9.68	9.62	9.52	9.56
<5260 MHz ~ 5320 MHz> Average Power (dBm)	9.76	9.71	9.69	9.66	9.73	9.61	9.60	9.68
<5500 MHz ~ 5580 MHz and 5660 MHz ~ 5700 MHz > Average Power (dBm)	9.31	9.15	9.26	9.19	9.28	9.14	9.12	9.27

5GHz 802.11n HT20 mode								
Data Rate (MHz)	MCS0	MCS1	MCS2	MCS3	MCS4	MCS5	MCS6	MCS7
<5180 MHz ~ 5240 MHz> Average Power (dBm)	9.88	9.80	9.82	9.78	9.80	9.78	9.81	9.67
<5260 MHz ~ 5320 MHz> Average Power (dBm)	9.93	9.89	9.90	9.92	9.84	9.71	9.83	9.80
<5500 MHz ~ 5580 MHz and 5660 MHz ~ 5700 MHz > Average Power (dBm)	9.60	9.58	9.55	9.45	9.47	9.49	9.56	9.53

5GHz 802.11n HT40 mode								
Data Rate (MHz)	MCS0	MCS1	MCS2	MCS3	MCS4	MCS5	MCS6	MCS7
<5180 MHz ~ 5240 MHz> Average Power (dBm)	9.94	9.87	9.88	9.87	9.87	9.70	9.74	9.83
<5260 MHz ~ 5320 MHz> Average Power (dBm)	9.91	9.69	9.81	9.81	9.82	9.76	9.83	9.85
<5500 MHz ~ 5580 MHz and 5660 MHz ~ 5700 MHz > Average Power (dBm)	9.52	9.39	9.48	9.38	9.47	9.31	9.37	9.46



2.3 Test Mode

Final results of test modes, data rates and test channels are shown as following table.

Test Cases				
	Test Items	Mode	Data rate	Test Channel
Conducted TCs	26dB and 99% BW Power Spectral Density	802.11a	6 Mbps	L/M/H
		802.11n HT20	MCS 0	L/M/H
		802.11n HT40	MCS 0	L/M/H
	Output Power	802.11a	6 Mbps	L/M/H
		802.11n HT20	MCS 0	L/M/H
		802.11n HT40	MCS 0	L/M/H
	Peak Excursion	802.11a	6 Mbps	L/M/H
		802.11n HT20	MCS 0	L/M/H
		802.11n HT40	MCS 0	L/M/H
	Frequency Stability	802.11a	6 Mbps	L/M/H
		802.11n HT20	MCS 0	L/M/H
		802.11n HT40	MCS 0	L/M/H
Radiated TCs	Radiated Band Edge	802.11a	6 Mbps	L/H
		802.11n HT20	MCS 0	L/H
		802.11n HT40	MCS 0	L/H
	Radiated Spurious Emission	802.11a	6 Mbps	L/M/H
		802.11n HT20	MCS 0	L/M/H
		802.11n HT40	MCS 0	L/M/H
AC Conducted Emission	Mode 1 : GSM1900 Idle + WLAN(5GHz) Link + Bluetooth Link + Earphone + USB Cable (Data Link with Notebook) + GPS Rx + Battery			



Ch. #		Band I : 5150-5250 MHz	Band II : 5250-5350 MHz	Band III : 5470-5600 MHz and 5650-5725MHz
		802.11a	802.11a	802.11a
L	Low	36	52	100
M	Middle	44	60	116
H	High	48	64	140

Ch. #		Band I : 5150-5250 MHz	Band II : 5250-5350 MHz	Band III : 5470-5600 MHz and 5650-5725MHz
		802.11n HT20	802.11n HT20	802.11n HT20
L	Low	36	52	100
M	Middle	44	60	116
H	High	48	64	140

Ch. #		Band I : 5150-5250 MHz	Band II : 5250-5350 MHz	Band III : 5470-5600 MHz and 5650-5725MHz
		802.11n HT40	802.11n HT40	802.11n HT40
L	Low	38	54	102
M	Middle	-	-	110
H	High	46	62	134

2.4 Connection Diagram of Test System

<WLAN Tx Mode>

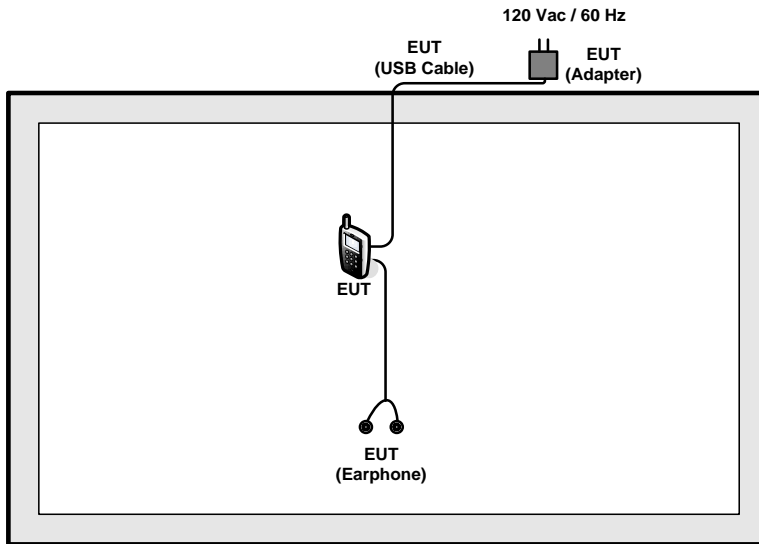

< WLAN Tx Mode with WPC Charging >

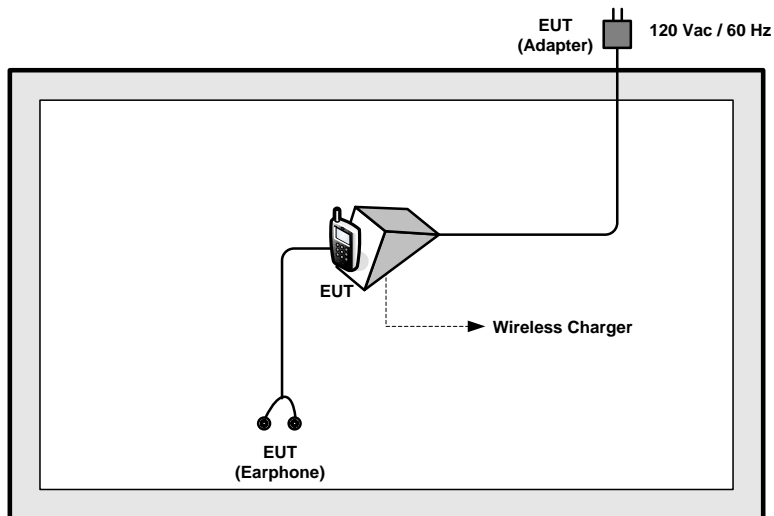

<AC Conducted Emission Mode>

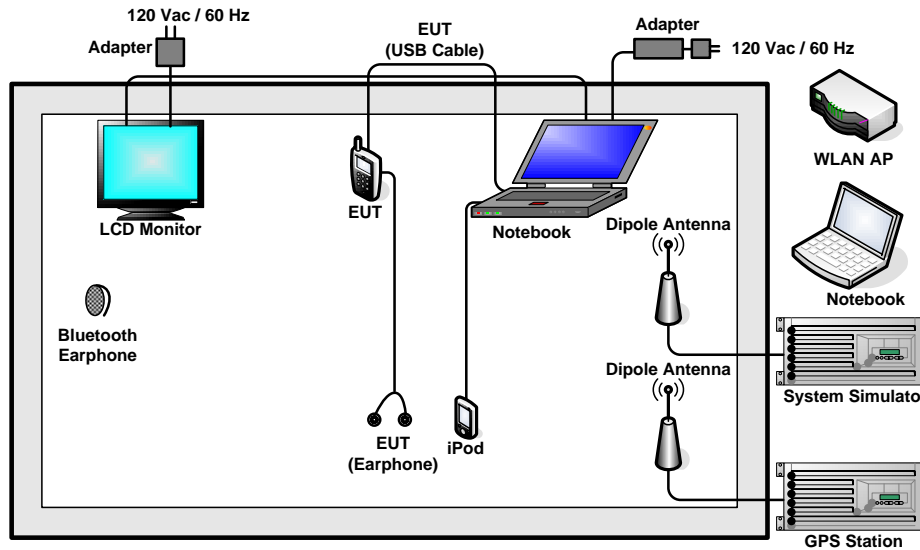

2.5 Support Unit used in test configuration and system

Item	Equipment	Trade Name	Model Name	FCC ID	Data Cable	Power Cord
1.	System Simulator	R&S	CMU 200	N/A	N/A	Unshielded, 1.8 m
2.	GPS Station	Pendulum	GSG-54	N/A	N/A	Unshielded, 1.8 m
3.	Bluetooth Earphone	Sony Ericsson	MW600	PY7DDA-2029	N/A	N/A
4.	WLAN AP	D-Link	DIR-628	KA2DIR628A2	N/A	Unshielded, 1.8 m
5.	Notebook	DELL	Latitude E6320	FCC DoC/ Contains FCC ID: QDS-BRCM1054	N/A	AC I/P: Unshielded, 1.2 m DC O/P: Shielded, 1.8 m
6.	iPod	Apple	A1285	FCC DoC	Shielded, 1.0 m	N/A
7.	LCD Monitor	DELL	U2410	FCC DoC	Shielded, 1.6 m	Unshielded, 1.8 m
8.	SD Card	SanDisk	MicroSD HC	FCC DoC	N/A	N/A



2.6 EUT Operation Test Setup

For WLAN function, programmed RF utility, “QRCT” installed in the notebook make the EUT provide functions like channel selection and power level for continuous transmitting and receiving signals.

2.7 Measurement Results Explanation Example

For all conducted test items:

The offset level is set in the spectrum analyzer to compensate the RF cable loss and attenuator factor between EUT conducted output port and spectrum analyzer. With the offset compensation, the spectrum analyzer reading level is exactly the EUT RF output level.

Example :

The spectrum analyzer offset is derived from RF cable loss and attenuator factor.

Offset = RF cable loss + attenuator factor.

Following shows an offset computation example with cable loss 4.2 dB and 10dB attenuator.

$$\begin{aligned} \text{Offset(dB)} &= \text{RF cable loss(dB)} + \text{attenuator factor(dB)}. \\ &= 4.2 + 10 = 14.2 \text{ (dB)} \end{aligned}$$

3 Test Result

3.1 26dB & 99% Occupied Bandwidth Measurement

3.1.1 Description of 26dB & 99% Occupied Bandwidth

There is no restriction limits for bandwidth. The maximum conducted output power can be limited by measured emission bandwidth (B).

For the band 5150-5250 MHz, the maximum conducted output power over the frequency band of operation shall not exceed the lesser of 50 mW (17dBm) or 4 dBm + 10log B.

For the bands 5250-5350 MHz and 5470-5600 MHz and 5650-5725MHz, the maximum conducted output power over the frequency bands of operation shall not exceed the lesser of 250 mW (24dBm) or 11 dBm + 10log B.

3.1.2 Measuring Instruments

The measuring equipment is listed in the section 4 of this test report.

3.1.3 Test Procedures

1. The testing follows FCC KDB 789033 D01 General UNII Test Procedures Old Rules v01r04. Section D) Emission bandwidth
2. Set RBW = approximately 1% of the emission bandwidth.
3. Set the VBW > RBW.
4. Detector = Peak.
5. Trace mode = max hold
6. Measure the maximum width of the emission that is 26 dB down from the peak of the emission. Compare this with the RBW setting of the analyzer. Readjust RBW and repeat measurement as needed until the RBW/EBW ratio is approximately 1%.
7. For 99% Bandwidth Measurement, the spectrum analyzer's resolution bandwidth (RBW) is set 1MHz and set the Video bandwidth (VBW) $\geq 3 * RBW$.
8. Measure and record the results in the test report.

3.1.4 Test Setup

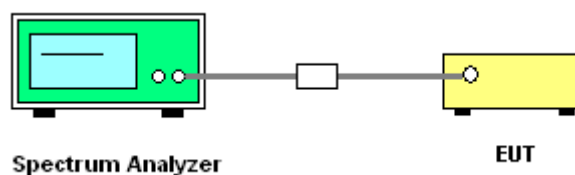



3.1.5 Test Result of 26dB & 99% Occupied Bandwidth Plots

Test Band :	5GHz band 1	Temperature :	21~26°C
Test Engineer :	Osolemio Chang and Alen Tsui	Relative Humidity :	45~54%

Mod.	Data Rate	N _{TX}	Channel	Freq. (MHz)	99% Bandwidth (MHz)	26dB Bandwidth (MHz)	IC 99% Bandwidth EIRP Limit (dBm)	FCC 26dB Bandwidth Power Limit (dBm)
11a	6Mbps	1	36	5180	18.20	23.95	22.60	16.99
11a	6Mbps	1	44	5220	18.10	23.85	22.58	16.99
11a	6Mbps	1	48	5240	18.10	23.75	22.58	16.99
HT20	MCS0	1	36	5180	18.90	23.90	22.76	16.99
HT20	MCS0	1	44	5220	18.90	24.05	22.76	16.99
HT20	MCS0	1	48	5240	18.90	24.10	22.76	16.99
HT40	MCS0	1	38	5190	36.50	45.72	23.01	16.99
HT40	MCS0	1	46	5230	36.70	45.81	23.01	16.99

Test Band :	5GHz band 2	Temperature :	21~26°C
Test Engineer :	Osolemio Chang and Alen Tsui	Relative Humidity :	45~54%

Mod.	Data Rate	N _{TX}	Channel	Freq. (MHz)	99% Bandwidth (MHz)	26dB Bandwidth (MHz)	IC 99% Bandwidth EIRP Limit (dBm)	FCC 26dB Bandwidth Power Limit (dBm)
11a	6Mbps	1	52	5260	18.2	23.6	29.60	23.98
11a	6Mbps	1	60	5300	18.2	23.75	29.60	23.98
11a	6Mbps	1	64	5320	18.1	23.9	29.58	23.98
HT20	MCS0	1	52	5260	18.9	24.1	29.76	23.98
HT20	MCS0	1	60	5300	19.1	24.15	29.81	23.98
HT20	MCS0	1	64	5320	18.95	24.3	29.78	23.98
HT40	MCS0	1	54	5270	36.5	45.45	30.00	23.98
HT40	MCS0	1	62	5310	36.6	44.55	30.00	23.98



Test Band :	5GHz band 3	Temperature :	21~26°C
Test Engineer :	Osolemio Chang and Alen Tsui	Relative Humidity :	45~54%

Mod.	Data Rate	N _{TX}	Channel	Freq. (MHz)	99% Bandwidth (MHz)	26dB Bandwidth (MHz)	IC 99% Bandwidth EIRP Limit (dBm)	FCC 26dB Bandwidth Power Limit (dBm)
11a	6Mbps	1	100	5500	18.1	23.85	29.58	23.98
11a	6Mbps	1	116	5580	18.15	24.2	29.59	23.98
11a	6Mbps	1	140	5700	18.1	23.9	29.58	23.98
HT20	MCS0	1	100	5500	19.05	23.85	29.80	23.98
HT20	MCS0	1	116	5580	18.95	24.2	29.78	23.98
HT20	MCS0	1	140	5700	19.1	24.15	29.81	23.98
HT40	MCS0	1	102	5510	36.5	45.09	30.00	23.98
HT40	MCS0	1	110	5550	36.5	45.36	30.00	23.98
HT40	MCS0	1	134	5670	36.6	45.36	30.00	23.98

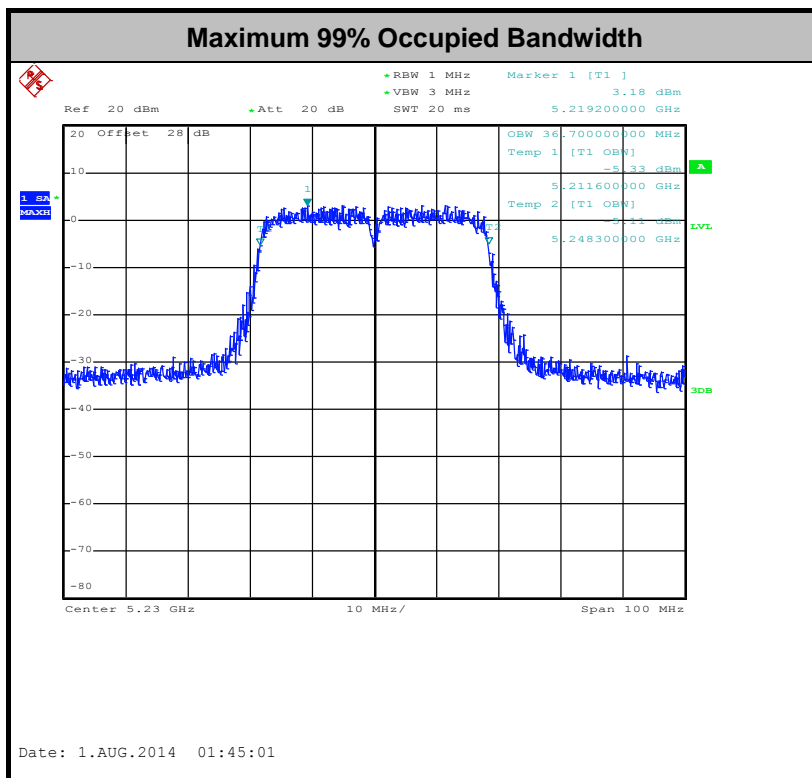
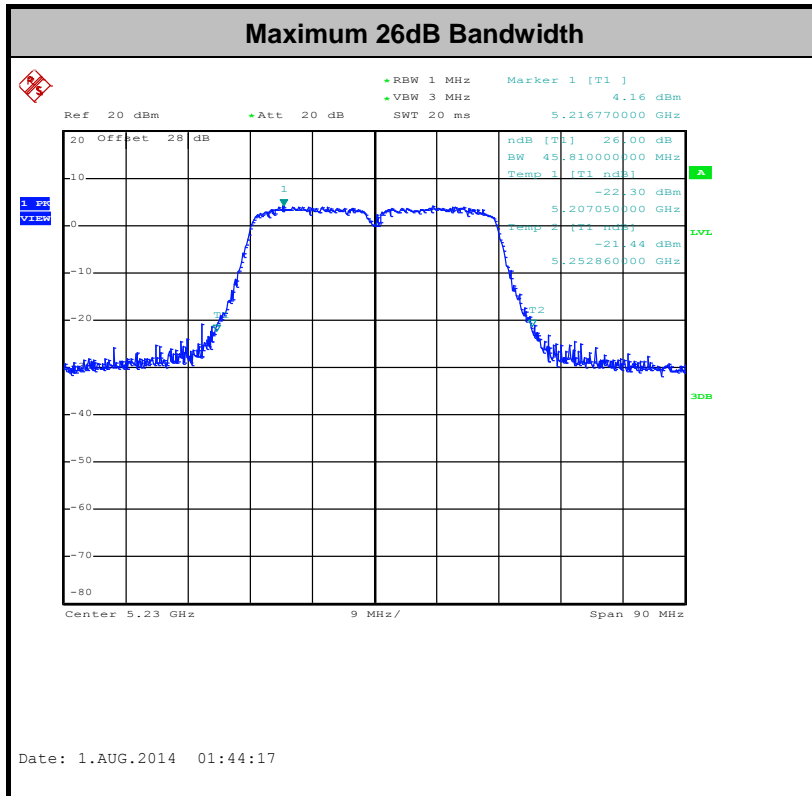



3.1.6 Test Result of 20dB Occupied Bandwidth

Test Band :	5GHz band 1	Temperature :	21~26°C
Test Engineer :	Osolemio Chang and Alen Tsui	Relative Humidity :	45~54%

Mod.	Data Rate	N _{TX}	Channel	Freq. (MHz)	20dB Bandwidth (MHz)	20dB Bandwidth Upper Frequency (FH) (MHz)	Upper Limit Line (MHz)	Pass/Fail
11a	6Mbps	1	48	5240	19.75	5249.85	5250	Pass
HT20	MCS0	1	48	5240	19.75	5249.95		Pass
HT40	MCS0	1	46	5230	38.79	5249.44		Pass

Test Band :	5GHz band 2	Temperature :	21~26°C
Test Engineer :	Osolemio Chang and Alen Tsui	Relative Humidity :	45~54%

Mod.	Data Rate	N _{TX}	Channel	Freq. (MHz)	20dB Bandwidth (MHz)	20dB Bandwidth Lower Frequency (FL) (MHz)	Low Limit Line (MHz)	Pass/Fail
11a	6Mbps	1	52	5260	20.05	5250.05	5250	Pass
HT20	MCS0	1	52	5260	19.95	5250.05		Pass
HT40	MCS0	1	54	5270	38.97	5250.47		Pass

Test Band :	5GHz band 3	Temperature :	21~26°C
Test Engineer :	Osolemio Chang and Alen Tsui	Relative Humidity :	45~54%

Mod.	Data Rate	N _{TX}	Channel	Freq. (MHz)	20dB Bandwidth (MHz)	20dB Bandwidth Lower Frequency (FL) (MHz)	Low Limit Line (MHz)	Pass/Fail
11a	6Mbps	1	132	5660	19.65	5650.05	5650	Pass
HT20	MCS0	1	132	5660	19.85	5650.05		Pass
HT40	MCS0	1	134	5670	39.24	5650.29		Pass



20dB Occupied Bandwidth

Band I

802.11a CH48 5240MHz

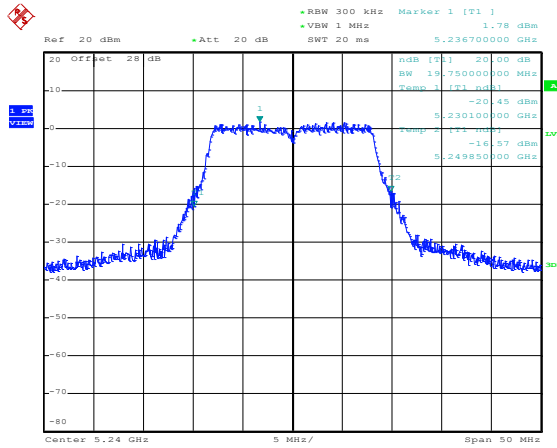

Date: 31.JUL.2014 23:56:48

802.11n HT20 CH48 5240MHz

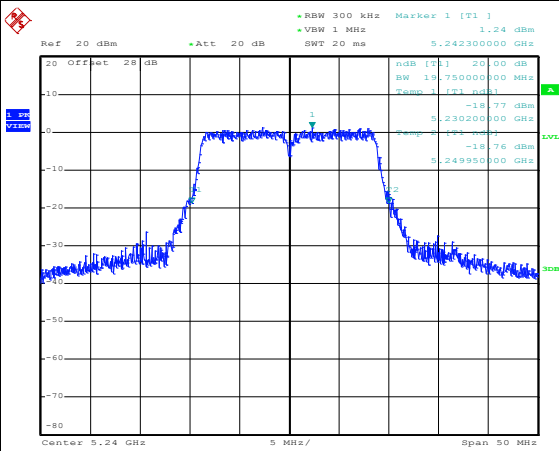

Date: 1.AUG.2014 01:22:09

802.11n HT40 CH46 5230MHz

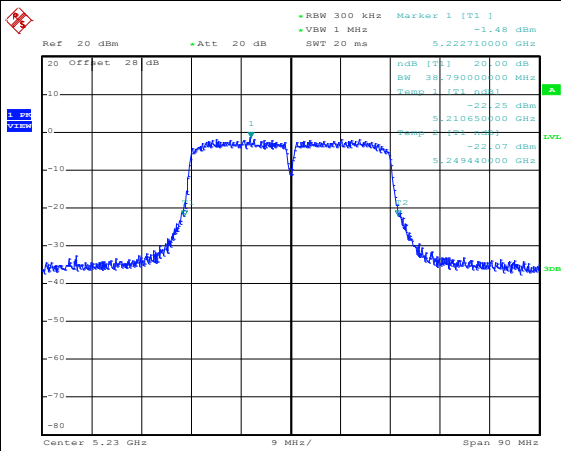

Date: 1.AUG.2014 01:47:26



20dB Occupied Bandwidth

Band II

802.11a CH52 5260MHz

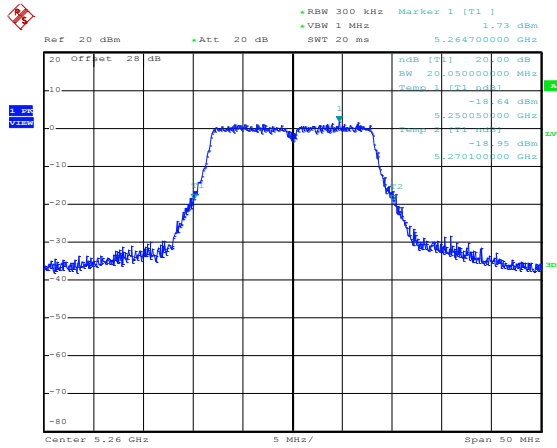

Date: 1.AUG.2014 00:04:14

802.11n HT20 CH52 5260MHz

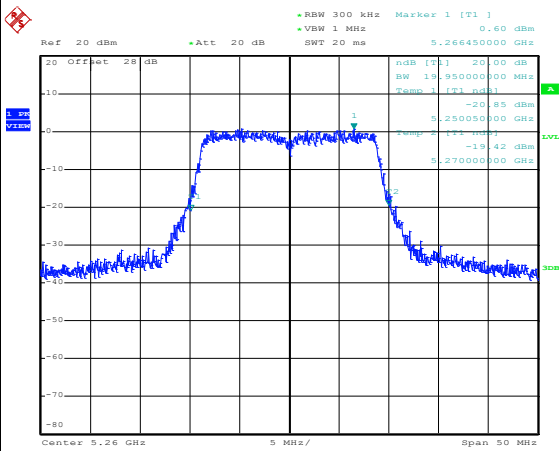

Date: 1.AUG.2014 01:12:47

802.11n HT40 CH54 5270MHz

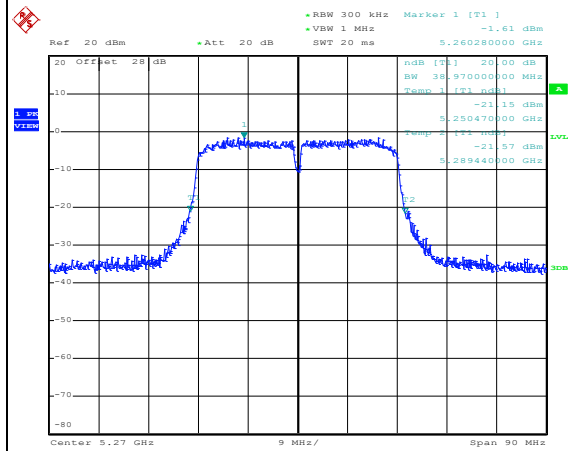

Date: 1.AUG.2014 01:51:01



20dB Occupied Bandwidth

Band III

802.11a CH132 5660MHz

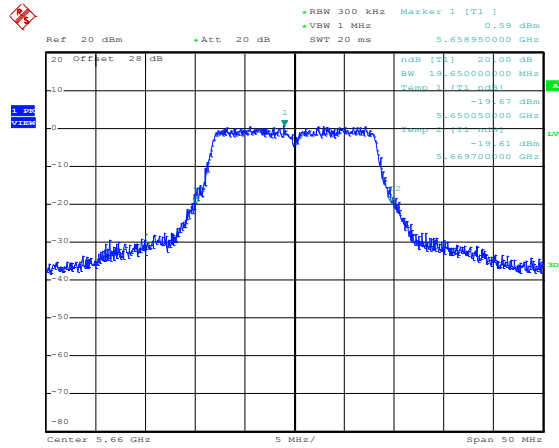

Date: 1.AUG.2014 00:44:49

802.11n HT20 CH132 5660MHz

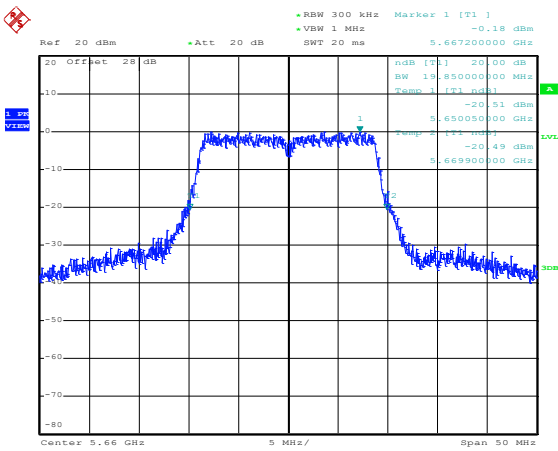

Date: 1.AUG.2014 02:47:21

802.11n HT40 CH134 5670MHz

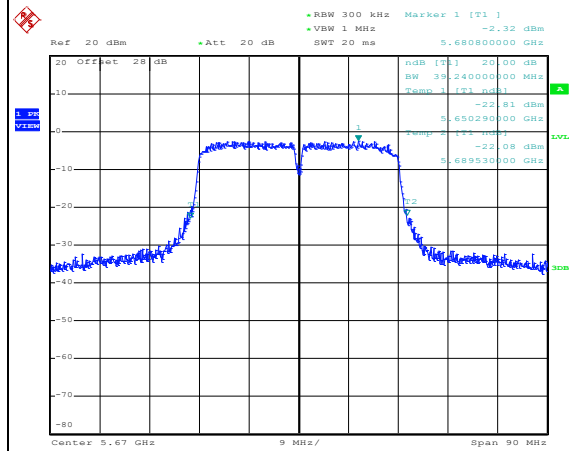

Date: 1.AUG.2014 02:05:01



3.2 Maximum Conducted Output Power Measurement

3.2.1 Limit of Maximum Conducted Output Power

For the band 5150-5250 MHz, the maximum conducted output power shall not exceed the lesser of 50 mW (17dBm) or $4 \text{ dBm} + 10\log B$, where B is the 26 dB emissions bandwidth in 1-MHz. If transmitting antenna directional gain is greater than 6 dBi, the peak output power shall be reduced by the amount in dB that the directional gain of the antenna exceeds 6 dBi.

For the bands 5250-5350 MHz and 5470-5600 MHz and 5650-5725 MHz, bands, the maximum conducted output power shall not exceed the lesser of 250 mW (24dBm) or $11 \text{ dBm} + 10\log B$, where B is the 26 dB emissions bandwidth in 1-MHz. If transmitting antenna directional gain is greater than 6 dBi, the peak output power shall be reduced by the amount in dB that the directional gain of the antenna exceeds 6 dBi.

If transmitting antennas of directional gain greater than 6 dBi are used, the peak output power shall be reduced by the amount in dB that the directional gain of the antenna exceeds 6 dBi.

3.2.2 Measuring Instruments

The measuring equipment is listed in the section 4 of this test report.

3.2.3 Test Procedures

The testing follows Method PM of FCC KDB 789033 D01 General UNII Test Procedures Old Rules v01r04.

Method PM (Measurement using an RF average power meter):

1. Measurement is performed using a wideband RF power meter.
2. The EUT is configured to transmit continuously with a consistent duty cycle at its maximum power control level.
3. Measure the average power of the transmitter, and the average power is corrected with duty factor, $10 \log(1/x)$, where x is the duty cycle.

3.2.4 Test Setup

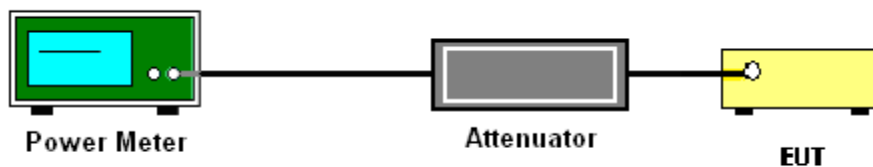



3.2.5 Test Result of Maximum Conducted Output Power

Test Band :	5GHz band 1	Temperature :	21~26°C
Test Engineer :	Osolemio Chang and Alen Tsui	Relative Humidity :	45~54%

Mod.	Data Rate	N _{TX}	Channel	Freq. (MHz)	Duty Factor (dB)	Average Conducted Power (dBm)	FCC Conducted Power Limit (dBm)	DG (dBi)		Pass/Fail
11a	6Mbps	1	36	5180	0.59	9.81	16.99	1.16		Pass
11a	6Mbps	1	44	5220	0.59	9.73	16.99	1.16		Pass
11a	6Mbps	1	48	5240	0.59	9.50	16.99	1.16		Pass
HT20	MCS0	1	36	5180	0.63	9.88	16.99	1.16		Pass
HT20	MCS0	1	44	5220	0.63	9.80	16.99	1.16		Pass
HT20	MCS0	1	48	5240	0.63	9.76	16.99	1.16		Pass
HT40	MCS0	1	38	5190	1.17	9.76	16.99	1.16		Pass
HT40	MCS0	1	46	5230	1.17	9.94	16.99	1.16		Pass

Mod.	Data Rate	N _{TX}	Channel	Freq. (MHz)	Duty Factor (dB)	Average Conducted Power (dBm)	IC Conducted Power Limit (dBm)	DG (dBi)	EIRP Power Limit (dBm)	Pass/Fail
11a	6Mbps	1	36	5180	0.59	9.81	21.44	1.16	22.60	Pass
11a	6Mbps	1	44	5220	0.59	9.73	21.42	1.16	22.58	Pass
11a	6Mbps	1	48	5240	0.59	9.50	21.42	1.16	22.58	Pass
HT20	MCS0	1	36	5180	0.63	9.88	21.60	1.16	22.76	Pass
HT20	MCS0	1	44	5220	0.63	9.80	21.60	1.16	22.76	Pass
HT20	MCS0	1	48	5240	0.63	9.76	21.60	1.16	22.76	Pass
HT40	MCS0	1	38	5190	1.17	9.76	21.85	1.16	23.01	Pass
HT40	MCS0	1	46	5230	1.17	9.94	21.85	1.16	23.01	Pass

Note:

1. Final Output Power equals to Measured Output Power adds the duty factor.
2. For the band 5150-5250 MHz, the maximum average conducted output power shall not exceed lesser of 50 mW (17dBm) or 4 dBm + 10log (B), where B is 26dB BW for FCC.
3. For the band 5150-5250 MHz, the maximum average EIRP output power shall not exceed lesser of 200 mW (23dBm) or 10 dBm + 10log (B), where B is 99%OBW for IC.



Test Band :	5GHz band 2	Temperature :	21~26°C
Test Engineer :	Osolemio Chang and Alen Tsui	Relative Humidity :	45~54%

Mod.	Data Rate	N _{TX}	Channel	Freq. (MHz)	Duty Factor (dB)	Average Conducted Power (dBm)	FCC Conducted Power Limit (dBm)	DG (dBi)		Pass/Fail
11a	6Mbps	1	52	5260	0.59	9.67	23.98	0.25		Pass
11a	6Mbps	1	60	5300	0.59	9.76	23.98	0.25		Pass
11a	6Mbps	1	64	5320	0.59	9.64	23.98	0.25		Pass
HT20	MCS0	1	52	5260	0.63	9.83	23.98	0.25		Pass
HT20	MCS0	1	60	5300	0.63	9.93	23.98	0.25		Pass
HT20	MCS0	1	64	5320	0.63	9.69	23.98	0.25		Pass
HT40	MCS0	1	54	5270	1.17	9.91	23.98	0.25		Pass
HT40	MCS0	1	62	5310	1.17	9.72	23.98	0.25		Pass

Mod.	Data Rate	N _{TX}	Channel	Freq. (MHz)	Duty Factor (dB)	Average Conducted Power (dBm)	IC Conducted Power Limit (dBm)	DG (dBi)	EIRP Power Limit (dBm)	Pass/Fail
11a	6Mbps	1	52	5260	0.59	9.67	23.60	0.25	29.60	Pass
11a	6Mbps	1	60	5300	0.59	9.76	23.60	0.25	29.60	Pass
11a	6Mbps	1	64	5320	0.59	9.64	23.58	0.25	29.58	Pass
HT20	MCS0	1	52	5260	0.63	9.83	23.76	0.25	29.76	Pass
HT20	MCS0	1	60	5300	0.63	9.93	23.81	0.25	29.81	Pass
HT20	MCS0	1	64	5320	0.63	9.69	23.78	0.25	29.78	Pass
HT40	MCS0	1	54	5270	1.17	9.91	23.98	0.25	30.00	Pass
HT40	MCS0	1	62	5310	1.17	9.72	23.98	0.25	30.00	Pass

Note:

1. Final Output Power equals to Measured Output Power adds the duty factor.
2. For the 5250-5350 MHz and 5470-5600 MHz and 5650-5725 MHz bands, the maximum conducted output power shall not exceed the lesser of 250 mW (24dBm) or 11 dBm + 10log (B), where B is 26dB BW for FCC and 99% OBW for IC



Test Band :	5GHz band 3	Temperature :	21~26°C
Test Engineer :	Osolemio Chang and Alen Tsui	Relative Humidity :	45~54%

Mod.	Data Rate	N _{TX}	Channel	Freq. (MHz)	Duty Factor (dB)	Average Conducted Power (dBm)	FCC Conducted Power Limit (dBm)	DG (dBi)		Pass/Fail
11a	6Mbps	1	100	5500	0.59	9.20	23.98	0.74		Pass
11a	6Mbps	1	116	5580	0.59	9.31	23.98	0.74		Pass
11a	6Mbps	1	140	5700	0.59	9.07	23.98	0.74		Pass
HT20	MCS0	1	100	5500	0.63	9.53	23.98	0.74		Pass
HT20	MCS0	1	116	5580	0.63	9.60	23.98	0.74		Pass
HT20	MCS0	1	140	5700	0.63	9.47	23.98	0.74		Pass
HT40	MCS0	1	102	5510	1.17	8.37	23.98	0.74		Pass
HT40	MCS0	1	110	5550	1.17	9.48	23.98	0.74		Pass
HT40	MCS0	1	134	5670	1.17	9.52	23.98	0.74		Pass

Mod.	Data Rate	N _{TX}	Channel	Freq. (MHz)	Duty Factor (dB)	Average Conducted Power (dBm)	IC Conducted Power Limit (dBm)	DG (dBi)	EIRP Power Limit (dBm)	Pass/Fail
11a	6Mbps	1	100	5500	0.59	9.20	23.58	0.74	29.58	Pass
11a	6Mbps	1	116	5580	0.59	9.31	23.59	0.74	29.59	Pass
11a	6Mbps	1	140	5700	0.59	9.07	23.58	0.74	29.58	Pass
HT20	MCS0	1	100	5500	0.63	9.53	23.80	0.74	29.80	Pass
HT20	MCS0	1	116	5580	0.63	9.60	23.78	0.74	29.78	Pass
HT20	MCS0	1	140	5700	0.63	9.47	23.81	0.74	29.81	Pass
HT40	MCS0	1	102	5510	1.17	8.37	23.98	0.74	30.00	Pass
HT40	MCS0	1	110	5550	1.17	9.48	23.98	0.74	30.00	Pass
HT40	MCS0	1	134	5670	1.17	9.52	23.98	0.74	30.00	Pass

Note:

1. Final Output Power equals to Measured Output Power adds the duty factor.
2. For the 5250-5350 MHz and 5470-5600 MHz and 5650-5725 MHz bands, the maximum conducted output power shall not exceed the lesser of 250 mW (24dBm) or 11 dBm + 10log (B), where B is 26dB BW for FCC and 99% OBW for IC.



3.3 Power Spectral Density Measurement

3.3.1 Limit of Power Spectral Density

For the band 5150-5250 MHz, the peak power spectral density shall not exceed 4 dBm in any 1-MHz band.

For the bands 5250-5350 MHz and 5470-5600 and 5650-5725 MHz, the peak power spectral density shall not exceed 11 dBm in any 1-MHz band.

If transmitting antenna directional gain is greater than 6 dBi, both the maximum conducted output power and the peak power spectral density shall be reduced by the amount in dB that the directional gain of the antenna exceeds 6 dBi.

3.3.2 Measuring Instruments

The measuring equipment is listed in the section 4 of this test report.

3.3.3 Test Procedures

The testing follows FCC KDB 789033 D01 General UNII Test Procedures Old Rules v01r04.

Section F) Peak power spectral density (PPSD).

Note: Though the rule refers to “peak power spectral density”, the intent is to measure the maximum value of the time average of the power spectral density measured during a period of continuous transmission.

Method SA-2

(trace averaging across on and off times of the EUT transmissions, followed by duty cycle correction).

1. The testing follows Method SA-2 of FCC KDB 789033 D01 General UNII Test Procedures Old Rules v01r04.
 - Measure the duty cycle.
 - Set span to encompass the entire emission bandwidth (EBW) of the signal.
 - Set RBW = 1 MHz.
 - Set VBW \geq 3 MHz.
 - Number of points in sweep \geq 2 Span / RBW.
 - Sweep time = auto.
 - Detector = RMS
 - Trace average at least 100 traces in power averaging mode.
 - Add $10 \log(1/x)$, where x is the duty cycle, to the measured power in order to compute the average power during the actual transmission times. For example, add $10 \log(1/0.25) = 6$ dB if the duty cycle is 25 percent.
2. The RF output of EUT was connected to the spectrum analyzer by a low loss cable.
3. Each plot has already offset with cable loss, and attenuator loss. Measure the PPSD and record it.

3.3.4 Test Setup

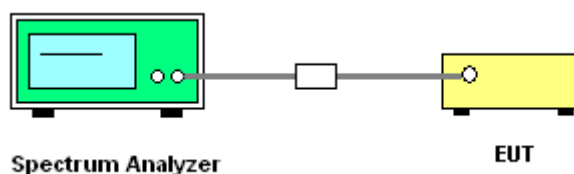



3.3.5 Test Result of Power Spectral Density

Test Band :	5GHz band 1	Temperature :	21~26°C
Test Engineer :	Osolemio Chang and Alen Tsui	Relative Humidity :	45~54%

Mod.	Data Rate	N _{TX}	CH	Freq. (MHz)	Duty Factor (dB)	Average Power Density (dBm/MHz)	Average PSD Limit (dBm)	DG (dBi)	EIRP PSD Limit (dBm)	Pass/Fail
11a	6Mbps	1	36	5180	0.59	-1.02	4.00	1.16	10	Pass
11a	6Mbps	1	44	5220	0.59	-0.76	4.00	1.16	10	Pass
11a	6Mbps	1	48	5240	0.59	-1.37	4.00	1.16	10	Pass
HT20	MCS0	1	36	5180	0.63	-1.19	4.00	1.16	10	Pass
HT20	MCS0	1	44	5220	0.63	-1.06	4.00	1.16	10	Pass
HT20	MCS0	1	48	5240	0.63	-1.11	4.00	1.16	10	Pass
HT40	MCS0	1	38	5190	1.17	-4.31	4.00	1.16	10	Pass
HT40	MCS0	1	46	5230	1.17	-4.38	4.00	1.16	10	Pass

Test Band :	5GHz band 2	Temperature :	21~26°C
Test Engineer :	Osolemio Chang and Alen Tsui	Relative Humidity :	45~54%

Mod.	Data Rate	N _{TX}	CH	Freq. (MHz)	Duty Factor (dB)	Average Power Density (dBm/MHz)	Average PSD Limit (dBm)	DG (dBi)	Pass/Fail
11a	6Mbps	1	52	5260	0.59	-1.17	11.00	0.25	Pass
11a	6Mbps	1	60	5300	0.59	-1.22	11.00	0.25	Pass
11a	6Mbps	1	64	5320	0.59	-1.16	11.00	0.25	Pass
HT20	MCS0	1	52	5260	0.63	-1.30	11.00	0.25	Pass
HT20	MCS0	1	60	5300	0.63	-1.07	11.00	0.25	Pass
HT20	MCS0	1	64	5320	0.63	-0.90	11.00	0.25	Pass
HT40	MCS0	1	54	5270	1.17	-4.60	11.00	0.25	Pass
HT40	MCS0	1	62	5310	1.17	-4.46	11.00	0.25	Pass



Test Band :	5GHz band 3	Temperature :	21~26°C
Test Engineer :	Osolemio Chang and Alen Tsui	Relative Humidity :	45~54%

Mod.	Data Rate	N _{TX}	CH	Freq. (MHz)	Duty Factor (dB)	Average Power Density (dBm/MHz)	Average PSD Limit (dBm)	DG (dBi)	Pass/Fail
11a	6Mbps	1	100	5500	0.59	-0.93	11.00	0.74	Pass
11a	6Mbps	1	116	5580	0.59	-1.16	11.00	0.74	Pass
11a	6Mbps	1	140	5700	0.59	-1.73	11.00	0.74	Pass
HT20	MCS0	1	100	5500	0.63	-0.63	11.00	0.74	Pass
HT20	MCS0	1	116	5580	0.63	-1.20	11.00	0.74	Pass
HT20	MCS0	1	140	5700	0.63	-1.65	11.00	0.74	Pass
HT40	MCS0	1	102	5510	1.17	-5.67	11.00	0.74	Pass
HT40	MCS0	1	110	5550	1.17	-4.83	11.00	0.74	Pass
HT40	MCS0	1	134	5670	1.17	-5.05	11.00	0.74	Pass

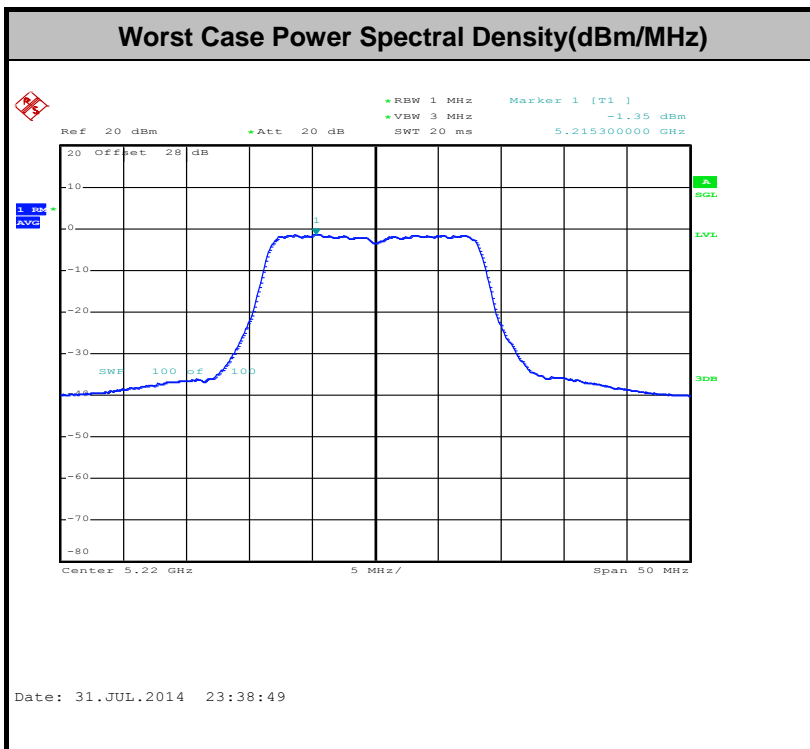

Note: Average Power Density (dB) = Measured value+ Duty Factor

3.4 Peak Excursion Ratio Measurement

3.4.1 Limit of Peak Excursion Ratio

The ratio of the peak excursion of the modulation envelope (measured using a peak hold function) to the maximum conducted output power (measured as specified above) shall not exceed 13 dB across any 1 MHz bandwidth or the emission bandwidth whichever is less.

3.4.2 Measuring Instruments

The measuring equipment is listed in the section 4 of this test report.

3.4.3 Test Procedures

The testing follows FCC KDB 789033 D01 General UNII Test Procedures Old Rules v01r04.

Section G) Peak excursion measurement

1. The transmitter output is connected to the spectrum analyzer.
2. Set the spectrum analyzer span to view the entire emission bandwidth.
3. Find the maximum of the peak-max-hold spectrum.
 - *Set RBW = 1MHz.
 - *Set VBW \geq 3MHz.
 - *Detector = peak.
 - *Trace mode = max-hold.
 - *Allow the sweeps to continue until the trace stabilizes.
 - *Use the peak search function to find the peak of the spectrum.
4. Use the procedure found under section 3.3 to measure the PPSD.
5. Compute the ratio of the maximum of the peak-max-hold spectrum to the PPSD.

3.4.4 Test Setup

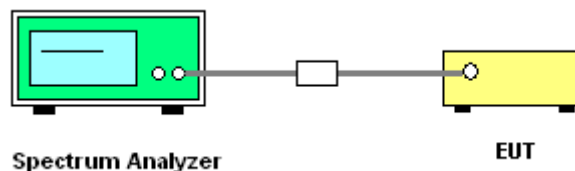



3.4.5 Test Result of Peak Excursion Ratio

Test Band :	5GHz band 3	Temperature :	21~26°C
Test Engineer :	Osolemio Chang and Alen Tsui	Relative Humidity :	45~54%

Mod.	N _{TX}	Channel	Freq. (MHz)	Peak Excursion Ratio (dB)					Max. Limits (dB)	Pass/Fail
				BPSK	QPSK	16QAM	64QAM	256QAM		
11a	1	100	5500	7.72	7.33	6.62	5.08	-	13	Pass
HT20	1	100	5500	7.74	7.38	5.77	4.83	-	13	Pass
HT40	1	102	5510	6.99	6.16	5.39	3.87	-	13	Pass

Note: All modulation measured based on the minimum data rate setting.

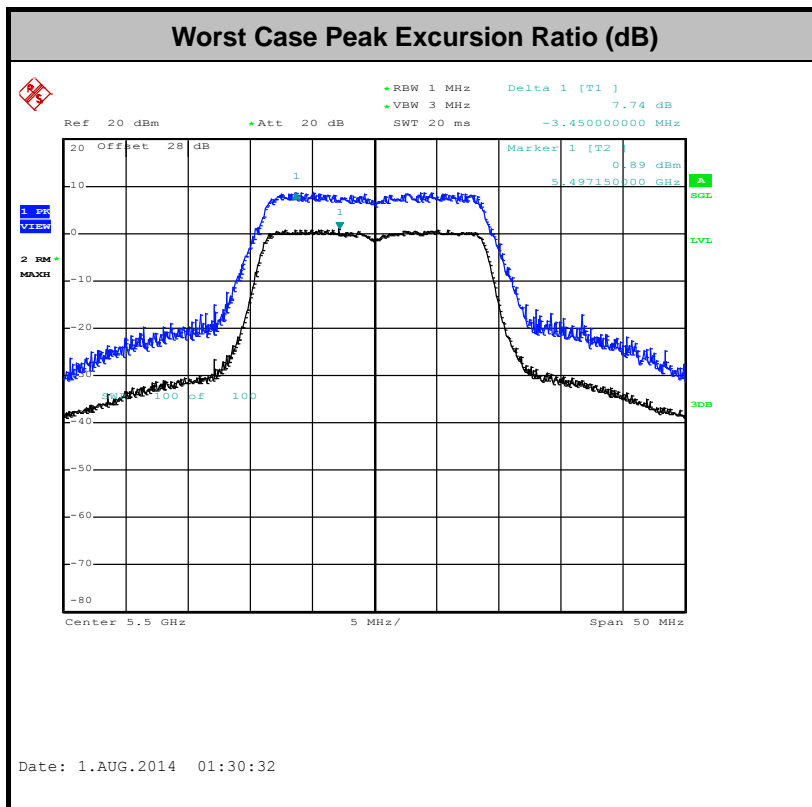

Note: Peak Excursion Ratio (dB) = Peak – (Average + Duty Cycle Offset)

Duty Cycle Offset: 0.63 dB



3.5 Unwanted Radiated Emission Measurement

This section as specified in FCC Part 15.407(b) is to measure unwanted emissions through radiated measurement for band edge spurious emissions and out of band emissions measurement. The unwanted emissions shall comply with 15.407(b)(1) to (6), and restricted bands per FCC Part15.205.

3.5.1 Limit of Unwanted Emissions

(1) For transmitters operating in the 5150-5250 MHz band: all emissions outside of the 5150-5350 MHz band shall not exceed an EIRP of -27dBm/MHz.

For transmitters operating in the 5250-5350 MHz band: all emissions outside of the 5150-5350 MHz band shall not exceed an EIRP of -27 dBm/MHz. Devices operating in the 5250-5350 MHz band that generate emissions in the 5150-5250 MHz band must meet all applicable technical requirements for operation in the 5150-5250 MHz band (including indoor use) or alternatively meet an out-of-band emission EIRP limit of -27 dBm/MHz in the 5150-5250 MHz band.

For transmitters operating in the 5470-5600 MHz and 5650-5725MHz band: all emissions outside of the 5470-5600 MHz and 5650-5725MHz band shall not exceed an EIRP of -27 dBm/MHz.

(2) Unwanted spurious emissions fallen in restricted bands per FCC Part15.205 shall comply with the general field strength limits set forth in § 15.209 as below table,

Frequency (MHz)	Field Strength (microvolts/meter)	Measurement Distance (meters)
0.009 – 0.490	2400/F(kHz)	300
0.490 – 1.705	24000/F(kHz)	30
1.705 – 30.0	30	30
30 – 88	100	3
88 – 216	150	3
216 - 960	200	3
Above 960	500	3

Note: The following formula is used to convert the EIRP to field strength.

$$E = \frac{1000000\sqrt{30P}}{3} \mu V/m, \text{ where } P \text{ is the eirp (Watts)}$$



EIRP (dBm)	Field Strength at 3m (dB μ V/m)
-17	78.3
- 27	68.3

(3) KDB789033 v01 G)2)c) As specified in 15.407(b), emissions above 1000 MHz that are outside of the restricted bands are subject to a peak emission limit of -27 dBm/MHz (or -17 dBm/MHz as specified in 15.407(b)(4)). However, an out-of-band emission that complies with both the average and peak limits of 15.209 is not required to satisfy the -27 dBm/MHz or -17 dBm/MHz peak emission limit.

3.5.2 Measuring Instruments

The measuring equipment is listed in the section 4 of this test report.



3.5.3 Test Procedures

1. The testing follows FCC KDB 789033 D01 General UNII Test Procedures Old Rules v01r04. Section H) Unwanted emissions measurement.

(1) Procedure for Unwanted Emissions Measurements Below 1000MHz

- RBW = 120 kHz
• VBW = 300 kHz
• Detector = Peak
• Trace mode = max hold

(2) Procedure for Peak Unwanted Emissions Measurements Above 1000 MHz

- The setting follows the H) 5) of FCC KDB 789033.
• RBW = 1 MHz
• VBW ≥ 3 MHz
• Detector = Peak
• Sweep time = auto
• Trace mode = max hold

(3) Procedures for Average Unwanted Emissions Measurements Above 1000MHz

- The setting follows H) 6) of FCC KDB 789033.
• RBW = 1 MHz
• VBW = 10 Hz, when duty cycle is no less than 98 percent.
• VBW ≥ 1/T, when duty cycle is less than 98 percent where T is the minimum transmission duration over which the transmitter is on and is transmitting at its maximum power control level for the tested mode of operation.

Table with 5 columns: Band, Duty Cycle(%), T(μs), 1/T(kHz), VBW Setting. Rows include 802.11a, 802.11n HT20, and 802.11n HT40.

2. The EUT was placed on a rotatable table top 0.8 meter above ground.
3. The EUT was set 3 meters from the interference receiving antenna which was mounted on the top of a variable height antenna tower.
4. The antenna is a broadband antenna and its height is adjusted between one meter and four meters above ground to find the maximum value of the field strength for both horizontal polarization and vertical polarization of the antenna.
5. For each suspected emission, the EUT was arranged to its worst case and then adjust the antenna tower (from 1 m to 4 m) and turntable (from 0 degree to 360 degrees) to find the maximum reading.
6. For testing below 1GHz, if the emission level of the EUT in peak mode was 3 dB lower than the limit specified, then peak values of EUT will be reported, otherwise, the emissions will be repeated one by one using the CISPR quasi-peak method and reported.
7. For testing above 1GHz, the emission level of the EUT in peak mode was 20dB lower than average limit (that means the emission level in average mode also complies with the limit in average mode), then peak values of EUT will be reported, otherwise, the emissions will be measured in average mode again and reported.

3.5.4 Test Setup

For radiated emissions below 30MHz

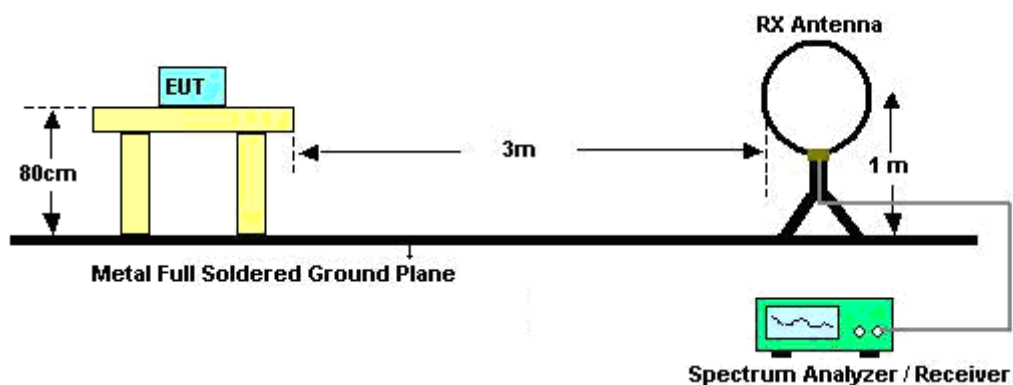

For radiated emissions from 30MHz to 1GHz

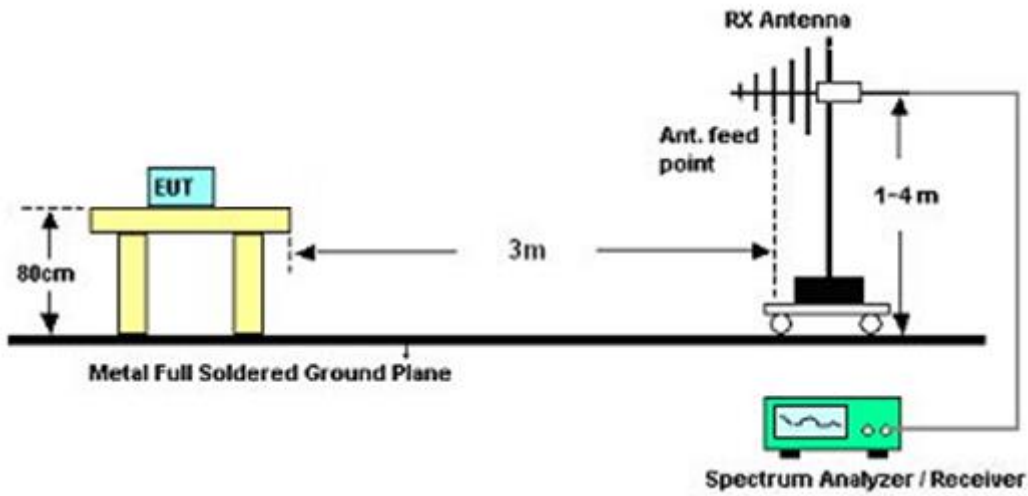

For radiated emissions above 1GHz

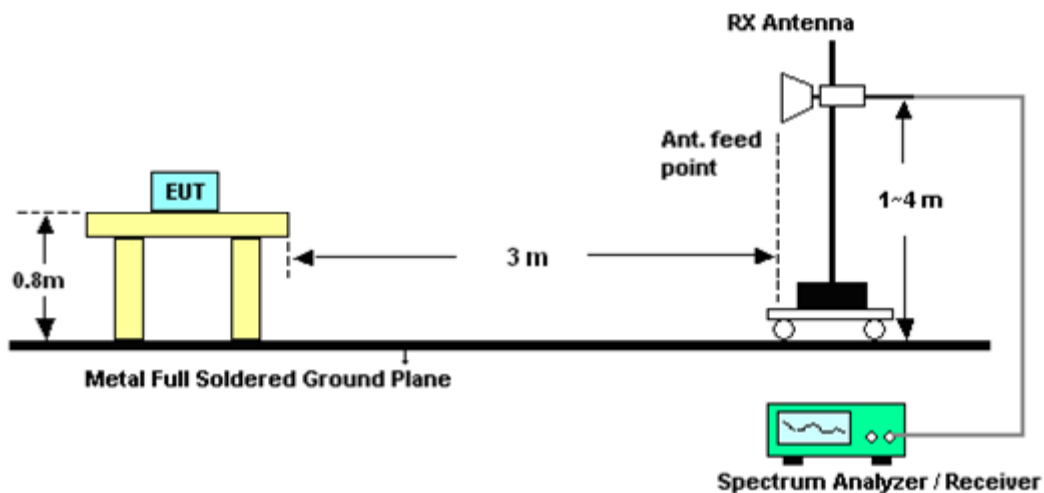

3.5.5 Test Results of Radiated Emissions (9 kHz ~ 30 MHz)

The low frequency, which started from 9 kHz to 30MHz, was pre-scanned and the result which was 20dB lower than the limit line per 15.31(o) was not reported.



3.5.6 Test Result

3.5.6.1 Test Result of Radiated Band Edges

Test Mode :	802.11a	Temperature :	22~24°C
Test Channel :	36	Relative Humidity :	47~49%
Test Engineer :	Kyle Jhuang, Abi Lin and Derreck Chen		

ANTENNA POLARITY : HORIZONTAL										
Frequency (MHz)	Level (dBμV/m)	Over Limit (dB)	Limit Line (dBμV/m)	Read Level (dBμV)	Antenna Factor (dB)	Cable Loss (dB)	Preamp Factor (dB)	Ant Pos (cm)	Table Pos (deg)	Remark
5040.95	48.08	-25.92	74	42.15	31.84	6.48	32.39	108	115	Peak
5149.4	38.88	-15.12	54	32.71	31.95	6.62	32.4	108	115	Average

ANTENNA POLARITY : VERTICAL										
Frequency (MHz)	Level (dBμV/m)	Over Limit (dB)	Limit Line (dBμV/m)	Read Level (dBμV)	Antenna Factor (dB)	Cable Loss (dB)	Preamp Factor (dB)	Ant Pos (cm)	Table Pos (deg)	Remark
5149.85	54.36	-19.64	74	48.19	31.95	6.62	32.4	101	16	Peak
5150	44.84	-9.16	54	38.67	31.95	6.62	32.4	101	16	Average



Test Mode :	802.11a	Temperature :	22~24°C
Test Channel :	48	Relative Humidity :	47~49%
Test Engineer :	Kyle Jhuang, Abi Lin and Derreck Chen		

ANTENNA POLARITY : HORIZONTAL										
Frequency (MHz)	Level (dBμV/m)	Over Limit (dB)	Limit Line (dBμV/m)	Read Level (dBμV)	Antenna Factor (dB)	Cable Loss (dB)	Preamp Factor (dB)	Ant Pos (cm)	Table Pos (deg)	Remark
5090.3	48.78	-25.22	74	42.73	31.89	6.55	32.39	109	195	Peak
5144.3	38.97	-15.03	54	32.81	31.94	6.62	32.4	109	195	Average
5418.75	48.5	-25.5	74	41.91	32.22	6.78	32.41	109	195	Peak
5453.62	39.18	-14.82	54	32.53	32.25	6.81	32.41	109	195	Average

ANTENNA POLARITY : VERTICAL										
Frequency (MHz)	Level (dBμV/m)	Over Limit (dB)	Limit Line (dBμV/m)	Read Level (dBμV)	Antenna Factor (dB)	Cable Loss (dB)	Preamp Factor (dB)	Ant Pos (cm)	Table Pos (deg)	Remark
5032.55	48.49	-25.51	74	42.58	31.83	6.47	32.39	100	342	Peak
5149.25	38.99	-15.01	54	32.82	31.95	6.62	32.4	100	342	Average
5414.68	49.35	-24.65	74	42.77	32.21	6.78	32.41	100	342	Peak
5459.23	39.46	-14.54	54	32.79	32.26	6.82	32.41	100	342	Average



Test Mode :	802.11a	Temperature :	22~24°C
Test Channel :	52	Relative Humidity :	47~49%
Test Engineer :	Kyle Jhuang, Abi Lin and Derreck Chen		

ANTENNA POLARITY : HORIZONTAL										
Frequency (MHz)	Level (dBµV/m)	Over Limit (dB)	Limit Line (dBµV/m)	Read Level (dBµV)	Antenna Factor (dB)	Cable Loss (dB)	Preamp Factor (dB)	Ant Pos (cm)	Table Pos (deg)	Remark
5117.45	48.45	-25.55	74	42.34	31.92	6.58	32.39	105	33	Peak
5148.65	38.94	-15.06	54	32.77	31.95	6.62	32.4	105	33	Average
5377.28	49.23	-24.77	74	42.7	32.18	6.76	32.41	105	33	Peak
5458.57	39.32	-14.68	54	32.65	32.26	6.82	32.41	105	33	Average

ANTENNA POLARITY : VERTICAL										
Frequency (MHz)	Level (dBµV/m)	Over Limit (dB)	Limit Line (dBµV/m)	Read Level (dBµV)	Antenna Factor (dB)	Cable Loss (dB)	Preamp Factor (dB)	Ant Pos (cm)	Table Pos (deg)	Remark
5097.05	48.53	-25.47	74	42.46	31.9	6.56	32.39	100	11	Peak
5149.25	39.12	-14.88	54	32.95	31.95	6.62	32.4	100	11	Average
5435.8	49.62	-24.38	74	42.99	32.24	6.8	32.41	100	11	Peak
5456.37	39.43	-14.57	54	32.76	32.26	6.82	32.41	100	11	Average

Test Mode :	802.11a	Temperature :	22~24°C
Test Channel :	64	Relative Humidity :	47~49%
Test Engineer :	Kyle Jhuang, Abi Lin and Derreck Chen		

ANTENNA POLARITY : HORIZONTAL										
Frequency (MHz)	Level (dBµV/m)	Over Limit (dB)	Limit Line (dBµV/m)	Read Level (dBµV)	Antenna Factor (dB)	Cable Loss (dB)	Preamp Factor (dB)	Ant Pos (cm)	Table Pos (deg)	Remark
5351.87	51.42	-22.58	74	44.92	32.15	6.75	32.4	104	32	Peak
5350.22	41.02	-12.98	54	34.52	32.15	6.75	32.4	104	32	Average

ANTENNA POLARITY : VERTICAL										
Frequency (MHz)	Level (dBµV/m)	Over Limit (dB)	Limit Line (dBµV/m)	Read Level (dBµV)	Antenna Factor (dB)	Cable Loss (dB)	Preamp Factor (dB)	Ant Pos (cm)	Table Pos (deg)	Remark
5351.21	56.18	-17.82	74	49.68	32.15	6.75	32.4	100	340	Peak
5350	45.8	-8.2	54	39.3	32.15	6.75	32.4	100	340	Average



Test Mode :	802.11a	Temperature :	22~24°C
Test Channel :	100	Relative Humidity :	47~49%
Test Engineer :	Kyle Jhuang, Abi Lin and Derreck Chen		

ANTENNA POLARITY : HORIZONTAL										
Frequency (MHz)	Level (dBμV/m)	Over Limit (dB)	Limit Line (dBμV/m)	Read Level (dBμV)	Antenna Factor (dB)	Cable Loss (dB)	Preamp Factor (dB)	Ant Pos (cm)	Table Pos (deg)	Remark
5450.96	49.97	-24.03	74	43.32	32.25	6.81	32.41	111	326	Peak
5447.6	41.57	-12.43	54	34.92	32.25	6.81	32.41	111	326	Average

ANTENNA POLARITY : VERTICAL										
Frequency (MHz)	Level (dBμV/m)	Over Limit (dB)	Limit Line (dBμV/m)	Read Level (dBμV)	Antenna Factor (dB)	Cable Loss (dB)	Preamp Factor (dB)	Ant Pos (cm)	Table Pos (deg)	Remark
5447.92	51.58	-22.42	74	44.93	32.25	6.81	32.41	105	41	Peak
5447.76	43.88	-10.12	54	37.23	32.25	6.81	32.41	105	41	Average

Test Mode :	802.11a	Temperature :	22~24°C
Test Channel :	140	Relative Humidity :	47~49%
Test Engineer :	Kyle Jhuang, Abi Lin and Derreck Chen		

ANTENNA POLARITY : HORIZONTAL										
Frequency (MHz)	Level (dBμV/m)	Over Limit (dB)	Limit Line (dBμV/m)	Read Level (dBμV)	Antenna Factor (dB)	Cable Loss (dB)	Preamp Factor (dB)	Ant Pos (cm)	Table Pos (deg)	Remark
5726.12	51.74	-22.26	74	44.67	32.57	7.02	32.52	108	11	Peak
5725	42.7	-11.3	54	35.63	32.57	7.02	32.52	108	11	Average

ANTENNA POLARITY : VERTICAL										
Frequency (MHz)	Level (dBμV/m)	Over Limit (dB)	Limit Line (dBμV/m)	Read Level (dBμV)	Antenna Factor (dB)	Cable Loss (dB)	Preamp Factor (dB)	Ant Pos (cm)	Table Pos (deg)	Remark
5725	53.03	-20.97	74	45.96	32.57	7.02	32.52	102	26	Peak
5725.08	42.82	-11.18	54	35.75	32.57	7.02	32.52	102	26	Average



Test Mode :	802.11n HT20	Temperature :	22~24°C
Test Channel :	36	Relative Humidity :	47~49%
Test Engineer :	Kyle Jhuang, Abi Lin and Derreck Chen		

ANTENNA POLARITY : HORIZONTAL										
Frequency (MHz)	Level (dBμV/m)	Over Limit (dB)	Limit Line (dBμV/m)	Read Level (dBμV)	Antenna Factor (dB)	Cable Loss (dB)	Preamp Factor (dB)	Ant Pos (cm)	Table Pos (deg)	Remark
5149.55	49.54	-24.46	74	43.37	31.95	6.62	32.4	107	31	Peak
5150	41.84	-12.16	54	35.67	31.95	6.62	32.4	107	31	Average

ANTENNA POLARITY : VERTICAL										
Frequency (MHz)	Level (dBμV/m)	Over Limit (dB)	Limit Line (dBμV/m)	Read Level (dBμV)	Antenna Factor (dB)	Cable Loss (dB)	Preamp Factor (dB)	Ant Pos (cm)	Table Pos (deg)	Remark
5147.3	59.81	-14.19	74	53.64	31.95	6.62	32.4	100	12	Peak
5150	45.67	-8.33	54	39.5	31.95	6.62	32.4	100	12	Average

Test Mode :	802.11n HT20	Temperature :	22~24°C
Test Channel :	48	Relative Humidity :	47~49%
Test Engineer :	Kyle Jhuang, Abi Lin and Derreck Chen		

ANTENNA POLARITY : HORIZONTAL										
Frequency (MHz)	Level (dBμV/m)	Over Limit (dB)	Limit Line (dBμV/m)	Read Level (dBμV)	Antenna Factor (dB)	Cable Loss (dB)	Preamp Factor (dB)	Ant Pos (cm)	Table Pos (deg)	Remark
5119.4	47.78	-26.22	74	41.66	31.92	6.59	32.39	107	29	Peak
5131.85	38.85	-15.15	54	32.72	31.93	6.6	32.4	107	29	Average
5445.04	49.79	-24.21	74	43.14	32.25	6.81	32.41	107	29	Peak
5453.51	39.28	-14.72	54	32.63	32.25	6.81	32.41	107	29	Average

ANTENNA POLARITY : VERTICAL										
Frequency (MHz)	Level (dBμV/m)	Over Limit (dB)	Limit Line (dBμV/m)	Read Level (dBμV)	Antenna Factor (dB)	Cable Loss (dB)	Preamp Factor (dB)	Ant Pos (cm)	Table Pos (deg)	Remark
5108	48.05	-25.95	74	41.96	31.91	6.57	32.39	100	346	Peak
5147	39.01	-14.99	54	32.84	31.95	6.62	32.4	100	346	Average
5439.1	48.9	-25.1	74	42.27	32.24	6.8	32.41	100	346	Peak
5432.17	39.41	-14.59	54	32.79	32.23	6.8	32.41	100	346	Average



Test Mode :	802.11n HT20	Temperature :	22~24°C
Test Channel :	52	Relative Humidity :	47~49%
Test Engineer :	Kyle Jhuang, Abi Lin and Derreck Chen		

ANTENNA POLARITY : HORIZONTAL										
Frequency (MHz)	Level (dBμV/m)	Over Limit (dB)	Limit Line (dBμV/m)	Read Level (dBμV)	Antenna Factor (dB)	Cable Loss (dB)	Preamp Factor (dB)	Ant Pos (cm)	Table Pos (deg)	Remark
5078.75	48.71	-25.29	74	42.69	31.88	6.53	32.39	106	28	Peak
5148.95	38.84	-15.16	54	32.67	31.95	6.62	32.4	106	28	Average
5364.19	49	-25	74	42.48	32.16	6.76	32.4	106	28	Peak
5458.35	39.33	-14.67	54	32.66	32.26	6.82	32.41	106	28	Average

ANTENNA POLARITY : VERTICAL										
Frequency (MHz)	Level (dBμV/m)	Over Limit (dB)	Limit Line (dBμV/m)	Read Level (dBμV)	Antenna Factor (dB)	Cable Loss (dB)	Preamp Factor (dB)	Ant Pos (cm)	Table Pos (deg)	Remark
5144.3	48.6	-25.4	74	42.44	31.94	6.62	32.4	100	336	Peak
5129.15	38.94	-15.06	54	32.81	31.93	6.6	32.4	100	336	Average
5355.5	49.23	-24.77	74	42.72	32.16	6.75	32.4	100	336	Peak
5459.67	39.39	-14.61	54	32.72	32.26	6.82	32.41	100	336	Average

Test Mode :	802.11n HT20	Temperature :	22~24°C
Test Channel :	64	Relative Humidity :	47~49%
Test Engineer :	Kyle Jhuang, Abi Lin and Derreck Chen		

ANTENNA POLARITY : HORIZONTAL										
Frequency (MHz)	Level (dBμV/m)	Over Limit (dB)	Limit Line (dBμV/m)	Read Level (dBμV)	Antenna Factor (dB)	Cable Loss (dB)	Preamp Factor (dB)	Ant Pos (cm)	Table Pos (deg)	Remark
5353.19	51.91	-22.09	74	45.41	32.15	6.75	32.4	104	25	Peak
5350.11	42.56	-11.44	54	36.06	32.15	6.75	32.4	104	25	Average

ANTENNA POLARITY : VERTICAL										
Frequency (MHz)	Level (dBμV/m)	Over Limit (dB)	Limit Line (dBμV/m)	Read Level (dBμV)	Antenna Factor (dB)	Cable Loss (dB)	Preamp Factor (dB)	Ant Pos (cm)	Table Pos (deg)	Remark
5357.48	58.29	-15.71	74	51.78	32.16	6.75	32.4	100	347	Peak
5350.22	47.46	-6.54	54	40.96	32.15	6.75	32.4	100	347	Average



Test Mode :	802.11n HT20	Temperature :	22~24°C
Test Channel :	100	Relative Humidity :	47~49%
Test Engineer :	Kyle Jhuang, Abi Lin and Derreck Chen		

ANTENNA POLARITY : HORIZONTAL										
Frequency (MHz)	Level (dBμV/m)	Over Limit (dB)	Limit Line (dBμV/m)	Read Level (dBμV)	Antenna Factor (dB)	Cable Loss (dB)	Preamp Factor (dB)	Ant Pos (cm)	Table Pos (deg)	Remark
5465.84	50.59	-23.41	74	43.91	32.27	6.82	32.41	100	9	Peak
5469.68	42.1	-11.9	54	35.41	32.27	6.83	32.41	100	9	Average

ANTENNA POLARITY : VERTICAL										
Frequency (MHz)	Level (dBμV/m)	Over Limit (dB)	Limit Line (dBμV/m)	Read Level (dBμV)	Antenna Factor (dB)	Cable Loss (dB)	Preamp Factor (dB)	Ant Pos (cm)	Table Pos (deg)	Remark
5468.24	53.78	-20.22	74	47.1	32.27	6.82	32.41	100	72	Peak
5448.4	43.85	-10.15	54	37.2	32.25	6.81	32.41	100	72	Average

Test Mode :	802.11n HT20	Temperature :	22~24°C
Test Channel :	140	Relative Humidity :	47~49%
Test Engineer :	Kyle Jhuang, Abi Lin and Derreck Chen		

ANTENNA POLARITY : HORIZONTAL										
Frequency (MHz)	Level (dBμV/m)	Over Limit (dB)	Limit Line (dBμV/m)	Read Level (dBμV)	Antenna Factor (dB)	Cable Loss (dB)	Preamp Factor (dB)	Ant Pos (cm)	Table Pos (deg)	Remark
5725	56.53	-17.47	74	49.46	32.57	7.02	32.52	100	8	Peak
5725	47.2	-6.8	54	40.13	32.57	7.02	32.52	100	8	Average

ANTENNA POLARITY : VERTICAL										
Frequency (MHz)	Level (dBμV/m)	Over Limit (dB)	Limit Line (dBμV/m)	Read Level (dBμV)	Antenna Factor (dB)	Cable Loss (dB)	Preamp Factor (dB)	Ant Pos (cm)	Table Pos (deg)	Remark
5725.08	60.24	-13.76	74	53.17	32.57	7.02	32.52	103	331	Peak
5725	48.1	-5.9	54	41.03	32.57	7.02	32.52	103	331	Average



Test Mode :	802.11n HT40	Temperature :	22~24°C
Test Channel :	38	Relative Humidity :	47~49%
Test Engineer :	Kyle Jhuang, Abi Lin and Derreck Chen		

ANTENNA POLARITY : HORIZONTAL										
Frequency (MHz)	Level (dBμV/m)	Over Limit (dB)	Limit Line (dBμV/m)	Read Level (dBμV)	Antenna Factor (dB)	Cable Loss (dB)	Preamp Factor (dB)	Ant Pos (cm)	Table Pos (deg)	Remark
5146.5	60.93	-13.07	74	54.76	31.95	6.62	32.4	107	197	Peak
5149.65	51.43	-2.57	54	45.26	31.95	6.62	32.4	107	197	Average
5448.67	49.55	-24.45	74	42.9	32.25	6.81	32.41	107	197	Peak
5453.73	39.81	-14.19	54	33.16	32.25	6.81	32.41	107	197	Average

ANTENNA POLARITY : VERTICAL										
Frequency (MHz)	Level (dBμV/m)	Over Limit (dB)	Limit Line (dBμV/m)	Read Level (dBμV)	Antenna Factor (dB)	Cable Loss (dB)	Preamp Factor (dB)	Ant Pos (cm)	Table Pos (deg)	Remark
5149.05	63.42	-10.58	74	57.25	31.95	6.62	32.4	100	351	Peak
5149	52.76	-1.24	54	46.59	31.95	6.62	32.4	100	351	Average
5454.5	48.63	-25.37	74	41.98	32.25	6.81	32.41	100	351	Peak
5455.27	39.94	-14.06	54	33.28	32.26	6.81	32.41	100	351	Average



Test Mode :	802.11n HT40	Temperature :	22~24°C
Test Channel :	46	Relative Humidity :	47~49%
Test Engineer :	Kyle Jhuang, Abi Lin and Derreck Chen		

ANTENNA POLARITY : HORIZONTAL										
Frequency (MHz)	Level (dBμV/m)	Over Limit (dB)	Limit Line (dBμV/m)	Read Level (dBμV)	Antenna Factor (dB)	Cable Loss (dB)	Preamp Factor (dB)	Ant Pos (cm)	Table Pos (deg)	Remark
5124.1	49.15	-24.85	74	43.03	31.92	6.59	32.39	103	30	Peak
5127.45	39.87	-14.13	54	33.74	31.93	6.6	32.4	103	30	Average
5453.51	48.64	-25.36	74	41.99	32.25	6.81	32.41	103	30	Peak
5438	39.96	-14.04	54	33.33	32.24	6.8	32.41	103	30	Average

ANTENNA POLARITY : VERTICAL										
Frequency (MHz)	Level (dBμV/m)	Over Limit (dB)	Limit Line (dBμV/m)	Read Level (dBμV)	Antenna Factor (dB)	Cable Loss (dB)	Preamp Factor (dB)	Ant Pos (cm)	Table Pos (deg)	Remark
5144.2	48.77	-25.23	74	42.61	31.94	6.62	32.4	103	65	Peak
5126.65	40.9	-13.1	54	34.78	31.93	6.59	32.4	103	65	Average
5432.61	49.22	-24.78	74	42.6	32.23	6.8	32.41	103	65	Peak
5428.98	39.92	-14.08	54	33.31	32.23	6.79	32.41	103	65	Average



Test Mode :	802.11n HT40	Temperature :	22~24°C
Test Channel :	54	Relative Humidity :	47~49%
Test Engineer :	Kyle Jhuang, Abi Lin and Derreck Chen		

ANTENNA POLARITY : HORIZONTAL										
Frequency (MHz)	Level (dBμV/m)	Over Limit (dB)	Limit Line (dBμV/m)	Read Level (dBμV)	Antenna Factor (dB)	Cable Loss (dB)	Preamp Factor (dB)	Ant Pos (cm)	Table Pos (deg)	Remark
5109.8	49.37	-24.63	74	43.28	31.91	6.57	32.39	102	196	Peak
5149.6	39.83	-14.17	54	33.66	31.95	6.62	32.4	102	196	Average
5447.79	49.05	-24.95	74	42.4	32.25	6.81	32.41	102	196	Peak
5421.39	40.11	-13.89	54	33.51	32.22	6.79	32.41	102	196	Average

ANTENNA POLARITY : VERTICAL										
Frequency (MHz)	Level (dBμV/m)	Over Limit (dB)	Limit Line (dBμV/m)	Read Level (dBμV)	Antenna Factor (dB)	Cable Loss (dB)	Preamp Factor (dB)	Ant Pos (cm)	Table Pos (deg)	Remark
5143.6	49.24	-24.76	74	43.08	31.94	6.62	32.4	103	71	Peak
5147.9	39.63	-14.37	54	33.46	31.95	6.62	32.4	103	71	Average
5351.87	49.5	-24.5	74	43	32.15	6.75	32.4	103	71	Peak
5372.88	41.97	-12.03	54	35.44	32.17	6.76	32.4	103	71	Average



Test Mode :	802.11n HT40	Temperature :	22~24°C
Test Channel :	62	Relative Humidity :	47~49%
Test Engineer :	Kyle Jhuang, Abi Lin and Derreck Chen		

ANTENNA POLARITY : HORIZONTAL										
Frequency (MHz)	Level (dBμV/m)	Over Limit (dB)	Limit Line (dBμV/m)	Read Level (dBμV)	Antenna Factor (dB)	Cable Loss (dB)	Preamp Factor (dB)	Ant Pos (cm)	Table Pos (deg)	Remark
5120	48.46	-25.54	74	42.34	31.92	6.59	32.39	105	24	Peak
5120	40.18	-13.82	54	34.06	31.92	6.59	32.39	105	24	Average
5350	61.48	-12.52	74	54.98	32.15	6.75	32.4	105	24	Peak
5350.55	49.2	-4.8	54	42.7	32.15	6.75	32.4	105	24	Average

ANTENNA POLARITY : VERTICAL										
Frequency (MHz)	Level (dBμV/m)	Over Limit (dB)	Limit Line (dBμV/m)	Read Level (dBμV)	Antenna Factor (dB)	Cable Loss (dB)	Preamp Factor (dB)	Ant Pos (cm)	Table Pos (deg)	Remark
5120	49.43	-24.57	74	43.31	31.92	6.59	32.39	106	12	Peak
5120	41.03	-12.97	54	34.91	31.92	6.59	32.39	106	12	Average
5353.08	61.92	-12.08	74	55.42	32.15	6.75	32.4	106	12	Peak
5350.99	52.99	-1.01	54	46.49	32.15	6.75	32.4	106	12	Average



Test Mode :	802.11n HT40	Temperature :	22~24°C
Test Channel :	102	Relative Humidity :	47~49%
Test Engineer :	Kyle Jhuang, Abi Lin and Derreck Chen		

ANTENNA POLARITY : HORIZONTAL										
Frequency (MHz)	Level (dBμV/m)	Over Limit (dB)	Limit Line (dBμV/m)	Read Level (dBμV)	Antenna Factor (dB)	Cable Loss (dB)	Preamp Factor (dB)	Ant Pos (cm)	Table Pos (deg)	Remark
5466.8	61.65	-12.35	74	54.97	32.27	6.82	32.41	100	217	Peak
5469.68	51	-3	54	44.31	32.27	6.83	32.41	100	217	Average
5726.92	48.91	-25.09	74	41.83	32.57	7.03	32.52	100	217	Peak
5759.72	40.28	-13.72	54	33.15	32.61	7.05	32.53	100	217	Average

ANTENNA POLARITY : VERTICAL										
Frequency (MHz)	Level (dBμV/m)	Over Limit (dB)	Limit Line (dBμV/m)	Read Level (dBμV)	Antenna Factor (dB)	Cable Loss (dB)	Preamp Factor (dB)	Ant Pos (cm)	Table Pos (deg)	Remark
5469.52	60.91	-13.09	74	54.22	32.27	6.83	32.41	102	12	Peak
5469.52	52.71	-1.29	54	46.02	32.27	6.83	32.41	102	12	Average
5752.28	48.89	-25.11	74	41.78	32.6	7.04	32.53	102	12	Peak
5764.28	40.37	-13.63	54	33.24	32.62	7.05	32.54	102	12	Average



Test Mode :	802.11n HT40	Temperature :	22~24°C
Test Channel :	134	Relative Humidity :	47~49%
Test Engineer :	Kyle Jhuang, Abi Lin and Derreck Chen		

ANTENNA POLARITY : HORIZONTAL										
Frequency (MHz)	Level (dBμV/m)	Over Limit (dB)	Limit Line (dBμV/m)	Read Level (dBμV)	Antenna Factor (dB)	Cable Loss (dB)	Preamp Factor (dB)	Ant Pos (cm)	Table Pos (deg)	Remark
5403.44	48.76	-25.24	74	42.2	32.2	6.77	32.41	100	330	Peak
5468.24	40.23	-13.77	54	33.55	32.27	6.82	32.41	100	330	Average
5725.64	54.73	-19.27	74	47.66	32.57	7.02	32.52	100	330	Peak
5726.92	45.11	-8.89	54	38.03	32.57	7.03	32.52	100	330	Average

ANTENNA POLARITY : VERTICAL										
Frequency (MHz)	Level (dBμV/m)	Over Limit (dB)	Limit Line (dBμV/m)	Read Level (dBμV)	Antenna Factor (dB)	Cable Loss (dB)	Preamp Factor (dB)	Ant Pos (cm)	Table Pos (deg)	Remark
5385.04	49.16	-24.84	74	42.62	32.19	6.76	32.41	106	4	Peak
5467.92	40.47	-13.53	54	33.79	32.27	6.82	32.41	106	4	Average
5725	53.6	-20.4	74	46.53	32.57	7.02	32.52	106	4	Peak
5726.36	43.02	-10.98	54	35.95	32.57	7.02	32.52	106	4	Average



<WLAN Tx Mode with WPC Charging Mode>

Test Mode :	802.11n HT40	Temperature :	22~24°C
Test Channel :	62	Relative Humidity :	47~49%
Test Engineer :	Kyle Jhuang, Abi Lin and Derreck Chen		

ANTENNA POLARITY : HORIZONTAL										
Frequency (MHz)	Level (dBμV/m)	Over Limit (dB)	Limit Line (dBμV/m)	Read Level (dBμV)	Antenna Factor (dB)	Cable Loss (dB)	Preamp Factor (dB)	Ant Pos (cm)	Table Pos (deg)	Remark
5207.1	48.58	-25.42	74	42.28	32.01	6.69	32.4	103	297	Peak
5249.55	40.12	-13.88	54	33.76	32.05	6.71	32.4	103	297	Average
5351.43	60.48	-13.52	74	53.98	32.15	6.75	32.4	103	297	Peak
5350	49	-5	54	42.5	32.15	6.75	32.4	103	297	Average

ANTENNA POLARITY : VERTICAL										
Frequency (MHz)	Level (dBμV/m)	Over Limit (dB)	Limit Line (dBμV/m)	Read Level (dBμV)	Antenna Factor (dB)	Cable Loss (dB)	Preamp Factor (dB)	Ant Pos (cm)	Table Pos (deg)	Remark
5208.45	48.42	-25.58	74	42.12	32.01	6.69	32.4	100	236	Peak
5143.95	39.63	-14.37	54	33.47	31.94	6.62	32.4	100	236	Average
5352.64	56.73	-17.27	74	50.23	32.15	6.75	32.4	100	236	Peak
5350.44	47	-7	54	40.5	32.15	6.75	32.4	100	236	Average



3.5.6.2 Test Result of Unwanted Radiated Emission (30MHz ~ 10th Harmonic)

Test Mode :	802.11a	Temperature :	22~24°C
Test Channel :	36	Relative Humidity :	47~49%
Test Engineer :	Kyle Jhuang, Abi Lin and Derreck Chen	Polarization :	Horizontal
Remark :	1. 5182 MHz is fundamental signal which can be ignored. 2. 10359 MHz is not within a restricted band and satisfies both the average and peak limits of 15.209. 3. Average measurement was not performed if peak level went lower than the average limit.		

Frequency (MHz)	Level (dBμV/m)	Over Limit (dB)	Limit Line (dBμV/m)	Read Level (dBμV)	Antenna Factor (dB)	Cable Loss (dB)	Preamp Factor (dB)	Ant Pos (cm)	Table Pos (deg)	Remark
82.65	27.28	-12.72	40	45.44	9.2	0.73	28.09	100	58	Peak
148.26	17.51	-25.99	43.5	30.9	13.75	1	28.14	-	-	Peak
250.59	27.64	-18.36	46	42.13	12.42	1.26	28.17	-	-	Peak
342.7	29.49	-16.51	46	41.08	15.04	1.52	28.15	-	-	Peak
715.8	27.58	-18.42	46	31.47	21.55	2.23	27.67	-	-	Peak
842.5	29.12	-16.88	46	30.94	23.11	2.4	27.33	-	-	Peak
5182	92.05	-	-	85.8	31.98	6.67	32.4	108	155	Average
5182	97.3	-	-	91.05	31.98	6.67	32.4	108	155	Peak
10359	48.44	-25.56	74	31.52	40.03	11.04	34.15	100	0	Peak
15540	49.31	-24.69	74	31.39	39.18	13.25	34.51	100	0	Peak



Test Mode :	802.11a	Temperature :	22~24°C
Test Channel :	36	Relative Humidity :	47~49%
Test Engineer :	Kyle Jhuang, Abi Lin and Derreck Chen	Polarization :	Vertical
Remark :	1. 5182 MHz is fundamental signal which can be ignored. 2. 10359 MHz is not within a restricted band and satisfies both the average and peak limits of 15.209. 3. Average measurement was not performed if peak level went lower than the average limit.		

Frequency (MHz)	Level (dBµV/m)	Over Limit (dB)	Limit Line (dBµV/m)	Read Level (dBµV)	Antenna Factor (dB)	Cable Loss (dB)	Preamp Factor (dB)	Ant Pos (cm)	Table Pos (deg)	Remark
40.8	26.15	-13.85	40	39.71	13.86	0.58	28	100	133	Peak
95.07	24.4	-19.1	43.5	43.11	8.56	0.85	28.12	-	-	Peak
249.51	23.64	-22.36	46	38.16	12.39	1.26	28.17	-	-	Peak
461	26.73	-19.27	46	35.25	17.71	1.79	28.02	-	-	Peak
553.4	28.88	-17.12	46	35.99	18.9	1.9	27.91	-	-	Peak
930.7	30.78	-15.22	46	30.98	24.23	2.58	27.01	-	-	Peak
5182	97.36	-	-	91.11	31.98	6.67	32.4	101	16	Average
5182	104.48	-	-	98.25	31.97	6.66	32.4	101	16	Peak
10359	48.83	-25.17	74	31.91	40.03	11.04	34.15	100	0	Peak
15540	50.91	-23.09	74	32.99	39.18	13.25	34.51	100	0	Peak



Test Mode :	802.11a	Temperature :	22~24°C
Test Channel :	44	Relative Humidity :	47~49%
Test Engineer :	Kyle Jhuang, Abi Lin and Derreck Chen	Polarization :	Horizontal
Remark :	<ol style="list-style-type: none"> 5218 MHz is fundamental signal which can be ignored. 10440 MHz is not within a restricted band and satisfies both the average and peak limits of 15.209. Average measurement was not performed if peak level went lower than the average limit. 		

Frequency (MHz)	Level (dBμV/m)	Over Limit (dB)	Limit Line (dBμV/m)	Read Level (dBμV)	Antenna Factor (dB)	Cable Loss (dB)	Preamp Factor (dB)	Ant Pos (cm)	Table Pos (deg)	Remark
5218	90.43	-	-	84.11	32.02	6.7	32.4	109	153	Average
5218	97.93	-	-	91.61	32.02	6.7	32.4	109	153	Peak
10440	48.33	-25.67	74	31.17	40.13	11.24	34.21	100	0	Peak
15660	49.23	-24.77	74	31.61	38.82	13.33	34.53	100	0	Peak

Test Mode :	802.11a	Temperature :	22~24°C
Test Channel :	44	Relative Humidity :	47~49%
Test Engineer :	Kyle Jhuang, Abi Lin and Derreck Chen	Polarization :	Vertical
Remark :	<ol style="list-style-type: none"> 5222 MHz is fundamental signal which can be ignored. 10440 MHz is not within a restricted band and satisfies both the average and peak limits of 15.209. Average measurement was not performed if peak level went lower than the average limit. 		

Frequency (MHz)	Level (dBμV/m)	Over Limit (dB)	Limit Line (dBμV/m)	Read Level (dBμV)	Antenna Factor (dB)	Cable Loss (dB)	Preamp Factor (dB)	Ant Pos (cm)	Table Pos (deg)	Remark
5222	97.44	-	-	91.12	32.02	6.7	32.4	100	8	Average
5222	104.5	-	-	98.17	32.03	6.7	32.4	100	8	Peak
10440	50.31	-23.69	74	33.15	40.13	11.24	34.21	100	0	Peak
15561	50.82	-23.18	74	32.96	39.12	13.26	34.52	100	0	Peak



Test Mode :	802.11a	Temperature :	22~24°C
Test Channel :	48	Relative Humidity :	47~49%
Test Engineer :	Kyle Jhuang, Abi Lin and Derreck Chen	Polarization :	Horizontal
Remark :	<ol style="list-style-type: none"> 5238 MHz is fundamental signal which can be ignored. 10479 MHz is not within a restricted band and satisfies both the average and peak limits of 15.209. Average measurement was not performed if peak level went lower than the average limit. 		

Frequency (MHz)	Level (dBμV/m)	Over Limit (dB)	Limit Line (dBμV/m)	Read Level (dBμV)	Antenna Factor (dB)	Cable Loss (dB)	Preamp Factor (dB)	Ant Pos (cm)	Table Pos (deg)	Remark
5238	92.13	-	-	85.78	32.04	6.71	32.4	109	195	Average
5238	96.51	-	-	90.18	32.03	6.7	32.4	109	195	Peak
10479	50.71	-23.29	74	33.43	40.17	11.34	34.23	100	0	Peak
15720	48.81	-25.19	74	31.33	38.64	13.37	34.53	100	0	Peak

Test Mode :	802.11a	Temperature :	22~24°C
Test Channel :	48	Relative Humidity :	47~49%
Test Engineer :	Kyle Jhuang, Abi Lin and Derreck Chen	Polarization :	Vertical
Remark :	<ol style="list-style-type: none"> 5238 MHz is fundamental signal which can be ignored. 10479 MHz is not within a restricted band and satisfies both the average and peak limits of 15.209. Average measurement was not performed if peak level went lower than the average limit. 		

Frequency (MHz)	Level (dBμV/m)	Over Limit (dB)	Limit Line (dBμV/m)	Read Level (dBμV)	Antenna Factor (dB)	Cable Loss (dB)	Preamp Factor (dB)	Ant Pos (cm)	Table Pos (deg)	Remark
5238	97.45	-	-	91.1	32.04	6.71	32.4	100	342	Average
5238	103.63	-	-	97.28	32.04	6.71	32.4	100	342	Peak
10479	50.32	-23.68	74	33.04	40.17	11.34	34.23	100	0	Peak
15720	50.92	-23.08	74	33.44	38.64	13.37	34.53	100	0	Peak



Test Mode :	802.11a	Temperature :	22~24°C
Test Channel :	52	Relative Humidity :	47~49%
Test Engineer :	Kyle Jhuang, Abi Lin and Derreck Chen	Polarization :	Horizontal
Remark :	1. 5258 MHz is fundamental signal which can be ignored. 2. 10521 MHz is not within a restricted band and satisfies both the average and peak limits of 15.209. 3. Average measurement was not performed if peak level went lower than the average limit.		

Frequency (MHz)	Level (dBμV/m)	Over Limit (dB)	Limit Line (dBμV/m)	Read Level (dBμV)	Antenna Factor (dB)	Cable Loss (dB)	Preamp Factor (dB)	Ant Pos (cm)	Table Pos (deg)	Remark
5258	92.88	-	-	86.51	32.06	6.71	32.4	105	33	Average
5258	99.82	-	-	93.45	32.06	6.71	32.4	105	33	Peak
10521	49.5	-24.5	74	32.13	40.23	11.4	34.26	100	0	Peak
15780	48.51	-25.49	74	31.17	38.46	13.42	34.54	100	0	Peak

Test Mode :	802.11a	Temperature :	22~24°C
Test Channel :	52	Relative Humidity :	47~49%
Test Engineer :	Kyle Jhuang, Abi Lin and Derreck Chen	Polarization :	Vertical
Remark :	1. 5258 MHz is fundamental signal which can be ignored. 2. 10521 MHz is not within a restricted band and satisfies both the average and peak limits of 15.209. 3. Average measurement was not performed if peak level went lower than the average limit.		

Frequency (MHz)	Level (dBμV/m)	Over Limit (dB)	Limit Line (dBμV/m)	Read Level (dBμV)	Antenna Factor (dB)	Cable Loss (dB)	Preamp Factor (dB)	Ant Pos (cm)	Table Pos (deg)	Remark
5258	98.16	-	-	91.79	32.06	6.71	32.4	100	11	Average
5258	104.72	-	-	98.35	32.06	6.71	32.4	100	11	Peak
10521	49.88	-24.12	74	32.51	40.23	11.4	34.26	100	0	Peak
15780	50.49	-23.51	74	33.15	38.46	13.42	34.54	100	0	Peak



Test Mode :	802.11a	Temperature :	22~24°C
Test Channel :	60	Relative Humidity :	47~49%
Test Engineer :	Kyle Jhuang, Abi Lin and Derreck Chen	Polarization :	Horizontal
Remark :	1. 5298 MHz is fundamental signal which can be ignored. 2. 10599 MHz is not within a restricted band and satisfies both the average and peak limits of 15.209. 3. Average measurement was not performed if peak level went lower than the average limit.		

Frequency (MHz)	Level (dBμV/m)	Over Limit (dB)	Limit Line (dBμV/m)	Read Level (dBμV)	Antenna Factor (dB)	Cable Loss (dB)	Preamp Factor (dB)	Ant Pos (cm)	Table Pos (deg)	Remark
5298	93.44	-	-	87.01	32.1	6.73	32.4	106	33	Average
5298	99.77	-	-	93.34	32.1	6.73	32.4	106	33	Peak
10599	50.17	-23.83	74	32.7	40.32	11.44	34.29	100	0	Peak
15900	50.1	-23.9	74	33.05	38.1	13.5	34.55	100	0	Peak

Test Mode :	802.11a	Temperature :	22~24°C
Test Channel :	60	Relative Humidity :	47~49%
Test Engineer :	Kyle Jhuang, Abi Lin and Derreck Chen	Polarization :	Vertical
Remark :	1. 5298 MHz is fundamental signal which can be ignored. 2. 10599 MHz is not within a restricted band and satisfies both the average and peak limits of 15.209. 3. Average measurement was not performed if peak level went lower than the average limit.		

Frequency (MHz)	Level (dBμV/m)	Over Limit (dB)	Limit Line (dBμV/m)	Read Level (dBμV)	Antenna Factor (dB)	Cable Loss (dB)	Preamp Factor (dB)	Ant Pos (cm)	Table Pos (deg)	Remark
5298	98.9	-	-	92.47	32.1	6.73	32.4	100	339	Average
5298	105.82	-	-	99.39	32.1	6.73	32.4	100	339	Peak
10599	50.52	-23.48	74	33.05	40.32	11.44	34.29	100	0	Peak
15900	49.29	-24.71	74	32.24	38.1	13.5	34.55	100	0	Peak



Test Mode :	802.11a	Temperature :	22~24°C
Test Channel :	64	Relative Humidity :	47~49%
Test Engineer :	Kyle Jhuang, Abi Lin and Derreck Chen	Polarization :	Horizontal
Remark :	1. 5318 MHz is fundamental signal which can be ignored. 2. Average measurement was not performed if peak level went lower than the average limit.		

Frequency (MHz)	Level (dBμV/m)	Over Limit (dB)	Limit Line (dBμV/m)	Read Level (dBμV)	Antenna Factor (dB)	Cable Loss (dB)	Preamp Factor (dB)	Ant Pos (cm)	Table Pos (deg)	Remark
46.47	19.52	-20.48	40	32.67	14.26	0.59	28	-	-	Peak
147.18	17.2	-26.3	43.5	30.62	13.72	1	28.14	-	-	Peak
282.72	25.15	-20.85	46	38.23	13.75	1.35	28.18	-	-	Peak
456.8	22.59	-23.41	46	31.17	17.67	1.78	28.03	-	-	Peak
671.7	26.44	-19.56	46	31.09	20.85	2.24	27.74	-	-	Peak
927.2	29.16	-16.84	46	29.43	24.18	2.58	27.03	100	47	Peak
5318	91.76	-	-	85.3	32.12	6.74	32.4	104	32	Average
5318	98.7	-	-	92.24	32.12	6.74	32.4	104	32	Peak
10641	49.09	-24.91	74	31.57	40.37	11.46	34.31	100	0	Peak
15960	48	-26	74	31.1	37.92	13.54	34.56	100	0	Peak



Test Mode :	802.11a	Temperature :	22~24°C
Test Channel :	64	Relative Humidity :	47~49%
Test Engineer :	Kyle Jhuang, Abi Lin and Derreck Chen	Polarization :	Vertical
Remark :	1. 5318 MHz is fundamental signal which can be ignored. 2. Average measurement was not performed if peak level went lower than the average limit.		

Frequency (MHz)	Level (dBμV/m)	Over Limit (dB)	Limit Line (dBμV/m)	Read Level (dBμV)	Antenna Factor (dB)	Cable Loss (dB)	Preamp Factor (dB)	Ant Pos (cm)	Table Pos (deg)	Remark
34.05	26.61	-13.39	40	40.65	13.52	0.43	27.99	100	165	Peak
62.67	24	-16	40	38.09	13.29	0.66	28.04	-	-	Peak
297.84	26.46	-19.54	46	39.19	14.06	1.39	28.18	-	-	Peak
461	27.45	-18.55	46	35.97	17.71	1.79	28.02	-	-	Peak
559.7	28.4	-17.6	46	35.31	19.07	1.92	27.9	-	-	Peak
914.6	30.48	-15.52	46	30.98	24	2.57	27.07	-	-	Peak
5318	98.4	-	-	91.94	32.12	6.74	32.4	100	340	Average
5318	105.37	-	-	98.91	32.12	6.74	32.4	100	340	Peak
10641	50.34	-23.66	74	32.82	40.37	11.46	34.31	100	0	Peak
15960	49.93	-24.07	74	33.03	37.92	13.54	34.56	100	0	Peak



Test Mode :	802.11a	Temperature :	22~24°C
Test Channel :	100	Relative Humidity :	47~49%
Test Engineer :	Kyle Jhuang, Abi Lin and Derreck Chen	Polarization :	Horizontal
Remark :	<ol style="list-style-type: none"> 5502 MHz is fundamental signal which can be ignored. 16500 MHz is not within a restricted band and satisfies both the average and peak limits of 15.209. Average measurement was not performed if peak level went lower than the average limit. 		

Frequency (MHz)	Level (dBμV/m)	Over Limit (dB)	Limit Line (dBμV/m)	Read Level (dBμV)	Antenna Factor (dB)	Cable Loss (dB)	Preamp Factor (dB)	Ant Pos (cm)	Table Pos (deg)	Remark
71.85	32.35	-7.65	40	48.22	11.47	0.72	28.06	100	75	Peak
83.19	27.91	-12.09	40	46.14	9.12	0.74	28.09	-	-	Peak
292.71	26.53	-19.47	46	39.38	13.95	1.38	28.18	-	-	Peak
579.3	24.18	-21.82	46	30.45	19.62	1.98	27.87	-	-	Peak
747.3	26.71	-19.29	46	30.01	22.06	2.24	27.6	-	-	Peak
899.9	30.3	-15.7	46	31.07	23.8	2.56	27.13	-	-	Peak
5502	91.48	-	-	84.74	32.3	6.85	32.41	111	326	Average
5502	98.1	-	-	91.36	32.3	6.85	32.41	111	326	Peak
11001	49.81	-24.19	74	31.84	40.8	11.64	34.47	100	0	Peak
16500	49.13	-24.87	74	30.82	39	13.93	34.62	100	0	Peak



Test Mode :	802.11a	Temperature :	22~24°C
Test Channel :	100	Relative Humidity :	47~49%
Test Engineer :	Kyle Jhuang, Abi Lin and Derreck Chen	Polarization :	Vertical
Remark :	1. 5502 MHz is fundamental signal which can be ignored. 2. 16500 MHz is not within a restricted band and satisfies both the average and peak limits of 15.209. 3. Average measurement was not performed if peak level went lower than the average limit.		

Frequency (MHz)	Level (dBµV/m)	Over Limit (dB)	Limit Line (dBµV/m)	Read Level (dBµV)	Antenna Factor (dB)	Cable Loss (dB)	Preamp Factor (dB)	Ant Pos (cm)	Table Pos (deg)	Remark
62.13	24.91	-15.09	40	38.9	13.4	0.65	28.04	-	-	Peak
117.75	20.24	-23.26	43.5	36.17	11.32	0.89	28.14	-	-	Peak
217.65	16.95	-29.05	46	32.97	10.95	1.19	28.16	-	-	Peak
492.5	26.45	-19.55	46	34.6	18.02	1.81	27.98	-	-	Peak
573	27.89	-18.11	46	34.37	19.44	1.96	27.88	-	-	Peak
957.3	31.57	-14.43	46	31.33	24.53	2.62	26.91	100	155	Peak
5502	95.63	-	-	88.89	32.3	6.85	32.41	105	41	Average
5502	103.39	-	-	96.65	32.3	6.85	32.41	105	41	Peak
11001	50.15	-23.85	74	32.18	40.8	11.64	34.47	100	0	Peak
16500	50.54	-23.46	74	32.23	39	13.93	34.62	100	0	Peak



Test Mode :	802.11a	Temperature :	22~24°C
Test Channel :	116	Relative Humidity :	47~49%
Test Engineer :	Kyle Jhuang, Abi Lin and Derreck Chen	Polarization :	Horizontal
Remark :	<ol style="list-style-type: none"> 5578 MHz is fundamental signal which can be ignored. 16740 MHz is not within a restricted band and satisfies both the average and peak limits of 15.209. Average measurement was not performed if peak level went lower than the average limit. 		

Frequency (MHz)	Level (dBμV/m)	Over Limit (dB)	Limit Line (dBμV/m)	Read Level (dBμV)	Antenna Factor (dB)	Cable Loss (dB)	Preamp Factor (dB)	Ant Pos (cm)	Table Pos (deg)	Remark
5578	91.59	-	-	84.74	32.39	6.91	32.45	100	6	Average
5578	98.99	-	-	92.14	32.39	6.91	32.45	100	6	Peak
11160	49.34	-24.66	74	31.62	40.61	11.6	34.49	100	0	Peak
16740	49.08	-24.92	74	30.91	39.19	13.68	34.7	100	0	Peak

Test Mode :	802.11a	Temperature :	22~24°C
Test Channel :	116	Relative Humidity :	47~49%
Test Engineer :	Kyle Jhuang, Abi Lin and Derreck Chen	Polarization :	Vertical
Remark :	<ol style="list-style-type: none"> 5582 MHz is fundamental signal which can be ignored. 16740 MHz is not within a restricted band and satisfies both the average and peak limits of 15.209. Average measurement was not performed if peak level went lower than the average limit. 		

Frequency (MHz)	Level (dBμV/m)	Over Limit (dB)	Limit Line (dBμV/m)	Read Level (dBμV)	Antenna Factor (dB)	Cable Loss (dB)	Preamp Factor (dB)	Ant Pos (cm)	Table Pos (deg)	Remark
5582	97.97	-	-	91.1	32.4	6.92	32.45	104	24	Average
5582	103.71	-	-	96.84	32.4	6.92	32.45	104	24	Peak
11160	49.97	-24.03	74	32.25	40.61	11.6	34.49	100	0	Peak
16740	50.07	-23.93	74	31.9	39.19	13.68	34.7	100	0	Peak



Test Mode :	802.11a	Temperature :	22~24°C
Test Channel :	140	Relative Humidity :	47~49%
Test Engineer :	Kyle Jhuang, Abi Lin and Derreck Chen	Polarization :	Horizontal
Remark :	1. 5702 MHz is fundamental signal which can be ignored. 2. 17100 MHz is not within a restricted band and satisfies both the average and peak limits of 15.209. 3. Average measurement was not performed if peak level went lower than the average limit.		

Frequency (MHz)	Level (dBμV/m)	Over Limit (dB)	Limit Line (dBμV/m)	Read Level (dBμV)	Antenna Factor (dB)	Cable Loss (dB)	Preamp Factor (dB)	Ant Pos (cm)	Table Pos (deg)	Remark
5702	91.59	-	-	84.55	32.54	7.01	32.51	108	11	Average
5702	97.29	-	-	90.25	32.54	7.01	32.51	108	11	Peak
11400	48.51	-25.49	74	31.15	40.32	11.55	34.51	100	0	Peak
17100	50.24	-23.76	74	31.76	39.68	13.56	34.76	100	0	Peak

Test Mode :	802.11a	Temperature :	22~24°C
Test Channel :	140	Relative Humidity :	47~49%
Test Engineer :	Kyle Jhuang, Abi Lin and Derreck Chen	Polarization :	Vertical
Remark :	1. 5698 MHz is fundamental signal which can be ignored. 2. 17100 MHz is not within a restricted band and satisfies both the average and peak limits of 15.209. 3. Average measurement was not performed if peak level went lower than the average limit.		

Frequency (MHz)	Level (dBμV/m)	Over Limit (dB)	Limit Line (dBμV/m)	Read Level (dBμV)	Antenna Factor (dB)	Cable Loss (dB)	Preamp Factor (dB)	Ant Pos (cm)	Table Pos (deg)	Remark
5698	94.04	-	-	87.01	32.54	7	32.51	102	26	Average
5698	100.59	-	-	93.55	32.54	7	32.5	102	26	Peak
11400	50.32	-23.68	74	32.96	40.32	11.55	34.51	100	0	Peak
17100	52.15	-21.85	74	33.67	39.68	13.56	34.76	100	0	Peak



Test Mode :	802.11n HT20	Temperature :	22~24°C
Test Channel :	36	Relative Humidity :	47~49%
Test Engineer :	Kyle Jhuang, Abi Lin and Derreck Chen	Polarization :	Horizontal
Remark :	1. 5182 MHz is fundamental signal which can be ignored. 2. 10359 MHz is not within a restricted band and satisfies both the average and peak limits of 15.209. 3. Average measurement was not performed if peak level went lower than the average limit.		

Frequency (MHz)	Level (dBμV/m)	Over Limit (dB)	Limit Line (dBμV/m)	Read Level (dBμV)	Antenna Factor (dB)	Cable Loss (dB)	Preamp Factor (dB)	Ant Pos (cm)	Table Pos (deg)	Remark
75.09	24.37	-15.63	40	40.98	10.73	0.73	28.07	100	65	Peak
141.51	17.44	-26.06	43.5	31.02	13.55	1.01	28.14	-	-	Peak
250.59	21.5	-24.5	46	35.99	12.42	1.26	28.17	-	-	Peak
475	22.32	-23.68	46	30.68	17.85	1.79	28	-	-	Peak
649.3	26.64	-19.36	46	31.67	20.5	2.25	27.78	-	-	Peak
881.7	29.67	-16.33	46	30.78	23.58	2.5	27.19	-	-	Peak
5182	91.53	-	-	85.28	31.98	6.67	32.4	107	31	Average
5182	98.2	-	-	91.95	31.98	6.67	32.4	107	31	Peak
10359	46.63	-27.37	74	29.71	40.03	11.04	34.15	100	0	Peak
15540	48.74	-25.26	74	30.82	39.18	13.25	34.51	100	0	Peak



Test Mode :	802.11n HT20	Temperature :	22~24°C
Test Channel :	36	Relative Humidity :	47~49%
Test Engineer :	Kyle Jhuang, Abi Lin and Derreck Chen	Polarization :	Vertical
Remark :	1. 5178 MHz is fundamental signal which can be ignored. 2. 10359 MHz is not within a restricted band and satisfies both the average and peak limits of 15.209. 3. Average measurement was not performed if peak level went lower than the average limit.		

Frequency (MHz)	Level (dBμV/m)	Over Limit (dB)	Limit Line (dBμV/m)	Read Level (dBμV)	Antenna Factor (dB)	Cable Loss (dB)	Preamp Factor (dB)	Ant Pos (cm)	Table Pos (deg)	Remark
63.21	25.51	-14.49	40	39.7	13.19	0.66	28.04	100	199	Peak
117.75	21.59	-21.91	43.5	37.52	11.32	0.89	28.14	-	-	Peak
275.43	17.68	-28.32	46	31.06	13.47	1.33	28.18	-	-	Peak
467.3	25.23	-20.77	46	33.69	17.77	1.79	28.02	-	-	Peak
553.4	28.35	-17.65	46	35.46	18.9	1.9	27.91	-	-	Peak
862.8	29.25	-16.75	46	30.72	23.35	2.44	27.26	-	-	Peak
5178	96.73	-	-	90.49	31.98	6.66	32.4	100	12	Average
5178	103.65	-	-	97.41	31.98	6.66	32.4	100	12	Peak
10359	47.94	-26.06	74	31.02	40.03	11.04	34.15	100	0	Peak
15540	46.35	-27.65	74	28.43	39.18	13.25	34.51	100	0	Peak



Test Mode :	802.11n HT20	Temperature :	22~24°C
Test Channel :	44	Relative Humidity :	47~49%
Test Engineer :	Kyle Jhuang, Abi Lin and Derreck Chen	Polarization :	Horizontal
Remark :	1. 5222 MHz is fundamental signal which can be ignored. 2. 10440 MHz is not within a restricted band and satisfies both the average and peak limits of 15.209. 3. Average measurement was not performed if peak level went lower than the average limit.		

Frequency (MHz)	Level (dBμV/m)	Over Limit (dB)	Limit Line (dBμV/m)	Read Level (dBμV)	Antenna Factor (dB)	Cable Loss (dB)	Preamp Factor (dB)	Ant Pos (cm)	Table Pos (deg)	Remark
5222	91.63	-	-	85.31	32.02	6.7	32.4	108	31	Average
5222	98.33	-	-	92.01	32.02	6.7	32.4	108	31	Peak
10440	47.12	-26.88	74	29.96	40.13	11.24	34.21	100	0	Peak
15561	49.03	-24.97	74	31.17	39.12	13.26	34.52	100	0	Peak

Test Mode :	802.11n HT20	Temperature :	22~24°C
Test Channel :	44	Relative Humidity :	47~49%
Test Engineer :	Kyle Jhuang, Abi Lin and Derreck Chen	Polarization :	Vertical
Remark :	1. 5222 MHz is fundamental signal which can be ignored. 2. 10440 MHz is not within a restricted band and satisfies both the average and peak limits of 15.209. 3. Average measurement was not performed if peak level went lower than the average limit.		

Frequency (MHz)	Level (dBμV/m)	Over Limit (dB)	Limit Line (dBμV/m)	Read Level (dBμV)	Antenna Factor (dB)	Cable Loss (dB)	Preamp Factor (dB)	Ant Pos (cm)	Table Pos (deg)	Remark
5222	97.03	-	-	90.71	32.02	6.7	32.4	100	10	Average
5222	104.06	-	-	97.74	32.02	6.7	32.4	100	10	Peak
10440	47.82	-26.18	74	30.66	40.13	11.24	34.21	100	0	Peak
15660	47.93	-26.07	74	30.31	38.82	13.33	34.53	100	0	Peak



Test Mode :	802.11n HT20	Temperature :	22~24°C
Test Channel :	48	Relative Humidity :	47~49%
Test Engineer :	Kyle Jhuang, Abi Lin and Derreck Chen	Polarization :	Horizontal
Remark :	1. 5242 MHz is fundamental signal which can be ignored. 2. 10479 MHz is not within a restricted band and satisfies both the average and peak limits of 15.209. 3. Average measurement was not performed if peak level went lower than the average limit.		

Frequency (MHz)	Level (dBμV/m)	Over Limit (dB)	Limit Line (dBμV/m)	Read Level (dBμV)	Antenna Factor (dB)	Cable Loss (dB)	Preamp Factor (dB)	Ant Pos (cm)	Table Pos (deg)	Remark
5242	92.85	-	-	86.5	32.04	6.71	32.4	107	29	Average
5242	99.4	-	-	93.05	32.04	6.71	32.4	107	29	Peak
10479	47.57	-26.43	74	30.29	40.17	11.34	34.23	100	0	Peak
15720	48.33	-25.67	74	30.85	38.64	13.37	34.53	100	0	Peak

Test Mode :	802.11n HT20	Temperature :	22~24°C
Test Channel :	48	Relative Humidity :	47~49%
Test Engineer :	Kyle Jhuang, Abi Lin and Derreck Chen	Polarization :	Vertical
Remark :	1. 5242 MHz is fundamental signal which can be ignored. 2. 10479 MHz is not within a restricted band and satisfies both the average and peak limits of 15.209. 3. Average measurement was not performed if peak level went lower than the average limit.		

Frequency (MHz)	Level (dBμV/m)	Over Limit (dB)	Limit Line (dBμV/m)	Read Level (dBμV)	Antenna Factor (dB)	Cable Loss (dB)	Preamp Factor (dB)	Ant Pos (cm)	Table Pos (deg)	Remark
5242	98.16	-	-	91.81	32.04	6.71	32.4	100	346	Average
5242	104.79	-	-	98.44	32.04	6.71	32.4	100	346	Peak
10479	49.35	-24.65	74	32.07	40.17	11.34	34.23	100	0	Peak
15720	46.26	-27.74	74	28.78	38.64	13.37	34.53	100	0	Peak



Test Mode :	802.11n HT20	Temperature :	22~24°C
Test Channel :	52	Relative Humidity :	47~49%
Test Engineer :	Kyle Jhuang, Abi Lin and Derreck Chen	Polarization :	Horizontal
Remark :	1. 5258 MHz is fundamental signal which can be ignored. 2. 10521 MHz is not within a restricted band and satisfies both the average and peak limits of 15.209. 3. Average measurement was not performed if peak level went lower than the average limit.		

Frequency (MHz)	Level (dBμV/m)	Over Limit (dB)	Limit Line (dBμV/m)	Read Level (dBμV)	Antenna Factor (dB)	Cable Loss (dB)	Preamp Factor (dB)	Ant Pos (cm)	Table Pos (deg)	Remark
5258	91.38	-	-	85.01	32.06	6.71	32.4	106	28	Average
5258	98.47	-	-	92.1	32.06	6.71	32.4	106	28	Peak
10521	48.13	-25.87	74	30.76	40.23	11.4	34.26	100	0	Peak
15780	47.12	-26.88	74	29.78	38.46	13.42	34.54	100	0	Peak

Test Mode :	802.11n HT20	Temperature :	22~24°C
Test Channel :	52	Relative Humidity :	47~49%
Test Engineer :	Kyle Jhuang, Abi Lin and Derreck Chen	Polarization :	Vertical
Remark :	1. 5258 MHz is fundamental signal which can be ignored. 2. 10521 MHz is not within a restricted band and satisfies both the average and peak limits of 15.209. 3. Average measurement was not performed if peak level went lower than the average limit.		

Frequency (MHz)	Level (dBμV/m)	Over Limit (dB)	Limit Line (dBμV/m)	Read Level (dBμV)	Antenna Factor (dB)	Cable Loss (dB)	Preamp Factor (dB)	Ant Pos (cm)	Table Pos (deg)	Remark
5258	96.93	-	-	90.56	32.06	6.71	32.4	100	336	Average
5258	103.8	-	-	97.43	32.06	6.71	32.4	100	336	Peak
10521	49.28	-24.72	74	31.91	40.23	11.4	34.26	100	0	Peak
15780	44.92	-29.08	74	27.58	38.46	13.42	34.54	100	0	Peak



Test Mode :	802.11n HT20	Temperature :	22~24°C
Test Channel :	60	Relative Humidity :	47~49%
Test Engineer :	Kyle Jhuang, Abi Lin and Derreck Chen	Polarization :	Horizontal
Remark :	1. 5302 MHz is fundamental signal which can be ignored. 2. 10599 MHz is not within a restricted band and satisfies both the average and peak limits of 15.209. 3. Average measurement was not performed if peak level went lower than the average limit.		

Frequency (MHz)	Level (dBμV/m)	Over Limit (dB)	Limit Line (dBμV/m)	Read Level (dBμV)	Antenna Factor (dB)	Cable Loss (dB)	Preamp Factor (dB)	Ant Pos (cm)	Table Pos (deg)	Remark
5302	91.72	-	-	85.29	32.1	6.73	32.4	116	30	Average
5302	98.16	-	-	91.73	32.1	6.73	32.4	116	30	Peak
10599	47.8	-26.2	74	30.33	40.32	11.44	34.29	100	0	Peak
15900	48.34	-25.66	74	31.29	38.1	13.5	34.55	100	0	Peak

Test Mode :	802.11n HT20	Temperature :	22~24°C
Test Channel :	60	Relative Humidity :	47~49%
Test Engineer :	Kyle Jhuang, Abi Lin and Derreck Chen	Polarization :	Vertical
Remark :	1. 5302 MHz is fundamental signal which can be ignored. 2. 10599 MHz is not within a restricted band and satisfies both the average and peak limits of 15.209. 3. Average measurement was not performed if peak level went lower than the average limit.		

Frequency (MHz)	Level (dBμV/m)	Over Limit (dB)	Limit Line (dBμV/m)	Read Level (dBμV)	Antenna Factor (dB)	Cable Loss (dB)	Preamp Factor (dB)	Ant Pos (cm)	Table Pos (deg)	Remark
5302	97.91	-	-	91.48	32.1	6.73	32.4	100	336	Average
5302	104.51	-	-	98.08	32.1	6.73	32.4	100	336	Peak
10599	49.44	-24.56	74	31.97	40.32	11.44	34.29	100	0	Peak
15900	45.33	-28.67	74	28.28	38.1	13.5	34.55	100	0	Peak



Test Mode :	802.11n HT20	Temperature :	22~24°C
Test Channel :	64	Relative Humidity :	47~49%
Test Engineer :	Kyle Jhuang, Abi Lin and Derreck Chen	Polarization :	Horizontal
Remark :	1. 5318 MHz is fundamental signal which can be ignored. 2. Average measurement was not performed if peak level went lower than the average limit.		

Frequency (MHz)	Level (dBμV/m)	Over Limit (dB)	Limit Line (dBμV/m)	Read Level (dBμV)	Antenna Factor (dB)	Cable Loss (dB)	Preamp Factor (dB)	Ant Pos (cm)	Table Pos (deg)	Remark
71.85	28.82	-11.18	40	44.69	11.47	0.72	28.06	100	25	Peak
122.61	20.77	-22.73	43.5	36.24	11.76	0.91	28.14	-	-	Peak
297.3	26	-20	46	38.74	14.05	1.39	28.18	-	-	Peak
304.2	28.03	-17.97	46	40.61	14.19	1.41	28.18	-	-	Peak
675.2	27.48	-18.52	46	32.09	20.9	2.23	27.74	-	-	Peak
902	29.3	-16.7	46	30.03	23.83	2.56	27.12	-	-	Peak
5318	92.26	-	-	85.8	32.12	6.74	32.4	104	25	Average
5318	98.9	-	-	92.44	32.12	6.74	32.4	104	25	Peak
10641	47.38	-26.62	74	29.86	40.37	11.46	34.31	100	0	Peak
15960	48.06	-25.94	74	31.16	37.92	13.54	34.56	100	0	Peak



Test Mode :	802.11n HT20	Temperature :	22~24°C
Test Channel :	64	Relative Humidity :	47~49%
Test Engineer :	Kyle Jhuang, Abi Lin and Derreck Chen	Polarization :	Vertical
Remark :	1. 5318 MHz is fundamental signal which can be ignored. 2. Average measurement was not performed if peak level went lower than the average limit.		

Frequency (MHz)	Level (dBμV/m)	Over Limit (dB)	Limit Line (dBμV/m)	Read Level (dBμV)	Antenna Factor (dB)	Cable Loss (dB)	Preamp Factor (dB)	Ant Pos (cm)	Table Pos (deg)	Remark
47.01	27.09	-12.91	40	40.22	14.28	0.59	28	100	67	Peak
120.18	22.03	-21.47	43.5	37.75	11.52	0.9	28.14	-	-	Peak
273	27.58	-18.42	46	41.08	13.35	1.32	28.17	-	-	Peak
463.8	26.93	-19.07	46	35.42	17.74	1.79	28.02	-	-	Peak
563.2	28.28	-17.72	46	35.07	19.17	1.93	27.89	-	-	Peak
957.3	32.26	-13.74	46	32.02	24.53	2.62	26.91	-	-	Peak
5318	98.51	-	-	92.05	32.12	6.74	32.4	100	347	Average
5318	105.43	-	-	98.97	32.12	6.74	32.4	100	347	Peak
10641	49.42	-24.58	74	31.9	40.37	11.46	34.31	100	0	Peak
15960	46.94	-27.06	74	30.04	37.92	13.54	34.56	100	0	Peak



Test Mode :	802.11n HT20	Temperature :	22~24°C
Test Channel :	100	Relative Humidity :	47~49%
Test Engineer :	Kyle Jhuang, Abi Lin and Derreck Chen	Polarization :	Horizontal
Remark :	1. 5502 MHz is fundamental signal which can be ignored. 2. 16500 MHz is not within a restricted band and satisfies both the average and peak limits of 15.209. 3. Average measurement was not performed if peak level went lower than the average limit.		

Frequency (MHz)	Level (dBμV/m)	Over Limit (dB)	Limit Line (dBμV/m)	Read Level (dBμV)	Antenna Factor (dB)	Cable Loss (dB)	Preamp Factor (dB)	Ant Pos (cm)	Table Pos (deg)	Remark
5502	92.11	-	-	85.37	32.3	6.85	32.41	100	9	Average
5502	99.63	-	-	92.89	32.3	6.85	32.41	100	9	Peak
11001	47.64	-26.36	74	29.67	40.8	11.64	34.47	100	0	Peak
16500	49.41	-24.59	74	31.1	39	13.93	34.62	100	0	Peak

Test Mode :	802.11n HT20	Temperature :	22~24°C
Test Channel :	100	Relative Humidity :	47~49%
Test Engineer :	Kyle Jhuang, Abi Lin and Derreck Chen	Polarization :	Vertical
Remark :	1. 5502 MHz is fundamental signal which can be ignored. 2. 16500 MHz is not within a restricted band and satisfies both the average and peak limits of 15.209. 3. Average measurement was not performed if peak level went lower than the average limit.		

Frequency (MHz)	Level (dBμV/m)	Over Limit (dB)	Limit Line (dBμV/m)	Read Level (dBμV)	Antenna Factor (dB)	Cable Loss (dB)	Preamp Factor (dB)	Ant Pos (cm)	Table Pos (deg)	Remark
5502	94.76	-	-	88.02	32.3	6.85	32.41	100	72	Average
5502	102.12	-	-	95.38	32.3	6.85	32.41	100	72	Peak
11001	49.91	-24.09	74	31.94	40.8	11.64	34.47	100	0	Peak
16500	46.43	-27.57	74	28.12	39	13.93	34.62	100	0	Peak



Test Mode :	802.11n HT20	Temperature :	22~24°C
Test Channel :	116	Relative Humidity :	47~49%
Test Engineer :	Kyle Jhuang, Abi Lin and Derreck Chen	Polarization :	Horizontal
Remark :	1. 5578 MHz is fundamental signal which can be ignored. 2. 16740 MHz is not within a restricted band and satisfies both the average and peak limits of 15.209. 3. Average measurement was not performed if peak level went lower than the average limit.		

Frequency (MHz)	Level (dBμV/m)	Over Limit (dB)	Limit Line (dBμV/m)	Read Level (dBμV)	Antenna Factor (dB)	Cable Loss (dB)	Preamp Factor (dB)	Ant Pos (cm)	Table Pos (deg)	Remark
5578	93.52	-	-	86.67	32.39	6.91	32.45	100	7	Average
5578	99.66	-	-	92.81	32.39	6.91	32.45	100	7	Peak
11160	48.34	-25.66	74	30.62	40.61	11.6	34.49	100	0	Peak
16740	48.37	-25.63	74	30.2	39.19	13.68	34.7	100	0	Peak

Test Mode :	802.11n HT20	Temperature :	22~24°C
Test Channel :	116	Relative Humidity :	47~49%
Test Engineer :	Kyle Jhuang, Abi Lin and Derreck Chen	Polarization :	Vertical
Remark :	1. 5582 MHz is fundamental signal which can be ignored. 2. 16740 MHz is not within a restricted band and satisfies both the average and peak limits of 15.209. 3. Average measurement was not performed if peak level went lower than the average limit.		

Frequency (MHz)	Level (dBμV/m)	Over Limit (dB)	Limit Line (dBμV/m)	Read Level (dBμV)	Antenna Factor (dB)	Cable Loss (dB)	Preamp Factor (dB)	Ant Pos (cm)	Table Pos (deg)	Remark
5582	94.41	-	-	87.54	32.4	6.92	32.45	100	72	Average
5582	101.83	-	-	94.96	32.4	6.92	32.45	100	72	Peak
11160	48.74	-25.26	74	31.02	40.61	11.6	34.49	100	0	Peak
16740	46.25	-27.75	74	28.08	39.19	13.68	34.7	100	0	Peak



Test Mode :	802.11n HT20	Temperature :	22~24°C
Test Channel :	140	Relative Humidity :	47~49%
Test Engineer :	Kyle Jhuang, Abi Lin and Derreck Chen	Polarization :	Horizontal
Remark :	1. 5702 MHz is fundamental signal which can be ignored. 2. 17100 MHz is not within a restricted band and satisfies both the average and peak limits of 15.209. 3. Average measurement was not performed if peak level went lower than the average limit.		

Frequency (MHz)	Level (dBμV/m)	Over Limit (dB)	Limit Line (dBμV/m)	Read Level (dBμV)	Antenna Factor (dB)	Cable Loss (dB)	Preamp Factor (dB)	Ant Pos (cm)	Table Pos (deg)	Remark
68.07	30.34	-9.66	40	45.43	12.27	0.69	28.05	100	65	Peak
81.84	29.7	-10.3	40	47.75	9.32	0.72	28.09	-	-	Peak
296.49	34.29	-11.71	46	47.05	14.03	1.39	28.18	-	-	Peak
480.6	23.54	-22.46	46	31.83	17.91	1.8	28	-	-	Peak
596.8	25.96	-20.04	46	31.66	20.11	2.04	27.85	-	-	Peak
832.7	34.13	-11.87	46	36.12	22.99	2.39	27.37	-	-	Peak
5702	92.72	-	-	85.68	32.54	7.01	32.51	100	8	Average
5702	99.31	-	-	92.27	32.54	7.01	32.51	100	8	Peak
11400	47.42	-26.58	74	30.06	40.32	11.55	34.51	100	0	Peak
17100	50.6	-23.4	74	32.12	39.68	13.56	34.76	100	0	Peak



Test Mode :	802.11n HT20	Temperature :	22~24°C
Test Channel :	140	Relative Humidity :	47~49%
Test Engineer :	Kyle Jhuang, Abi Lin and Derreck Chen	Polarization :	Vertical
Remark :	1. 5698 MHz is fundamental signal which can be ignored. 2. 17100 MHz is not within a restricted band and satisfies both the average and peak limits of 15.209. 3. Average measurement was not performed if peak level went lower than the average limit.		

Frequency (MHz)	Level (dBμV/m)	Over Limit (dB)	Limit Line (dBμV/m)	Read Level (dBμV)	Antenna Factor (dB)	Cable Loss (dB)	Preamp Factor (dB)	Ant Pos (cm)	Table Pos (deg)	Remark
30	25.34	-14.66	40	39.32	13.6	0.41	27.99	100	166	Peak
96.69	23.59	-19.91	43.5	42.16	8.7	0.85	28.12	-	-	Peak
219	18.1	-27.9	46	34.09	10.98	1.19	28.16	-	-	Peak
470.1	26.75	-19.25	46	35.17	17.8	1.79	28.01	-	-	Peak
556.9	28.84	-17.16	46	35.84	18.99	1.91	27.9	-	-	Peak
876.1	29.53	-16.47	46	30.75	23.51	2.48	27.21	-	-	Peak
5698	94.6	-	-	87.57	32.54	7	32.51	103	331	Average
5698	101.34	-	-	94.31	32.54	7	32.51	103	331	Peak
11400	48.26	-25.74	74	30.9	40.32	11.55	34.51	100	0	Peak
17100	47.79	-26.21	74	29.31	39.68	13.56	34.76	100	0	Peak



Test Mode :	802.11n HT40	Temperature :	22~24°C
Test Channel :	38	Relative Humidity :	47~49%
Test Engineer :	Kyle Jhuang, Abi Lin and Derreck Chen	Polarization :	Horizontal
Remark :	1. 5192 MHz is fundamental signal which can be ignored. 2. 10380 MHz is not within a restricted band and satisfies both the average and peak limits of 15.209. 3. Average measurement was not performed if peak level went lower than the average limit.		

Frequency (MHz)	Level (dBµV/m)	Over Limit (dB)	Limit Line (dBµV/m)	Read Level (dBµV)	Antenna Factor (dB)	Cable Loss (dB)	Preamp Factor (dB)	Ant Pos (cm)	Table Pos (deg)	Remark
67.26	30.37	-9.63	40	45.31	12.42	0.69	28.05	100	19	Peak
89.67	29.47	-14.03	43.5	48.67	8.15	0.76	28.11	-	-	Peak
266.79	28.82	-17.18	46	42.61	13.07	1.31	28.17	-	-	Peak
342.7	23.98	-22.02	46	35.57	15.04	1.52	28.15	-	-	Peak
533.8	24	-22	46	31.5	18.57	1.86	27.93	-	-	Peak
822.9	28.51	-17.49	46	30.65	22.87	2.39	27.4	-	-	Peak
5192	91.4	-	-	85.13	31.99	6.68	32.4	107	197	Average
5192	98.04	-	-	91.77	31.99	6.68	32.4	107	197	Peak
10380	47.34	-26.66	74	30.35	40.06	11.09	34.16	100	0	Peak
15570	50.16	-23.84	74	32.32	39.09	13.27	34.52	100	0	Peak



Test Mode :	802.11n HT40	Temperature :	22~24°C
Test Channel :	38	Relative Humidity :	47~49%
Test Engineer :	Kyle Jhuang, Abi Lin and Derreck Chen	Polarization :	Vertical
Remark :	1. 5192 MHz is fundamental signal which can be ignored. 2. 10380 MHz is not within a restricted band and satisfies both the average and peak limits of 15.209. 3. Average measurement was not performed if peak level went lower than the average limit.		

Frequency (MHz)	Level (dBμV/m)	Over Limit (dB)	Limit Line (dBμV/m)	Read Level (dBμV)	Antenna Factor (dB)	Cable Loss (dB)	Preamp Factor (dB)	Ant Pos (cm)	Table Pos (deg)	Remark
33.24	25.72	-14.28	40	39.74	13.54	0.43	27.99	-	-	Peak
118.02	22.15	-21.35	43.5	38.06	11.34	0.89	28.14	-	-	Peak
207.12	20.9	-22.6	43.5	37.15	10.74	1.17	28.16	-	-	Peak
470.1	26.6	-19.4	46	35.02	17.8	1.79	28.01	-	-	Peak
559.7	28.85	-17.15	46	35.76	19.07	1.92	27.9	-	-	Peak
833.4	31.74	-14.26	46	33.71	23	2.39	27.36	100	188	Peak
5192	94.27	-	-	88	31.99	6.68	32.4	100	351	Average
5192	101.05	-	-	94.78	31.99	6.68	32.4	100	351	Peak
10380	47.79	-26.21	74	30.8	40.06	11.09	34.16	100	0	Peak
15570	46.14	-27.86	74	28.3	39.09	13.27	34.52	100	0	Peak



Test Mode :	802.11n HT40	Temperature :	22~24°C
Test Channel :	46	Relative Humidity :	47~49%
Test Engineer :	Kyle Jhuang, Abi Lin and Derreck Chen	Polarization :	Horizontal
Remark :	<ol style="list-style-type: none"> 5233 MHz is fundamental signal which can be ignored. 10461 MHz is not within a restricted band and satisfies both the average and peak limits of 15.209. Average measurement was not performed if peak level went lower than the average limit. 		

Frequency (MHz)	Level (dBμV/m)	Over Limit (dB)	Limit Line (dBμV/m)	Read Level (dBμV)	Antenna Factor (dB)	Cable Loss (dB)	Preamp Factor (dB)	Ant Pos (cm)	Table Pos (deg)	Remark
5233	89.27	-	-	82.94	32.03	6.7	32.4	103	30	Average
5233	95.31	-	-	88.98	32.03	6.7	32.4	103	30	Peak
10461	47.89	-26.11	74	30.67	40.15	11.29	34.22	100	0	Peak
15690	48.12	-25.88	74	30.57	38.73	13.35	34.53	100	0	Peak

Test Mode :	802.11n HT40	Temperature :	22~24°C
Test Channel :	46	Relative Humidity :	47~49%
Test Engineer :	Kyle Jhuang, Abi Lin and Derreck Chen	Polarization :	Vertical
Remark :	<ol style="list-style-type: none"> 5228 MHz is fundamental signal which can be ignored. 10461 MHz is not within a restricted band and satisfies both the average and peak limits of 15.209. Average measurement was not performed if peak level went lower than the average limit. 		

Frequency (MHz)	Level (dBμV/m)	Over Limit (dB)	Limit Line (dBμV/m)	Read Level (dBμV)	Antenna Factor (dB)	Cable Loss (dB)	Preamp Factor (dB)	Ant Pos (cm)	Table Pos (deg)	Remark
5228	92.57	-	-	86.24	32.03	6.7	32.4	103	65	Average
5228	98.78	-	-	92.46	32.02	6.7	32.4	103	65	Peak
10461	48.36	-25.64	74	31.14	40.15	11.29	34.22	100	0	Peak
15690	47.21	-26.79	74	29.66	38.73	13.35	34.53	100	0	Peak



Test Mode :	802.11n HT40	Temperature :	22~24°C
Test Channel :	54	Relative Humidity :	47~49%
Test Engineer :	Kyle Jhuang, Abi Lin and Derreck Chen	Polarization :	Horizontal
Remark :	<ol style="list-style-type: none"> 5273 MHz is fundamental signal which can be ignored. 10539 MHz is not within a restricted band and satisfies both the average and peak limits of 15.209. Average measurement was not performed if peak level went lower than the average limit. 		

Frequency (MHz)	Level (dBμV/m)	Over Limit (dB)	Limit Line (dBμV/m)	Read Level (dBμV)	Antenna Factor (dB)	Cable Loss (dB)	Preamp Factor (dB)	Ant Pos (cm)	Table Pos (deg)	Remark
5273	90.82	-	-	84.43	32.07	6.72	32.4	102	196	Average
5273	97.5	-	-	91.1	32.08	6.72	32.4	102	196	Peak
10539	49.18	-24.82	74	31.79	40.25	11.41	34.27	100	0	Peak
15810	47.54	-26.46	74	30.27	38.37	13.44	34.54	100	0	Peak

Test Mode :	802.11n HT40	Temperature :	22~24°C
Test Channel :	54	Relative Humidity :	47~49%
Test Engineer :	Kyle Jhuang, Abi Lin and Derreck Chen	Polarization :	Vertical
Remark :	<ol style="list-style-type: none"> 5268 MHz is fundamental signal which can be ignored. 10539 MHz is not within a restricted band and satisfies both the average and peak limits of 15.209. Average measurement was not performed if peak level went lower than the average limit. 		

Frequency (MHz)	Level (dBμV/m)	Over Limit (dB)	Limit Line (dBμV/m)	Read Level (dBμV)	Antenna Factor (dB)	Cable Loss (dB)	Preamp Factor (dB)	Ant Pos (cm)	Table Pos (deg)	Remark
5268	92.61	-	-	86.22	32.07	6.72	32.4	103	71	Average
5268	98.41	-	-	92.02	32.07	6.72	32.4	103	71	Peak
10539	49.03	-24.97	74	31.64	40.25	11.41	34.27	100	0	Peak
15810	45.98	-28.02	74	28.71	38.37	13.44	34.54	100	0	Peak



Test Mode :	802.11n HT40	Temperature :	22~24°C
Test Channel :	62	Relative Humidity :	47~49%
Test Engineer :	Kyle Jhuang, Abi Lin and Derreck Chen	Polarization :	Horizontal
Remark :	1. 5313 MHz is fundamental signal which can be ignored. 2. Average measurement was not performed if peak level went lower than the average limit.		

Frequency (MHz)	Level (dBμV/m)	Over Limit (dB)	Limit Line (dBμV/m)	Read Level (dBμV)	Antenna Factor (dB)	Cable Loss (dB)	Preamp Factor (dB)	Ant Pos (cm)	Table Pos (deg)	Remark
67.53	30.2	-9.8	40	45.19	12.37	0.69	28.05	100	32	Peak
118.83	19.75	-23.75	43.5	35.58	11.41	0.9	28.14	-	-	Peak
295.68	28.01	-17.99	46	40.79	14.01	1.39	28.18	-	-	Peak
309.1	25.67	-20.33	46	38.11	14.3	1.43	28.17	-	-	Peak
611.5	25.86	-20.14	46	31.32	20.27	2.1	27.83	-	-	Peak
948.9	30.25	-15.75	46	30.11	24.48	2.6	26.94	-	-	Peak
5313	90.3	-	-	83.85	32.11	6.74	32.4	105	24	Average
5313	96.74	-	-	90.29	32.11	6.74	32.4	105	24	Peak
10620	47.76	-26.24	74	30.27	40.34	11.45	34.3	100	0	Peak
15930	48.24	-25.76	74	31.26	38.01	13.52	34.55	100	0	Peak



Test Mode :	802.11n HT40	Temperature :	22~24°C
Test Channel :	62	Relative Humidity :	47~49%
Test Engineer :	Kyle Jhuang, Abi Lin and Derreck Chen	Polarization :	Vertical
Remark :	1. 5313 MHz is fundamental signal which can be ignored. 2. Average measurement was not performed if peak level went lower than the average limit.		

Frequency (MHz)	Level (dBμV/m)	Over Limit (dB)	Limit Line (dBμV/m)	Read Level (dBμV)	Antenna Factor (dB)	Cable Loss (dB)	Preamp Factor (dB)	Ant Pos (cm)	Table Pos (deg)	Remark
61.86	25.12	-14.88	40	39.06	13.45	0.65	28.04	100	188	Peak
117.48	21.88	-21.62	43.5	37.83	11.3	0.89	28.14	-	-	Peak
233.04	24.32	-21.68	46	39.49	11.78	1.22	28.17	-	-	Peak
461	25.33	-20.67	46	33.85	17.71	1.79	28.02	-	-	Peak
559.7	28.14	-17.86	46	35.05	19.07	1.92	27.9	-	-	Peak
707.4	26.59	-19.41	46	30.63	21.42	2.22	27.68	-	-	Peak
5313	95.41	-	-	88.96	32.11	6.74	32.4	106	12	Average
5313	99.61	-	-	93.15	32.12	6.74	32.4	106	12	Peak
10620	49.11	-24.89	74	31.62	40.34	11.45	34.3	100	0	Peak
15930	46.15	-27.85	74	29.17	38.01	13.52	34.55	100	0	Peak



Test Mode :	802.11n HT40	Temperature :	22~24°C
Test Channel :	102	Relative Humidity :	47~49%
Test Engineer :	Kyle Jhuang, Abi Lin and Derreck Chen	Polarization :	Horizontal
Remark :	1. 5508 MHz is fundamental signal which can be ignored. 2. 16530 MHz is not within a restricted band and satisfies both the average and peak limits of 15.209. 3. Average measurement was not performed if peak level went lower than the average limit.		

Frequency (MHz)	Level (dBμV/m)	Over Limit (dB)	Limit Line (dBμV/m)	Read Level (dBμV)	Antenna Factor (dB)	Cable Loss (dB)	Preamp Factor (dB)	Ant Pos (cm)	Table Pos (deg)	Remark
72.12	29.28	-10.72	40	45.21	11.41	0.72	28.06	100	16	Peak
148.26	25.28	-18.22	43.5	38.67	13.75	1	28.14	-	-	Peak
295.41	28.28	-17.72	46	41.06	14.01	1.39	28.18	-	-	Peak
372.8	31.66	-14.34	46	42.54	15.7	1.55	28.13	-	-	Peak
643	25.83	-20.17	46	30.94	20.46	2.22	27.79	-	-	Peak
957.3	30.98	-15.02	46	30.74	24.53	2.62	26.91	-	-	Peak
5508	90.15	-	-	83.39	32.31	6.86	32.41	100	217	Average
5508	95.75	-	-	89.01	32.3	6.85	32.41	100	217	Peak
11019	48.3	-25.7	74	30.35	40.78	11.64	34.47	100	0	Peak
16530	49.01	-24.99	74	30.72	39.02	13.9	34.63	100	0	Peak



Test Mode :	802.11n HT40	Temperature :	22~24°C
Test Channel :	102	Relative Humidity :	47~49%
Test Engineer :	Kyle Jhuang, Abi Lin and Derreck Chen	Polarization :	Vertical
Remark :	1. 5513 MHz is fundamental signal which can be ignored. 2. 16530 MHz is not within a restricted band and satisfies both the average and peak limits of 15.209. 3. Average measurement was not performed if peak level went lower than the average limit.		

Frequency (MHz)	Level (dBµV/m)	Over Limit (dB)	Limit Line (dBµV/m)	Read Level (dBµV)	Antenna Factor (dB)	Cable Loss (dB)	Preamp Factor (dB)	Ant Pos (cm)	Table Pos (deg)	Remark
46.2	30.01	-9.99	40	43.17	14.25	0.59	28	100	68	Peak
71.58	26	-14	40	41.8	11.54	0.72	28.06	-	-	Peak
202.53	28.84	-14.66	43.5	45.19	10.65	1.16	28.16	-	-	Peak
461	26.55	-19.45	46	35.07	17.71	1.79	28.02	-	-	Peak
550.6	28	-18	46	35.2	18.82	1.89	27.91	-	-	Peak
804.7	28.82	-17.18	46	31.24	22.66	2.38	27.46	-	-	Peak
5513	94.62	-	-	87.86	32.32	6.86	32.42	102	12	Average
5513	100.23	-	-	93.47	32.32	6.86	32.42	102	12	Peak
11019	49.07	-24.93	74	31.12	40.78	11.64	34.47	100	0	Peak
16530	46.3	-27.7	74	28.01	39.02	13.9	34.63	100	0	Peak



Test Mode :	802.11n HT40	Temperature :	22~24°C
Test Channel :	110	Relative Humidity :	47~49%
Test Engineer :	Kyle Jhuang, Abi Lin and Derreck Chen	Polarization :	Horizontal
Remark :	1. 5552 MHz is fundamental signal which can be ignored. 2. 16650 MHz is not within a restricted band and satisfies both the average and peak limits of 15.209. 3. Average measurement was not performed if peak level went lower than the average limit.		

Frequency (MHz)	Level (dBμV/m)	Over Limit (dB)	Limit Line (dBμV/m)	Read Level (dBμV)	Antenna Factor (dB)	Cable Loss (dB)	Preamp Factor (dB)	Ant Pos (cm)	Table Pos (deg)	Remark
5552	89.95	-	-	83.13	32.36	6.89	32.43	100	1	Average
5552	95.54	-	-	88.72	32.36	6.89	32.43	100	1	Peak
11100	49.21	-24.79	74	31.39	40.68	11.62	34.48	100	0	Peak
16650	49.27	-24.73	74	31.05	39.12	13.77	34.67	100	0	Peak

Test Mode :	802.11n HT40	Temperature :	22~24°C
Test Channel :	110	Relative Humidity :	47~49%
Test Engineer :	Kyle Jhuang, Abi Lin and Derreck Chen	Polarization :	Vertical
Remark :	1. 5548 MHz is fundamental signal which can be ignored. 2. 16650 MHz is not within a restricted band and satisfies both the average and peak limits of 15.209. 3. Average measurement was not performed if peak level went lower than the average limit.		

Frequency (MHz)	Level (dBμV/m)	Over Limit (dB)	Limit Line (dBμV/m)	Read Level (dBμV)	Antenna Factor (dB)	Cable Loss (dB)	Preamp Factor (dB)	Ant Pos (cm)	Table Pos (deg)	Remark
5548	95.15	-	-	88.33	32.36	6.89	32.43	102	340	Average
5548	97.48	-	-	90.66	32.36	6.89	32.43	102	340	Peak
11100	48.68	-25.32	74	30.86	40.68	11.62	34.48	100	0	Peak
16650	46.62	-27.38	74	28.4	39.12	13.77	34.67	100	0	Peak



Test Mode :	802.11n HT40	Temperature :	22~24°C
Test Channel :	134	Relative Humidity :	47~49%
Test Engineer :	Kyle Jhuang, Abi Lin and Derreck Chen	Polarization :	Horizontal
Remark :	1. 5673 MHz is fundamental signal which can be ignored. 2. 17010 MHz is not within a restricted band and satisfies both the average and peak limits of 15.209. 3. Average measurement was not performed if peak level went lower than the average limit.		

Frequency (MHz)	Level (dBμV/m)	Over Limit (dB)	Limit Line (dBμV/m)	Read Level (dBμV)	Antenna Factor (dB)	Cable Loss (dB)	Preamp Factor (dB)	Ant Pos (cm)	Table Pos (deg)	Remark
5673	92	-	-	85	32.51	6.98	32.49	106	4	Average
5673	98.3	-	-	91.3	32.51	6.99	32.5	106	4	Peak
11340	47.36	-26.64	74	29.9	40.39	11.57	34.5	100	0	Peak
17010	48.86	-25.14	74	30.78	39.43	13.43	34.78	100	0	Peak

Test Mode :	802.11n HT40	Temperature :	22~24°C
Test Channel :	134	Relative Humidity :	47~49%
Test Engineer :	Kyle Jhuang, Abi Lin and Derreck Chen	Polarization :	Vertical
Remark :	1. 5672 MHz is fundamental signal which can be ignored. 2. 17010 MHz is not within a restricted band and satisfies both the average and peak limits of 15.209. 3. Average measurement was not performed if peak level went lower than the average limit.		

Frequency (MHz)	Level (dBμV/m)	Over Limit (dB)	Limit Line (dBμV/m)	Read Level (dBμV)	Antenna Factor (dB)	Cable Loss (dB)	Preamp Factor (dB)	Ant Pos (cm)	Table Pos (deg)	Remark
5672	95.5	-	-	88.5	32.51	6.98	32.49	100	330	Average
5672	100.33	-	-	93.33	32.51	6.98	32.49	100	330	Peak
11340	47.95	-26.05	74	30.49	40.39	11.57	34.5	100	0	Peak
17010	45.66	-28.34	74	27.58	39.43	13.43	34.78	100	0	Peak



Test Mode :	802.11n HT40 with WPC Charging Mode	Temperature :	22~24°C
Test Channel :	62	Relative Humidity :	47~49%
Test Engineer :	Kyle Jhuang, Abi Lin and Derreck Chen	Polarization :	Horizontal
Remark :	1. 5308 MHz is fundamental signal which can be ignored. 2. Average measurement was not performed if peak level went lower than the average limit.		

Frequency (MHz)	Level (dBμV/m)	Over Limit (dB)	Limit Line (dBμV/m)	Read Level (dBμV)	Antenna Factor (dB)	Cable Loss (dB)	Preamp Factor (dB)	Ant Pos (cm)	Table Pos (deg)	Remark
87.51	29.26	-10.74	40	48.13	8.47	0.76	28.1	-	-	Peak
142.05	37.15	-6.35	43.5	50.72	13.56	1.01	28.14	100	188	Peak
194.7	36.1	-7.4	43.5	52.32	10.81	1.13	28.16	-	-	Peak
377	21.72	-24.28	46	32.5	15.79	1.56	28.13	-	-	Peak
539.4	23.64	-22.36	46	31.04	18.65	1.87	27.92	-	-	Peak
825.7	28.84	-17.16	46	30.93	22.91	2.39	27.39	-	-	Peak
5308	97.15	-	-	90.71	32.11	6.73	32.4	103	297	Average
5308	95.43	-	-	88.99	32.11	6.73	32.4	103	297	Peak
10620	47.19	-26.81	74	29.7	40.34	11.45	34.3	100	0	Peak
15930	40.04	-33.96	74	23.06	38.01	13.52	34.55	100	0	Peak



Test Mode :	802.11n HT40 with WPC Charging Mode	Temperature :	22~24°C
Test Channel :	62	Relative Humidity :	47~49%
Test Engineer :	Kyle Jhuang, Abi Lin and Derreck Chen	Polarization :	Vertical
Remark :	1. 5308 MHz is fundamental signal which can be ignored. 2. Average measurement was not performed if peak level went lower than the average limit.		

Frequency (MHz)	Level (dBμV/m)	Over Limit (dB)	Limit Line (dBμV/m)	Read Level (dBμV)	Antenna Factor (dB)	Cable Loss (dB)	Preamp Factor (dB)	Ant Pos (cm)	Table Pos (deg)	Remark
62.13	32.65	-7.35	40	46.64	13.4	0.65	28.04	100	48	Peak
88.86	32.61	-10.89	43.5	51.68	8.27	0.76	28.1	-	-	Peak
171.21	35.26	-8.24	43.5	49.34	13.04	1.03	28.15	-	-	Peak
477.1	26.99	-19.01	46	35.32	17.87	1.8	28	-	-	Peak
598.2	25.77	-20.23	46	31.43	20.15	2.04	27.85	-	-	Peak
958	34.83	-11.17	46	34.58	24.53	2.63	26.91	-	-	Peak
5308	94.7	-	-	88.26	32.11	6.73	32.4	100	236	Average
5308	91.7	-	-	85.26	32.11	6.73	32.4	100	236	Peak
10620	46.32	-27.68	74	28.83	40.34	11.45	34.3	100	0	Peak
15930	40.26	-33.74	74	23.28	38.01	13.52	34.55	100	0	Peak



3.6 AC Conducted Emission Measurement

3.6.1 Limit of AC Conducted Emission

For equipment that is designed to be connected to the public utility (AC) power line, the radio frequency voltage that is conducted back onto the AC power line on any frequency or frequencies within the band 150 kHz to 30 MHz shall not exceed the limits in the following table.

Frequency of emission (MHz)	Conducted limit (dB μ V)	
	Quasi-peak	Average
0.15-0.5	66 to 56*	56 to 46*
0.5-5	56	46
5-30	60	50

*Decreases with the logarithm of the frequency.

3.6.2 Measuring Instruments

The measuring equipment is listed in the section 4 of this test report.

3.6.3 Test Procedures

1. The EUT was placed 0.4 meter from the conducting wall of the shielding room was kept at least 80 centimeters from any other grounded conducting surface.
2. Connect EUT to the power mains through a line impedance stabilization network (LISN).
3. All the support units are connecting to the other LISN.
4. The LISN provides 50 ohm coupling impedance for the measuring instrument.
5. The FCC states that a 50 ohm, 50 microhenry LISN should be used.
6. Both sides of AC line were checked for maximum conducted interference.
7. The frequency range from 150 kHz to 30 MHz was searched.
8. Set the test-receiver system to Peak Detect Function and specified bandwidth with Maximum Hold Mode.

3.6.4 Test Setup

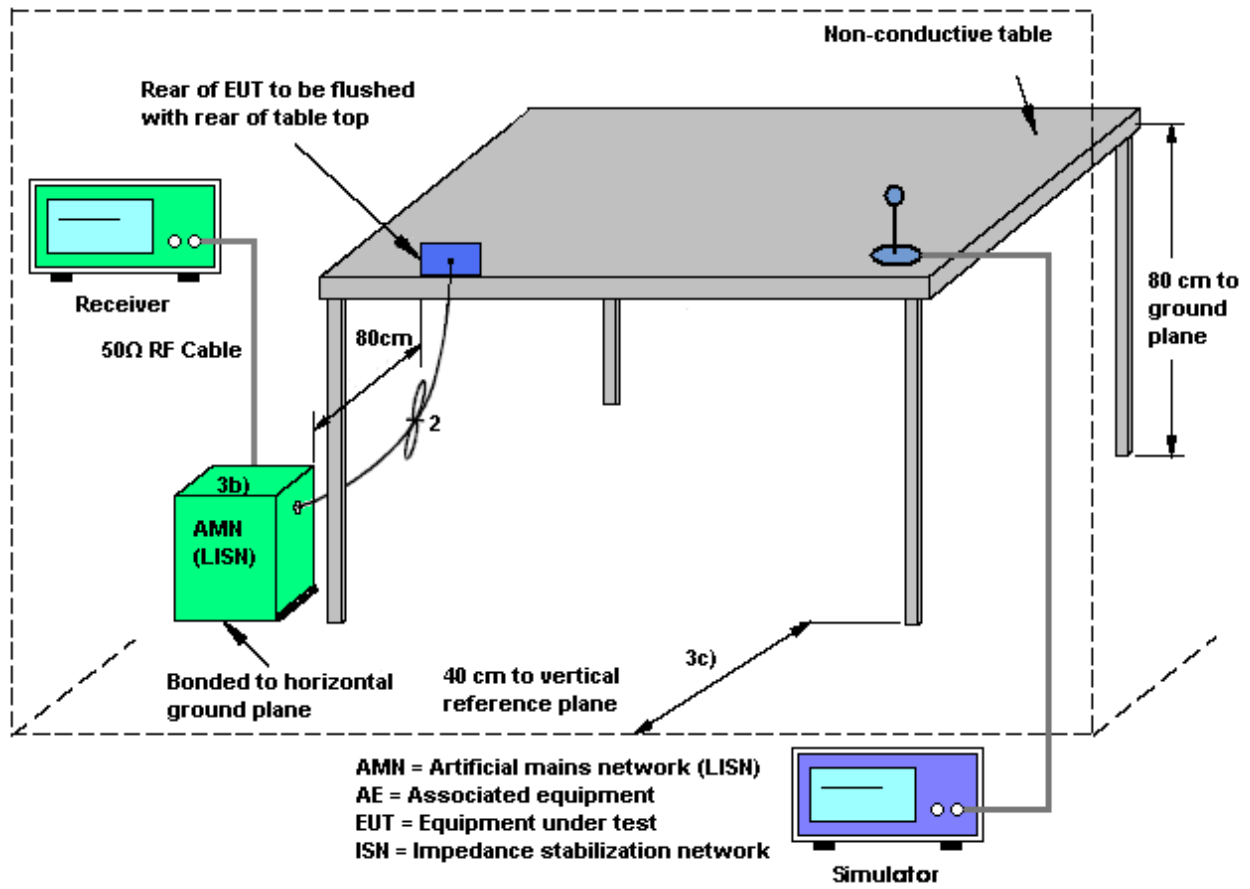



3.6.5 Test Result of AC Conducted Emission

Test Mode :	Mode 1	Temperature :	20~22°C
Test Engineer :	Cosmo Xu	Relative Humidity :	45~47%
Test Voltage :	120Vac / 60Hz	Phase :	Line
Function Type :	GSM1900 Idle + WLAN(5GHz) Link + Bluetooth Link + Earphone + USB Cable (Data Link with Notebook) + GPS Rx + Battery		

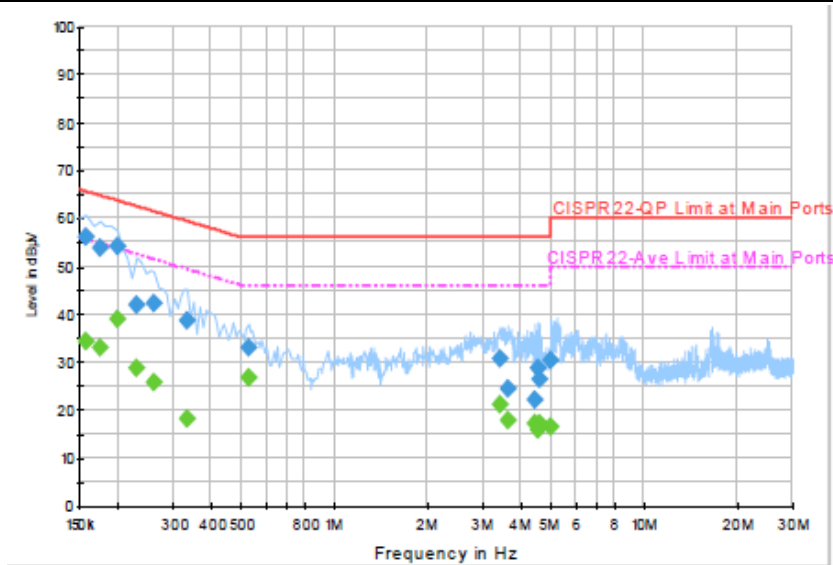

Final Result : QuasiPeak

Frequency (MHz)	QuasiPeak (dBµV)	Filter	Line	Corr. (dB)	Margin (dB)	Limit (dBµV)
0.158000	56.2	Off	L1	19.3	9.4	65.6
0.174000	53.7	Off	L1	19.3	11.1	64.8
0.198000	54.0	Off	L1	19.3	9.7	63.7
0.230000	42.0	Off	L1	19.4	20.4	62.4
0.262000	42.2	Off	L1	19.4	19.2	61.4
0.334000	38.5	Off	L1	19.4	20.9	59.4
0.526000	33.0	Off	L1	19.4	23.0	56.0
3.398000	30.7	Off	L1	19.6	25.3	56.0
3.630000	24.6	Off	L1	19.5	31.4	56.0
4.414000	22.0	Off	L1	19.5	34.0	56.0
4.542000	28.6	Off	L1	19.6	27.4	56.0
4.598000	26.3	Off	L1	19.6	29.7	56.0
4.990000	30.4	Off	L1	19.6	25.6	56.0



Test Mode :	Mode 1	Temperature :	20~22°C
Test Engineer :	Cosmo Xu	Relative Humidity :	45~47%
Test Voltage :	120Vac / 60Hz	Phase :	Line
Function Type :	GSM1900 Idle + WLAN(5GHz) Link + Bluetooth Link + Earphone + USB Cable (Data Link with Notebook) + GPS Rx + Battery		

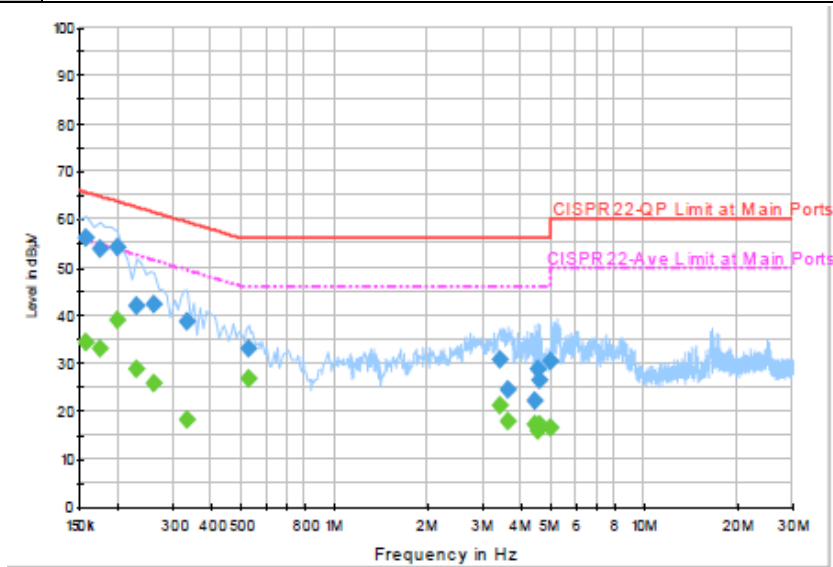

Final Result : Average

Frequency (MHz)	Average (dBµV)	Filter	Line	Corr. (dB)	Margin (dB)	Limit (dBµV)
0.158000	34.4	Off	L1	19.3	21.2	55.6
0.174000	32.9	Off	L1	19.3	21.9	54.8
0.198000	39.0	Off	L1	19.3	14.7	53.7
0.230000	28.9	Off	L1	19.4	23.5	52.4
0.262000	25.8	Off	L1	19.4	25.6	51.4
0.334000	18.2	Off	L1	19.4	31.2	49.4
0.526000	26.9	Off	L1	19.4	19.1	46.0
3.398000	21.0	Off	L1	19.6	25.0	46.0
3.630000	17.9	Off	L1	19.5	28.1	46.0
4.414000	17.3	Off	L1	19.5	28.7	46.0
4.542000	15.9	Off	L1	19.6	30.1	46.0
4.598000	17.2	Off	L1	19.6	28.8	46.0
4.990000	16.6	Off	L1	19.6	29.4	46.0



Test Mode :	Mode 1	Temperature :	20~22°C
Test Engineer :	Cosmo Xu	Relative Humidity :	45~47%
Test Voltage :	120Vac / 60Hz	Phase :	Neutral
Function Type :	GSM1900 Idle + WLAN(5GHz) Link + Bluetooth Link + Earphone + USB Cable (Data Link with Notebook) + GPS Rx + Battery		

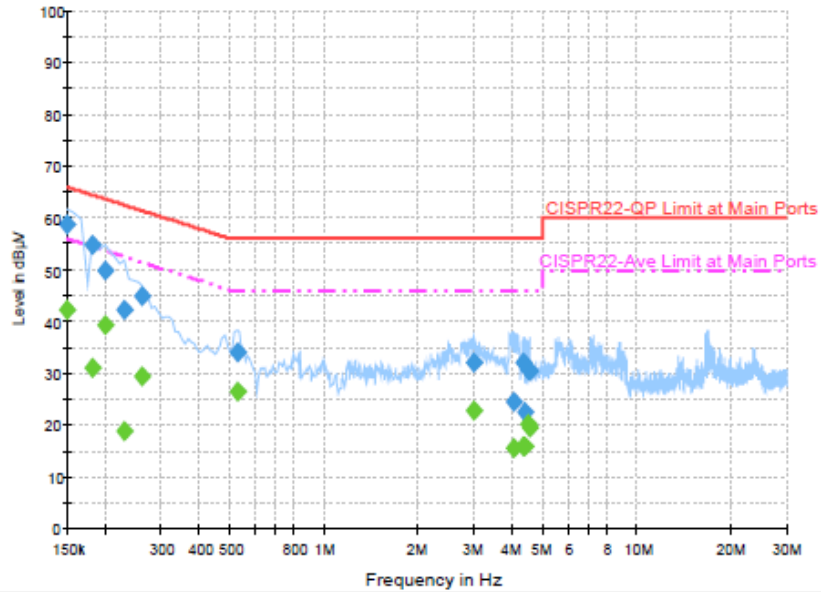

Final Result : QuasiPeak

Frequency (MHz)	QuasiPeak (dBµV)	Filter	Line	Corr. (dB)	Margin (dB)	Limit (dBµV)
0.150000	58.6	Off	N	19.4	7.4	66.0
0.182000	54.9	Off	N	19.4	9.5	64.4
0.198000	49.9	Off	N	19.3	13.8	63.7
0.230000	42.3	Off	N	19.4	20.1	62.4
0.262000	45.0	Off	N	19.4	16.4	61.4
0.526000	34.0	Off	N	19.4	22.0	56.0
3.014000	32.2	Off	N	19.6	23.8	56.0
4.046000	24.3	Off	N	19.6	31.7	56.0
4.326000	32.1	Off	N	19.6	23.9	56.0
4.382000	22.4	Off	N	19.6	33.6	56.0
4.470000	30.6	Off	N	19.6	25.4	56.0
4.518000	30.2	Off	N	19.6	25.8	56.0



Test Mode :	Mode 1	Temperature :	20~22°C
Test Engineer :	Cosmo Xu	Relative Humidity :	45~47%
Test Voltage :	120Vac / 60Hz	Phase :	Neutral
Function Type :	GSM1900 Idle + WLAN(5GHz) Link + Bluetooth Link + Earphone + USB Cable (Data Link with Notebook) + GPS Rx + Battery		

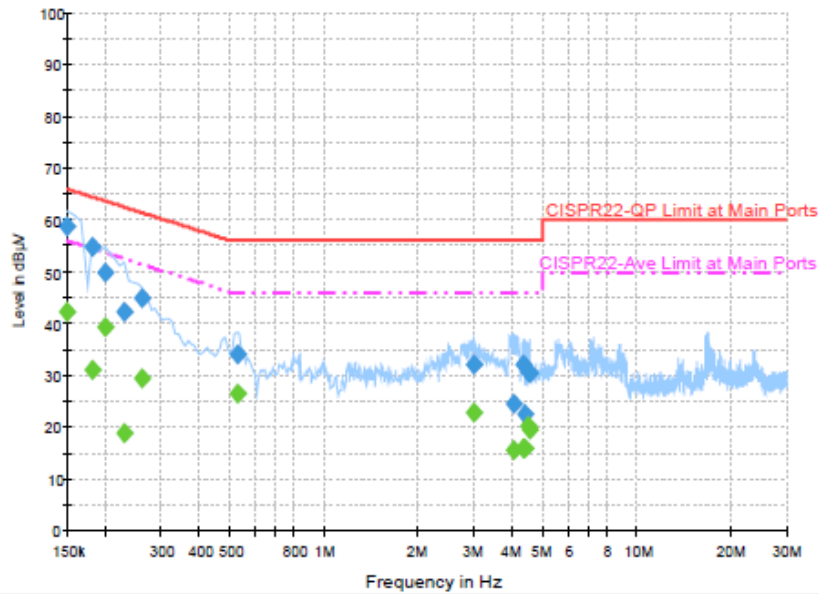

Final Result : Average

Frequency (MHz)	Average (dBµV)	Filter	Line	Corr. (dB)	Margin (dB)	Limit (dBµV)
0.150000	42.1	Off	N	19.4	13.9	56.0
0.182000	31.2	Off	N	19.4	23.2	54.4
0.198000	39.2	Off	N	19.3	14.5	53.7
0.230000	18.9	Off	N	19.4	33.5	52.4
0.262000	29.5	Off	N	19.4	21.9	51.4
0.526000	26.5	Off	N	19.4	19.5	46.0
3.014000	22.8	Off	N	19.6	23.2	46.0
4.046000	15.5	Off	N	19.6	30.5	46.0
4.326000	16.0	Off	N	19.6	30.0	46.0
4.382000	15.9	Off	N	19.6	30.1	46.0
4.470000	20.1	Off	N	19.6	25.9	46.0
4.518000	19.5	Off	N	19.6	26.5	46.0

3.7 Frequency Stability Measurement

3.7.1 Limit of Frequency Stability

Manufacturers of U-NII devices are responsible for ensuring frequency stability such that an emission is maintained within the band of operation under all conditions of normal operation as specified in the user's manual.

3.7.2 Measuring Instruments

The measuring equipment is listed in the section 4 of this test report.

3.7.3 Test Procedures

1. To ensure emission at the band edge is maintained within the authorized band, those values shall be measured by radiation emissions at upper and lower frequency points, and finally compensated by frequency deviation as procedures below.
2. The EUT was operated at the maximum output power, and connected to the spectrum analyzer, which is set to maximum hold function and peak detector. The peak value of the power envelope was measured and noted. The upper and lower frequency points were respectively measured relatively 10dB lower than the measured peak value.
3. The frequency deviation was calculated by adding the upper frequency point and the lower frequency point divided by two. Those detailed values of frequency deviation are provided in table below.

3.7.4 Test Setup

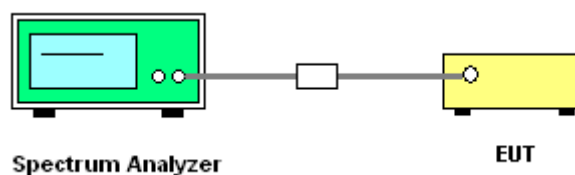



3.7.5 Test Result of Frequency Stability

Test Band :	5GHz band 1,2,3	Test Engineer :	Osolemio Chang and Alen Tsui
-------------	-----------------	-----------------	------------------------------

Mod.	Data Rate	NTX	Channel	Freq. (MHz)	Center Frequency (MHz)	Frequency Deviation (MHz)	Frequency Stability (ppm)	Temperature (°C)	Voltage (V)
11a	6Mbps	1	36	5180	5180.025	0.025	4.83	20	3.4
11a	6Mbps	1	36	5180	5180.000	0.000	0.00	20	4.2
11a	6Mbps	1	36	5180	5180.000	0.000	0.00	20	3.8
11a	6Mbps	1	36	5180	5180.050	0.050	9.65	-20	3.8
11a	6Mbps	1	36	5180	5180.000	0.000	0.00	55	3.8

Mod.	Data Rate	NTX	Channel	Freq. (MHz)	Center Frequency (MHz)	Frequency Deviation (MHz)	Frequency Stability (ppm)	Temperature (°C)	Voltage (V)
11a	6Mbps	1	64	5320	5320.000	0.000	0.00	20	3.4
11a	6Mbps	1	64	5320	5320.000	0.000	0.00	20	4.2
11a	6Mbps	1	64	5320	5320.000	0.000	0.00	20	3.8
11a	6Mbps	1	64	5320	5320.050	0.050	9.40	-20	3.8
11a	6Mbps	1	64	5320	5320.000	0.000	0.00	55	3.8

Mod.	Data Rate	NTX	Channel	Freq. (MHz)	Center Frequency (MHz)	Frequency Deviation (MHz)	Frequency Stability (ppm)	Temperature (°C)	Voltage (V)
11a	6Mbps	1	100	5500	5500.000	0.000	0.00	20	3.4
11a	6Mbps	1	100	5500	5500.000	0.000	0.00	20	4.2
11a	6Mbps	1	100	5500	5500.000	0.000	0.00	20	3.8
11a	6Mbps	1	100	5500	5500.050	0.050	9.09	-20	3.8
11a	6Mbps	1	100	5500	5500.000	0.000	0.00	55	3.8

Note: Center Frequency = (Low Frequency + High Frequency) / 2.



3.8 Automatically Discontinue Transmission

3.8.1 Limit of Automatically Discontinue Transmission

The device shall automatically discontinue transmission in case of either absence of information to transmit or operational failure. These provisions are not intended to preclude the transmission of control or signaling information or the use of repetitive codes used by certain digital technologies to complete frame or burst intervals. Applicants shall include in their application for equipment authorization to describe how this requirement is met.

3.8.2 Measuring Instruments

The measuring equipment is listed in the section 4 of this test report.

3.8.3 Test Result of Automatically Discontinue Transmission

While the EUT is not transmitting any information, the EUT can automatically discontinue transmission and become standby mode for power saving. The EUT can detect the controlling signal of ACK message transmitting from remote device and verify whether it shall resend or discontinue transmission.



3.9 Antenna Requirements

3.9.1 Standard Applicable

According to FCC 47 CFR Section 15.407(a)(1)(2) ,if transmitting antenna directional gain is greater than 6 dBi, both the peak transmit power and the peak power spectral density shall be reduced by the amount in dB that the directional gain of the antenna exceeds 6 dBi.

3.9.2 Antenna Anti-Replacement Construction

An embedded-in antenna design is used.

3.9.3 Antenna Gain

The antenna gain is less than 6 dBi. Therefore, it is not necessary to reduce maximum peak output power limit.



4 List of Measuring Equipments

Instrument	Manufacturer	Model No.	Serial No.	Characteristics	Calibration Date	Test Date	Due Date	Remark
Spectrum Analyzer	Rohde & Schwarz	FSP40	100055	9kHz~40GHz	Jun. 09, 2014	Jul. 21, 2014~ Aug. 06, 2014	Jun. 08, 2015	Conducted (TH02-HY)
Power Meter	Anritsu	ML2495A	1036004	300MHz~40GHz	Aug. 17, 2013	Jul. 21, 2014~ Aug. 06, 2014	Aug. 16, 2014	Conducted (TH02-HY)
Power Sensor	Anritsu	MA2411B	1027253	300MHz~40GHz	Aug. 17, 2013	Jul. 21, 2014~ Aug. 06, 2014	Aug. 16, 2014	Conducted (TH02-HY)
EMI Test Receiver	Rohde & Schwarz	ESCS 30	100356	9kHz ~ 2.75GHz	Nov. 15, 2013	Jul. 31, 2014	Nov. 14, 2014	Conduction (CO05-HY)
LISN (for auxiliary equipment)	Rohde & Schwarz	ENV216	100081	9kHz ~ 30MHz	Dec. 12, 2013	Jul. 31, 2014	Dec. 11, 2014	Conduction (CO05-HY)
LISN	Rohde & Schwarz	ENV216	100080	9kHz ~ 30MHz	Dec. 04, 2013	Jul. 31, 2014	Dec. 03, 2014	Conduction (CO05-HY)
AC Power Source	ChainTek	APC-1000W	N/A	N/A	N/A	Jul. 31, 2014	N/A	Conduction (CO05-HY)
Spectrum Analyzer	Rohde & Schwarz	FSV30	101749	10Hz ~ 30GHz	Feb. 10, 2014	Jul. 21, 2014~ Jul. 26, 2014	Feb. 09, 2015	Radiation (03CH07-HY)
EMI Test Receiver	Rohde & Schwarz	ESCI 7	100724	9kHz~7GHz	Sep. 06, 2013	Jul. 21, 2014~ Jul. 26, 2014	Sep. 05, 2014	Radiation (03CH07-HY)
Loop Antenna	TESEQ	HLA 6120	31244	9 kHz~30 MhZ	Dec. 02, 2012	Jul. 21, 2014~ Jul. 26, 2014	Dec. 03, 2014	Radiation (03CH07-HY)
Bilog Antenna	Schaffner	CBL6111C	2726	30MHz ~ 1GHz	Oct. 10, 2013	Jul. 21, 2014~ Jul. 26, 2014	Oct. 09, 2014	Radiation (03CH07-HY)
Double Ridge Horn Antenna	ESCO	3117	75962	1GHz~18GHz	Aug. 22, 2013	Jul. 21, 2014~ Jul. 26, 2014	Aug. 21, 2014	Radiation (03CH07-HY)
SHF-EHF Horn Antenna	SCHWARZBECK	BBHA 9170	BBHA9170251	15GHz- 40GHz	Oct. 03, 2013	Jul. 21, 2014~ Jul. 26, 2014	Oct. 02, 2014	Radiation (03CH07-HY)
Preamplifier	Agilent	8449B	3008A02362	1G~26.5GHz	Nov. 29, 2013	Jul. 21, 2014~ Jul. 26, 2014	Nov. 28, 2014	Radiation (03CH07-HY)
Preamplifier	MITEQ	TTA0204	1872107	2GHz~40GHz	May. 23, 2014	Jul. 21, 2014~ Jul. 26, 2014	May. 22, 2015	Radiation (03CH07-HY)
Turn Table	ChainTek	ChainTek 3000	N/A	0 ~ 360 degree	N/A	Jul. 21, 2014~ Jul. 26, 2014	N/A	Radiation (03CH07-HY)
Antenna Mast	ChainTek	ChainTek 3000	N/A	N/A	N/A	Jul. 21, 2014~ Jul. 26, 2014	N/A	Radiation (03CH07-HY)



5 Uncertainty of Evaluation

Uncertainty of Conducted Emission Measurement (150kHz ~ 30MHz)

Measuring Uncertainty for a Level of Confidence of 95% ($U = 2Uc(y)$)	2.26
---	------

Uncertainty of Radiated Emission Measurement (30 MHz ~ 1000 MHz)

Measuring Uncertainty for a Level of Confidence of 95% ($U = 2Uc(y)$)	4.50
---	------

