



Hearing Aid Compatibility (HAC) RF Emissions Test Report

APPLICANT : Bullitt Group
EQUIPMENT : Rugged Smart Phone
BRAND NAME : CAT
MODEL NAME : S48c
FCC ID : ZL5S48C
STANDARD : FCC 47 CFR §20.19
ANSI C63.19-2011

We, Sporton International (Kunshan) Inc., would like to declare that the tested sample has been evaluated in accordance with the procedures and had been in compliance with the applicable technical standards.

The test results in this report apply exclusively to the tested model / sample. Without written approval of Sporton International (Kunshan) Inc., the test report shall not be reproduced except in full.

Approved by: Mark Qu / Manager



Sporton International (Kunshan) Inc.
No.3-2 Ping-Xiang Rd, Kunshan Development Zone Kunshan City Jiangsu Province 215335
China



Table of Contents

1. General Information.....	4
2. Administration Data.....	5
3. Applied Standards	5
4. RF Audio Interference Level.....	5
5. Air Interface and Operating Mode.....	6
6. Measurement System Specification.....	7
6.1 E-Field Probe System.....	7
6.2 Data Storage and Evaluation.....	8
7. RF Emissions Test Procedure.....	9
8. Test Equipment List.....	12
9. Measurement System Validation	13
10. Modulation Interference Factor.....	14
11. Low-power Exemption.....	15
12. Conducted RF Output Power (Unit: dBm).....	16
13. HAC RF Emission Test Results.....	19
14. Uncertainty Assessment	20
15. References.....	22
 Appendix A. Plots of System Performance Check	
Appendix B. Plots of RF Emission Measurement	
Appendix C. DASYS Calibration Certificate	
Appendix D. Test Setup Photos	



Revision History

REPORT NO.	VERSION	DESCRIPTION	ISSUED DATE
HA850804-02A	Rev. 01	Initial issue of report	Jul. 10, 2018



1. General Information

Product Feature & Specification	
Applicant Name	Bullitt Group
Equipment Name	Rugged Smart Phone
Brand Name	CAT
Model Name	S48c
FCC ID	ZL5S48C
IMEI Code	358016090012034
EUT Stage	Identical Prototype
Exposure category	General Population/Uncontrolled Exposure
Frequency Band	GSM850: 824.2 MHz ~ 848.8 MHz GSM1900: 1850.2 MHz ~ 1909.8 MHz WCDMA Band II: 1852.4 MHz ~ 1907.6 MHz WCDMA Band IV: 1712.4 MHz ~ 1752.6 MHz WCDMA Band V: 826.4 MHz ~ 846.6 MHz CDMA2000 BC0: 824.7 MHz ~ 848.31 MHz CDMA 2000 BC1: 1851.25 MHz ~ 1908.75 MHz CDMA 2000 BC10: 817.9 MHz ~ 823.1 MHz LTE Band 2: 1850.7 MHz ~ 1909.3 MHz LTE Band 4: 1710.7 MHz ~ 1754.3 MHz LTE Band 5: 824.7 MHz ~ 848.3 MHz LTE Band 7: 2502.5 MHz ~ 2567.5 MHz LTE Band 12: 699.7 MHz ~ 715.3 MHz LTE Band 13: 779.5 MHz ~ 784.5 MHz LTE Band 14: 790.5 MHz ~ 795.5 MHz LTE Band 25: 1850.7 MHz ~ 1914.3 MHz LTE Band 26: 814.7 MHz ~ 848.3 MHz LTE Band 41: 2498.5 MHz ~ 2687.5 MHz LTE Band 66: 1710.7 MHz ~ 1779.3 MHz WLAN 2.4GHz Band: 2412 MHz ~ 2462 MHz WLAN 5.2GHz Band: 5180 MHz ~ 5240 MHz WLAN 5.3GHz Band: 5260 MHz ~ 5320 MHz WLAN 5.5GHz Band: 5500 MHz ~ 5720 MHz WLAN 5.8GHz Band: 5745 MHz ~ 5825 MHz Bluetooth: 2402 MHz ~ 2480 MHz NFC : 13.56 MHz
Mode	GSM/GPRS/EGPRS RMC/AMR 12.2Kbps HSDPA HSUPA DC-HSDPA HSPA+ CDMA2000 : 1xRTT/1xEv-Do(Rev.0)/1xEv-Do(Rev.A) LTE: QPSK, 16QAM, 64QAM WLAN 2.4GHz 802.11b/g/n HT20/HT40 WLAN 5GHz 802.11a/n HT20/HT40 WLAN 5GHz 802.11ac VHT20/VHT40/VHT80 Bluetooth BR/EDR/LE NFC
HAC Rating	M3
Date Tested	2018/6/30 ~ 2018/7/9
Test Result	Pass

This device is compliance with HAC limits specified in guidelines FCC 47 CFR §20.19 and ANSI Standard ANSI C63.19.



2. Administration Data

Table with 2 columns: Field Name and Value. Rows include Testing Laboratory, Test Site, Test Site Location, Test Site No., Applicant, Company Name, and Address.

3. Applied Standards

- FCC CFR47 Part 20.19
ANSI C63.19-2011
FCC KDB 285076 D01 HAC Guidance v05
FCC KDB 285076 D02 T Coil testing v03
FCC KDB 285076 D03 HAC FAQ v01

4. RF Audio Interference Level

FCC wireless hearing aid compatibility rules ensure that consumers with hearing loss are able to access wireless communications services through a wide selection of handsets without experiencing disabling radio frequency (RF) interference or other technical obstacles.

To define and measure the hearing aid compatibility of handsets, in CFR47 part 20.19 ANSI C63.19 is referenced. A handset is considered hearing aid-compatible for acoustic coupling if it meets a rating of at least M3 under ANSI C63.19, and A handset is considered hearing aid compatible for inductive coupling if it meets a rating of at least T3. According to ANSI C63.19 2011 version, for acoustic coupling, the RF electric field emissions of wireless communication devices should be measured and rated according to the emission level as below.

Table with 3 columns: Emission Categories, <960Mhz, and >960Mhz. Rows include M1, M2, M3, and M4 with corresponding dB (V/m) ranges.

Table 5.1 Telephone near-field categories in linear units



5. Air Interface and Operating Mode

Air Interface	Band MHz	Type	C63.19 Tested	Simultaneous Transmitter	Name of Voice Service	Power Reduction
GSM	GSM850	VO	Yes	WLAN, BT	CMRS Voice	No
	GSM1900			WLAN, BT		No
	EDGE850	VD	Yes	WLAN, BT	Google DUO/ SIP calling	No
	EDGE1900			WLAN, BT		
WCDMA	850	VO	No ⁽¹⁾	WLAN, BT	CMRS Voice	No
	1750			WLAN, BT		No
	1900			WLAN, BT		No
	HSPA	VD	No ⁽¹⁾	WLAN, BT	Google DUO/ SIP calling	No
CDMA	BC0	VO	Yes	WLAN, BT	CMRS Voice	No
	BC1			WLAN, BT		No
	BC10			WLAN, BT		No
	EVDO	VD	No ⁽¹⁾	WLAN, BT	Google DUO/ SIP calling	No
LTE (FDD)	Band 2	VD	No ⁽¹⁾	WLAN, BT	VoLTE/ Google DUO/ SIP calling	No
	Band 4			WLAN, BT		No
	Band 5			WLAN, BT		No
	Band 7			WLAN, BT		No
	Band 12			WLAN, BT		No
	Band 13			WLAN, BT		No
	Band 14			WLAN, BT		No
	Band 25			WLAN, BT		No
	Band 26			WLAN, BT		No
	Band 66			WLAN, BT		No
LTE (TDD)	Band 41	VD	Yes	WLAN, BT	VoLTE/ Google DUO/ SIP calling	No
Wi-Fi	2450	VD	No ⁽¹⁾	GSM,CDMA,WCDMA,LTE	VoWiFi/ Google DUO/ SIP calling	No
	5200			GSM,CDMA,WCDMA,LTE		No
	5300			GSM,CDMA,WCDMA,LTE		No
	5500			GSM,CDMA,WCDMA,LTE		No
	5800			GSM,CDMA,WCDMA,LTE		No
BT	2450	DT	No	GSM,CDMA,WCDMA,LTE	NA	No

Type Transport:
 VO= Voice only
 DT= Digital Transport only (no voice)
 VD= CMRS and IP Voice Service over Digital Transport

Remark:
 1. The air interface is exempted from testing by low power exemption that its average antenna input power plus its MIF is ≤17 dBm, and is rated as M4

6. Measurement System Specification

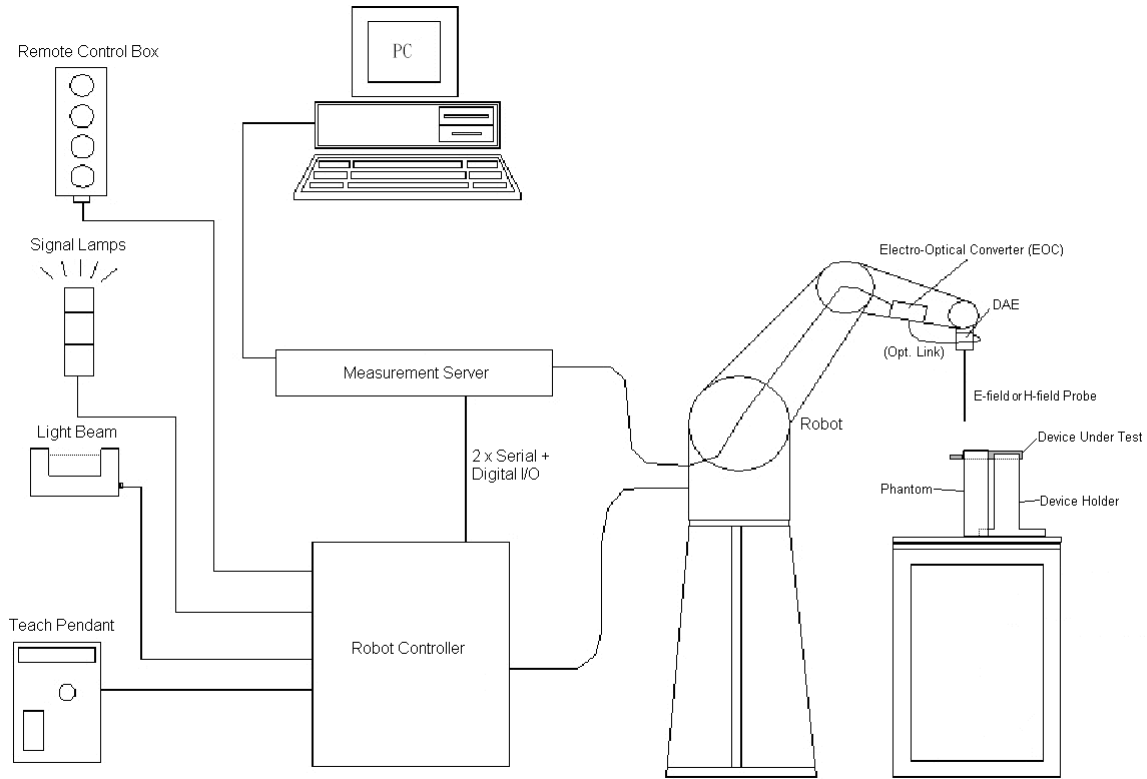

Fig 5.1 System Configurations

6.1 E-Field Probe System

E-Field Probe Specification <EF3DV3>

Construction	One dipole parallel, two dipoles normal to probe axis Built-in shielding against static charges
Calibration	In air from 100 MHz to 3.0 GHz (absolute accuracy $\pm 6.0\%$, $k=2$)
Frequency	100 MHz to 6 GHz; Linearity: ± 2.0 dB (100 MHz to 3 GHz)
Directivity	± 0.2 dB in air (rotation around probe axis) ± 0.4 dB in air (rotation normal to probe axis)
Dynamic Range	2 V/m to 1000 V/m (M3 or better device readings fall well below diode compression point)
Linearity	± 0.2 dB
Dimensions	Overall length: 330 mm (Tip: 16 mm) Tip diameter: 8 mm (Body: 12 mm) Distance from probe tip to dipole centers: 2.5 mm



Fig 5.2 Photo of E-field Probe

Probe Tip Description:

HAC field measurements take place in the close near field with high gradients. Increasing the measuring distance from the source will generally decrease the measured field values (in case of the validation dipole approx. 10% per mm).

6.2 Data Storage and Evaluation

The DASY software stores the assessed data from the data acquisition electronics as raw data (in microvolt readings from the probe sensors), together with all the necessary software parameters for the data evaluation (probe calibration data, and device frequency and modulation data) in measurement files.

Probe parameters :	- Sensitivity	Norm _i , a _{i0} , a _{i1} , a _{i2}
	- Conversion factor	ConvF _i
	- Diode compression point	dcp _i
Device parameters :	- Frequency	f
	- Crest factor	cf
Media parameters :	- Conductivity	σ
	- Density	ρ

The formula for each channel can be given as :

$$V_i = U_i + U_i^2 \cdot \frac{cf}{dcp_i}$$

- with V_i = compensated signal of channel i, (i = x, y, z)
- U_i = input signal of channel i, (i = x, y, z)
- cf = crest factor of exciting field (DASY parameter)
- dcp_i = diode compression point (DASY parameter)

From the compensated input signals, the primary field data for each channel can be evaluated :

$$\text{E-field Probes : } E_i = \sqrt{\frac{V_i}{\text{Norm}_i \cdot \text{ConvF}}}$$

- with V_i = compensated signal of channel i, (i = x, y, z)
- Norm_i = sensor sensitivity of channel i, (i = x, y, z), μV/(V/m)² for E-field Probes
- ConvF = sensitivity enhancement in solution
- f = carrier frequency [GHz]
- E_i = electric field strength of channel i in V/m

The RSS value of the field components gives the total field strength (Hermitian magnitude) :

$$E_{tot} = \sqrt{E_x^2 + E_y^2 + E_z^2}$$

The primary field data are used to calculate the derived field units.



7. RF Emissions Test Procedure

Referenced from ANSI C63.19 -2011 section 5.5.1

- a. Confirm the proper operation of the field probe, probe measurement system, and other instrumentation and the positioning system.
- b. Position the WD in its intended test position.
- c. Set the WD to transmit a fixed and repeatable combination of signal power and modulation characteristic that is representative of the worst case (highest interference potential) encountered in normal use. Transiently occurring start-up, changeover, or termination conditions, or other operations likely to occur less than 1% of the time during normal operation, may be excluded from consideration.
- d. The center sub-grid shall be centered on the T-Coil mode perpendicular measurement point or the acoustic output, as appropriate. Locate the field probe at the initial test position in the 50 mm by 50 mm grid, which is contained in the measurement plane, refer to illustrated in Figure 8.2. If the field alignment method is used, align the probe for maximum field reception.
- e. Record the reading at the output of the measurement system.
- f. Scan the entire 50 mm by 50 mm region in equality spaced increments and record the reading at each measurement point, The distance between measurement points shall be sufficient to assure the identification of the maximum reading.
- g. Identify the five contiguous sub-grids around the center sub-grid whose maximum reading is the lowest of all available choices. This eliminates the three sub-grids with the maximum readings. Thus, the six areas to be used to determine the WD's highest emissions are identified.
- h. Identify the maximum reading within the non-excluded sub-grids identified in step g).
 - i. Indirect measurement method
 - j. The RF audio interference level in dB (V/m) is obtained by adding the MIF (in dB) to the maximum steady-state rms field-strength reading, in dB (V/m)
- k. Compare this RF audio interference level with the categories in ANSI C63.19-2011 clause 8 and record the resulting WD category rating.
- l. For the T-Coil perpendicular measurement location is ≥ 5.0 mm from the center of the acoustic output, then two different 50 mm by 50 mm areas may need to be scanned, the first for the microphone mode assessment and the second for the T-Coil assessment.
- m. The second for the T-Coil assessment, with the grid shifted so that it is centered on the perpendicular measurement point. Record the WD category rating.

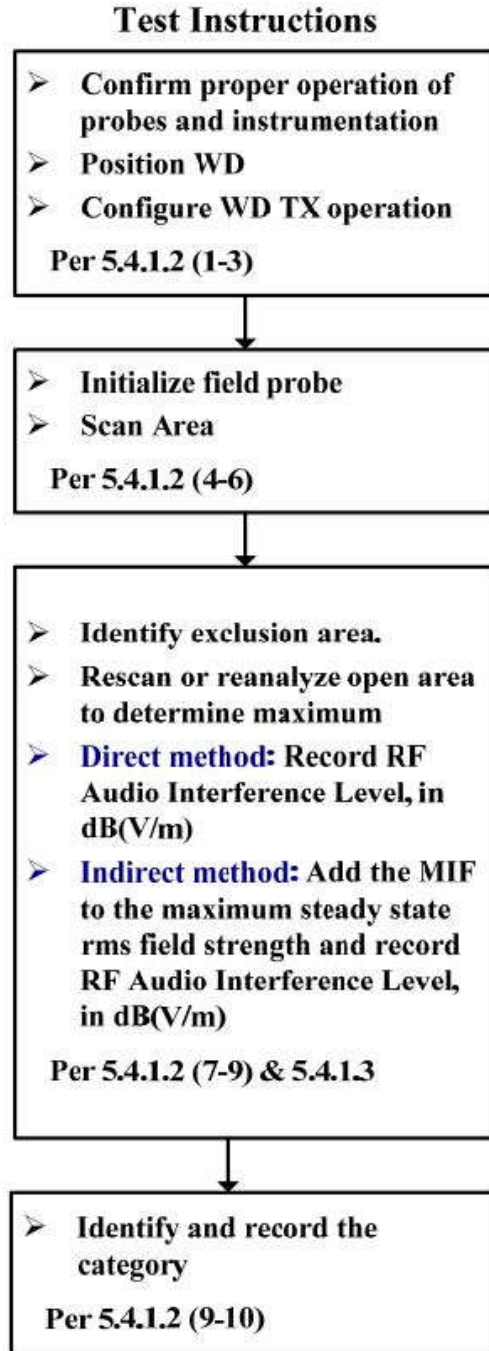

Figure 8.1 RF Emissions Flow Chart



Fig 8.2 EUT reference and plane for HAC RF emission measurements

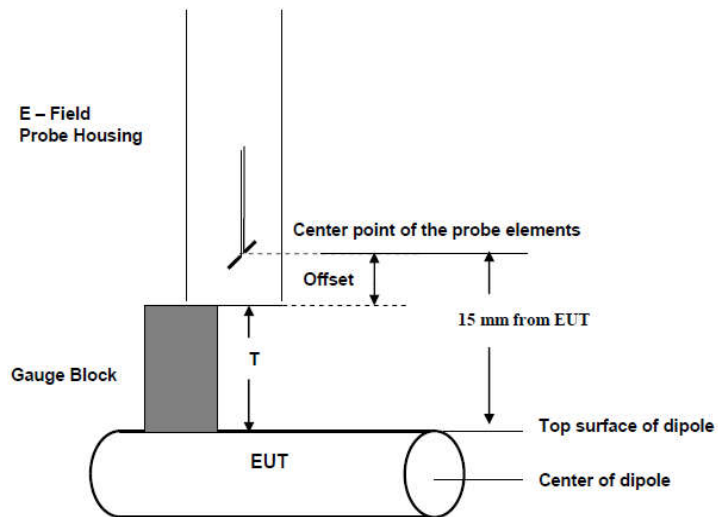

Fig. 8.3 Gauge block with E-field probe



8. Test Equipment List

Manufacturer	Name of Equipment	Type/Model	Serial Number	Calibration	
				Last Cal.	Due Date
SPEAG	835MHz Calibration Dipole	CD835V3	1171	2018/3/26	2019/3/25
SPEAG	1880MHz Calibration Dipole	CD1880V3	1155	2018/3/26	2019/3/25
SPEAG	2600MHz Calibration Dipole	CD2600V3	1010	2017/11/22	2018/11/21
SPEAG	Data Acquisition Electronics	DAE4	1386	2017/7/20	2018/7/19
SPEAG	Data Acquisition Electronics	DAE4	1338	2017/12/4	2018/12/3
SPEAG	Isotropic E-Field Probe	EF3DV3	4053	2018/3/19	2019/3/18
SPEAG	Isotropic E-Field Probe	EF3DV3	4050	2018/1/9	2019/1/8
Testo	Hygrometer	608-H1	1241332096	2017/8/21	2018/8/20
SPEAG	Test Arch Phantom	Par phantom	1105	NCR	NCR
SPEAG	Phone Positioner	N/A	N/A	NCR	NCR
Agilent	Wireless Communication Test Set	E5515C	GB47050646	2017/8/7	2018/8/6
R&S	Universal Radio Communication Tester	CMW500	143030	2017/8/17	2018/8/16
Anritsu	Power Meter	ML2495A	1218006	2017/10/6	2018/10/5
Anritsu	Power Sensor	MA2411B	1207363	2017/10/6	2018/10/5
Anritsu	Power Meter	ML2495A	1349001	2017/7/19	2018/7/18
Anritsu	Power Sensor	MA2411B	1306099	2017/8/21	2018/8/20
ARRA	Power Divider	A3200-2	N/A	NCR	NCR
Agilent	Signal Generator	N5181A	MY50145381	2017/12/26	2018/12/25
PASTERNAK	Dual Directional Coupler	PE2214-10	N/A	NCR	NCR
R&S	Spectrum Analyzer	FSP7	100818	NCR	NCR
MCL	Attenuation	BW-S10W5	N/A	NCR	NCR
AR	Amplifier	551G4	333096	NCR	NCR
mini-circuits	Amplifier	ZHL-42W+	QA1341002	NCR	NCR
mini-circuits	Amplifier	ZVE-3W-83+	599201528	NCR	NCR

Note: NCR: "No-Calibration Required"

9. Measurement System Validation

Each DASY system is equipped with one or more system validation kits. These units, together with the predefined measurement procedures within the DASY software, enable the user to conduct the system performance check and system validation. System validation kit includes a dipole, tripod holder to fix it underneath the test Arch and a corresponding distance holder.

The system performance check verifies that the system operates within its specifications. System and operator errors can be detected and corrected. It is recommended that the system performance check be performed prior to any usage of the system in order to guarantee reproducible results. The system performance check uses normal HAC measurements in a simplified setup with a well characterized source. This setup was selected to give a high sensitivity to all parameters that might fail or vary over time. The system check does not intend to replace the calibration of the components, but indicates situations where the system uncertainty is exceeded due to drift or failure.

<Test Setup>

1. In the simplified setup for system evaluation, the EUT is replaced by a calibrated dipole and the power source is replaced by a continuous wave which comes from a signal generator.
2. The center point of the probe element(s) is 15mm from the closest surface of the dipole elements.
3. The calibrated dipole must be placed beneath the arch phantom. The equipment setup is shown below:
4. The output power on dipole port must be calibrated to 20dBm (100mW) before dipole is connected.

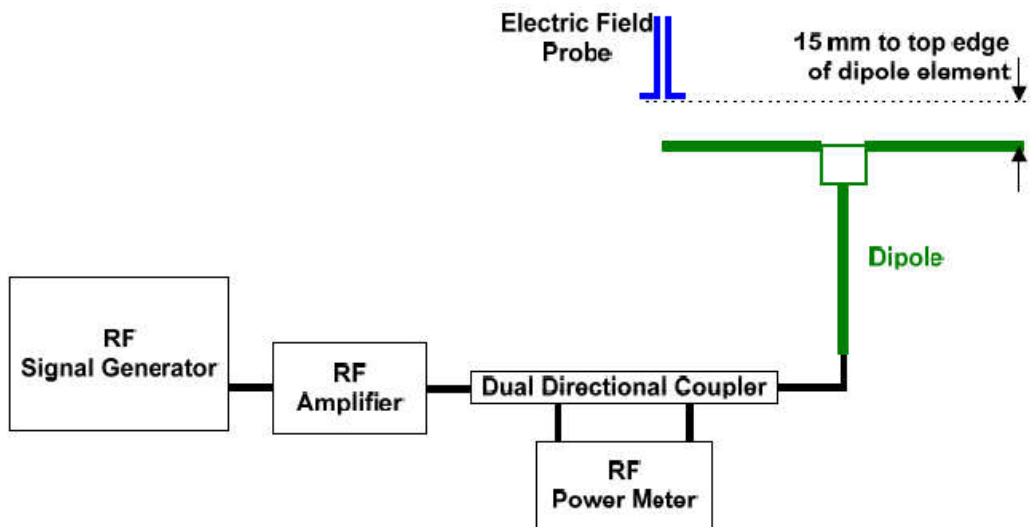

Fig. 7.1 Setup Diagram

<Validation Results>

Comparing to the original E-field value provided by SPEAG, the verification data should be within its specification of 25 %. Table 6.1 shows the target value and measured value. The table below indicates the system performance check can meet the variation criterion and the plots can be referred to appendix A of this report.

$$\text{Deviation} = ((\text{Average E-field Value}) - (\text{Target value})) / (\text{Target value}) * 100\%$$

Frequency (MHz)	Input Power (dBm)	Target Value (V/m)	E-Field above high end (V/m)	E-Field above low end (V/m)	Average Value (V/m)	Deviation (%)	Date
835	20	105.6	99.95	98.67	99.31	-5.96	Jun. 30, 2018
1880	20	88.8	89.18	93.12	91.15	2.65	Jun. 30, 2018
2600	20	85.4	85.60	91.50	88.55	1.97	Jul. 09, 2018

10. Modulation Interference Factor

The HAC Standard ANSI C63.19-2011 defines a new scaling using the Modulation Interference Factor (MIF). For any specific fixed and repeatable modulated signal, a modulation interference factor (MIF, expressed in dB) may be developed that relates its interference potential to its steady-state rms signal level or average power level. This factor is a function only of the audio-frequency amplitude modulation characteristics of the signal and is the same for field-strength and conducted power measurements. It is important to emphasize that the MIF is valid only for a specific repeatable audio-frequency amplitude modulation characteristic. Any change in modulation characteristic requires determination and application of a new MIF

The Modulation Interference factor (MIF, in dB) is added to the measured average E-field (in dBV/m) and converts it to the RF Audio Interference level (in dBV/m). This level considers the audible amplitude modulation components in the RF E-field. CW fields without amplitude modulation are assumed to not interfere with the hearing aid electronics. Modulations without time slots and low fluctuations at low frequencies have low MIF values, TDMA modulations with narrow transmission and repetition rates of few 100 Hz have high MIF values and give similar classifications as ANSI C63.19-2011.

ER3D, EF3D and EU2D E-field probes have a bandwidth <10 kHz and can therefore not evaluate the RF envelope in the full audio band. DASY52 is therefore using the indirect measurement method according to ANSI C63.19-2011 which is the primary method. These near field probes read the averaged E-field measurement. Especially for the new high peak-to-average (PAR) signal types, the probes shall be linearized by PMR calibration in order to not overestimate the field reading. Probe Modulation Response (PMR) calibration linearizes the probe response over its dynamic range for specific modulations which are characterized by their UID and result in an uncertainty specified in the probe calibration certificate. The MIF is characteristic for a given waveform envelope and can be used as a constant conversion factor if the probe has been PMR calibrated.

The evaluation method for the MIF is defined in ANSI C63.19-2011 section D.7. An RMS demodulated RF signal is fed to a spectral filter (similar to an A weighting filter) and forwarded to a temporal filter acting as a quasi-peak detector. The averaged output of these filtering is scaled to a 1 kHz 80% AM signal as reference. MIF measurement requires additional instrumentation and is not well suited for evaluation by the end user with reasonable uncertainty. It may alternatively be determined through analysis and simulation, because it is constant and characteristic for a communication signal. DASY52 uses well-defined signals for PMR calibration. The MIF of these signals has been determined by simulation and it is automatically applied.

The MIF measurement uncertainty is estimated as follows, declared by HAC equipment provider SPEAG, for modulation frequencies from slotted waveforms with fundamental frequency and at least 2 harmonics within 10 kHz:

1. 0.2 dB for MIF: -7 to +5 dB
2. 0.5 dB for MIF: -13 to +11 dB
3. 1 dB for MIF: > -20 dB

MIF values applied in this test report were provided by the HAC equipment provider of SPEAG, and the worst values for all air interface are listed below to be determine the Low-power Exemption.

UID	Communication System Name	MIF(dB)
10021	GSM-FDD(TDMA,GMSK)	3.63
10025	EDGE-FDD (TDMA, 8PSK, TN 0)	3.75
10460	UMTS-FDD(WCDMA, AMR)	-25.43
10225	UMTS-FDD (HSPA+)	-20.39
10081	CDMA2000 (1xRTT, RC3)	-19.71
10295	CDMA2000 (1xRTT, RC1 SO3, 1/8th Rate 25 fr.)	3.26
10403	CDMA2000 (1xEV-DO, Rev. 0)	-17.67
10170	LTE-FDD(SC-FDMA, 1RB, 20MHz, 16-QAM)	-9.76
10172	LTE-TDD (SC-FDMA, 1 RB, 20 MHz, QPSK)	-1.62
10173	LTE-TDD (SC-FDMA, 1 RB, 20 MHz, 16-QAM)	-1.44
10174	LTE-TDD (SC-FDMA, 1 RB, 20 MHz, 64-QAM)	-1.54
10061	IEEE 802.11b WiFi 2.4 GHz (DSSS, 11 Mbps)	-2.02
10077	IEEE 802.11g WiFi 2.4 GHz (DSSS/OFDM, 54 Mbps)	0.12
10427	IEEE 802.11n (HT Greeneld, 150 Mbps, 64-QAM)	-13.44
10069	IEEE 802.11a/h WiFi 5 GHz (OFDM, 54 Mbps)	-3.15
10616	IEEE 802.11ac WiFi (40MHz, MCS0, 90pc duty cycle)	-5.57



11. Low-power Exemption

<Max Tune-up Limit>

Mode		Average Power (dBm)
GSM	GSM850	33.50
	EDGE850	27.50
	GSM1900	30.50
	EDGE1900	26.50
WCDMA	Band V	24.00
	Band IV	24.00
	Band II	24.00
	HSPA	23.00
CDMA	BC0	25.00
	BC1	25.00
	BC10	25.00
	1xEvDO	25.00
FDD LTE	Band 2	25.00
	Band 4	25.00
	Band 5	25.00
	Band 7	23.00
	Band 12	25.00
	Band 13	25.00
	Band 14	25.00
	Band 25	25.00
	Band 26	25.00
Band 66	25.00	
TDD LTE	Band 41_PC2	27.00
	Band 41_PC3	23.00
TDD LTE CA 20MHz+20MHz	Band 41_PC2	25.00
	Band 41_PC3	23.00
2.4GHz WLAN	802.11b	16.00
	802.11g	15.90
	802.11n-HT20	15.80
	802.11n-HT40	15.70
5GHz WLAN	802.11a	17.10
	802.11n-HT20	15.80
	802.11n-HT40	15.70
	802.11ac-VHT20	17.00
	802.11ac-VHT40	17.00
	802.11ac-VHT80	17.00



<Low Power Exemption>

Air Interface	Max Average Antenna Input Power (dBm)	Worst Case MIF (dB)	Power + MIF(dB)	C63.19 test required
GSM850	33.50	3.63	37.13	Yes
EDGE850	27.50	3.75	31.25	Yes ⁽¹⁾
GSM1900	30.50	3.63	34.13	Yes
EDGE1900	26.50	3.75	30.25	Yes ⁽¹⁾
WCDMA	24.00	-25.43	-1.43	No
WCDMA - HSPA	23.00	-20.39	2.61	No
CDMA Full Frame Rate	25.00	-19.71	5.29	No
CDMA 1/8th Frame Rate	25.00	3.26	28.26	Yes
CDMA - EVDO	25.00	-17.67	7.33	No
LTE - FDD	25.00	-9.76	15.24	No
LTE – TDD – Power Class 2	27.00	-1.62	25.38	Yes
LTE – TDD CA - Power Class 2	25.00	-1.62	23.38	Yes
LTE – TDD - Power Class 3	23.00	-1.62	21.38	Yes
LTE – TDD CA –Power Class 3	23.00	-1.62	21.38	Yes
802.11b	16.00	-2.02	13.98	No
802.11g	15.90	0.12	16.02	No
802.11n-HT20	15.80	-13.44	2.36	No
802.11n-HT40	15.70	-13.44	2.26	No
802.11a	17.10	-3.15	13.95	No
802.11n-HT20	15.80	-13.44	2.36	No
802.11n-HT40	15.70	-13.44	2.26	No
802.11ac-VHT20	17.00	-5.57	11.43	No
802.11ac-VHT40	17.00	-5.57	11.43	No
802.11ac-VHT80	17.00	-5.57	11.43	No

General Note:

- EDGE data modes is not necessary due the GSM Voice mode is the worst case.
- According to ANSI C63.19 2011-version, for the air interface technology of a device is exempt from testing when its average antenna input power plus its MIF is ≤17 dBm for any of its operating modes.
- HAC RF rating is M4 for the air interface which meets the low power exemption.

12. Conducted RF Output Power (Unit: dBm)

Average Antenna Input Power(dBm)						
Band	GSM850			GSM1900		
Channel	128	189	251	512	661	810
Frequency (MHz)	824.2	836.4	848.8	1850.2	1880.0	1909.8
GSM (GMSK, 1 Tx slot)	32.57	32.41	32.49	29.15	29.55	29.31

Average Antenna Input Power(dBm)									
Band	CDMA2000 BC0			CDMA2000 BC1			CDMA2000 BC10		
TX Channel	1013	384	777	25	600	1175	476	580	684
Frequency (MHz)	824.7	836.52	848.31	1851.25	1880	1908.75	817.9	820.5	823.1
1xRTT RC1 SO3, 1/8th Rate	23.91	24.05	24.04	24.02	23.89	23.61	23.99	24.02	24.08



<TDD LTE Band 41>
Power Class 2:

BW [MHz]	Modulation	RB Size	RB Offset	Power Low Ch. / Freq.	Power Low Middle Ch. / Freq.	Power Middle Ch. / Freq.	Power High Middle Ch. / Freq.	Power High Ch. / Freq.
Channel				39750	40185	40620	41055	41490
Frequency (MHz)				2506	2549.5	2593	2636.5	2680
20	QPSK	1	0	25.72	25.92	25.97	25.95	25.89
20	QPSK	1	49	25.69	25.91	25.91	25.93	25.86
20	QPSK	1	99	25.76	25.79	25.81	25.91	25.78
20	QPSK	50	0	25.39	25.54	25.66	25.55	25.65
20	QPSK	50	24	25.38	25.47	25.41	25.40	25.62
20	QPSK	50	50	25.34	25.38	25.30	25.29	25.64
20	QPSK	100	0	25.36	25.37	25.65	25.33	25.60

Power Class 3:

BW [MHz]	Modulation	RB Size	RB Offset	Power Low Ch. / Freq.	Power Low Middle Ch. / Freq.	Power Middle Ch. / Freq.	Power High Middle Ch. / Freq.	Power High Ch. / Freq.
Channel				39750	40185	40620	41055	41490
Frequency (MHz)				2506	2549.5	2593	2636.5	2680
20	QPSK	1	0	22.19	22.17	22.25	21.73	22.09
20	QPSK	1	49	22.15	22.16	22.21	21.82	22.06
20	QPSK	1	99	21.92	22.08	22.03	22.01	21.91
20	QPSK	50	0	21.91	21.99	22.10	22.01	21.90
20	QPSK	50	24	21.86	22.06	21.95	21.99	21.85
20	QPSK	50	50	21.83	22.09	21.93	22.04	21.76
20	QPSK	100	0	21.82	21.85	21.89	21.78	21.73



<CA_41C for Power Class 2>

Power State	Combination	PCC							SCC							Power ULCA Tx. Power (dBm)
		PCC Band	PCC Bandwidth (MHz)	PCC (UL/DL) Channel	PCC (UL/DL) Frequency (MHz)	Modulation	PCC UL# RB	PCC UL RB Offset	SCC Band	SCC Bandwidth (MHz)	SCC (UL/DL) Channel	SCC (UL/DL) Frequency (MHz)	Modulation	SCC UL# RB	SCC UL RB Offset	
Full	CA_41C	LTE B41	20	39750	2506	QPSK	1	0	LTE B41	20	39948	2525.8	QPSK	0	0	24.09
		LTE B41	20	40185	2549.5	QPSK	1	0	LTE B41	20	40383	2569.3	QPSK	0	0	23.75
		LTE B41	20	40620	2593	QPSK	1	0	LTE B41	20	40422	2573.2	QPSK	0	0	24.18
		LTE B41	20	41055	2636.5	QPSK	1	0	LTE B41	20	40857	2616.7	QPSK	0	0	23.98
		LTE B41	20	41490	2680	QPSK	1	0	LTE B41	20	41292	2660.2	QPSK	0	0	24.15

<CA_41C for Power Class 3>

Power State	Combination	PCC							SCC							Power ULCA Tx. Power (dBm)
		PCC Band	PCC Bandwidth (MHz)	PCC (UL/DL) Channel	PCC (UL/DL) Frequency (MHz)	Modulation	PCC UL# RB	PCC UL RB Offset	SCC Band	SCC Bandwidth (MHz)	SCC (UL/DL) Channel	SCC (UL/DL) Frequency (MHz)	Modulation	SCC UL# RB	SCC UL RB Offset	
Full	CA_41C	LTE B41	20	39750	2506	QPSK	1	0	LTE B41	20	39948	2525.8	QPSK	0	0	21.97
		LTE B41	20	40185	2549.5	QPSK	1	0	LTE B41	20	40383	2569.3	QPSK	0	0	21.74
		LTE B41	20	40620	2593	QPSK	1	0	LTE B41	20	40422	2573.2	QPSK	0	0	22.22
		LTE B41	20	41055	2636.5	QPSK	1	0	LTE B41	20	40857	2616.7	QPSK	0	0	21.77
		LTE B41	20	41490	2680	QPSK	1	0	LTE B41	20	41292	2660.2	QPSK	0	0	22.18



13. HAC RF Emission Test Results

Plot No.	Air Interface	Mode	Channel	Average Antenna Input Power (dBm)	MIF	E-Field (dBV/m)	Margin to FCC M3 limit (dB)	E-Field M Rating
1	GSM850	GSM Voice	128	32.57	3.63	39.19	5.81	M4
2	GSM850	GSM Voice	189	32.41	3.63	39.29	5.71	M4
3	GSM850	GSM Voice	251	32.49	3.63	38.08	6.92	M4
4	GSM1900	GSM Voice	512	29.15	3.63	33.03	1.97	M3
5	GSM1900	GSM Voice	661	29.55	3.63	31.78	3.22	M3
6	GSM1900	GSM Voice	810	29.31	3.63	31.33	3.67	M3
7	CDMA BC0	RC1 SO3 1/8th Rate	1013	23.91	3.26	30.05	4.95	M4
8	CDMA BC0	RC1 SO3 1/8th Rate	384	24.05	3.26	29.73	5.27	M4
9	CDMA BC0	RC1 SO3 1/8th Rate	777	24.04	3.26	30.07	4.93	M4
10	CDMA BC10	RC1 SO3 1/8th Rate	476	23.99	3.26	30.44	4.56	M4
11	CDMA BC10	RC1 SO3 1/8th Rate	580	24.02	3.26	30.27	4.73	M4
12	CDMA BC10	RC1 SO3 1/8th Rate	684	24.08	3.26	30.10	4.90	M4
13	CDMA BC1	RC1 SO3 1/8th Rate	25	24.02	3.26	27.63	7.37	M4
14	CDMA BC1	RC1 SO3 1/8th Rate	600	23.89	3.26	26.48	8.52	M4
15	CDMA BC1	RC1 SO3 1/8th Rate	1175	23.61	3.26	25.91	9.09	M4
16	LTE Band 41(Class 2)	20M_QPSK_1RB_99offset	39750	25.72	-1.62	23.49	11.51	M4
17	LTE Band 41(Class 2)	20M_QPSK_1RB_99offset	40185	25.92	-1.62	22.37	12.63	M4
18	LTE Band 41(Class 2)	20M_QPSK_1RB_99offset	40620	25.97	-1.62	22.21	12.79	M4
19	LTE Band 41(Class 2)	20M_QPSK_1RB_99offset	41055	25.95	-1.62	21.08	13.92	M4
20	LTE Band 41(Class 2)	20M_QPSK_1RB_99offset	41490	25.89	-1.62	22.23	12.77	M4
21	LTE Band 41 CA (Class 2)	20M_QPSK_1RB_0offset	PCC: 39750 SCC: 39948	24.09	-1.62	21.73	13.27	M4
22	LTE Band 41 CA (Class 2)	20M_QPSK_1RB_0offset	PCC: 40185 SCC: 40383	23.75	-1.62	20.72	14.28	M4
23	LTE Band 41 CA (Class 2)	20M_QPSK_1RB_0offset	PCC: 40620 SCC: 40422	24.18	-1.62	21.86	13.14	M4
24	LTE Band 41 CA (Class 2)	20M_QPSK_1RB_0offset	PCC: 41055 SCC: 40857	23.98	-1.62	21.01	13.99	M4
25	LTE Band 41 CA (Class 2)	20M_QPSK_1RB_0offset	PCC: 41490 SCC: 41292	24.15	-1.62	20.24	14.76	M4
26	LTE Band 41(Class 3)	20M_QPSK_1RB_0offset	39750	22.19	-1.62	21.18	13.82	M4
27	LTE Band 41(Class 3)	20M_QPSK_1RB_0offset	40185	22.17	-1.62	20.56	14.44	M4
28	LTE Band 41(Class 3)	20M_QPSK_1RB_0offset	40620	22.25	-1.62	20.21	14.79	M4
29	LTE Band 41(Class 3)	20M_QPSK_1RB_0offset	41055	21.73	-1.62	19.43	15.57	M4
30	LTE Band 41(Class 3)	20M_QPSK_1RB_0offset	41490	22.09	-1.62	20.02	14.98	M4
31	LTE Band 41 CA (Class 3)	20M_QPSK_1RB_0offset	PCC: 39750 SCC: 39948	21.97	-1.62	21.37	13.63	M4
32	LTE Band 41 CA (Class 3)	20M_QPSK_1RB_0offset	PCC: 40185 SCC: 40383	21.74	-1.62	20.58	14.42	M4
33	LTE Band 41 CA (Class 3)	20M_QPSK_1RB_0offset	PCC: 40620 SCC: 40422	22.22	-1.62	20.14	14.86	M4
34	LTE Band 41 CA (Class 3)	20M_QPSK_1RB_0offset	PCC: 41055 SCC: 40857	21.77	-1.62	19.66	15.34	M4
35	LTE Band 41 CA (Class 3)	20M_QPSK_1RB_0offset	PCC: 41490 SCC: 41292	22.18	-1.62	18.78	16.22	M4

Remark:

- The HAC measurement system applies MIF value onto the measured RMS E-field, which is indirect method in ANSI C63.19 2011 version, and reports the RF audio interference level.
- Phone Condition: Mute on; Backlight off; Max Volume

Test Engineer : Nick Hu.



14. Uncertainty Assessment

The component of uncertainty may generally be categorized according to the methods used to evaluate them. The evaluation of uncertainty by the statistical analysis of a series of observations is termed a Type A evaluation of uncertainty. The evaluation of uncertainty by means other than the statistical analysis of a series of observation is termed a Type B evaluation of uncertainty. Each component of uncertainty, however evaluated, is represented by an estimated standard deviation, termed standard uncertainty, which is determined by the positive square root of the estimated variance.

The combined standard uncertainty of the measurement result represents the estimated standard deviation of the result. It is obtained by combining the individual standard uncertainties of both Type A and Type B evaluation using the usual “root-sum-squares” (RSS) methods of combining standard deviations by taking the positive square root of the estimated variances. Expanded uncertainty is a measure of uncertainty that defines an interval about the measurement result within which the measured value is confidently believed to lie. It is obtained by multiplying the combined standard uncertainty by a coverage factor. For purpose of this document, a coverage factor two is used, which corresponds to confidence interval of about 95 %. The DASY uncertainty Budget is showed in Table 12.1.



Error Description	Uncertainty Value (±%)	Probability Distribution	Divisor	Ci (E)	Standard Uncertainty (E)
Measurement System					
Probe Calibration	5.1	Normal	1	1	± 5.1 %
Axial Isotropy	4.7	Rectangular	√3	1	± 2.7 %
Sensor Displacement	16.5	Rectangular	√3	1	± 9.5 %
Boundary Effects	2.4	Rectangular	√3	1	± 1.4 %
Phantom Boundary Effects	7.2	Rectangular	√3	1	± 4.1 %
Linearity	4.7	Rectangular	√3	1	± 2.7 %
Scaling with PMR Calibration	10.0	Rectangular	√3	1	± 5.77 %
System Detection Limit	1.0	Rectangular	√3	1	± 0.6 %
Readout Electronics	0.3	Normal	1	1	± 0.3 %
Response Time	0.8	Rectangular	√3	1	± 0.5 %
Integration Time	2.6	Rectangular	√3	1	± 1.5 %
RF Ambient Conditions	3.0	Rectangular	√3	1	± 1.7 %
RF Reflections	12.0	Rectangular	√3	1	± 6.9 %
Probe Positioner	1.2	Rectangular	√3	1	± 0.7 %
Probe Positioning	4.7	Rectangular	√3	1	± 2.7 %
Extrap. and Interpolation	1.0	Rectangular	√3	1	± 0.6 %
Test Sample Related					
Device Positioning Vertical	4.7	Rectangular	√3	1	± 2.7 %
Device Positioning Lateral	1.0	Rectangular	√3	1	± 0.6 %
Device Holder and Phantom	2.4	Rectangular	√3	1	± 1.4 %
Power Drift	5.0	Rectangular	√3	1	± 2.9 %
Phantom and Setup Related					
Phantom Thickness	2.4	Rectangular	√3	1	± 1.4 %
Combined Standard Uncertainty					± 16.30 %
Coverage Factor for 95 %					K = 2
Expanded Std. Uncertainty on Power					± 32.6 %
Expanded Std. Uncertainty on Field					± 16.3 %

Table 12.1 Uncertainty Budget of HAC free field assessment

Remark:

Worst-Case uncertainty budget for HAC free field assessment according to ANSIC63.19 [1], [2]. The budget is valid for the frequency range 700 MHz - 3 GHz and represents a worst case analysis.



15. References

- [1] ANSI C63.19-2011, "American National Standard for Methods of Measurement of Compatibility between Wireless Communications Devices and Hearing Aids", 27 May 2011.
- [2] FCC KDB 285076 D01v05, "Equipment Authorization Guidance for Hearing Aid Compatibility", Sep 2017
- [3] FCC KDB 285076 D02v03, "Guidance for performing T-Coil tests for air interfaces supporting voice over IP (e.g., LTE and WiFi) to support CMRS based telephone services", Sep 2017
- [4] FCC KDB 285076 D03v01, "Hearing aid compatibility frequently asked questions", Sep 2017
- [5] SPEAG DASY System Handbook



Appendix A. Plots of System Performance Check

The plots are shown as follows.

HAC_E_Dipole_835

Communication System: UID 0, CW; Frequency: 835 MHz; Duty Cycle: 1:1

Medium: Air Medium parameters used: $\sigma = 0$ S/m, $\epsilon_r = 1$; $\rho = 0$ kg/m³

Ambient Temperature : 23.5 °C

DASY5 Configuration:

- Probe: EF3DV3 - SN4050; ConvF(1, 1, 1); Calibrated: 2018.1.9;
- Sensor-Surface: (Fix Surface)
- Electronics: DAE4 Sn1338; Calibrated: 2017.12.4
- Phantom: HAC Test Arch with AMCC; Type: SD HAC P01 BA;
- Measurement SW: DASY52, Version 52.8 (8); SEMCAD X Version 14.6.10 (7331)

E Scan - measurement distance from the probe sensor center to CD835 = 15mm/Hearing Aid Compatibility Test at 15mm distance (41x361x1): Interpolated grid:

dx=0.5000 mm, dy=0.5000 mm

Device Reference Point: 0, 0, -6.3 mm

Reference Value = 95.73 V/m; Power Drift = 0.02 dB

PMR not calibrated. PMF = 1.000 is applied.

E-field emissions = 96.20 V/m

Average value of Total=(99.95+98.67)/2=99.31 V/m

PMF scaled E-field

Grid 1 M4 96.70 V/m	Grid 2 M4 99.95 V/m	Grid 3 M4 96.73 V/m
Grid 4 M4 59.26 V/m	Grid 5 M4 59.22 V/m	Grid 6 M4 58.45 V/m
Grid 7 M4 96.48 V/m	Grid 8 M4 98.67 V/m	Grid 9 M4 96.32 V/m

Cursor:

Total = 97.90 V/m

E Category: M4

Location: 0, 78.5, 9.7 mm

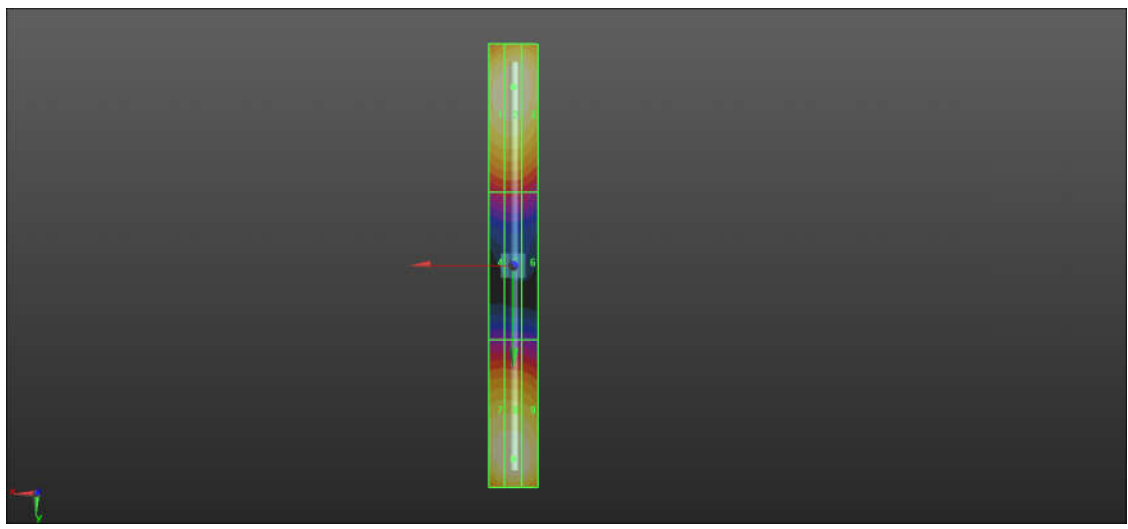
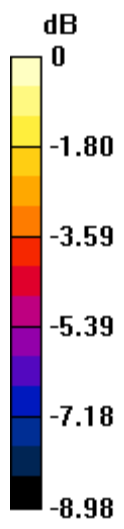

0 dB = 97.90 V/m = 39.82 dBV/m

HAC_E_Dipole_1880

Communication System: UID 0, CW; Frequency: 1880 MHz; Duty Cycle: 1:1

Medium: Air Medium parameters used: $\sigma = 0$ S/m, $\epsilon_r = 1$; $\rho = 0$ kg/m³

Ambient Temperature : 23.5 °C

DASY5 Configuration:

- Probe: EF3DV3 - SN4050; ConvF(1, 1, 1); Calibrated: 2018.1.9;
- Sensor-Surface: (Fix Surface)
- Electronics: DAE4 Sn1338; Calibrated: 2017.12.4
- Phantom: HAC Test Arch with AMCC; Type: SD HAC P01 BA;
- Measurement SW: DASY52, Version 52.8 (8); SEMCAD X Version 14.6.10 (7331)

E Scan - measurement distance from the probe sensor center to CD1880 = 15mm/Hearing Aid Compatibility Test at 15mm distance (41x181x1): Interpolated grid:

dx=0.5000 mm, dy=0.5000 mm

Device Reference Point: 0, 0, -6.3 mm

Reference Value = 146.5 V/m; Power Drift = -0.03 dB

PMR not calibrated. PMF = 1.000 is applied.

E-field emissions = 92.12 V/m

Average value of Total=(89.18+93.12)/2=91.15 V/m

PMF scaled E-field

Grid 1 M3 88.43 V/m	Grid 2 M3 89.18 V/m	Grid 3 M3 89.02 V/m
Grid 4 M3 70.86 V/m	Grid 5 M3 71.85 V/m	Grid 6 M3 70.62 V/m
Grid 7 M3 83.59 V/m	Grid 8 M3 93.12 V/m	Grid 9 M3 84.16 V/m

Cursor:

Total = 90.18 V/m

E Category: M3

Location: 0, -31, 9.7 mm

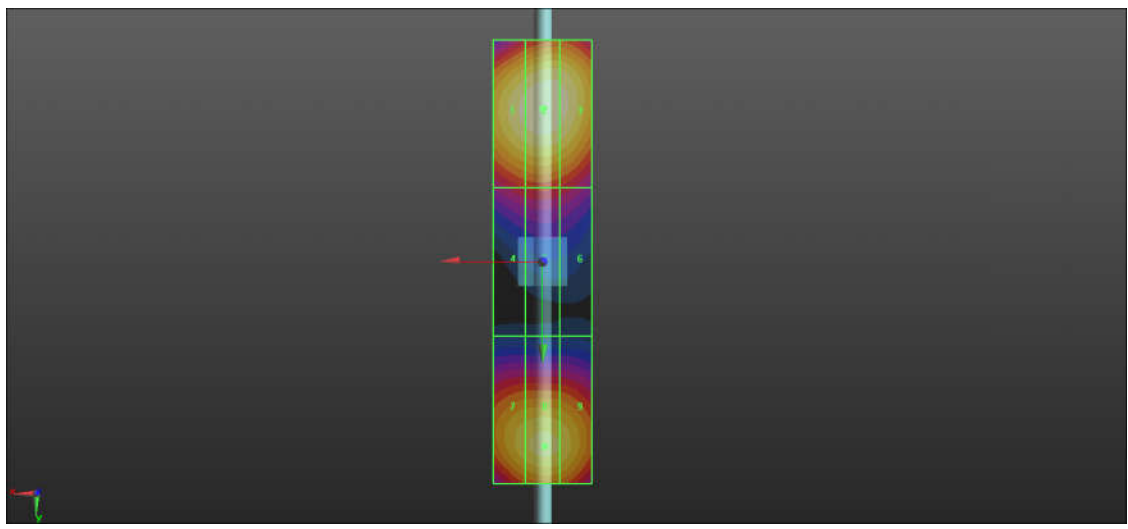
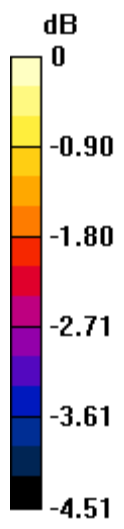

0 dB = 90.18 V/m = 39.10 dBV/m

HAC_E_Dipole_2600_180709

DUT: HAC-Dipole 2600 MHz

Communication System: UID 0, CW; Frequency: 2600 MHz; Duty Cycle: 1:1

Medium: Air Medium parameters used: $\sigma = 0$ S/m, $\epsilon_r = 1$; $\rho = 0$ kg/m³

Ambient Temperature : 23.4 °C

DASY5 Configuration:

- Probe: EF3DV3 - SN4053; ConvF(1, 1, 1); Calibrated: 2018.03.19;
- Sensor-Surface: (Fix Surface)
- Electronics: DAE4 Sn1386; Calibrated: 2017.07.20
- Phantom: HAC Test Arch with AMCC; Type: SD HAC P01 BA;
- Measurement SW: DASY52, Version 52.8 (8); SEMCAD X Version 14.6.10 (7331)

E Scan - measurement distance from the probe sensor center to CD1880 = 10mm & 15mm/Hearing Aid Compatibility Test at 15mm distance (41x181x1): Interpolated grid:

dx=0.5000 mm, dy=0.5000 mm

Device Reference Point: 0, 0, -6.3 mm

Reference Value = 72.77 V/m; Power Drift = -0.05 dB

PMR not calibrated. PMF = 1.000 is applied.

E-field emissions = 92.89 V/m

Average value of Total=(85.6+91.5) / 2 = 88.55 V/m

PMF scaled E-field

Grid 1 M3 84.01 V/m	Grid 2 M3 85.6 V/m	Grid 3 M3 82.73 V/m
Grid 4 M3 87.67 V/m	Grid 5 M3 89.38 V/m	Grid 6 M3 88.33 V/m
Grid 7 M3 90.87 V/m	Grid 8 M3 91.5 V/m	Grid 9 M3 91.06 V/m

Cursor:

Total = 92.49 V/m

E Category: M3

Location: 1, -33.5, 9.7 mm

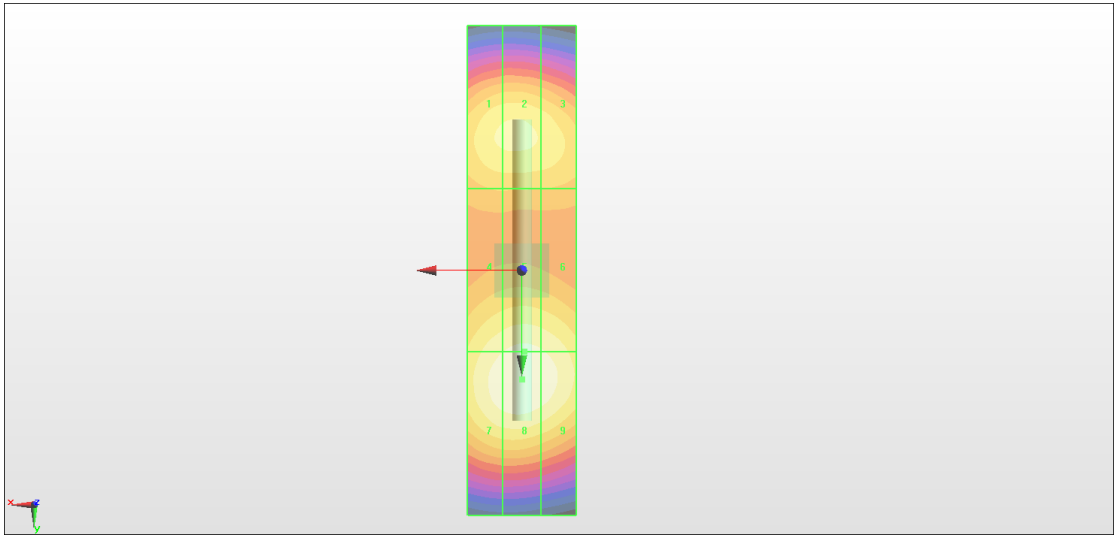
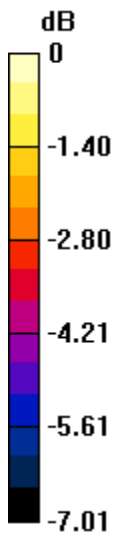

0 dB = 92.89 V/m = 39.33 dBV/m



Appendix B. Plots of RF Emission Measurement

The plots are shown as follows.

1 HAC RF GSM850_Voice_Ch128

Communication System: UID 10021 - DAB, GSM-FDD (TDMA, GMSK); Frequency: 824.2 MHz; Duty Cycle: 1:8.3

Medium: Air Medium parameters used: $\sigma = 0$ S/m, $\epsilon_r = 1$; $\rho = 0$ kg/m³

Ambient Temperature : 23.5 °C

DASY5 Configuration:

- Probe: EF3DV3 - SN4050; ConvF(1, 1, 1); Calibrated: 2018.1.9;
- Sensor-Surface: (Fix Surface)
- Electronics: DAE4 Sn1338; Calibrated: 2017.12.4
- Phantom: HAC Test Arch with AMCC; Type: SD HAC P01 BA;
- Measurement SW: DASY52, Version 52.8 (8); SEMCAD X Version 14.6.10 (7331)

Ch128/Hearing Aid Compatibility Test (101x101x1): Interpolated grid: dx=0.5000 mm, dy=0.5000 mm

Device Reference Point: 0, 0, -6.3 mm

Reference Value = 73.73 V/m; Power Drift = -0.02 dB

Applied MIF = 3.63 dB

RF audio interference level = 39.19 dBV/m

Emission category: M4

MIF scaled E-field

Grid 1 M4 37.49 dBV/m	Grid 2 M4 38.85 dBV/m	Grid 3 M4 38.85 dBV/m
Grid 4 M4 37.7 dBV/m	Grid 5 M4 39.19 dBV/m	Grid 6 M4 39.19 dBV/m
Grid 7 M4 37.99 dBV/m	Grid 8 M4 39.23 dBV/m	Grid 9 M4 39.23 dBV/m

Cursor:

Total = 39.23 dBV/m

E Category: M4

Location: -8.5, 19, 8.7 mm

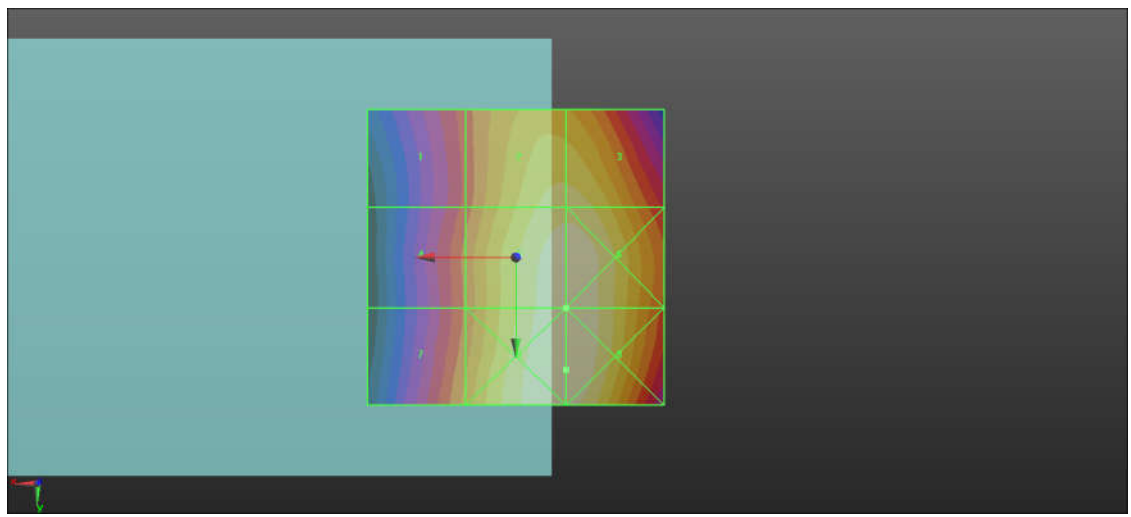
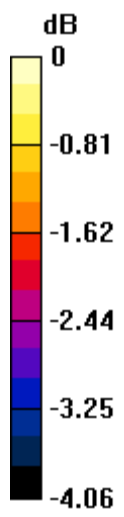

0 dB = 91.47 V/m = 39.23 dBV/m

2 HAC RF GSM850_Voice_Ch189

Communication System: UID 10021 - DAB, GSM-FDD (TDMA, GMSK); Frequency: 836.4 MHz; Duty Cycle: 1:8.3

Medium: Air Medium parameters used: $\sigma = 0$ S/m, $\epsilon_r = 1$; $\rho = 0$ kg/m³

Ambient Temperature : 23.5 °C

DASY5 Configuration:

- Probe: EF3DV3 - SN4050; ConvF(1, 1, 1); Calibrated: 2018.1.9;
- Sensor-Surface: (Fix Surface)
- Electronics: DAE4 Sn1338; Calibrated: 2017.12.4
- Phantom: HAC Test Arch with AMCC; Type: SD HAC P01 BA;
- Measurement SW: DASY52, Version 52.8 (8); SEMCAD X Version 14.6.10 (7331)

Ch189/Hearing Aid Compatibility Test (101x101x1): Interpolated grid: dx=0.5000 mm, dy=0.5000 mm

Device Reference Point: 0, 0, -6.3 mm

Reference Value = 74.19 V/m; Power Drift = -0.09 dB

Applied MIF = 3.63 dB

RF audio interference level = 39.29 dBV/m

Emission category: M4

MIF scaled E-field

Grid 1 M4 37.58 dBV/m	Grid 2 M4 38.89 dBV/m	Grid 3 M4 38.89 dBV/m
Grid 4 M4 37.72 dBV/m	Grid 5 M4 39.29 dBV/m	Grid 6 M4 39.29 dBV/m
Grid 7 M4 37.9 dBV/m	Grid 8 M4 39.31 dBV/m	Grid 9 M4 39.29 dBV/m

Cursor:

Total = 39.31 dBV/m

E Category: M4

Location: -5.5, 19.5, 8.7 mm

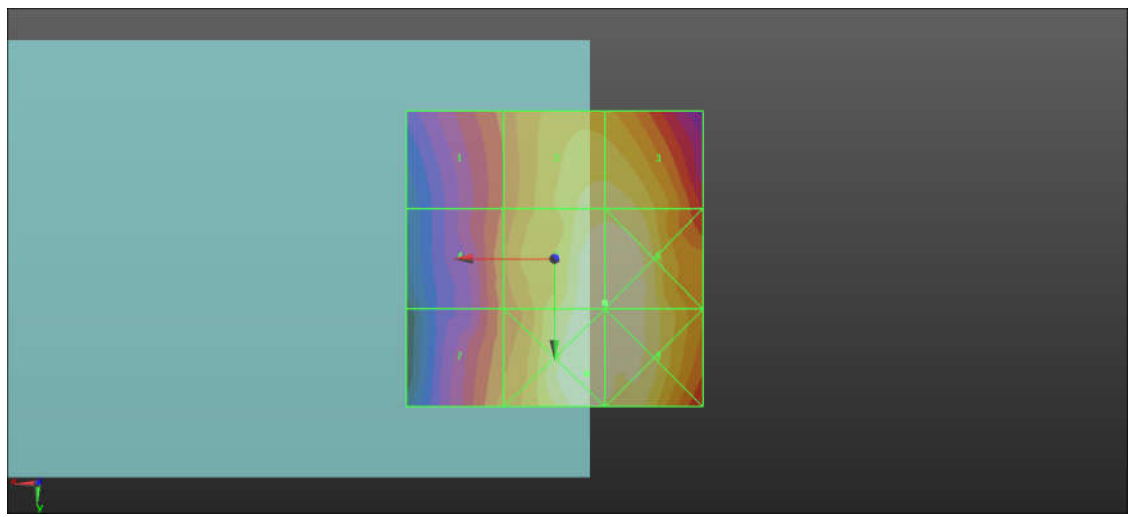
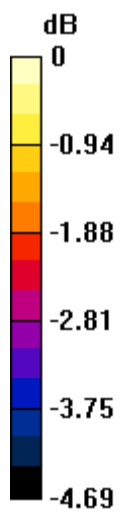

0 dB = 92.37 V/m = 39.31 dBV/m

3 HAC RF GSM850_Voice_Ch251

Communication System: UID 10021 - DAB, GSM-FDD (TDMA, GMSK); Frequency: 848.8 MHz; Duty Cycle: 1:8.3

Medium: Air Medium parameters used: $\sigma = 0$ S/m, $\epsilon_r = 1$; $\rho = 0$ kg/m³

Ambient Temperature : 23.5 °C

DASY5 Configuration:

- Probe: EF3DV3 - SN4050; ConvF(1, 1, 1); Calibrated: 2018.1.9;
- Sensor-Surface: (Fix Surface)
- Electronics: DAE4 Sn1338; Calibrated: 2017.12.4
- Phantom: HAC Test Arch with AMCC; Type: SD HAC P01 BA;
- Measurement SW: DASY52, Version 52.8 (8); SEMCAD X Version 14.6.10 (7331)

Ch251/Hearing Aid Compatibility Test (101x101x1): Interpolated grid: dx=0.5000 mm, dy=0.5000 mm

Device Reference Point: 0, 0, -6.3 mm

Reference Value = 65.34 V/m; Power Drift = -0.03 dB

Applied MIF = 3.63 dB

RF audio interference level = 38.08 dBV/m

Emission category: M4

MIF scaled E-field

Grid 1 M4 36.91 dBV/m	Grid 2 M4 37.69 dBV/m	Grid 3 M4 37.69 dBV/m
Grid 4 M4 36.57 dBV/m	Grid 5 M4 38.08 dBV/m	Grid 6 M4 38.09 dBV/m
Grid 7 M4 36.59 dBV/m	Grid 8 M4 38.15 dBV/m	Grid 9 M4 38.15 dBV/m

Cursor:

Total = 38.15 dBV/m

E Category: M4

Location: -9, 17.5, 8.7 mm

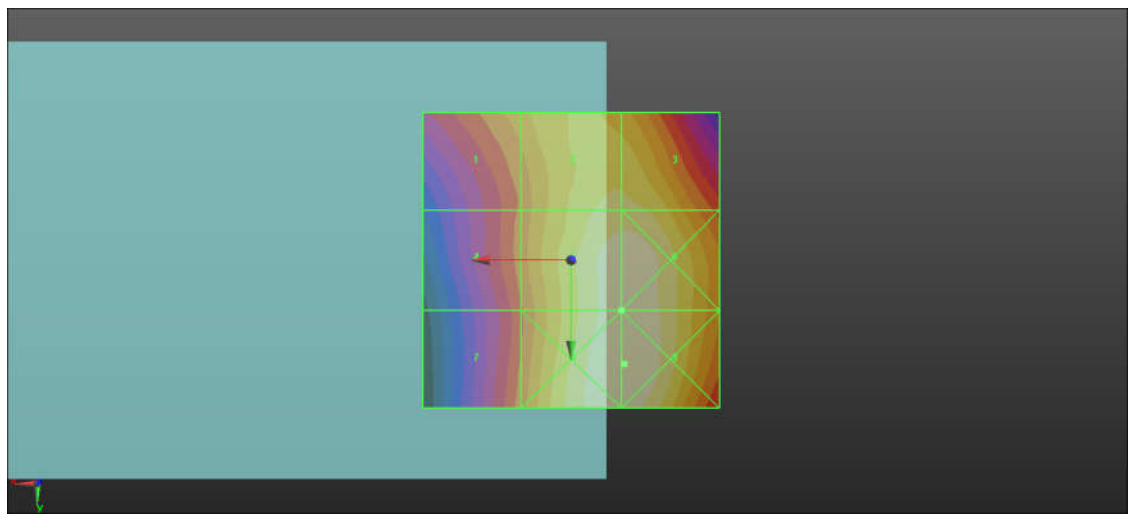
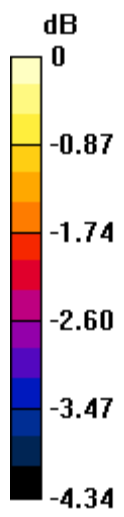

0 dB = 80.85 V/m = 38.15 dBV/m

4 HAC RF GSM1900_Voice_Ch512

Communication System: UID 10021 - DAB, GSM-FDD (TDMA, GMSK); Frequency: 1850.2 MHz; Duty Cycle: 1:8.3

Medium: Air Medium parameters used: $\sigma = 0$ S/m, $\epsilon_r = 1$; $\rho = 0$ kg/m³

Ambient Temperature : 23.5 °C

DASY5 Configuration:

- Probe: EF3DV3 - SN4050; ConvF(1, 1, 1); Calibrated: 2018.1.9;
- Sensor-Surface: (Fix Surface)
- Electronics: DAE4 Sn1338; Calibrated: 2017.12.4
- Phantom: HAC Test Arch with AMCC; Type: SD HAC P01 BA;
- Measurement SW: DASY52, Version 52.8 (8); SEMCAD X Version 14.6.10 (7331)

Ch512/Hearing Aid Compatibility Test (101x101x1): Interpolated grid: dx=0.5000 mm, dy=0.5000 mm

Device Reference Point: 0, 0, -6.3 mm

Reference Value = 31.78 V/m; Power Drift = -0.06 dB

Applied MIF = 3.63 dB

RF audio interference level = 33.03 dBV/m

Emission category: M3

MIF scaled E-field

Grid 1 M4 27.92 dBV/m	Grid 2 M3 31.88 dBV/m	Grid 3 M3 32.08 dBV/m
Grid 4 M4 28.86 dBV/m	Grid 5 M3 33.03 dBV/m	Grid 6 M3 33.14 dBV/m
Grid 7 M4 29.88 dBV/m	Grid 8 M3 33.04 dBV/m	Grid 9 M3 33.15 dBV/m

Cursor:

Total = 33.15 dBV/m

E Category: M3

Location: -11.5, 10, 8.7 mm

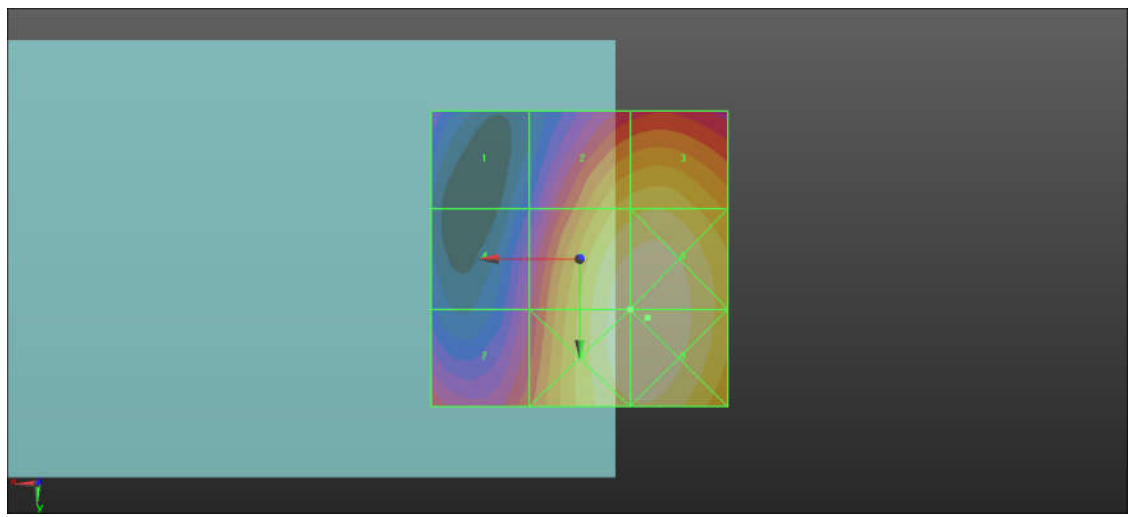
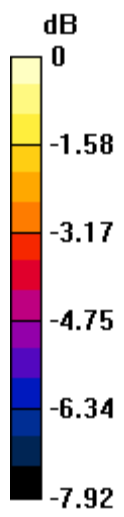

0 dB = 45.43 V/m = 33.15 dBV/m

5 HAC RF GSM1900_Voice_Ch661

Communication System: UID 10021 - DAB, GSM-FDD (TDMA, GMSK); Frequency: 1880 MHz; Duty Cycle: 1:8.3

Medium: Air Medium parameters used: $\sigma = 0$ S/m, $\epsilon_r = 1$; $\rho = 0$ kg/m³

Ambient Temperature : 23.5 °C

DASY5 Configuration:

- Probe: EF3DV3 - SN4050; ConvF(1, 1, 1); Calibrated: 2018.1.9;
- Sensor-Surface: (Fix Surface)
- Electronics: DAE4 Sn1338; Calibrated: 2017.12.4
- Phantom: HAC Test Arch with AMCC; Type: SD HAC P01 BA;
- Measurement SW: DASY52, Version 52.8 (8); SEMCAD X Version 14.6.10 (7331)

Ch661/Hearing Aid Compatibility Test (101x101x1): Interpolated grid: dx=0.5000 mm, dy=0.5000 mm

Device Reference Point: 0, 0, -6.3 mm

Reference Value = 27.01 V/m; Power Drift = -0.12 dB

Applied MIF = 3.63 dB

RF audio interference level = 31.78 dBV/m

Emission category: M3

MIF scaled E-field

Grid 1 M4 27.66 dBV/m	Grid 2 M3 30.9 dBV/m	Grid 3 M3 31.19 dBV/m
Grid 4 M4 27.83 dBV/m	Grid 5 M3 31.78 dBV/m	Grid 6 M3 32.03 dBV/m
Grid 7 M3 30.2 dBV/m	Grid 8 M3 31.78 dBV/m	Grid 9 M3 32.03 dBV/m

Cursor:

Total = 32.03 dBV/m

E Category: M3

Location: -13.5, 7, 8.7 mm

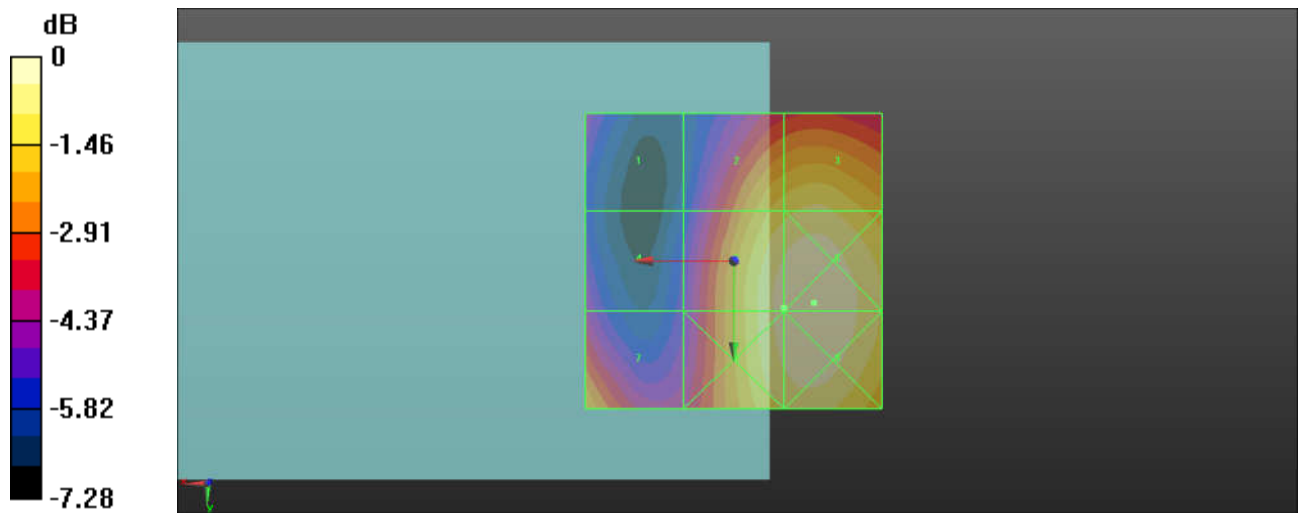

0 dB = 39.96 V/m = 32.03 dBV/m

6 HAC RF GSM1900_Voice_Ch810

Communication System: UID 10021 - DAB, GSM-FDD (TDMA, GMSK); Frequency: 1909.8 MHz; Duty Cycle: 1:8.3

Medium: Air Medium parameters used: $\sigma = 0$ S/m, $\epsilon_r = 1$; $\rho = 0$ kg/m³

Ambient Temperature : 23.5 °C

DASY5 Configuration:

- Probe: EF3DV3 - SN4050; ConvF(1, 1, 1); Calibrated: 2018.1.9;
- Sensor-Surface: (Fix Surface)
- Electronics: DAE4 Sn1338; Calibrated: 2017.12.4
- Phantom: HAC Test Arch with AMCC; Type: SD HAC P01 BA;
- Measurement SW: DASY52, Version 52.8 (8); SEMCAD X Version 14.6.10 (7331)

Ch810/Hearing Aid Compatibility Test (101x101x1): Interpolated grid: dx=0.5000 mm, dy=0.5000 mm

Device Reference Point: 0, 0, -6.3 mm

Reference Value = 25.73 V/m; Power Drift = -0.07 dB

Applied MIF = 3.63 dB

RF audio interference level = 31.33 dBV/m

Emission category: M3

MIF scaled E-field

Grid 1 M4 27.38 dBV/m	Grid 2 M4 29.97 dBV/m	Grid 3 M3 30.2 dBV/m
Grid 4 M4 27.17 dBV/m	Grid 5 M3 31.33 dBV/m	Grid 6 M3 31.44 dBV/m
Grid 7 M4 28.48 dBV/m	Grid 8 M3 31.37 dBV/m	Grid 9 M3 31.47 dBV/m

Cursor:

Total = 31.47 dBV/m

E Category: M3

Location: -11.5, 11.5, 8.7 mm

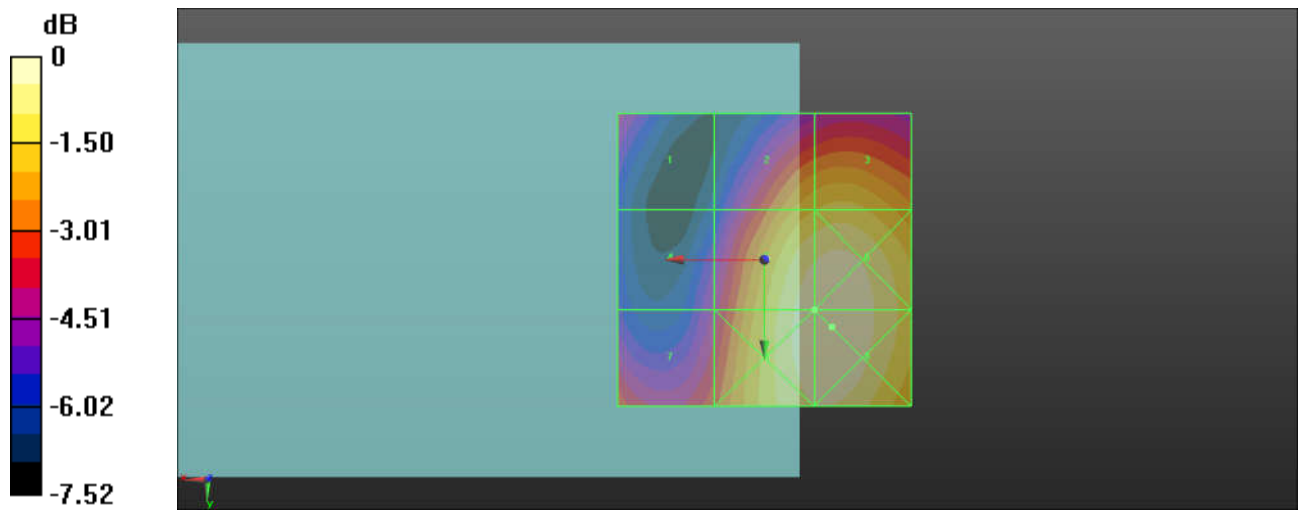

0 dB = 37.47 V/m = 31.47 dBV/m

7 HAC RF CDMA2000 BC0_1xRTT, RC1 SO3, 1/8th Rate_Ch1013

Communication System: UID 10295 - AAB, CDMA2000, RC1, SO3, 1/8th Rate 25 fr.; Frequency: 824.7 MHz; Duty Cycle: 1:8.3

Medium: Air Medium parameters used: $\sigma = 0$ S/m, $\epsilon_r = 1$; $\rho = 0$ kg/m³

Ambient Temperature : 23.5 °C

DASY5 Configuration:

- Probe: EF3DV3 - SN4050; ConvF(1, 1, 1); Calibrated: 2018.1.9;
- Sensor-Surface: (Fix Surface)
- Electronics: DAE4 Sn1338; Calibrated: 2017.12.4
- Phantom: HAC Test Arch with AMCC; Type: SD HAC P01 BA;
- Measurement SW: DASY52, Version 52.8 (8); SEMCAD X Version 14.6.10 (7331)

Ch1013/Hearing Aid Compatibility Test (101x101x1): Interpolated grid: dx=0.5000 mm, dy=0.5000 mm

Device Reference Point: 0, 0, -6.3 mm

Reference Value = 27.78 V/m; Power Drift = -0.05 dB

Applied MIF = 3.26 dB

RF audio interference level = 30.05 dBV/m

Emission category: M4

MIF scaled E-field

Grid 1 M4 28.63 dBV/m	Grid 2 M4 29.66 dBV/m	Grid 3 M4 29.66 dBV/m
Grid 4 M4 28.46 dBV/m	Grid 5 M4 30.05 dBV/m	Grid 6 M4 30.08 dBV/m
Grid 7 M4 28.61 dBV/m	Grid 8 M4 30.17 dBV/m	Grid 9 M4 30.17 dBV/m

Cursor:

Total = 30.17 dBV/m

E Category: M4

Location: -9, 19.5, 8.7 mm

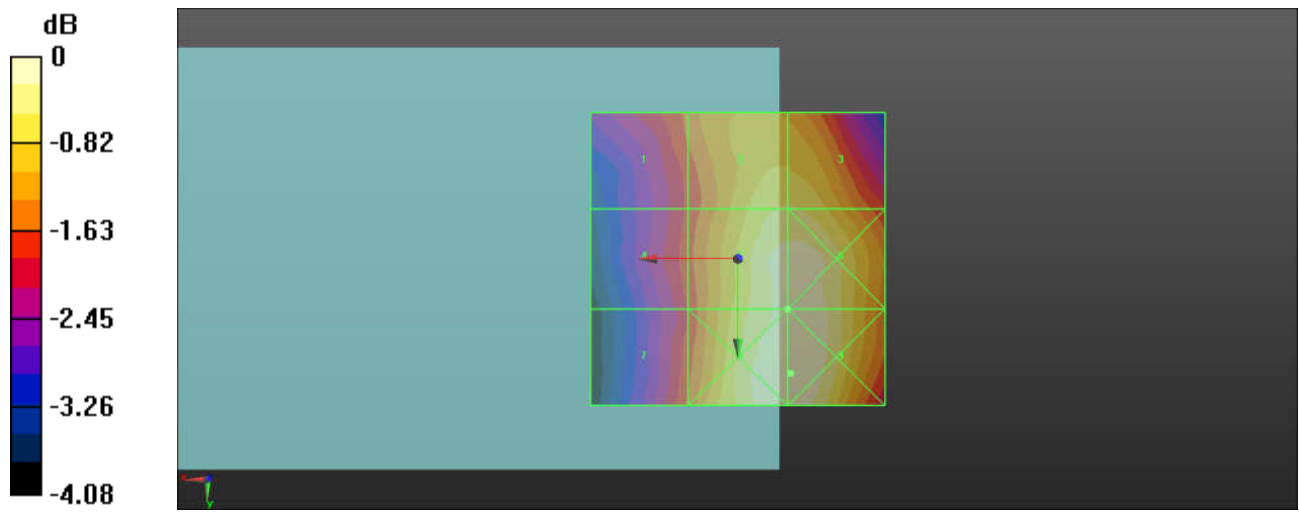

0 dB = 32.25 V/m = 30.17 dBV/m

8 HAC RF CDMA2000 BC0_1xRTT, RC1 SO3, 1/8th Rate_Ch384

Communication System: UID 10295 - AAB, CDMA2000, RC1, SO3, 1/8th Rate 25 fr.; Frequency: 836.52 MHz; Duty Cycle: 1:8.3

Medium: Air Medium parameters used: $\sigma = 0$ S/m, $\epsilon_r = 1$; $\rho = 0$ kg/m³

Ambient Temperature : 23.5 °C

DASY5 Configuration:

- Probe: EF3DV3 - SN4050; ConvF(1, 1, 1); Calibrated: 2018.1.9;
- Sensor-Surface: (Fix Surface)
- Electronics: DAE4 Sn1338; Calibrated: 2017.12.4
- Phantom: HAC Test Arch with AMCC; Type: SD HAC P01 BA;
- Measurement SW: DASY52, Version 52.8 (8); SEMCAD X Version 14.6.10 (7331)

Ch384/Hearing Aid Compatibility Test (101x101x1): Interpolated grid: dx=0.5000 mm, dy=0.5000 mm

Device Reference Point: 0, 0, -6.3 mm

Reference Value = 28.50 V/m; Power Drift = -0.01 dB

Applied MIF = 3.26 dB

RF audio interference level = 29.73 dBV/m

Emission category: M4

MIF scaled E-field

Grid 1 M4 29.6 dBV/m	Grid 2 M4 29.95 dBV/m	Grid 3 M4 29.68 dBV/m
Grid 4 M4 28.98 dBV/m	Grid 5 M4 29.73 dBV/m	Grid 6 M4 29.69 dBV/m
Grid 7 M4 28.34 dBV/m	Grid 8 M4 29.39 dBV/m	Grid 9 M4 29.36 dBV/m

Cursor:

Total = 29.95 dBV/m

E Category: M4

Location: 0, -25, 8.7 mm

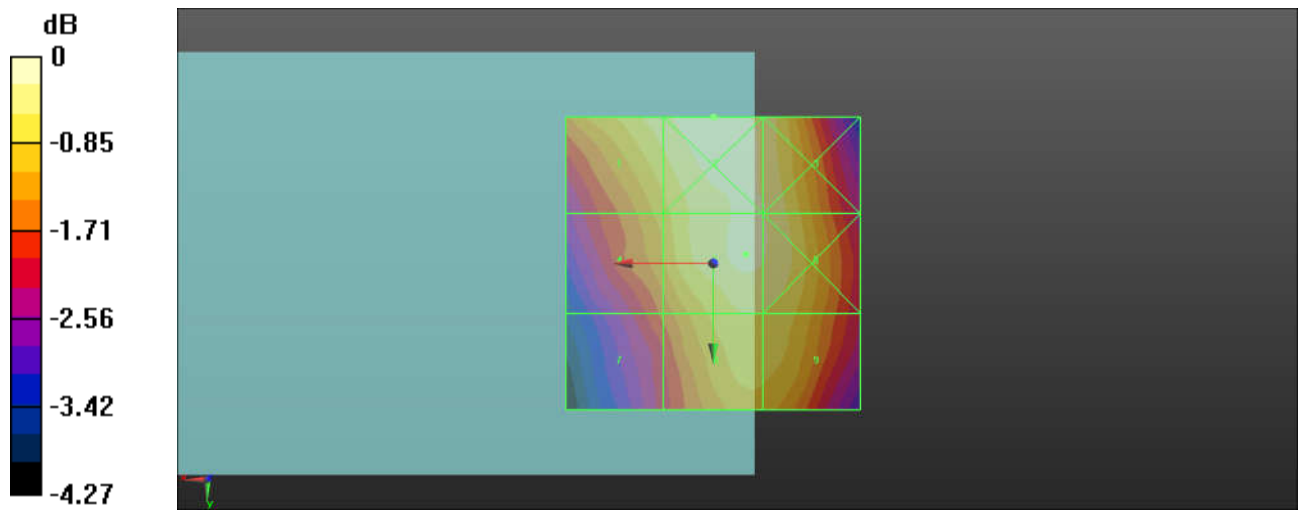

0 dB = 31.43 V/m = 29.95 dBV/m

9 HAC RF CDMA2000 BC0_1xRTT, RC1 SO3, 1/8th Rate_Ch777

Communication System: UID 10295 - AAB, CDMA2000, RC1, SO3, 1/8th Rate 25 fr.; Frequency: 848.31 MHz; Duty Cycle: 1:8.3

Medium: Air Medium parameters used: $\sigma = 0$ S/m, $\epsilon_r = 1$; $\rho = 0$ kg/m³

Ambient Temperature : 23.5 °C

DASY5 Configuration:

- Probe: EF3DV3 - SN4050; ConvF(1, 1, 1); Calibrated: 2018.1.9;
- Sensor-Surface: (Fix Surface)
- Electronics: DAE4 Sn1338; Calibrated: 2017.12.4
- Phantom: HAC Test Arch with AMCC; Type: SD HAC P01 BA;
- Measurement SW: DASY52, Version 52.8 (8); SEMCAD X Version 14.6.10 (7331)

Ch777/Hearing Aid Compatibility Test (101x101x1): Interpolated grid: dx=0.5000 mm, dy=0.5000 mm

Device Reference Point: 0, 0, -6.3 mm

Reference Value = 29.62 V/m; Power Drift = 0.06 dB

Applied MIF = 3.26 dB

RF audio interference level = 30.07 dBV/m

Emission category: M4

MIF scaled E-field

Grid 1 M4 30.1 dBV/m	Grid 2 M4 30.41 dBV/m	Grid 3 M4 30.09 dBV/m
Grid 4 M4 29.43 dBV/m	Grid 5 M4 30.07 dBV/m	Grid 6 M4 29.86 dBV/m
Grid 7 M4 28.66 dBV/m	Grid 8 M4 29.33 dBV/m	Grid 9 M4 29.12 dBV/m

Cursor:

Total = 30.41 dBV/m

E Category: M4

Location: 0, -25, 8.7 mm

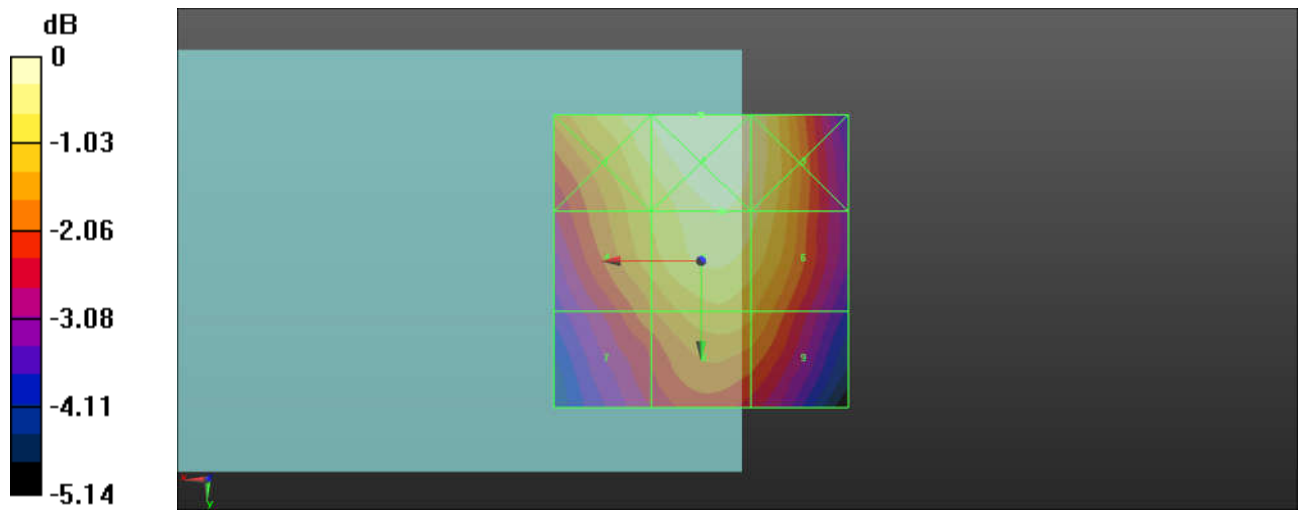

0 dB = 33.14 V/m = 30.41 dBV/m

10 HAC RF CDMA2000 BC10_1xRTT, RC1 SO3, 1/8th Rate_Ch476

Communication System: UID 10295 - AAB, CDMA2000, RC1, SO3, 1/8th Rate 25 fr.; Frequency: 817.9 MHz; Duty Cycle: 1:8.3

Medium: Air Medium parameters used: $\sigma = 0$ S/m, $\epsilon_r = 1$; $\rho = 0$ kg/m³

Ambient Temperature : 23.5 °C

DASY5 Configuration:

- Probe: EF3DV3 - SN4050; ConvF(1, 1, 1); Calibrated: 2018.1.9;
- Sensor-Surface: (Fix Surface)
- Electronics: DAE4 Sn1338; Calibrated: 2017.12.4
- Phantom: HAC Test Arch with AMCC; Type: SD HAC P01 BA;
- Measurement SW: DASY52, Version 52.8 (8); SEMCAD X Version 14.6.10 (7331)

Ch476/Hearing Aid Compatibility Test (101x101x1): Interpolated grid: dx=0.5000 mm, dy=0.5000 mm

Device Reference Point: 0, 0, -6.3 mm

Reference Value = 27.76 V/m; Power Drift = 0.02 dB

Applied MIF = 3.26 dB

RF audio interference level = 30.44 dBV/m

Emission category: M4

MIF scaled E-field

Grid 1 M4 28.75 dBV/m	Grid 2 M4 30.06 dBV/m	Grid 3 M4 30.06 dBV/m
Grid 4 M4 28.77 dBV/m	Grid 5 M4 30.44 dBV/m	Grid 6 M4 30.44 dBV/m
Grid 7 M4 29.07 dBV/m	Grid 8 M4 30.56 dBV/m	Grid 9 M4 30.56 dBV/m

Cursor:

Total = 30.56 dBV/m

E Category: M4

Location: -9, 15.5, 8.7 mm

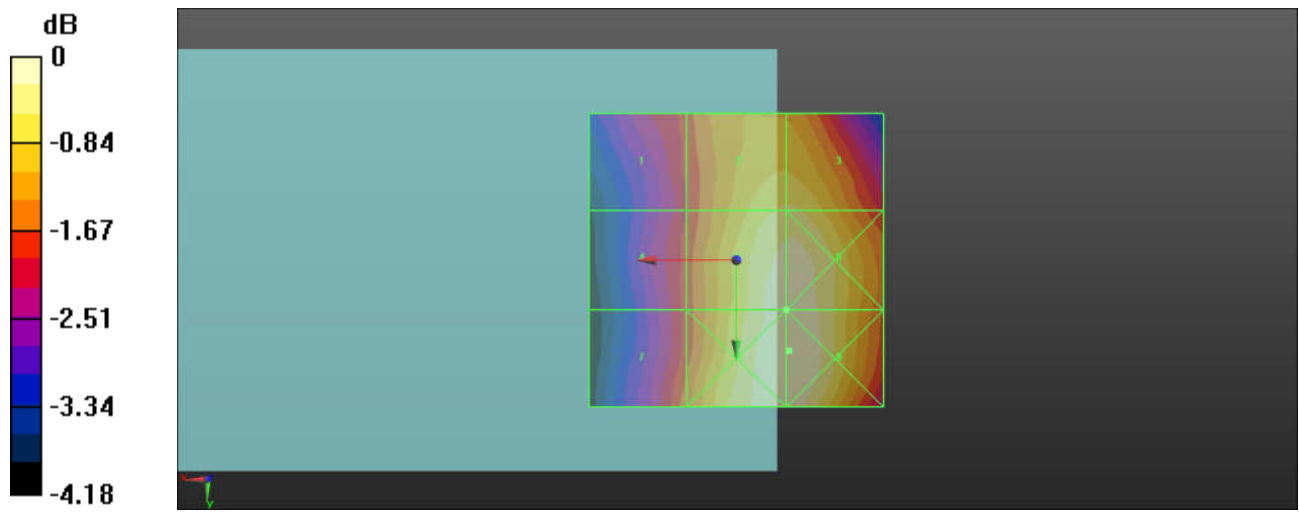

0 dB = 33.74 V/m = 30.56 dBV/m

11 HAC RF CDMA2000 BC10_1xRTT, RC1 SO3, 1/8th Rate_Ch580

Communication System: UID 10295 - AAB, CDMA2000, RC1, SO3, 1/8th Rate 25 fr.; Frequency: 820.5 MHz; Duty Cycle: 1:8.3

Medium: Air Medium parameters used: $\sigma = 0$ S/m, $\epsilon_r = 1$; $\rho = 0$ kg/m³

Ambient Temperature : 23.5 °C

DASY5 Configuration:

- Probe: EF3DV3 - SN4050; ConvF(1, 1, 1); Calibrated: 2018.1.9;
- Sensor-Surface: (Fix Surface)
- Electronics: DAE4 Sn1338; Calibrated: 2017.12.4
- Phantom: HAC Test Arch with AMCC; Type: SD HAC P01 BA;
- Measurement SW: DASY52, Version 52.8 (8); SEMCAD X Version 14.6.10 (7331)

Ch580/Hearing Aid Compatibility Test (101x101x1): Interpolated grid: dx=0.5000 mm, dy=0.5000 mm

Device Reference Point: 0, 0, -6.3 mm

Reference Value = 28.11 V/m; Power Drift = -0.04 dB

Applied MIF = 3.26 dB

RF audio interference level = 30.27 dBV/m

Emission category: M4

MIF scaled E-field

Grid 1 M4 28.72 dBV/m	Grid 2 M4 29.84 dBV/m	Grid 3 M4 29.84 dBV/m
Grid 4 M4 28.6 dBV/m	Grid 5 M4 30.24 dBV/m	Grid 6 M4 30.27 dBV/m
Grid 7 M4 35.17 dBV/m	Grid 8 M4 30.37 dBV/m	Grid 9 M4 30.37 dBV/m

Cursor:

Total = 35.17 dBV/m

E Category: M4

Location: 25, 25, 8.7 mm

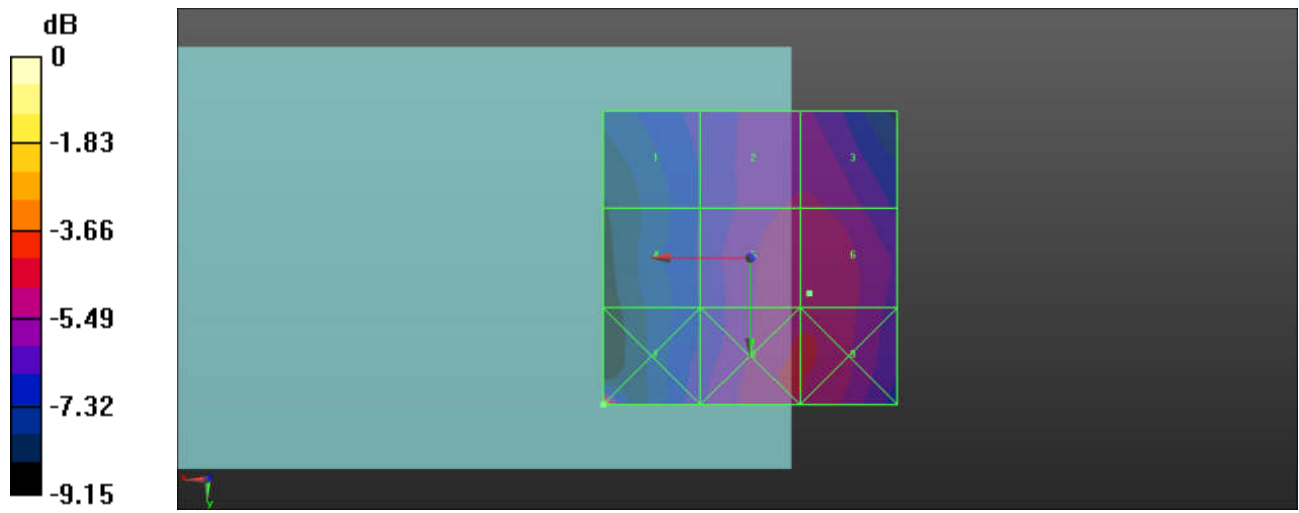

0 dB = 57.37 V/m = 35.17 dBV/m

12 HAC RF CDMA2000 BC10_1xRTT, RC1 SO3, 1/8th Rate_Ch684

Communication System: UID 10295 - AAB, CDMA2000, RC1, SO3, 1/8th Rate 25 fr.; Frequency: 823.1 MHz; Duty Cycle: 1:8.3

Medium: Air Medium parameters used: $\sigma = 0$ S/m, $\epsilon_r = 1$; $\rho = 0$ kg/m³

Ambient Temperature : 23.5 °C

DASY5 Configuration:

- Probe: EF3DV3 - SN4050; ConvF(1, 1, 1); Calibrated: 2018.1.9;
- Sensor-Surface: (Fix Surface)
- Electronics: DAE4 Sn1338; Calibrated: 2017.12.4
- Phantom: HAC Test Arch with AMCC; Type: SD HAC P01 BA;
- Measurement SW: DASY52, Version 52.8 (8); SEMCAD X Version 14.6.10 (7331)

Ch684/Hearing Aid Compatibility Test (101x101x1): Interpolated grid: dx=0.5000 mm, dy=0.5000 mm

Device Reference Point: 0, 0, -6.3 mm

Reference Value = 27.73 V/m; Power Drift = -0.03 dB

Applied MIF = 3.26 dB

RF audio interference level = 30.10 dBV/m

Emission category: M4

MIF scaled E-field

Grid 1 M4 28.6 dBV/m	Grid 2 M4 29.68 dBV/m	Grid 3 M4 29.68 dBV/m
Grid 4 M4 28.44 dBV/m	Grid 5 M4 30.1 dBV/m	Grid 6 M4 30.13 dBV/m
Grid 7 M4 28.69 dBV/m	Grid 8 M4 30.19 dBV/m	Grid 9 M4 30.19 dBV/m

Cursor:

Total = 30.19 dBV/m

E Category: M4

Location: -9, 18.5, 8.7 mm

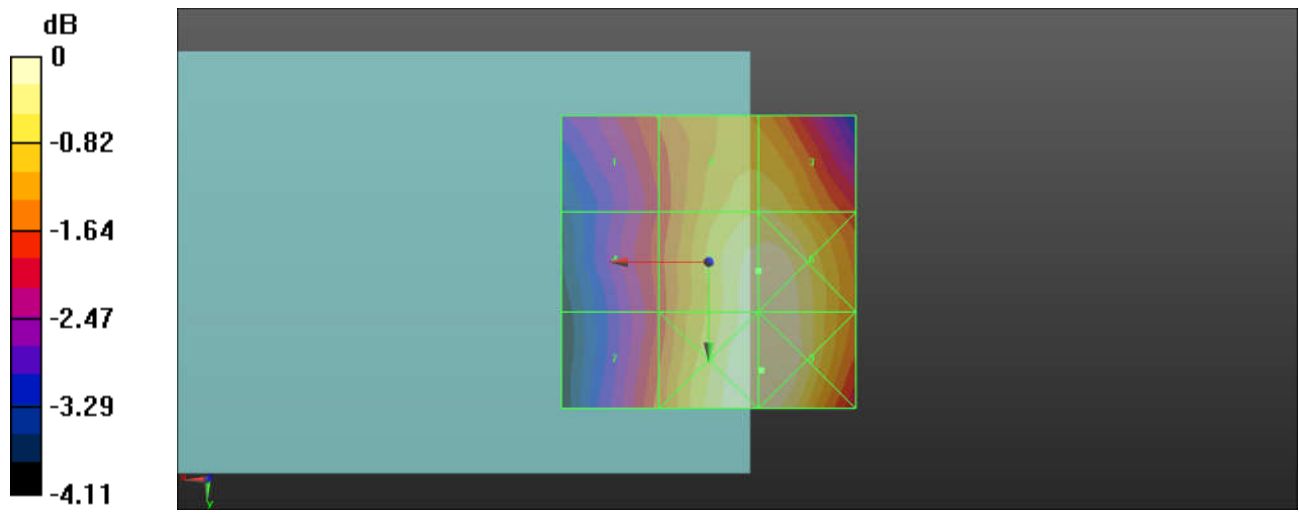

0 dB = 32.33 V/m = 30.19 dBV/m

13 HAC RF CDMA2000 BC1_1xRTT, RC1 SO3, 1/8th Rate_Ch25

Communication System: UID 10295 - AAB, CDMA2000, RC1, SO3, 1/8th Rate 25 fr.; Frequency: 1851.25 MHz; Duty Cycle: 1:8.3

Medium: Air Medium parameters used: $\sigma = 0$ S/m, $\epsilon_r = 1$; $\rho = 0$ kg/m³

Ambient Temperature : 23.5 °C

DASY5 Configuration:

- Probe: EF3DV3 - SN4050; ConvF(1, 1, 1); Calibrated: 2018.1.9;
- Sensor-Surface: (Fix Surface)
- Electronics: DAE4 Sn1338; Calibrated: 2017.12.4
- Phantom: HAC Test Arch with AMCC; Type: SD HAC P01 BA;
- Measurement SW: DASY52, Version 52.8 (8); SEMCAD X Version 14.6.10 (7331)

Ch25/Hearing Aid Compatibility Test (101x101x1): Interpolated grid: dx=0.5000 mm, dy=0.5000 mm

Device Reference Point: 0, 0, -6.3 mm

Reference Value = 18.19 V/m; Power Drift = 0.01 dB

Applied MIF = 3.26 dB

RF audio interference level = 27.63 dBV/m

Emission category: M4

MIF scaled E-field

Grid 1 M4 22.39 dBV/m	Grid 2 M4 26.39 dBV/m	Grid 3 M4 26.6 dBV/m
Grid 4 M4 23.32 dBV/m	Grid 5 M4 27.63 dBV/m	Grid 6 M4 27.72 dBV/m
Grid 7 M4 24.21 dBV/m	Grid 8 M4 27.73 dBV/m	Grid 9 M4 27.79 dBV/m

Cursor:

Total = 27.79 dBV/m

E Category: M4

Location: -11, 14, 8.7 mm

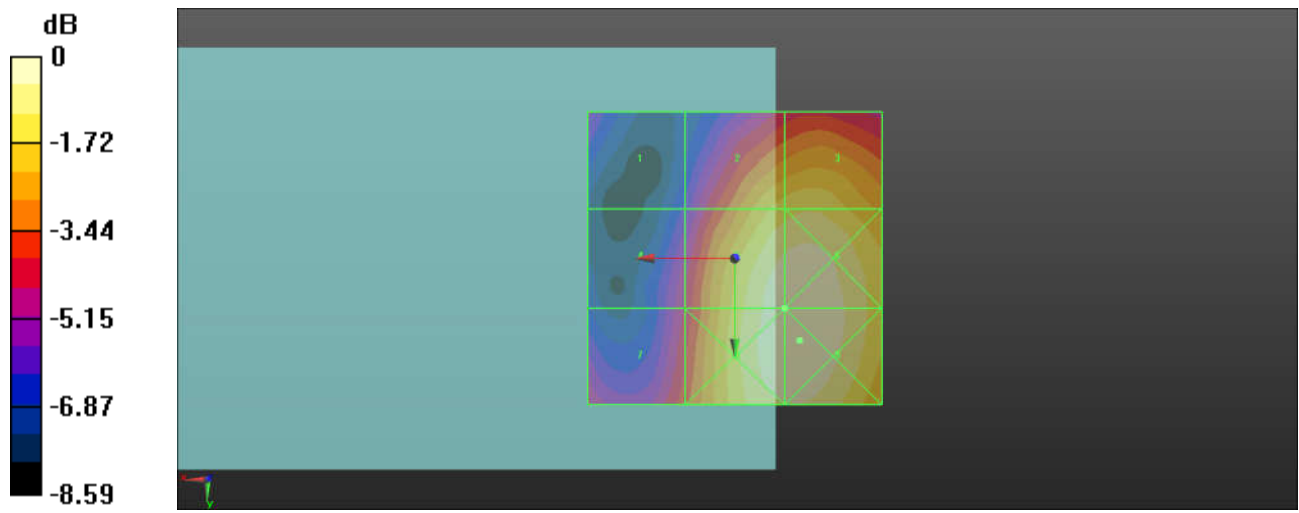

0 dB = 24.53 V/m = 27.79 dBV/m

14 HAC RF CDMA2000 BC1_1xRTT, RC1 SO3, 1/8th Rate_Ch600

Communication System: UID 10295 - AAB, CDMA2000, RC1, SO3, 1/8th Rate 25 fr.; Frequency: 1880 MHz; Duty Cycle: 1:8.3

Medium: Air Medium parameters used: $\sigma = 0$ S/m, $\epsilon_r = 1$; $\rho = 0$ kg/m³

Ambient Temperature : 23.5 °C

DASY5 Configuration:

- Probe: EF3DV3 - SN4050; ConvF(1, 1, 1); Calibrated: 2018.1.9;
- Sensor-Surface: (Fix Surface)
- Electronics: DAE4 Sn1338; Calibrated: 2017.12.4
- Phantom: HAC Test Arch with AMCC; Type: SD HAC P01 BA;
- Measurement SW: DASY52, Version 52.8 (8); SEMCAD X Version 14.6.10 (7331)

Ch600/Hearing Aid Compatibility Test (101x101x1): Interpolated grid: dx=0.5000 mm, dy=0.5000 mm

Device Reference Point: 0, 0, -6.3 mm

Reference Value = 16.23 V/m; Power Drift = -0.04 dB

Applied MIF = 3.26 dB

RF audio interference level = 26.48 dBV/m

Emission category: M4

MIF scaled E-field

Grid 1 M4 22.28 dBV/m	Grid 2 M4 25.61 dBV/m	Grid 3 M4 25.84 dBV/m
Grid 4 M4 21.88 dBV/m	Grid 5 M4 26.48 dBV/m	Grid 6 M4 26.64 dBV/m
Grid 7 M4 24.34 dBV/m	Grid 8 M4 26.47 dBV/m	Grid 9 M4 26.65 dBV/m

Cursor:

Total = 26.65 dBV/m

E Category: M4

Location: -13, 10, 8.7 mm

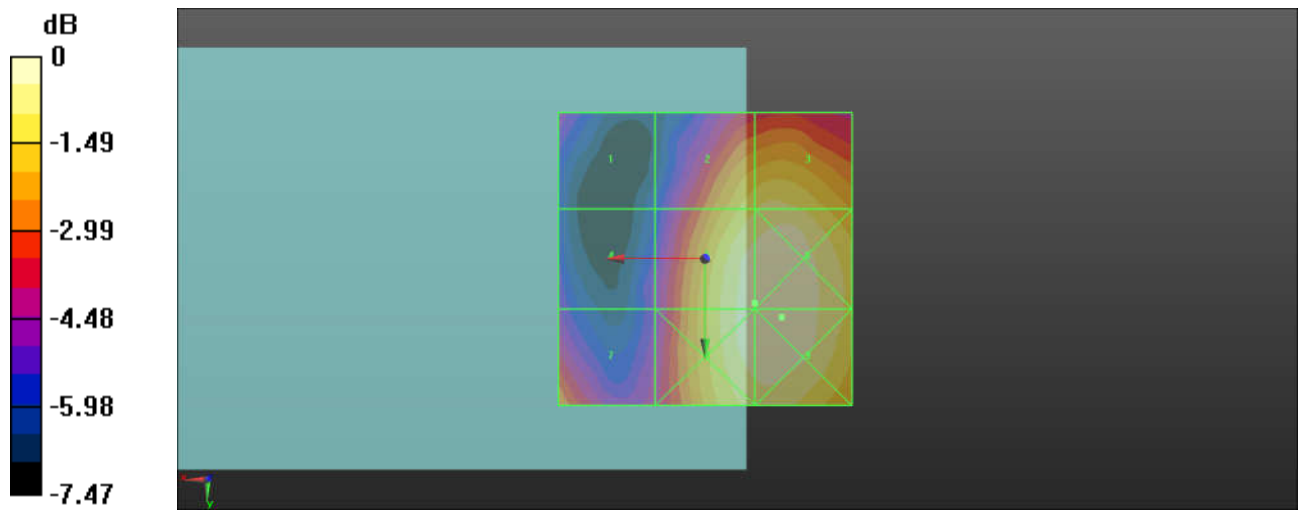

0 dB = 21.49 V/m = 26.65 dBV/m

15 HAC RF CDMA2000 BC1_1xRTT, RC1 SO3, 1/8th RateCh1175

Communication System: UID 10295 - AAB, CDMA2000, RC1, SO3, 1/8th Rate 25 fr.; Frequency: 1908.75 MHz; Duty Cycle: 1:8.3

Medium: Air Medium parameters used: $\sigma = 0$ S/m, $\epsilon_r = 1$; $\rho = 0$ kg/m³

Ambient Temperature : 23.5 °C

DASY5 Configuration:

- Probe: EF3DV3 - SN4050; ConvF(1, 1, 1); Calibrated: 2018.1.9;
- Sensor-Surface: (Fix Surface)
- Electronics: DAE4 Sn1338; Calibrated: 2017.12.4
- Phantom: HAC Test Arch with AMCC; Type: SD HAC P01 BA;
- Measurement SW: DASY52, Version 52.8 (8); SEMCAD X Version 14.6.10 (7331)

Ch1175/Hearing Aid Compatibility Test (101x101x1): Interpolated grid: dx=0.5000 mm, dy=0.5000 mm

Device Reference Point: 0, 0, -6.3 mm

Reference Value = 14.56 V/m; Power Drift = -0.05 dB

Applied MIF = 3.26 dB

RF audio interference level = 25.91 dBV/m

Emission category: M4

MIF scaled E-field

Grid 1 M4 21.89 dBV/m	Grid 2 M4 24.34 dBV/m	Grid 3 M4 24.54 dBV/m
Grid 4 M4 21.21 dBV/m	Grid 5 M4 25.91 dBV/m	Grid 6 M4 26.02 dBV/m
Grid 7 M4 22.42 dBV/m	Grid 8 M4 26.02 dBV/m	Grid 9 M4 26.11 dBV/m

Cursor:

Total = 26.11 dBV/m

E Category: M4

Location: -11, 14, 8.7 mm

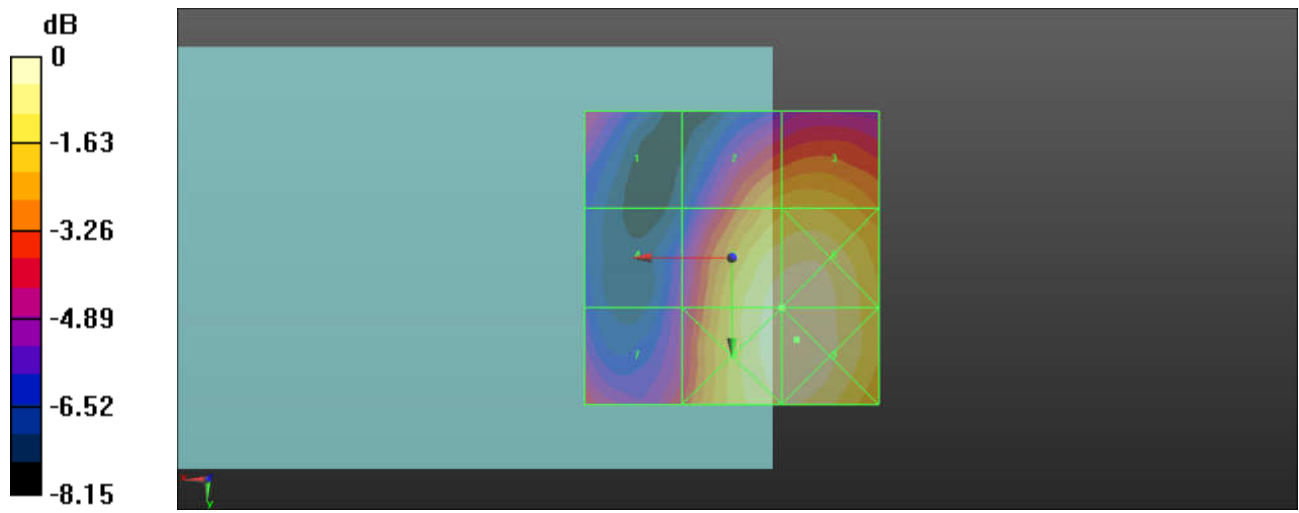

0 dB = 20.21 V/m = 26.11 dBV/m

16_HAC RF_LTE Band41_20M_QPSK_1RB_0offset_Ch39750

Communication System: UID 10172 - CAC, LTE-TDD (SC-FDMA, 1 RB, 20 MHz, QPSK);
 Frequency: 2506 MHz; Duty Cycle: 1:1

Medium: Air Medium parameters used: $\sigma = 0$ S/m, $\epsilon_r = 1$; $\rho = 0$ kg/m³

Ambient Temperature : 23.4 °C

DASY5 Configuration:

- Probe: EF3DV3 - SN4053; ConvF(1, 1, 1); Calibrated: 2018.03.19;
- Sensor-Surface: (Fix Surface)
- Electronics: DAE4 Sn1386; Calibrated: 2017.07.20
- Phantom: HAC Test Arch with AMCC; Type: SD HAC P01 BA;
- Measurement SW: DASY52, Version 52.8 (8); SEMCAD X Version 14.6.10 (7331)

Ch39750/Hearing Aid Compatibility Test (101x101x1): Interpolated grid: dx=0.5000 mm, dy=0.5000 mm

Device Reference Point: 0, 0, -6.3 mm

Reference Value = 11.90 V/m; Power Drift = 0.17 dB

Applied MIF = -1.62 dB

RF audio interference level = 23.49 dBV/m

Emission category: M4

MIF scaled E-field

Grid 1 M4 21.84 dBV/m	Grid 2 M4 21.82 dBV/m	Grid 3 M4 22.6 dBV/m
Grid 4 M4 21.9 dBV/m	Grid 5 M4 22.35 dBV/m	Grid 6 M4 23.31 dBV/m
Grid 7 M4 23.49 dBV/m	Grid 8 M4 22.16 dBV/m	Grid 9 M4 23.2 dBV/m

Total = 23.49 dBV/m

E Category: M4

Location: 25, 25, 8.7 mm

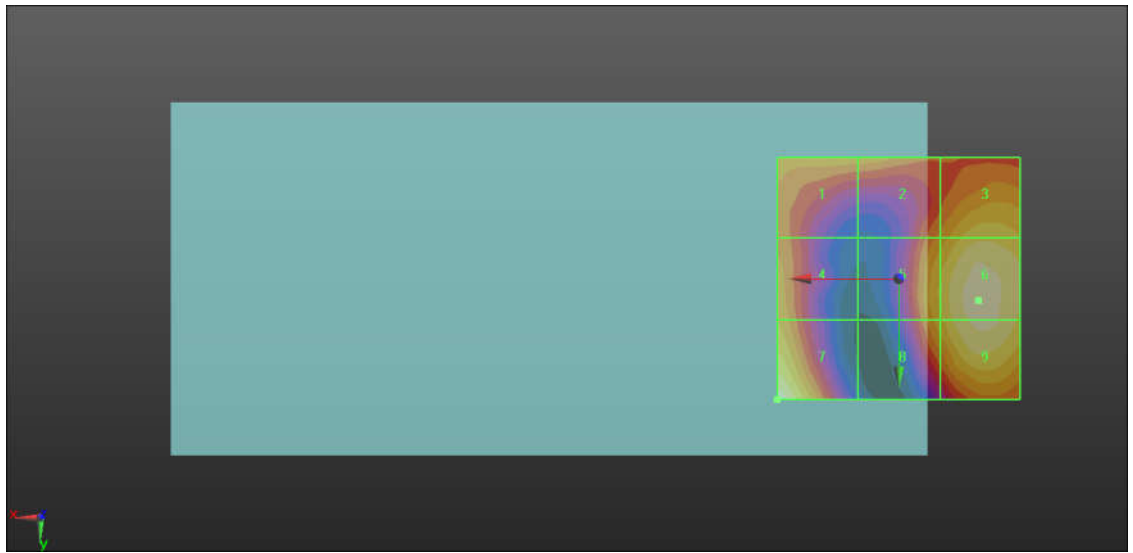
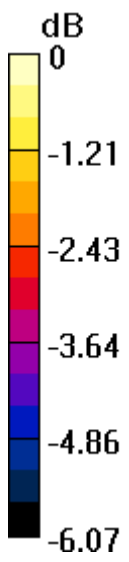

0 dB = 14.94 V/m = 23.49 dBV/m

17_HAC RF_LTE Band41_20M_QPSK_1RB_0offset_Ch40185

Communication System: UID 10172 - CAC, LTE-TDD (SC-FDMA, 1 RB, 20 MHz, QPSK);
 Frequency: 2549.5 MHz; Duty Cycle: 1:1

Medium: Air Medium parameters used: $\sigma = 0$ S/m, $\epsilon_r = 1$; $\rho = 0$ kg/m³

Ambient Temperature : 23.4 °C

DASY5 Configuration:

- Probe: EF3DV3 - SN4053; ConvF(1, 1, 1); Calibrated: 2018.03.19;
- Sensor-Surface: (Fix Surface)
- Electronics: DAE4 Sn1386; Calibrated: 2017.07.20
- Phantom: HAC Test Arch with AMCC; Type: SD HAC P01 BA;
- Measurement SW: DASY52, Version 52.8 (8); SEMCAD X Version 14.6.10 (7331)

Ch40185/Hearing Aid Compatibility Test (101x101x1): Interpolated grid: dx=0.5000 mm, dy=0.5000 mm

Device Reference Point: 0, 0, -6.3 mm

Reference Value = 10.34 V/m; Power Drift = 0.01 dB

Applied MIF = -1.62 dB

RF audio interference level = 22.37 dBV/m

Emission category: M4

MIF scaled E-field

Grid 1 M4 20.85 dBV/m	Grid 2 M4 20.72 dBV/m	Grid 3 M4 21.72 dBV/m
Grid 4 M4 20.82 dBV/m	Grid 5 M4 20.69 dBV/m	Grid 6 M4 21.91 dBV/m
Grid 7 M4 22.37 dBV/m	Grid 8 M4 20.5 dBV/m	Grid 9 M4 21.64 dBV/m

Total = 22.37 dBV/m

E Category: M4

Location: 25, 25, 8.7 mm

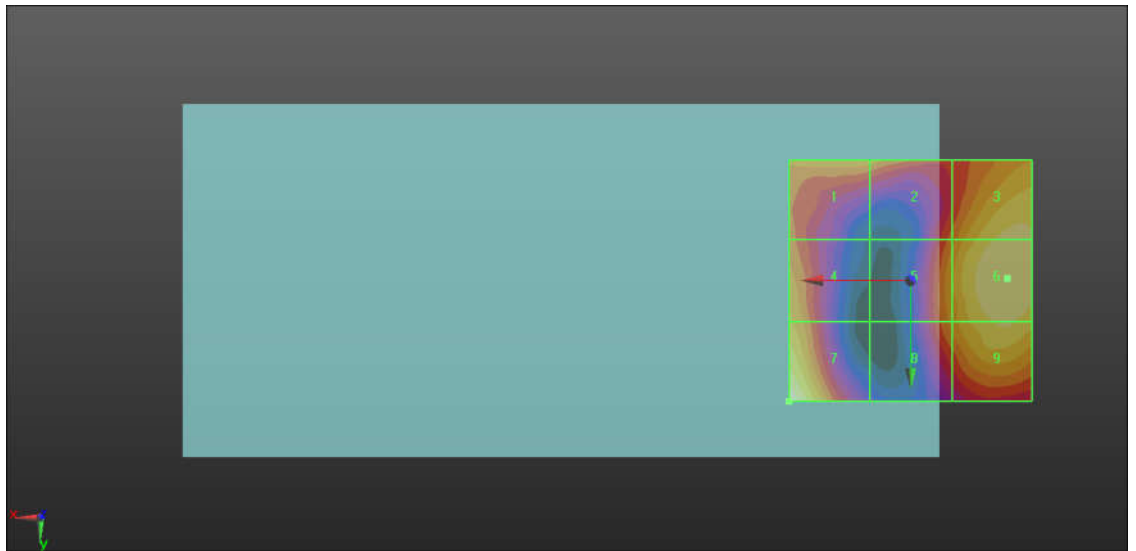
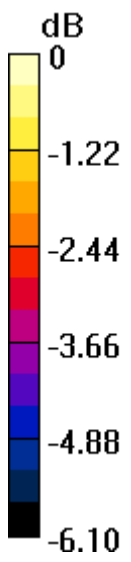

0 dB = 13.14 V/m = 22.37 dBV/m

18_HAC RF_LTE Band41_20M_QPSK_1RB_0offset_Ch40620

Communication System: UID 10172 - CAC, LTE-TDD (SC-FDMA, 1 RB, 20 MHz, QPSK);
 Frequency: 2593 MHz; Duty Cycle: 1:1

Medium: Air Medium parameters used: $\sigma = 0$ S/m, $\epsilon_r = 1$; $\rho = 0$ kg/m³

Ambient Temperature : 23.4 °C

DASY5 Configuration:

- Probe: EF3DV3 - SN4053; ConvF(1, 1, 1); Calibrated: 2018.03.19;
- Sensor-Surface: (Fix Surface)
- Electronics: DAE4 Sn1386; Calibrated: 2017.07.20
- Phantom: HAC Test Arch with AMCC; Type: SD HAC P01 BA;
- Measurement SW: DASY52, Version 52.8 (8); SEMCAD X Version 14.6.10 (7331)

Ch40620/Hearing Aid Compatibility Test (101x101x1): Interpolated grid: dx=0.5000 mm, dy=0.5000 mm

Device Reference Point: 0, 0, -6.3 mm

Reference Value = 9.153 V/m; Power Drift = -0.05 dB

Applied MIF = -1.62 dB

RF audio interference level = 22.21 dBV/m

Emission category: M4

MIF scaled E-field

Grid 1 M4 21.13 dBV/m	Grid 2 M4 20.97 dBV/m	Grid 3 M4 21.45 dBV/m
Grid 4 M4 20.63 dBV/m	Grid 5 M4 19.96 dBV/m	Grid 6 M4 21.57 dBV/m
Grid 7 M4 22.2 dBV/m	Grid 8 M4 19.95 dBV/m	Grid 9 M4 21.49 dBV/m

Total = 22.21 dBV/m

E Category: M4

Location: 25, 25, 8.7 mm

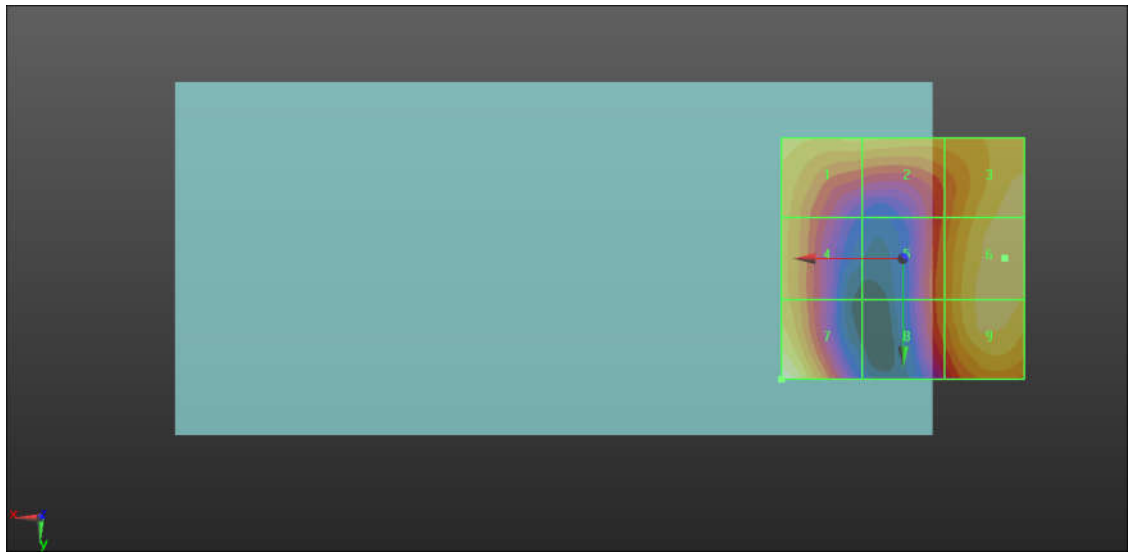
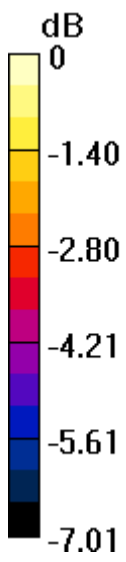

0 dB = 12.89 V/m = 22.21 dBV/m

19_HAC RF_LTE Band41_20M_QPSK_1RB_0offset_Ch41055

Communication System: UID 10172 - CAC, LTE-TDD (SC-FDMA, 1 RB, 20 MHz, QPSK);
 Frequency: 2636.5 MHz; Duty Cycle: 1:1

Medium: Air Medium parameters used: $\sigma = 0$ S/m, $\epsilon_r = 1$; $\rho = 0$ kg/m³

Ambient Temperature : 23.4 °C

DASY5 Configuration:

- Probe: EF3DV3 - SN4053; ConvF(1, 1, 1); Calibrated: 2018.03.19;
- Sensor-Surface: (Fix Surface)
- Electronics: DAE4 Sn1386; Calibrated: 2017.07.20
- Phantom: HAC Test Arch with AMCC; Type: SD HAC P01 BA;
- Measurement SW: DASY52, Version 52.8 (8); SEMCAD X Version 14.6.10 (7331)

Ch41055/Hearing Aid Compatibility Test (101x101x1): Interpolated grid: dx=0.5000 mm, dy=0.5000 mm

Device Reference Point: 0, 0, -6.3 mm

Reference Value = 8.551 V/m; Power Drift = -0.07 dB

Applied MIF = -1.62 dB

RF audio interference level = 21.08 dBV/m

Emission category: M4

MIF scaled E-field

Grid 1 M4 20.18 dBV/m	Grid 2 M4 19.06 dBV/m	Grid 3 M4 19.88 dBV/m
Grid 4 M4 19.99 dBV/m	Grid 5 M4 19.28 dBV/m	Grid 6 M4 20.59 dBV/m
Grid 7 M4 21.08 dBV/m	Grid 8 M4 19.27 dBV/m	Grid 9 M4 20.59 dBV/m

Total = 21.08 dBV/m

E Category: M4

Location: 25, 25, 8.7 mm

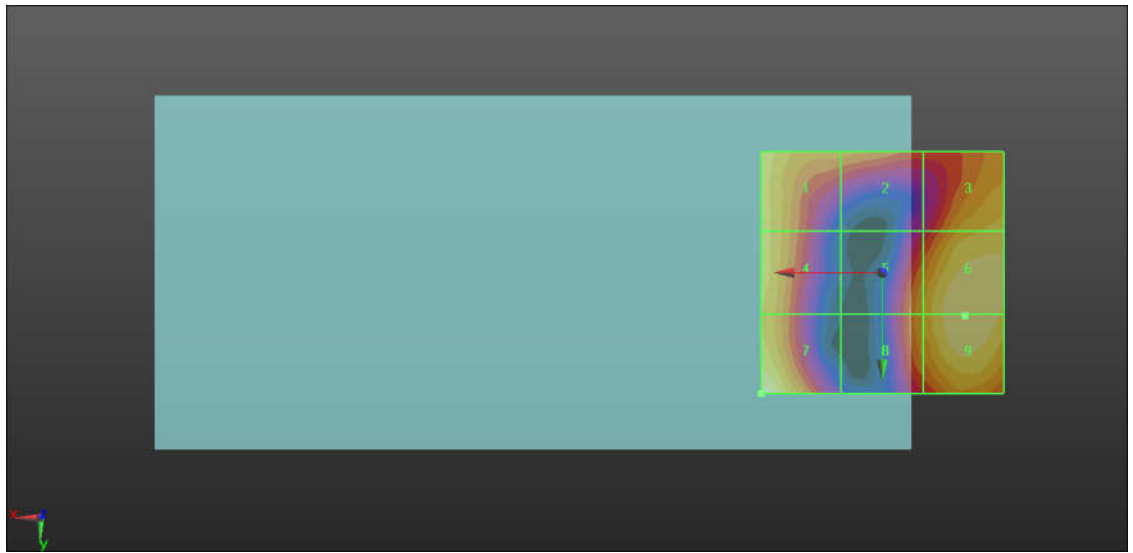
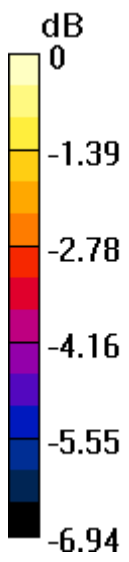

0 dB = 11.32 V/m = 21.08 dBV/m

20_HAC RF_LTE Band41_20M_QPSK_1RB_0offset_Ch41490

Communication System: UID 10172 - CAC, LTE-TDD (SC-FDMA, 1 RB, 20 MHz, QPSK);
 Frequency: 2680 MHz; Duty Cycle: 1:1

Medium: Air Medium parameters used: $\sigma = 0$ S/m, $\epsilon_r = 1$; $\rho = 0$ kg/m³

Ambient Temperature : 23.4 °C

DASY5 Configuration:

- Probe: EF3DV3 - SN4053; ConvF(1, 1, 1); Calibrated: 2018.03.19;
- Sensor-Surface: (Fix Surface)
- Electronics: DAE4 Sn1386; Calibrated: 2017.07.20
- Phantom: HAC Test Arch with AMCC; Type: SD HAC P01 BA;
- Measurement SW: DASY52, Version 52.10 (0); SEMCAD X Version 14.6.10 (7331)

Ch41490/Hearing Aid Compatibility Test (101x101x1): Interpolated grid: dx=0.5000 mm, dy=0.5000 mm

Device Reference Point: 0, 0, -6.3 mm

Reference Value = 8.114 V/m; Power Drift = 0.04 dB

Applied MIF = -1.62 dB

RF audio interference level = 22.23 dBV/m

Emission category: M4

MIF scaled E-field

Grid 1 M4 22.22 dBV/m	Grid 2 M4 20.99 dBV/m	Grid 3 M4 19.2 dBV/m
Grid 4 M4 21.31 dBV/m	Grid 5 M4 18.74 dBV/m	Grid 6 M4 20.26 dBV/m
Grid 7 M4 21.37 dBV/m	Grid 8 M4 19.4 dBV/m	Grid 9 M4 20.77 dBV/m

Total = 22.23 dBV/m

E Category: M4

Location: 25, -25, 8.7 mm

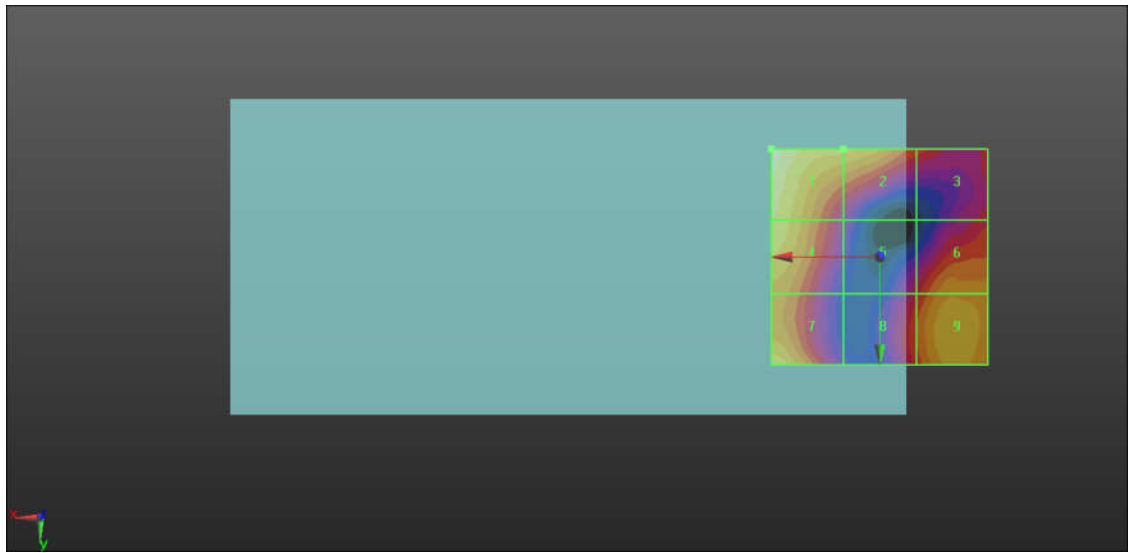
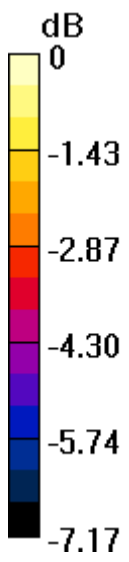

0 dB = 12.92 V/m = 22.23 dBV/m

21_HAC RF_LTE Band41_20M_QPSK_1RB_0offset_PCC: Ch39750 & SCC: Ch39948

Communication System: UID 10172 - CAC, LTE-TDD (SC-FDMA, 1 RB, 20 MHz, QPSK);

Frequency: PCC:2506 MHz & SCC:2525.8MHz;Duty Cycle: 1:1

Medium: Air Medium parameters used: $\sigma = 0$ S/m, $\epsilon_r = 1$; $\rho = 0$ kg/m³

Ambient Temperature : 23.4 °C

DASY5 Configuration:

- Probe: EF3DV3 - SN4053; ConvF(1, 1, 1); Calibrated: 2018.03.19;

- Sensor-Surface: (Fix Surface)

- Electronics: DAE4 Sn1386; Calibrated: 2017.07.20

- Phantom: HAC Test Arch with AMCC; Type: SD HAC P01 BA;

- Measurement SW: DASY52, Version 52.8 (8); SEMCAD X Version 14.6.10 (7331)

PCC: Ch39750 & SCC: Ch39948/Hearing Aid Compatibility Test (101x101x1):

Interpolated grid: dx=0.5000 mm,dy=0.5000 mm

Device Reference Point: 0, 0, -6.3 mm

Reference Value = 10.32 V/m; Power Drift = 0.07 dB

Applied MIF = -1.62 dB

RF audio interference level = 21.73 dBV/m

Emission category: M4

MIF scaled E-field

Grid 1 M4 20.01 dBV/m	Grid 2 M4 20.01 dBV/m	Grid 3 M4 20.9 dBV/m
Grid 4 M4 20.07 dBV/m	Grid 5 M4 20.55 dBV/m	Grid 6 M4 21.52 dBV/m
Grid 7 M4 21.73 dBV/m	Grid 8 M4 20.27 dBV/m	Grid 9 M4 21.4 dBV/m

Total = 21.73 dBV/m

E Category: M4

Location: 25, 25, 8.7 mm

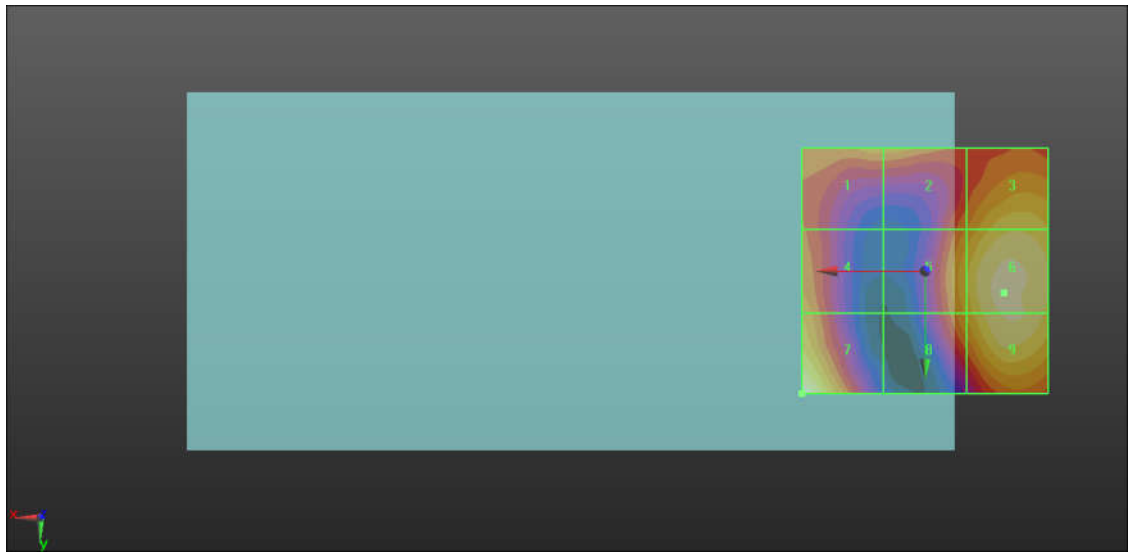
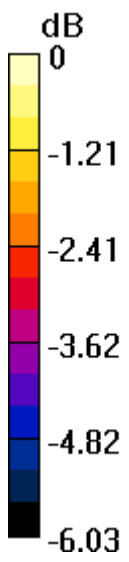

0 dB = 12.21 V/m = 21.73 dBV/m

22_HAC RF_LTE Band41_20M_QPSK_1RB_0offset_PCC: Ch40185& SCC:Ch40383

Communication System: UID 10172 - CAC, LTE-TDD (SC-FDMA, 1 RB, 20 MHz, QPSK);

Frequency: PCC:2549.5 MHz & SCC:2569.3MHz;Duty Cycle: 1:1

Medium: Air Medium parameters used: $\sigma = 0$ S/m, $\epsilon_r = 1$; $\rho = 0$ kg/m³

Ambient Temperature : 23.4 °C

DASY5 Configuration:

- Probe: EF3DV3 - SN4053; ConvF(1, 1, 1); Calibrated: 2018.03.19;

- Sensor-Surface: (Fix Surface)

- Electronics: DAE4 Sn1386; Calibrated: 2017.07.20

- Phantom: HAC Test Arch with AMCC; Type: SD HAC P01 BA;

- Measurement SW: DASY52, Version 52.8 (8); SEMCAD X Version 14.6.10 (7331)

PCC: Ch40185& SCC:Ch40383/Hearing Aid Compatibility Test (101x101x1):

Interpolated grid: dx=0.5000 mm,dy=0.5000 mm

Device Reference Point: 0, 0, -6.3 mm

Reference Value = 8.955 V/m; Power Drift = -0.01 dB

Applied MIF = -1.62 dB

RF audio interference level = 20.72 dBV/m

Emission category: M4

MIF scaled E-field

Grid 1 M4 19.75 dBV/m	Grid 2 M4 19.5 dBV/m	Grid 3 M4 20.12 dBV/m
Grid 4 M4 19.44 dBV/m	Grid 5 M4 19.3 dBV/m	Grid 6 M4 20.51 dBV/m
Grid 7 M4 20.72 dBV/m	Grid 8 M4 19.15 dBV/m	Grid 9 M4 20.37 dBV/m

Total = 20.72 dBV/m

E Category: M4

Location: 25, 25, 8.7 mm

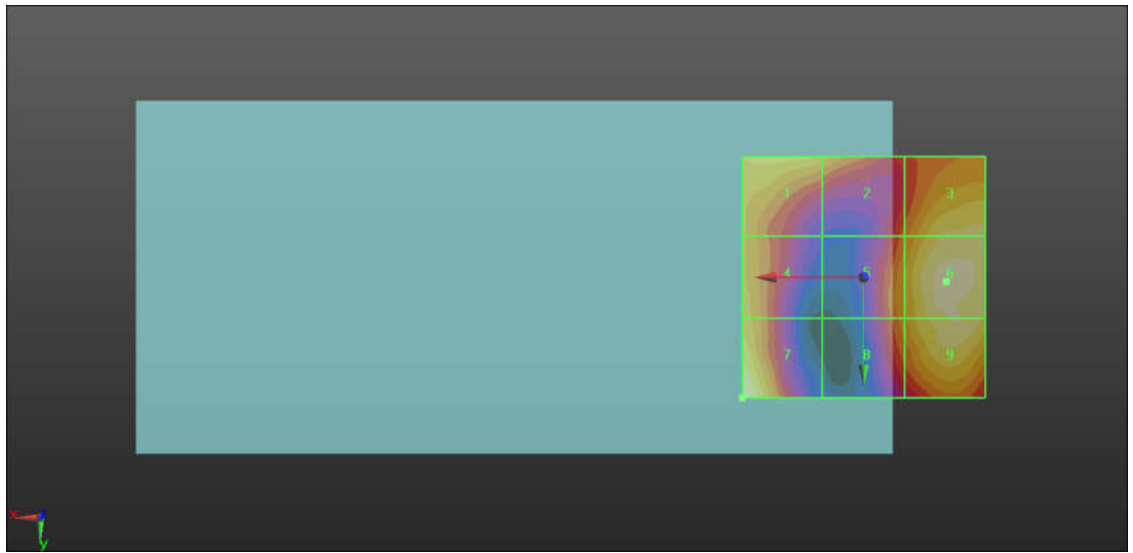
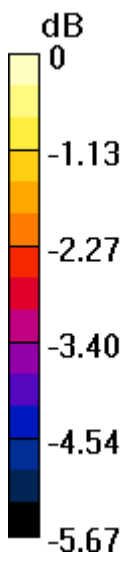

0 dB = 10.87 V/m = 20.72 dBV/m

23_HAC RF_LTE Band41_20M_QPSK_1RB_0offset_PCC: Ch40620& SCC:Ch40422

Communication System: UID 10172 - CAC, LTE-TDD (SC-FDMA, 1 RB, 20 MHz, QPSK);

Frequency: PCC:2593 MHz&SCC:2573.2MHz;Duty Cycle: 1:1

Medium: Air Medium parameters used: $\sigma = 0$ S/m, $\epsilon_r = 1$; $\rho = 0$ kg/m³

Ambient Temperature : 23.4 °C

DASY5 Configuration:

- Probe: EF3DV3 - SN4053; ConvF(1, 1, 1); Calibrated: 2018.03.19;

- Sensor-Surface: (Fix Surface)

- Electronics: DAE4 Sn1386; Calibrated: 2017.07.20

- Phantom: HAC Test Arch with AMCC; Type: SD HAC P01 BA;

- Measurement SW: DASY52, Version 52.8 (8); SEMCAD X Version 14.6.10 (7331)

PCC: Ch40620& SCC:Ch40422/Hearing Aid Compatibility Test (101x101x1):

Interpolated grid: dx=0.5000 mm,dy=0.5000 mm

Device Reference Point: 0, 0, -6.3 mm

Reference Value = 8.268 V/m; Power Drift = -0.13 dB

Applied MIF = 0.00 dB

RF audio interference level = 21.86 dBV/m

Emission category: M4

MIF scaled E-field

Grid 1 M4 19.46 dBV/m	Grid 2 M4 20.35 dBV/m	Grid 3 M4 21.26 dBV/m
Grid 4 M4 19.2 dBV/m	Grid 5 M4 19.79 dBV/m	Grid 6 M4 21.37 dBV/m
Grid 7 M4 21.86 dBV/m	Grid 8 M4 19.62 dBV/m	Grid 9 M4 20.94 dBV/m

Total = 21.86 dBV/m

E Category: M4

Location: 25, 25, 8.7 mm

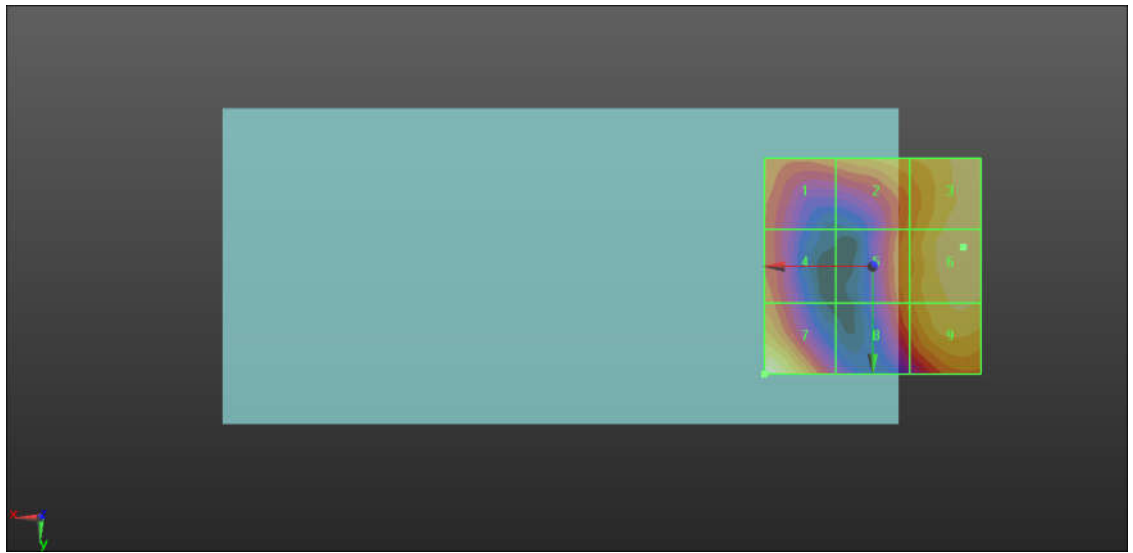
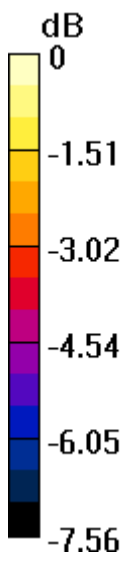

0 dB = 12.39 V/m = 21.86 dBV/m

24_HAC RF_LTE Band41_20M_QPSK_1RB_0offset_PCC: Ch41055& SCC:Ch40857

Communication System: UID 10172 - CAC, LTE-TDD (SC-FDMA, 1 RB, 20 MHz, QPSK);

Frequency: PCC:2636.5 MHz&SCC:2616.7MHz;Duty Cycle: 1:1

Medium: Air Medium parameters used: $\sigma = 0$ S/m, $\epsilon_r = 1$; $\rho = 0$ kg/m³

Ambient Temperature : 23.4 °C

DASY5 Configuration:

- Probe: EF3DV3 - SN4053; ConvF(1, 1, 1); Calibrated: 2018.03.19;

- Sensor-Surface: (Fix Surface)

- Electronics: DAE4 Sn1386; Calibrated: 2017.07.20

- Phantom: HAC Test Arch with AMCC; Type: SD HAC P01 BA;

- Measurement SW: DASY52, Version 52.8 (8); SEMCAD X Version 14.6.10 (7331)

PCC: Ch41055& SCC:Ch40857/Hearing Aid Compatibility Test (101x101x1):

Interpolated grid: dx=0.5000 mm,dy=0.5000 mm

Device Reference Point: 0, 0, -6.3 mm

Reference Value = 8.001 V/m; Power Drift = -0.03 dB

Applied MIF = 0.00 dB

RF audio interference level = 21.01 dBV/m

Emission category: M4

MIF scaled E-field

Grid 1 M4 19.53 dBV/m	Grid 2 M4 18.08 dBV/m	Grid 3 M4 19.69 dBV/m
Grid 4 M4 19.53 dBV/m	Grid 5 M4 19.46 dBV/m	Grid 6 M4 20.32 dBV/m
Grid 7 M4 21.01 dBV/m	Grid 8 M4 19.43 dBV/m	Grid 9 M4 20.28 dBV/m

Total = 21.01 dBV/m

E Category: M4

Location: 25, 25, 8.7 mm

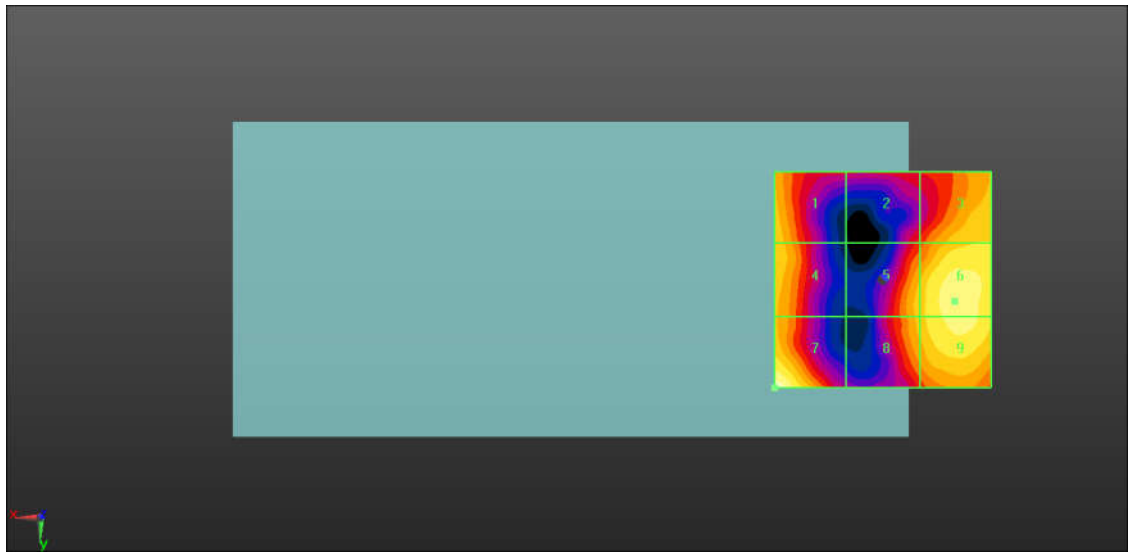
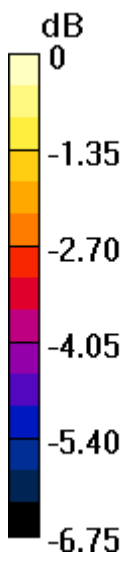

0 dB = 11.23 V/m = 21.01 dBV/m

25_HAC RF_LTE Band41_20M_QPSK_1RB_0offset_PCC: Ch41490& SCC:Ch41292

Communication System: UID 10172 - CAC, LTE-TDD (SC-FDMA, 1 RB, 20 MHz, QPSK);

Frequency: PCC:2680 MHz&SCC:2660.2MHz;Duty Cycle: 1:1

Medium: Air Medium parameters used: $\sigma = 0$ S/m, $\epsilon_r = 1$; $\rho = 0$ kg/m³

Ambient Temperature : 23.4 °C

DASY5 Configuration:

- Probe: EF3DV3 - SN4053; ConvF(1, 1, 1); Calibrated: 2018.03.19;

- Sensor-Surface: (Fix Surface)

- Electronics: DAE4 Sn1386; Calibrated: 2017.07.20

- Phantom: HAC Test Arch with AMCC; Type: SD HAC P01 BA;

- Measurement SW: DASY52, Version 52.8 (8); SEMCAD X Version 14.6.10 (7331)

PCC: Ch41490& SCC:Ch41292/Hearing Aid Compatibility Test (101x101x1):

Interpolated grid: dx=0.5000 mm,dy=0.5000 mm

Device Reference Point: 0, 0, -6.3 mm

Reference Value = 8.268 V/m; Power Drift = -0.03 dB

Applied MIF = -1.62 dB

RF audio interference level = 20.24 dBV/m

Emission category: M4

MIF scaled E-field

Grid 1 M4 17.84 dBV/m	Grid 2 M4 18.73 dBV/m	Grid 3 M4 19.64 dBV/m
Grid 4 M4 17.58 dBV/m	Grid 5 M4 18.17 dBV/m	Grid 6 M4 19.75 dBV/m
Grid 7 M4 20.24 dBV/m	Grid 8 M4 18 dBV/m	Grid 9 M4 19.32 dBV/m

Total = 20.24 dBV/m

E Category: M4

Location: 25, 25, 8.7 mm

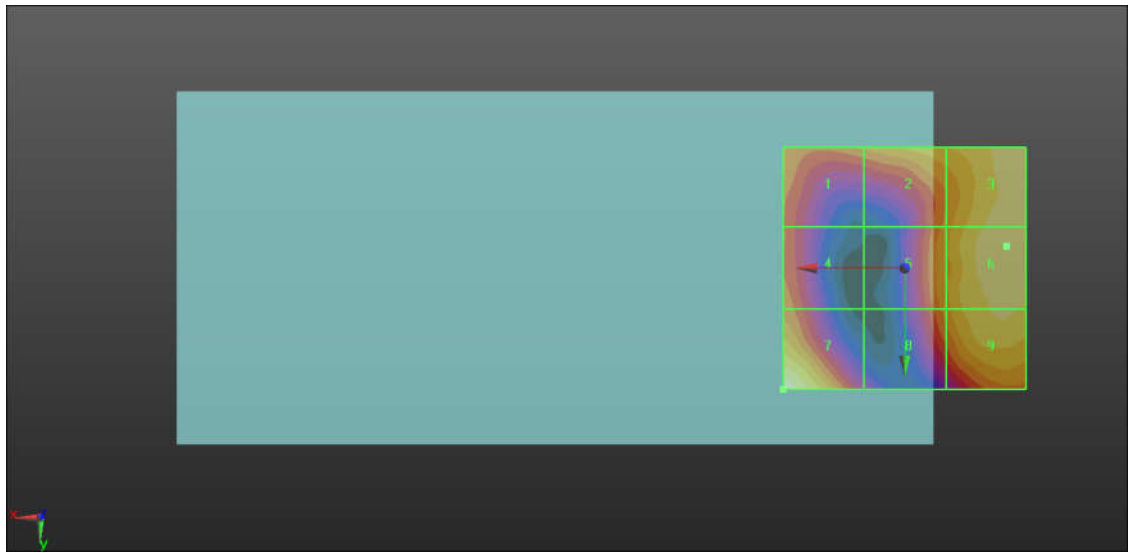
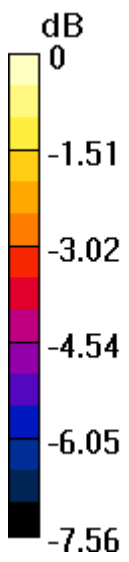

0 dB = 10.28 V/m = 20.24 dBV/m

26_HAC RF_LTE Band41_20M_QPSK_1RB_0offset_Ch39750

Communication System: UID 10172 - CAC, LTE-TDD (SC-FDMA, 1 RB, 20 MHz, QPSK);
 Frequency: 2506 MHz; Duty Cycle: 1:1

Medium: Air Medium parameters used: $\sigma = 0$ S/m, $\epsilon_r = 1$; $\rho = 0$ kg/m³

Ambient Temperature : 23.4 °C

DASY5 Configuration:

- Probe: EF3DV3 - SN4053; ConvF(1, 1, 1); Calibrated: 2018.03.19;
- Sensor-Surface: (Fix Surface)
- Electronics: DAE4 Sn1386; Calibrated: 2017.07.20
- Phantom: HAC Test Arch with AMCC; Type: SD HAC P01 BA;
- Measurement SW: DASY52, Version 52.8 (8); SEMCAD X Version 14.6.10 (7331)

Ch39750/Hearing Aid Compatibility Test (101x101x1): Interpolated grid: dx=0.5000 mm, dy=0.5000 mm

Device Reference Point: 0, 0, -6.3 mm

Reference Value = 10.25 V/m; Power Drift = -0.01 dB

Applied MIF = -1.62 dB

RF audio interference level = 21.18 dBV/m

Emission category: M4

MIF scaled E-field

Grid 1 M4 19.66 dBV/m	Grid 2 M4 19.66 dBV/m	Grid 3 M4 20.54 dBV/m
Grid 4 M4 19.46 dBV/m	Grid 5 M4 20.35 dBV/m	Grid 6 M4 21.18 dBV/m
Grid 7 M4 21.03 dBV/m	Grid 8 M4 20.08 dBV/m	Grid 9 M4 21.1 dBV/m

Total = 21.18 dBV/m

E Category: M4

Location: -16.5, 4.5, 8.7 mm

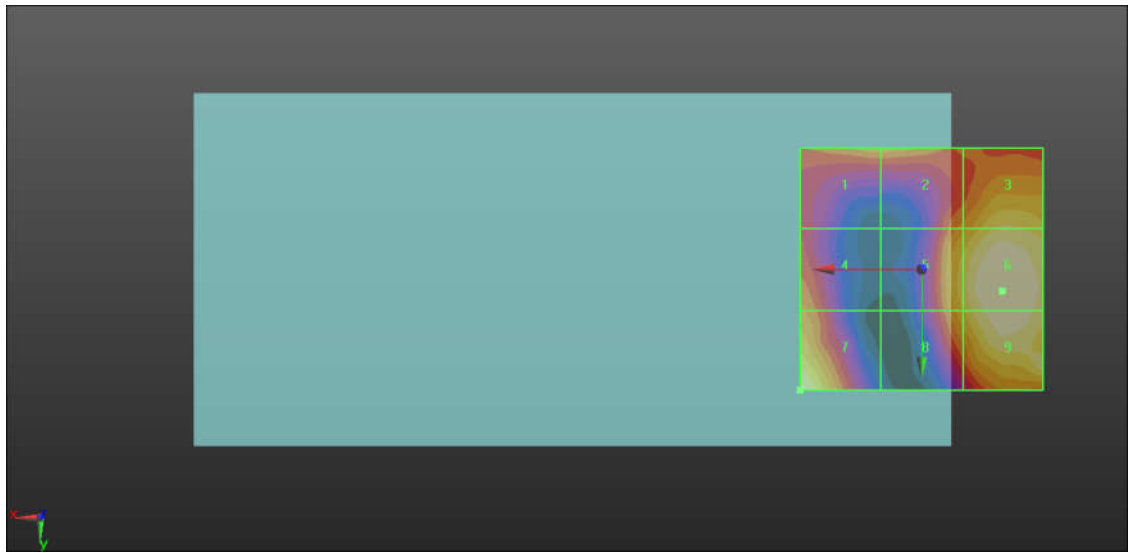
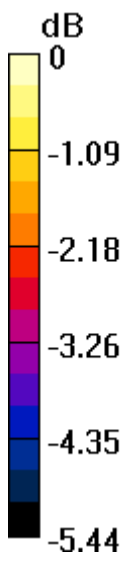

0 dB = 11.46 V/m = 21.18 dBV/m

27_HAC RF_LTE Band41_20M_QPSK_1RB_0offset_Ch40185

Communication System: UID 10172 - CAC, LTE-TDD (SC-FDMA, 1 RB, 20 MHz, QPSK);
 Frequency: 2549.5 MHz; Duty Cycle: 1:1

Medium: Air Medium parameters used: $\sigma = 0$ S/m, $\epsilon_r = 1$; $\rho = 0$ kg/m³

Ambient Temperature : 23.4 °C

DASY5 Configuration:

- Probe: EF3DV3 - SN4053; ConvF(1, 1, 1); Calibrated: 2018.03.19;
- Sensor-Surface: (Fix Surface)
- Electronics: DAE4 Sn1386; Calibrated: 2017.07.20
- Phantom: HAC Test Arch with AMCC; Type: SD HAC P01 BA;
- Measurement SW: DASY52, Version 52.8 (8); SEMCAD X Version 14.6.10 (7331)

Ch40185/Hearing Aid Compatibility Test (101x101x1): Interpolated grid: dx=0.5000 mm, dy=0.5000 mm

Device Reference Point: 0, 0, -6.3 mm

Reference Value = 8.043 V/m; Power Drift = -0.04 dB

Applied MIF = -1.62 dB

RF audio interference level = 20.56 dBV/m

Emission category: M4

MIF scaled E-field

Grid 1 M4 19.22 dBV/m	Grid 2 M4 19.13 dBV/m	Grid 3 M4 19.41 dBV/m
Grid 4 M4 19.53 dBV/m	Grid 5 M4 18.38 dBV/m	Grid 6 M4 19.71 dBV/m
Grid 7 M4 20.56 dBV/m	Grid 8 M4 18.22 dBV/m	Grid 9 M4 19.56 dBV/m

Total = 20.56 dBV/m

E Category: M4

Location: 25, 25, 8.7 mm

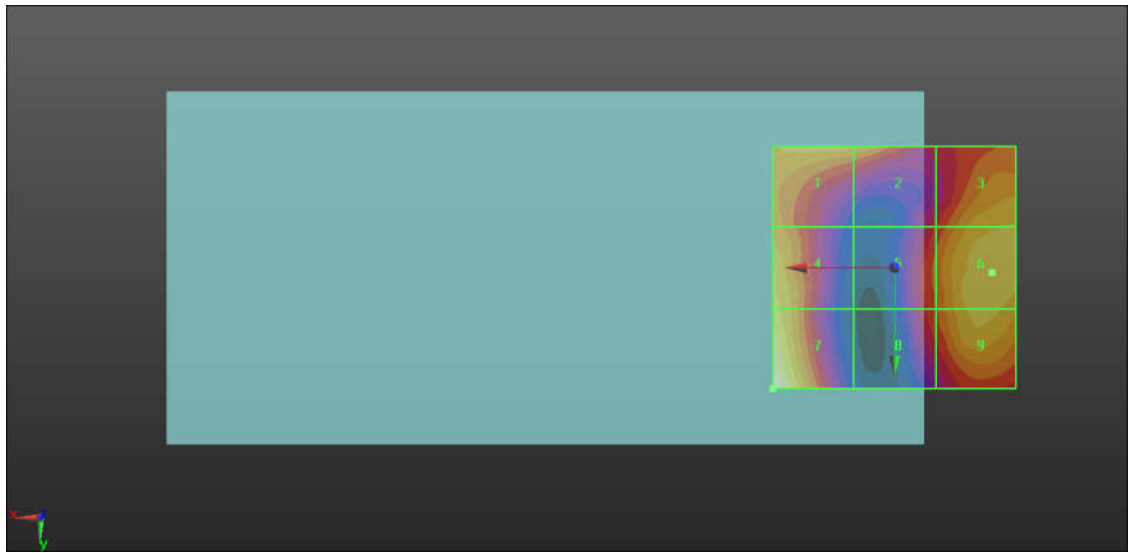
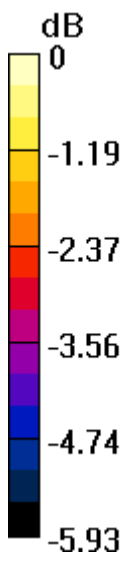

0 dB = 10.67 V/m = 20.56 dBV/m

28_HAC RF_LTE Band41_20M_QPSK_1RB_0offset_Ch40620

Communication System: UID 10172 - CAC, LTE-TDD (SC-FDMA, 1 RB, 20 MHz, QPSK);
 Frequency: 2593 MHz; Duty Cycle: 1:1

Medium: Air Medium parameters used: $\sigma = 0$ S/m, $\epsilon_r = 1$; $\rho = 0$ kg/m³

Ambient Temperature : 23.4 °C

DASY5 Configuration:

- Probe: EF3DV3 - SN4053; ConvF(1, 1, 1); Calibrated: 2018.03.19;
- Sensor-Surface: (Fix Surface)
- Electronics: DAE4 Sn1386; Calibrated: 2017.07.20
- Phantom: HAC Test Arch with AMCC; Type: SD HAC P01 BA;
- Measurement SW: DASY52, Version 52.8 (8); SEMCAD X Version 14.6.10 (7331)

Ch40620/Hearing Aid Compatibility Test (101x101x1): Interpolated grid: dx=0.5000 mm, dy=0.5000 mm

Device Reference Point: 0, 0, -6.3 mm

Reference Value = 7.342 V/m; Power Drift = 0.14 dB

Applied MIF = -1.62 dB

RF audio interference level = 20.21 dBV/m

Emission category: M4

MIF scaled E-field

Grid 1 M4 18.22 dBV/m	Grid 2 M4 18.67 dBV/m	Grid 3 M4 19.07 dBV/m
Grid 4 M4 18.52 dBV/m	Grid 5 M4 17.73 dBV/m	Grid 6 M4 19.27 dBV/m
Grid 7 M4 20.21 dBV/m	Grid 8 M4 17.66 dBV/m	Grid 9 M4 19.16 dBV/m

Total = 20.21 dBV/m

E Category: M4

Location: 25, 25, 8.7 mm

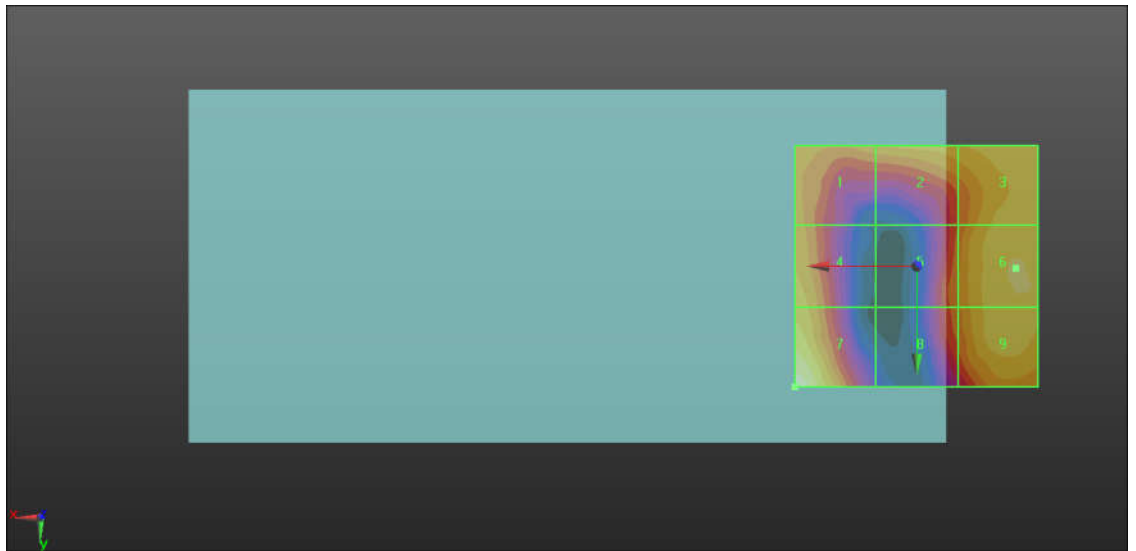
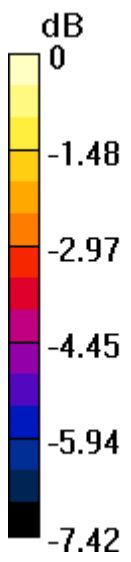

0 dB = 10.24 V/m = 20.21 dBV/m

29_HAC RF_LTE Band41_20M_QPSK_1RB_0offset_Ch41055

Communication System: UID 10172 - CAC, LTE-TDD (SC-FDMA, 1 RB, 20 MHz, QPSK);
 Frequency: 2636.5 MHz; Duty Cycle: 1:1

Medium: Air Medium parameters used: $\sigma = 0$ S/m, $\epsilon_r = 1$; $\rho = 0$ kg/m³

Ambient Temperature : 23.4 °C

DASY5 Configuration:

- Probe: EF3DV3 - SN4053; ConvF(1, 1, 1); Calibrated: 2018.03.19;
- Sensor-Surface: (Fix Surface)
- Electronics: DAE4 Sn1386; Calibrated: 2017.07.20
- Phantom: HAC Test Arch with AMCC; Type: SD HAC P01 BA;
- Measurement SW: DASY52, Version 52.8 (8); SEMCAD X Version 14.6.10 (7331)

Ch41055/Hearing Aid Compatibility Test (101x101x1): Interpolated grid: dx=0.5000 mm, dy=0.5000 mm

Device Reference Point: 0, 0, -6.3 mm

Reference Value = 6.873 V/m; Power Drift = 0.12 dB

Applied MIF = -1.62 dB

RF audio interference level = 19.43 dBV/m

Emission category: M4

MIF scaled E-field

Grid 1 M4 17.82 dBV/m	Grid 2 M4 16.5 dBV/m	Grid 3 M4 17.82 dBV/m
Grid 4 M4 17.91 dBV/m	Grid 5 M4 17.29 dBV/m	Grid 6 M4 18.42 dBV/m
Grid 7 M4 19.43 dBV/m	Grid 8 M4 17.24 dBV/m	Grid 9 M4 18.41 dBV/m

Total = 19.43 dBV/m

E Category: M4

Location: 25, 25, 8.7 mm

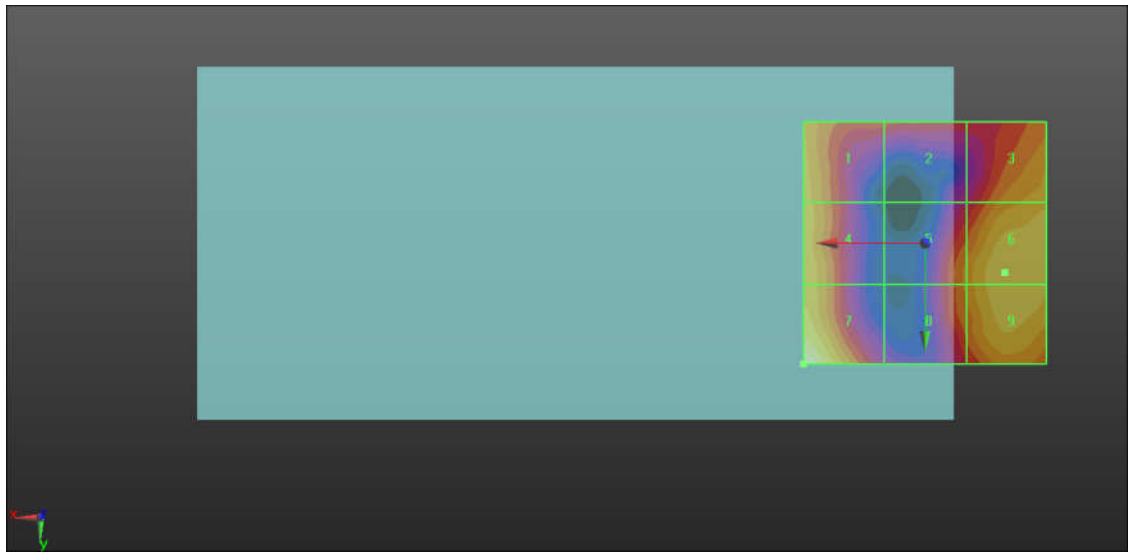
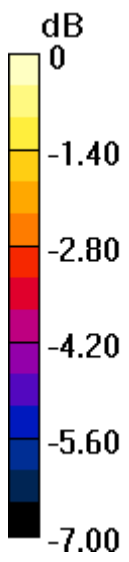

0 dB = 9.362 V/m = 19.43 dBV/m

30_HAC RF_LTE Band41_20M_QPSK_1RB_0offset_Ch41490

Communication System: UID 10172 - CAC, LTE-TDD (SC-FDMA, 1 RB, 20 MHz, QPSK);
 Frequency: 2680 MHz; Duty Cycle: 1:1

Medium: Air Medium parameters used: $\sigma = 0$ S/m, $\epsilon_r = 1$; $\rho = 0$ kg/m³

Ambient Temperature : 23.4 °C

DASY5 Configuration:

- Probe: EF3DV3 - SN4053; ConvF(1, 1, 1); Calibrated: 2018.03.19;
- Sensor-Surface: (Fix Surface)
- Electronics: DAE4 Sn1386; Calibrated: 2017.07.20
- Phantom: HAC Test Arch with AMCC; Type: SD HAC P01 BA;
- Measurement SW: DASY52, Version 52.8 (8); SEMCAD X Version 14.6.10 (7331)

Ch41490/Hearing Aid Compatibility Test (101x101x1): Interpolated grid: dx=0.5000 mm, dy=0.5000 mm

Device Reference Point: 0, 0, -6.3 mm

Reference Value = 7.008 V/m; Power Drift = -0.16 dB

Applied MIF = -1.62 dB

RF audio interference level = 20.02 dBV/m

Emission category: M4

MIF scaled E-field

Grid 1 M4 20.02 dBV/m	Grid 2 M4 19.02 dBV/m	Grid 3 M4 17.65 dBV/m
Grid 4 M4 19.51 dBV/m	Grid 5 M4 16.99 dBV/m	Grid 6 M4 18.3 dBV/m
Grid 7 M4 19.86 dBV/m	Grid 8 M4 17.47 dBV/m	Grid 9 M4 18.73 dBV/m

Total = 20.02 dBV/m

E Category: M4

Location: 25, -25, 8.7 mm

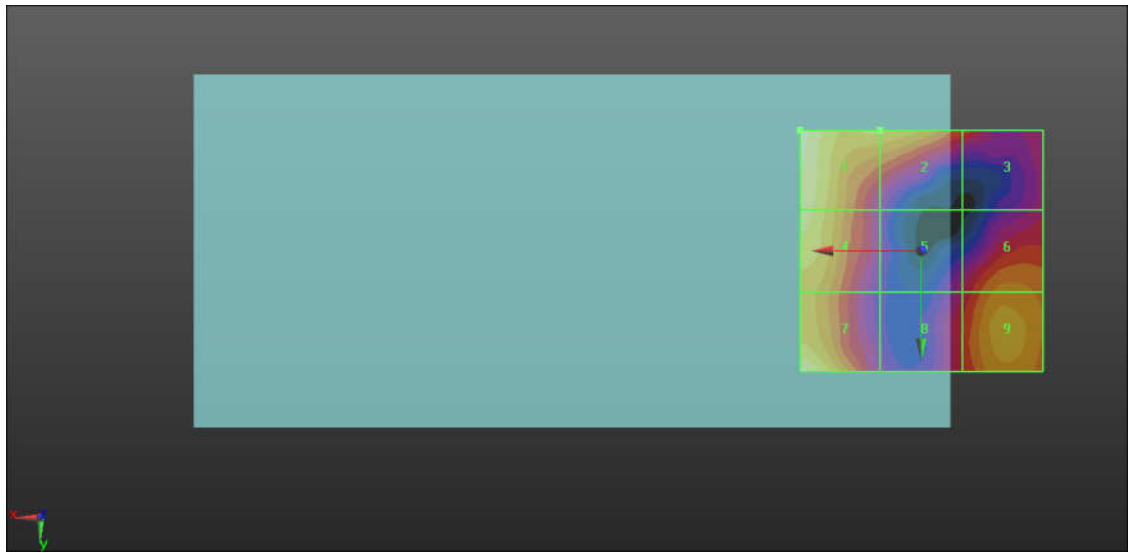
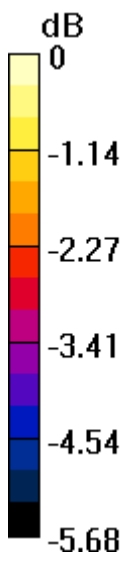

0 dB = 10.03 V/m = 20.03 dBV/m

31_HAC RF_LTE Band41_20M_QPSK_1RB_0offset_PCC: Ch39750 & SCC: Ch39948

Communication System: UID 10172 - CAC, LTE-TDD (SC-FDMA, 1 RB, 20 MHz, QPSK);

Frequency: PCC:2506 MHz & SCC:2525.8MHz;Duty Cycle: 1:1

Medium: Air Medium parameters used: $\sigma = 0$ S/m, $\epsilon_r = 1$; $\rho = 0$ kg/m³

Ambient Temperature : 23.4 °C

DASY5 Configuration:

- Probe: EF3DV3 - SN4053; ConvF(1, 1, 1); Calibrated: 2018.03.19;

- Sensor-Surface: (Fix Surface)

- Electronics: DAE4 Sn1386; Calibrated: 2017.07.20

- Phantom: HAC Test Arch with AMCC; Type: SD HAC P01 BA;

- Measurement SW: DASY52, Version 52.8 (8); SEMCAD X Version 14.6.10 (7331)

PCC: Ch39750 & SCC: Ch39948/Hearing Aid Compatibility Test (101x101x1):

Interpolated grid: dx=0.5000 mm,dy=0.5000 mm

Device Reference Point: 0, 0, -6.3 mm

Reference Value = 9.827 V/m; Power Drift = 0.14 dB

Applied MIF = -1.62 dB

RF audio interference level = 21.37 dBV/m

Emission category: M4

MIF scaled E-field

Grid 1 M4 19.61 dBV/m	Grid 2 M4 19.61 dBV/m	Grid 3 M4 20.42 dBV/m
Grid 4 M4 19.53 dBV/m	Grid 5 M4 20.05 dBV/m	Grid 6 M4 21.08 dBV/m
Grid 7 M4 21.37 dBV/m	Grid 8 M4 19.86 dBV/m	Grid 9 M4 21.02 dBV/m

Total = 21.37 dBV/m

E Category: M4

Location: 25, 25, 8.7 mm

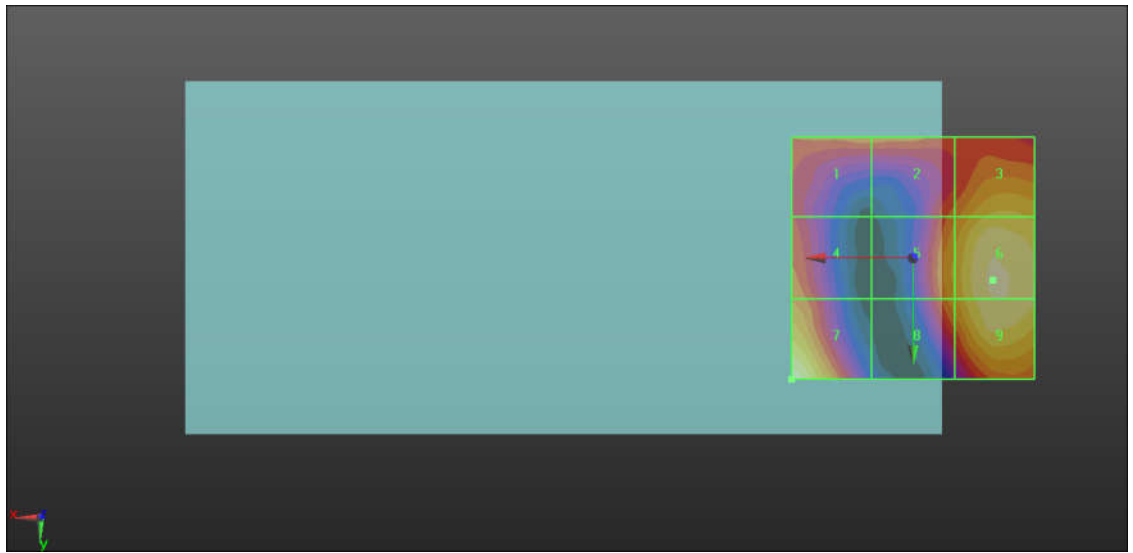
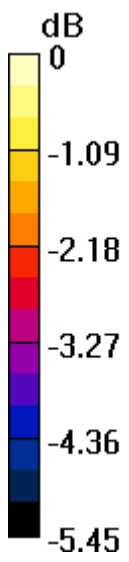

0 dB = 11.71 V/m = 21.37 dBV/m

32_HAC RF_LTE Band41_20M_QPSK_1RB_0offset_PCC: Ch40185& SCC:Ch40383

Communication System: UID 10172 - CAC, LTE-TDD (SC-FDMA, 1 RB, 20 MHz, QPSK);

Frequency: PCC:2549.5 MHz & SCC:2569.3MHz;Duty Cycle: 1:1

Medium: Air Medium parameters used: $\sigma = 0$ S/m, $\epsilon_r = 1$; $\rho = 0$ kg/m³

Ambient Temperature : 23.4 °C

DASY5 Configuration:

- Probe: EF3DV3 - SN4053; ConvF(1, 1, 1); Calibrated: 2018.03.19;

- Sensor-Surface: (Fix Surface)

- Electronics: DAE4 Sn1386; Calibrated: 2017.07.20

- Phantom: HAC Test Arch with AMCC; Type: SD HAC P01 BA;

- Measurement SW: DASY52, Version 52.8 (8); SEMCAD X Version 14.6.10 (7331)

PCC: Ch40185& SCC:Ch40383/Hearing Aid Compatibility Test (101x101x1):

Interpolated grid: dx=0.5000 mm,dy=0.5000 mm

Device Reference Point: 0, 0, -6.3 mm

Reference Value = 8.390 V/m; Power Drift = -0.05 dB

Applied MIF = -1.62 dB

RF audio interference level = 20.58 dBV/m

Emission category: M4

MIF scaled E-field

Grid 1 M4 19.34 dBV/m	Grid 2 M4 19.17 dBV/m	Grid 3 M4 19.46 dBV/m
Grid 4 M4 19.52 dBV/m	Grid 5 M4 18.52 dBV/m	Grid 6 M4 19.85 dBV/m
Grid 7 M4 20.58 dBV/m	Grid 8 M4 18.41 dBV/m	Grid 9 M4 19.67 dBV/m

Total = 20.58 dBV/m

E Category: M4

Location: 25, 25, 8.7 mm

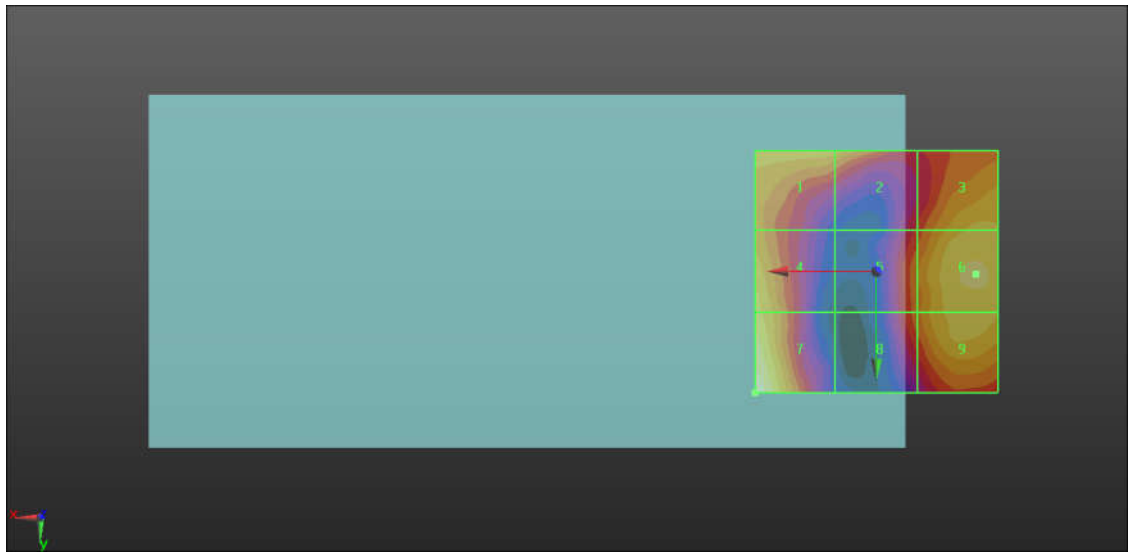
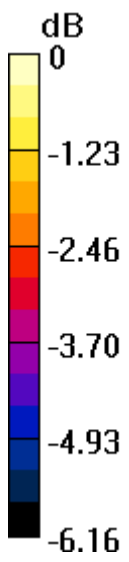

0 dB = 10.69 V/m = 20.58 dBV/m

33_HAC RF_LTE Band41_20M_QPSK_1RB_0offset_PCC: Ch40620& SCC:Ch40422

Communication System: UID 10172 - CAC, LTE-TDD (SC-FDMA, 1 RB, 20 MHz, QPSK);

Frequency: PCC:2593 MHz&SCC:2573.2MHz;Duty Cycle: 1:1

Medium: Air Medium parameters used: $\sigma = 0$ S/m, $\epsilon_r = 1$; $\rho = 0$ kg/m³

Ambient Temperature : 23.4 °C

DASY5 Configuration:

- Probe: EF3DV3 - SN4053; ConvF(1, 1, 1); Calibrated: 2018.03.19;

- Sensor-Surface: (Fix Surface)

- Electronics: DAE4 Sn1386; Calibrated: 2017.07.20

- Phantom: HAC Test Arch with AMCC; Type: SD HAC P01 BA;

- Measurement SW: DASY52, Version 52.8 (8); SEMCAD X Version 14.6.10 (7331)

PCC: Ch40620& SCC:Ch40422/Hearing Aid Compatibility Test (101x101x1):

Interpolated grid: dx=0.5000 mm,dy=0.5000 mm

Device Reference Point: 0, 0, -6.3 mm

Reference Value = 8.037 V/m; Power Drift = 0.12 dB

Applied MIF = -1.62 dB

RF audio interference level = 20.14 dBV/m

Emission category: M4

MIF scaled E-field

Grid 1 M4 18.84 dBV/m	Grid 2 M4 19.14 dBV/m	Grid 3 M4 19.46 dBV/m
Grid 4 M4 17.58 dBV/m	Grid 5 M4 18.21 dBV/m	Grid 6 M4 19.52 dBV/m
Grid 7 M4 20.14 dBV/m	Grid 8 M4 17.82 dBV/m	Grid 9 M4 19.33 dBV/m

Total = 20.14 dBV/m

E Category: M4

Location: 25, 25, 8.7 mm

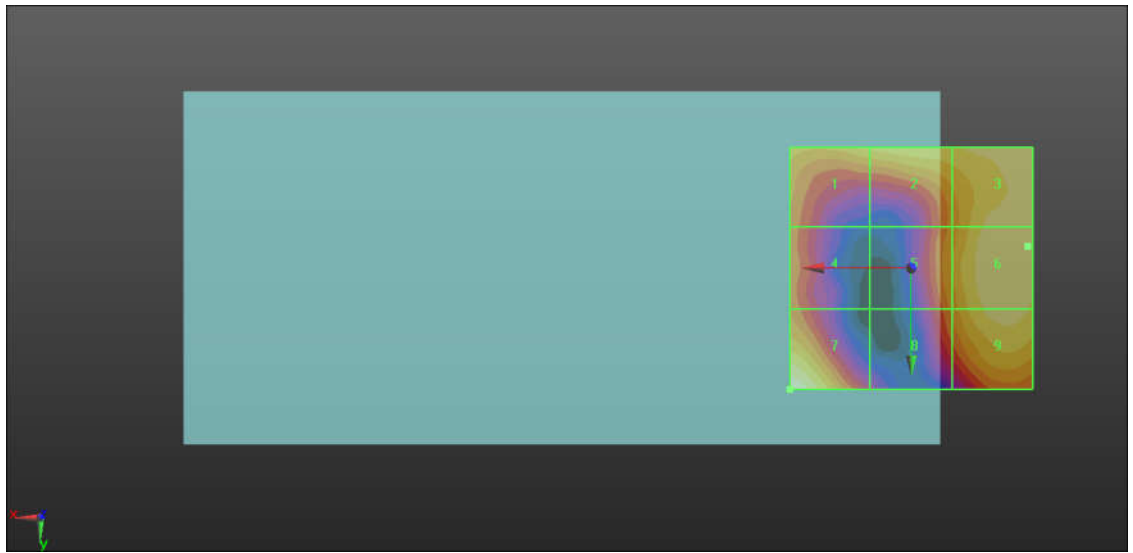
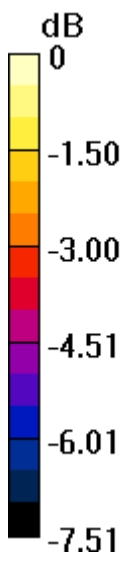

0 dB = 10.16 V/m = 20.14 dBV/m

34_HAC RF_LTE Band41_20M_QPSK_1RB_0offset_PCC: Ch41055& SCC:Ch40857

Communication System: UID 10172 - CAC, LTE-TDD (SC-FDMA, 1 RB, 20 MHz, QPSK);

Frequency: PCC:2636.5 MHz&SCC:2616.7MHz;Duty Cycle: 1:1

Medium: Air Medium parameters used: $\sigma = 0$ S/m, $\epsilon_r = 1$; $\rho = 0$ kg/m³

Ambient Temperature : 23.4 °C

DASY5 Configuration:

- Probe: EF3DV3 - SN4053; ConvF(1, 1, 1); Calibrated: 2018.03.19;

- Sensor-Surface: (Fix Surface)

- Electronics: DAE4 Sn1386; Calibrated: 2017.07.20

- Phantom: HAC Test Arch with AMCC; Type: SD HAC P01 BA;

- Measurement SW: DASY52, Version 52.8 (8); SEMCAD X Version 14.6.10 (7331)

PCC: Ch41055& SCC:Ch40857/Hearing Aid Compatibility Test (101x101x1):

Interpolated grid: dx=0.5000 mm,dy=0.5000 mm

Device Reference Point: 0, 0, -6.3 mm

Reference Value = 6.802 V/m; Power Drift = 0.07 dB

Applied MIF = -1.62 dB

RF audio interference level = 19.66 dBV/m

Emission category: M4

MIF scaled E-field

Grid 1 M4 18.13 dBV/m	Grid 2 M4 16.62 dBV/m	Grid 3 M4 17.94 dBV/m
Grid 4 M4 18.34 dBV/m	Grid 5 M4 17.26 dBV/m	Grid 6 M4 18.64 dBV/m
Grid 7 M4 19.66 dBV/m	Grid 8 M4 17.26 dBV/m	Grid 9 M4 18.64 dBV/m

Total = 19.66 dBV/m

E Category: M4

Location: 25, 25, 8.7 mm

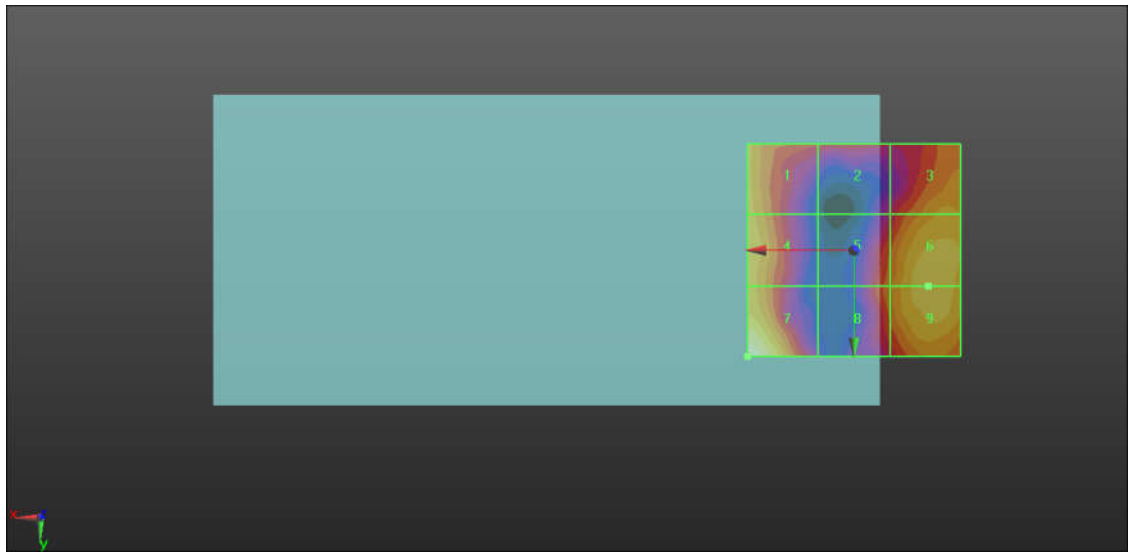
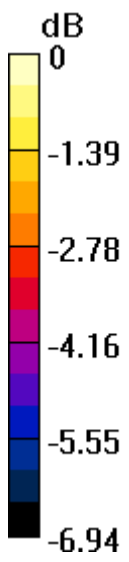

0 dB = 9.621 V/m = 19.66 dBV/m

35_HAC RF_LTE Band41_20M_QPSK_1RB_0offset_PCC: Ch41490& SCC:Ch41292

Communication System: UID 10172 - CAC, LTE-TDD (SC-FDMA, 1 RB, 20 MHz, QPSK);

Frequency: PCC:2680 MHz&SCC:2660.2MHz;Duty Cycle: 1:1

Medium: Air Medium parameters used: $\sigma = 0$ S/m, $\epsilon_r = 1$; $\rho = 0$ kg/m³

Ambient Temperature : 23.4 °C

DASY5 Configuration:

- Probe: EF3DV3 - SN4053; ConvF(1, 1, 1); Calibrated: 2018.03.19;

- Sensor-Surface: (Fix Surface)

- Electronics: DAE4 Sn1386; Calibrated: 2017.07.20

- Phantom: HAC Test Arch with AMCC; Type: SD HAC P01 BA;

- Measurement SW: DASY52, Version 52.8 (8); SEMCAD X Version 14.6.10 (7331)

PCC: Ch41490& SCC:Ch41292/Hearing Aid Compatibility Test (101x101x1):

Interpolated grid: dx=0.5000 mm,dy=0.5000 mm

Device Reference Point: 0, 0, -6.3 mm

Reference Value = 5.615 V/m; Power Drift = 0.18 dB

Applied MIF = -1.62 dB

RF audio interference level = 18.78 dBV/m

Emission category: M4

MIF scaled E-field

Grid 1 M4 18.78 dBV/m	Grid 2 M4 17.49 dBV/m	Grid 3 M4 16.62 dBV/m
Grid 4 M4 17.84 dBV/m	Grid 5 M4 15.46 dBV/m	Grid 6 M4 16.87 dBV/m
Grid 7 M4 17.36 dBV/m	Grid 8 M4 15.7 dBV/m	Grid 9 M4 17.11 dBV/m

Total = 18.78 dBV/m

E Category: M4

Location: 25, -25, 8.7 mm

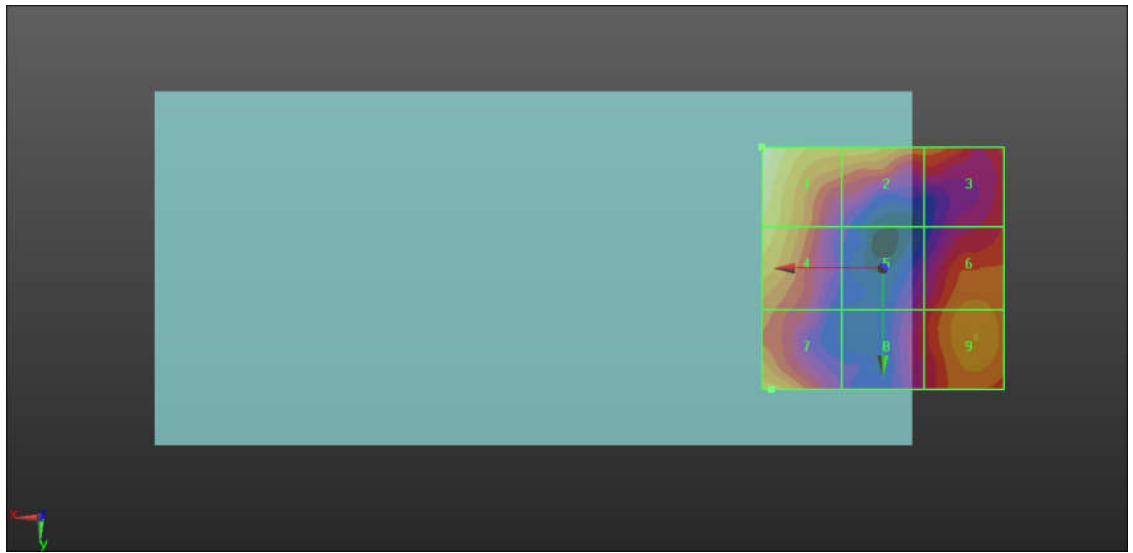
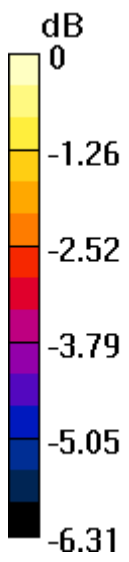

0 dB = 8.685 V/m = 18.78 dBV/m



Appendix C. DASY Calibration Certificate

The DASY calibration certificates are shown as follows.



Accredited by the Swiss Accreditation Service (SAS)
The Swiss Accreditation Service is one of the signatories to the EA
Multilateral Agreement for the recognition of calibration certificates

Accreditation No.: **SCS 0108**

Client **Sporton (Auden)**

Certificate No: **CD835V3-1171_Mar18**

CALIBRATION CERTIFICATE

Object **CD835V3 - SN: 1171**

Calibration procedure(s) **QA CAL-20.v6
Calibration procedure for dipoles in air**

Calibration date: **March 26, 2018**

This calibration certificate documents the traceability to national standards, which realize the physical units of measurements (SI).
The measurements and the uncertainties with confidence probability are given on the following pages and are part of the certificate.

All calibrations have been conducted in the closed laboratory facility: environment temperature (22 ± 3)°C and humidity < 70%.

Calibration Equipment used (M&TE critical for calibration)

Primary Standards	ID #	Cal Date (Certificate No.)	Scheduled Calibration
Power meter NRP	SN: 104778	04-Apr-17 (No. 217-02521/02522)	Apr-18
Power sensor NRP-Z91	SN: 103244	04-Apr-17 (No. 217-02521)	Apr-18
Power sensor NRP-Z91	SN: 103245	04-Apr-17 (No. 217-02522)	Apr-18
Reference 20 dB Attenuator	SN: 5058 (20k)	07-Apr-17 (No. 217-02528)	Apr-18
Type-N mismatch combination	SN: 5047.2 / 06327	07-Apr-17 (No. 217-02529)	Apr-18
Probe EF3DV3	SN: 4013	05-Mar-18 (No. EF3-4013_Mar18)	Mar-19
DAE4	SN: 781	17-Jan-18 (No. DAE4-781_Jan18)	Jan-19

Secondary Standards	ID #	Check Date (in house)	Scheduled Check
Power meter Agilent 4419B	SN: GB42420191	09-Oct-09 (in house check Oct-17)	In house check: Oct-20
Power sensor HP E4412A	SN: US38485102	05-Jan-10 (in house check Oct-17)	In house check: Oct-20
Power sensor HP 8482A	SN: US37295597	09-Oct-09 (in house check Oct-17)	In house check: Oct-20
RF generator R&S SMT-06	SN: 832283/011	27-Aug-12 (in house check Oct-17)	In house check: Oct-20
Network Analyzer HP 8753E	SN: US37390585	18-Oct-01 (in house check Oct-17)	In house check: Oct-18

	Name	Function	Signature
Calibrated by:	Claudio Leubler	Laboratory Technician	
Approved by:	Katja Pokovic	Technical Manager	

Issued: March 26, 2018

This calibration certificate shall not be reproduced except in full without written approval of the laboratory.



Accredited by the Swiss Accreditation Service (SAS)

The Swiss Accreditation Service is one of the signatories to the EA
Multilateral Agreement for the recognition of calibration certificates

References

- [1] ANSI-C63.19-2011
American National Standard, Methods of Measurement of Compatibility between Wireless Communications
Devices and Hearing Aids.

Methods Applied and Interpretation of Parameters:

- *Coordinate System:* y-axis is in the direction of the dipole arms. z-axis is from the basis of the antenna (mounted on the table) towards its feed point between the two dipole arms. x-axis is normal to the other axes. In coincidence with the standards [1], the measurement planes (probe sensor center) are selected to be at a distance of 15 mm above the top metal edge of the dipole arms.
- *Measurement Conditions:* Further details are available from the hardcopies at the end of the certificate. All figures stated in the certificate are valid at the frequency indicated. The forward power to the dipole connector is set with a calibrated power meter connected and monitored with an auxiliary power meter connected to a directional coupler. While the dipole under test is connected, the forward power is adjusted to the same level.
- *Antenna Positioning:* The dipole is mounted on a HAC Test Arch phantom using the matching dipole positioner with the arms horizontal and the feeding cable coming from the floor. The measurements are performed in a shielded room with absorbers around the setup to reduce the reflections. It is verified before the mounting of the dipole under the Test Arch phantom, that its arms are perfectly in a line. It is installed on the HAC dipole positioner with its arms parallel below the dielectric reference wire and able to move elastically in vertical direction without changing its relative position to the top center of the Test Arch phantom. The vertical distance to the probe is adjusted after dipole mounting with a DASY5 Surface Check job. Before the measurement, the distance between phantom surface and probe tip is verified. The proper measurement distance is selected by choosing the matching section of the HAC Test Arch phantom with the proper device reference point (upper surface of the dipole) and the matching grid reference point (tip of the probe) considering the probe sensor offset. The vertical distance to the probe is essential for the accuracy.
- *Feed Point Impedance and Return Loss:* These parameters are measured using a HP 8753E Vector Network Analyzer. The impedance is specified at the SMA connector of the dipole. The influence of reflections was eliminated by applying the averaging function while moving the dipole in the air, at least 70cm away from any obstacles.
- *E-field distribution:* E field is measured in the x-y-plane with an isotropic ER3D-field probe with 100 mW forward power to the antenna feed point. In accordance with [1], the scan area is 20mm wide, its length exceeds the dipole arm length (180 or 90mm). The sensor center is 15 mm (in z) above the metal top of the dipole arms. Two 3D maxima are available near the end of the dipole arms. Assuming the dipole arms are perfectly in one line, the average of these two maxima (in subgrid 2 and subgrid 8) is determined to compensate for any non-parallelity to the measurement plane as well as the sensor displacement. The E-field value stated as calibration value represents the maximum of the interpolated 3D-E-field, in the plane above the dipole surface.

The reported uncertainty of measurement is stated as the standard uncertainty of measurement multiplied by the coverage factor $k=2$, which for a normal distribution corresponds to a coverage probability of approximately 95%.