



FCC RF Test Report

APPLICANT : Bullitt Group
EQUIPMENT : Rugged Smart Phone
BRAND NAME : CAT
MODEL NAME : S41
FCC ID : ZL5S41A
STANDARD : 47 CFR Part 2, 22(H), 24(E), 27
CLASSIFICATION : PCS Licensed Transmitter Held to Ear (PCE)

The product was received on Jun. 06, 2017 and completely tested on Aug. 05, 2017. We, SPORTON INTERNATIONAL INC., would like to declare that the tested sample has been evaluated in accordance with the test procedures given in ANSI / TIA / EIA-603-D-2010 and the testing has shown the tested sample to be in compliance with the applicable technical standards.

The test results in this report apply exclusively to the tested model / sample. Without written approval of SPORTON INTERNATIONAL INC., the test report shall not be reproduced except in full.

Reviewed by: Joseph Lin / Supervisor

Approved by: Jones Tsai / Manager



SPORTON INTERNATIONAL INC.

No. 52, Hwa Ya 1st Rd., Hwa Ya Technology Park, Kwei-Shan District, Tao Yuan City, Taiwan, R.O.C.



TABLE OF CONTENTS

REVISION HISTORY.....3
SUMMARY OF TEST RESULT4
1 GENERAL DESCRIPTION5
1.1 Applicant5
1.2 Manufacturer5
1.3 Product Feature of Equipment Under Test.....5
1.4 Modification of EUT5
1.5 Testing Location6
1.6 Applicable Standards.....6
2 TEST CONFIGURATION OF EQUIPMENT UNDER TEST7
2.1 Test Mode7
2.2 Connection Diagram of Test System9
2.3 Support Unit used in test configuration and system9
2.4 Measurement Results Explanation Example9
2.5 Frequency List of Low/Middle/High Channels10
3 CONDUCTED TEST ITEMS13
3.1 Measuring Instruments13
3.2 Test Setup13
3.3 Test Result of Conducted Test13
3.4 Conducted Output Power and ERP/EIRP14
3.5 Peak-to-Average Ratio15
3.6 Occupied Bandwidth16
3.7 Conducted Band Edge17
3.8 Conducted Spurious Emission19
3.9 Frequency Stability20
4 RADIATED TEST ITEMS21
4.1 Measuring Instruments21
4.2 Test Setup21
4.3 Test Result of Radiated Test21
4.4 Radiated Spurious Emission22
5 LIST OF MEASURING EQUIPMENT23
6 UNCERTAINTY OF EVALUATION24
APPENDIX A. TEST RESULTS OF CONDUCTED TEST
APPENDIX B. TEST RESULTS OF RADIATED TEST
APPENDIX C. TEST SETUP PHOTOGRAPHS



SUMMARY OF TEST RESULT

| Report Section | FCC Rule | Description | Limit | Result | Remark |
|----------------|---|---|-------------------------------------|--------|--|
| 3.4 | §2.1046 | Conducted Output Power | Reporting Only | PASS | - |
| | §22.913(a)(2) | Effective Radiated Power (Band 5) | ERP < 7 Watt | | |
| | §24.232(c) §27.50(h)(2) | Equivalent Isotropic Radiated Power (Band 2)(Band 7)(Band 41) | EIRP < 2Watt | | |
| | §27.50(d)(4) | Equivalent Isotropic Radiated Power (Band 4) | EIRP < 1Watt | | |
| 3.5 | §24.232(d) | Peak-to-Average Ratio | <13 dB | PASS | - |
| 3.6 | §2.1049 | Occupied Bandwidth | Reporting Only | PASS | - |
| 3.7 | §2.1051 §22.917(a) §24.238(a) §27.53(h) | Conducted Band Edge Measurement (Band 2) (Band 4) (Band 5) | < 43+10log ₁₀ (P[Watts]) | PASS | - |
| | §27.53(m)(4) | Conducted Band Edge Measurement (Band 7) (Band 38) (Band 41) | §27.53(m)(4) | | |
| 3.8 | §2.1051 §22.917(a) §24.238(a) §27.53(h) | Conducted Spurious Emission (Band 2) (Band 4) (Band 5) | < 43+10log ₁₀ (P[Watts]) | PASS | - |
| | §2.1051 §27.53(m)(4) | Conducted Spurious Emission (Band 7)(Band 38)(Band 41) | < 55+10log ₁₀ (P[Watts]) | | |
| 3.9 | §2.1055 §22.355 | Frequency Stability Temperature & Voltage | < 2.5 ppm for Part 22 | PASS | - |
| | §2.1055 §24.235 §27.54 | | Within Authorized Band | | |
| 4.4 | §2.1053 §22.917(a) §24.238(a) §27.53(f) §27.53(h) | Radiated Spurious Emission (Band 2) (Band 4) (Band 5) | < 43+10log ₁₀ (P[Watts]) | PASS | Under limit 12.72 dB at 15192.000 MHz |
| | §2.1053 §27.53(m)(4) | Radiated Spurious Emission (Band 7)(Band 38)(Band 41) | < 55+10log ₁₀ (P[Watts]) | | |



1 General Description

1.1 Applicant

Bullitt Group

One Valpy, Valpy Street, Reading, Berkshire, England RG1 1AR

1.2 Manufacturer

Compal Electronics, INC.

No. 385, Yangguang St. Neihu District, Taipei City 11491, Taiwan, R.O.C

1.3 Product Feature of Equipment Under Test

GSM/WCDMA/LTE, Bluetooth, Wi-Fi 2.4GHz 802.11b/g/n, Wi-Fi 5GHz 802.11a/n, FM Receiver, NFC, and GPS.

| Product Specification subjective to this standard | |
|---|--|
| Antenna Type | WWAN: PIFA + Coupling type (LDS) Antenna WLAN: PIFA Antenna Bluetooth: PIFA Antenna GPS / Glonass : PIFA Antenna NFC: Loop Antenna FM: Integral Antenna (Earphone acting as FM antenna deemed as an integral antenna) |

<Sample Information>

| S41 has 2 different Variant | |
|--|------------|
| Sample 1 | Dual SIM |
| Sample 2 | Single SIM |
| For Dual-SIM or Single-SIM control by SW, The HW difference is SIM holder. | |

Remark: All test items were performed with Sample 1.

1.4 Modification of EUT

No modifications are made to the EUT during all test items.



1.5 Testing Location

Sporton Lab is accredited to ISO 17025 by Taiwan Accreditation Foundation (TAF code : 1190) and the FCC designation No. TW0007 under the FCC 2.948(e) by Mutual Recognition Agreement (MRA) in FCC Test.

| | |
|---------------------------|--|
| Test Site | SPORTON INTERNATIONAL INC. |
| Test Site Location | No. 52, Hwa Ya 1 st Rd., Hwa Ya Technology Park, Kwei-Shan District, Tao Yuan City, Taiwan, R.O.C. TEL: +886-3-327-3456 FAX: +886-3-328-4978 |
| Test Site No. | Sporton Site No. |
| | TH03-HY |

| | |
|---------------------------|--|
| Test Site | SPORTON INTERNATIONAL INC. |
| Test Site Location | No.58, Aly. 75, Ln. 564, Wenhua 3rd Rd. Guishan Dist, Taoyuan City, Taiwan (R.O.C.) TEL: +886-3-327-0868 FAX: +886-3-327-0855 |
| Test Site No. | Sporton Site No. |
| | 03CH11-HY |

1.6 Applicable Standards

According to the specifications of the manufacturer, the EUT must comply with the requirements of the following standards:

- ♦ 47 CFR Part 2, 22(H), 24(E), 27
- ♦ ANSI / TIA / EIA-603-D-2010
- ♦ FCC KDB 971168 D01 Power Meas. License Digital Systems v02r02
- ♦ FCC KDB 412172 D01 Determining ERP and EIRP v01r01

Remark:

1. All test items were verified and recorded according to the standards and without any deviation during the test.
2. This EUT has also been tested and complied with the requirements of FCC Part 15, Subpart B, recorded in a separate test report.



2 Test Configuration of Equipment Under Test

2.1 Test Mode

Antenna port conducted and radiated test items listed below are performed according to KDB 971168 D01 Power Meas. License Digital Systems v02r02 with maximum output power.

Radiated measurements are performed by rotating the EUT in three different orthogonal test planes to find the maximum emission.

| Test Items | Band | Bandwidth (MHz) | | | | | | Modulation | | RB # | | | Test Channel | | |
|------------------------|------|-----------------|---|---|----|----|----|------------|-------|------|------|------|--------------|---|---|
| | | 1.4 | 3 | 5 | 10 | 15 | 20 | QPSK | 16QAM | 1 | Half | Full | L | M | H |
| Max. Output Power | 2 | ✓ | ✓ | ✓ | ✓ | ✓ | ✓ | ✓ | ✓ | ✓ | ✓ | ✓ | ✓ | ✓ | ✓ |
| | 4 | ✓ | ✓ | ✓ | ✓ | ✓ | ✓ | ✓ | ✓ | ✓ | ✓ | ✓ | ✓ | ✓ | ✓ |
| | 5 | ✓ | ✓ | ✓ | ✓ | - | - | ✓ | ✓ | ✓ | ✓ | ✓ | ✓ | ✓ | ✓ |
| | 7 | - | - | ✓ | ✓ | ✓ | ✓ | ✓ | ✓ | ✓ | ✓ | ✓ | ✓ | ✓ | ✓ |
| | 38 | - | - | ✓ | ✓ | ✓ | ✓ | ✓ | ✓ | ✓ | ✓ | ✓ | ✓ | ✓ | ✓ |
| | 41 | - | - | ✓ | ✓ | ✓ | ✓ | ✓ | ✓ | ✓ | ✓ | ✓ | ✓ | ✓ | ✓ |
| Peak-to-Average Ratio | 2 | | | | | | ✓ | ✓ | ✓ | ✓ | | ✓ | ✓ | ✓ | ✓ |
| | 4 | | | | | | ✓ | ✓ | ✓ | ✓ | | ✓ | ✓ | ✓ | ✓ |
| | 5 | | | | ✓ | - | - | ✓ | ✓ | ✓ | | ✓ | ✓ | ✓ | ✓ |
| | 7 | - | - | | | | ✓ | ✓ | ✓ | ✓ | | ✓ | ✓ | ✓ | ✓ |
| | 38 | - | - | | | | ✓ | ✓ | ✓ | ✓ | | ✓ | ✓ | ✓ | ✓ |
| | 41 | - | - | | | | ✓ | ✓ | ✓ | ✓ | | ✓ | ✓ | ✓ | ✓ |
| 26dB and 99% Bandwidth | 2 | ✓ | ✓ | ✓ | ✓ | ✓ | ✓ | ✓ | ✓ | | | ✓ | ✓ | ✓ | ✓ |
| | 4 | ✓ | ✓ | ✓ | ✓ | ✓ | ✓ | ✓ | ✓ | | | ✓ | ✓ | ✓ | ✓ |
| | 5 | ✓ | ✓ | ✓ | ✓ | - | - | ✓ | ✓ | | | ✓ | ✓ | ✓ | ✓ |
| | 7 | - | - | ✓ | ✓ | ✓ | ✓ | ✓ | ✓ | | | ✓ | ✓ | ✓ | ✓ |
| | 38 | - | - | ✓ | ✓ | ✓ | ✓ | ✓ | ✓ | | | ✓ | ✓ | ✓ | ✓ |
| | 41 | - | - | ✓ | ✓ | ✓ | ✓ | ✓ | ✓ | | | ✓ | ✓ | ✓ | ✓ |
| Conducted Band Edge | 2 | ✓ | ✓ | ✓ | ✓ | ✓ | ✓ | ✓ | ✓ | ✓ | | ✓ | ✓ | | ✓ |
| | 4 | ✓ | ✓ | ✓ | ✓ | ✓ | ✓ | ✓ | ✓ | ✓ | | ✓ | ✓ | | ✓ |
| | 5 | ✓ | ✓ | ✓ | ✓ | - | - | ✓ | ✓ | ✓ | | ✓ | ✓ | | ✓ |
| | 7 | - | - | ✓ | ✓ | ✓ | ✓ | ✓ | ✓ | ✓ | | ✓ | ✓ | | ✓ |
| | 38 | - | - | ✓ | ✓ | ✓ | ✓ | ✓ | ✓ | ✓ | | ✓ | ✓ | | ✓ |
| | 41 | - | - | ✓ | ✓ | ✓ | ✓ | ✓ | ✓ | ✓ | | ✓ | ✓ | | ✓ |



| Test Items | Band | Bandwidth (MHz) | | | | | | Modulation | | RB # | | | Test Channel | | |
|-----------------------------|---|-----------------|---|---|----|----|----|------------|-------|------|------|------|--------------|---|---|
| | | 1.4 | 3 | 5 | 10 | 15 | 20 | QPSK | 16QAM | 1 | Half | Full | L | M | H |
| Conducted Spurious Emission | 2 | √ | √ | √ | √ | √ | √ | √ | √ | √ | | | √ | √ | √ |
| | 4 | √ | √ | √ | √ | √ | √ | √ | √ | √ | | | √ | √ | √ |
| | 5 | √ | √ | √ | √ | - | - | √ | √ | √ | | | √ | √ | √ |
| | 7 | - | - | √ | √ | √ | √ | √ | √ | √ | | | √ | √ | √ |
| | 38 | - | - | √ | √ | √ | √ | √ | √ | √ | | | √ | √ | √ |
| | 41 | - | - | √ | √ | √ | √ | √ | √ | √ | | | √ | √ | √ |
| Frequency Stability | 2 | | | | √ | | | √ | | | | √ | | √ | |
| | 4 | | | | √ | | | √ | | | | √ | | √ | |
| | 5 | | | | √ | - | - | √ | | | | √ | | √ | |
| | 7 | - | - | | √ | | | √ | | | | √ | | √ | |
| | 38 | - | - | | √ | | | √ | | | | √ | | √ | |
| | 41 | - | - | | √ | | | √ | | | | √ | | √ | |
| E.R.P./E.I.R.P. | 2 | √ | √ | √ | √ | √ | √ | √ | √ | √ | | | √ | √ | √ |
| | 4 | √ | √ | √ | √ | √ | √ | √ | √ | √ | | | √ | √ | √ |
| | 5 | √ | √ | √ | √ | - | - | √ | √ | √ | | | √ | √ | √ |
| | 7 | - | - | √ | √ | √ | √ | √ | √ | √ | | | √ | √ | √ |
| | 38 | - | - | √ | √ | √ | √ | √ | √ | √ | | | √ | √ | √ |
| | 41 | - | - | √ | √ | √ | √ | √ | √ | √ | | | √ | √ | √ |
| Radiated Spurious Emission | 2 | √ | √ | √ | √ | √ | √ | √ | | √ | | | √ | √ | √ |
| | 4 | √ | √ | √ | √ | √ | √ | √ | | √ | | | | √ | √ |
| | 5 | √ | √ | √ | √ | - | - | √ | | √ | | | | √ | √ |
| | 7 | - | - | √ | √ | √ | √ | √ | | √ | | | √ | √ | |
| | 38 | - | - | √ | √ | √ | √ | √ | | √ | | | √ | | √ |
| | 41 | - | - | √ | √ | √ | √ | √ | | √ | | | | | √ |
| Note | <p>1. The mark "√" means that this configuration is chosen for testing</p> <p>2. The mark "-" means that this bandwidth is not supported.</p> <p>3. The device is investigated from 30MHz to 10 times of fundamental signal for radiated spurious emission test under different RB size/offset and modulations in exploratory test. Subsequently, only the worst case emissions are reported.</p> | | | | | | | | | | | | | | |

2.2 Connection Diagram of Test System

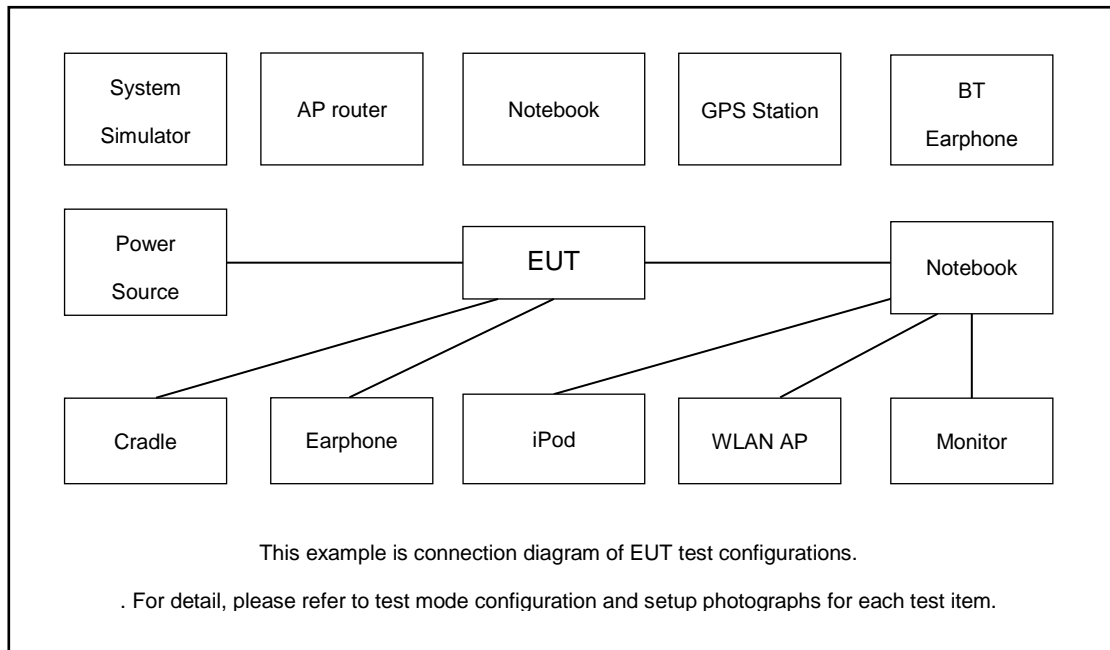

2.3 Support Unit used in test configuration and system

| Item | Equipment | Trade Name | Model No. | FCC ID | Data Cable | Power Cord |
|------|------------------|------------|-----------|--------|------------|-------------------|
| 1. | System Simulator | Anritsu | MT8820C | N/A | N/A | Unshielded, 1.8 m |

2.4 Measurement Results Explanation Example

For all conducted test items:

The offset level is set in the spectrum analyzer to compensate the RF cable loss and attenuator factor between EUT conducted output port and spectrum analyzer. With the offset compensation, the spectrum analyzer reading level is exactly the EUT RF output level.

The spectrum analyzer offset is derived from RF cable loss and attenuator factor.

$Offset = RF\ cable\ loss + attenuator\ factor.$

Following shows an offset computation example with cable loss 4.2 dB and 10dB attenuator.

Example :

$Offset(dB) = RF\ cable\ loss(dB) + attenuator\ factor(dB).$
 $= 4.2 + 10 = 14.2 (dB)$



2.5 Frequency List of Low/Middle/High Channels

| LTE Band 2 Channel and Frequency List | | | | |
|---------------------------------------|------------------------|--------|--------|---------|
| BW [MHz] | Channel/Frequency(MHz) | Lowest | Middle | Highest |
| 20 | Channel | 18700 | 18900 | 19100 |
| | Frequency | 1860 | 1880 | 1900 |
| 15 | Channel | 18675 | 18900 | 19125 |
| | Frequency | 1857.5 | 1880 | 1902.5 |
| 10 | Channel | 18650 | 18900 | 19150 |
| | Frequency | 1855 | 1880 | 1905 |
| 5 | Channel | 18625 | 18900 | 19175 |
| | Frequency | 1852.5 | 1880 | 1907.5 |
| 3 | Channel | 18615 | 18900 | 19185 |
| | Frequency | 1851.5 | 1880 | 1908.5 |
| 1.4 | Channel | 18607 | 18900 | 19193 |
| | Frequency | 1850.7 | 1880 | 1909.3 |

| LTE Band 4 Channel and Frequency List | | | | |
|---------------------------------------|------------------------|--------|--------|---------|
| BW [MHz] | Channel/Frequency(MHz) | Lowest | Middle | Highest |
| 20 | Channel | 20050 | 20175 | 20300 |
| | Frequency | 1720 | 1732.5 | 1745 |
| 15 | Channel | 20025 | 20175 | 20325 |
| | Frequency | 1717.5 | 1732.5 | 1747.5 |
| 10 | Channel | 20000 | 20175 | 20350 |
| | Frequency | 1715 | 1732.5 | 1750 |
| 5 | Channel | 19975 | 20175 | 20375 |
| | Frequency | 1712.5 | 1732.5 | 1752.5 |
| 3 | Channel | 19965 | 20175 | 20385 |
| | Frequency | 1711.5 | 1732.5 | 1753.5 |
| 1.4 | Channel | 19957 | 20175 | 20393 |
| | Frequency | 1710.7 | 1732.5 | 1754.3 |



| LTE Band 5 Channel and Frequency List | | | | |
|---------------------------------------|------------------------|--------|--------|---------|
| BW [MHz] | Channel/Frequency(MHz) | Lowest | Middle | Highest |
| 10 | Channel | 20450 | 20525 | 20600 |
| | Frequency | 829 | 836.5 | 844 |
| 5 | Channel | 20425 | 20525 | 20625 |
| | Frequency | 826.5 | 836.5 | 846.5 |
| 3 | Channel | 20415 | 20525 | 20635 |
| | Frequency | 825.5 | 836.5 | 847.5 |
| 1.4 | Channel | 20407 | 20525 | 20643 |
| | Frequency | 824.7 | 836.5 | 848.3 |

| LTE Band 7 Channel and Frequency List | | | | |
|---------------------------------------|------------------------|--------|--------|---------|
| BW [MHz] | Channel/Frequency(MHz) | Lowest | Middle | Highest |
| 20 | Channel | 20850 | 21100 | 21350 |
| | Frequency | 2510 | 2535 | 2560 |
| 15 | Channel | 20825 | 21100 | 21375 |
| | Frequency | 2507.5 | 2535 | 2562.5 |
| 10 | Channel | 20800 | 21100 | 21400 |
| | Frequency | 2505 | 2535 | 2565 |
| 5 | Channel | 20775 | 21100 | 21425 |
| | Frequency | 2502.5 | 2535 | 2567.5 |



| LTE Band 38 Channel and Frequency List | | | | |
|--|------------------------|--------|--------|---------|
| BW [MHz] | Channel/Frequency(MHz) | Lowest | Middle | Highest |
| 20 | Channel | 37850 | 38000 | 38150 |
| | Frequency | 2580 | 2595 | 2610 |
| 15 | Channel | 37825 | 38000 | 38175 |
| | Frequency | 2577.5 | 2595 | 2612.5 |
| 10 | Channel | 37800 | 38000 | 38200 |
| | Frequency | 2575 | 2595 | 2615 |
| 5 | Channel | 37775 | 38000 | 38225 |
| | Frequency | 2572.5 | 2595 | 2617.5 |

| LTE Band 41 Channel and Frequency List | | | | |
|--|------------------------|--------|--------|---------|
| BW [MHz] | Channel/Frequency(MHz) | Lowest | Middle | Highest |
| 20 | Channel | 39750 | 40620 | 41490 |
| | Frequency | 2506 | 2593 | 2680 |
| 15 | Channel | 39725 | 40620 | 41515 |
| | Frequency | 2503.5 | 2593 | 2682.5 |
| 10 | Channel | 39700 | 40620 | 41540 |
| | Frequency | 2501 | 2593 | 2685 |
| 5 | Channel | 39675 | 40620 | 41565 |
| | Frequency | 2498.5 | 2593 | 2687.5 |

3 Conducted Test Items

3.1 Measuring Instruments

See list of measuring instruments of this test report.

3.2 Test Setup

3.2.1 Conducted Output Power

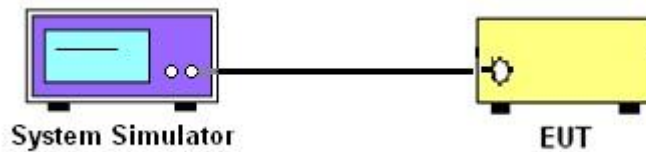

3.2.2 Peak-to-Average Ratio, Occupied Bandwidth ,Conducted Band-Edge and Conducted Spurious Emission

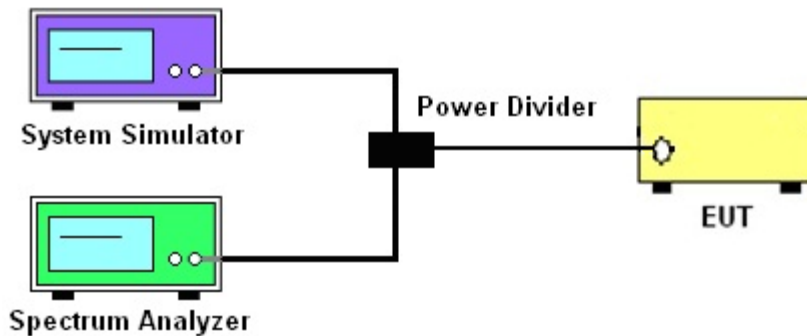

3.2.3 Frequency Stability

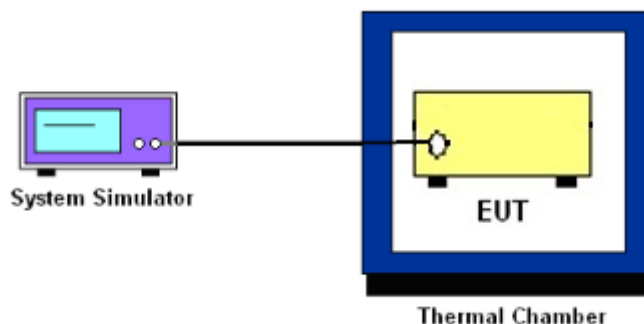

3.3 Test Result of Conducted Test

Please refer to Appendix A.



3.4 Conducted Output Power and ERP/EIRP

3.4.1 Description of the Conducted Output Power Measurement and ERP/EIRP Measurement

A system simulator was used to establish communication with the EUT. Its parameters were set to force the EUT transmitting at maximum output power. The measured power in the radio frequency on the transmitter output terminals shall be reported.

The ERP of mobile transmitters must not exceed 7 Watts for LTE Band 5.

The EIRP of mobile transmitters must not exceed 2 Watts for LTE Band 2 and Band 7 and Band 38 and Band 41.

The EIRP of mobile transmitters must not exceed 1 Watts for LTE Band 4.

According to KDB 412172 D01 Power Approach,

$EIRP = P_T + G_T - L_C$, $ERP = EIRP - 2.15$, where

P_T = transmitter output power in dBm

G_T = gain of the transmitting antenna in dBi

L_C = signal attenuation in the connecting cable between the transmitter and antenna in dB

3.4.2 Test Procedures

1. The transmitter output port was connected to the system simulator.
2. Set EUT at maximum power through the system simulator.
3. Select lowest, middle, and highest channels for each band and different modulation.
4. Measure and record the power level from the system simulator.



3.5 Peak-to-Average Ratio

3.5.1 Description of the PAR Measurement

Power Complementary Cumulative Distribution Function (CCDF) curves provide a means for characterizing the power peaks of a digitally modulated signal on a statistical basis. A CCDF curve depicts the probability of the peak signal amplitude exceeding the average power level. Most contemporary measurement instrumentation include the capability to produce CCDF curves for an input signal provided that the instrument's resolution bandwidth can be set wide enough to accommodate the entire input signal bandwidth. In measuring transmissions in this band using an average power technique, the peak-to-average ratio (PAR) of the transmission may not exceed 13 dB.

3.5.2 Test Procedures

1. The testing follows FCC KDB 971168 v02r02 Section 5.7.1.
2. The EUT was connected to spectrum and system simulator via a power divider.
3. Set the CCDF (Complementary Cumulative Distribution Function) option in spectrum analyzer.
4. The highest RF powers were measured and recorded the maximum PAPR level associated with a probability of 0.1 %.
5. Record the deviation as Peak to Average Ratio.



3.6 Occupied Bandwidth

3.6.1 Description of Occupied Bandwidth Measurement

The occupied bandwidth is the width of a frequency band such that, below the lower and above the upper frequency limits, the mean powers emitted are each equal to a specified percentage 0.5% of the total mean transmitted power.

The 26 dB emission bandwidth is defined as the frequency range between two points, one above and one below the carrier frequency, at which the spectral density of the emission is attenuated 26 dB below the maximum in-band spectral density of the modulated signal. Spectral density (power per unit bandwidth) is to be measured with a detector of resolution bandwidth equal to approximately 1.0% of the emission bandwidth.

3.6.2 Test Procedures

1. The testing follows FCC KDB 971168 v02r02 Section 4.2.
2. The EUT was connected to spectrum analyzer and system simulator via a power divider.
3. The spectrum analyzer center frequency is set to the nominal EUT channel center frequency. The span range for the spectrum analyzer shall be between two and five times the anticipated OBW.
4. The nominal resolution bandwidth (RBW) shall be in the range of 1 to 5 % of the anticipated OBW, and the VBW shall be at least 3 times the RBW.
5. Set the detection mode to peak, and the trace mode to max hold.
6. Determine the reference value: Set the EUT to transmit a modulated signal. Allow the trace to stabilize. Set the spectrum analyzer marker to the highest level of the displayed trace.
(this is the reference value)
7. Determine the “-26 dB down amplitude” as equal to (Reference Value – X).
8. Place two markers, one at the lowest and the other at the highest frequency of the envelope of the spectral display such that each marker is at or slightly below the “-X dB down amplitude” determined in step 6. If a marker is below this “-X dB down amplitude” value it shall be placed as close as possible to this value. The OBW is the positive frequency difference between the two markers.
9. Use the 99 % power bandwidth function of the spectrum analyzer and report the measured bandwidth.



3.7 Conducted Band Edge

3.7.1 Description of Conducted Band Edge Measurement

22.917(a)

For operations in the 824 – 849 MHz band, the FCC limit is $43 + 10\log_{10}(P[\text{Watts}])$ dB below the transmitter power $P(\text{Watts})$ in a 100kHz bandwidth. However, in the 1MHz bands immediately outside and adjacent to the licensee's frequency block, a resolution bandwidth of at least one percent of the emission bandwidth of the fundamental emission of the transmitter may be employed.

24.238 (a)

For operations in the 1850-1910 and 1930-1990 MHz band, the FCC limit is $43 + 10\log_{10}(P[\text{Watts}])$ dB below the transmitter power $P(\text{Watts})$ in a 1MHz bandwidth. However, in the 1 MHz bands immediately outside and adjacent to the frequency block a resolution bandwidth of at least one percent of the emission bandwidth of the fundamental emission of the transmitter may be employed.

27.53 (h)

For operations in the 1710 – 1755 MHz band, the FCC limit is $43 + 10\log_{10}(P[\text{Watts}])$ dB below the transmitter power $P(\text{Watts})$ in a 1 MHz bandwidth. However, in the 1MHz bands immediately outside and adjacent to the licensee's frequency block, a resolution bandwidth of at least one percent of the emission bandwidth of the fundamental emission of the transmitter may be employed.

27.53(m)(4)

For mobile digital stations, the attenuation factor shall be not less than $40 + 10 \log (P)$ dB on all frequencies between the channel edge and 5 megahertz from the channel edge, $43 + 10 \log (P)$ dB on all frequencies between 5 megahertz and X megahertz from the channel edge, and $55 + 10 \log (P)$ dB on all frequencies more than X megahertz from the channel edge, where X is the greater of 6 megahertz or the actual emission bandwidth as defined in paragraph (m)(6) of this section. In addition, the attenuation factor shall not be less that $43 + 10 \log (P)$ dB on all frequencies between 2490.5 MHz and 2496 MHz and $55 + 10 \log (P)$ dB at or below 2490.5 MHz. Mobile Satellite Service licensees operating on frequencies below 2495 MHz may also submit a documented interference complaint against BRS licensees operating on channel BRS Channel 1 on the same terms and conditions as adjacent channel BRS or EBS licensees.



3.7.2 Test Procedures

1. The testing follows FCC KDB 971168 v02r02 Section 6.0.
2. The EUT was connected to spectrum analyzer and system simulator via a power divider.
3. The band edges of low and high channels for the highest RF powers were measured.
4. Set RBW \geq 1% EBW in the 1MHz band immediately outside and adjacent to the band edge.
5. Beyond the 1 MHz band from the band edge, RBW=1MHz was used.
6. Set spectrum analyzer with RMS detector.
7. The RF fundamental frequency should be excluded against the limit line in the operating frequency band.
8. Checked that all the results comply with the emission limit line.
The limit line is derived from $43 + 10\log(P)$ dB below the transmitter power P(Watts)
9. For LTE Band 7, 38, 41, the other 40 dB, and 55 dB have additionally applied same calculation above.



3.8 Conducted Spurious Emission

3.8.1 Description of Conducted Spurious Emission Measurement

The power of any emission outside of the authorized operating frequency ranges must be lower than the transmitter power (P) by a factor of at least $43 + 10 \log (P)$ dB.

For Band 7,38,41:

The power of any emission outside of the authorized operating frequency ranges must be lower than the transmitter power (P) by a factor of at least $55 + 10 \log (P)$ dB.

It is measured by means of a calibrated spectrum analyzer and scanned from 30 MHz up to a frequency including its 10th harmonic.

3.8.2 Test Procedures

1. The testing follows FCC KDB 971168 v02r02 Section 6.0.
2. The EUT was connected to spectrum analyzer and system simulator via a power divider.
3. The RF output of EUT was connected to the spectrum analyzer by RF cable and attenuator. The path loss was compensated to the results for each measurement.
4. The middle channel for the highest RF power within the transmitting frequency was measured.
5. The conducted spurious emission for the whole frequency range was taken.
6. Make the measurement with the spectrum analyzer's RBW = 1MHz, VBW = 3MHz.
7. Set spectrum analyzer with RMS detector.
8. Taking the record of maximum spurious emission.
9. The RF fundamental frequency should be excluded against the limit line in the operating frequency band.
10. The limit line is derived from $43 + 10\log(P)$ dB below the transmitter power P(Watts)
11. For Band 7, 38, 41
The limit line is derived from $55 + 10\log(P)$ dB below the transmitter power P(Watts)



3.9 Frequency Stability

3.9.1 Description of Frequency Stability Measurement

The frequency stability shall be measured by variation of ambient temperature and variation of primary supply voltage to ensure that the fundamental emission stays within the authorized frequency block. The frequency stability of the transmitter shall be maintained within $\pm 0.00025\%$ ($\pm 2.5\text{ppm}$) of the center frequency.

3.9.2 Test Procedures for Temperature Variation

1. The testing follows FCC KDB 971168 v02r02 Section 9.0.
2. The EUT was set up in the thermal chamber and connected with the system simulator.
3. With power OFF, the temperature was decreased to -30°C and the EUT was stabilized before testing. Power was applied and the maximum change in frequency was recorded within one minute.
4. With power OFF, the temperature was raised in 10°C step up to 50°C . The EUT was stabilized at each step for at least half an hour. Power was applied and the maximum frequency change was recorded within one minute.

3.9.3 Test Procedures for Voltage Variation

1. The testing follows FCC KDB 971168 v02r02 Section 9.0.
2. The EUT was placed in a temperature chamber at $20\pm 5^{\circ}\text{C}$ and connected with the system simulator.
3. The power supply voltage to the EUT was varied from 85% to 115% of the nominal value measured at the input to the EUT.
4. The variation in frequency was measured for the worst case.

4 Radiated Test Items

4.1 Measuring Instruments

See list of measuring instruments of this test report.

4.2 Test Setup

4.2.1 For radiated test from 30MHz to 1GHz

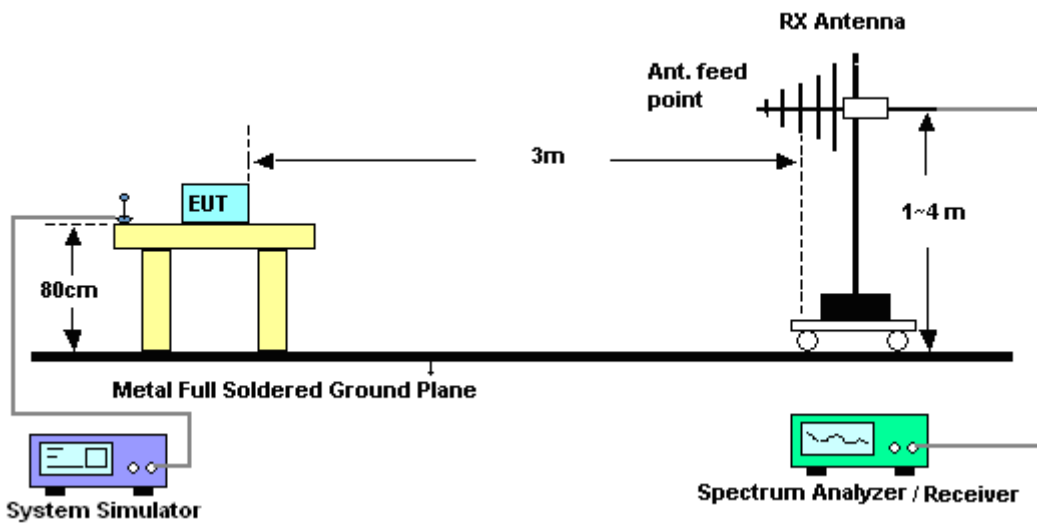

4.2.2 For radiated test above 1GHz

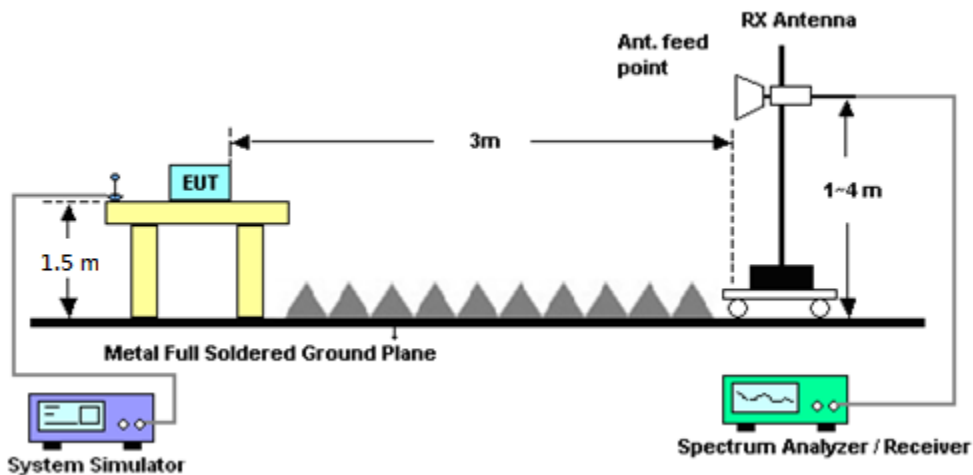

4.3 Test Result of Radiated Test

Please refer to Appendix B.



4.4 Radiated Spurious Emission

4.4.1 Description of Radiated Spurious Emission

The radiated spurious emission was measured by substitution method according to ANSI / TIA / EIA-603-D-2010. The power of any emission outside of the authorized operating frequency ranges must be attenuated below the transmitter power (P) by a factor of at least $43 + 10 \log (P)$ dB.

For Band 7, 38, 41

The power of any emission outside of the authorized operating frequency ranges must be attenuated below the transmitter power (P) by a factor of at least $55 + 10 \log (P)$ dB.

The spectrum is scanned from 30 MHz up to a frequency including its 10th harmonic.

4.4.2 Test Procedures

1. The testing follows FCC KDB 971168 v02r02 Section 5.8 and ANSI / TIA-603-D-2010 Section 2.2.12.
2. The EUT was placed on a turntable with 0.8 meter for frequency below 1GHz and 1.5 meter for frequency above 1GHz respectively above ground.
3. The EUT was set 3 meters from the receiving antenna, which was mounted on the antenna tower.
4. The table was rotated 360 degrees to determine the position of the highest spurious emission.
5. The height of the receiving antenna is varied between one meter and four meters to search the maximum spurious emission for both horizontal and vertical polarizations.
6. Make the measurement with the spectrum analyzer's RBW = 1MHz, VBW = 3MHz, taking the record of maximum spurious emission.
7. A horn antenna was substituted in place of the EUT and was driven by a signal generator.
8. Tune the output power of signal generator to the same emission level with EUT maximum spurious emission.
9. Taking the record of output power at antenna port.
10. Repeat step 7 to step 8 for another polarization.
11. The RF fundamental frequency should be excluded against the limit line in the operating frequency band.
The limit line is derived from $43 + 10\log(P)$ dB below the transmitter power P(Watts)
12. For Band 7, 38, 41:
The limit line is derived from $55 + 10\log(P)$ dB below the transmitter power P(Watts)
 $EIRP \text{ (dBm)} = S.G. \text{ Power} - Tx \text{ Cable Loss} + Tx \text{ Antenna Gain}$
 $ERP \text{ (dBm)} = EIRP - 2.15$



5 List of Measuring Equipment

| Instrument | Manufacturer | Model No. | Serial No. | Characteristics | Calibration Date | Test Date | Due Date | Remark |
|---------------------------|-----------------|---|----------------|--------------------------------|------------------|-------------------------------|---------------|-----------------------|
| LTE Base Station | Anritsu | MT8820C | 6201432821 | GSM/GPRS /WCDMA/LTE | Oct. 11, 2016 | Aug. 02, 2017 ~ Aug. 03, 2017 | Oct. 10, 2017 | Conducted (TH05-HY) |
| Spectrum Analyzer | Rohde & Schwarz | FSV40 | 101397 | 10Hz~40GHz | Nov. 04, 2016 | Aug. 02, 2017 ~ Aug. 03, 2017 | Nov. 03, 2017 | Conducted (TH05-HY) |
| Temperature Chamber | ESPEC | SH-641 | 92013720 | -30°C~70°C | Sep. 01, 2016 | Aug. 02, 2017 ~ Aug. 03, 2017 | Aug. 31, 2017 | Conducted (TH05-HY) |
| Programmable Power Supply | GW Instek | PSS-2005 | EL890001 | 1V~20V 0.5A~5A | Oct. 03, 2016 | Aug. 02, 2017 ~ Aug. 03, 2017 | Oct. 02, 2017 | Conducted (TH05-HY) |
| Coupler | Warison | 1-18GHz 20dB 25WSMA Directional Coupler | #B | 1G~18GHz | Feb. 20, 2017 | Aug. 02, 2017 ~ Aug. 03, 2017 | Feb. 19, 2018 | Conducted (TH05-HY) |
| Amplifier | MITEQ | TTA1840-35-HG | 1871923 | 18GHz~40GHz, VS WR : 2.5:1 max | Jul. 18, 2017 | Aug. 04, 2017 ~ Aug. 05, 2017 | Jul. 17, 2018 | Radiation (03CH11-HY) |
| Amplifier | SONOMA | 310N | 187312 | 9kHz~1GHz | Nov. 10, 2016 | Aug. 04, 2017 ~ Aug. 05, 2017 | Nov. 09, 2017 | Radiation (03CH11-HY) |
| Bilog Antenna | TESEQ | CBL 6111D&N-6-06 | 35414&AT-N0602 | 30MHz~1GHz | Oct. 15, 2016 | Aug. 04, 2017 ~ Aug. 05, 2017 | Oct. 14, 2017 | Radiation (03CH11-HY) |
| Horn Antenna | SCHWARZBECK | BBHA 9120 D | 9120D-1326 | 1GHz ~ 18GHz | Oct. 07, 2016 | Aug. 04, 2017 ~ Aug. 05, 2017 | Oct. 06, 2017 | Radiation (03CH11-HY) |
| Preamplifier | Keysight | 83017A | MY53270080 | 1GHz~26.5GHz | Nov. 10, 2016 | Aug. 04, 2017 ~ Aug. 05, 2017 | Nov. 09, 2017 | Radiation (03CH11-HY) |
| Preamplifier | MITEQ | AMF-7D-0010 1800-30-10P | 1902247 | 1GHz~18GHz | Jun. 23, 2017 | Aug. 04, 2017 ~ Aug. 05, 2017 | Jun. 22, 2018 | Radiation (03CH11-HY) |
| Spectrum Analyzer | Keysight | N9010A | MY54200486 | 10Hz ~ 44GHz | Oct. 12, 2016 | Aug. 04, 2017 ~ Aug. 05, 2017 | Oct. 11, 2017 | Radiation (03CH11-HY) |
| Antenna Mast | EMEC | AM-BS-4500-B | N/A | 1~4m | N/A | Aug. 04, 2017 ~ Aug. 05, 2017 | N/A | Radiation (03CH11-HY) |
| Turn Table | EMEC | TT 2000 | N/A | 0~360 Degree | N/A | Aug. 04, 2017 ~ Aug. 05, 2017 | N/A | Radiation (03CH11-HY) |
| SHF-EHF Horn Antenna | SCHWARZBECK | BBHA 9170 | BBHA9170584 | 18GHz- 40GHz | Nov. 08, 2016 | Aug. 04, 2017 ~ Aug. 05, 2017 | Nov. 07, 2017 | Radiation (03CH11-HY) |



6 Uncertainty of Evaluation

Uncertainty of Radiated Emission Measurement (30 MHz ~ 1000 MHz)

| | |
|---|------|
| Measuring Uncertainty for a Level of Confidence of 95% ($U = 2Uc(y)$) | 3.37 |
|---|------|

Uncertainty of Radiated Emission Measurement (1 GHz ~ 18 GHz)

| | |
|---|------|
| Measuring Uncertainty for a Level of Confidence of 95% ($U = 2Uc(y)$) | 3.67 |
|---|------|

Uncertainty of Radiated Emission Measurement (18 GHz ~ 40 GHz)

| | |
|---|------|
| Measuring Uncertainty for a Level of Confidence of 95% ($U = 2Uc(y)$) | 4.03 |
|---|------|



Appendix A. Test Results of Conducted Test

Conducted Output Power(Average power)

| LTE Band 2 Maximum Average Power [dBm] | | | | | | |
|--|---------|-----------|--------|--------------|--------|---------|
| BW [MHz] | RB Size | RB Offset | Mod | Lowest | Middle | Highest |
| 20 | 1 | 0 | QPSK | 22.62 | 22.61 | 22.49 |
| 20 | 1 | 49 | | 22.27 | 22.33 | 22.24 |
| 20 | 1 | 99 | | 22.43 | 22.50 | 22.47 |
| 20 | 50 | 0 | | 21.41 | 21.37 | 21.31 |
| 20 | 50 | 24 | | 21.31 | 21.30 | 21.25 |
| 20 | 50 | 50 | | 21.31 | 21.33 | 21.25 |
| 20 | 100 | 0 | | 21.38 | 21.29 | 21.31 |
| 20 | 1 | 0 | 16-QAM | 21.82 | 21.77 | 21.77 |
| 20 | 1 | 49 | | 21.52 | 21.50 | 21.51 |
| 20 | 1 | 99 | | 21.71 | 21.66 | 21.74 |
| 20 | 50 | 0 | | 20.44 | 20.33 | 20.37 |
| 20 | 50 | 24 | | 20.34 | 20.27 | 20.31 |
| 20 | 50 | 50 | | 20.36 | 20.34 | 20.32 |
| 20 | 100 | 0 | | 20.40 | 20.35 | 20.38 |
| 15 | 1 | 0 | QPSK | 22.43 | 22.43 | 22.41 |
| 15 | 1 | 37 | | 22.24 | 22.27 | 22.29 |
| 15 | 1 | 74 | | 22.29 | 22.32 | 22.41 |
| 15 | 36 | 0 | | 21.31 | 21.29 | 21.34 |
| 15 | 36 | 20 | | 21.24 | 21.24 | 21.29 |
| 15 | 36 | 39 | | 21.23 | 21.26 | 21.29 |
| 15 | 75 | 0 | | 21.26 | 21.26 | 21.30 |
| 15 | 1 | 0 | 16-QAM | 21.66 | 21.74 | 21.70 |
| 15 | 1 | 37 | | 21.49 | 21.56 | 21.59 |
| 15 | 1 | 74 | | 21.55 | 21.63 | 21.66 |
| 15 | 36 | 0 | | 20.33 | 20.36 | 20.39 |
| 15 | 36 | 20 | | 20.26 | 20.31 | 20.34 |
| 15 | 36 | 39 | | 20.26 | 20.33 | 20.33 |
| 15 | 75 | 0 | | 20.30 | 20.34 | 20.36 |



| LTE Band 2 Maximum Average Power [dBm] | | | | | | |
|--|---------|-----------|--------|--------|--------|---------|
| BW [MHz] | RB Size | RB Offset | Mod | Lowest | Middle | Highest |
| 10 | 1 | 0 | QPSK | 22.34 | 22.35 | 22.36 |
| 10 | 1 | 25 | | 22.25 | 22.27 | 22.30 |
| 10 | 1 | 49 | | 22.24 | 22.28 | 22.35 |
| 10 | 25 | 0 | | 21.26 | 21.23 | 21.34 |
| 10 | 25 | 12 | | 21.23 | 21.23 | 21.29 |
| 10 | 25 | 25 | | 21.22 | 21.23 | 21.26 |
| 10 | 50 | 0 | | 21.26 | 21.25 | 21.31 |
| 10 | 1 | 0 | 16-QAM | 21.53 | 21.63 | 21.61 |
| 10 | 1 | 25 | | 21.44 | 21.53 | 21.56 |
| 10 | 1 | 49 | | 21.45 | 21.56 | 21.60 |
| 10 | 25 | 0 | | 20.30 | 20.32 | 20.41 |
| 10 | 25 | 12 | | 20.27 | 20.32 | 20.36 |
| 10 | 25 | 25 | | 20.28 | 20.33 | 20.33 |
| 10 | 50 | 0 | | 20.29 | 20.33 | 20.36 |
| 5 | 1 | 0 | QPSK | 22.20 | 21.48 | 21.29 |
| 5 | 1 | 12 | | 21.94 | 21.30 | 21.35 |
| 5 | 1 | 24 | | 21.46 | 21.21 | 21.30 |
| 5 | 12 | 0 | | 20.84 | 20.22 | 20.31 |
| 5 | 12 | 7 | | 20.68 | 20.25 | 20.33 |
| 5 | 12 | 13 | | 20.54 | 20.27 | 20.29 |
| 5 | 25 | 0 | | 20.56 | 20.36 | 20.29 |
| 5 | 1 | 0 | 16-QAM | 20.57 | 20.61 | 20.64 |
| 5 | 1 | 12 | | 20.61 | 20.67 | 20.69 |
| 5 | 1 | 24 | | 20.52 | 20.58 | 20.63 |
| 5 | 12 | 0 | | 19.82 | 19.31 | 19.39 |
| 5 | 12 | 7 | | 19.71 | 19.34 | 19.41 |
| 5 | 12 | 13 | | 19.89 | 19.33 | 19.38 |
| 5 | 25 | 0 | | 19.86 | 19.42 | 19.35 |



| LTE Band 2 Maximum Average Power [dBm] | | | | | | |
|--|---------|-----------|--------|--------|--------|---------|
| BW [MHz] | RB Size | RB Offset | Mod | Lowest | Middle | Highest |
| 3 | 1 | 0 | QPSK | 22.24 | 21.39 | 21.35 |
| 3 | 1 | 8 | | 21.72 | 21.24 | 21.29 |
| 3 | 1 | 14 | | 21.58 | 21.27 | 21.36 |
| 3 | 8 | 0 | | 20.55 | 20.41 | 20.39 |
| 3 | 8 | 4 | | 20.60 | 20.31 | 20.37 |
| 3 | 8 | 7 | | 20.44 | 20.32 | 20.36 |
| 3 | 15 | 0 | | 20.55 | 20.30 | 20.38 |
| 3 | 1 | 0 | 16-QAM | 20.60 | 20.67 | 20.71 |
| 3 | 1 | 8 | | 20.54 | 20.62 | 20.66 |
| 3 | 1 | 14 | | 20.61 | 20.66 | 20.70 |
| 3 | 8 | 0 | | 19.77 | 19.44 | 19.49 |
| 3 | 8 | 4 | | 19.77 | 19.45 | 19.48 |
| 3 | 8 | 7 | | 19.74 | 19.43 | 19.46 |
| 3 | 15 | 0 | | 19.79 | 19.46 | 19.45 |
| 1.4 | 1 | 0 | QPSK | 22.06 | 22.09 | 21.88 |
| 1.4 | 1 | 3 | | 22.03 | 22.07 | 21.47 |
| 1.4 | 1 | 5 | | 22.07 | 22.10 | 21.28 |
| 1.4 | 3 | 0 | | 22.17 | 22.18 | 21.36 |
| 1.4 | 3 | 1 | | 22.17 | 22.18 | 21.32 |
| 1.4 | 3 | 3 | | 22.21 | 22.23 | 21.29 |
| 1.4 | 6 | 0 | | 21.17 | 21.18 | 20.29 |
| 1.4 | 1 | 0 | 16-QAM | 21.36 | 21.48 | 20.59 |
| 1.4 | 1 | 3 | | 21.30 | 21.40 | 20.53 |
| 1.4 | 1 | 5 | | 21.35 | 21.47 | 20.58 |
| 1.4 | 3 | 0 | | 21.27 | 21.37 | 20.47 |
| 1.4 | 3 | 1 | | 21.30 | 21.37 | 20.48 |
| 1.4 | 3 | 3 | | 21.26 | 21.34 | 20.44 |
| 1.4 | 6 | 0 | | 20.27 | 20.33 | 19.41 |



| LTE Band 4 Maximum Average Power [dBm] | | | | | | |
|--|---------|-----------|--------|--------|--------|---------|
| BW [MHz] | RB Size | RB Offset | Mod | Lowest | Middle | Highest |
| 20 | 1 | 0 | QPSK | 22.85 | 22.93 | 22.92 |
| 20 | 1 | 49 | | 22.58 | 22.61 | 22.63 |
| 20 | 1 | 99 | | 22.75 | 22.74 | 22.73 |
| 20 | 50 | 0 | | 21.60 | 21.71 | 21.64 |
| 20 | 50 | 24 | | 21.58 | 21.61 | 21.62 |
| 20 | 50 | 50 | | 21.64 | 21.69 | 21.70 |
| 20 | 100 | 0 | | 21.63 | 21.70 | 21.68 |
| 20 | 1 | 0 | 16-QAM | 21.98 | 21.96 | 21.99 |
| 20 | 1 | 49 | | 21.83 | 21.88 | 21.89 |
| 20 | 1 | 99 | | 21.99 | 21.99 | 21.94 |
| 20 | 50 | 0 | | 20.63 | 20.72 | 20.68 |
| 20 | 50 | 24 | | 20.62 | 20.66 | 20.65 |
| 20 | 50 | 50 | | 20.67 | 20.72 | 20.72 |
| 20 | 100 | 0 | | 20.67 | 20.74 | 20.71 |
| 15 | 1 | 0 | QPSK | 22.76 | 22.79 | 22.79 |
| 15 | 1 | 37 | | 22.59 | 22.63 | 22.64 |
| 15 | 1 | 74 | | 22.67 | 22.68 | 22.65 |
| 15 | 36 | 0 | | 21.59 | 21.68 | 21.65 |
| 15 | 36 | 20 | | 21.58 | 21.63 | 21.63 |
| 15 | 36 | 39 | | 21.62 | 21.64 | 21.62 |
| 15 | 75 | 0 | | 21.60 | 21.66 | 21.64 |
| 15 | 1 | 0 | 16-QAM | 21.97 | 21.95 | 22.00 |
| 15 | 1 | 37 | | 21.86 | 21.91 | 21.89 |
| 15 | 1 | 74 | | 21.93 | 21.95 | 21.89 |
| 15 | 36 | 0 | | 20.63 | 20.71 | 20.68 |
| 15 | 36 | 20 | | 20.62 | 20.66 | 20.66 |
| 15 | 36 | 39 | | 20.65 | 20.67 | 20.64 |
| 15 | 75 | 0 | | 20.64 | 20.70 | 20.68 |



| LTE Band 4 Maximum Average Power [dBm] | | | | | | |
|--|---------|-----------|--------|--------|--------|---------|
| BW [MHz] | RB Size | RB Offset | Mod | Lowest | Middle | Highest |
| 10 | 1 | 0 | QPSK | 22.66 | 22.71 | 22.74 |
| 10 | 1 | 25 | | 22.58 | 22.61 | 22.60 |
| 10 | 1 | 49 | | 22.62 | 22.59 | 22.59 |
| 10 | 25 | 0 | | 21.53 | 21.44 | 21.57 |
| 10 | 25 | 12 | | 21.56 | 21.59 | 21.58 |
| 10 | 25 | 25 | | 21.59 | 21.38 | 21.54 |
| 10 | 50 | 0 | | 21.58 | 21.53 | 21.59 |
| 10 | 1 | 0 | 16-QAM | 21.88 | 21.77 | 21.91 |
| 10 | 1 | 25 | | 21.77 | 21.59 | 21.68 |
| 10 | 1 | 49 | | 21.83 | 21.62 | 21.68 |
| 10 | 25 | 0 | | 20.55 | 20.48 | 20.65 |
| 10 | 25 | 12 | | 20.60 | 20.55 | 20.63 |
| 10 | 25 | 25 | | 20.62 | 20.59 | 20.61 |
| 10 | 50 | 0 | | 20.60 | 20.63 | 20.63 |
| 5 | 1 | 0 | QPSK | 21.58 | 21.63 | 21.58 |
| 5 | 1 | 12 | | 21.62 | 21.66 | 21.61 |
| 5 | 1 | 24 | | 21.55 | 21.59 | 21.56 |
| 5 | 12 | 0 | | 20.51 | 20.57 | 20.53 |
| 5 | 12 | 7 | | 20.60 | 20.63 | 20.59 |
| 5 | 12 | 13 | | 20.61 | 20.64 | 20.60 |
| 5 | 25 | 0 | | 20.56 | 20.61 | 20.58 |
| 5 | 1 | 0 | 16-QAM | 20.88 | 20.95 | 20.89 |
| 5 | 1 | 12 | | 20.93 | 21.00 | 20.93 |
| 5 | 1 | 24 | | 20.85 | 20.91 | 20.84 |
| 5 | 12 | 0 | | 19.54 | 19.62 | 19.58 |
| 5 | 12 | 7 | | 19.64 | 19.68 | 19.64 |
| 5 | 12 | 13 | | 19.65 | 19.69 | 19.65 |
| 5 | 25 | 0 | | 19.58 | 19.64 | 19.61 |



| LTE Band 4 Maximum Average Power [dBm] | | | | | | |
|--|---------|-----------|--------|--------|--------|---------|
| BW [MHz] | RB Size | RB Offset | Mod | Lowest | Middle | Highest |
| 3 | 1 | 0 | QPSK | 21.64 | 21.67 | 21.63 |
| 3 | 1 | 8 | | 21.57 | 21.59 | 21.56 |
| 3 | 1 | 14 | | 21.62 | 21.63 | 21.62 |
| 3 | 8 | 0 | | 20.65 | 20.68 | 20.65 |
| 3 | 8 | 4 | | 20.65 | 20.67 | 20.64 |
| 3 | 8 | 7 | | 20.64 | 20.66 | 20.66 |
| 3 | 15 | 0 | | 20.65 | 20.67 | 20.66 |
| 3 | 1 | 0 | 16-QAM | 20.95 | 21.01 | 20.94 |
| 3 | 1 | 8 | | 20.90 | 20.94 | 20.89 |
| 3 | 1 | 14 | | 20.94 | 20.99 | 20.93 |
| 3 | 8 | 0 | | 19.71 | 19.75 | 19.71 |
| 3 | 8 | 4 | | 19.71 | 19.74 | 19.71 |
| 3 | 8 | 7 | | 19.70 | 19.73 | 19.70 |
| 3 | 15 | 0 | | 19.68 | 19.72 | 19.74 |
| 1.4 | 1 | 0 | QPSK | 21.42 | 21.47 | 21.43 |
| 1.4 | 1 | 3 | | 21.40 | 21.44 | 21.40 |
| 1.4 | 1 | 5 | | 21.44 | 21.48 | 21.45 |
| 1.4 | 3 | 0 | | 21.52 | 21.56 | 21.52 |
| 1.4 | 3 | 1 | | 21.52 | 21.56 | 21.52 |
| 1.4 | 3 | 3 | | 21.56 | 21.60 | 21.57 |
| 1.4 | 6 | 0 | | 20.55 | 20.59 | 20.56 |
| 1.4 | 1 | 0 | 16-QAM | 20.80 | 20.87 | 20.81 |
| 1.4 | 1 | 3 | | 20.76 | 20.81 | 20.74 |
| 1.4 | 1 | 5 | | 20.78 | 20.85 | 20.78 |
| 1.4 | 3 | 0 | | 20.70 | 20.76 | 20.70 |
| 1.4 | 3 | 1 | | 20.74 | 20.79 | 20.74 |
| 1.4 | 3 | 3 | | 20.69 | 20.75 | 20.70 |
| 1.4 | 6 | 0 | | 19.64 | 19.68 | 19.69 |



| LTE Band 5 Maximum Average Power [dBm] | | | | | | |
|--|---------|-----------|--------|--------|--------|---------|
| BW [MHz] | RB Size | RB Offset | Mod | Lowest | Middle | Highest |
| 10 | 1 | 0 | QPSK | 23.25 | 23.33 | 23.19 |
| 10 | 1 | 25 | | 22.83 | 23.14 | 23.19 |
| 10 | 1 | 49 | | 22.94 | 23.23 | 23.30 |
| 10 | 25 | 0 | | 22.25 | 22.26 | 22.14 |
| 10 | 25 | 12 | | 21.97 | 22.21 | 22.14 |
| 10 | 25 | 25 | | 21.89 | 22.18 | 22.16 |
| 10 | 50 | 0 | | 22.10 | 22.26 | 22.22 |
| 10 | 1 | 0 | 16-QAM | 22.41 | 22.31 | 22.36 |
| 10 | 1 | 25 | | 22.24 | 22.43 | 22.39 |
| 10 | 1 | 49 | | 22.17 | 22.46 | 22.34 |
| 10 | 25 | 0 | | 21.31 | 21.32 | 21.21 |
| 10 | 25 | 12 | | 21.08 | 21.20 | 21.26 |
| 10 | 25 | 25 | | 20.98 | 21.24 | 21.24 |
| 10 | 50 | 0 | | 21.10 | 21.21 | 21.21 |
| 5 | 1 | 0 | QPSK | 22.33 | 22.19 | 22.46 |
| 5 | 1 | 12 | | 22.44 | 22.22 | 22.40 |
| 5 | 1 | 24 | | 22.00 | 22.17 | 22.33 |
| 5 | 12 | 0 | | 21.36 | 21.22 | 21.35 |
| 5 | 12 | 7 | | 21.36 | 21.32 | 21.33 |
| 5 | 12 | 13 | | 21.18 | 21.33 | 21.37 |
| 5 | 25 | 0 | | 21.33 | 21.38 | 21.37 |
| 5 | 1 | 0 | 16-QAM | 21.69 | 21.62 | 21.64 |
| 5 | 1 | 12 | | 21.74 | 21.70 | 21.65 |
| 5 | 1 | 24 | | 21.38 | 21.62 | 21.49 |
| 5 | 12 | 0 | | 20.43 | 20.36 | 20.35 |
| 5 | 12 | 7 | | 20.39 | 20.65 | 20.60 |
| 5 | 12 | 13 | | 20.32 | 20.50 | 20.35 |
| 5 | 25 | 0 | | 20.30 | 20.57 | 20.57 |



| LTE Band 5 Maximum Average Power [dBm] | | | | | | |
|--|---------|-----------|--------|--------|--------|---------|
| BW [MHz] | RB Size | RB Offset | Mod | Lowest | Middle | Highest |
| 3 | 1 | 0 | QPSK | 22.43 | 22.23 | 22.59 |
| 3 | 1 | 8 | | 22.32 | 22.17 | 22.34 |
| 3 | 1 | 14 | | 22.40 | 22.23 | 22.38 |
| 3 | 8 | 0 | | 21.41 | 21.26 | 21.51 |
| 3 | 8 | 4 | | 21.46 | 21.25 | 21.47 |
| 3 | 8 | 7 | | 21.45 | 21.24 | 21.45 |
| 3 | 15 | 0 | | 21.45 | 21.25 | 21.43 |
| 3 | 1 | 0 | 16-QAM | 21.71 | 21.61 | 21.68 |
| 3 | 1 | 8 | | 21.74 | 21.65 | 21.63 |
| 3 | 1 | 14 | | 21.75 | 21.53 | 21.61 |
| 3 | 8 | 0 | | 20.57 | 20.53 | 20.57 |
| 3 | 8 | 4 | | 20.54 | 20.63 | 20.58 |
| 3 | 8 | 7 | | 20.49 | 20.61 | 20.55 |
| 3 | 15 | 0 | | 20.51 | 20.51 | 20.80 |
| 1.4 | 1 | 0 | QPSK | 22.25 | 22.14 | 22.52 |
| 1.4 | 1 | 3 | | 22.25 | 22.18 | 22.46 |
| 1.4 | 1 | 5 | | 22.32 | 22.19 | 22.50 |
| 1.4 | 3 | 0 | | 22.29 | 22.24 | 22.43 |
| 1.4 | 3 | 1 | | 22.39 | 22.23 | 22.46 |
| 1.4 | 3 | 3 | | 22.35 | 22.18 | 22.53 |
| 1.4 | 6 | 0 | | 21.41 | 21.29 | 21.80 |
| 1.4 | 1 | 0 | 16-QAM | 21.63 | 21.62 | 21.80 |
| 1.4 | 1 | 3 | | 21.59 | 21.57 | 21.85 |
| 1.4 | 1 | 5 | | 21.70 | 21.69 | 21.72 |
| 1.4 | 3 | 0 | | 21.56 | 21.73 | 21.82 |
| 1.4 | 3 | 1 | | 21.57 | 21.61 | 21.75 |
| 1.4 | 3 | 3 | | 21.49 | 21.75 | 21.75 |
| 1.4 | 6 | 0 | | 20.48 | 20.92 | 20.98 |



| LTE Band 7 Maximum Average Power [dBm] | | | | | | |
|--|---------|-----------|--------|--------|--------|---------|
| BW [MHz] | RB Size | RB Offset | Mod | Lowest | Middle | Highest |
| 20 | 1 | 0 | QPSK | 22.40 | 22.27 | 22.10 |
| 20 | 1 | 49 | | 22.38 | 21.93 | 21.30 |
| 20 | 1 | 99 | | 22.25 | 22.20 | 21.61 |
| 20 | 50 | 0 | | 21.98 | 21.08 | 20.60 |
| 20 | 50 | 24 | | 21.33 | 20.95 | 20.36 |
| 20 | 50 | 50 | | 21.02 | 20.85 | 20.38 |
| 20 | 100 | 0 | | 20.98 | 20.97 | 20.50 |
| 20 | 1 | 0 | 16-QAM | 21.31 | 21.43 | 21.33 |
| 20 | 1 | 49 | | 21.11 | 21.17 | 20.62 |
| 20 | 1 | 99 | | 21.45 | 21.49 | 20.85 |
| 20 | 50 | 0 | | 20.01 | 20.08 | 19.63 |
| 20 | 50 | 24 | | 19.91 | 19.95 | 19.38 |
| 20 | 50 | 50 | | 20.01 | 19.88 | 19.41 |
| 20 | 100 | 0 | | 20.02 | 20.00 | 19.54 |
| 15 | 1 | 0 | QPSK | 22.03 | 22.14 | 21.42 |
| 15 | 1 | 37 | | 21.91 | 21.98 | 21.47 |
| 15 | 1 | 74 | | 22.11 | 22.11 | 21.51 |
| 15 | 36 | 0 | | 20.98 | 21.04 | 20.41 |
| 15 | 36 | 20 | | 20.91 | 20.94 | 20.44 |
| 15 | 36 | 39 | | 20.97 | 20.92 | 20.42 |
| 15 | 75 | 0 | | 20.97 | 20.97 | 20.41 |
| 15 | 1 | 0 | 16-QAM | 21.30 | 21.39 | 20.70 |
| 15 | 1 | 37 | | 21.20 | 21.22 | 20.78 |
| 15 | 1 | 74 | | 21.38 | 21.36 | 20.79 |
| 15 | 36 | 0 | | 19.97 | 20.04 | 19.42 |
| 15 | 36 | 20 | | 19.94 | 19.96 | 19.46 |
| 15 | 36 | 39 | | 19.98 | 19.93 | 19.43 |
| 15 | 75 | 0 | | 19.99 | 19.99 | 19.43 |



| LTE Band 7 Maximum Average Power [dBm] | | | | | | |
|--|---------|-----------|--------|--------|--------|---------|
| BW [MHz] | RB Size | RB Offset | Mod | Lowest | Middle | Highest |
| 10 | 1 | 0 | QPSK | 21.95 | 22.05 | 21.46 |
| 10 | 1 | 25 | | 21.94 | 21.98 | 21.44 |
| 10 | 1 | 49 | | 22.01 | 22.04 | 21.44 |
| 10 | 25 | 0 | | 20.96 | 21.01 | 20.50 |
| 10 | 25 | 12 | | 20.93 | 20.94 | 20.47 |
| 10 | 25 | 25 | | 20.92 | 20.88 | 20.33 |
| 10 | 50 | 0 | | 20.96 | 20.95 | 20.43 |
| 10 | 1 | 0 | 16-QAM | 21.21 | 21.29 | 20.74 |
| 10 | 1 | 25 | | 21.16 | 21.22 | 20.74 |
| 10 | 1 | 49 | | 21.26 | 21.29 | 20.69 |
| 10 | 25 | 0 | | 19.98 | 20.03 | 19.53 |
| 10 | 25 | 12 | | 19.95 | 19.97 | 19.50 |
| 10 | 25 | 25 | | 19.96 | 19.91 | 19.35 |
| 10 | 50 | 0 | | 19.95 | 19.96 | 19.43 |
| 5 | 1 | 0 | QPSK | 21.90 | 21.99 | 21.41 |
| 5 | 1 | 12 | | 21.97 | 22.03 | 21.45 |
| 5 | 1 | 24 | | 21.94 | 21.98 | 21.36 |
| 5 | 12 | 0 | | 20.90 | 20.93 | 20.43 |
| 5 | 12 | 7 | | 20.94 | 20.95 | 20.42 |
| 5 | 12 | 13 | | 20.92 | 20.89 | 20.33 |
| 5 | 25 | 0 | | 20.91 | 20.90 | 20.38 |
| 5 | 1 | 0 | 16-QAM | 21.19 | 21.24 | 20.71 |
| 5 | 1 | 12 | | 21.25 | 21.28 | 20.75 |
| 5 | 1 | 24 | | 21.21 | 21.23 | 20.64 |
| 5 | 12 | 0 | | 19.92 | 19.94 | 19.46 |
| 5 | 12 | 7 | | 19.96 | 19.98 | 19.46 |
| 5 | 12 | 13 | | 19.93 | 19.91 | 19.38 |
| 5 | 25 | 0 | | 19.91 | 19.92 | 19.41 |



| LTE Band 38 Maximum Average Power [dBm] | | | | | | |
|---|---------|-----------|--------|--------|--------|---------|
| BW [MHz] | RB Size | RB Offset | Mod | Lowest | Middle | Highest |
| 20 | 1 | 0 | QPSK | 22.98 | 22.96 | 22.94 |
| 20 | 1 | 49 | | 22.65 | 22.64 | 22.63 |
| 20 | 1 | 99 | | 22.97 | 22.95 | 22.91 |
| 20 | 50 | 0 | | 21.76 | 21.76 | 21.74 |
| 20 | 50 | 24 | | 21.65 | 21.64 | 21.62 |
| 20 | 50 | 50 | | 21.71 | 21.62 | 21.62 |
| 20 | 100 | 0 | | 21.72 | 21.71 | 21.70 |
| 20 | 1 | 0 | 16-QAM | 21.57 | 21.53 | 21.49 |
| 20 | 1 | 49 | | 21.30 | 21.29 | 21.28 |
| 20 | 1 | 99 | | 21.63 | 21.60 | 21.63 |
| 20 | 50 | 0 | | 20.69 | 20.71 | 20.70 |
| 20 | 50 | 24 | | 20.64 | 20.60 | 20.59 |
| 20 | 50 | 50 | | 20.68 | 20.59 | 20.60 |
| 20 | 100 | 0 | | 20.71 | 20.68 | 20.69 |
| 15 | 1 | 0 | QPSK | 22.89 | 22.85 | 22.84 |
| 15 | 1 | 37 | | 22.78 | 22.75 | 22.74 |
| 15 | 1 | 74 | | 22.93 | 22.90 | 22.93 |
| 15 | 36 | 0 | | 21.69 | 21.68 | 21.69 |
| 15 | 36 | 20 | | 21.66 | 21.63 | 21.64 |
| 15 | 36 | 39 | | 21.68 | 21.65 | 21.67 |
| 15 | 75 | 0 | | 21.67 | 21.65 | 21.66 |
| 15 | 1 | 0 | 16-QAM | 21.47 | 21.44 | 21.42 |
| 15 | 1 | 37 | | 21.35 | 21.32 | 21.33 |
| 15 | 1 | 74 | | 21.50 | 21.48 | 21.51 |
| 15 | 36 | 0 | | 20.66 | 20.64 | 20.65 |
| 15 | 36 | 20 | | 20.63 | 20.58 | 20.59 |
| 15 | 36 | 39 | | 20.65 | 20.60 | 20.63 |
| 15 | 75 | 0 | | 20.65 | 20.61 | 20.63 |



| LTE Band 38 Maximum Average Power [dBm] | | | | | | |
|---|---------|-----------|--------|--------|--------|---------|
| BW [MHz] | RB Size | RB Offset | Mod | Lowest | Middle | Highest |
| 10 | 1 | 0 | QPSK | 22.72 | 22.69 | 22.67 |
| 10 | 1 | 25 | | 22.67 | 22.64 | 22.66 |
| 10 | 1 | 49 | | 22.75 | 22.71 | 22.77 |
| 10 | 25 | 0 | | 21.60 | 21.63 | 21.64 |
| 10 | 25 | 12 | | 21.61 | 21.59 | 21.60 |
| 10 | 25 | 25 | | 21.61 | 21.58 | 21.59 |
| 10 | 50 | 0 | | 21.62 | 21.61 | 21.62 |
| 10 | 1 | 0 | 16-QAM | 21.33 | 21.30 | 21.30 |
| 10 | 1 | 25 | | 21.29 | 21.26 | 21.29 |
| 10 | 1 | 49 | | 21.37 | 21.33 | 21.39 |
| 10 | 25 | 0 | | 20.64 | 20.62 | 20.65 |
| 10 | 25 | 12 | | 20.64 | 20.58 | 20.60 |
| 10 | 25 | 25 | | 20.62 | 20.57 | 20.59 |
| 10 | 50 | 0 | | 20.59 | 20.56 | 20.58 |
| 5 | 1 | 0 | QPSK | 22.65 | 22.60 | 22.61 |
| 5 | 1 | 12 | | 22.70 | 22.66 | 22.69 |
| 5 | 1 | 24 | | 22.64 | 22.60 | 22.64 |
| 5 | 12 | 0 | | 21.58 | 21.59 | 21.58 |
| 5 | 12 | 7 | | 21.62 | 21.58 | 21.61 |
| 5 | 12 | 13 | | 21.61 | 21.58 | 21.60 |
| 5 | 25 | 0 | | 21.58 | 21.55 | 21.55 |
| 5 | 1 | 0 | 16-QAM | 21.30 | 21.26 | 21.28 |
| 5 | 1 | 12 | | 21.35 | 21.31 | 21.34 |
| 5 | 1 | 24 | | 21.30 | 21.25 | 21.32 |
| 5 | 12 | 0 | | 20.62 | 20.59 | 20.60 |
| 5 | 12 | 7 | | 20.66 | 20.60 | 20.64 |
| 5 | 12 | 13 | | 20.67 | 20.59 | 20.61 |
| 5 | 25 | 0 | | 20.60 | 20.54 | 20.56 |



| LTE Band 41 Maximum Average Power [dBm] | | | | | | |
|---|---------|-----------|--------|--------|--------|---------|
| BW [MHz] | RB Size | RB Offset | Mod | Lowest | Middle | Highest |
| 20 | 1 | 0 | QPSK | 22.88 | 22.93 | 22.94 |
| 20 | 1 | 49 | | 22.74 | 22.62 | 22.85 |
| 20 | 1 | 99 | | 22.87 | 22.73 | 22.93 |
| 20 | 50 | 0 | | 21.79 | 21.73 | 21.91 |
| 20 | 50 | 24 | | 21.73 | 21.63 | 21.81 |
| 20 | 50 | 50 | | 21.79 | 21.62 | 21.82 |
| 20 | 100 | 0 | | 21.80 | 21.69 | 21.88 |
| 20 | 1 | 0 | 16-QAM | 21.63 | 21.49 | 21.75 |
| 20 | 1 | 49 | | 21.39 | 21.28 | 21.49 |
| 20 | 1 | 99 | | 21.71 | 21.59 | 21.81 |
| 20 | 50 | 0 | | 20.77 | 20.69 | 20.89 |
| 20 | 50 | 24 | | 20.72 | 20.60 | 20.78 |
| 20 | 50 | 50 | | 20.76 | 20.61 | 20.79 |
| 20 | 100 | 0 | | 20.79 | 20.67 | 20.86 |
| 15 | 1 | 0 | QPSK | 22.77 | 22.72 | 22.85 |
| 15 | 1 | 37 | | 22.87 | 22.59 | 22.92 |
| 15 | 1 | 74 | | 22.84 | 22.68 | 22.91 |
| 15 | 36 | 0 | | 21.76 | 21.69 | 21.87 |
| 15 | 36 | 20 | | 21.73 | 21.61 | 21.81 |
| 15 | 36 | 39 | | 21.81 | 21.58 | 21.84 |
| 15 | 75 | 0 | | 21.77 | 21.70 | 21.84 |
| 15 | 1 | 0 | 16-QAM | 21.54 | 21.47 | 21.65 |
| 15 | 1 | 37 | | 21.43 | 21.25 | 21.53 |
| 15 | 1 | 74 | | 21.62 | 21.35 | 21.69 |
| 15 | 36 | 0 | | 20.73 | 20.66 | 20.84 |
| 15 | 36 | 20 | | 20.72 | 20.58 | 20.79 |
| 15 | 36 | 39 | | 20.75 | 20.57 | 20.79 |
| 15 | 75 | 0 | | 20.74 | 20.68 | 20.82 |



| LTE Band 41 Maximum Average Power [dBm] | | | | | | |
|---|---------|-----------|--------|--------|--------|---------|
| BW [MHz] | RB Size | RB Offset | Mod | Lowest | Middle | Highest |
| 10 | 1 | 0 | QPSK | 22.82 | 22.86 | 22.90 |
| 10 | 1 | 25 | | 22.77 | 22.52 | 22.86 |
| 10 | 1 | 49 | | 22.86 | 22.54 | 22.93 |
| 10 | 25 | 0 | | 21.72 | 21.63 | 21.84 |
| 10 | 25 | 12 | | 21.72 | 21.56 | 21.82 |
| 10 | 25 | 25 | | 21.74 | 21.51 | 21.78 |
| 10 | 50 | 0 | | 21.71 | 21.65 | 21.82 |
| 10 | 1 | 0 | 16-QAM | 21.44 | 21.40 | 21.54 |
| 10 | 1 | 25 | | 21.39 | 21.21 | 21.50 |
| 10 | 1 | 49 | | 21.47 | 21.20 | 21.59 |
| 10 | 25 | 0 | | 20.73 | 20.63 | 20.86 |
| 10 | 25 | 12 | | 20.73 | 20.58 | 20.83 |
| 10 | 25 | 25 | | 20.74 | 20.54 | 20.78 |
| 10 | 50 | 0 | | 20.69 | 20.62 | 20.78 |
| 5 | 1 | 0 | QPSK | 22.75 | 22.51 | 22.84 |
| 5 | 1 | 12 | | 22.81 | 22.57 | 22.92 |
| 5 | 1 | 24 | | 22.76 | 22.54 | 22.85 |
| 5 | 12 | 0 | | 21.69 | 21.47 | 21.84 |
| 5 | 12 | 7 | | 21.72 | 21.51 | 21.84 |
| 5 | 12 | 13 | | 21.73 | 21.46 | 21.81 |
| 5 | 25 | 0 | | 21.70 | 21.53 | 21.81 |
| 5 | 1 | 0 | 16-QAM | 21.39 | 21.17 | 21.50 |
| 5 | 1 | 12 | | 21.44 | 21.22 | 21.57 |
| 5 | 1 | 24 | | 21.41 | 21.19 | 21.52 |
| 5 | 12 | 0 | | 20.71 | 20.56 | 20.85 |
| 5 | 12 | 7 | | 20.75 | 20.59 | 20.86 |
| 5 | 12 | 13 | | 20.74 | 20.57 | 20.84 |
| 5 | 25 | 0 | | 20.69 | 20.54 | 20.80 |



LTE Band 2

Peak-to-Average Ratio

| Mode | LTE Band 2 / 20MHz | | | | |
|------------|--------------------|---------|-------|---------|-------------|
| Mod. | QPSK | | 16QAM | | Limit: 13dB |
| RB Size | 1RB | Full RB | 1RB | Full RB | Result |
| Lowest CH | 4.32 | 5.33 | 5.74 | 6.26 | PASS |
| Middle CH | 4.93 | 5.62 | 6.09 | 6.41 | |
| Highest CH | 5.25 | 5.42 | 6.23 | 6.35 | |



LTE Band 2 / 20MHz / QPSK

Lowest Channel / 1RB

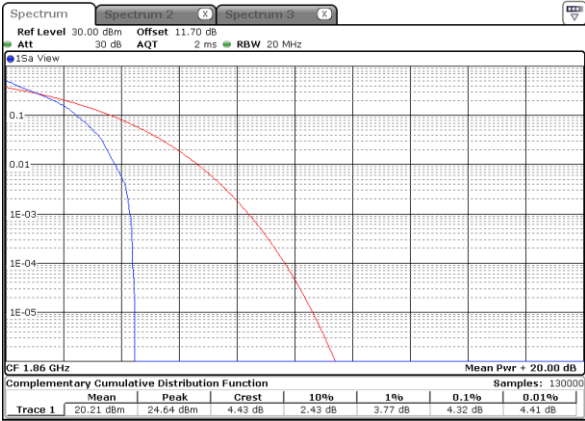

Date: 2 AUG 2017 19:07:17

Lowest Channel / Full RB

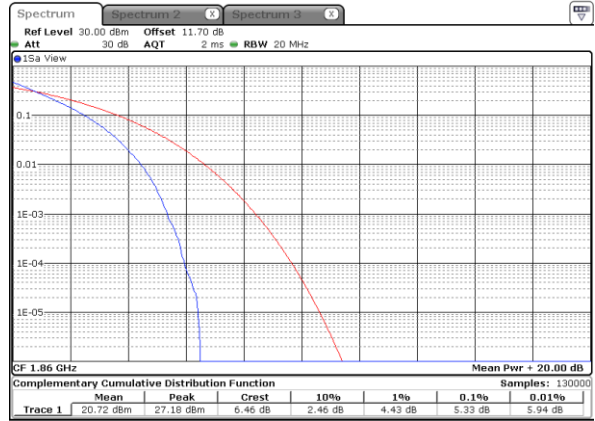

Date: 2 AUG 2017 19:07:25

Middle Channel / 1RB

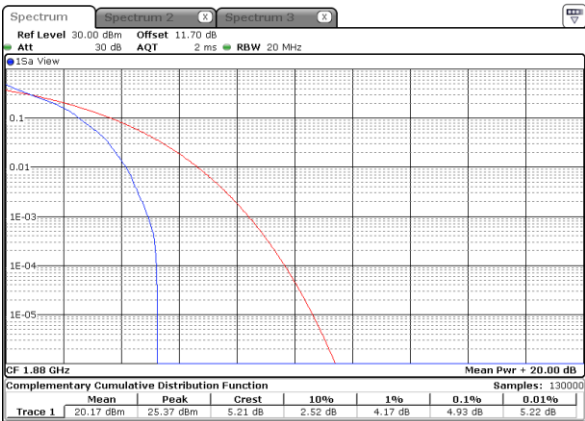

Date: 2 AUG 2017 19:07:34

Middle Channel / Full RB

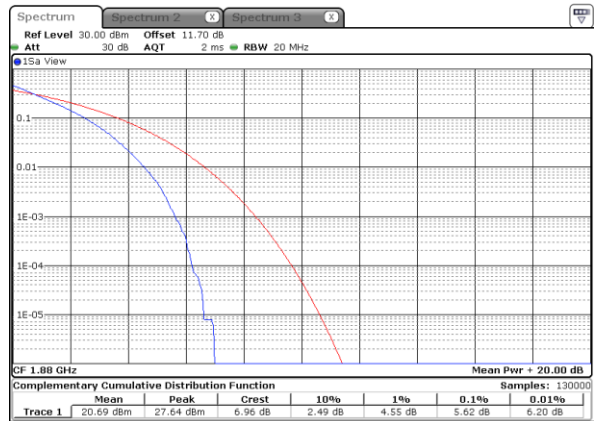

Date: 2 AUG 2017 19:07:43

Highest Channel / 1RB

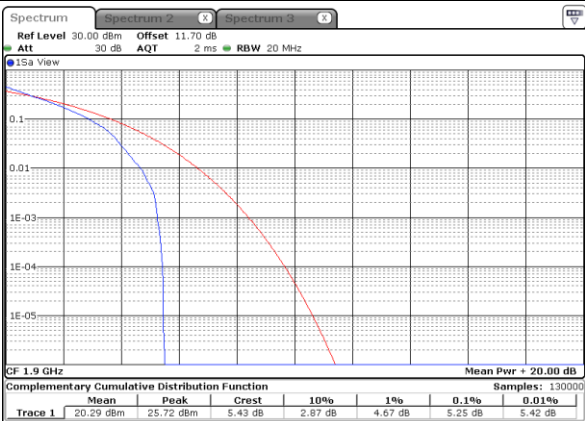

Date: 2 AUG 2017 19:07:52

Highest Channel / Full RB

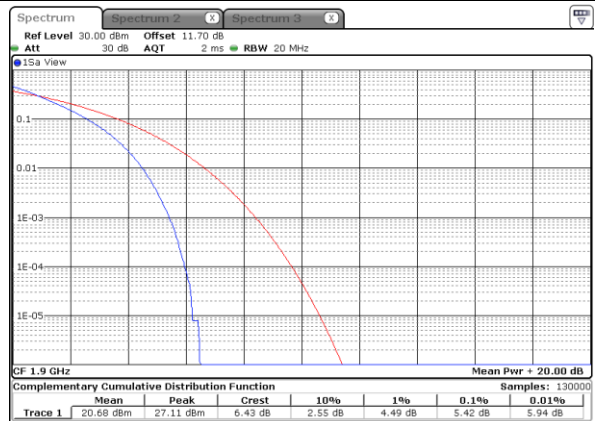

Date: 2 AUG 2017 19:08:00



LTE Band 2 / 20MHz / 16QAM

Lowest Channel / 1RB

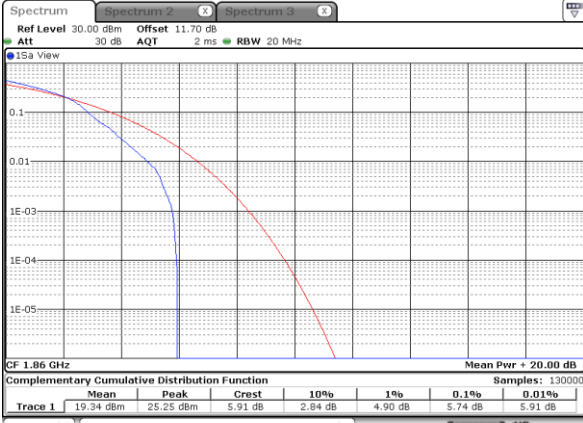

Date: 2 AUG 2017 19:04:29

Lowest Channel / Full RB

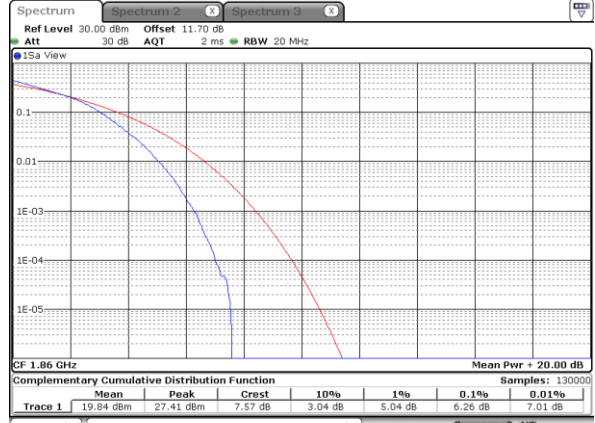

Date: 2 AUG 2017 19:04:39

Middle Channel / 1RB

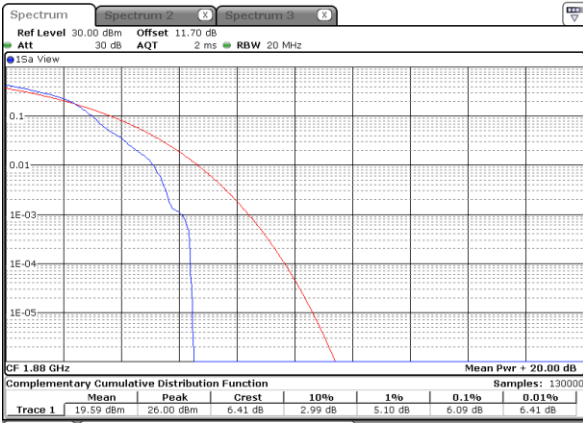

Date: 2 AUG 2017 19:05:06

Middle Channel / Full RB

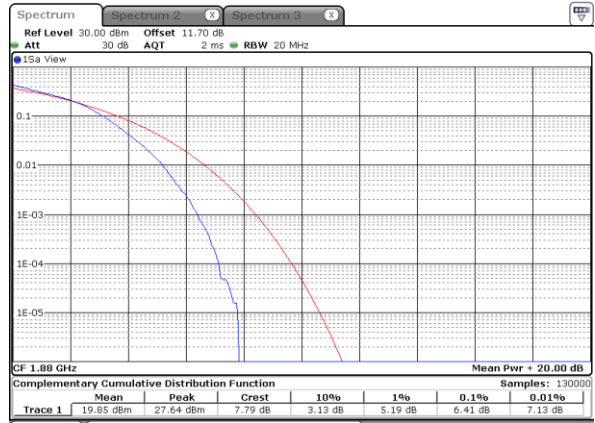

Date: 2 AUG 2017 19:05:30

Highest Channel / 1RB

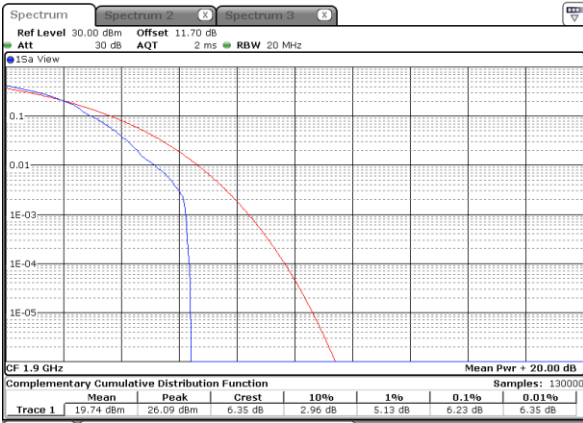

Date: 2 AUG 2017 19:06:57

Highest Channel / Full RB

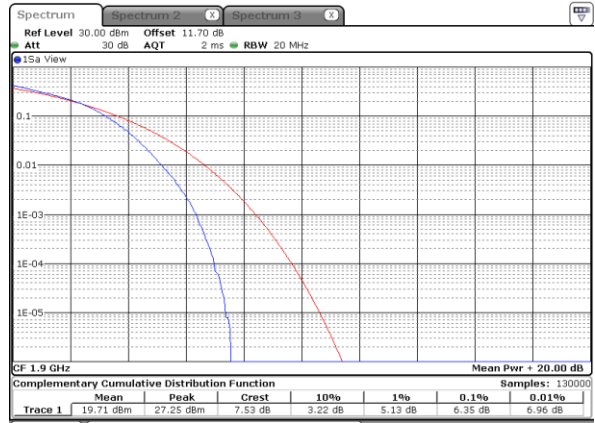

Date: 2 AUG 2017 19:07:08



26dB Bandwidth

| Mode | LTE Band 2 : 26dB BW(MHz) | | | | | | | | | | | |
|------------|---------------------------|-------|------|-------|------|-------|-------|-------|-------|-------|-------|-------|
| | 1.4MHz | | 3MHz | | 5MHz | | 10MHz | | 15MHz | | 20MHz | |
| BW | | | | | | | | | | | | |
| Mod. | QPSK | 16QAM | QPSK | 16QAM | QPSK | 16QAM | QPSK | 16QAM | QPSK | 16QAM | QPSK | 16QAM |
| Lowest CH | 1.25 | 1.25 | 3.02 | 2.99 | 4.93 | 4.96 | 9.69 | 9.81 | 14.48 | 14.90 | 20.14 | 20.26 |
| Middle CH | 1.25 | 1.24 | 2.98 | 3.00 | 5.07 | 4.99 | 10.17 | 9.77 | 14.18 | 14.42 | 20.14 | 20.18 |
| Highest CH | 1.25 | 1.26 | 2.97 | 3.00 | 4.99 | 4.95 | 9.73 | 9.99 | 14.33 | 14.57 | 20.26 | 20.14 |



LTE Band 2

Lowest Channel / 1.4MHz / QPSK

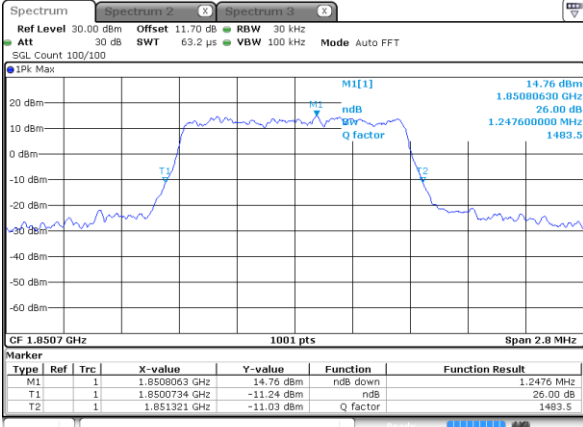

Date: 2 AUG 2017 18:39:55

Lowest Channel / 1.4MHz / 16QAM

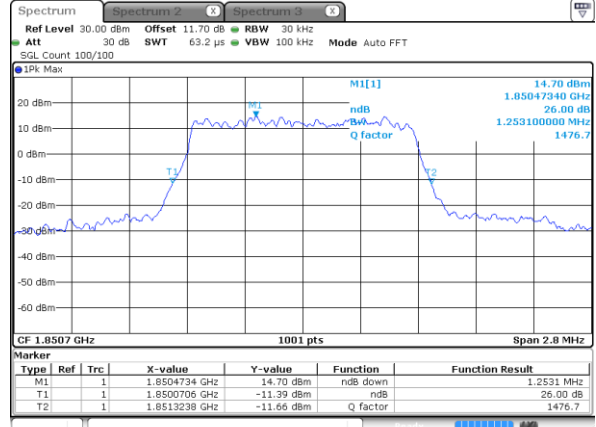

Date: 2 AUG 2017 18:40:05

Middle Channel / 1.4MHz / QPSK

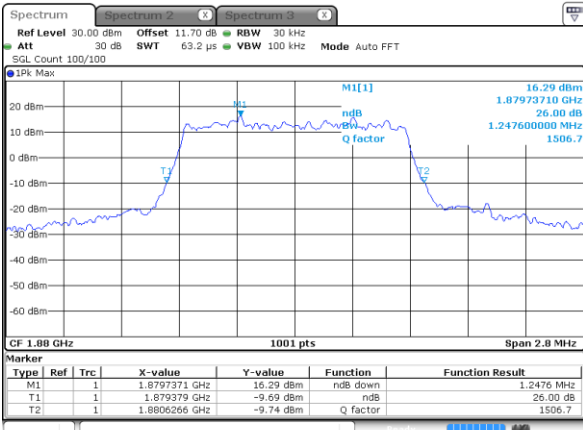

Date: 2 AUG 2017 18:46:58

Middle Channel / 1.4MHz / 16QAM

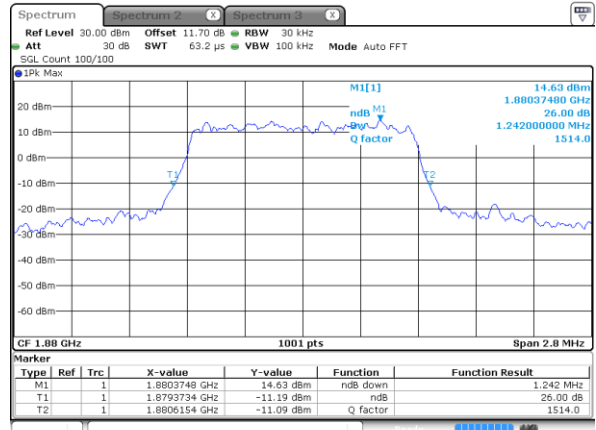

Date: 2 AUG 2017 18:47:08

Highest Channel / 1.4MHz / QPSK

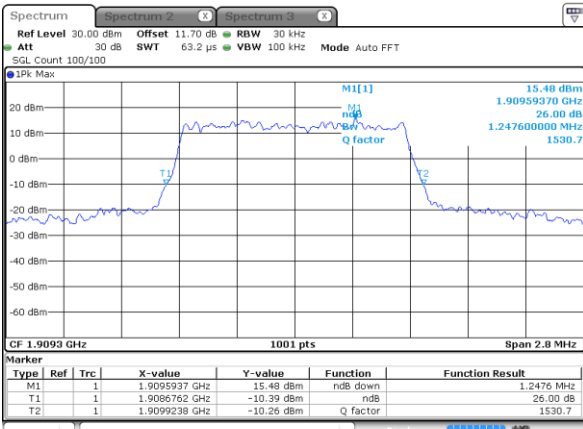

Date: 2 AUG 2017 18:49:27

Highest Channel / 1.4MHz / 16QAM

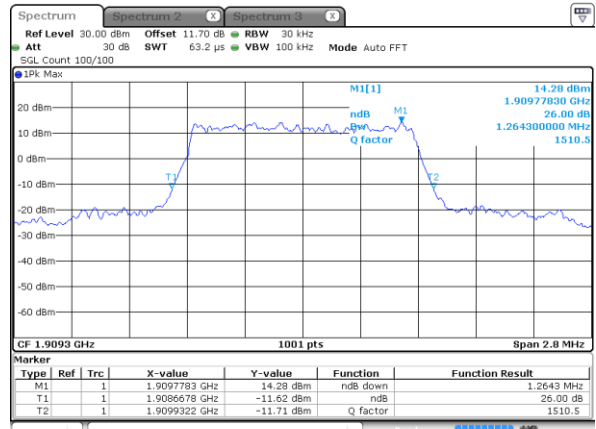

Date: 2 AUG 2017 18:49:37



LTE Band 2

Lowest Channel / 3MHz / QPSK

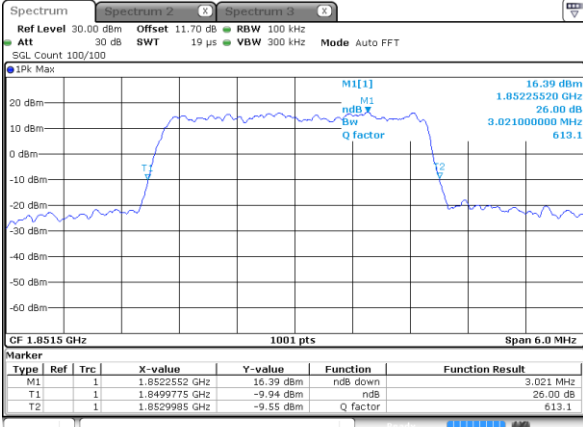

Date: 2 AUG 2017 17:16:27

Lowest Channel / 3MHz / 16QAM

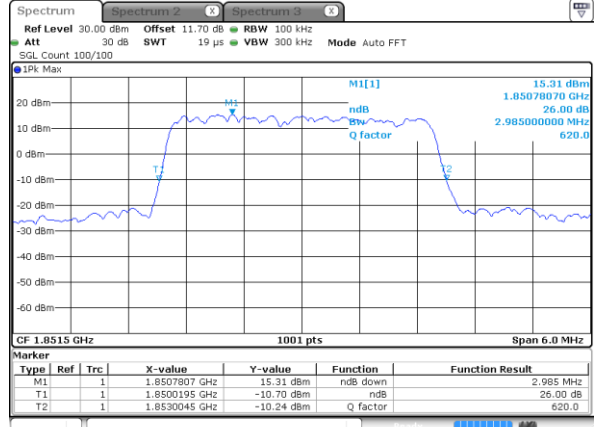

Date: 2 AUG 2017 17:16:37

Middle Channel / 3MHz / QPSK

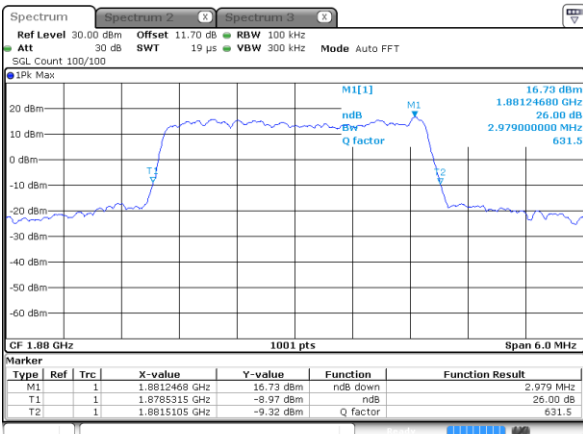

Date: 2 AUG 2017 17:23:30

Middle Channel / 3MHz / 16QAM

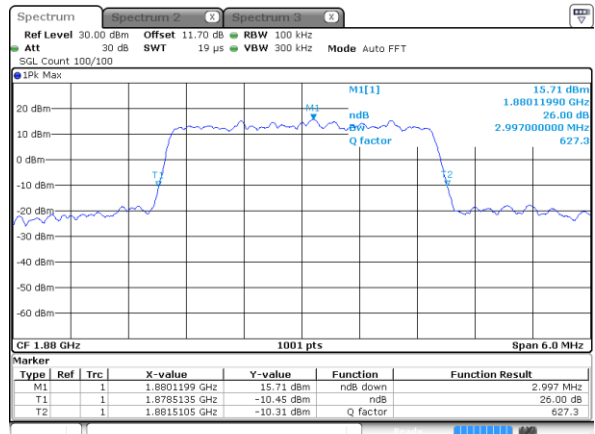

Date: 2 AUG 2017 17:23:40

Highest Channel / 3MHz / QPSK

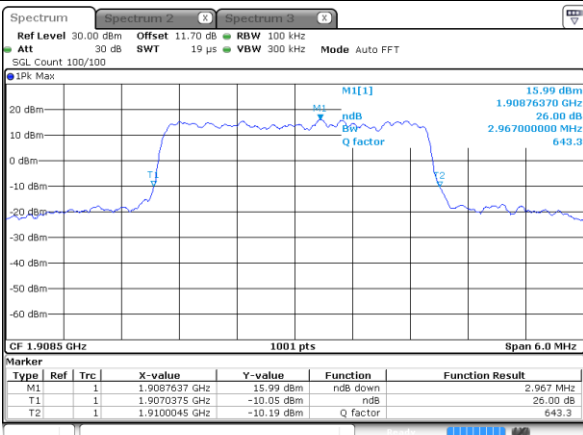

Date: 2 AUG 2017 17:25:58

Highest Channel / 3MHz / 16QAM

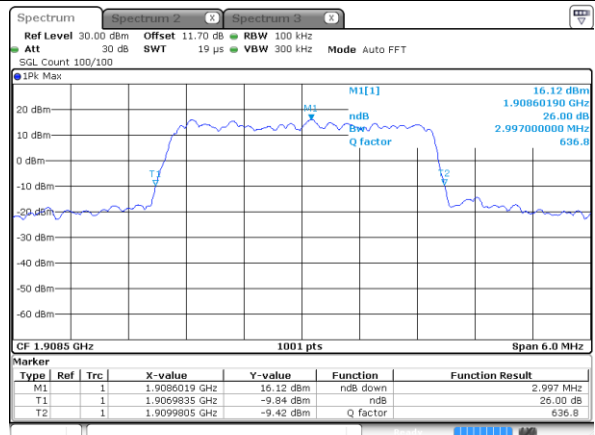

Date: 2 AUG 2017 17:26:08



LTE Band 2

Lowest Channel / 5MHz / QPSK

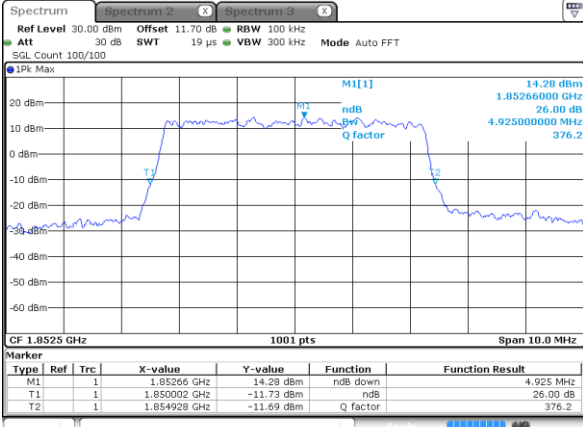

Date: 2 AUG 2017 17:33:34

Lowest Channel / 5MHz / 16QAM

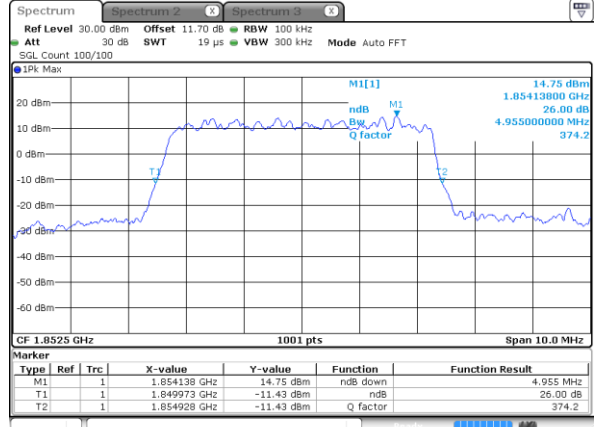

Date: 2 AUG 2017 17:33:44

Middle Channel / 5MHz / QPSK

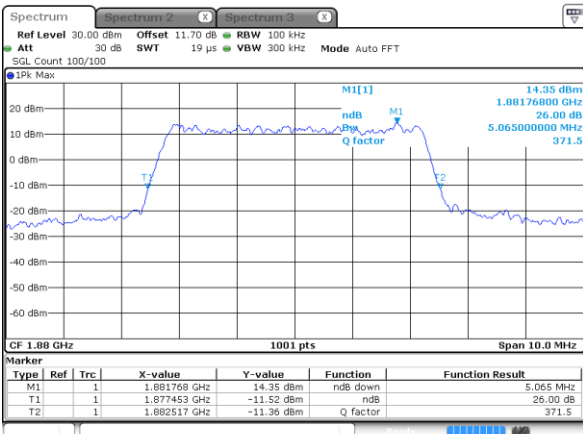

Date: 2 AUG 2017 17:40:37

Middle Channel / 5MHz / 16QAM

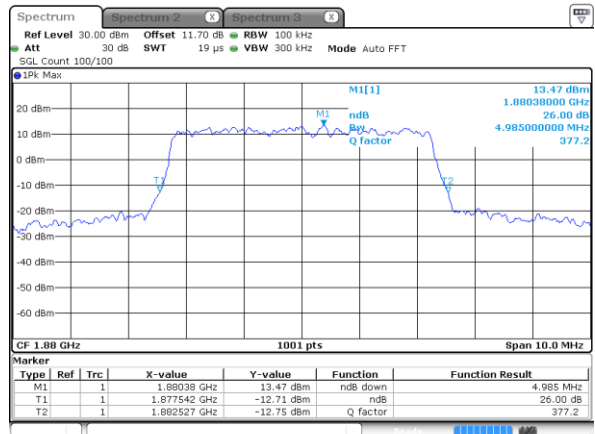

Date: 2 AUG 2017 17:40:47

Highest Channel / 5MHz / QPSK

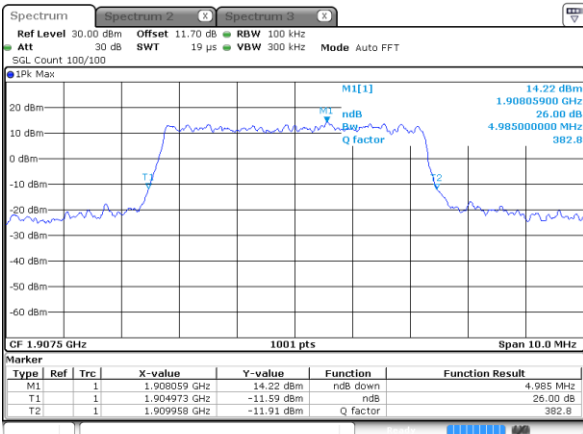

Date: 2 AUG 2017 17:43:06

Highest Channel / 5MHz / 16QAM

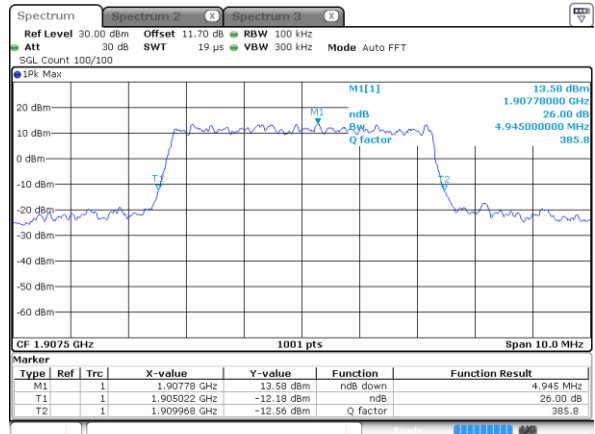

Date: 2 AUG 2017 17:43:16



LTE Band 2

Lowest Channel / 10MHz / QPSK

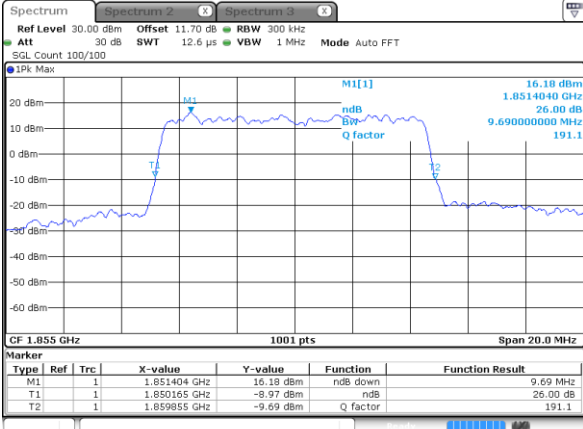

Date: 2 AUG 2017 17:50:09

Lowest Channel / 10MHz / 16QAM

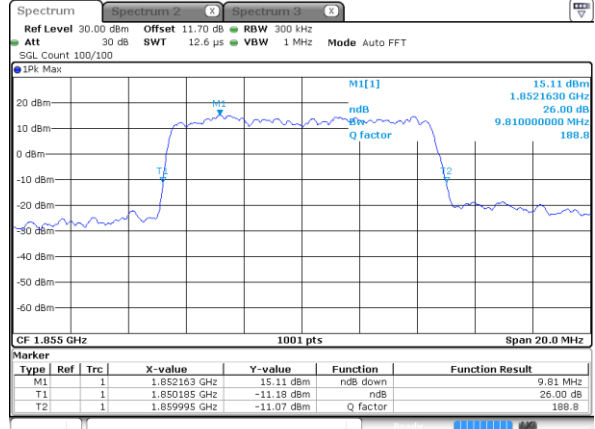

Date: 2 AUG 2017 17:50:19

Middle Channel / 10MHz / QPSK

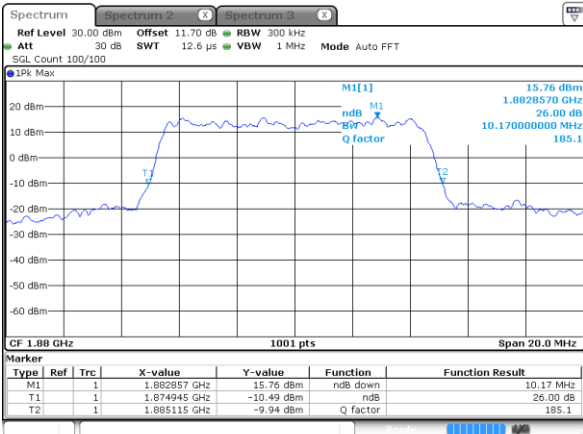

Date: 2 AUG 2017 17:57:13

Middle Channel / 10MHz / 16QAM

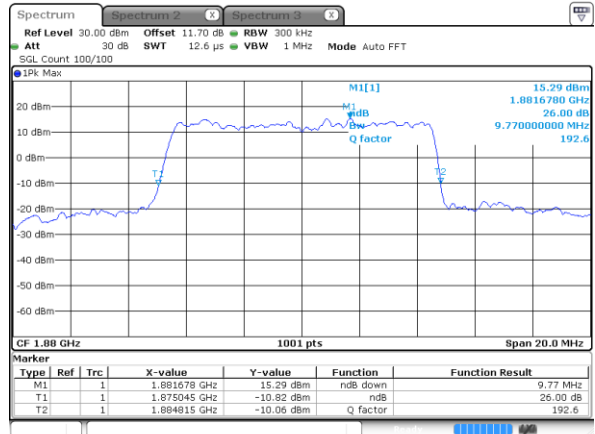

Date: 2 AUG 2017 17:57:23

Highest Channel / 10MHz / QPSK

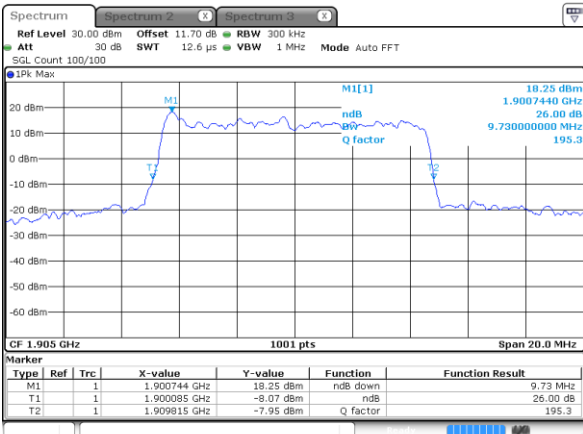

Date: 2 AUG 2017 17:59:41

Highest Channel / 10MHz / 16QAM

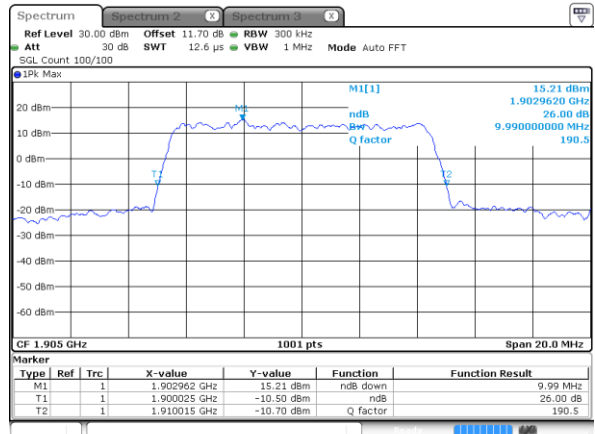

Date: 2 AUG 2017 17:59:51



LTE Band 2

Lowest Channel / 15MHz / QPSK

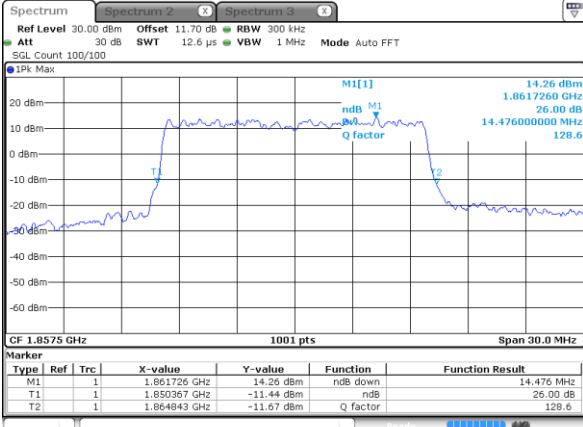

Date: 2 AUG 2017 18:06:44

Lowest Channel / 15MHz / 16QAM

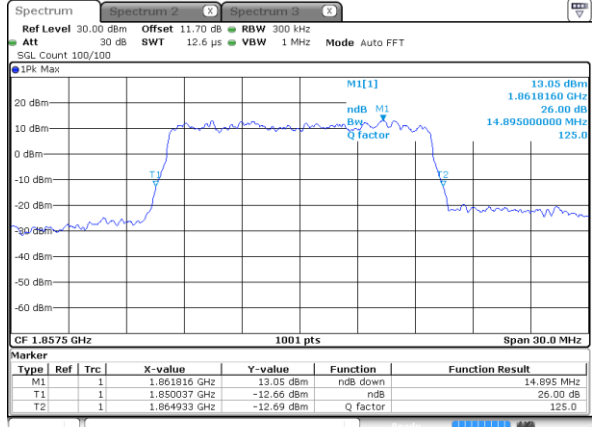

Date: 2 AUG 2017 18:06:54

Middle Channel / 15MHz / QPSK

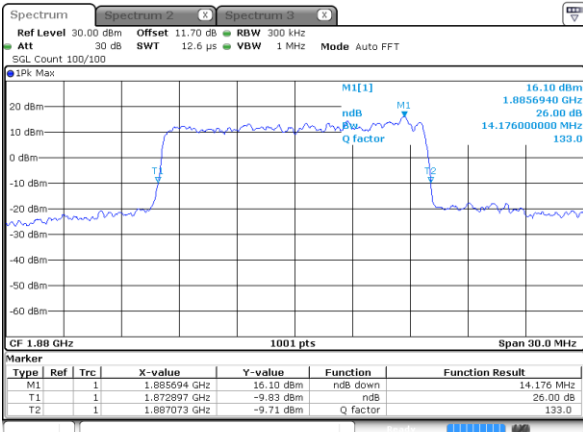

Date: 2 AUG 2017 18:13:48

Middle Channel / 15MHz / 16QAM

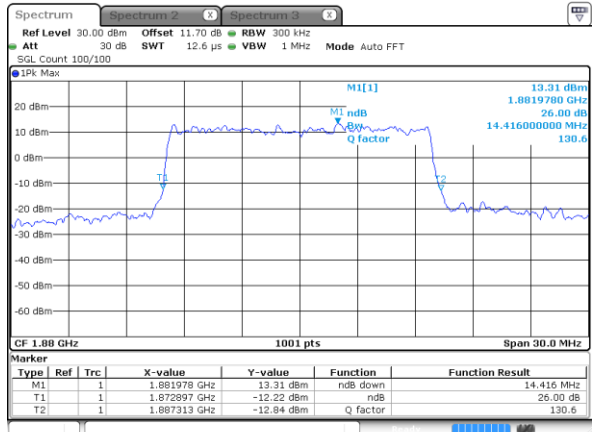

Date: 2 AUG 2017 18:13:58

Highest Channel / 15MHz / QPSK

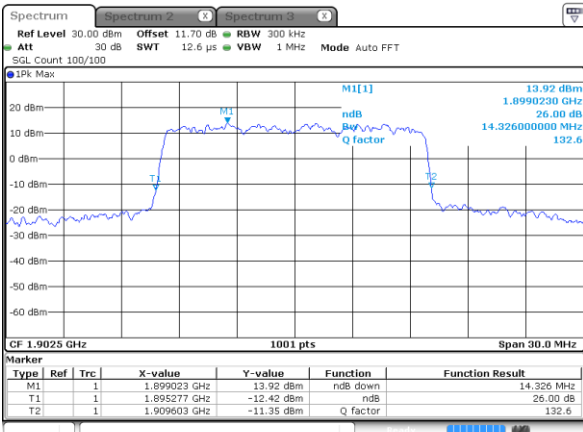

Date: 2 AUG 2017 18:16:16

Highest Channel / 15MHz / 16QAM

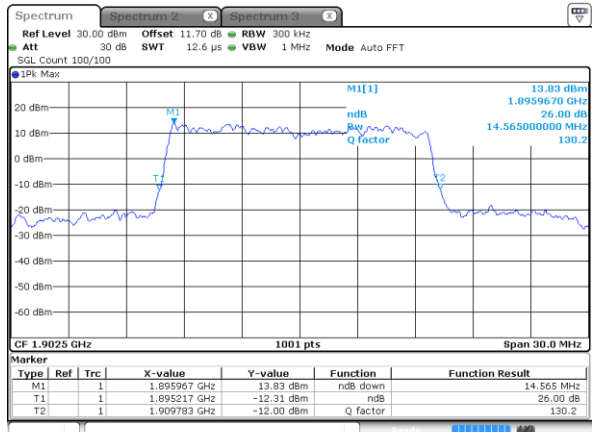

Date: 2 AUG 2017 18:16:26



LTE Band 2

Lowest Channel / 20MHz / QPSK

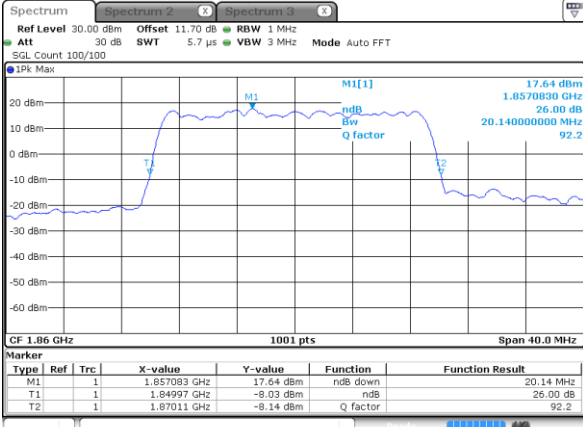

Date: 2 AUG 2017 18:23:20

Lowest Channel / 20MHz / 16QAM

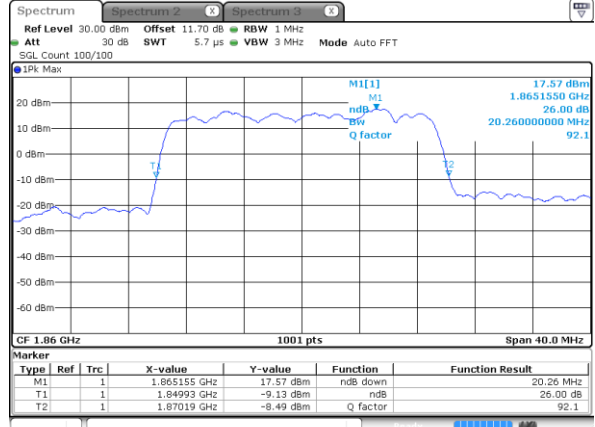

Date: 2 AUG 2017 18:23:30

Middle Channel / 20MHz / QPSK

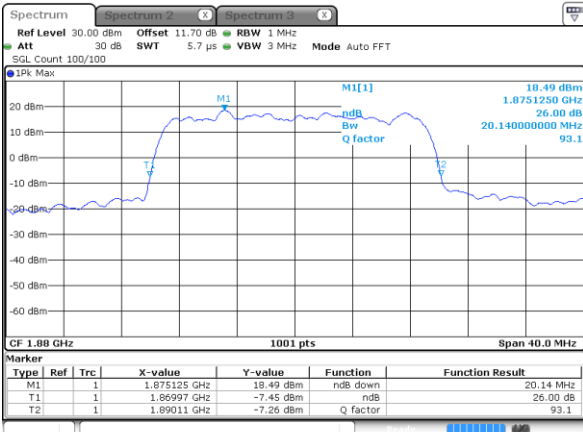

Date: 2 AUG 2017 18:30:23

Middle Channel / 20MHz / 16QAM

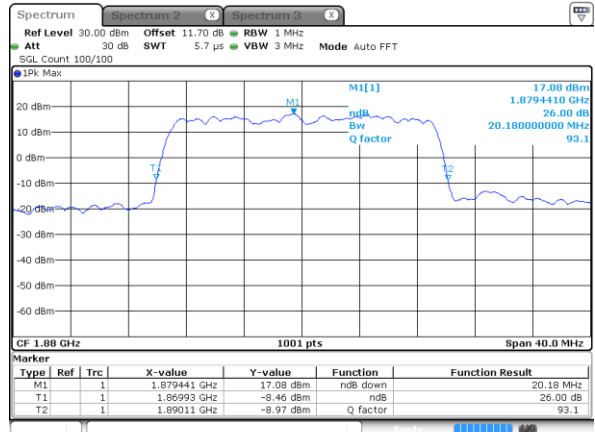

Date: 2 AUG 2017 18:30:33

Highest Channel / 20MHz / QPSK

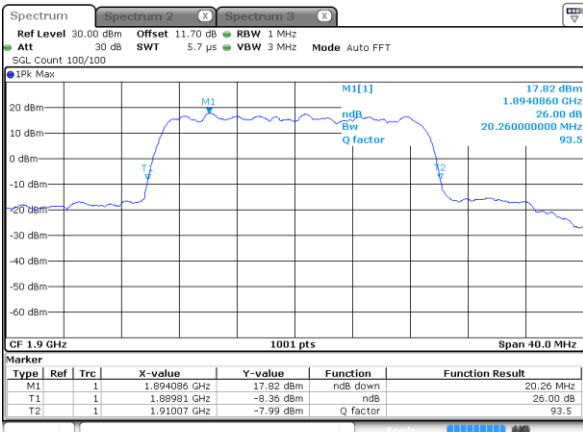

Date: 2 AUG 2017 18:32:51

Highest Channel / 20MHz / 16QAM

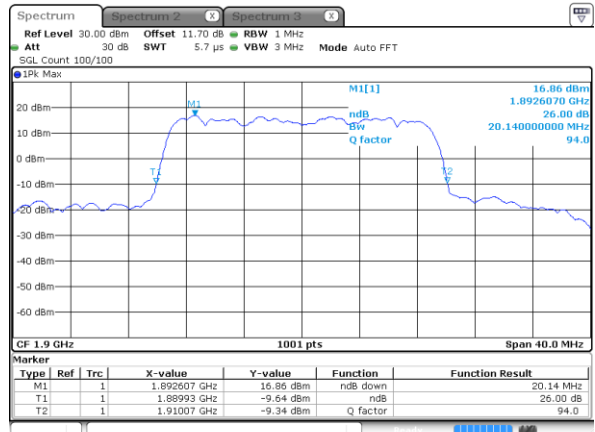

Date: 2 AUG 2017 18:33:01



Occupied Bandwidth

| Mode | LTE Band 2 : 99%OBW(MHz) | | | | | | | | | | | |
|------------|--------------------------|-------|------|-------|------|-------|-------|-------|-------|-------|-------|-------|
| | 1.4MHz | | 3MHz | | 5MHz | | 10MHz | | 15MHz | | 20MHz | |
| BW | QPSK | 16QAM | QPSK | 16QAM | QPSK | 16QAM | QPSK | 16QAM | QPSK | 16QAM | QPSK | 16QAM |
| Lowest CH | 1.09 | 1.09 | 2.73 | 2.72 | 4.52 | 4.48 | 9.11 | 9.03 | 13.46 | 13.49 | 18.34 | 18.42 |
| Middle CH | 1.08 | 1.1 | 2.72 | 2.73 | 4.49 | 4.49 | 9.05 | 9.03 | 13.52 | 13.52 | 18.22 | 18.58 |
| Highest CH | 1.1 | 1.09 | 2.72 | 2.73 | 4.5 | 4.51 | 9.01 | 9.09 | 13.43 | 13.43 | 18.3 | 18.46 |



LTE Band 2

Lowest Channel / 1.4MHz / QPSK

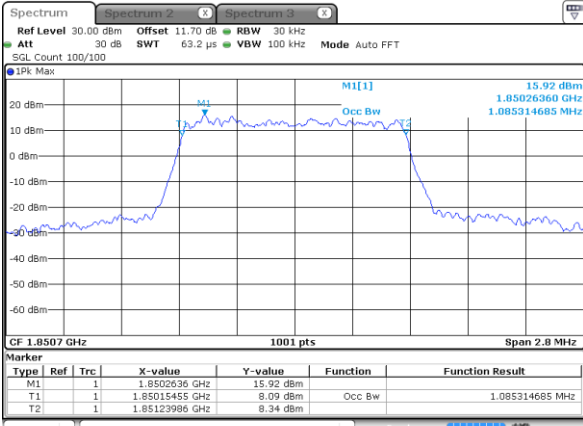

Date: 2 AUG 2017 18:39:35

Lowest Channel / 1.4MHz / 16QAM

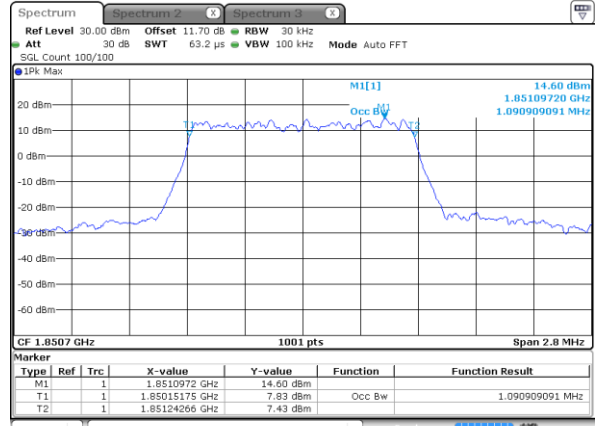

Date: 2 AUG 2017 18:39:45

Middle Channel / 1.4MHz / QPSK

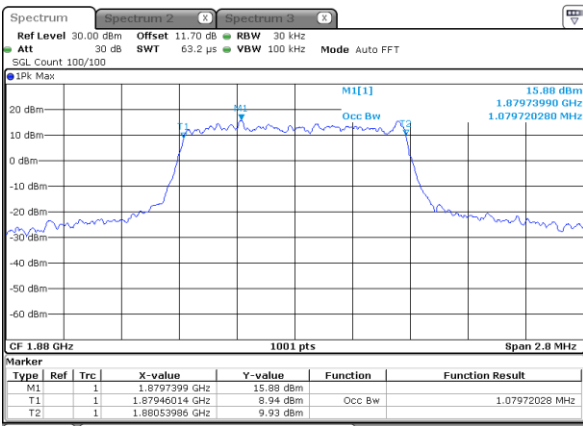

Date: 2 AUG 2017 18:46:38

Middle Channel / 1.4MHz / 16QAM

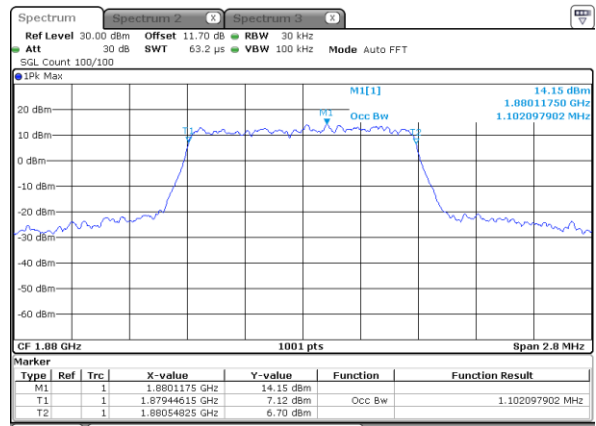

Date: 2 AUG 2017 18:46:48

Highest Channel / 1.4MHz / QPSK

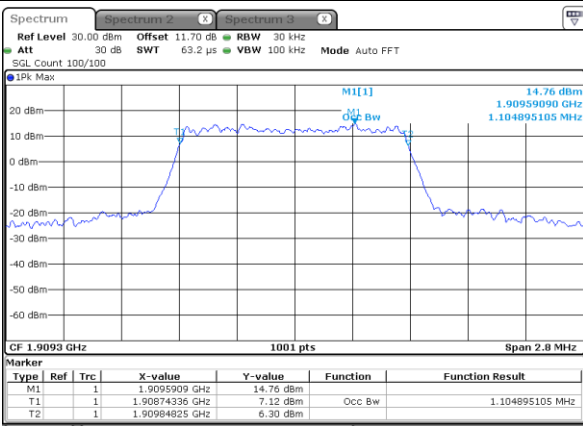

Date: 2 AUG 2017 18:49:06

Highest Channel / 1.4MHz / 16QAM

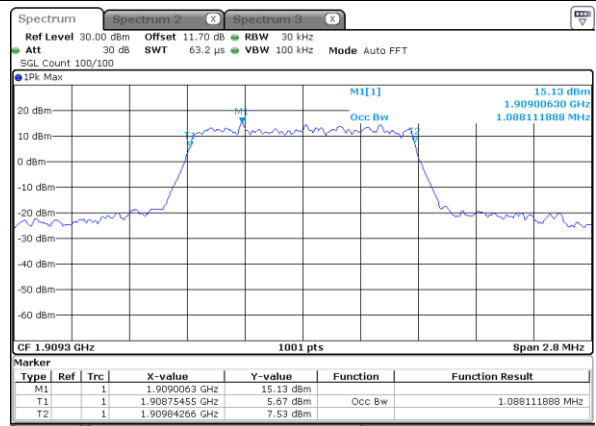

Date: 2 AUG 2017 18:49:17



LTE Band 2

Lowest Channel / 3MHz / QPSK

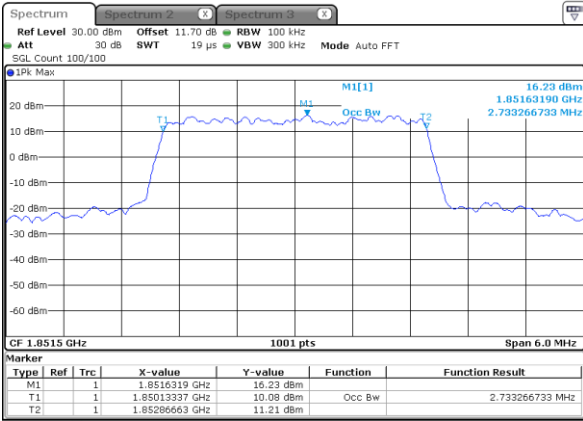

Date: 2 AUG 2017 17:16:06

Lowest Channel / 3MHz / 16QAM

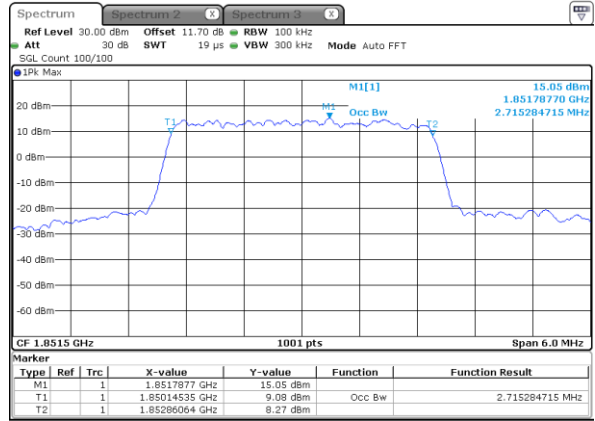

Date: 2 AUG 2017 17:16:16

Middle Channel / 3MHz / QPSK

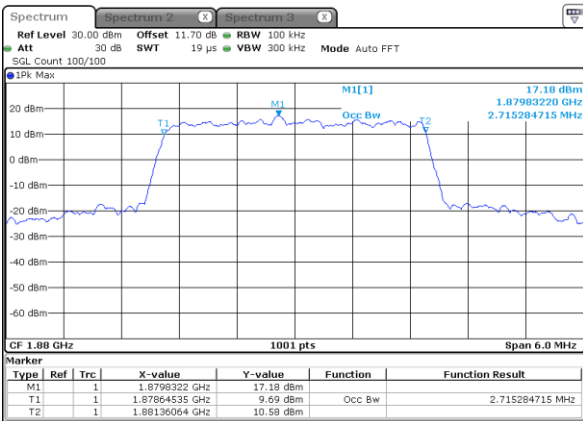

Date: 2 AUG 2017 17:23:10

Middle Channel / 3MHz / 16QAM

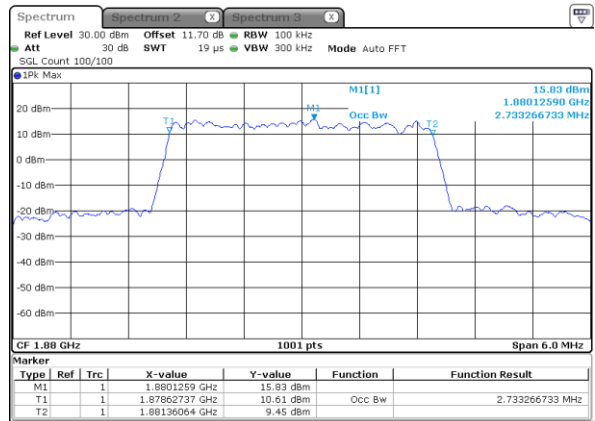

Date: 2 AUG 2017 17:23:20

Highest Channel / 3MHz / QPSK

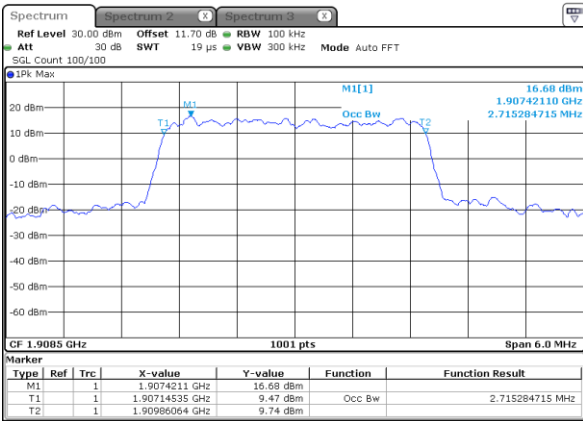

Date: 2 AUG 2017 17:25:38

Highest Channel / 3MHz / 16QAM

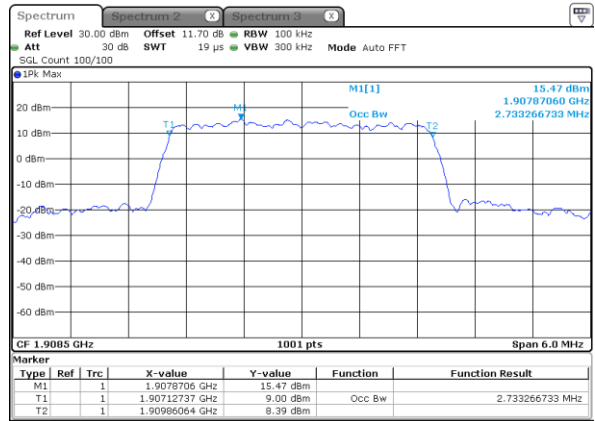

Date: 2 AUG 2017 17:25:48



LTE Band 2

Lowest Channel / 5MHz / QPSK

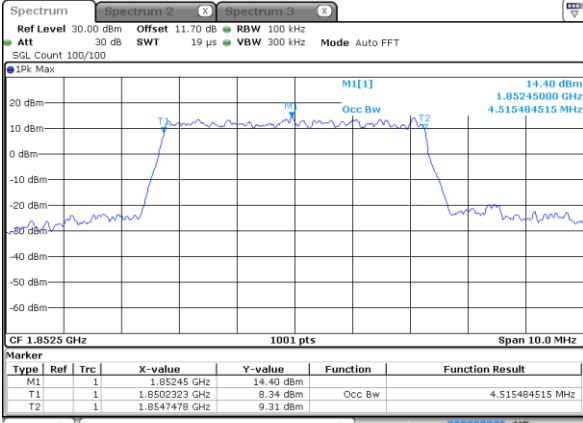

Date: 2 AUG 2017 17:33:14

Lowest Channel / 5MHz / 16QAM

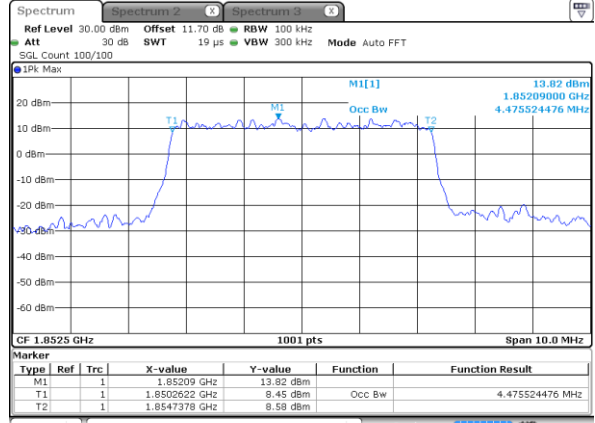

Date: 2 AUG 2017 17:33:24

Middle Channel / 5MHz / QPSK

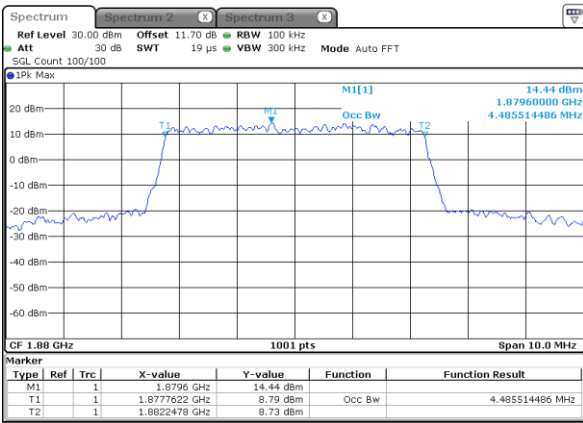

Date: 2 AUG 2017 17:40:17

Middle Channel / 5MHz / 16QAM

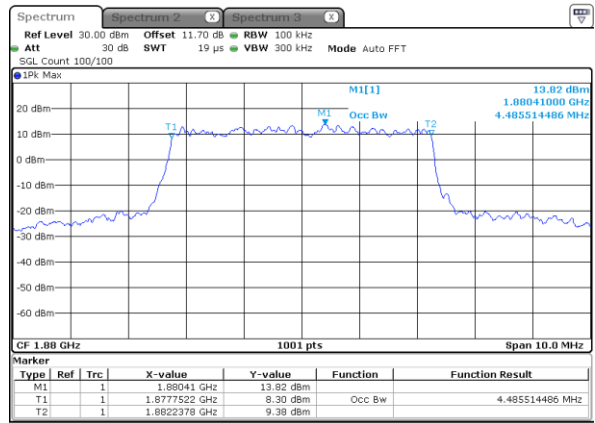

Date: 2 AUG 2017 17:40:27

Highest Channel / 5MHz / QPSK

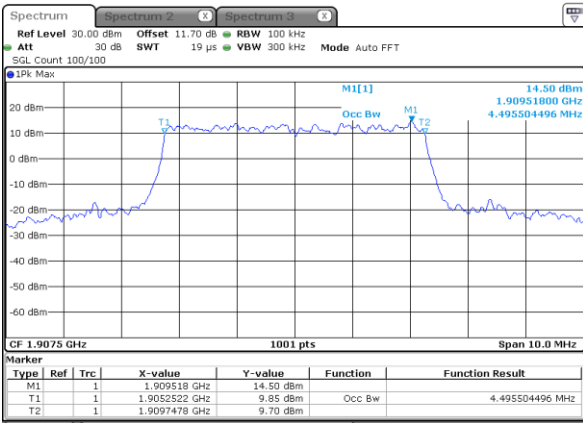

Date: 2 AUG 2017 17:42:45

Highest Channel / 5MHz / 16QAM

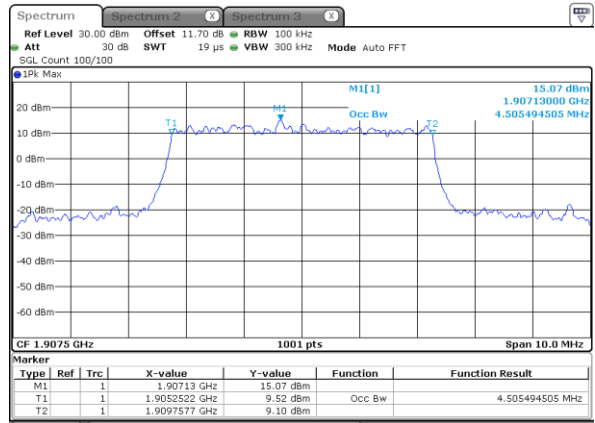

Date: 2 AUG 2017 17:42:56



LTE Band 2

Lowest Channel / 10MHz / QPSK

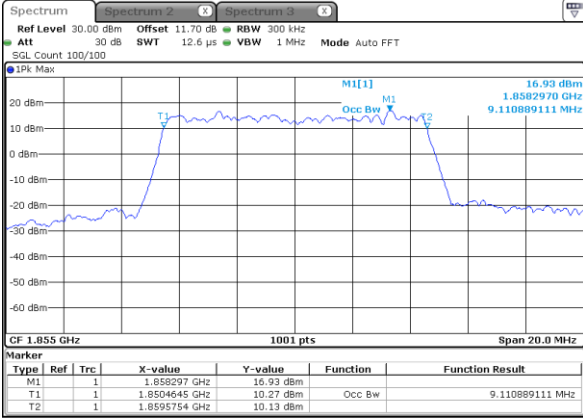

Date: 2 AUG 2017 17:49:49

Lowest Channel / 10MHz / 16QAM

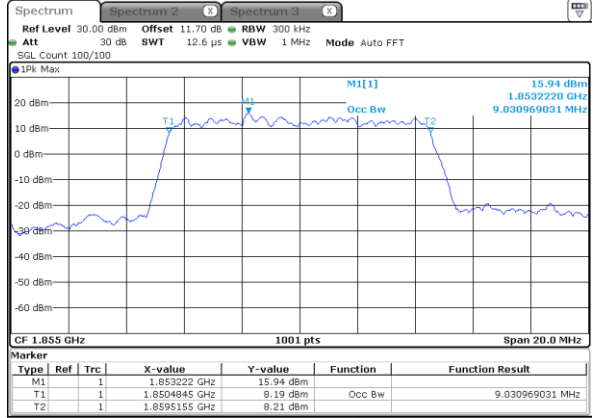

Date: 2 AUG 2017 17:49:59

Middle Channel / 10MHz / QPSK

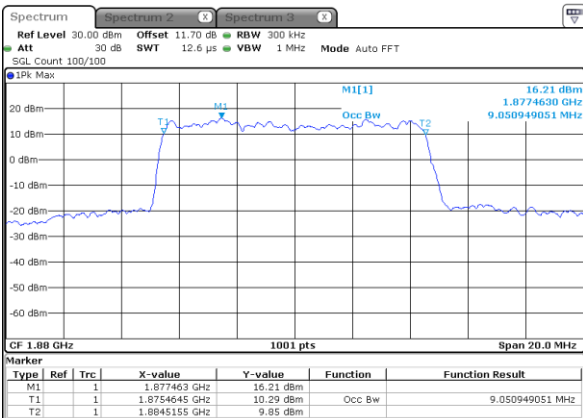

Date: 2 AUG 2017 17:56:52

Middle Channel / 10MHz / 16QAM

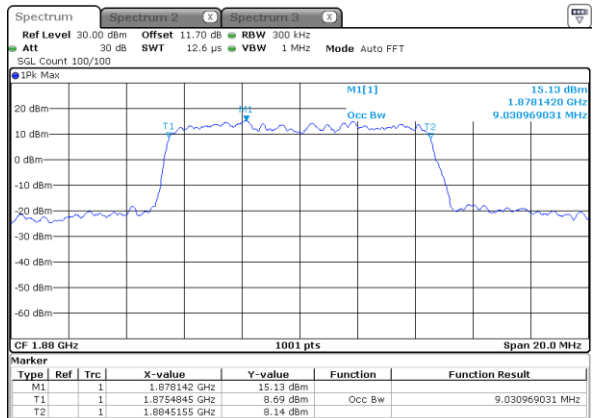

Date: 2 AUG 2017 17:57:02

Highest Channel / 10MHz / QPSK

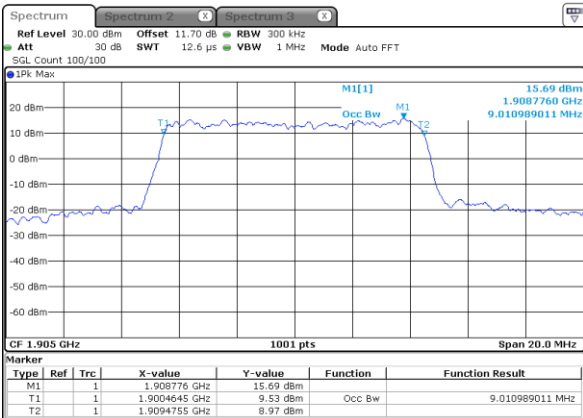

Date: 2 AUG 2017 17:59:21

Highest Channel / 10MHz / 16QAM

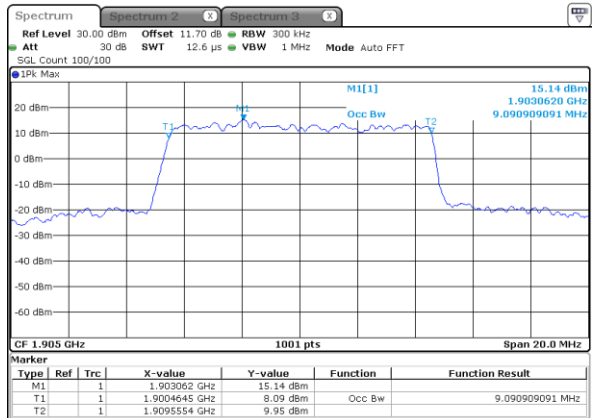

Date: 2 AUG 2017 17:59:31



LTE Band 2

Lowest Channel / 15MHz / QPSK

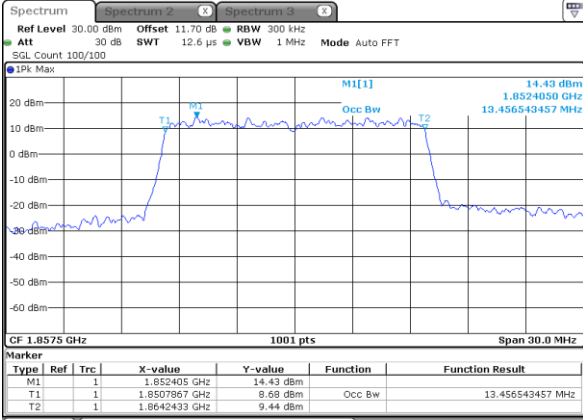

Date: 2 AUG 2017 18:06:24

Lowest Channel / 15MHz / 16QAM

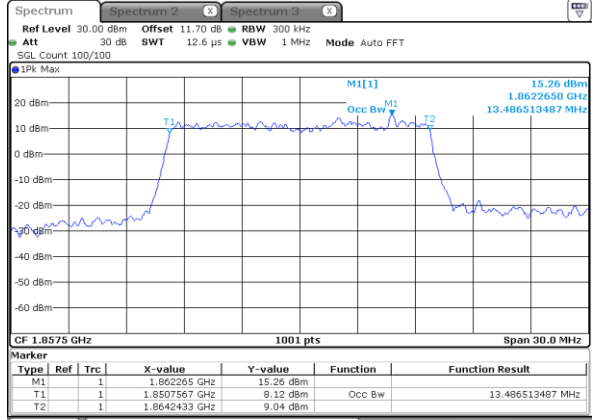

Date: 2 AUG 2017 18:06:34

Middle Channel / 15MHz / QPSK

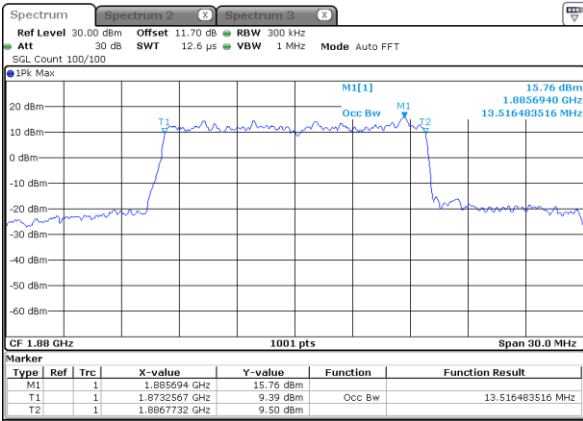

Date: 2 AUG 2017 18:13:27

Middle Channel / 15MHz / 16QAM

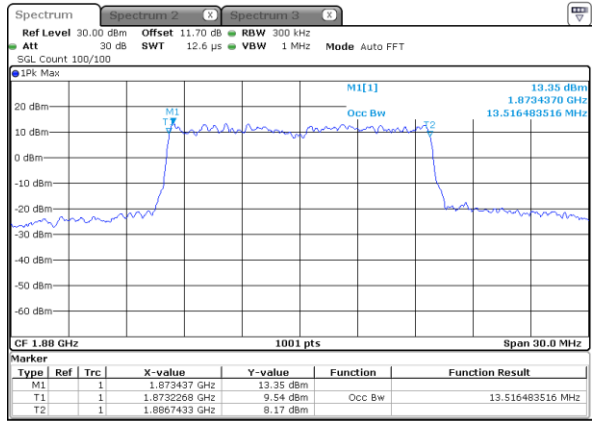

Date: 2 AUG 2017 18:13:38

Highest Channel / 15MHz / QPSK

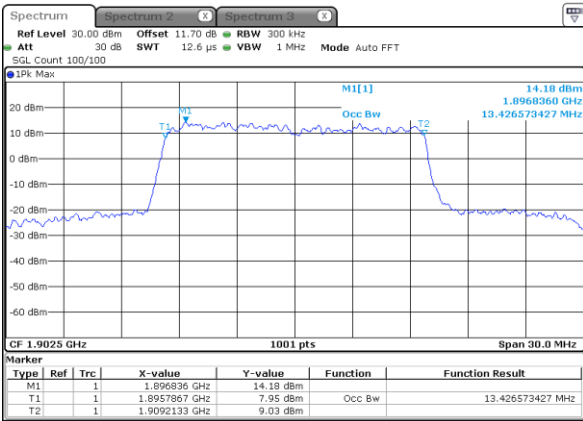

Date: 2 AUG 2017 18:15:56

Highest Channel / 15MHz / 16QAM

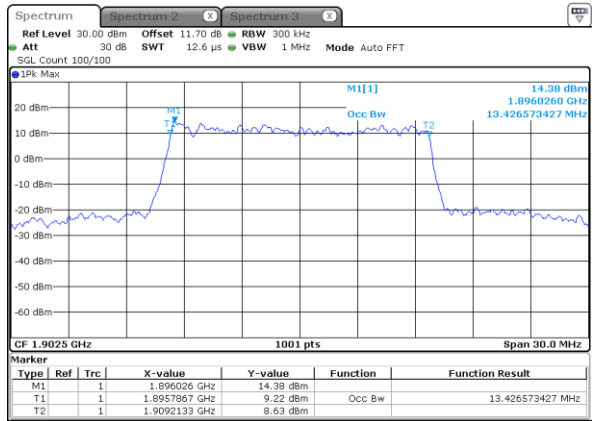

Date: 2 AUG 2017 18:16:06



LTE Band 2

Lowest Channel / 20MHz / QPSK

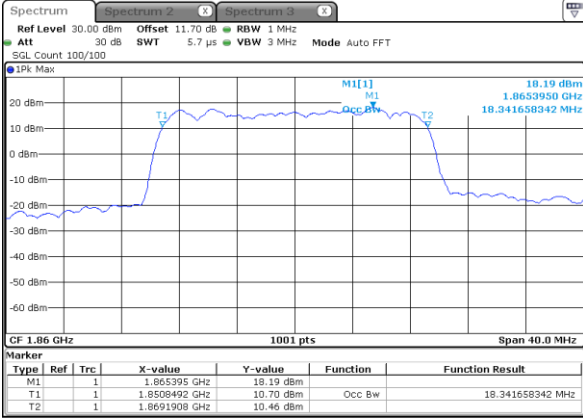

Date: 2 AUG 2017 18:22:59

Lowest Channel / 20MHz / 16QAM

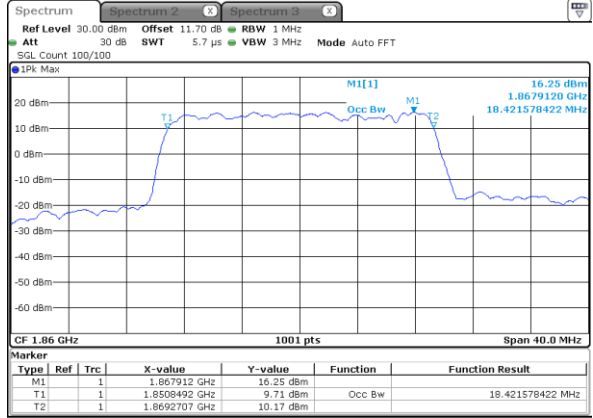

Date: 2 AUG 2017 18:23:09

Middle Channel / 20MHz / QPSK

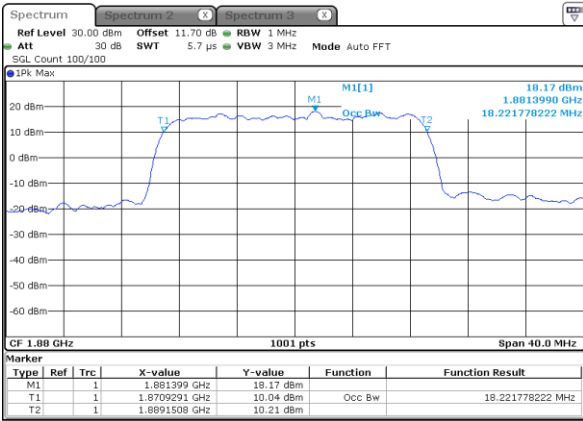

Date: 2 AUG 2017 18:30:03

Middle Channel / 20MHz / 16QAM

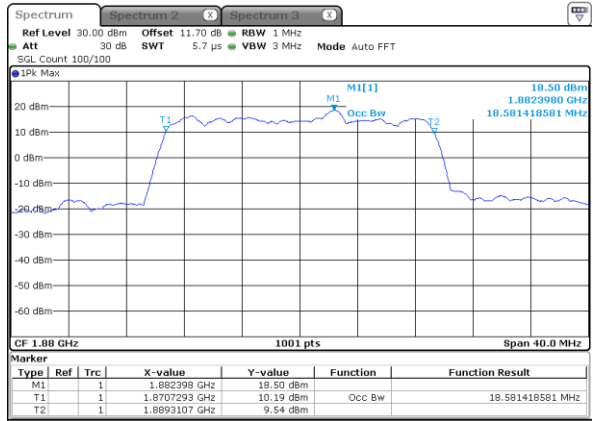

Date: 2 AUG 2017 18:30:13

Highest Channel / 20MHz / QPSK

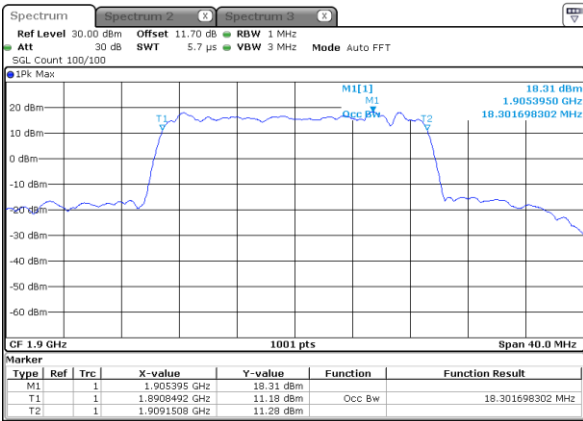

Date: 2 AUG 2017 18:32:31

Highest Channel / 20MHz / 16QAM

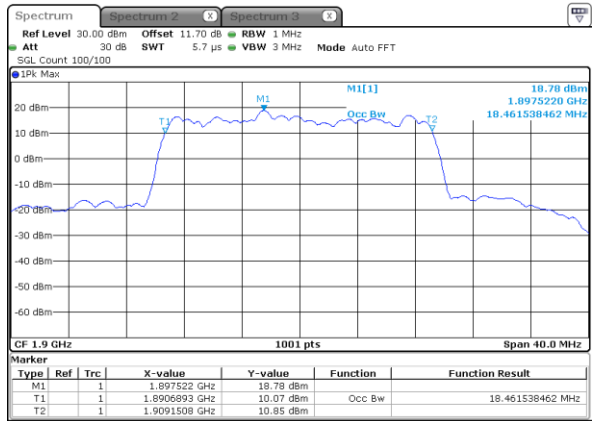

Date: 2 AUG 2017 18:32:41



Conducted Band Edge



LTE Band 2 / 1.4MHz / QPSK

Lowest Band Edge / 1RB

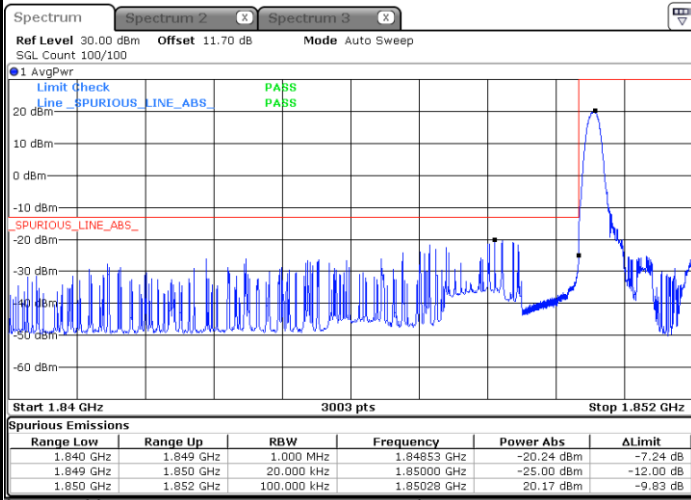

Date: 2 AUG 2017 18:41:13

Highest Band Edge / 1RB

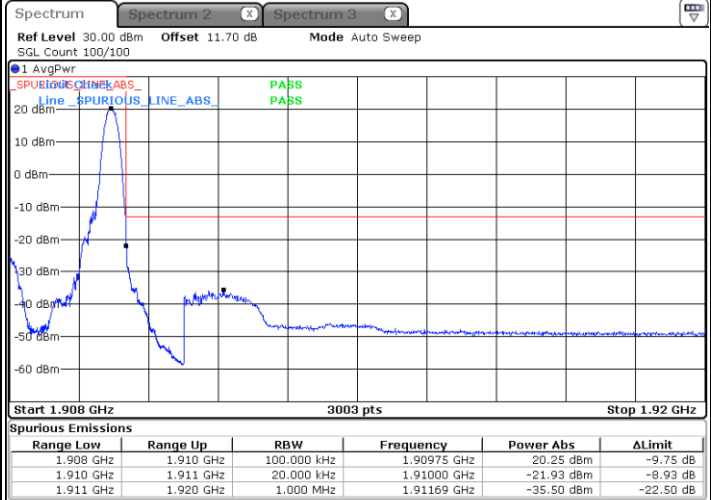

Date: 2 AUG 2017 18:50:45

Lowest Band Edge / Full RB

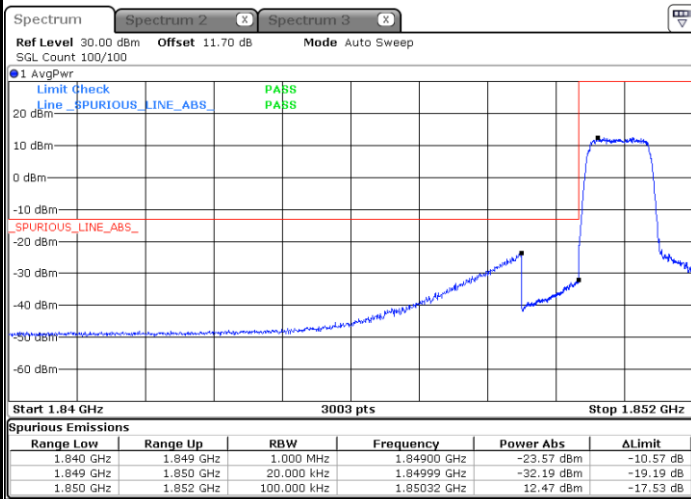

Date: 2 AUG 2017 18:43:31

Highest Band Edge / Full RB

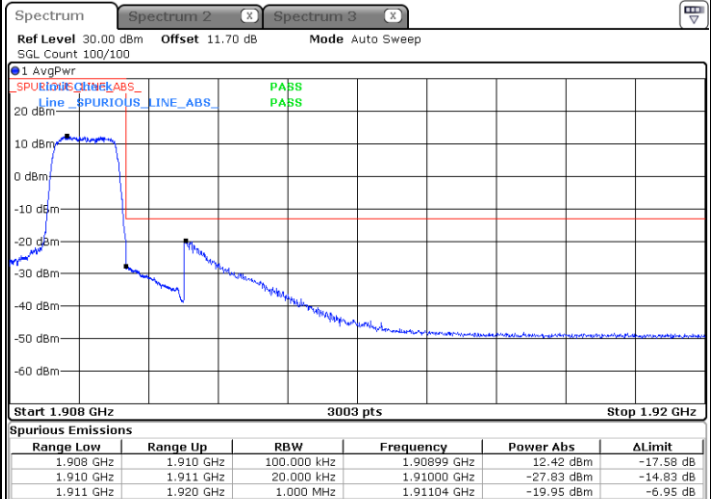

Date: 2 AUG 2017 18:53:03



LTE Band 2 / 1.4MHz / 16QAM

Lowest Band Edge / 1 RB

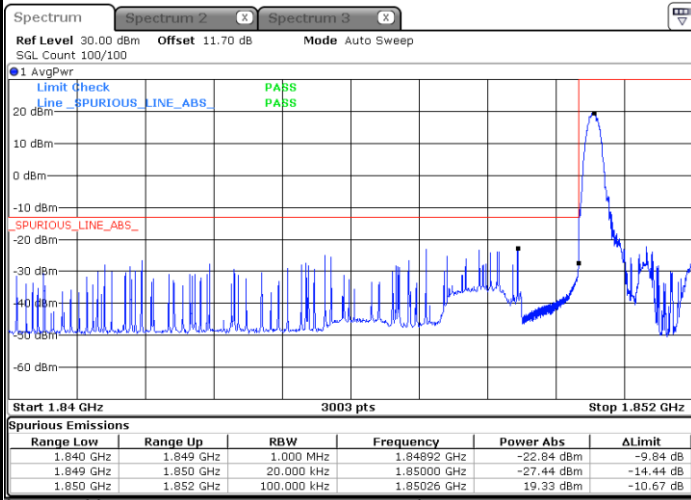

Date: 2 AUG 2017 18:42:22

Highest Band Edge / 1 RB

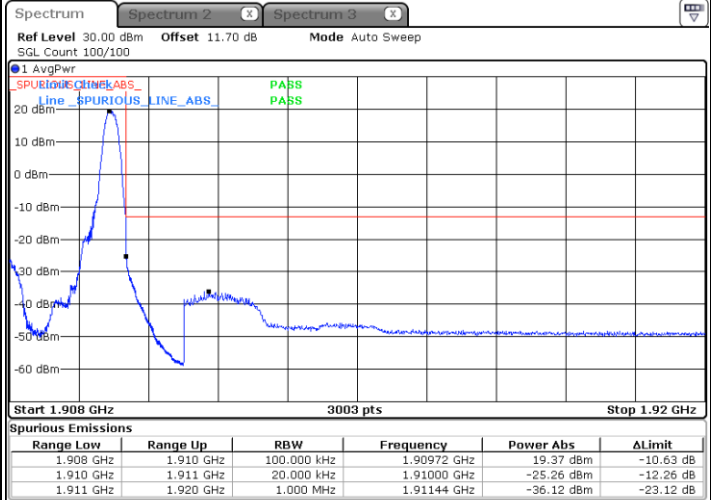

Date: 2 AUG 2017 18:51:54

Lowest Band Edge / Full RB

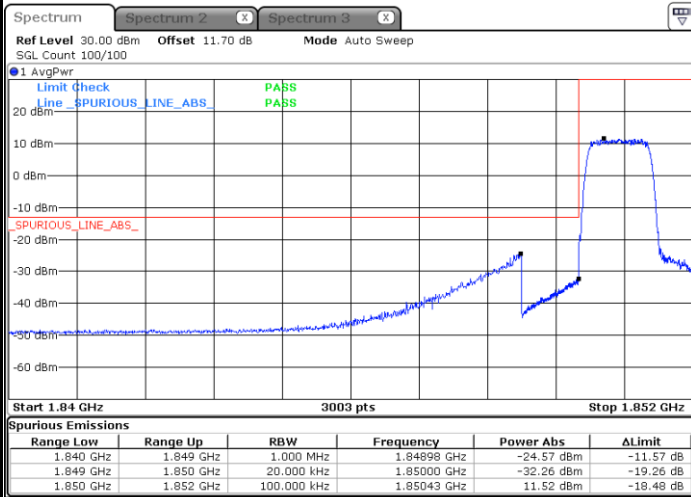

Date: 2 AUG 2017 18:44:40

Highest Band Edge / Full RB

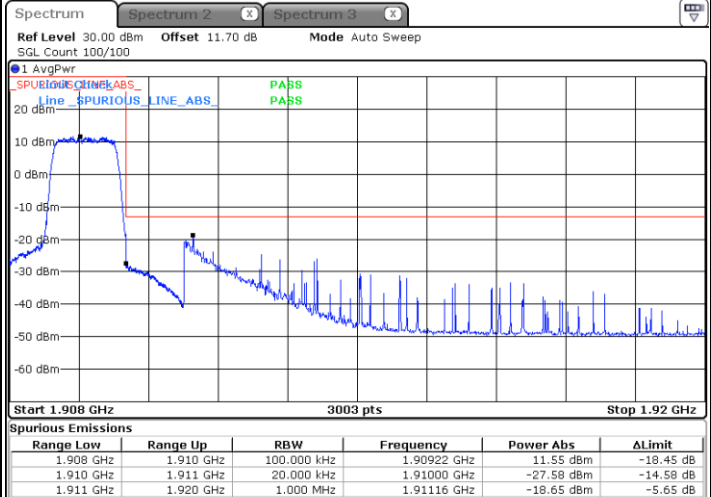

Date: 2 AUG 2017 18:54:12



LTE Band 2 / 3MHz / QPSK

Lowest Band Edge / 1RB

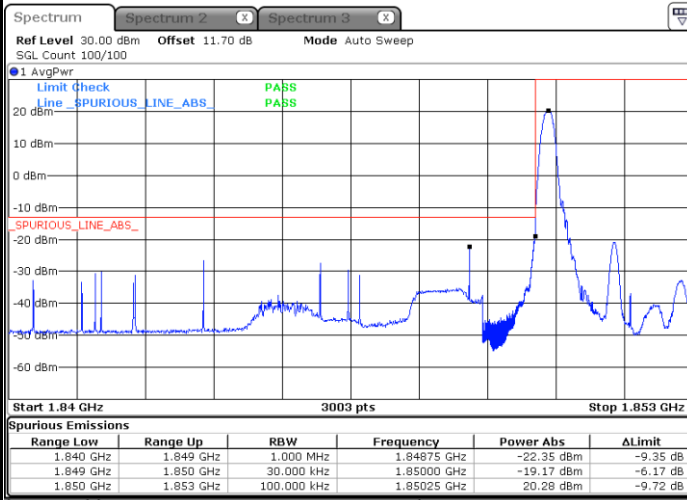

Date: 2 AUG 2017 17:17:45

Highest Band Edge / 1 RB

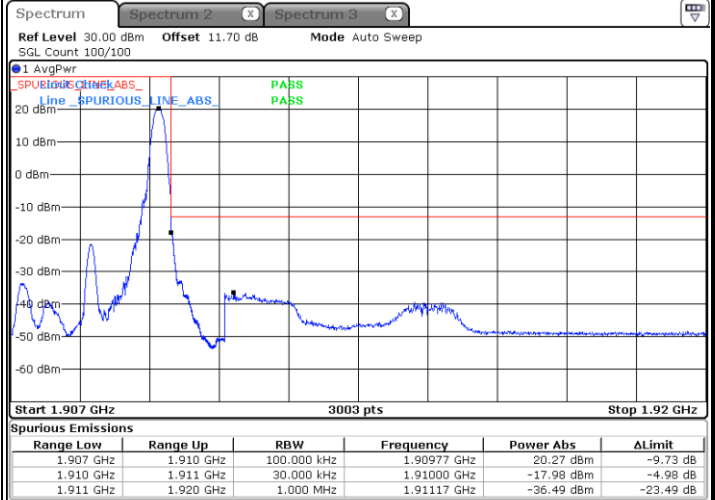

Date: 2 AUG 2017 17:27:17

Lowest Band Edge / Full RB

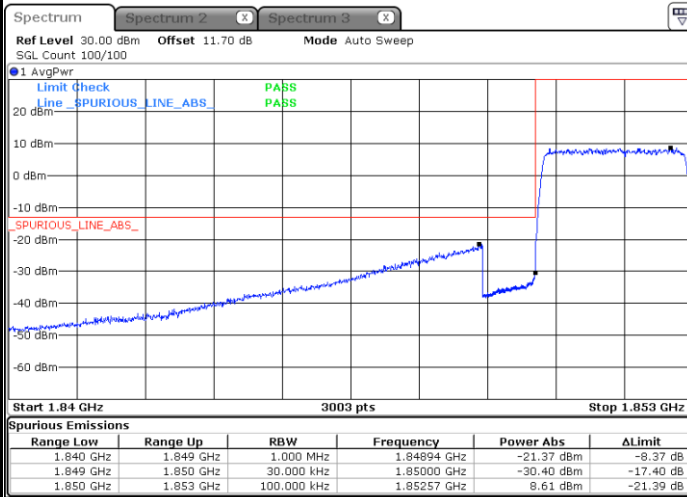

Date: 2 AUG 2017 17:20:03

Highest Band Edge / Full RB

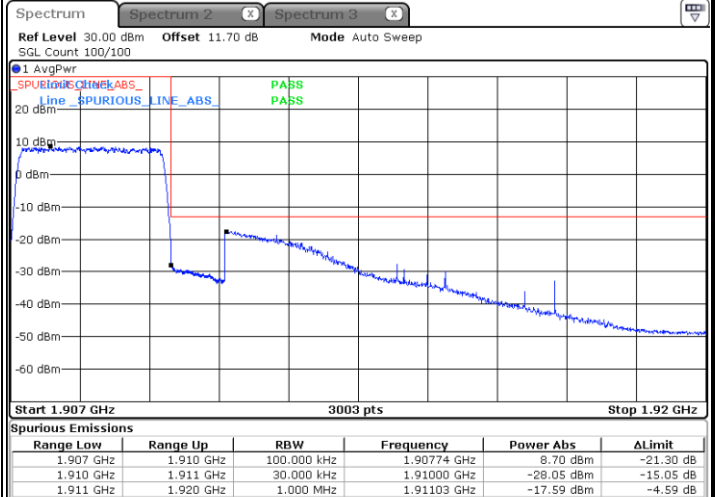

Date: 2 AUG 2017 17:29:34



LTE Band 2 / 3MHz / 16QAM

Lowest Band Edge / 1 RB

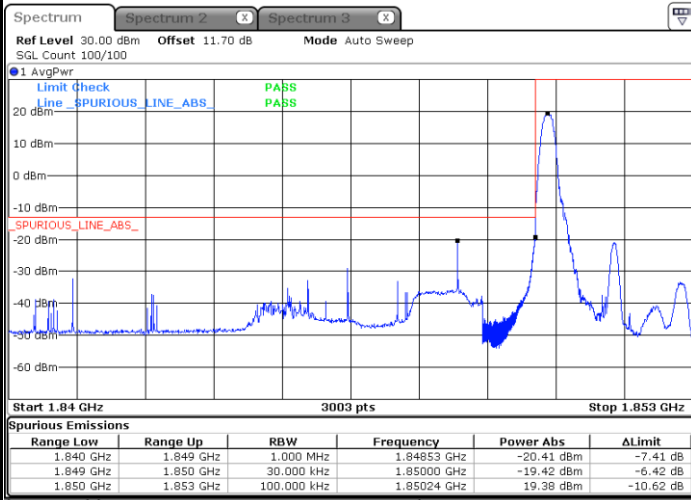

Date: 2 AUG 2017 17:18:54

Highest Band Edge / 1 RB

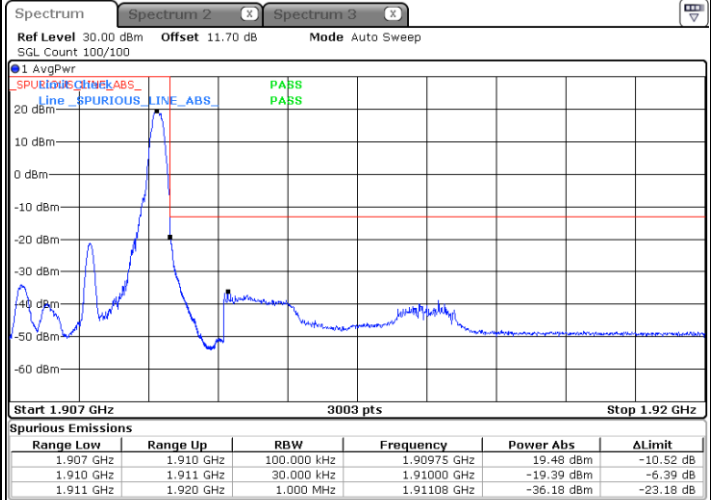

Date: 2 AUG 2017 17:28:26

Lowest Band Edge / Full RB

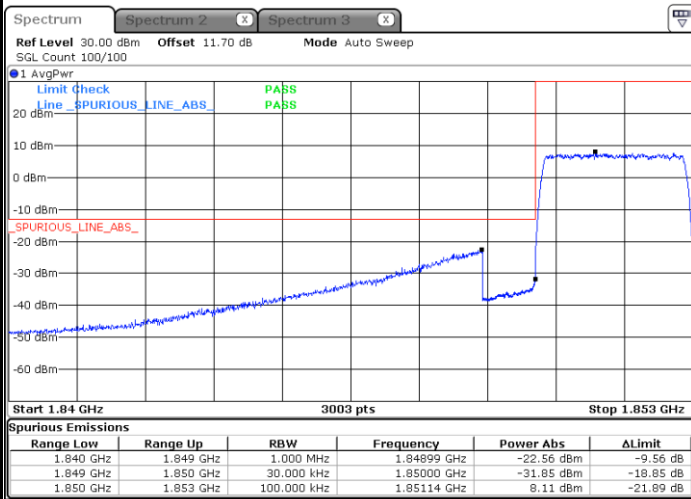

Date: 2 AUG 2017 17:21:11

Highest Band Edge / Full RB



Date: 2 AUG 2017 17:30:43



LTE Band 2 / 5MHz / QPSK

Lowest Band Edge / 1 RB

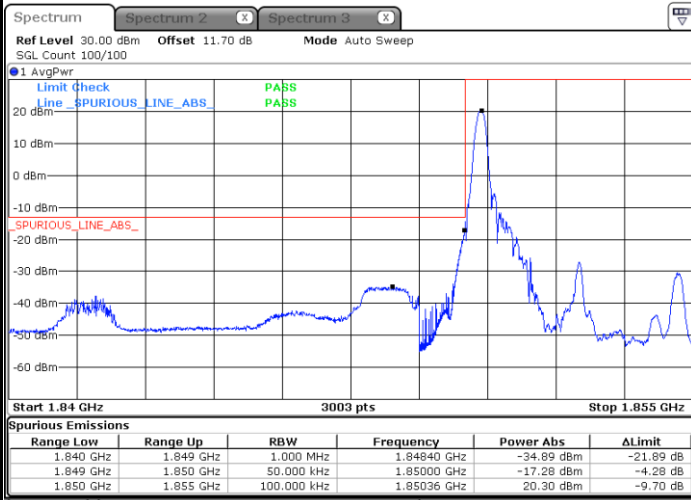

Date: 2 AUG 2017 17:34:52

Highest Band Edge / 1 RB



Date: 2 AUG 2017 17:44:24

Lowest Band Edge / Full RB

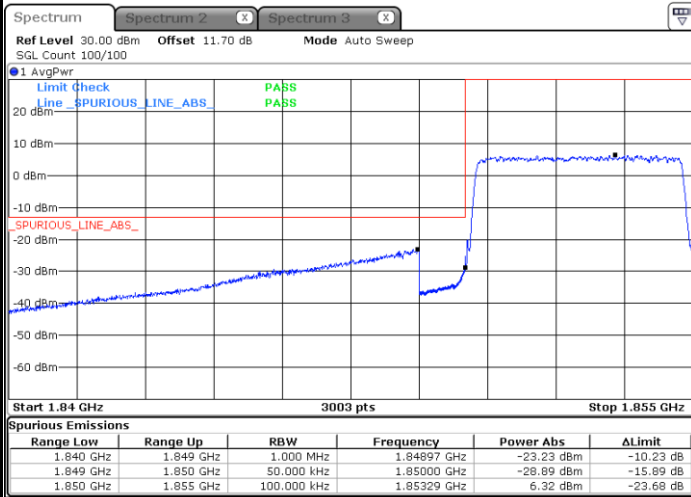

Date: 2 AUG 2017 17:37:10

Highest Band Edge / Full RB

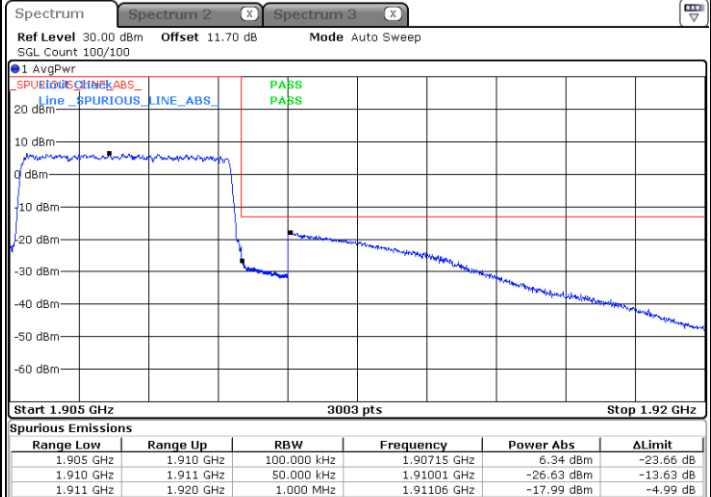

Date: 2 AUG 2017 17:46:42



LTE Band 2 / 5MHz / 16QAM

Lowest Band Edge / 1RB

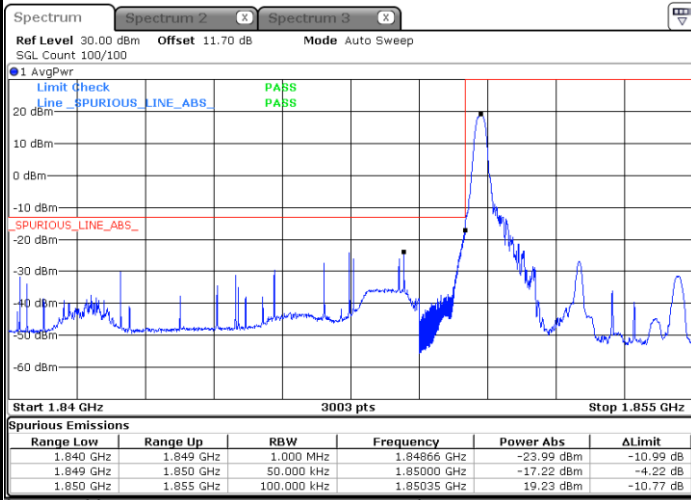

Date: 2 AUG.2017 17:36:01

Highest Band Edge / 1 RB

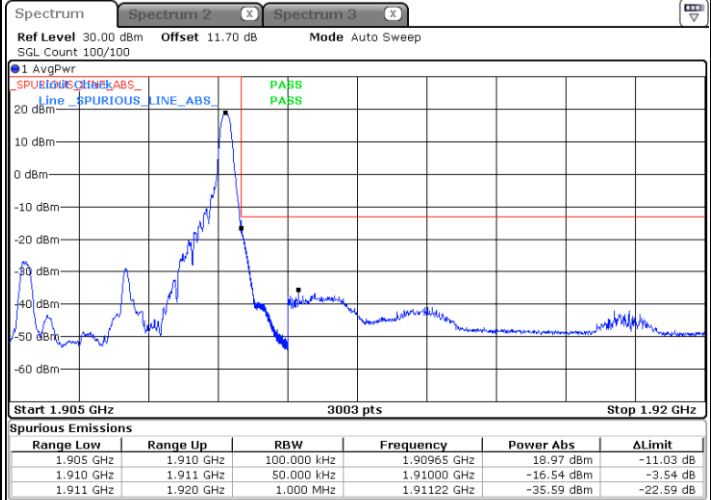

Date: 2 AUG.2017 17:45:33

Lowest Band Edge / Full RB

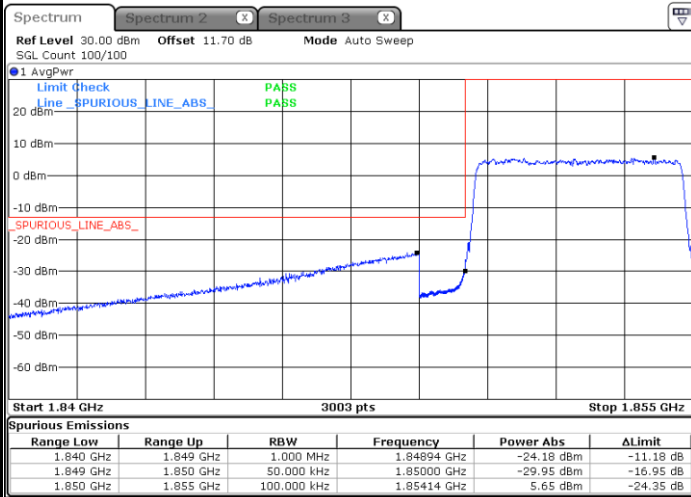

Date: 2 AUG.2017 17:38:19

Highest Band Edge / Full RB

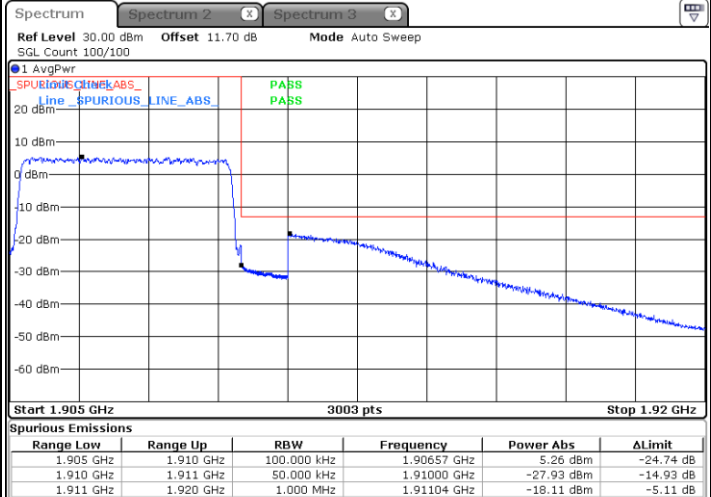

Date: 2 AUG.2017 17:47:50