



FCC RF Test Report

APPLICANT : Bullitt Group
EQUIPMENT : Rugged Smart Phone
BRAND NAME : CAT
MODEL NAME : S41
FCC ID : ZL5S41A
STANDARD : FCC 47 CFR Part 2, 22(H), 24(E), 27(L)
CLASSIFICATION : PCS Licensed Transmitter Held to Ear (PCE)

The product was received on Jun. 06, 2017 and testing was completed on Aug. 05, 2017. We, SPORTON INTERNATIONAL INC., would like to declare that the tested sample has been evaluated in accordance with the test procedures given in ANSI / TIA / EIA-603-D-2010 and has been in compliance with the applicable technical standards.

The test results in this report apply exclusively to the tested model / sample. Without written approval of SPORTON INTERNATIONAL INC., the test report shall not be reproduced except in full.

Reviewed by: Joseph Lin / Supervisor

Approved by: Jones Tsai / Manager



SPORTON INTERNATIONAL INC.

No. 52, Hwa Ya 1st Rd., Hwa Ya Technology Park, Kwei-Shan District, Tao Yuan City, Taiwan, R.O.C.

SPORTON INTERNATIONAL INC.

TEL : 886-3-327-3456

FAX : 886-3-328-4978

FCC ID : ZL5S41A

Page Number : 1 of 20

Report Issued Date : Aug. 25, 2017

Report Version : Rev. 01

Report Template No.: BU5-FG22/24/27 Version 2.0



TABLE OF CONTENTS

REVISION HISTORY..... 3

SUMMARY OF TEST RESULT 4

1 GENERAL DESCRIPTION 5

 1.1 Applicant..... 5

 1.2 Manufacturer 5

 1.3 Product Feature of Equipment Under Test 5

 1.4 Modification of EUT 5

 1.5 Testing Location 6

 1.6 Applicable Standards 6

2 TEST CONFIGURATION OF EQUIPMENT UNDER TEST 7

 2.1 Test Mode..... 7

 2.2 Connection Diagram of Test System 8

 2.3 Support Unit used in test configuration 8

 2.4 Measurement Results Explanation Example 8

 2.5 Frequency List of Low/Middle/High Channels..... 9

3 CONDUCTED TEST RESULT..... 10

 3.1 Measuring Instruments..... 10

 3.2 Test Setup 10

 3.3 Test Result of Conducted Test..... 10

 3.4 Conducted Output Power and ERP/EIRP 11

 3.5 Peak-to-Average Ratio 12

 3.6 99% Occupied Bandwidth and 26dB Bandwidth Measurement..... 13

 3.7 Conducted Band Edge 14

 3.8 Conducted Spurious Emission 15

 3.9 Frequency Stability..... 16

4 RADIATED TEST ITEMS 17

 4.1 Measuring Instruments..... 17

 4.2 Test Setup 17

 4.3 Test Result of Radiated Test..... 17

 4.4 Field Strength of Spurious Radiation Measurement 18

5 LIST OF MEASURING EQUIPMENT 19

6 UNCERTAINTY OF EVALUATION 20

APPENDIX A. TEST RESULTS OF CONDUCTED TEST

APPENDIX B. TEST RESULTS OF RADIATED TEST

APPENDIX C. TEST SETUP PHOTOGRAPHS



REVISION HISTORY

REPORT NO.	VERSION	DESCRIPTION	ISSUED DATE
FG760506-01A	Rev. 01	Initial issue of report	Aug. 25, 2017



SUMMARY OF TEST RESULT

Report Section	FCC Rule	Description	Limit	Result	Remark
3.4	§2.1046	Conducted Output Power	Reporting Only	PASS	-
	§22.913(a)(2)	Effective Radiated Power	< 7 Watts	PASS	-
	§24.232(c)	Equivalent Isotropic Radiated Power	< 2 Watts	PASS	-
	§27.50(d)(4)	Equivalent Isotropic Radiated Power	< 1 Watts	PASS	-
3.5	§24.232(d)	Peak-to-Average Ratio	< 13 dB	PASS	-
3.6	§2.1049 §22.917(b) §24.238(b) §27.53(g)	Occupied Bandwidth	Reporting Only	PASS	-
3.7	§2.1051 §22.917(a) §24.238(a) §27.53(h)	Band Edge Measurement	< 43+10log10(P[Watts])	PASS	-
3.8	§2.1051 §22.917(a) §24.238(a) §27.53(h)	Conducted Emission	< 43+10log10(P[Watts])	PASS	-
3.9	§2.1055 §22.355	Frequency Stability for Temperature & Voltage	< 2.5 ppm for Part 22	PASS	-
	§2.1055 §24.235 §27.54		Within Authorized Band		
4.4	§2.1053 §22.917(a) §24.238(a) §27.53(h)	Field Strength of Spurious Radiation	< 43+10log10(P[Watts])	PASS	Under limit 21.76 dB at 3822.000 MHz



1 General Description

1.1 Applicant

Bullitt Group

One Valpy, Valpy Street, Reading, Berkshire, England RG1 1AR

1.2 Manufacturer

Compal Electronics, INC.

No. 385, Yangguang St. Neihu District, Taipei City 11491, Taiwan, R.O.C

1.3 Product Feature of Equipment Under Test

GSM/WCDMA/LTE, Bluetooth, Wi-Fi 2.4GHz 802.11b/g/n, Wi-Fi 5GHz 802.11a/n, FM Receiver, NFC, and GPS.

Product Specification subjective to this standard	
Antenna Type	WWAN: PIFA + Coupling type (LDS) Antenna WLAN: PIFA Antenna Bluetooth: PIFA Antenna GPS / Glonass : PIFA Antenna NFC: Loop Antenna FM: Integral Antenna (Earphone acting as FM antenna deemed as an integral antenna)

<Sample Information>

S41 has 2 different Variant	
Sample 1	Dual SIM
Sample 2	Single SIM
For Dual-SIM or Single-SIM control by SW, The HW difference is SIM holder.	

Remark: All test items were performed with Sample 1.

1.4 Modification of EUT

No modifications are made to the EUT during all test items.



1.5 Testing Location

Sporton Lab is accredited to ISO 17025 by Taiwan Accreditation Foundation (TAF code : 1190) and the FCC designation No. TW0007 under the FCC 2.948(e) by Mutual Recognition Agreement (MRA) in FCC Test.

Test Site	SPORTON INTERNATIONAL INC.
Test Site Location	No. 52, Hwa Ya 1 st Rd., Hwa Ya Technology Park, Kwei-Shan District, Tao Yuan City, Taiwan, R.O.C. TEL: +886-3-327-3456 FAX: +886-3-328-4978
Test Site No.	Sporton Site No.
	TH03-HY

Test Site	SPORTON INTERNATIONAL INC.
Test Site Location	No.58, Aly. 75, Ln. 564, Wenhua 3rd Rd. Guishan Dist, Taoyuan City, Taiwan (R.O.C.) TEL: +886-3-327-0868 FAX: +886-3-327-0855
Test Site No.	Sporton Site No.
	03CH11-HY

1.6 Applicable Standards

According to the specifications of the manufacturer, the EUT must comply with the requirements of the following standards:

- 47 CFR Part 2, 22(H), 24(E), 27(L)
- ANSI / TIA / EIA-603-D-2010
- FCC KDB 971168 D01 Power Meas. License Digital Systems v02r02
- FCC KDB 412172 D01 Determining ERP and EIRP v01r01

Remark:

1. All test items were verified and recorded according to the standards and without any deviation during the test.
2. This EUT has also been tested and complied with the requirements of FCC Part 15, Subpart B, recorded in a separate test report.



2 Test Configuration of Equipment Under Test

2.1 Test Mode

Antenna port conducted and radiated test items were performed according to KDB 971168 D01 Power Meas. License Digital Systems v02r02 with maximum output power.

Radiated measurements were performed with rotating EUT in different three orthogonal test planes to find the maximum emission.

Radiated emissions were investigated as following frequency range:

1. 30 MHz to 9000 MHz for GSM850 and WCDMA Band V.
2. 30 MHz to 18000 MHz for WCDMA Band IV.
3. 30 MHz to 19100 MHz for GSM1900 and WCDMA Band II.

All modes and data rates and positions were investigated.

Test modes are chosen to be reported as the worst case configuration below:

Test Modes		
Band	Radiated TCs	Conducted TCs
GSM 850	■ GPRS class 8 Link ■ EDGE class 8 Link	■ GPRS class 8 Link ■ EDGE class 8 Link
GSM 1900	■ GPRS class 8 Link ■ EDGE class 8 Link	■ GPRS class 8 Link ■ EDGE class 8 Link
WCDMA Band V	■ RMC 12.2Kbps Link	■ RMC 12.2Kbps Link
WCDMA Band II	■ RMC 12.2Kbps Link	■ RMC 12.2Kbps Link
WCDMA Band IV	■ RMC 12.2Kbps Link	■ RMC 12.2Kbps Link

2.2 Connection Diagram of Test System

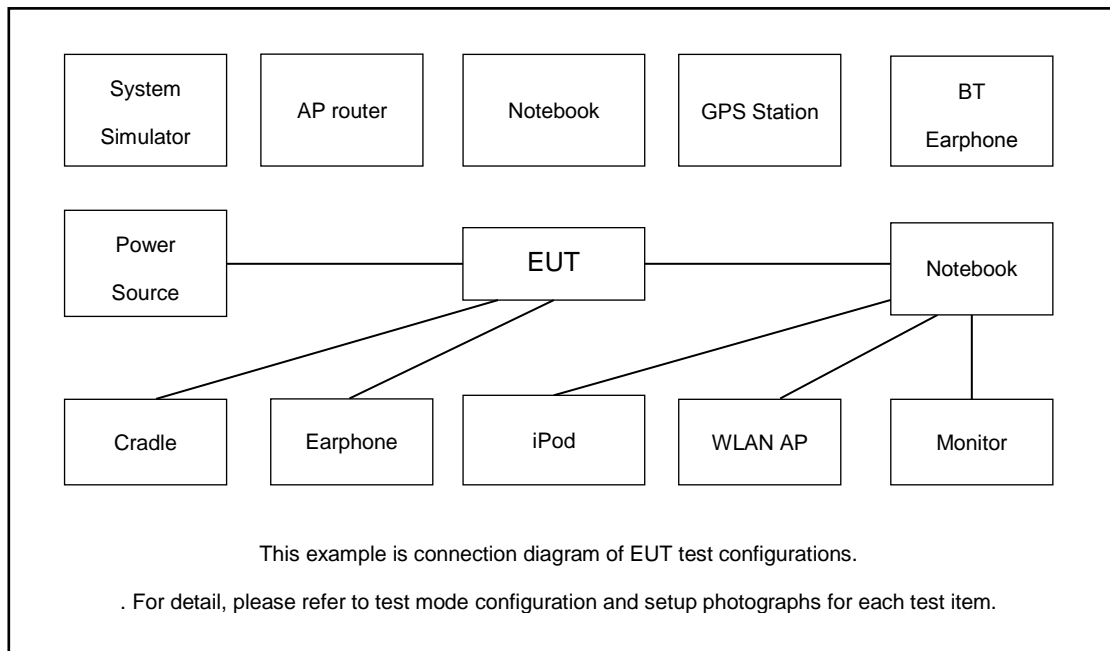

2.3 Support Unit used in test configuration

Item	Equipment	Trade Name	Model No.	FCC ID	Data Cable	Power Cord
1.	System Simulator	R&S	CMU 200	N/A	N/A	Unshielded, 1.8 m

2.4 Measurement Results Explanation Example

For all conducted test items:

The offset level is set in the spectrum analyzer to compensate the RF cable loss and attenuator factor between RF conducted output port and spectrum analyzer. With the offset compensation, the spectrum analyzer reading level will be exactly the RF output level.

The spectrum analyzer offset is derived from RF cable loss and attenuator factor.

Offset = RF cable loss + attenuator factor.

The following shows an offset computation example with RF cable loss 4.2 dB and a 10dB attenuator.

Example :

$$\begin{aligned} \text{Offset}(dB) &= \text{RF cable loss}(dB) + \text{attenuator factor}(dB). \\ &= 4.2 + 10 = 14.2 \text{ (dB)} \end{aligned}$$



2.5 Frequency List of Low/Middle/High Channels

Frequency List				
Band	Channel/Frequency(MHz)	Lowest	Middle	Highest
GSM850	Channel	128	189	251
	Frequency	824.2	836.4	848.8
WCDMA Band V	Channel	4132	4182	4233
	Frequency	826.4	836.4	846.6
GSM1900	Channel	512	661	810
	Frequency	1850.2	1880.0	1909.8
WCDMA Band II	Channel	9262	9400	9538
	Frequency	1852.4	1880.0	1907.6
WCDMA Band IV	Channel	1312	1413	1513
	Frequency	1712.4	1732.6	1752.6

3 Conducted Test Result

3.1 Measuring Instruments

See list of measuring instruments of this test report.

3.2 Test Setup

3.2.1 Conducted Output Power

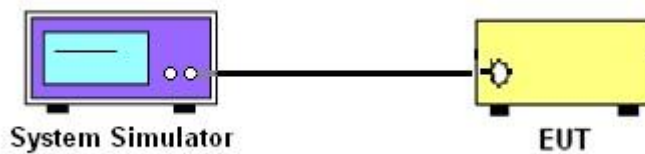

3.2.2 Peak-to-Average Ratio, Occupied Bandwidth, Conducted Band-Edge and Conducted Spurious Emission

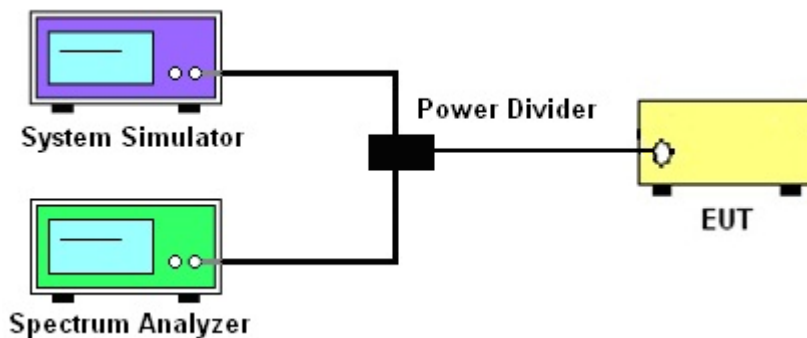

3.2.3 Frequency Stability

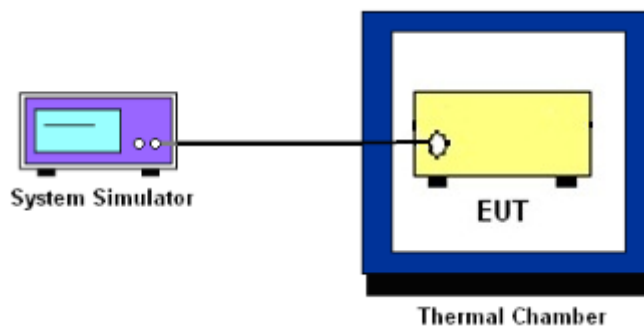

3.3 Test Result of Conducted Test

Please refer to Appendix A.



3.4 Conducted Output Power and ERP/EIRP

3.4.1 Description of the Conducted Output Power and ERP/EIRP

A system simulator was used to establish communication with the EUT. Its parameters were set to enforce EUT transmitting at the maximum power. The measured power in the radio frequency on the transmitter output terminals shall be reported.

The ERP of mobile transmitters must not exceed 7 Watts for GSM850 and WCDMA Band V.

The EIRP of mobile transmitters must not exceed 2 Watts for GSM1900 and WCDMA Band II.

The EIRP of mobile transmitters must not exceed 1 Watts for WCDMA Band IV.

According to KDB 412172 D01 Power Approach,

$EIRP = P_T + G_T - L_C$, $ERP = EIRP - 2.15$, where

P_T = transmitter output power in dBm

G_T = gain of the transmitting antenna in dBi

L_C = signal attenuation in the connecting cable between the transmitter and antenna in dB

3.4.2 Test Procedures

1. The transmitter output port was connected to the system simulator.
2. Set EUT at maximum power through system simulator.
3. Select lowest, middle, and highest channels for each band and different modulation.
4. Measure the maximum burst average power for GSM and maximum average power for other modulation signal.



3.5 Peak-to-Average Ratio

3.5.1 Description of the PAR Measurement

The peak-to-average ratio (PAR) of the transmission may not exceed 13 dB.

3.5.2 Test Procedures

1. The testing follows FCC KDB 971168 D01 v02r02 Section 5.7.1.
2. The EUT was connected to spectrum analyzer and system simulator via a power divider.
3. Set EUT to transmit at maximum output power.
4. When the duty cycle is less than 98%, then signal gating will be implemented on the spectrum analyzer by triggering from the system simulator.
5. Set the CCDF (Complementary Cumulative Distribution Function) option of the spectrum analyzer.
Record the maximum PAPR level associated with a probability of 0.1%.



3.6 99% Occupied Bandwidth and 26dB Bandwidth Measurement

3.6.1 Description of 99% Occupied Bandwidth and 26dB Bandwidth Measurement

The occupied bandwidth is the width of a frequency band such that, below the lower and above the upper frequency limits, the mean powers emitted are each equal to a specified percentage 0.5% of the total mean transmitted power.

The 26 dB emission bandwidth is defined as the frequency range between two points, one above and one below the carrier frequency, at which the spectral density of the emission is attenuated 26 dB below the maximum in-band spectral density of the modulated signal. Spectral density (power per unit bandwidth) is to be measured with a detector of resolution bandwidth equal to approximately 1.0% of the emission bandwidth.

3.6.2 Test Procedures

1. The testing follows FCC KDB 971168 v02r02 Section 4.2.
2. The EUT was connected to spectrum analyzer and system simulator via a power divider.
3. The spectrum analyzer center frequency is set to the nominal EUT channel center frequency. The span range for the spectrum analyzer shall be between two and five times the anticipated OBW.
4. The nominal resolution bandwidth (RBW) shall be in the range of 1 to 5 % of the anticipated OBW, and the VBW shall be at least 3 times the RBW.
5. Set the detection mode to peak, and the trace mode to max hold.
6. Determine the reference value: Set the EUT to transmit a modulated signal. Allow the trace to stabilize. Set the spectrum analyzer marker to the highest level of the displayed trace.
(this is the reference value)
7. Determine the “-26 dB down amplitude” as equal to (Reference Value – X).
8. Place two markers, one at the lowest and the other at the highest frequency of the envelope of the spectral display such that each marker is at or slightly below the “-X dB down amplitude” determined in step 6. If a marker is below this “-X dB down amplitude” value it shall be placed as close as possible to this value. The OBW is the positive frequency difference between the two markers.
9. Use the 99 % power bandwidth function of the spectrum analyzer and report the measured bandwidth.



3.7 Conducted Band Edge

3.7.1 Description of Conducted Band Edge Measurement

The power of any emission outside of the authorized operating frequency ranges must be lower than the transmitter power (P) by a factor of at least $43 + 10 \log (P)$ dB.

3.7.2 Test Procedures

1. The testing follows FCC KDB 971168 D01 v02r02 Section 6.0.
2. The EUT was connected to the spectrum analyzer and system simulator via a power divider.
3. The RF output of EUT was connected to the spectrum analyzer by an RF cable and attenuator. The path loss was compensated to the results for each measurement.
4. The band edges of low and high channels for the highest RF powers were measured.
5. The RF fundamental frequency should be excluded against the limit line in the operating frequency band.
6. The limit line is derived from $43 + 10\log(P)$ dB below the transmitter power P(Watts)



3.8 Conducted Spurious Emission

3.8.1 Description of Conducted Spurious Emission Measurement

The power of any emission outside of the authorized operating frequency ranges must be lower than the transmitter power (P) by a factor of at least $43 + 10 \log (P)$ dB.

It is measured by means of a calibrated spectrum analyzer and scanned from 30 MHz up to a frequency including its 10th harmonic.

3.8.2 Test Procedures

1. The testing follows FCC KDB 971168 D01 v02r02 Section 6.0.
2. The EUT was connected to the spectrum analyzer and system simulator via a power divider.
3. The RF output of EUT was connected to the spectrum analyzer by an RF cable and attenuator. The path loss was compensated to the results for each measurement.
4. The middle channel for the highest RF power within the transmitting frequency was measured.
5. The conducted spurious emission for the whole frequency range was taken.
6. The RF fundamental frequency should be excluded against the limit line in the operating frequency band.
7. The limit line is derived from $43 + 10\log(P)$ dB below the transmitter power P(Watts)



3.9 Frequency Stability

3.9.1 Description of Frequency Stability Measurement

The frequency stability shall be measured by variation of ambient temperature and variation of primary supply voltage to ensure that the fundamental emission stays within the authorized frequency block. The frequency stability of the transmitter shall be maintained within $\pm 0.00025\%$ ($\pm 2.5\text{ppm}$) of the center frequency.

3.9.2 Test Procedures for Temperature Variation

1. The testing follows FCC KDB 971168 D01 v02r02 Section 9.0.
2. The EUT was set up in the thermal chamber and connected with the system simulator.
3. With power OFF, the temperature was decreased to -30°C and the EUT was stabilized before testing. Power was applied and the maximum change in frequency was recorded within one minute.
4. With power OFF, the temperature was raised in 10°C steps up to 50°C . The EUT was stabilized at each step for at least half an hour. Power was applied and the maximum frequency change was recorded within one minute.

3.9.3 Test Procedures for Voltage Variation

1. The testing follows FCC KDB 971168 D01 v02r02 Section 9.0.
2. The EUT was placed in a temperature chamber at $20\pm 5^{\circ}\text{C}$ and connected with the system simulator.
3. The power supply voltage to the EUT was varied from 85% to 115% of the nominal value measured at the input to the EUT.
4. The variation in frequency was measured for the worst case.

4 Radiated Test Items

4.1 Measuring Instruments

See list of measuring instruments of this test report.

4.2 Test Setup

4.2.1 For radiated test from 30MHz to 1GHz

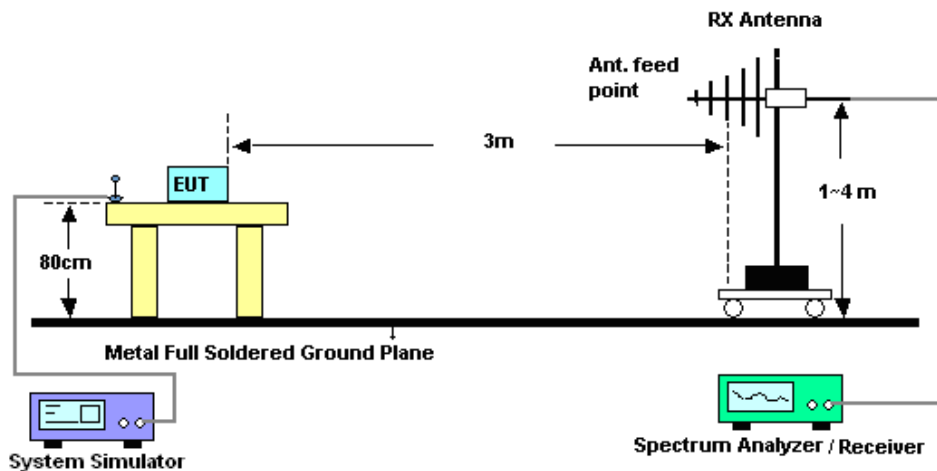

4.2.2 For radiated test above 1GHz

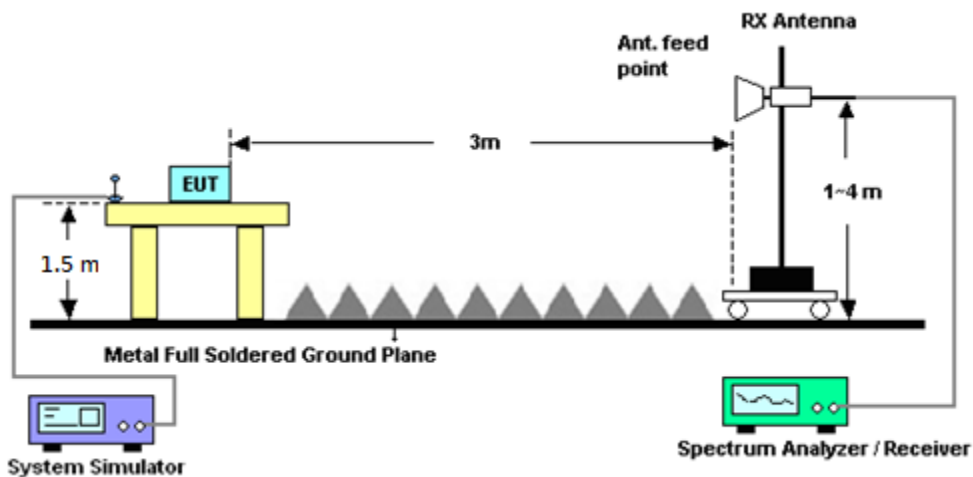

4.3 Test Result of Radiated Test

Please refer to Appendix B.



4.4 Field Strength of Spurious Radiation Measurement

4.4.1 Description of Field Strength of Spurious Radiated Measurement

The power of any emission outside of the authorized operating frequency ranges must be attenuated below the transmitter power (P) by a factor of at least $43 + 10 \log (P)$ dB. The spectrum is scanned from 30 MHz up to a frequency including its 10th harmonic.

4.4.2 Test Procedures

1. The testing follows FCC KDB 971168 D01 v02r02 Section 5.8 and ANSI / TIA-603-D-2010 Section 2.2.12.
2. The EUT was placed on a rotatable wooden table 0.8 meters for frequency below 1GHz and 1.5 meter for frequency above 1GHz above the ground.
3. The EUT was set 3 meters from the receiving antenna, which was mounted on the antenna tower.
4. The table was rotated 360 degrees to determine the position of the highest spurious emission.
5. The height of the receiving antenna is varied between one meter and four meters to search for the maximum spurious emission for both horizontal and vertical polarizations.
6. Make the measurement with the spectrum analyzer's RBW = 1MHz, VBW = 3MHz, taking record of maximum spurious emission.
7. A horn antenna was substituted in place of the EUT and was driven by a signal generator.
8. Tune the output power of signal generator to the same emission level with EUT maximum spurious emission.
9. Taking the record of output power at antenna port.
10. Repeat step 7 to step 8 for another polarization.
11. $EIRP \text{ (dBm)} = S.G. \text{ Power} - Tx \text{ Cable Loss} + Tx \text{ Antenna Gain}$
12. $ERP \text{ (dBm)} = EIRP - 2.15$
13. The RF fundamental frequency should be excluded against the limit line in the operating frequency band.
14. The limit line is derived from $43 + 10\log(P)$ dB below the transmitter power P(Watts)



5 List of Measuring Equipment

Instrument	Manufacturer	Model No.	Serial No.	Characteristics	Calibration Date	Test Date	Due Date	Remark
Spectrum Analyzer	Rohde & Schwarz	FSP30	101329	9kHz~30GHz	Jun. 26, 2017	Jul. 26, 2017 ~ Aug. 03, 2017	Jun. 25, 2018	Conducted (TH03-HY)
Temperature Chamber	ESPEC	SU-641	92013721	-30°C ~70°C	Nov. 16, 2016	Jul. 26, 2017 ~ Aug. 03, 2017	Nov. 15, 2017	Conducted (TH03-HY)
Programmable Power Supply	GW Instek	PSS-2005	EL883644	Voltage:0~20V;Current:0~5A	Nov. 22, 2016	Jul. 26, 2017 ~ Aug. 03, 2017	Nov. 21, 2017	Conducted (TH03-HY)
Base Station (Measure)	Rohde & Schwarz	CMU200	117997	GSM / GPRS / WCDMA / CDMA	Aug. 19, 2016	Jul. 26, 2017 ~ Aug. 03, 2017	Aug. 18, 2017	Conducted (TH03-HY)
Amplifier	MITEQ	TTA1840-35-HG	1871923	18GHz~40GHz, VSWR : 2.5:1 max	Jul. 18, 2017	Aug. 04, 2017 ~ Aug. 05, 2017	Jul. 17, 2018	Radiation (03CH11-HY)
Amplifier	SONOMA	310N	187312	9kHz~1GHz	Nov. 10, 2016	Aug. 04, 2017 ~ Aug. 05, 2017	Nov. 09, 2017	Radiation (03CH11-HY)
Bilog Antenna	TESEQ	CBL 6111D&N-6-06	35414&AT-N0602	30MHz~1GHz	Oct. 15, 2016	Aug. 04, 2017 ~ Aug. 05, 2017	Oct. 14, 2017	Radiation (03CH11-HY)
Horn Antenna	SCHWARZBECK	BBHA 9120 D	9120D-1326	1GHz ~ 18GHz	Oct. 07, 2016	Aug. 04, 2017 ~ Aug. 05, 2017	Oct. 06, 2017	Radiation (03CH11-HY)
Preamplifier	Keysight	83017A	MY53270080	1GHz~26.5GHz	Nov. 10, 2016	Aug. 04, 2017 ~ Aug. 05, 2017	Nov. 09, 2017	Radiation (03CH11-HY)
Preamplifier	MITEQ	AMF-7D-001 01800-30-10	1902247	1GHz~18GHz	Jun. 23, 2017	Aug. 04, 2017 ~ Aug. 05, 2017	Jun. 22, 2018	Radiation (03CH11-HY)
Spectrum Analyzer	Keysight	N9010A	MY54200486	10Hz ~ 44GHz	Oct. 12, 2016	Aug. 04, 2017 ~ Aug. 05, 2017	Oct. 11, 2017	Radiation (03CH11-HY)
Antenna Mast	EMEC	AM-BS-4500-B	N/A	1~4m	N/A	Aug. 04, 2017 ~ Aug. 05, 2017	N/A	Radiation (03CH11-HY)
Turn Table	EMEC	TT 2000	N/A	0~360 Degree	N/A	Aug. 04, 2017 ~ Aug. 05, 2017	N/A	Radiation (03CH11-HY)
SHF-EHF Horn Antenna	SCHWARZBECK	BBHA 9170	BBHA9170584	18GHz- 40GHz	Nov. 08, 2016	Aug. 04, 2017 ~ Aug. 05, 2017	Nov. 07, 2017	Radiation (03CH11-HY)



6 Uncertainty of Evaluation

Uncertainty of Radiated Emission Measurement (30 MHz ~ 1000 MHz)

Measuring Uncertainty for a Level of Confidence of 95% ($U = 2Uc(y)$)	3.37
---	------

Uncertainty of Radiated Emission Measurement (1 GHz ~ 18 GHz)

Measuring Uncertainty for a Level of Confidence of 95% ($U = 2Uc(y)$)	3.67
---	------

Uncertainty of Radiated Emission Measurement (18 GHz ~ 40 GHz)

Measuring Uncertainty for a Level of Confidence of 95% ($U = 2Uc(y)$)	4.03
---	------



Appendix A. Test Results of Conducted Test

Conducted Output Power(Average power)

Conducted Power (*Unit: dBm)						
Band	GSM850			GSM1900		
Channel	128	189	251	512	661	810
Frequency	824.2	836.4	848.8	1850.2	1880	1909.8
GSM	32.80	32.81	32.79	29.72	29.88	30.06
GPRS class 8	32.83	32.83	32.80	29.76	29.91	30.08
GPRS class 10	29.05	29.00	29.02	27.31	27.49	27.74
GPRS class 11	28.46	28.49	28.43	26.34	26.48	26.50
GPRS class 12	27.53	27.51	27.48	24.52	24.74	25.00
EGPRS class 8	25.88	25.86	25.82	24.43	24.54	24.59
EGPRS class 10	25.33	25.32	25.31	24.28	24.38	24.43
EGPRS class 11	25.15	25.12	25.10	23.56	23.72	23.80
EGPRS class 12	24.94	24.94	24.90	23.38	23.51	23.52

Conducted Power (*Unit: dBm)						
Band	WCDMA Band V			WCDMA Band II		
Channel	4132	4182	4233	9262	9400	9538
Frequency	826.4	836.4	846.6	1852.4	1880	1907.6
RMC 12.2K	23.33	23.29	23.35	22.72	22.66	22.98
HSDPA Subtest-1	22.38	22.36	22.42	21.57	21.69	21.79
HSDPA Subtest-2	22.46	22.31	22.39	21.57	21.64	21.76
HSDPA Subtest-3	21.96	21.79	21.93	21.09	21.16	21.30
HSDPA Subtest-4	21.94	21.82	21.92	21.12	21.23	21.30
HSUPA Subtest-1	20.42	20.29	20.40	20.05	20.05	20.02
HSUPA Subtest-2	20.42	20.31	20.42	19.69	19.71	19.85
HSUPA Subtest-3	21.44	21.34	21.42	20.70	20.77	20.88
HSUPA Subtest-4	20.06	19.86	19.95	19.22	19.30	19.35
HSUPA Subtest-5	21.42	21.36	21.43	20.65	20.65	20.85



Conducted Power (*Unit: dBm)			
Band	WCDMA Band IV		
Channel	1312	1413	1513
Frequency	1712.4	1732.6	1752.6
RMC 12.2K	23.90	23.96	24.00
HSDPA Subtest-1	22.86	22.98	22.99
HSDPA Subtest-2	22.80	22.94	22.96
HSDPA Subtest-3	22.28	22.46	22.45
HSDPA Subtest-4	22.32	22.48	22.46
HSUPA Subtest-1	21.50	21.68	21.65
HSUPA Subtest-2	20.81	21.00	20.93
HSUPA Subtest-3	21.81	21.96	21.99
HSUPA Subtest-4	20.30	20.59	20.55
HSUPA Subtest-5	21.85	22.05	21.97



A1. GSM

Peak-to-Average Ratio

Mode	GSM850		Limit: 13dB
Mod.	GPRS class 8	EDGE class 8	Result
Lowest CH	0.20	3.24	PASS
Middle CH	0.20	3.32	
Highest CH	0.24	3.44	

Mode	GSM1900		Limit: 13dB
Mod.	GPRS class 8	EDGE class 8	Result
Lowest CH	0.24	3.40	PASS
Middle CH	0.20	3.52	
Highest CH	0.24	3.36	



GSM850 (GPRS class 8)	GSM850 (EDGE class 8)
<p align="center">Lowest Channel</p> <p align="center">Complementary Cumulative Distribution Function (100000 samples) Trace 1</p> <p>Mean 31.82 dBm Peak 32.08 dBm Crest 0.26 dB</p> <p>10 % 0.20 dB 1 % 0.20 dB .1 % 0.20 dB .01 % 0.24 dB</p> <p>Date: 26.JUL.2017 17:30:10</p>	<p align="center">Lowest Channel</p> <p align="center">Complementary Cumulative Distribution Function (100000 samples) Trace 1</p> <p>Mean 27.01 dBm Peak 30.38 dBm Crest 3.37 dB</p> <p>10 % 2.56 dB 1 % 3.12 dB .1 % 3.24 dB .01 % 3.32 dB</p> <p>Date: 3.AUG.2017 14:28:54</p>
<p align="center">Middle Channel</p> <p align="center">Complementary Cumulative Distribution Function (100000 samples) Trace 1</p> <p>Mean 31.88 dBm Peak 32.15 dBm Crest 0.27 dB</p> <p>10 % 0.20 dB 1 % 0.20 dB .1 % 0.20 dB .01 % 0.20 dB</p> <p>Date: 26.JUL.2017 17:30:27</p>	<p align="center">Middle Channel</p> <p align="center">Complementary Cumulative Distribution Function (100000 samples) Trace 1</p> <p>Mean 26.83 dBm Peak 30.17 dBm Crest 3.34 dB</p> <p>10 % 2.56 dB 1 % 3.16 dB .1 % 3.32 dB .01 % 3.36 dB</p> <p>Date: 3.AUG.2017 14:29:08</p>
<p align="center">Highest Channel</p> <p align="center">Complementary Cumulative Distribution Function (100000 samples) Trace 1</p> <p>Mean 31.93 dBm Peak 32.15 dBm Crest 0.22 dB</p> <p>10 % 0.20 dB 1 % 0.24 dB .1 % 0.24 dB .01 % 0.24 dB</p> <p>Date: 26.JUL.2017 17:30:44</p>	<p align="center">Highest Channel</p> <p align="center">Complementary Cumulative Distribution Function (100000 samples) Trace 1</p> <p>Mean 26.72 dBm Peak 30.24 dBm Crest 3.52 dB</p> <p>10 % 2.64 dB 1 % 3.24 dB .1 % 3.44 dB .01 % 3.48 dB</p> <p>Date: 3.AUG.2017 14:29:22</p>



GSM1900 (GPRS class 8)	GSM1900 (EDGE class 8)
<p align="center">Lowest Channel</p> <p align="center">Date: 3.AUG.2017 14:46:30</p>	<p align="center">Lowest Channel</p> <p align="center">Date: 3.AUG.2017 15:19:21</p>
<p align="center">Middle Channel</p> <p align="center">Date: 3.AUG.2017 14:46:43</p>	<p align="center">Middle Channel</p> <p align="center">Date: 3.AUG.2017 15:19:40</p>
<p align="center">Highest Channel</p> <p align="center">Date: 3.AUG.2017 14:47:04</p>	<p align="center">Highest Channel</p> <p align="center">Date: 3.AUG.2017 15:19:55</p>



26dB Bandwidth

Mode	GSM850	
Mod.	GPRS class 8	EDGE class 8
Lowest CH	0.302	0.294
Middle CH	0.315	0.299
Highest CH	0.311	0.310

Mode	GSM1900	
Mod.	GPRS class 8	EDGE class 8
Lowest CH	0.302	0.308
Middle CH	0.311	0.302
Highest CH	0.313	0.313

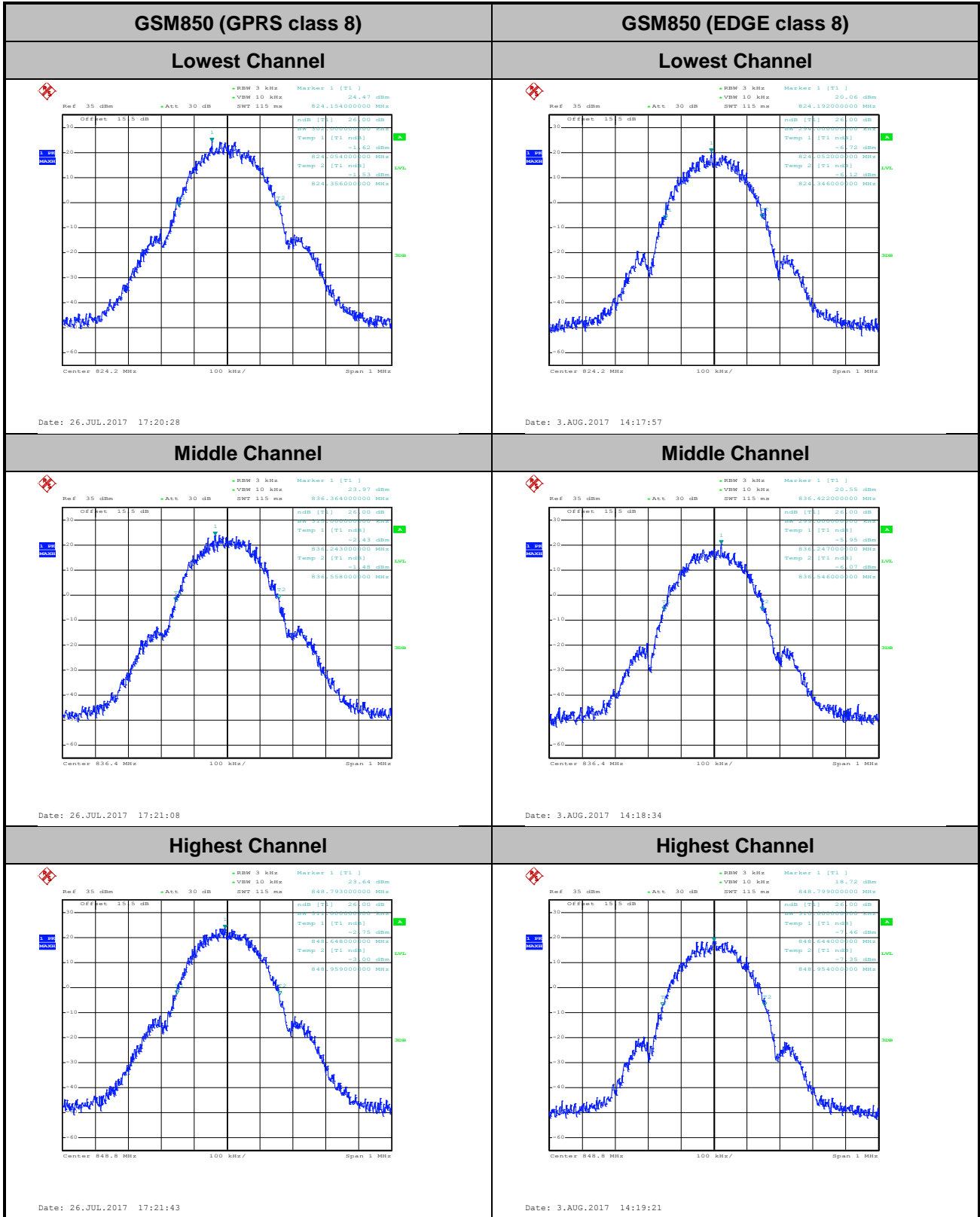

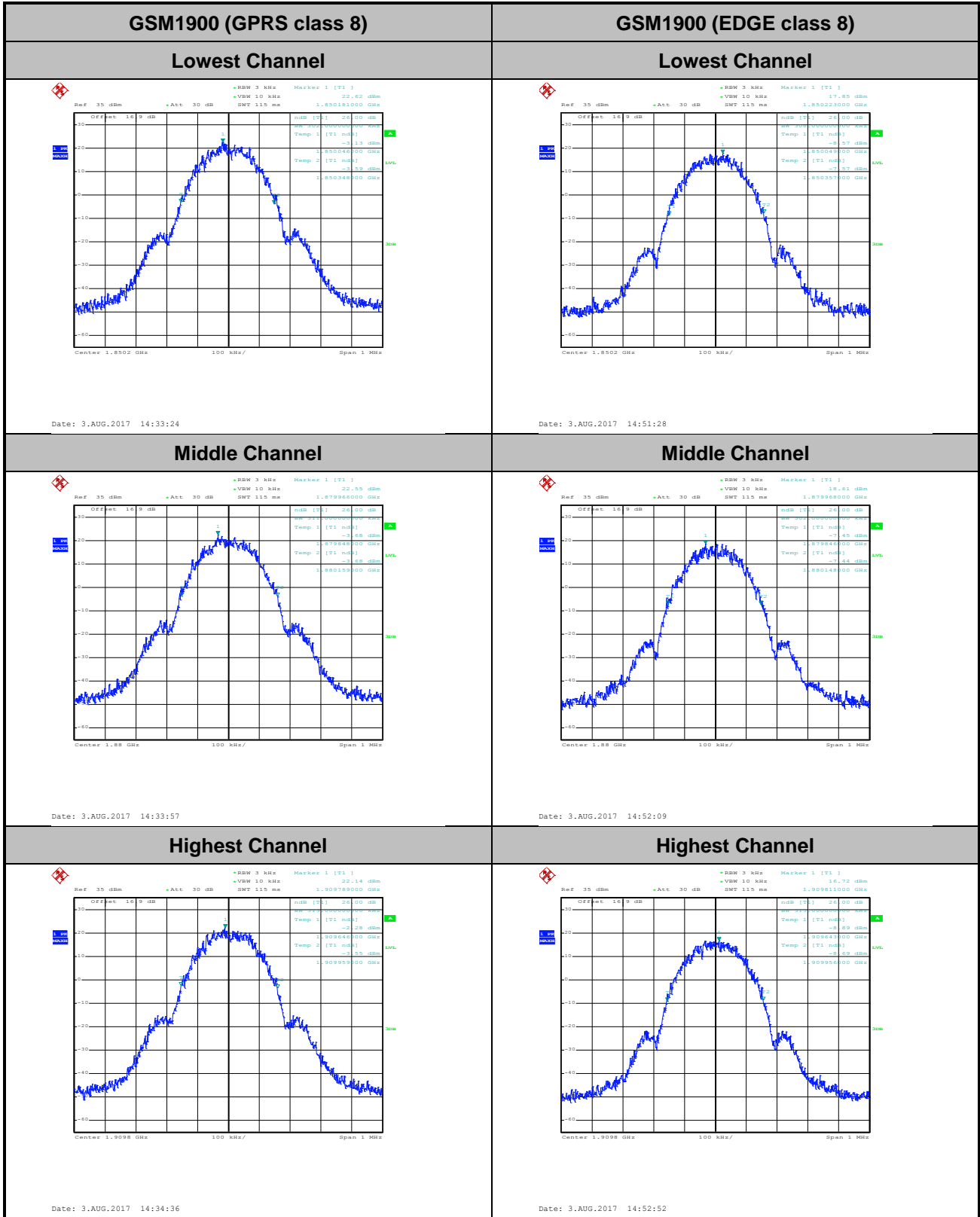



Occupied Bandwidth

Mode	GSM850	
Mod.	GPRS class 8	EDGE class 8
Lowest CH	0.245	0.248
Middle CH	0.244	0.248
Highest CH	0.244	0.246

Mode	GSM1900	
Mod.	GPRS class 8	EDGE class 8
Lowest CH	0.244	0.248
Middle CH	0.242	0.251
Highest CH	0.249	0.251

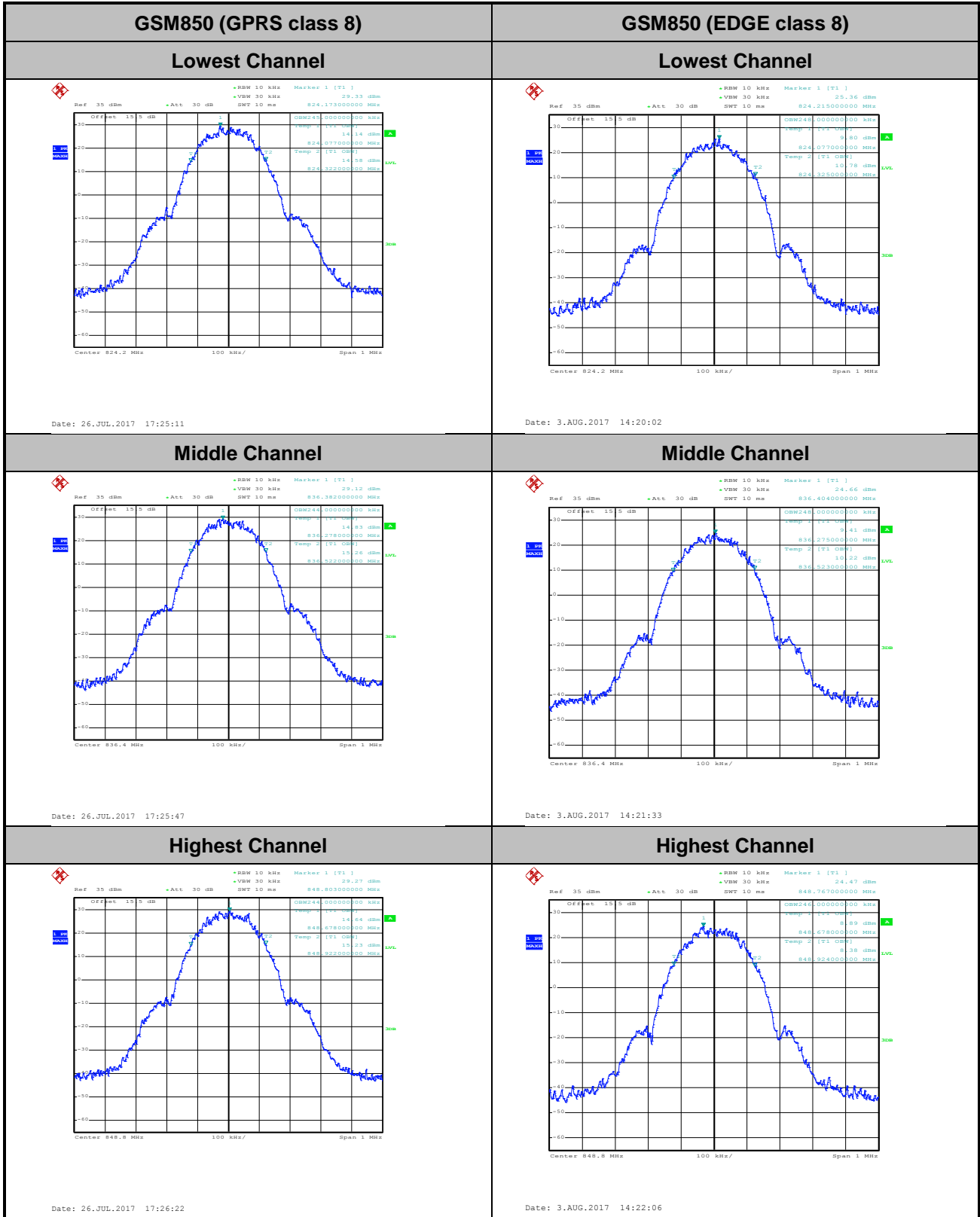

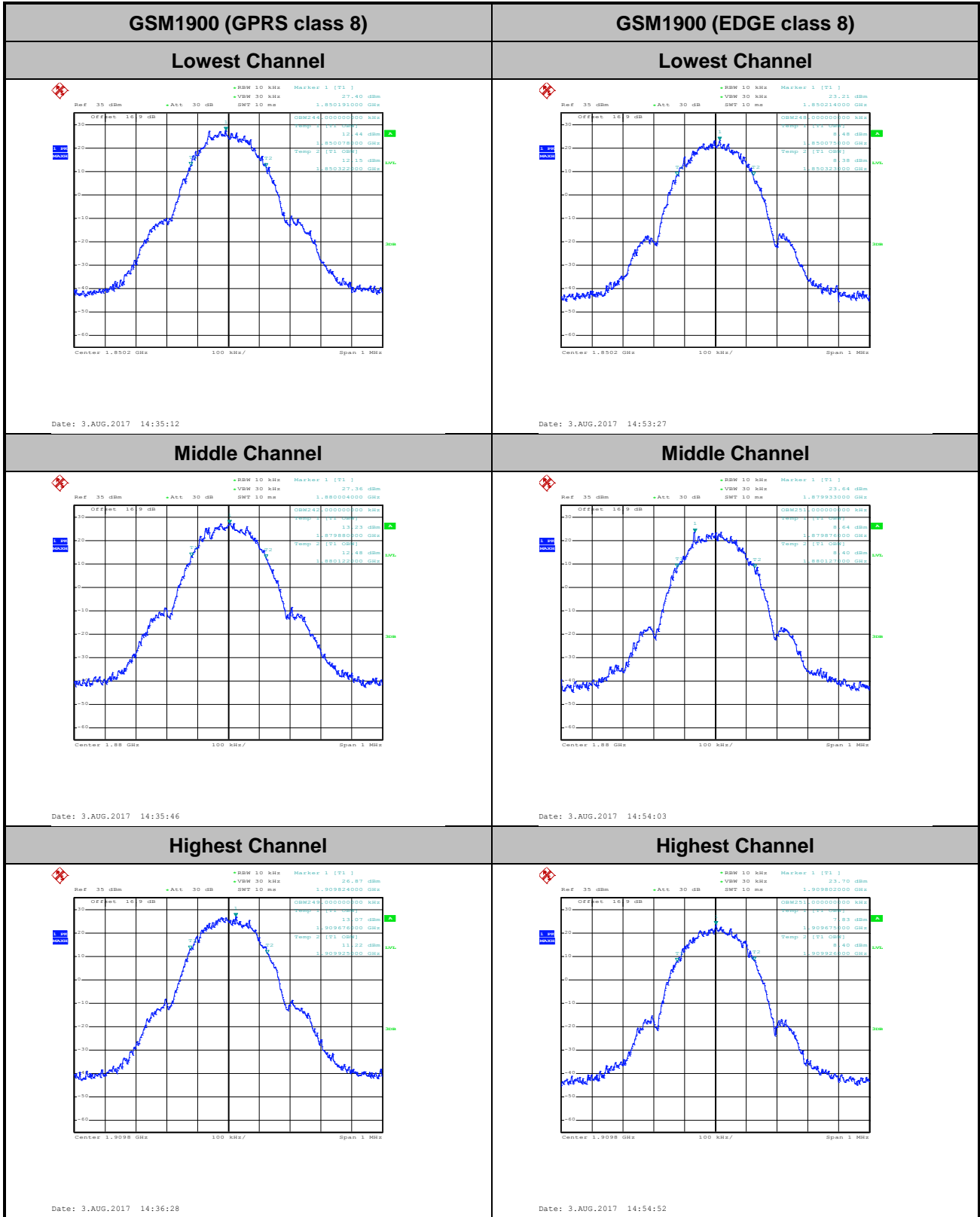



Conducted Band Edge



GSM850 (GPRS class 8)

Lowest Band Edge

Highest Band Edge

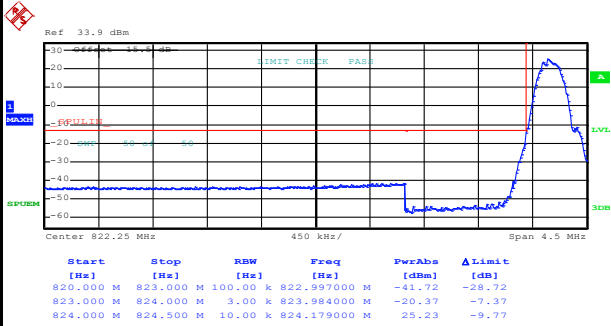

Date: 26.JUL.2017 17:27:57

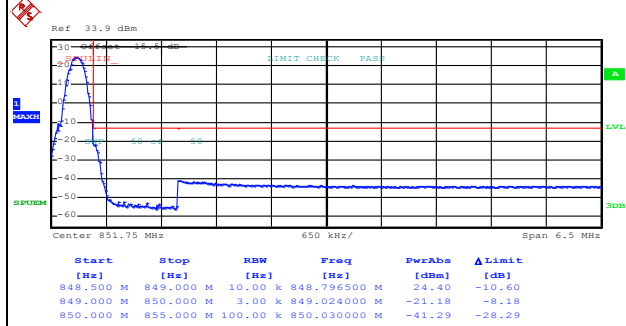

Date: 26.JUL.2017 17:29:45

GSM850 (EDGE class 8)

Lowest Band Edge

Highest Band Edge

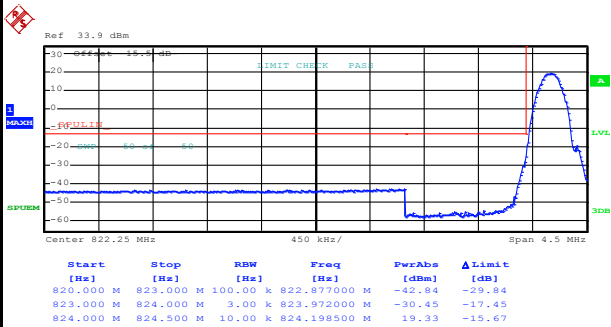

Date: 3.AUG.2017 14:24:09

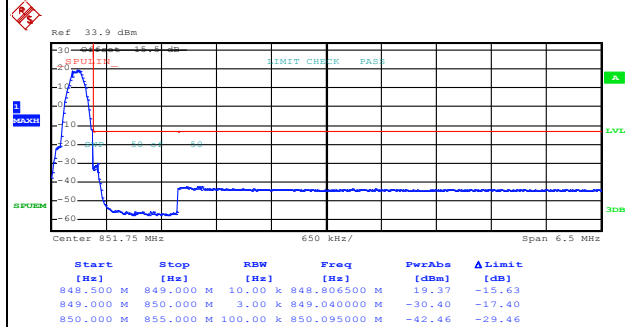

Date: 3.AUG.2017 14:25:41



GSM1900 (GPRS class 8)

Lowest Band Edge

Highest Band Edge

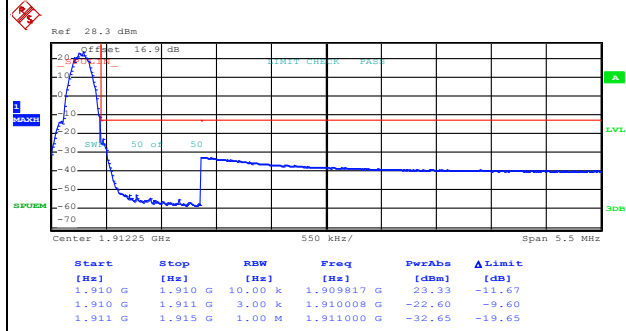
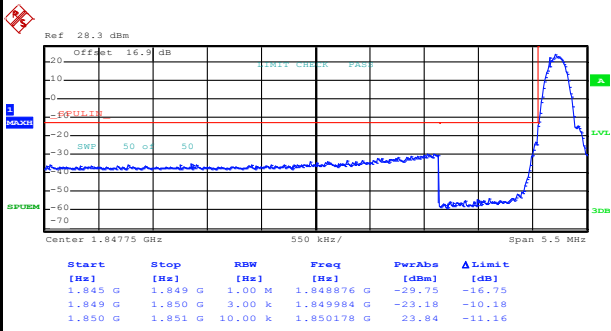

Date: 3.AUG.2017 14:38:02

Date: 3.AUG.2017 14:39:33

GSM1900 (EDGE class 8)

Lowest Band Edge

Highest Band Edge

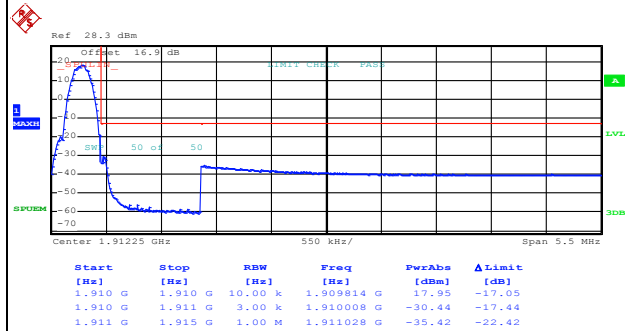
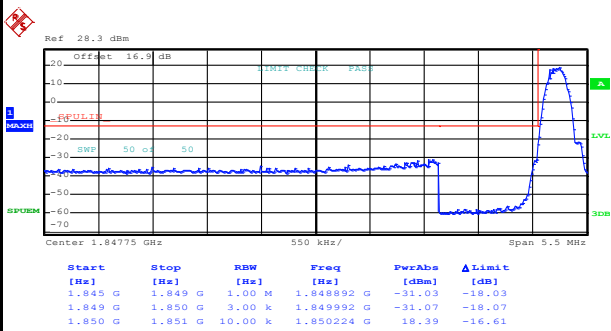

Date: 3.AUG.2017 15:00:33

Date: 3.AUG.2017 15:09:32



Conducted Spurious Emission

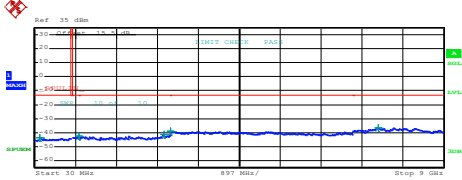
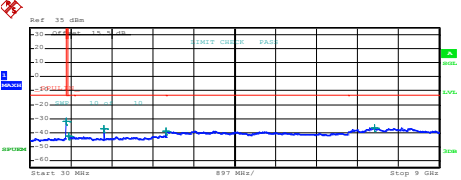
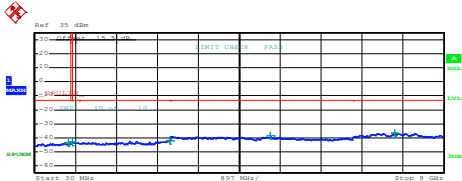
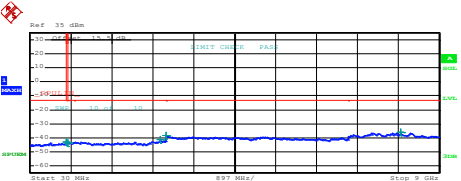
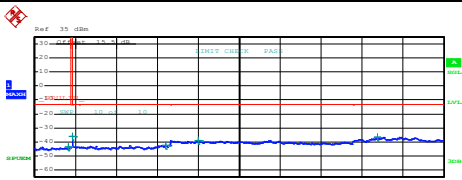
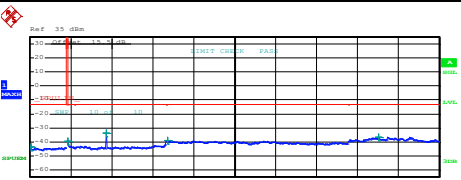

GSM850 (GPRS class 8)	GSM850 (EDGE class 8)																																																																								
Lowest Channel	Lowest Channel																																																																								
 <table border="1" data-bbox="239 577 638 660"> <thead> <tr> <th>Start [Hz]</th> <th>Stop [Hz]</th> <th>RBW [Hz]</th> <th>Freq [Hz]</th> <th>PwrAve [dBm]</th> <th>ΔLimit [dB]</th> </tr> </thead> <tbody> <tr> <td>35,000 M</td> <td>825,000 M</td> <td>1,00 M</td> <td>133,200000 M</td> <td>-43.92</td> <td>-30.92</td> </tr> <tr> <td>855,000 M</td> <td>1,000 G</td> <td>1,00 G</td> <td>994,997510 M</td> <td>-42.74</td> <td>-29.74</td> </tr> <tr> <td>1,000 G</td> <td>3,000 G</td> <td>1,00 M</td> <td>2,1805000 G</td> <td>-42.94</td> <td>-28.94</td> </tr> <tr> <td>3,000 G</td> <td>7,000 G</td> <td>1,00 M</td> <td>3,0030000 G</td> <td>-39.11</td> <td>-26.11</td> </tr> <tr> <td>7,000 G</td> <td>9,000 G</td> <td>1,00 M</td> <td>7,5630000 G</td> <td>-36.56</td> <td>-23.56</td> </tr> </tbody> </table> <p>Date: 26.JUL.2017 17:22:41</p>	Start [Hz]	Stop [Hz]	RBW [Hz]	Freq [Hz]	PwrAve [dBm]	ΔLimit [dB]	35,000 M	825,000 M	1,00 M	133,200000 M	-43.92	-30.92	855,000 M	1,000 G	1,00 G	994,997510 M	-42.74	-29.74	1,000 G	3,000 G	1,00 M	2,1805000 G	-42.94	-28.94	3,000 G	7,000 G	1,00 M	3,0030000 G	-39.11	-26.11	7,000 G	9,000 G	1,00 M	7,5630000 G	-36.56	-23.56	 <table border="1" data-bbox="893 577 1292 660"> <thead> <tr> <th>Start [Hz]</th> <th>Stop [Hz]</th> <th>RBW [Hz]</th> <th>Freq [Hz]</th> <th>PwrAve [dBm]</th> <th>ΔLimit [dB]</th> </tr> </thead> <tbody> <tr> <td>35,000 M</td> <td>825,000 M</td> <td>1,00 M</td> <td>819,825000 M</td> <td>-41.92</td> <td>-30.92</td> </tr> <tr> <td>855,000 M</td> <td>1,000 G</td> <td>1,00 M</td> <td>871,022501 M</td> <td>-42.73</td> <td>-29.73</td> </tr> <tr> <td>1,000 G</td> <td>3,000 G</td> <td>1,00 M</td> <td>1,6490000 G</td> <td>-36.98</td> <td>-23.98</td> </tr> <tr> <td>3,000 G</td> <td>7,000 G</td> <td>1,00 M</td> <td>3,0080000 G</td> <td>-38.85</td> <td>-25.85</td> </tr> <tr> <td>7,000 G</td> <td>9,000 G</td> <td>1,00 M</td> <td>7,5750000 G</td> <td>-36.38</td> <td>-23.38</td> </tr> </tbody> </table> <p>Date: 3.AUG.2017 14:26:36</p>	Start [Hz]	Stop [Hz]	RBW [Hz]	Freq [Hz]	PwrAve [dBm]	ΔLimit [dB]	35,000 M	825,000 M	1,00 M	819,825000 M	-41.92	-30.92	855,000 M	1,000 G	1,00 M	871,022501 M	-42.73	-29.73	1,000 G	3,000 G	1,00 M	1,6490000 G	-36.98	-23.98	3,000 G	7,000 G	1,00 M	3,0080000 G	-38.85	-25.85	7,000 G	9,000 G	1,00 M	7,5750000 G	-36.38	-23.38
Start [Hz]	Stop [Hz]	RBW [Hz]	Freq [Hz]	PwrAve [dBm]	ΔLimit [dB]																																																																				
35,000 M	825,000 M	1,00 M	133,200000 M	-43.92	-30.92																																																																				
855,000 M	1,000 G	1,00 G	994,997510 M	-42.74	-29.74																																																																				
1,000 G	3,000 G	1,00 M	2,1805000 G	-42.94	-28.94																																																																				
3,000 G	7,000 G	1,00 M	3,0030000 G	-39.11	-26.11																																																																				
7,000 G	9,000 G	1,00 M	7,5630000 G	-36.56	-23.56																																																																				
Start [Hz]	Stop [Hz]	RBW [Hz]	Freq [Hz]	PwrAve [dBm]	ΔLimit [dB]																																																																				
35,000 M	825,000 M	1,00 M	819,825000 M	-41.92	-30.92																																																																				
855,000 M	1,000 G	1,00 M	871,022501 M	-42.73	-29.73																																																																				
1,000 G	3,000 G	1,00 M	1,6490000 G	-36.98	-23.98																																																																				
3,000 G	7,000 G	1,00 M	3,0080000 G	-38.85	-25.85																																																																				
7,000 G	9,000 G	1,00 M	7,5750000 G	-36.38	-23.38																																																																				
Middle Channel	Middle Channel																																																																								
 <table border="1" data-bbox="239 1093 638 1176"> <thead> <tr> <th>Start [Hz]</th> <th>Stop [Hz]</th> <th>RBW [Hz]</th> <th>Freq [Hz]</th> <th>PwrAve [dBm]</th> <th>ΔLimit [dB]</th> </tr> </thead> <tbody> <tr> <td>35,000 M</td> <td>825,000 M</td> <td>1,00 M</td> <td>773,982500 M</td> <td>-43.64</td> <td>-30.64</td> </tr> <tr> <td>855,000 M</td> <td>1,000 G</td> <td>1,00 M</td> <td>862,223251 M</td> <td>-42.99</td> <td>-29.99</td> </tr> <tr> <td>1,000 G</td> <td>3,000 G</td> <td>1,00 M</td> <td>2,9865000 G</td> <td>-41.64</td> <td>-28.64</td> </tr> <tr> <td>3,000 G</td> <td>7,000 G</td> <td>1,00 M</td> <td>3,1900000 G</td> <td>-38.61</td> <td>-25.61</td> </tr> <tr> <td>7,000 G</td> <td>9,000 G</td> <td>1,00 M</td> <td>7,9270000 G</td> <td>-36.93</td> <td>-23.93</td> </tr> </tbody> </table> <p>Date: 26.JUL.2017 17:23:36</p>	Start [Hz]	Stop [Hz]	RBW [Hz]	Freq [Hz]	PwrAve [dBm]	ΔLimit [dB]	35,000 M	825,000 M	1,00 M	773,982500 M	-43.64	-30.64	855,000 M	1,000 G	1,00 M	862,223251 M	-42.99	-29.99	1,000 G	3,000 G	1,00 M	2,9865000 G	-41.64	-28.64	3,000 G	7,000 G	1,00 M	3,1900000 G	-38.61	-25.61	7,000 G	9,000 G	1,00 M	7,9270000 G	-36.93	-23.93	 <table border="1" data-bbox="893 1093 1292 1176"> <thead> <tr> <th>Start [Hz]</th> <th>Stop [Hz]</th> <th>RBW [Hz]</th> <th>Freq [Hz]</th> <th>PwrAve [dBm]</th> <th>ΔLimit [dB]</th> </tr> </thead> <tbody> <tr> <td>35,000 M</td> <td>825,000 M</td> <td>1,00 M</td> <td>817,630000 M</td> <td>-43.01</td> <td>-30.01</td> </tr> <tr> <td>855,000 M</td> <td>1,000 G</td> <td>1,00 M</td> <td>808,232250 M</td> <td>-43.82</td> <td>-30.82</td> </tr> <tr> <td>1,000 G</td> <td>3,000 G</td> <td>1,00 M</td> <td>2,8805000 G</td> <td>-41.38</td> <td>-28.38</td> </tr> <tr> <td>3,000 G</td> <td>7,000 G</td> <td>1,00 M</td> <td>3,0000000 G</td> <td>-38.16</td> <td>-25.16</td> </tr> <tr> <td>7,000 G</td> <td>9,000 G</td> <td>1,00 M</td> <td>8,1630000 G</td> <td>-36.88</td> <td>-23.88</td> </tr> </tbody> </table> <p>Date: 3.AUG.2017 14:27:24</p>	Start [Hz]	Stop [Hz]	RBW [Hz]	Freq [Hz]	PwrAve [dBm]	ΔLimit [dB]	35,000 M	825,000 M	1,00 M	817,630000 M	-43.01	-30.01	855,000 M	1,000 G	1,00 M	808,232250 M	-43.82	-30.82	1,000 G	3,000 G	1,00 M	2,8805000 G	-41.38	-28.38	3,000 G	7,000 G	1,00 M	3,0000000 G	-38.16	-25.16	7,000 G	9,000 G	1,00 M	8,1630000 G	-36.88	-23.88
Start [Hz]	Stop [Hz]	RBW [Hz]	Freq [Hz]	PwrAve [dBm]	ΔLimit [dB]																																																																				
35,000 M	825,000 M	1,00 M	773,982500 M	-43.64	-30.64																																																																				
855,000 M	1,000 G	1,00 M	862,223251 M	-42.99	-29.99																																																																				
1,000 G	3,000 G	1,00 M	2,9865000 G	-41.64	-28.64																																																																				
3,000 G	7,000 G	1,00 M	3,1900000 G	-38.61	-25.61																																																																				
7,000 G	9,000 G	1,00 M	7,9270000 G	-36.93	-23.93																																																																				
Start [Hz]	Stop [Hz]	RBW [Hz]	Freq [Hz]	PwrAve [dBm]	ΔLimit [dB]																																																																				
35,000 M	825,000 M	1,00 M	817,630000 M	-43.01	-30.01																																																																				
855,000 M	1,000 G	1,00 M	808,232250 M	-43.82	-30.82																																																																				
1,000 G	3,000 G	1,00 M	2,8805000 G	-41.38	-28.38																																																																				
3,000 G	7,000 G	1,00 M	3,0000000 G	-38.16	-25.16																																																																				
7,000 G	9,000 G	1,00 M	8,1630000 G	-36.88	-23.88																																																																				
Highest Channel	Highest Channel																																																																								
 <table border="1" data-bbox="239 1608 638 1691"> <thead> <tr> <th>Start [Hz]</th> <th>Stop [Hz]</th> <th>RBW [Hz]</th> <th>Freq [Hz]</th> <th>PwrAve [dBm]</th> <th>ΔLimit [dB]</th> </tr> </thead> <tbody> <tr> <td>35,000 M</td> <td>825,000 M</td> <td>1,00 M</td> <td>769,830000 M</td> <td>-43.73</td> <td>-30.73</td> </tr> <tr> <td>855,000 M</td> <td>1,000 G</td> <td>1,00 M</td> <td>855,036250 M</td> <td>-35.92</td> <td>-22.92</td> </tr> <tr> <td>1,000 G</td> <td>3,000 G</td> <td>1,00 M</td> <td>2,9025000 G</td> <td>-42.20</td> <td>-29.20</td> </tr> <tr> <td>3,000 G</td> <td>7,000 G</td> <td>1,00 M</td> <td>3,1618000 G</td> <td>-39.07</td> <td>-26.07</td> </tr> <tr> <td>7,000 G</td> <td>9,000 G</td> <td>1,00 M</td> <td>7,5380000 G</td> <td>-36.79</td> <td>-23.79</td> </tr> </tbody> </table> <p>Date: 26.JUL.2017 17:24:28</p>	Start [Hz]	Stop [Hz]	RBW [Hz]	Freq [Hz]	PwrAve [dBm]	ΔLimit [dB]	35,000 M	825,000 M	1,00 M	769,830000 M	-43.73	-30.73	855,000 M	1,000 G	1,00 M	855,036250 M	-35.92	-22.92	1,000 G	3,000 G	1,00 M	2,9025000 G	-42.20	-29.20	3,000 G	7,000 G	1,00 M	3,1618000 G	-39.07	-26.07	7,000 G	9,000 G	1,00 M	7,5380000 G	-36.79	-23.79	 <table border="1" data-bbox="893 1608 1292 1691"> <thead> <tr> <th>Start [Hz]</th> <th>Stop [Hz]</th> <th>RBW [Hz]</th> <th>Freq [Hz]</th> <th>PwrAve [dBm]</th> <th>ΔLimit [dB]</th> </tr> </thead> <tbody> <tr> <td>35,000 M</td> <td>825,000 M</td> <td>1,00 M</td> <td>56,652500 M</td> <td>-43.87</td> <td>-30.87</td> </tr> <tr> <td>855,000 M</td> <td>1,000 G</td> <td>1,00 M</td> <td>855,036250 M</td> <td>-39.61</td> <td>-26.61</td> </tr> <tr> <td>1,000 G</td> <td>3,000 G</td> <td>1,00 M</td> <td>1,6975000 G</td> <td>-33.62</td> <td>-20.62</td> </tr> <tr> <td>3,000 G</td> <td>7,000 G</td> <td>1,00 M</td> <td>3,0370000 G</td> <td>-39.05</td> <td>-26.05</td> </tr> <tr> <td>7,000 G</td> <td>9,000 G</td> <td>1,00 M</td> <td>7,6795000 G</td> <td>-36.82</td> <td>-23.82</td> </tr> </tbody> </table> <p>Date: 3.AUG.2017 14:28:15</p>	Start [Hz]	Stop [Hz]	RBW [Hz]	Freq [Hz]	PwrAve [dBm]	ΔLimit [dB]	35,000 M	825,000 M	1,00 M	56,652500 M	-43.87	-30.87	855,000 M	1,000 G	1,00 M	855,036250 M	-39.61	-26.61	1,000 G	3,000 G	1,00 M	1,6975000 G	-33.62	-20.62	3,000 G	7,000 G	1,00 M	3,0370000 G	-39.05	-26.05	7,000 G	9,000 G	1,00 M	7,6795000 G	-36.82	-23.82
Start [Hz]	Stop [Hz]	RBW [Hz]	Freq [Hz]	PwrAve [dBm]	ΔLimit [dB]																																																																				
35,000 M	825,000 M	1,00 M	769,830000 M	-43.73	-30.73																																																																				
855,000 M	1,000 G	1,00 M	855,036250 M	-35.92	-22.92																																																																				
1,000 G	3,000 G	1,00 M	2,9025000 G	-42.20	-29.20																																																																				
3,000 G	7,000 G	1,00 M	3,1618000 G	-39.07	-26.07																																																																				
7,000 G	9,000 G	1,00 M	7,5380000 G	-36.79	-23.79																																																																				
Start [Hz]	Stop [Hz]	RBW [Hz]	Freq [Hz]	PwrAve [dBm]	ΔLimit [dB]																																																																				
35,000 M	825,000 M	1,00 M	56,652500 M	-43.87	-30.87																																																																				
855,000 M	1,000 G	1,00 M	855,036250 M	-39.61	-26.61																																																																				
1,000 G	3,000 G	1,00 M	1,6975000 G	-33.62	-20.62																																																																				
3,000 G	7,000 G	1,00 M	3,0370000 G	-39.05	-26.05																																																																				
7,000 G	9,000 G	1,00 M	7,6795000 G	-36.82	-23.82																																																																				

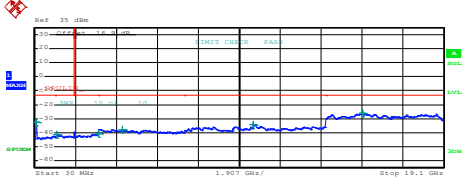
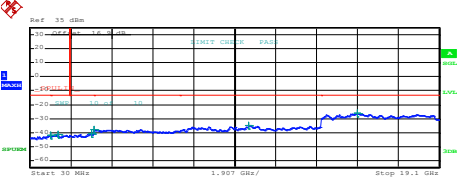
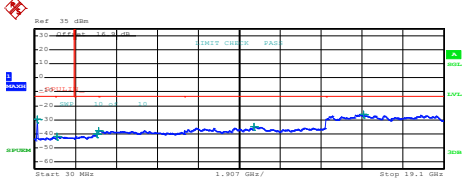
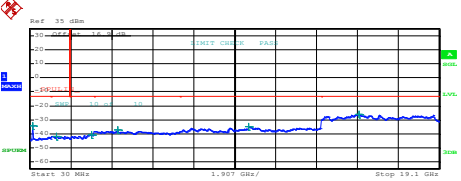
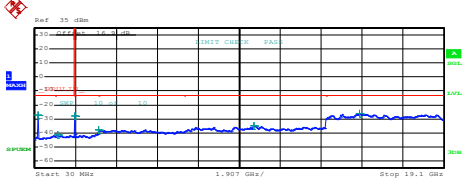
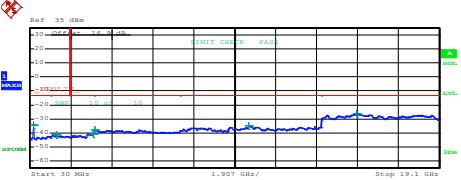

GSM1900 (GPRS class 8)	GSM1900 (EDGE class 8)																																																																																				
Lowest Channel	Lowest Channel																																																																																				
 <table border="1" data-bbox="239 577 638 672"> <thead> <tr> <th>Start [MHz]</th> <th>Stop [MHz]</th> <th>RBW [Hz]</th> <th>Freq [MHz]</th> <th>PwrAve [dBm]</th> <th>ΔLimit [dB]</th> </tr> </thead> <tbody> <tr><td>30.0000</td><td>1.0000</td><td>1.000</td><td>111.965000</td><td>-32.57</td><td>-19.57</td></tr> <tr><td>1.0000</td><td>1.8450</td><td>1.000</td><td>1.049010</td><td>-41.29</td><td>-28.29</td></tr> <tr><td>1.8450</td><td>3.0000</td><td>1.000</td><td>2.095218</td><td>-40.24</td><td>-27.24</td></tr> <tr><td>3.0000</td><td>7.0000</td><td>1.000</td><td>4.094000</td><td>-37.70</td><td>-24.70</td></tr> <tr><td>7.0000</td><td>13.6000</td><td>1.000</td><td>10.217900</td><td>-34.05</td><td>-21.05</td></tr> <tr><td>13.6000</td><td>19.1000</td><td>1.000</td><td>15.320325</td><td>-26.38</td><td>-13.38</td></tr> </tbody> </table> <p>Date: 3.AUG.2017 14:40:25</p>	Start [MHz]	Stop [MHz]	RBW [Hz]	Freq [MHz]	PwrAve [dBm]	ΔLimit [dB]	30.0000	1.0000	1.000	111.965000	-32.57	-19.57	1.0000	1.8450	1.000	1.049010	-41.29	-28.29	1.8450	3.0000	1.000	2.095218	-40.24	-27.24	3.0000	7.0000	1.000	4.094000	-37.70	-24.70	7.0000	13.6000	1.000	10.217900	-34.05	-21.05	13.6000	19.1000	1.000	15.320325	-26.38	-13.38	 <table border="1" data-bbox="893 577 1292 672"> <thead> <tr> <th>Start [MHz]</th> <th>Stop [MHz]</th> <th>RBW [Hz]</th> <th>Freq [MHz]</th> <th>PwrAve [dBm]</th> <th>ΔLimit [dB]</th> </tr> </thead> <tbody> <tr><td>30.0000</td><td>1.0000</td><td>1.000</td><td>996.847500</td><td>-41.78</td><td>-28.78</td></tr> <tr><td>1.0000</td><td>1.8450</td><td>1.000</td><td>1.325114</td><td>-41.17</td><td>-28.17</td></tr> <tr><td>1.8450</td><td>3.0000</td><td>1.000</td><td>2.882820</td><td>-40.84</td><td>-27.84</td></tr> <tr><td>3.0000</td><td>7.0000</td><td>1.000</td><td>3.005000</td><td>-37.70</td><td>-24.70</td></tr> <tr><td>7.0000</td><td>13.6000</td><td>1.000</td><td>10.224925</td><td>-34.77</td><td>-21.77</td></tr> <tr><td>13.6000</td><td>19.1000</td><td>1.000</td><td>15.289388</td><td>-26.05</td><td>-13.05</td></tr> </tbody> </table> <p>Date: 3.AUG.2017 15:10:34</p>	Start [MHz]	Stop [MHz]	RBW [Hz]	Freq [MHz]	PwrAve [dBm]	ΔLimit [dB]	30.0000	1.0000	1.000	996.847500	-41.78	-28.78	1.0000	1.8450	1.000	1.325114	-41.17	-28.17	1.8450	3.0000	1.000	2.882820	-40.84	-27.84	3.0000	7.0000	1.000	3.005000	-37.70	-24.70	7.0000	13.6000	1.000	10.224925	-34.77	-21.77	13.6000	19.1000	1.000	15.289388	-26.05	-13.05
Start [MHz]	Stop [MHz]	RBW [Hz]	Freq [MHz]	PwrAve [dBm]	ΔLimit [dB]																																																																																
30.0000	1.0000	1.000	111.965000	-32.57	-19.57																																																																																
1.0000	1.8450	1.000	1.049010	-41.29	-28.29																																																																																
1.8450	3.0000	1.000	2.095218	-40.24	-27.24																																																																																
3.0000	7.0000	1.000	4.094000	-37.70	-24.70																																																																																
7.0000	13.6000	1.000	10.217900	-34.05	-21.05																																																																																
13.6000	19.1000	1.000	15.320325	-26.38	-13.38																																																																																
Start [MHz]	Stop [MHz]	RBW [Hz]	Freq [MHz]	PwrAve [dBm]	ΔLimit [dB]																																																																																
30.0000	1.0000	1.000	996.847500	-41.78	-28.78																																																																																
1.0000	1.8450	1.000	1.325114	-41.17	-28.17																																																																																
1.8450	3.0000	1.000	2.882820	-40.84	-27.84																																																																																
3.0000	7.0000	1.000	3.005000	-37.70	-24.70																																																																																
7.0000	13.6000	1.000	10.224925	-34.77	-21.77																																																																																
13.6000	19.1000	1.000	15.289388	-26.05	-13.05																																																																																
Middle Channel	Middle Channel																																																																																				
 <table border="1" data-bbox="239 1097 638 1191"> <thead> <tr> <th>Start [MHz]</th> <th>Stop [MHz]</th> <th>RBW [Hz]</th> <th>Freq [MHz]</th> <th>PwrAve [dBm]</th> <th>ΔLimit [dB]</th> </tr> </thead> <tbody> <tr><td>30.0000</td><td>1.0000</td><td>1.000</td><td>141.792500</td><td>-29.39</td><td>-16.39</td></tr> <tr><td>1.0000</td><td>1.8450</td><td>1.000</td><td>1.062319</td><td>-41.82</td><td>-28.82</td></tr> <tr><td>1.8450</td><td>3.0000</td><td>1.000</td><td>2.917811</td><td>-40.18</td><td>-27.18</td></tr> <tr><td>3.0000</td><td>7.0000</td><td>1.000</td><td>3.016000</td><td>-37.55</td><td>-24.55</td></tr> <tr><td>7.0000</td><td>13.6000</td><td>1.000</td><td>10.236975</td><td>-35.01</td><td>-22.01</td></tr> <tr><td>13.6000</td><td>19.1000</td><td>1.000</td><td>15.361375</td><td>-26.14</td><td>-13.14</td></tr> </tbody> </table> <p>Date: 3.AUG.2017 14:42:06</p>	Start [MHz]	Stop [MHz]	RBW [Hz]	Freq [MHz]	PwrAve [dBm]	ΔLimit [dB]	30.0000	1.0000	1.000	141.792500	-29.39	-16.39	1.0000	1.8450	1.000	1.062319	-41.82	-28.82	1.8450	3.0000	1.000	2.917811	-40.18	-27.18	3.0000	7.0000	1.000	3.016000	-37.55	-24.55	7.0000	13.6000	1.000	10.236975	-35.01	-22.01	13.6000	19.1000	1.000	15.361375	-26.14	-13.14	 <table border="1" data-bbox="893 1097 1292 1191"> <thead> <tr> <th>Start [MHz]</th> <th>Stop [MHz]</th> <th>RBW [Hz]</th> <th>Freq [MHz]</th> <th>PwrAve [dBm]</th> <th>ΔLimit [dB]</th> </tr> </thead> <tbody> <tr><td>30.0000</td><td>1.0000</td><td>1.000</td><td>141.792500</td><td>-34.39</td><td>-21.39</td></tr> <tr><td>1.0000</td><td>1.8450</td><td>1.000</td><td>1.260260</td><td>-41.88</td><td>-28.88</td></tr> <tr><td>1.8450</td><td>3.0000</td><td>1.000</td><td>2.896634</td><td>-40.57</td><td>-27.57</td></tr> <tr><td>3.0000</td><td>7.0000</td><td>1.000</td><td>4.137000</td><td>-37.33</td><td>-24.33</td></tr> <tr><td>7.0000</td><td>13.6000</td><td>1.000</td><td>10.230700</td><td>-34.95</td><td>-21.95</td></tr> <tr><td>13.6000</td><td>19.1000</td><td>1.000</td><td>15.369625</td><td>-26.36</td><td>-13.36</td></tr> </tbody> </table> <p>Date: 3.AUG.2017 15:11:47</p>	Start [MHz]	Stop [MHz]	RBW [Hz]	Freq [MHz]	PwrAve [dBm]	ΔLimit [dB]	30.0000	1.0000	1.000	141.792500	-34.39	-21.39	1.0000	1.8450	1.000	1.260260	-41.88	-28.88	1.8450	3.0000	1.000	2.896634	-40.57	-27.57	3.0000	7.0000	1.000	4.137000	-37.33	-24.33	7.0000	13.6000	1.000	10.230700	-34.95	-21.95	13.6000	19.1000	1.000	15.369625	-26.36	-13.36
Start [MHz]	Stop [MHz]	RBW [Hz]	Freq [MHz]	PwrAve [dBm]	ΔLimit [dB]																																																																																
30.0000	1.0000	1.000	141.792500	-29.39	-16.39																																																																																
1.0000	1.8450	1.000	1.062319	-41.82	-28.82																																																																																
1.8450	3.0000	1.000	2.917811	-40.18	-27.18																																																																																
3.0000	7.0000	1.000	3.016000	-37.55	-24.55																																																																																
7.0000	13.6000	1.000	10.236975	-35.01	-22.01																																																																																
13.6000	19.1000	1.000	15.361375	-26.14	-13.14																																																																																
Start [MHz]	Stop [MHz]	RBW [Hz]	Freq [MHz]	PwrAve [dBm]	ΔLimit [dB]																																																																																
30.0000	1.0000	1.000	141.792500	-34.39	-21.39																																																																																
1.0000	1.8450	1.000	1.260260	-41.88	-28.88																																																																																
1.8450	3.0000	1.000	2.896634	-40.57	-27.57																																																																																
3.0000	7.0000	1.000	4.137000	-37.33	-24.33																																																																																
7.0000	13.6000	1.000	10.230700	-34.95	-21.95																																																																																
13.6000	19.1000	1.000	15.369625	-26.36	-13.36																																																																																
Highest Channel	Highest Channel																																																																																				
 <table border="1" data-bbox="239 1617 638 1711"> <thead> <tr> <th>Start [MHz]</th> <th>Stop [MHz]</th> <th>RBW [Hz]</th> <th>Freq [MHz]</th> <th>PwrAve [dBm]</th> <th>ΔLimit [dB]</th> </tr> </thead> <tbody> <tr><td>30.0000</td><td>1.0000</td><td>1.000</td><td>171.605000</td><td>-27.57</td><td>-14.57</td></tr> <tr><td>1.0000</td><td>1.8450</td><td>1.000</td><td>1.097598</td><td>-41.43</td><td>-28.43</td></tr> <tr><td>1.8450</td><td>3.0000</td><td>1.000</td><td>1.932371</td><td>-37.84</td><td>-24.84</td></tr> <tr><td>3.0000</td><td>7.0000</td><td>1.000</td><td>3.005000</td><td>-37.94</td><td>-24.94</td></tr> <tr><td>7.0000</td><td>13.6000</td><td>1.000</td><td>10.235850</td><td>-35.04</td><td>-22.04</td></tr> <tr><td>13.6000</td><td>19.1000</td><td>1.000</td><td>15.264750</td><td>-26.10</td><td>-13.10</td></tr> </tbody> </table> <p>Date: 3.AUG.2017 14:42:56</p>	Start [MHz]	Stop [MHz]	RBW [Hz]	Freq [MHz]	PwrAve [dBm]	ΔLimit [dB]	30.0000	1.0000	1.000	171.605000	-27.57	-14.57	1.0000	1.8450	1.000	1.097598	-41.43	-28.43	1.8450	3.0000	1.000	1.932371	-37.84	-24.84	3.0000	7.0000	1.000	3.005000	-37.94	-24.94	7.0000	13.6000	1.000	10.235850	-35.04	-22.04	13.6000	19.1000	1.000	15.264750	-26.10	-13.10	 <table border="1" data-bbox="893 1617 1292 1711"> <thead> <tr> <th>Start [MHz]</th> <th>Stop [MHz]</th> <th>RBW [Hz]</th> <th>Freq [MHz]</th> <th>PwrAve [dBm]</th> <th>ΔLimit [dB]</th> </tr> </thead> <tbody> <tr><td>30.0000</td><td>1.0000</td><td>1.000</td><td>171.605000</td><td>-31.55</td><td>-18.55</td></tr> <tr><td>1.0000</td><td>1.8450</td><td>1.000</td><td>1.233431</td><td>-41.36</td><td>-28.36</td></tr> <tr><td>1.8450</td><td>3.0000</td><td>1.000</td><td>2.962336</td><td>-40.84</td><td>-27.84</td></tr> <tr><td>3.0000</td><td>7.0000</td><td>1.000</td><td>3.024000</td><td>-37.55</td><td>-24.55</td></tr> <tr><td>7.0000</td><td>13.6000</td><td>1.000</td><td>10.231525</td><td>-35.17</td><td>-22.17</td></tr> <tr><td>13.6000</td><td>19.1000</td><td>1.000</td><td>15.233500</td><td>-26.25</td><td>-13.25</td></tr> </tbody> </table> <p>Date: 3.AUG.2017 15:12:38</p>	Start [MHz]	Stop [MHz]	RBW [Hz]	Freq [MHz]	PwrAve [dBm]	ΔLimit [dB]	30.0000	1.0000	1.000	171.605000	-31.55	-18.55	1.0000	1.8450	1.000	1.233431	-41.36	-28.36	1.8450	3.0000	1.000	2.962336	-40.84	-27.84	3.0000	7.0000	1.000	3.024000	-37.55	-24.55	7.0000	13.6000	1.000	10.231525	-35.17	-22.17	13.6000	19.1000	1.000	15.233500	-26.25	-13.25
Start [MHz]	Stop [MHz]	RBW [Hz]	Freq [MHz]	PwrAve [dBm]	ΔLimit [dB]																																																																																
30.0000	1.0000	1.000	171.605000	-27.57	-14.57																																																																																
1.0000	1.8450	1.000	1.097598	-41.43	-28.43																																																																																
1.8450	3.0000	1.000	1.932371	-37.84	-24.84																																																																																
3.0000	7.0000	1.000	3.005000	-37.94	-24.94																																																																																
7.0000	13.6000	1.000	10.235850	-35.04	-22.04																																																																																
13.6000	19.1000	1.000	15.264750	-26.10	-13.10																																																																																
Start [MHz]	Stop [MHz]	RBW [Hz]	Freq [MHz]	PwrAve [dBm]	ΔLimit [dB]																																																																																
30.0000	1.0000	1.000	171.605000	-31.55	-18.55																																																																																
1.0000	1.8450	1.000	1.233431	-41.36	-28.36																																																																																
1.8450	3.0000	1.000	2.962336	-40.84	-27.84																																																																																
3.0000	7.0000	1.000	3.024000	-37.55	-24.55																																																																																
7.0000	13.6000	1.000	10.231525	-35.17	-22.17																																																																																
13.6000	19.1000	1.000	15.233500	-26.25	-13.25																																																																																



Frequency Stability

Test Conditions	Middle Channel	GSM850 (GPRS class 8)	GSM850 (EDGE class 8)	Limit 2.5ppm
Temperature (°C)	Voltage (Volt)	Deviation (ppm)		Result
50	Normal Voltage	0.0108	0.0012	PASS
40	Normal Voltage	0.0132	0.0060	
30	Normal Voltage	0.0096	0.0048	
20(Ref.)	Normal Voltage	0.0000	0.0000	
10	Normal Voltage	0.0048	0.0036	
0	Normal Voltage	0.0072	0.0084	
-10	Normal Voltage	0.0000	0.0012	
-20	Normal Voltage	0.0096	0.0060	
-30	Normal Voltage	0.0060	0.0024	
20	Maximum Voltage	0.0000	0.0000	
20	Normal Voltage	0.0072	0.0048	
20	Battery End Point	0.0024	0.0096	

Test Conditions	Middle Channel	GSM1900 (GPRS class 8)	GSM1900 (EDGE class 8)	Limit Note 2.
Temperature (°C)	Voltage (Volt)	Deviation (ppm)		Result
50	Normal Voltage	0.0064	0.0080	PASS
40	Normal Voltage	0.0011	0.0048	
30	Normal Voltage	0.0005	0.0011	
20(Ref.)	Normal Voltage	0.0000	0.0000	
10	Normal Voltage	0.0021	0.0011	
0	Normal Voltage	0.0032	0.0064	
-10	Normal Voltage	0.0011	0.0101	
-20	Normal Voltage	0.0032	0.0106	
-30	Normal Voltage	0.0011	0.0138	
20	Maximum Voltage	0.0021	0.0016	
20	Normal Voltage	0.0053	0.0032	
20	Battery End Point	0.0011	0.0064	

Note:

1. Normal Voltage = 4 V. ; Battery End Point (BEP) = 3.6 V. ; Maximum Voltage =4.4 V
2. The frequency fundamental emissions stay within the authorized frequency block based on the frequency deviation measured is small.



A2. WCDMA

Peak-to-Average Ratio

Mode	WCDMA Band V	WCDMA Band II	WCDMA Band IV	Limit: 13dB
Mod.	RMC 12.2Kbps	RMC 12.2Kbps	RMC 12.2Kbps	Result
Lowest CH	2.84	2.60	2.72	PASS
Middle CH	2.72	3.00	2.60	
Highest CH	2.68	2.88	2.64	

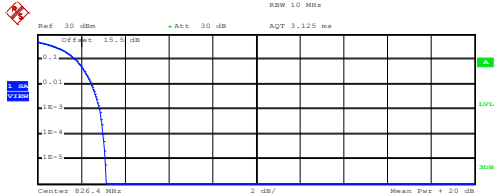
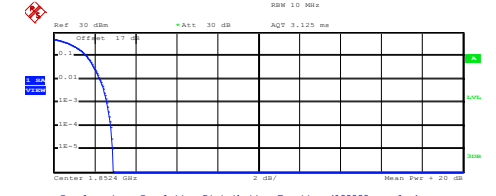
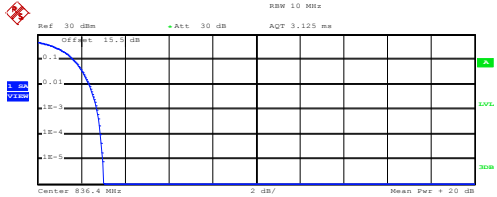
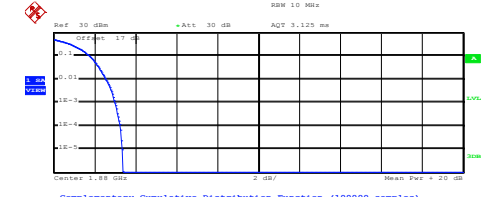
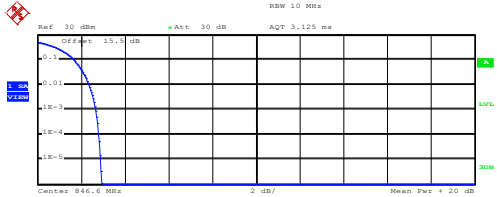
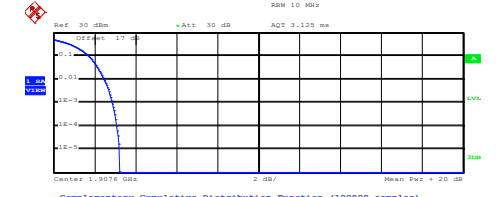

WCDMA Band V (RMC 12.2Kbps)	WCDMA Band II (RMC 12.2Kbps)
<p style="text-align: center;">Lowest Channel</p>  <p>Center 826.4 MHz 2 dB/ Mean Pwr + 20 dB</p> <p>Complementary Cumulative Distribution Function (100000 samples)</p> <p>Trace 1</p> <p>Mean 20.91 dBm Peak 24.04 dBm Crest 3.13 dB</p> <p>10 % 1.76 dB 1 % 2.48 dB .1 % 2.84 dB .01 % 3.00 dB</p> <p>Date: 26.JUL.2017 18:48:24</p>	<p style="text-align: center;">Lowest Channel</p>  <p>Center 1.8524 GHz 2 dB/ Mean Pwr + 20 dB</p> <p>Complementary Cumulative Distribution Function (100000 samples)</p> <p>Trace 1</p> <p>Mean 22.55 dBm Peak 25.45 dBm Crest 2.90 dB</p> <p>10 % 1.60 dB 1 % 2.24 dB .1 % 2.60 dB .01 % 2.80 dB</p> <p>Date: 3.AUG.2017 15:42:41</p>
<p style="text-align: center;">Middle Channel</p>  <p>Center 836.4 MHz 2 dB/ Mean Pwr + 20 dB</p> <p>Complementary Cumulative Distribution Function (100000 samples)</p> <p>Trace 1</p> <p>Mean 20.88 dBm Peak 23.90 dBm Crest 3.02 dB</p> <p>10 % 1.64 dB 1 % 2.36 dB .1 % 2.72 dB .01 % 2.88 dB</p> <p>Date: 26.JUL.2017 18:48:32</p>	<p style="text-align: center;">Middle Channel</p>  <p>Center 1.85 GHz 2 dB/ Mean Pwr + 20 dB</p> <p>Complementary Cumulative Distribution Function (100000 samples)</p> <p>Trace 1</p> <p>Mean 22.63 dBm Peak 26.02 dBm Crest 3.39 dB</p> <p>10 % 1.76 dB 1 % 2.56 dB .1 % 3.00 dB .01 % 3.24 dB</p> <p>Date: 3.AUG.2017 15:42:50</p>
<p style="text-align: center;">Highest Channel</p>  <p>Center 846.4 MHz 2 dB/ Mean Pwr + 20 dB</p> <p>Complementary Cumulative Distribution Function (100000 samples)</p> <p>Trace 1</p> <p>Mean 20.76 dBm Peak 23.69 dBm Crest 2.93 dB</p> <p>10 % 1.68 dB 1 % 2.36 dB .1 % 2.68 dB .01 % 2.80 dB</p> <p>Date: 26.JUL.2017 18:48:40</p>	<p style="text-align: center;">Highest Channel</p>  <p>Center 1.9076 GHz 2 dB/ Mean Pwr + 20 dB</p> <p>Complementary Cumulative Distribution Function (100000 samples)</p> <p>Trace 1</p> <p>Mean 22.72 dBm Peak 25.95 dBm Crest 3.22 dB</p> <p>10 % 1.72 dB 1 % 2.48 dB .1 % 2.88 dB .01 % 3.08 dB</p> <p>Date: 3.AUG.2017 15:43:01</p>



WCDMA Band IV (RMC 12.2Kbps)

Lowest Channel

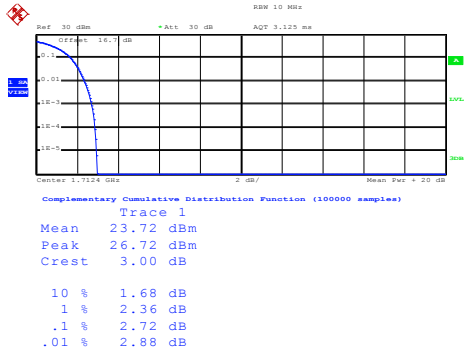

Date: 3.AUG.2017 15:55:40

Middle Channel

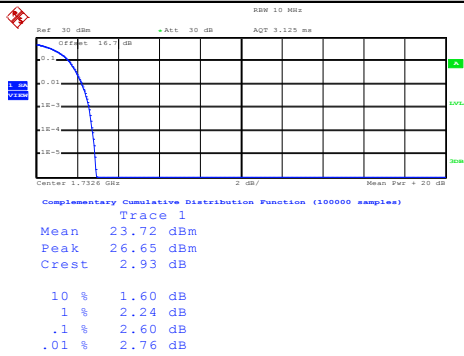

Date: 3.AUG.2017 15:55:50

Highest Channel

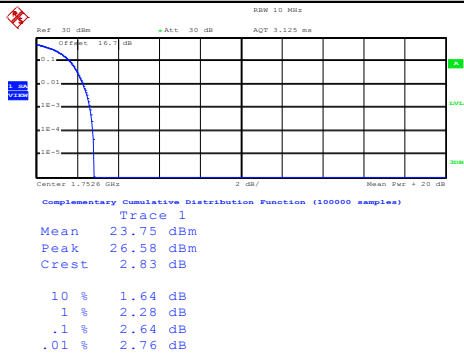

Date: 3.AUG.2017 15:56:00



26dB Bandwidth

Mode	WCDMA Band V	WCDMA Band II	WCDMA Band IV
Mod.	RMC 12.2Kbps	RMC 12.2Kbps	RMC 12.2Kbps
Lowest CH	4.69	4.72	4.68
Middle CH	4.70	4.69	4.71
Highest CH	4.69	4.69	4.71



WCDMA Band V (RMC 12.2Kbps)

WCDMA Band II (RMC 12.2Kbps)

Lowest Channel

Lowest Channel

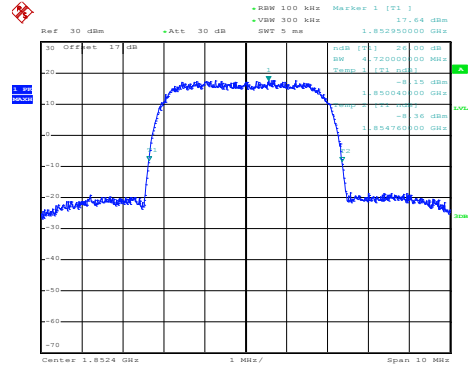
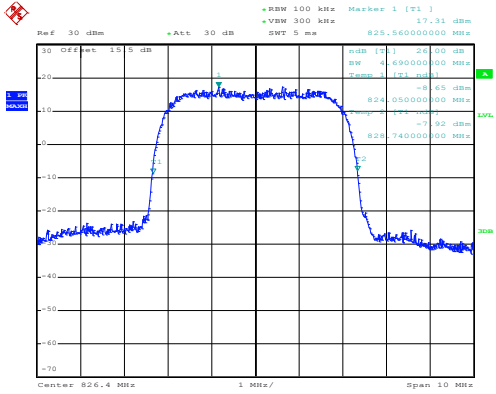

Date: 26.JUL.2017 17:58:21

Date: 3.AUG.2017 15:39:46

Middle Channel

Middle Channel

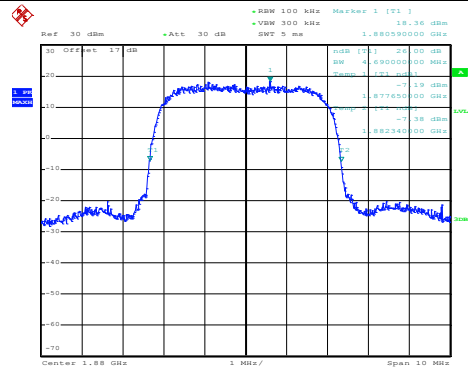
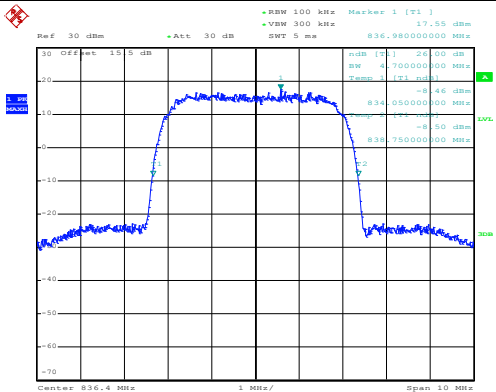

Date: 26.JUL.2017 17:58:49

Date: 3.AUG.2017 15:40:15

Highest Channel

Highest Channel

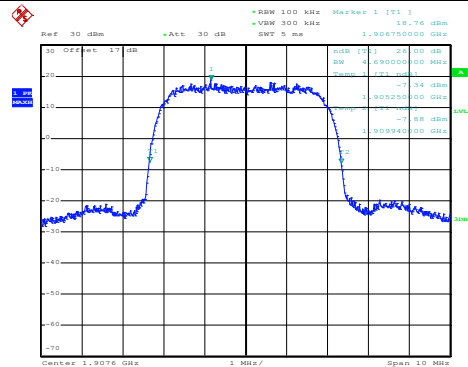
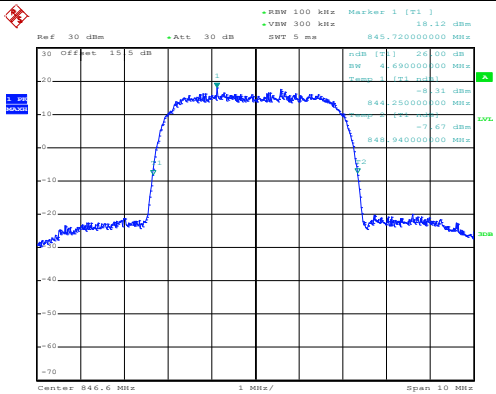

Date: 26.JUL.2017 17:59:17

Date: 3.AUG.2017 15:40:43



WCDMA Band IV (RMC 12.2Kbps)

Lowest Channel

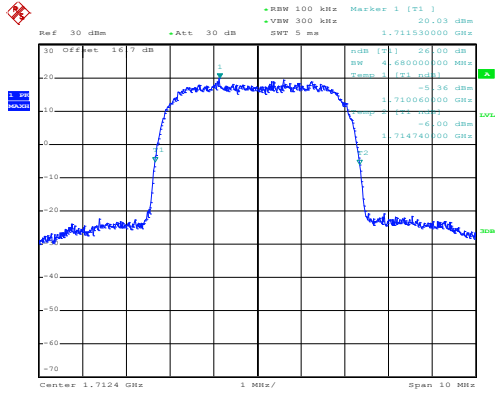

Date: 3.AUG.2017 15:50:23

Middle Channel

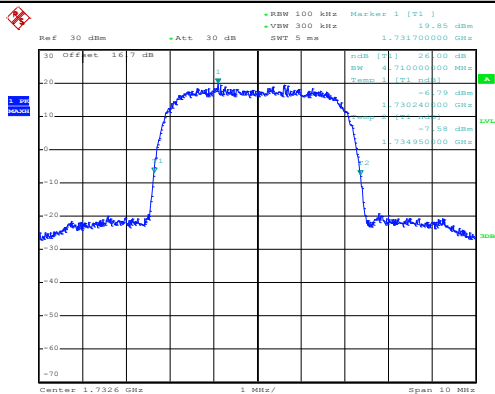

Date: 3.AUG.2017 15:50:51

Highest Channel

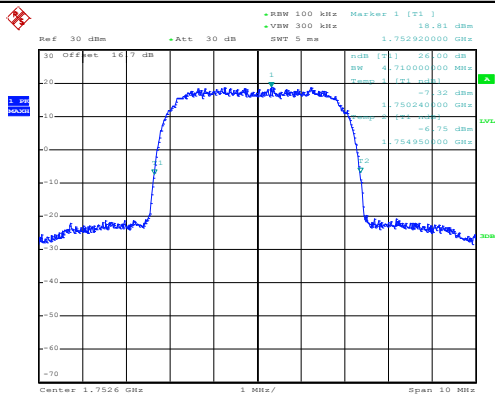

Date: 3.AUG.2017 15:51:19



Occupied Bandwidth

Mode	WCDMA Band V	WCDMA Band II	WCDMA Band IV
Mod.	RMC 12.2Kbps	RMC 12.2Kbps	RMC 12.2Kbps
Lowest CH	4.16	4.17	4.16
Middle CH	4.16	4.16	4.16
Highest CH	4.15	4.17	4.16



WCDMA Band V (RMC 12.2Kbps)

WCDMA Band II (RMC 12.2Kbps)

Lowest Channel

Lowest Channel

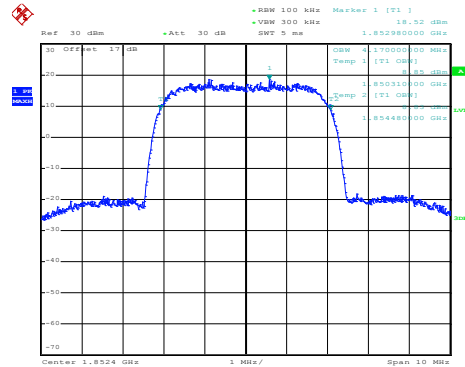
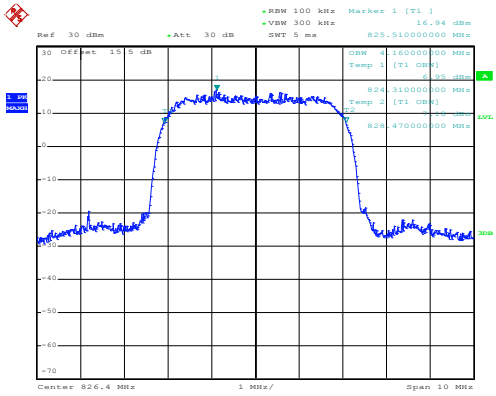

Date: 26.JUL.2017 18:44:53

Date: 3.AUG.2017 15:41:21

Middle Channel

Middle Channel

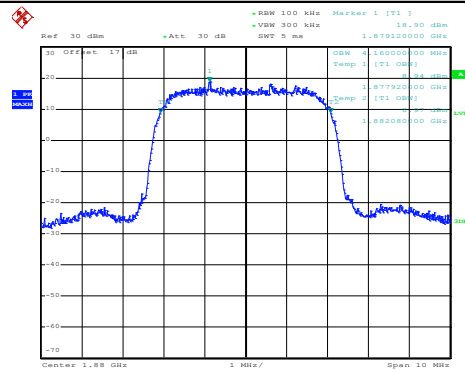
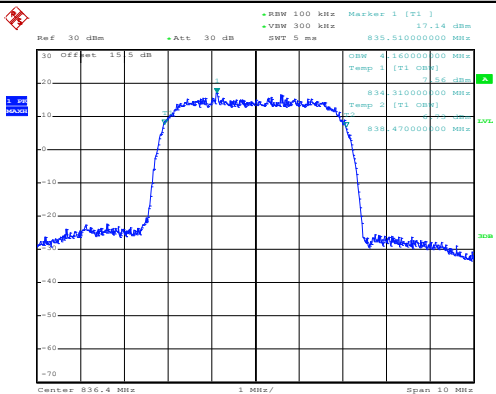

Date: 26.JUL.2017 18:45:21

Date: 3.AUG.2017 15:41:49

Highest Channel

Highest Channel

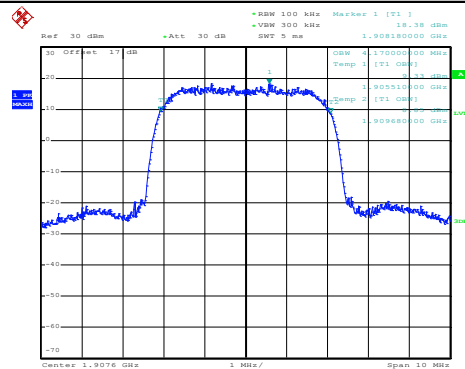
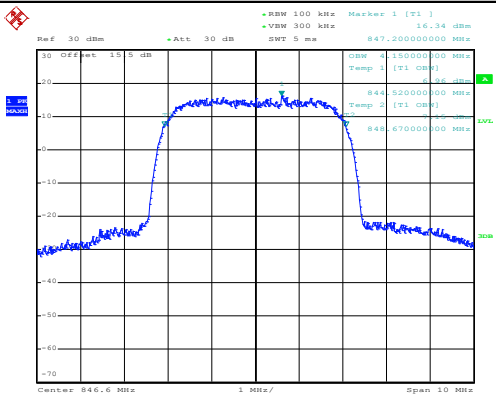

Date: 26.JUL.2017 18:45:49

Date: 3.AUG.2017 15:42:17



WCDMA Band IV (RMC 12.2Kbps)

Lowest Channel

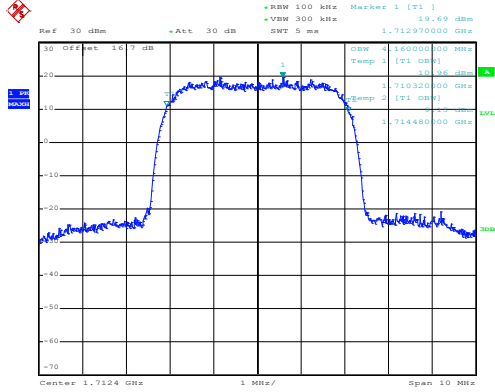

Date: 3.AUG.2017 15:52:08

Middle Channel

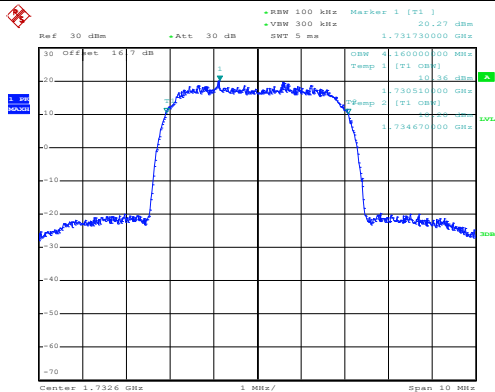

Date: 3.AUG.2017 15:52:36

Highest Channel

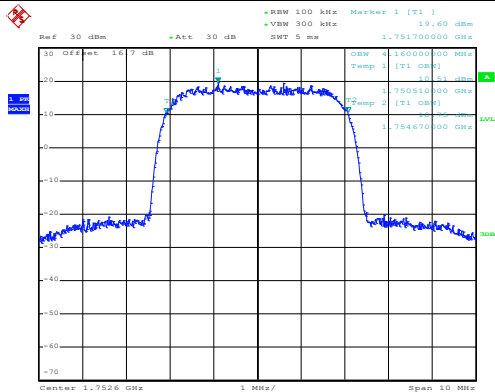

Date: 3.AUG.2017 15:53:04



Conducted Band Edge



WCDMA Band V (RMC 12.2Kbps)

Lowest Band Edge

Highest Band Edge

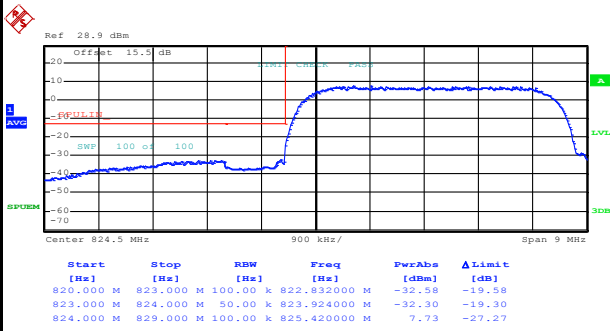

Date: 26.JUL.2017 18:05:58

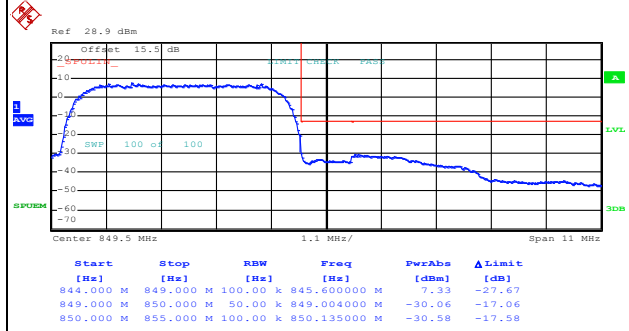

Date: 26.JUL.2017 18:08:41



WCDMA Band II (RMC 12.2Kbps)

Lowest Band Edge

Highest Band Edge

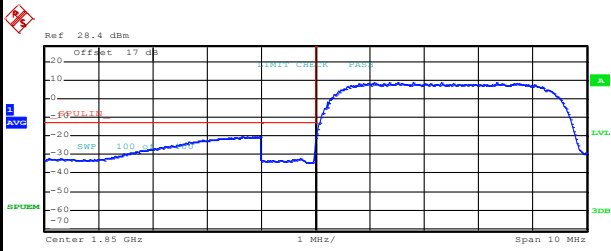

Start [Hz]	Stop [Hz]	RBW [Hz]	Freq [Hz]	PwrAbs [dBm]	ΔLimit [dB]
1.845 G	1.849 G	1.00 M	1.848964 G	-20.46	-7.46
1.849 G	1.850 G	50.00 k	1.849996 G	-29.63	-16.63
1.850 G	1.855 G	100.00 k	1.852310 G	8.68	-26.32

Date: 3.AUG.2017 15:45:52

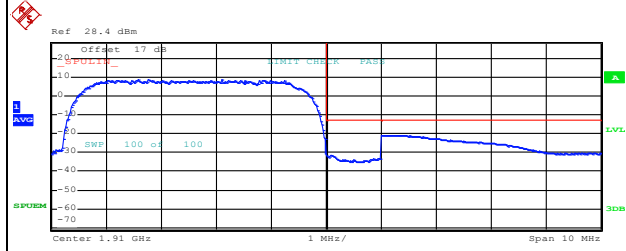

Start [Hz]	Stop [Hz]	RBW [Hz]	Freq [Hz]	PwrAbs [dBm]	ΔLimit [dB]
1.905 G	1.910 G	100.00 k	1.906570 G	8.87	-26.13
1.910 G	1.911 G	50.00 k	1.910092 G	-31.20	-18.20
1.911 G	1.915 G	1.00 M	1.911136 G	-20.80	-7.80

Date: 3.AUG.2017 15:48:34



WCDMA Band IV (RMC 12.2Kbps)

Lowest Band Edge

Highest Band Edge

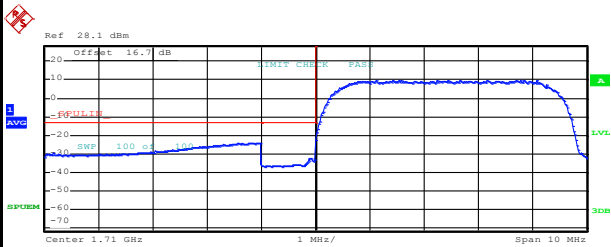

Start [Hz]	Stop [Hz]	RBW [Hz]	Freq [Hz]	PwrAbs [dBm]	ΔLimit [dB]
1.705 G	1.709 G	1.00 M	1.708780 G	-23.99	-10.99
1.709 G	1.710 G	50.00 k	1.709904 G	-32.20	-19.20
1.710 G	1.715 G	100.00 k	1.713155 G	9.88	-25.12

Date: 3.AUG.2017 15:58:44

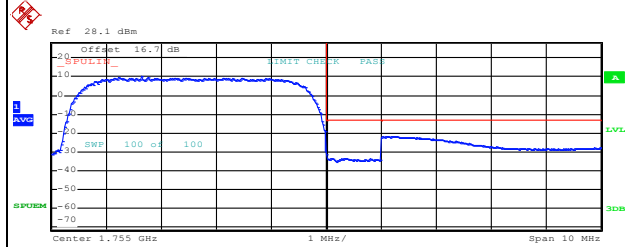

Start [Hz]	Stop [Hz]	RBW [Hz]	Freq [Hz]	PwrAbs [dBm]	ΔLimit [dB]
1.750 G	1.755 G	100.00 k	1.751630 G	10.39	-24.61
1.755 G	1.756 G	50.00 k	1.755004 G	-30.86	-17.86
1.756 G	1.760 G	1.00 M	1.756144 G	-21.72	-8.72

Date: 3.AUG.2017 16:01:26



Conducted Spurious Emission

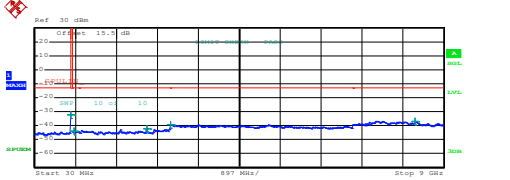
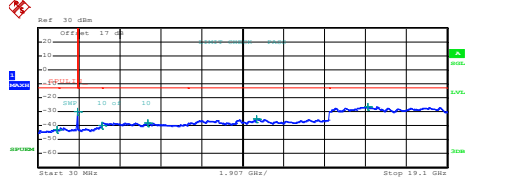
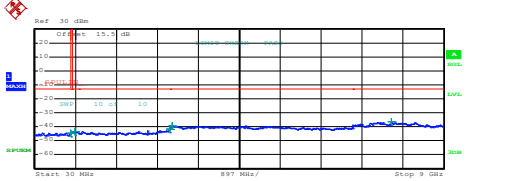
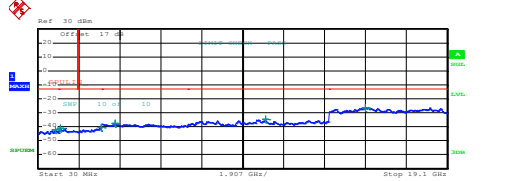
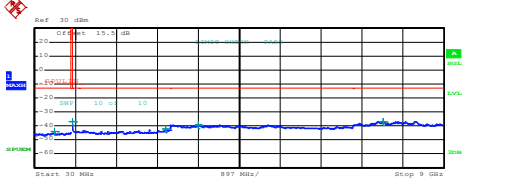
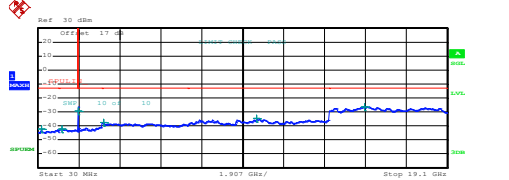

WCDMA Band V (RMC 12.2Kbps)	WCDMA Band II (RMC 12.2Kbps)																																																																														
Lowest Channel	Lowest Channel																																																																														
 <p>Start 30 MHz Stop 9 GHz RBW 897 MHz</p> <table border="1"> <thead> <tr> <th>Start [Hz]</th> <th>Stop [Hz]</th> <th>RBW [Hz]</th> <th>Freq [Hz]</th> <th>PwrAve [dBm]</th> <th>ΔLimit [dB]</th> </tr> </thead> <tbody> <tr><td>30,000 M</td><td>820,000 M</td><td>1,000 M</td><td>816,000000 M</td><td>-42.35</td><td>-29.23</td></tr> <tr><td>850,000 M</td><td>1,000 G</td><td>1,000 G</td><td>890,633750 M</td><td>-43.81</td><td>-30.81</td></tr> <tr><td>1,000 G</td><td>3,000 G</td><td>1,000 M</td><td>2,482500 G</td><td>-42.02</td><td>-29.02</td></tr> <tr><td>3,000 G</td><td>7,000 G</td><td>1,000 M</td><td>3,015000 G</td><td>-39.18</td><td>-26.18</td></tr> <tr><td>7,000 G</td><td>9,000 G</td><td>1,000 M</td><td>8,368000 G</td><td>-36.78</td><td>-23.78</td></tr> </tbody> </table> <p>Date: 26.JUL.2017 18:00:09</p>	Start [Hz]	Stop [Hz]	RBW [Hz]	Freq [Hz]	PwrAve [dBm]	ΔLimit [dB]	30,000 M	820,000 M	1,000 M	816,000000 M	-42.35	-29.23	850,000 M	1,000 G	1,000 G	890,633750 M	-43.81	-30.81	1,000 G	3,000 G	1,000 M	2,482500 G	-42.02	-29.02	3,000 G	7,000 G	1,000 M	3,015000 G	-39.18	-26.18	7,000 G	9,000 G	1,000 M	8,368000 G	-36.78	-23.78	 <p>Start 30 MHz Stop 19.1 GHz RBW 1,907 GHz</p> <table border="1"> <thead> <tr> <th>Start [Hz]</th> <th>Stop [Hz]</th> <th>RBW [Hz]</th> <th>Freq [Hz]</th> <th>PwrAve [dBm]</th> <th>ΔLimit [dB]</th> </tr> </thead> <tbody> <tr><td>30,000 M</td><td>1,000 G</td><td>1,000 M</td><td>816,000000 M</td><td>-42.35</td><td>-29.23</td></tr> <tr><td>1,000 G</td><td>1,845 G</td><td>1,000 M</td><td>1,844578 G</td><td>-29.92</td><td>-16.92</td></tr> <tr><td>1,845 G</td><td>3,000 G</td><td>1,000 M</td><td>2,997056 G</td><td>-40.32</td><td>-27.32</td></tr> <tr><td>3,000 G</td><td>7,000 G</td><td>1,000 M</td><td>3,144000 G</td><td>-37.97</td><td>-24.97</td></tr> <tr><td>7,000 G</td><td>13,600 G</td><td>1,000 M</td><td>10,215025 G</td><td>-35.14</td><td>-22.14</td></tr> <tr><td>13,600 G</td><td>19,100 G</td><td>1,000 M</td><td>15,383375 G</td><td>-26.51</td><td>-13.51</td></tr> </tbody> </table> <p>Date: 3.AUG.2017 15:37:19</p>	Start [Hz]	Stop [Hz]	RBW [Hz]	Freq [Hz]	PwrAve [dBm]	ΔLimit [dB]	30,000 M	1,000 G	1,000 M	816,000000 M	-42.35	-29.23	1,000 G	1,845 G	1,000 M	1,844578 G	-29.92	-16.92	1,845 G	3,000 G	1,000 M	2,997056 G	-40.32	-27.32	3,000 G	7,000 G	1,000 M	3,144000 G	-37.97	-24.97	7,000 G	13,600 G	1,000 M	10,215025 G	-35.14	-22.14	13,600 G	19,100 G	1,000 M	15,383375 G	-26.51	-13.51
Start [Hz]	Stop [Hz]	RBW [Hz]	Freq [Hz]	PwrAve [dBm]	ΔLimit [dB]																																																																										
30,000 M	820,000 M	1,000 M	816,000000 M	-42.35	-29.23																																																																										
850,000 M	1,000 G	1,000 G	890,633750 M	-43.81	-30.81																																																																										
1,000 G	3,000 G	1,000 M	2,482500 G	-42.02	-29.02																																																																										
3,000 G	7,000 G	1,000 M	3,015000 G	-39.18	-26.18																																																																										
7,000 G	9,000 G	1,000 M	8,368000 G	-36.78	-23.78																																																																										
Start [Hz]	Stop [Hz]	RBW [Hz]	Freq [Hz]	PwrAve [dBm]	ΔLimit [dB]																																																																										
30,000 M	1,000 G	1,000 M	816,000000 M	-42.35	-29.23																																																																										
1,000 G	1,845 G	1,000 M	1,844578 G	-29.92	-16.92																																																																										
1,845 G	3,000 G	1,000 M	2,997056 G	-40.32	-27.32																																																																										
3,000 G	7,000 G	1,000 M	3,144000 G	-37.97	-24.97																																																																										
7,000 G	13,600 G	1,000 M	10,215025 G	-35.14	-22.14																																																																										
13,600 G	19,100 G	1,000 M	15,383375 G	-26.51	-13.51																																																																										
Middle Channel	Middle Channel																																																																														
 <p>Start 30 MHz Stop 9 GHz RBW 897 MHz</p> <table border="1"> <thead> <tr> <th>Start [Hz]</th> <th>Stop [Hz]</th> <th>RBW [Hz]</th> <th>Freq [Hz]</th> <th>PwrAve [dBm]</th> <th>ΔLimit [dB]</th> </tr> </thead> <tbody> <tr><td>30,000 M</td><td>820,000 M</td><td>1,000 M</td><td>816,000000 M</td><td>-44.38</td><td>-31.38</td></tr> <tr><td>850,000 M</td><td>1,000 G</td><td>1,000 M</td><td>901,000000 M</td><td>-43.00</td><td>-30.00</td></tr> <tr><td>1,000 G</td><td>3,000 G</td><td>1,000 M</td><td>2,988500 G</td><td>-41.52</td><td>-28.52</td></tr> <tr><td>3,000 G</td><td>7,000 G</td><td>1,000 M</td><td>3,042000 G</td><td>-39.36</td><td>-26.36</td></tr> <tr><td>7,000 G</td><td>9,000 G</td><td>1,000 M</td><td>7,853500 G</td><td>-36.62</td><td>-23.62</td></tr> </tbody> </table> <p>Date: 26.JUL.2017 18:00:54</p>	Start [Hz]	Stop [Hz]	RBW [Hz]	Freq [Hz]	PwrAve [dBm]	ΔLimit [dB]	30,000 M	820,000 M	1,000 M	816,000000 M	-44.38	-31.38	850,000 M	1,000 G	1,000 M	901,000000 M	-43.00	-30.00	1,000 G	3,000 G	1,000 M	2,988500 G	-41.52	-28.52	3,000 G	7,000 G	1,000 M	3,042000 G	-39.36	-26.36	7,000 G	9,000 G	1,000 M	7,853500 G	-36.62	-23.62	 <p>Start 30 MHz Stop 19.1 GHz RBW 1,907 GHz</p> <table border="1"> <thead> <tr> <th>Start [Hz]</th> <th>Stop [Hz]</th> <th>RBW [Hz]</th> <th>Freq [Hz]</th> <th>PwrAve [dBm]</th> <th>ΔLimit [dB]</th> </tr> </thead> <tbody> <tr><td>30,000 M</td><td>1,000 G</td><td>1,000 M</td><td>829,765000 M</td><td>-42.23</td><td>-29.23</td></tr> <tr><td>1,000 G</td><td>3,845 G</td><td>1,000 M</td><td>3,030378 G</td><td>-41.04</td><td>-28.04</td></tr> <tr><td>1,915 G</td><td>3,000 G</td><td>1,000 M</td><td>2,977215 G</td><td>-40.55</td><td>-27.55</td></tr> <tr><td>3,000 G</td><td>7,000 G</td><td>1,000 M</td><td>3,608000 G</td><td>-37.81</td><td>-24.81</td></tr> <tr><td>7,000 G</td><td>13,600 G</td><td>1,000 M</td><td>10,626700 G</td><td>-34.81</td><td>-21.81</td></tr> <tr><td>13,600 G</td><td>19,100 G</td><td>1,000 M</td><td>15,283000 G</td><td>-26.36</td><td>-13.36</td></tr> </tbody> </table> <p>Date: 3.AUG.2017 15:38:04</p>	Start [Hz]	Stop [Hz]	RBW [Hz]	Freq [Hz]	PwrAve [dBm]	ΔLimit [dB]	30,000 M	1,000 G	1,000 M	829,765000 M	-42.23	-29.23	1,000 G	3,845 G	1,000 M	3,030378 G	-41.04	-28.04	1,915 G	3,000 G	1,000 M	2,977215 G	-40.55	-27.55	3,000 G	7,000 G	1,000 M	3,608000 G	-37.81	-24.81	7,000 G	13,600 G	1,000 M	10,626700 G	-34.81	-21.81	13,600 G	19,100 G	1,000 M	15,283000 G	-26.36	-13.36
Start [Hz]	Stop [Hz]	RBW [Hz]	Freq [Hz]	PwrAve [dBm]	ΔLimit [dB]																																																																										
30,000 M	820,000 M	1,000 M	816,000000 M	-44.38	-31.38																																																																										
850,000 M	1,000 G	1,000 M	901,000000 M	-43.00	-30.00																																																																										
1,000 G	3,000 G	1,000 M	2,988500 G	-41.52	-28.52																																																																										
3,000 G	7,000 G	1,000 M	3,042000 G	-39.36	-26.36																																																																										
7,000 G	9,000 G	1,000 M	7,853500 G	-36.62	-23.62																																																																										
Start [Hz]	Stop [Hz]	RBW [Hz]	Freq [Hz]	PwrAve [dBm]	ΔLimit [dB]																																																																										
30,000 M	1,000 G	1,000 M	829,765000 M	-42.23	-29.23																																																																										
1,000 G	3,845 G	1,000 M	3,030378 G	-41.04	-28.04																																																																										
1,915 G	3,000 G	1,000 M	2,977215 G	-40.55	-27.55																																																																										
3,000 G	7,000 G	1,000 M	3,608000 G	-37.81	-24.81																																																																										
7,000 G	13,600 G	1,000 M	10,626700 G	-34.81	-21.81																																																																										
13,600 G	19,100 G	1,000 M	15,283000 G	-26.36	-13.36																																																																										
Highest Channel	Highest Channel																																																																														
 <p>Start 30 MHz Stop 9 GHz RBW 897 MHz</p> <table border="1"> <thead> <tr> <th>Start [Hz]</th> <th>Stop [Hz]</th> <th>RBW [Hz]</th> <th>Freq [Hz]</th> <th>PwrAve [dBm]</th> <th>ΔLimit [dB]</th> </tr> </thead> <tbody> <tr><td>30,000 M</td><td>820,000 M</td><td>1,000 M</td><td>462,700000 M</td><td>-44.23</td><td>-31.23</td></tr> <tr><td>850,000 M</td><td>1,000 G</td><td>1,000 M</td><td>850,181250 M</td><td>-36.78</td><td>-23.78</td></tr> <tr><td>1,000 G</td><td>3,000 G</td><td>1,000 M</td><td>2,100000 G</td><td>-42.90</td><td>-28.90</td></tr> <tr><td>3,000 G</td><td>7,000 G</td><td>1,000 M</td><td>3,613000 G</td><td>-39.40</td><td>-26.40</td></tr> <tr><td>7,000 G</td><td>9,000 G</td><td>1,000 M</td><td>7,676000 G</td><td>-37.04</td><td>-24.04</td></tr> </tbody> </table> <p>Date: 26.JUL.2017 18:01:40</p>	Start [Hz]	Stop [Hz]	RBW [Hz]	Freq [Hz]	PwrAve [dBm]	ΔLimit [dB]	30,000 M	820,000 M	1,000 M	462,700000 M	-44.23	-31.23	850,000 M	1,000 G	1,000 M	850,181250 M	-36.78	-23.78	1,000 G	3,000 G	1,000 M	2,100000 G	-42.90	-28.90	3,000 G	7,000 G	1,000 M	3,613000 G	-39.40	-26.40	7,000 G	9,000 G	1,000 M	7,676000 G	-37.04	-24.04	 <p>Start 30 MHz Stop 19.1 GHz RBW 1,907 GHz</p> <table border="1"> <thead> <tr> <th>Start [Hz]</th> <th>Stop [Hz]</th> <th>RBW [Hz]</th> <th>Freq [Hz]</th> <th>PwrAve [dBm]</th> <th>ΔLimit [dB]</th> </tr> </thead> <tbody> <tr><td>30,000 M</td><td>1,000 G</td><td>1,000 M</td><td>170,160000 M</td><td>-42.27</td><td>-29.27</td></tr> <tr><td>1,000 G</td><td>1,845 G</td><td>1,000 M</td><td>1,152311 G</td><td>-42.10</td><td>-29.10</td></tr> <tr><td>1,845 G</td><td>3,000 G</td><td>1,000 M</td><td>1,935271 G</td><td>-29.21</td><td>-16.21</td></tr> <tr><td>3,000 G</td><td>7,000 G</td><td>1,000 M</td><td>3,079000 G</td><td>-37.77</td><td>-24.77</td></tr> <tr><td>7,000 G</td><td>13,600 G</td><td>1,000 M</td><td>10,213375 G</td><td>-34.82</td><td>-21.82</td></tr> <tr><td>13,600 G</td><td>19,100 G</td><td>1,000 M</td><td>15,253375 G</td><td>-26.38</td><td>-13.38</td></tr> </tbody> </table> <p>Date: 3.AUG.2017 15:38:50</p>	Start [Hz]	Stop [Hz]	RBW [Hz]	Freq [Hz]	PwrAve [dBm]	ΔLimit [dB]	30,000 M	1,000 G	1,000 M	170,160000 M	-42.27	-29.27	1,000 G	1,845 G	1,000 M	1,152311 G	-42.10	-29.10	1,845 G	3,000 G	1,000 M	1,935271 G	-29.21	-16.21	3,000 G	7,000 G	1,000 M	3,079000 G	-37.77	-24.77	7,000 G	13,600 G	1,000 M	10,213375 G	-34.82	-21.82	13,600 G	19,100 G	1,000 M	15,253375 G	-26.38	-13.38
Start [Hz]	Stop [Hz]	RBW [Hz]	Freq [Hz]	PwrAve [dBm]	ΔLimit [dB]																																																																										
30,000 M	820,000 M	1,000 M	462,700000 M	-44.23	-31.23																																																																										
850,000 M	1,000 G	1,000 M	850,181250 M	-36.78	-23.78																																																																										
1,000 G	3,000 G	1,000 M	2,100000 G	-42.90	-28.90																																																																										
3,000 G	7,000 G	1,000 M	3,613000 G	-39.40	-26.40																																																																										
7,000 G	9,000 G	1,000 M	7,676000 G	-37.04	-24.04																																																																										
Start [Hz]	Stop [Hz]	RBW [Hz]	Freq [Hz]	PwrAve [dBm]	ΔLimit [dB]																																																																										
30,000 M	1,000 G	1,000 M	170,160000 M	-42.27	-29.27																																																																										
1,000 G	1,845 G	1,000 M	1,152311 G	-42.10	-29.10																																																																										
1,845 G	3,000 G	1,000 M	1,935271 G	-29.21	-16.21																																																																										
3,000 G	7,000 G	1,000 M	3,079000 G	-37.77	-24.77																																																																										
7,000 G	13,600 G	1,000 M	10,213375 G	-34.82	-21.82																																																																										
13,600 G	19,100 G	1,000 M	15,253375 G	-26.38	-13.38																																																																										



WCDMA Band IV (RMC 12.2Kbps)

Lowest Channel

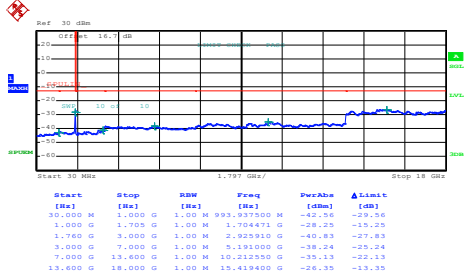

Date: 3.AUG.2017 15:53:56

Middle Channel

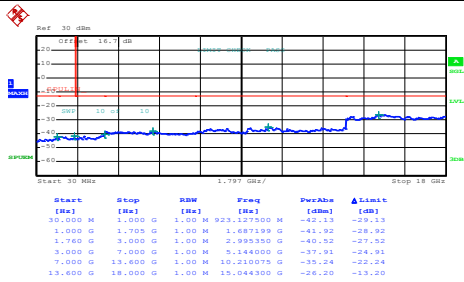

Date: 3.AUG.2017 15:54:42

Highest Channel

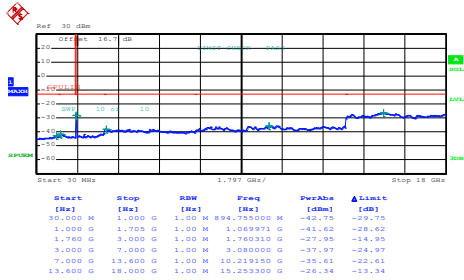

Date: 3.AUG.2017 15:55:27



Frequency Stability

Test Conditions	Middle Channel	WCDMA Band V (RMC 12.2Kbps)	Limit 2.5ppm
Temperature (°C)	Voltage (Volt)	Deviation (ppm)	Result
50	Normal Voltage	0.0036	PASS
40	Normal Voltage	0.0048	
30	Normal Voltage	0.0036	
20(Ref.)	Normal Voltage	0.0000	
10	Normal Voltage	0.0036	
0	Normal Voltage	0.0084	
-10	Normal Voltage	0.0120	
-20	Normal Voltage	0.0048	
-30	Normal Voltage	0.0108	
20	Maximum Voltage	0.0096	
20	Normal Voltage	0.0084	
20	Battery End Point	0.0072	

Test Conditions	Middle Channel	WCDMA Band II (RMC 12.2Kbps)	Limit Note 2.
Temperature (°C)	Voltage (Volt)	Deviation (ppm)	Result
50	Normal Voltage	0.0011	PASS
40	Normal Voltage	0.0005	
30	Normal Voltage	0.0021	
20(Ref.)	Normal Voltage	0.0000	
10	Normal Voltage	0.0053	
0	Normal Voltage	0.0011	
-10	Normal Voltage	0.0021	
-20	Normal Voltage	0.0005	
-30	Normal Voltage	0.0016	
20	Maximum Voltage	0.0032	
20	Normal Voltage	0.0021	
20	Battery End Point	0.0005	



Test Conditions	Middle Channel	WCDMA Band IV (RMC 12.2Kbps)	Limit Note 2.
Temperature (°C)	Voltage (Volt)	Deviation (ppm)	Result
50	Normal Voltage	0.0029	PASS
40	Normal Voltage	0.0058	
30	Normal Voltage	0.0006	
20(Ref.)	Normal Voltage	0.0000	
10	Normal Voltage	0.0040	
0	Normal Voltage	0.0081	
-10	Normal Voltage	0.0075	
-20	Normal Voltage	0.0069	
-30	Normal Voltage	0.0052	
20	Maximum Voltage	0.0046	
20	Normal Voltage	0.0058	
20	Battery End Point	0.0029	

Note:

1. Normal Voltage = 4 V. ; Battery End Point (BEP) = 3.6 V. ; Maximum Voltage =4.4 V
2. The frequency fundamental emissions stay within the authorized frequency block based on the frequency deviation measured is small.



Appendix B. Test Results of ERP/EIRP and Radiated Test

ERP/EIRP

Channel	Mode	Conducted		ERP	
		Power (dBm)	Power (Watts)	ERP(dBm)	ERP(W)
Lowest	GSM850 GPRS class 8 (GT - LC = -5 dB)	32.83	1.9187	25.68	0.3698
Middle		32.83	1.9187	25.68	0.3698
Highest		32.80	1.9055	25.65	0.3673
Lowest	GSM850 EDGE class 8 (GT - LC = -5 dB)	25.88	0.3873	18.73	0.0746
Middle		25.86	0.3855	18.71	0.0743
Highest		25.82	0.3819	18.67	0.0736
Lowest	WCDMA Band V RMC 12.2Kbps (GT - LC = -5 dB)	23.33	0.2153	16.18	0.0415
Middle		23.29	0.2133	16.14	0.0411
Highest		23.35	0.2163	16.20	0.0417
Limit	ERP < 7W	Result		PASS	

Channel	Mode	Conducted		EIRP	
		Power (dBm)	Power (Watts)	EIRP(dBm)	EIRP(W)
Lowest	GSM1900 GPRS class 8 (GT - LC = -3.7 dB)	29.76	0.9462	26.06	0.4036
Middle		29.91	0.9795	26.21	0.4178
Highest		30.08	1.0186	26.38	0.4345
Lowest	GSM1900 EDGE class 8 (GT - LC = -3.7 dB)	24.43	0.2773	20.73	0.1183
Middle		24.54	0.2844	20.84	0.1213
Highest		24.59	0.2877	20.89	0.1227
Lowest	WCDMA Band II RMC 12.2Kbps (GT - LC = -3.7 dB)	22.72	0.1871	19.02	0.0798
Middle		22.66	0.1845	18.96	0.0787
Highest		22.98	0.1986	19.28	0.0847
Limit	EIRP < 2W	Result		PASS	

Channel	Mode	Conducted		EIRP	
		Power (dBm)	Power (Watts)	EIRP(dBm)	EIRP(W)
Lowest	WCDMA Band IV RMC 12.2Kbps (GT - LC = -5.1 dB)	23.90	0.2455	18.80	0.0759
Middle		23.96	0.2489	18.86	0.0769
Highest		24.00	0.2512	18.90	0.0776
Limit	EIRP < 1W	Result		PASS	



Radiated Spurious Emission

GSM850 (GPRS class 8)									
Channel	Frequency (MHz)	ERP (dBm)	Limit (dBm)	Over Limit (dB)	SPA Reading (dBm)	S.G. Power (dBm)	TX Cable loss (dB)	TX Antenna Gain (dBi)	Polarization (H/V)
Lowest	1648	-46.47	-13	-33.47	-56.38	-53.42	0.53	9.63	H
	2472	-51.65	-13	-38.65	-65.09	-59.63	0.65	10.78	H
	4120	-49.48	-13	-36.48	-66.87	-58.82	0.86	12.35	H
									H
									H
									H
	1648	-45.32	-13	-32.32	-54.94	-52.27	0.53	9.63	V
	2472	-43.46	-13	-30.46	-57.39	-51.44	0.65	10.78	V
	4120	-39.82	-13	-26.82	-58.39	-49.16	0.86	12.35	V
									V
									V
									V

Remark: Spurious emissions within 30-1000MHz were found more than 20dB below limit line.



GSM850 (EDGE class 8)									
Channel	Frequency (MHz)	ERP (dBm)	Limit (dBm)	Over Limit (dB)	SPA Reading (dBm)	S.G. Power (dBm)	TX Cable loss (dB)	TX Antenna Gain (dBi)	Polarization (H/V)
Lowest	1648	-58.74	-13	-45.74	-68.65	-65.69	0.53	9.63	H
	2472	-59.22	-13	-46.22	-72.66	-67.2	0.65	10.78	H
	3296	-58.59	-13	-45.59	-74.73	-67.67	0.76	11.99	H
									H
									H
									H
	1648	-54.62	-13	-41.62	-64.24	-61.57	0.53	9.63	V
	2472	-54.52	-13	-41.52	-68.45	-62.5	0.65	10.78	V
	3296	-58.68	-13	-45.68	-74.79	-67.76	0.76	11.99	V
									V
									V
									V

Remark: Spurious emissions within 30-1000MHz were found more than 20dB below limit line.



GSM1900 (GPRS class 8)									
Channel	Frequency (MHz)	EIRP (dBm)	Limit (dBm)	Over Limit (dB)	SPA Reading (dBm)	S.G. Power (dBm)	TX Cable loss (dB)	TX Antenna Gain (dBi)	Polarization (H/V)
Highest	3822	-35.71	-13	-22.71	-52.98	-47.49	0.69	12.47	H
	5730	-40.70	-13	-27.70	-63.02	-52.77	0.99	13.06	H
	7644	-51.31	-13	-38.31	-76.52	-60.93	1.18	10.80	H
									H
									H
									H
	3822	-34.76	-13	-21.76	-53.25	-46.54	0.69	12.47	V
	5730	-46.05	-13	-33.05	-68.58	-58.12	0.99	13.06	V
	7644	-51.80	-13	-38.80	-76.79	-61.42	1.18	10.80	V
									V
									V
									V

Remark: Spurious emissions within 30-1000MHz were found more than 20dB below limit line.



GSM1900 (EDGE class 8)									
Channel	Frequency (MHz)	EIRP (dBm)	Limit (dBm)	Over Limit (dB)	SPA Reading (dBm)	S.G. Power (dBm)	TX Cable loss (dB)	TX Antenna Gain (dBi)	Polarization (H/V)
Highest	3822	-53.57	-13	-40.57	-70.84	-65.35	0.69	12.47	H
	5730	-54.60	-13	-41.60	-76.92	-66.67	0.99	13.06	H
	7644	-51.57	-13	-38.57	-76.78	-61.19	1.18	10.80	H
									H
									H
									H
	3822	-53.11	-13	-40.11	-71.6	-64.89	0.69	12.47	V
	5730	-54.83	-13	-41.83	-77.36	-66.9	0.99	13.06	V
	7644	-51.64	-13	-38.64	-76.63	-61.26	1.18	10.80	V
									V
									V
									V

Remark: Spurious emissions within 30-1000MHz were found more than 20dB below limit line.



WCDMA Band V(RMC 12.2Kbps)									
Channel	Frequency (MHz)	ERP (dBm)	Limit (dBm)	Over Limit (dB)	SPA Reading (dBm)	S.G. Power (dBm)	TX Cable loss (dB)	TX Antenna Gain (dBi)	Polarization (H/V)
Highest	1688	-61.57	-13	-48.57	-71.82	-68.6	0.53	9.71	H
	2536	-60.62	-13	-47.62	-74.07	-68.63	0.66	10.82	H
	3376	-58.40	-13	-45.40	-74.67	-67.71	0.77	12.23	H
									H
									H
									H
	1688	-61.56	-13	-48.56	-71.31	-68.59	0.53	9.71	V
	2536	-59.98	-13	-46.98	-73.81	-67.99	0.66	10.82	V
	3376	-58.73	-13	-45.73	-74.66	-68.04	0.77	12.23	V
									V
									V
									V

Remark: Spurious emissions within 30-1000MHz were found more than 20dB below limit line.



WCDMA Band II(RMC 12.2Kbps)									
Channel	Frequency (MHz)	EIRP (dBm)	Limit (dBm)	Over Limit (dB)	SPA Reading (dBm)	S.G. Power (dBm)	TX Cable loss (dB)	TX Antenna Gain (dBi)	Polarization (H/V)
Highest	3816	-53.12	-13	-40.12	-70.39	-64.91	0.69	12.47	H
	5724	-54.85	-13	-41.85	-76.6	-66.92	0.99	13.07	H
	7632	-51.53	-13	-38.53	-76.71	-61.12	1.18	10.77	H
									H
									H
									H
	3816	-52.17	-13	-39.17	-70.66	-63.96	0.69	12.47	V
	5724	-54.55	-13	-41.55	-76.51	-66.62	0.99	13.07	V
	7632	-51.36	-13	-38.36	-76.29	-60.95	1.18	10.77	V
									V
									V
									V

Remark: Spurious emissions within 30-1000MHz were found more than 20dB below limit line.



WCDMA Band IV(RMC 12.2Kbps)									
Channel	Frequency (MHz)	EIRP (dBm)	Limit (dBm)	Over Limit (dB)	SPA Reading (dBm)	S.G. Power (dBm)	TX Cable loss (dB)	TX Antenna Gain (dBi)	Polarization (H/V)
Highest	3504	-53.20	-13	-40.20	-70.45	-65.02	0.78	12.60	H
	5256	-56.46	-13	-43.46	-77.43	-68.16	1.01	12.71	H
	7008	-52.18	-13	-39.18	-76.21	-62.3	1.17	11.29	H
									H
									H
									H
	3504	-55.49	-13	-42.49	-73.71	-67.31	0.78	12.60	V
	5256	-56.46	-13	-43.46	-77.57	-68.16	1.01	12.71	V
	7008	-51.97	-13	-38.97	-76.3	-62.09	1.17	11.29	V
									V
									V
									V

Remark: Spurious emissions within 30-1000MHz were found more than 20dB below limit line.