



# FCC RF Test Report

**APPLICANT** : Bullitt Group  
**EQUIPMENT** : Rugged Smart Phone  
**BRAND NAME** : CAT  
**MODEL NAME** : S41  
**FCC ID** : ZL5S41  
**STANDARD** : FCC 47 CFR Part 2, 22(H), 24(E), 27(L)  
**CLASSIFICATION** : PCS Licensed Transmitter Held to Ear (PCE)

The product was received on Jun. 09, 2017 and testing was completed on Aug. 14, 2017. We, SPORTON INTERNATIONAL INC., would like to declare that the tested sample has been evaluated in accordance with the test procedures given in ANSI / TIA / EIA-603-D-2010 and has been in compliance with the applicable technical standards.

The test results in this report apply exclusively to the tested model / sample. Without written approval of SPORTON INTERNATIONAL INC., the test report shall not be reproduced except in full.

Reviewed by: Joseph Lin / Supervisor

Approved by: Jones Tsai / Manager



## **SPORTON INTERNATIONAL INC.**

**No. 52, Hwa Ya 1<sup>st</sup> Rd., Hwa Ya Technology Park, Kwei-Shan District, Tao Yuan City, Taiwan, R.O.C.**

SPORTON INTERNATIONAL INC.

TEL : 886-3-327-3456

FAX : 886-3-328-4978

FCC ID : ZL5S41

Page Number : 1 of 20

Report Issued Date : Aug. 21, 2017

Report Version : Rev. 01

Report Template No.: BU5-FG22/24/27 Version 2.0



# TABLE OF CONTENTS

**REVISION HISTORY..... 3**

**SUMMARY OF TEST RESULT ..... 4**

**1 GENERAL DESCRIPTION ..... 5**

    1.1 Applicant..... 5

    1.2 Manufacturer ..... 5

    1.3 Product Feature of Equipment Under Test ..... 5

    1.4 Modification of EUT ..... 5

    1.5 Testing Location ..... 6

    1.6 Applicable Standards ..... 6

**2 TEST CONFIGURATION OF EQUIPMENT UNDER TEST ..... 7**

    2.1 Test Mode..... 7

    2.2 Connection Diagram of Test System ..... 8

    2.3 Support Unit used in test configuration ..... 8

    2.4 Measurement Results Explanation Example ..... 8

    2.5 Frequency List of Low/Middle/High Channels..... 9

**3 CONDUCTED TEST RESULT..... 10**

    3.1 Measuring Instruments..... 10

    3.2 Test Setup ..... 10

    3.3 Test Result of Conducted Test..... 10

    3.4 Conducted Output Power and ERP/EIRP ..... 11

    3.5 Peak-to-Average Ratio ..... 12

    3.6 99% Occupied Bandwidth and 26dB Bandwidth Measurement..... 13

    3.7 Conducted Band Edge ..... 14

    3.8 Conducted Spurious Emission ..... 15

    3.9 Frequency Stability..... 16

**4 RADIATED TEST ITEMS ..... 17**

    4.1 Measuring Instruments..... 17

    4.2 Test Setup ..... 17

    4.3 Test Result of Radiated Test..... 17

    4.4 Field Strength of Spurious Radiation Measurement ..... 18

**5 LIST OF MEASURING EQUIPMENT ..... 19**

**6 UNCERTAINTY OF EVALUATION ..... 20**

**APPENDIX A. TEST RESULTS OF CONDUCTED TEST**

**APPENDIX B. TEST RESULTS OF RADIATED TEST**

**APPENDIX C. TEST SETUP PHOTOGRAPHS**





## SUMMARY OF TEST RESULT

Report Section	FCC Rule	Description	Limit	Result	Remark
3.4	§2.1046	Conducted Output Power	Reporting Only	PASS	-
	§22.913(a)(2)	Effective Radiated Power	< 7 Watts	PASS	-
	§24.232(c)	Equivalent Isotropic Radiated Power	< 2 Watts	PASS	-
	§27.50(d)(4)	Equivalent Isotropic Radiated Power	< 1 Watts	PASS	-
3.5	§24.232(d)	Peak-to-Average Ratio	< 13 dB	PASS	-
3.6	§2.1049 §22.917(b) §24.238(b) §27.53(g)	Occupied Bandwidth	Reporting Only	PASS	-
3.7	§2.1051 §22.917(a) §24.238(a) §27.53(h)	Band Edge Measurement	< 43+10log <sub>10</sub> (P[Watts])	PASS	-
3.8	§2.1051 §22.917(a) §24.238(a) §27.53(h)	Conducted Emission	< 43+10log <sub>10</sub> (P[Watts])	PASS	-
3.9	§2.1055 §22.355	Frequency Stability for Temperature & Voltage	< 2.5 ppm for Part 22	PASS	-
	§2.1055 §24.235 §27.54		Within Authorized Band		
4.4	§2.1053 §22.917(a) §24.238(a) §27.53(h)	Field Strength of Spurious Radiation	< 43+10log <sub>10</sub> (P[Watts])	PASS	Under limit 18.88dB at 13860.000 MHz



# 1 General Description

## 1.1 Applicant

**Bullitt Group**

One Valpy, Valpy Street, Reading, Berkshire, England RG1 1AR

## 1.2 Manufacturer

**Compal Electronics, INC.**

No. 385, Yangguang St. Neihu District, Taipei City 11491, Taiwan, R.O.C

## 1.3 Product Feature of Equipment Under Test

GSM/WCDMA/LTE, Bluetooth, Wi-Fi 2.4GHz 802.11b/g/n, Wi-Fi 5GHz 802.11a/n, FM Receiver, NFC, and GPS.

Product Specification subjective to this standard	
Antenna Type	WWAN: PIFA + Coupling type (LDS) Antenna WLAN: PIFA Antenna Bluetooth: PIFA Antenna GPS / Glonass : PIFA Antenna NFC: Loop Antenna FM: Integral Antenna (Earphone acting as FM antenna deemed as an integral antenna)

<Sample Information>

S41 has 2 different Variant	
Sample 1	Dual SIM
Sample 2	Single SIM
For Dual-SIM or Single-SIM control by SW, The HW difference is SIM holder.	

Remark: All test items were performed with Sample 1.

## 1.4 Modification of EUT

No modifications are made to the EUT during all test items.



### 1.5 Testing Location

Sporton Lab is accredited to ISO 17025 by Taiwan Accreditation Foundation (TAF code : 1190) and the FCC designation No. TW0007 under the FCC 2.948(e) by Mutual Recognition Agreement (MRA) in FCC Test.

<b>Test Site</b>	SPORTON INTERNATIONAL INC.
<b>Test Site Location</b>	No. 52, Hwa Ya 1 <sup>st</sup> Rd., Hwa Ya Technology Park, Kwei-Shan District, Tao Yuan City, Taiwan, R.O.C. TEL: +886-3-327-3456 FAX: +886-3-328-4978
<b>Test Site No.</b>	<b>Sporton Site No.</b>
	TH03-HY

<b>Test Site</b>	SPORTON INTERNATIONAL INC.
<b>Test Site Location</b>	No.58, Aly. 75, Ln. 564, Wenhua 3rd Rd. Guishan Dist, Taoyuan City, Taiwan (R.O.C.) TEL: +886-3-327-0868 FAX: +886-3-327-0855
<b>Test Site No.</b>	<b>Sporton Site No.</b>
	03CH13-HY

### 1.6 Applicable Standards

According to the specifications of the manufacturer, the EUT must comply with the requirements of the following standards:

- 47 CFR Part 2, 22(H), 24(E), 27(L)
- ANSI / TIA / EIA-603-D-2010
- FCC KDB 971168 D01 Power Meas. License Digital Systems v02r02
- FCC KDB 412172 D01 Determining ERP and EIRP v01r01

**Remark:**

1. All test items were verified and recorded according to the standards and without any deviation during the test.
2. This EUT has also been tested and complied with the requirements of FCC Part 15, Subpart B, recorded in a separate test report.



## 2 Test Configuration of Equipment Under Test

### 2.1 Test Mode

Antenna port conducted and radiated test items were performed according to KDB 971168 D01 Power Meas. License Digital Systems v02r02 with maximum output power.

Radiated measurements were performed with rotating EUT in different three orthogonal test planes to find the maximum emission.

Radiated emissions were investigated as following frequency range:

1. 30 MHz to 9000 MHz for GSM850 and WCDMA Band V.
2. 30 MHz to 18000 MHz for WCDMA Band IV.
3. 30 MHz to 19100 MHz for GSM1900 and WCDMA Band II.

All modes and data rates and positions were investigated.

Test modes are chosen to be reported as the worst case configuration below:

Test Modes		
Band	Radiated TCs	Conducted TCs
GSM 850	<ul style="list-style-type: none"> <li>■ GSM Link</li> <li>■ EDGE class 8 Link</li> </ul>	<ul style="list-style-type: none"> <li>■ GSM Link</li> <li>■ EDGE class 8 Link</li> </ul>
GSM 1900	<ul style="list-style-type: none"> <li>■ GPRS class 8 Link</li> <li>■ EDGE class 8 Link</li> </ul>	<ul style="list-style-type: none"> <li>■ GPRS class 8 Link</li> <li>■ EDGE class 8 Link</li> </ul>
WCDMA Band V	<ul style="list-style-type: none"> <li>■ RMC 12.2Kbps Link</li> </ul>	<ul style="list-style-type: none"> <li>■ RMC 12.2Kbps Link</li> </ul>
WCDMA Band II	<ul style="list-style-type: none"> <li>■ RMC 12.2Kbps Link</li> </ul>	<ul style="list-style-type: none"> <li>■ RMC 12.2Kbps Link</li> </ul>
WCDMA Band IV	<ul style="list-style-type: none"> <li>■ RMC 12.2Kbps Link</li> </ul>	<ul style="list-style-type: none"> <li>■ RMC 12.2Kbps Link</li> </ul>

## 2.2 Connection Diagram of Test System

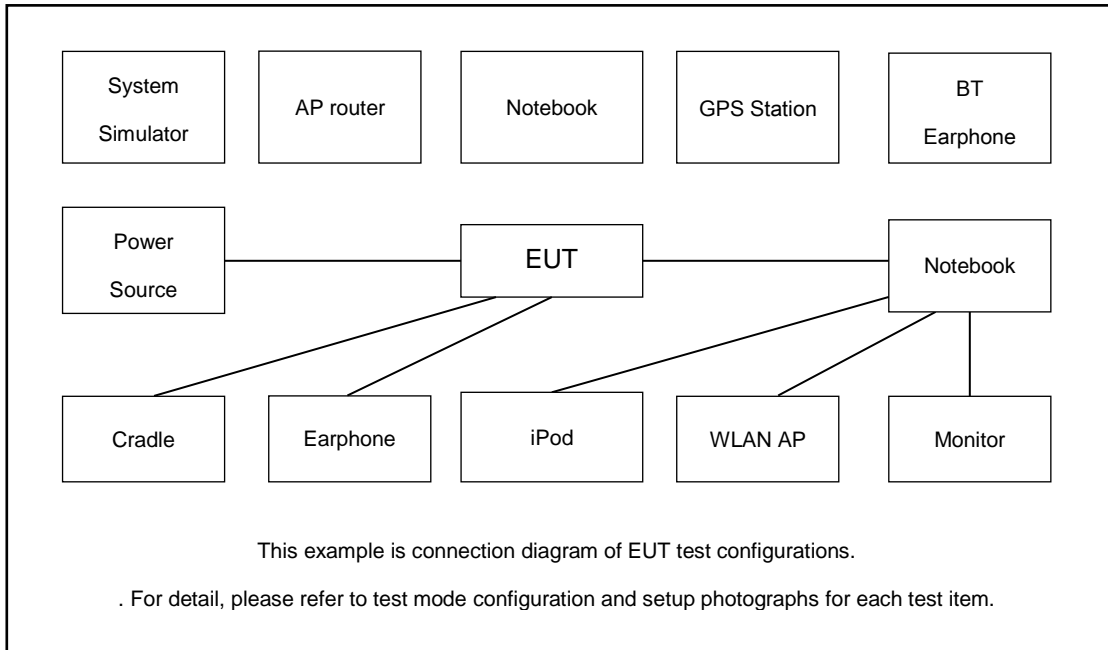

## 2.3 Support Unit used in test configuration

Item	Equipment	Trade Name	Model No.	FCC ID	Data Cable	Power Cord
1.	System Simulator	R&S	CMU 200	N/A	N/A	Unshielded, 1.8 m

## 2.4 Measurement Results Explanation Example

### For all conducted test items:

The offset level is set in the spectrum analyzer to compensate the RF cable loss and attenuator factor between RF conducted output port and spectrum analyzer. With the offset compensation, the spectrum analyzer reading level will be exactly the RF output level.

The spectrum analyzer offset is derived from RF cable loss and attenuator factor.

*Offset = RF cable loss + attenuator factor.*

The following shows an offset computation example with RF cable loss 4.2 dB and a 10dB attenuator.

Example :

$$\begin{aligned} \text{Offset}(dB) &= \text{RF cable loss}(dB) + \text{attenuator factor}(dB). \\ &= 4.2 + 10 = 14.2 \text{ (dB)} \end{aligned}$$





## 2.5 Frequency List of Low/Middle/High Channels

Frequency List				
Band	Channel/Frequency(MHz)	Lowest	Middle	Highest
GSM850	Channel	128	189	251
	Frequency	824.2	836.4	848.8
WCDMA Band V	Channel	4132	4182	4233
	Frequency	826.4	836.4	846.6
GSM1900	Channel	512	661	810
	Frequency	1850.2	1880.0	1909.8
WCDMA Band II	Channel	9262	9400	9538
	Frequency	1852.4	1880.0	1907.6
WCDMA Band IV	Channel	1312	1413	1513
	Frequency	1712.4	1732.6	1752.6

### 3 Conducted Test Result

#### 3.1 Measuring Instruments

See list of measuring instruments of this test report.

#### 3.2 Test Setup

##### 3.2.1 Conducted Output Power

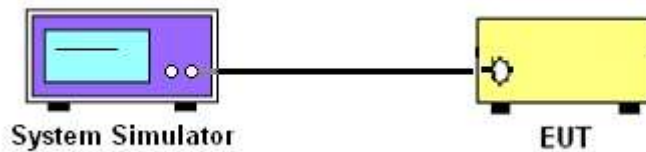

##### 3.2.2 Peak-to-Average Ratio, Occupied Bandwidth, Conducted Band-Edge and Conducted Spurious Emission

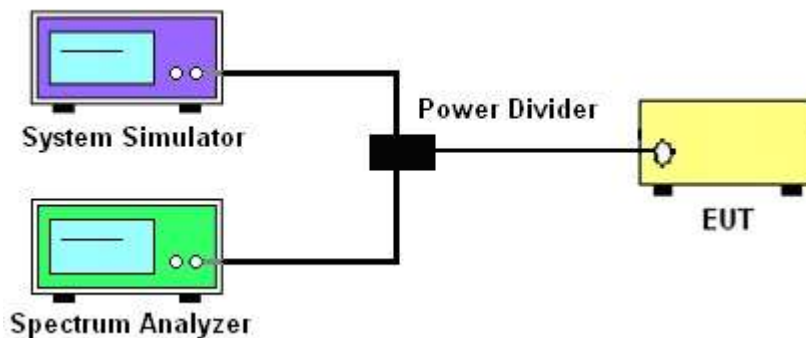

##### 3.2.3 Frequency Stability

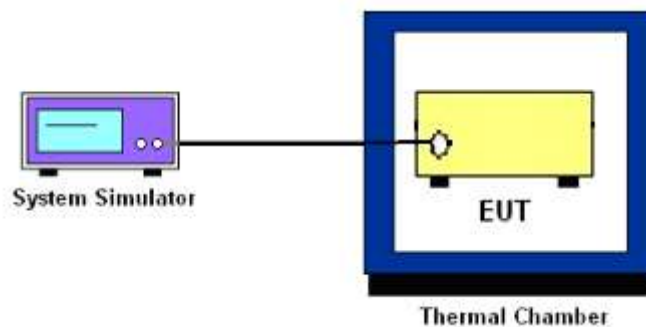

### 3.3 Test Result of Conducted Test

Please refer to Appendix A.



### 3.4 Conducted Output Power and ERP/EIRP

#### 3.4.1 Description of the Conducted Output Power and ERP/EIRP

A system simulator was used to establish communication with the EUT. Its parameters were set to enforce EUT transmitting at the maximum power. The measured power in the radio frequency on the transmitter output terminals shall be reported.

The ERP of mobile transmitters must not exceed 7 Watts for GSM850 and WCDMA Band V.

The EIRP of mobile transmitters must not exceed 2 Watts for GSM1900 and WCDMA Band II.

The EIRP of mobile transmitters must not exceed 1 Watts for WCDMA Band IV.

According to KDB 412172 D01 Power Approach,

$EIRP = P_T + G_T - L_C$ ,  $ERP = EIRP - 2.15$ , where

$P_T$  = transmitter output power in dBm

$G_T$  = gain of the transmitting antenna in dBi

$L_C$  = signal attenuation in the connecting cable between the transmitter and antenna in dB

#### 3.4.2 Test Procedures

1. The transmitter output port was connected to the system simulator.
2. Set EUT at maximum power through system simulator.
3. Select lowest, middle, and highest channels for each band and different modulation.
4. Measure the maximum burst average power for GSM and maximum average power for other modulation signal.



## **3.5 Peak-to-Average Ratio**

### **3.5.1 Description of the PAR Measurement**

The peak-to-average ratio (PAR) of the transmission may not exceed 13 dB.

### **3.5.2 Test Procedures**

1. The testing follows FCC KDB 971168 D01 v02r02 Section 5.7.1.
2. The EUT was connected to spectrum analyzer and system simulator via a power divider.
3. Set EUT to transmit at maximum output power.
4. When the duty cycle is less than 98%, then signal gating will be implemented on the spectrum analyzer by triggering from the system simulator.
5. Set the CCDF (Complementary Cumulative Distribution Function) option of the spectrum analyzer.  
Record the maximum PAPR level associated with a probability of 0.1%.



## **3.6 99% Occupied Bandwidth and 26dB Bandwidth Measurement**

### **3.6.1 Description of 99% Occupied Bandwidth and 26dB Bandwidth Measurement**

The occupied bandwidth is the width of a frequency band such that, below the lower and above the upper frequency limits, the mean powers emitted are each equal to a specified percentage 0.5% of the total mean transmitted power.

The 26 dB emission bandwidth is defined as the frequency range between two points, one above and one below the carrier frequency, at which the spectral density of the emission is attenuated 26 dB below the maximum in-band spectral density of the modulated signal. Spectral density (power per unit bandwidth) is to be measured with a detector of resolution bandwidth equal to approximately 1.0% of the emission bandwidth.

### **3.6.2 Test Procedures**

1. The testing follows FCC KDB 971168 v02r02 Section 4.2.
2. The EUT was connected to spectrum analyzer and system simulator via a power divider.
3. The spectrum analyzer center frequency is set to the nominal EUT channel center frequency. The span range for the spectrum analyzer shall be between two and five times the anticipated OBW.
4. The nominal resolution bandwidth (RBW) shall be in the range of 1 to 5 % of the anticipated OBW, and the VBW shall be at least 3 times the RBW.
5. Set the detection mode to peak, and the trace mode to max hold.
6. Determine the reference value: Set the EUT to transmit a modulated signal. Allow the trace to stabilize. Set the spectrum analyzer marker to the highest level of the displayed trace.  
(this is the reference value)
7. Determine the “-26 dB down amplitude” as equal to (Reference Value – X).
8. Place two markers, one at the lowest and the other at the highest frequency of the envelope of the spectral display such that each marker is at or slightly below the “-X dB down amplitude” determined in step 6. If a marker is below this “-X dB down amplitude” value it shall be placed as close as possible to this value. The OBW is the positive frequency difference between the two markers.
9. Use the 99 % power bandwidth function of the spectrum analyzer and report the measured bandwidth.



## **3.7 Conducted Band Edge**

### **3.7.1 Description of Conducted Band Edge Measurement**

The power of any emission outside of the authorized operating frequency ranges must be lower than the transmitter power (P) by a factor of at least  $43 + 10 \log (P)$  dB.

### **3.7.2 Test Procedures**

1. The testing follows FCC KDB 971168 D01 v02r02 Section 6.0.
2. The EUT was connected to the spectrum analyzer and system simulator via a power divider.
3. The RF output of EUT was connected to the spectrum analyzer by an RF cable and attenuator. The path loss was compensated to the results for each measurement.
4. The band edges of low and high channels for the highest RF powers were measured.
5. The RF fundamental frequency should be excluded against the limit line in the operating frequency band.
6. The limit line is derived from  $43 + 10\log(P)$  dB below the transmitter power P(Watts)



### 3.8 Conducted Spurious Emission

#### 3.8.1 Description of Conducted Spurious Emission Measurement

The power of any emission outside of the authorized operating frequency ranges must be lower than the transmitter power (P) by a factor of at least  $43 + 10 \log (P)$  dB.

It is measured by means of a calibrated spectrum analyzer and scanned from 30 MHz up to a frequency including its 10<sup>th</sup> harmonic.

#### 3.8.2 Test Procedures

1. The testing follows FCC KDB 971168 D01 v02r02 Section 6.0.
2. The EUT was connected to the spectrum analyzer and system simulator via a power divider.
3. The RF output of EUT was connected to the spectrum analyzer by an RF cable and attenuator. The path loss was compensated to the results for each measurement.
4. The middle channel for the highest RF power within the transmitting frequency was measured.
5. The conducted spurious emission for the whole frequency range was taken.
6. The RF fundamental frequency should be excluded against the limit line in the operating frequency band.
7. The limit line is derived from  $43 + 10\log(P)$  dB below the transmitter power P(Watts)



### 3.9 Frequency Stability

#### 3.9.1 Description of Frequency Stability Measurement

The frequency stability shall be measured by variation of ambient temperature and variation of primary supply voltage to ensure that the fundamental emission stays within the authorized frequency block. The frequency stability of the transmitter shall be maintained within  $\pm 0.00025\%$  ( $\pm 2.5\text{ppm}$ ) of the center frequency.

#### 3.9.2 Test Procedures for Temperature Variation

1. The testing follows FCC KDB 971168 D01 v02r02 Section 9.0.
2. The EUT was set up in the thermal chamber and connected with the system simulator.
3. With power OFF, the temperature was decreased to  $-30^{\circ}\text{C}$  and the EUT was stabilized before testing. Power was applied and the maximum change in frequency was recorded within one minute.
4. With power OFF, the temperature was raised in  $10^{\circ}\text{C}$  steps up to  $50^{\circ}\text{C}$ . The EUT was stabilized at each step for at least half an hour. Power was applied and the maximum frequency change was recorded within one minute.

#### 3.9.3 Test Procedures for Voltage Variation

1. The testing follows FCC KDB 971168 D01 v02r02 Section 9.0.
2. The EUT was placed in a temperature chamber at  $20\pm 5^{\circ}\text{C}$  and connected with the system simulator.
3. The power supply voltage to the EUT was varied from 85% to 115% of the nominal value measured at the input to the EUT.
4. The variation in frequency was measured for the worst case.



## 4 Radiated Test Items

### 4.1 Measuring Instruments

See list of measuring instruments of this test report.

### 4.2 Test Setup

#### 4.2.1 For radiated test from 30MHz to 1GHz

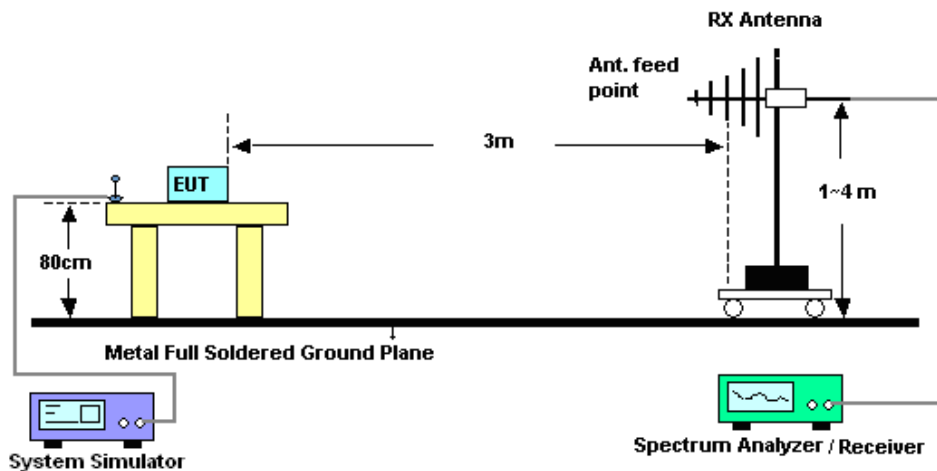

#### 4.2.2 For radiated test above 1GHz

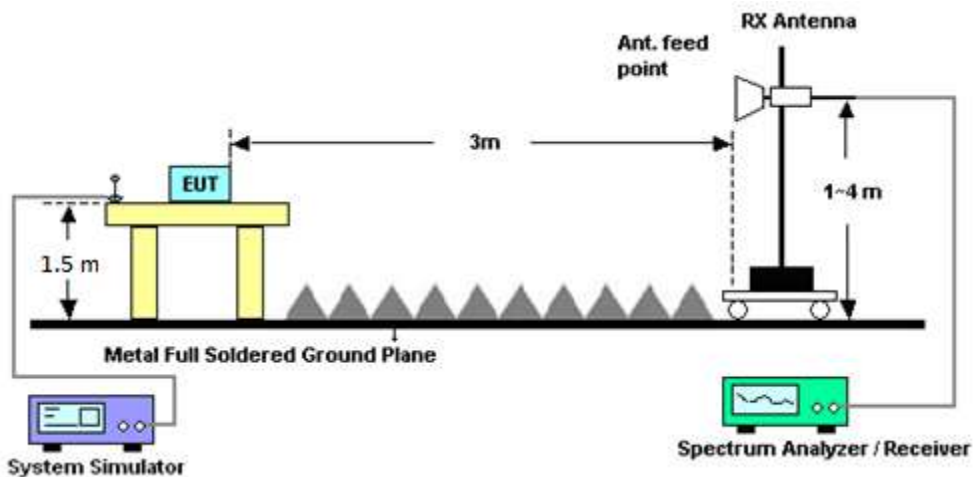

### 4.3 Test Result of Radiated Test

Please refer to Appendix B.



## **4.4 Field Strength of Spurious Radiation Measurement**

### **4.4.1 Description of Field Strength of Spurious Radiated Measurement**

The power of any emission outside of the authorized operating frequency ranges must be attenuated below the transmitter power (P) by a factor of at least  $43 + 10 \log (P)$  dB. The spectrum is scanned from 30 MHz up to a frequency including its 10th harmonic.

### **4.4.2 Test Procedures**

1. The testing follows FCC KDB 971168 D01 v02r02 Section 5.8 and ANSI / TIA-603-D-2010 Section 2.2.12.
2. The EUT was placed on a rotatable wooden table 0.8 meters for frequency below 1GHz and 1.5 meter for frequency above 1GHz above the ground.
3. The EUT was set 3 meters from the receiving antenna, which was mounted on the antenna tower.
4. The table was rotated 360 degrees to determine the position of the highest spurious emission.
5. The height of the receiving antenna is varied between one meter and four meters to search for the maximum spurious emission for both horizontal and vertical polarizations.
6. Make the measurement with the spectrum analyzer's RBW = 1MHz, VBW = 3MHz, taking record of maximum spurious emission.
7. A horn antenna was substituted in place of the EUT and was driven by a signal generator.
8. Tune the output power of signal generator to the same emission level with EUT maximum spurious emission.
9. Taking the record of output power at antenna port.
10. Repeat step 7 to step 8 for another polarization.
11.  $EIRP \text{ (dBm)} = S.G. \text{ Power} - Tx \text{ Cable Loss} + Tx \text{ Antenna Gain}$
12.  $ERP \text{ (dBm)} = EIRP - 2.15$
13. The RF fundamental frequency should be excluded against the limit line in the operating frequency band.
14. The limit line is derived from  $43 + 10\log(P)$  dB below the transmitter power P(Watts)



## 5 List of Measuring Equipment

Instrument	Manufacturer	Model No.	Serial No.	Characteristics	Calibration Date	Test Date	Due Date	Remark
Spectrum Analyzer	Rohde & Schwarz	FSP30	101329	9kHz~30GHz	Jun. 26, 2017	Aug. 07, 2017 ~ Aug. 08, 2017	Jun. 25, 2018	Conducted (TH03-HY)
Temperature Chamber	ESPEC	SU-641	92013721	-30°C ~70°C	Nov. 16, 2016	Aug. 07, 2017 ~ Aug. 08, 2017	Nov. 15, 2017	Conducted (TH03-HY)
Programmable Power Supply	GW Instek	PSS-2005	EL883644	Voltage:0~20V;Current:0~5A	Nov. 22, 2016	Aug. 07, 2017 ~ Aug. 08, 2017	Nov. 21, 2017	Conducted (TH03-HY)
Base Station (Measure)	Rohde & Schwarz	CMU200	117997	GSM / GPRS / WCDMA / CDMA	Aug. 19, 2016	Aug. 07, 2017 ~ Aug. 08, 2017	Aug. 18, 2017	Conducted (TH03-HY)
EMI Test Receiver	Keysight	N9038A(MXE)	MY55420170	N/A	Mar. 03, 2017	Aug. 10, 2017 ~ Aug. 14, 2017	Mar. 02, 2018	Radiation (03CH13-HY)
Amplifier	Sonoma-Instrument	310 N	187282	9KHz~1GHz	Dec. 21, 2016	Aug. 10, 2017 ~ Aug. 14, 2017	Dec. 20, 2017	Radiation (03CH13-HY)
Bilog Antenna	TESEQ	CBL 6111D&008	40103&04	30MHz to 1GHz	Jan. 07, 2017	Aug. 10, 2017 ~ Aug. 14, 2017	Jan. 06, 2018	Radiation (03CH13-HY)
Preamplifier	MITEQ	AMF-7D-00101800-30-10P	1590074	1GHz~18GHz	May 22, 2017	Aug. 10, 2017 ~ Aug. 14, 2017	May 21, 2018	Radiation (03CH13-HY)
Preamplifier	Keysight	83017A	MY53270147	1GHz~26.5GHz	Jan. 09, 2017	Aug. 10, 2017 ~ Aug. 14, 2017	Jan. 08, 2018	Radiation (03CH13-HY)
Spectrum Analyzer	Keysight	N9010A	MY55370526	N/A	Mar. 15, 2017	Aug. 10, 2017 ~ Aug. 14, 2017	Mar. 14, 2018	Radiation (03CH13-HY)
Antenna Mast	E MEC	AM-BS-4500-B	N/A	1m~4m	N/A	Aug. 10, 2017 ~ Aug. 14, 2017	N/A	Radiation (03CH13-HY)
Turn Table	E MEC	TT2000	N/A	0~360 Degree	N/A	Aug. 10, 2017 ~ Aug. 14, 2017	N/A	Radiation (03CH13-HY)
SHF-EHF Horn Antenna	SCHWARZBECK	BBHA 9170	BBHA9170584	18GHz- 40GHz	Nov. 08, 2016	Aug. 10, 2017 ~ Aug. 14, 2017	Nov. 07, 2017	Radiation (03CH13-HY)
Horn Antenna	SCHWARZBECK	BBHA 9120D	9120D-1522	1G~18GHz	Mar. 17, 2017	Aug. 10, 2017 ~ Aug. 14, 2017	Mar. 16, 2018	Radiation (03CH13-HY)
Horn Antenna	SCHWARZBECK	BBHA 9120D	9120D-1620	1G~18GHz	Sep. 30, 2016	Aug. 10, 2017 ~ Aug. 14, 2017	Sep. 29, 2017	Radiation (03CH13-HY)
Preamplifier	MITEQ	TTA 1840-35-HG	1887435	18GHz ~ 40GHz	Oct. 13, 2016	Aug. 10, 2017 ~ Aug. 14, 2017	Oct. 12, 2017	Radiation (03CH13-HY)
Signal Generator	Anritsu	MG3694C	163401	0.1Hz~40GHz	Jan. 04, 2017	Aug. 10, 2017 ~ Aug. 14, 2017	Jan. 03, 2018	Radiation (03CH13-HY)



## 6 Uncertainty of Evaluation

### Uncertainty of Radiated Emission Measurement (30 MHz ~ 1000 MHz)

Measuring Uncertainty for a Level of Confidence of 95% ( $U = 2Uc(y)$ )	3.07
---	------

### Uncertainty of Radiated Emission Measurement (1 GHz ~ 18 GHz)

Measuring Uncertainty for a Level of Confidence of 95% ( $U = 2Uc(y)$ )	3.48
---	------

### Uncertainty of Radiated Emission Measurement (18 GHz ~ 40 GHz)

Measuring Uncertainty for a Level of Confidence of 95% ( $U = 2Uc(y)$ )	3.92
---	------



## Appendix A. Test Results of Conducted Test

### Conducted Output Power(Average power)

Conducted Power (*Unit: dBm)						
Band	GSM850			GSM1900		
Channel	128	189	251	512	661	810
Frequency	824.2	836.4	848.8	1850.2	1880	1909.8
GSM	33.09	<b>33.10</b>	33.07	29.60	29.69	29.79
GPRS class 8	33.07	33.08	33.05	29.66	29.80	<b>29.95</b>
GPRS class 10	29.74	29.75	29.72	26.83	27.00	27.26
GPRS class 11	27.99	27.99	27.95	25.06	25.23	25.47
GPRS class 12	26.64	26.65	26.63	23.22	23.41	23.66
EGPRS class 8	25.97	<b>26.06</b>	25.99	24.15	24.32	<b>24.36</b>
EGPRS class 10	25.78	25.90	25.86	24.03	24.21	24.20
EGPRS class 11	25.62	25.69	25.60	23.83	24.00	23.98
EGPRS class 12	25.34	25.47	25.44	23.34	23.27	23.27

Conducted Power (*Unit: dBm)						
Band	WCDMA Band V			WCDMA Band II		
Channel	4132	4182	4233	9262	9400	9538
Frequency	826.4	836.4	846.6	1852.4	1880	1907.6
RMC 12.2K	22.68	22.74	<b>22.77</b>	22.42	22.46	<b>22.56</b>
HSDPA Subtest-1	21.74	21.68	21.70	21.55	21.56	21.64
HSDPA Subtest-2	21.70	21.72	21.76	21.49	21.55	21.62
HSDPA Subtest-3	21.30	21.28	21.21	21.07	21.06	21.20
HSDPA Subtest-4	21.21	21.26	21.23	20.96	21.09	21.10
HSUPA Subtest-1	19.69	19.75	19.68	20.04	20.06	20.15
HSUPA Subtest-2	19.68	19.73	19.71	19.93	19.96	19.94
HSUPA Subtest-3	20.61	20.70	20.71	19.92	19.90	19.95
HSUPA Subtest-4	19.38	19.33	19.41	19.65	19.66	19.74
HSUPA Subtest-5	20.68	20.76	20.64	20.44	20.55	20.64



Conducted Power (*Unit: dBm)			
Band	WCDMA Band IV		
Channel	1312	1413	1513
Frequency	1712.4	1732.6	1752.6
RMC 12.2K	23.88	<b>23.92</b>	23.82
HSDPA Subtest-1	22.88	22.99	22.91
HSDPA Subtest-2	22.88	22.95	22.87
HSDPA Subtest-3	22.45	22.42	22.38
HSDPA Subtest-4	22.40	22.40	22.40
HSUPA Subtest-1	21.00	21.02	21.03
HSUPA Subtest-2	20.83	20.95	20.87
HSUPA Subtest-3	21.85	21.93	21.83
HSUPA Subtest-4	20.36	20.54	20.53
HSUPA Subtest-5	21.82	21.99	21.84



# A1. GSM

## Peak-to-Average Ratio

Mode	GSM850		Limit: 13dB
Mod.	GSM	EDGE class 8	Result
Lowest CH	0.20	3.32	PASS
Middle CH	0.16	3.28	
Highest CH	0.20	3.12	

Mode	GSM1900		Limit: 13dB
Mod.	GPRS class 8	EDGE class 8	Result
Lowest CH	0.24	3.24	PASS
Middle CH	0.20	3.28	
Highest CH	0.20	3.32	



GSM850 (GSM)	GSM850 (EDGE class 8)
<p align="center"><b>Lowest Channel</b></p> <p>Center 824.2 MHz    2 dB/    Mean Pwr + 20 dB</p> <p>Complementary Cumulative Distribution Function (100000 samples)</p> <p>Trace 1</p> <p>Mean 32.05 dBm Peak 32.22 dBm Crest 0.16 dB</p> <p>10 % 0.16 dB 1 % 0.20 dB .1 % 0.20 dB .01 % 0.20 dB</p> <p>Date: 7.AUG.2017 09:40:19</p>	<p align="center"><b>Lowest Channel</b></p> <p>Center 824.2 MHz    2 dB/    Mean Pwr + 20 dB</p> <p>Complementary Cumulative Distribution Function (100000 samples)</p> <p>Trace 1</p> <p>Mean 26.15 dBm Peak 29.54 dBm Crest 3.38 dB</p> <p>10 % 2.56 dB 1 % 3.16 dB .1 % 3.32 dB .01 % 3.36 dB</p> <p>Date: 7.AUG.2017 09:52:23</p>
<p align="center"><b>Middle Channel</b></p> <p>Center 836.4 MHz    2 dB/    Mean Pwr + 20 dB</p> <p>Complementary Cumulative Distribution Function (100000 samples)</p> <p>Trace 1</p> <p>Mean 31.92 dBm Peak 32.15 dBm Crest 0.23 dB</p> <p>10 % 0.16 dB 1 % 0.16 dB .1 % 0.16 dB .01 % 0.20 dB</p> <p>Date: 7.AUG.2017 09:40:35</p>	<p align="center"><b>Middle Channel</b></p> <p>Center 836.4 MHz    2 dB/    Mean Pwr + 20 dB</p> <p>Complementary Cumulative Distribution Function (100000 samples)</p> <p>Trace 1</p> <p>Mean 26.13 dBm Peak 29.47 dBm Crest 3.33 dB</p> <p>10 % 2.56 dB 1 % 3.16 dB .1 % 3.28 dB .01 % 3.32 dB</p> <p>Date: 7.AUG.2017 09:52:35</p>
<p align="center"><b>Highest Channel</b></p> <p>Center 848.8 MHz    2 dB/    Mean Pwr + 20 dB</p> <p>Complementary Cumulative Distribution Function (100000 samples)</p> <p>Trace 1</p> <p>Mean 31.84 dBm Peak 32.01 dBm Crest 0.17 dB</p> <p>10 % 0.16 dB 1 % 0.20 dB .1 % 0.20 dB .01 % 0.20 dB</p> <p>Date: 7.AUG.2017 09:40:52</p>	<p align="center"><b>Highest Channel</b></p> <p>Center 848.8 MHz    2 dB/    Mean Pwr + 20 dB</p> <p>Complementary Cumulative Distribution Function (100000 samples)</p> <p>Trace 1</p> <p>Mean 26.24 dBm Peak 29.47 dBm Crest 3.22 dB</p> <p>10 % 2.44 dB 1 % 2.92 dB .1 % 3.12 dB .01 % 3.24 dB</p> <p>Date: 7.AUG.2017 09:52:56</p>





GSM1900 (GPRS class 8)	GSM1900 (EDGE class 8)
<p align="center"><b>Lowest Channel</b></p> <p align="center">Date: 7.AUG.2017 10:11:41</p>	<p align="center"><b>Lowest Channel</b></p> <p align="center">Date: 7.AUG.2017 10:24:00</p>
<p align="center"><b>Middle Channel</b></p> <p align="center">Date: 7.AUG.2017 10:11:56</p>	<p align="center"><b>Middle Channel</b></p> <p align="center">Date: 7.AUG.2017 10:24:12</p>
<p align="center"><b>Highest Channel</b></p> <p align="center">Date: 7.AUG.2017 10:12:08</p>	<p align="center"><b>Highest Channel</b></p> <p align="center">Date: 7.AUG.2017 10:24:26</p>



**26dB Bandwidth**

Mode	GSM850	
Mod.	GSM	EDGE class 8
Lowest CH	0.317	0.309
Middle CH	0.313	0.304
Highest CH	0.312	0.300

Mode	GSM1900	
Mod.	GPRS class 8	EDGE class 8
Lowest CH	0.291	0.312
Middle CH	0.300	0.301
Highest CH	0.315	0.306



GSM850 (GSM)

Lowest Channel

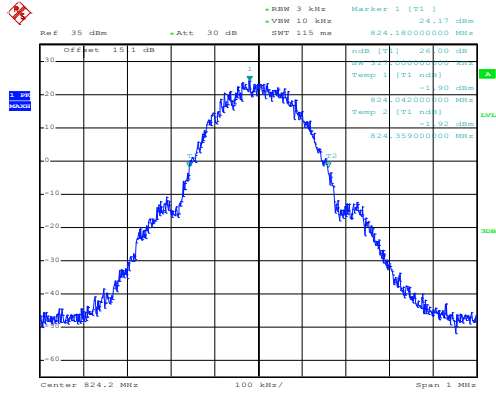

Date: 7.AUG.2017 09:23:55

GSM850 (EDGE class 8)

Lowest Channel

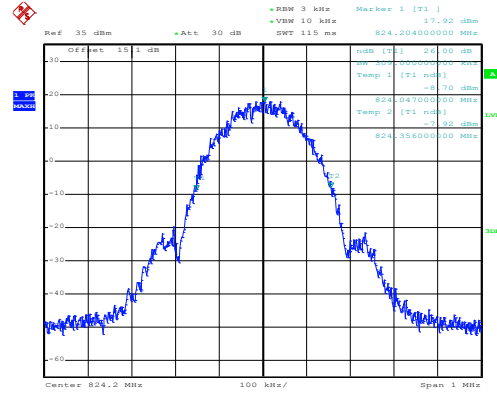

Date: 7.AUG.2017 09:42:39

Middle Channel

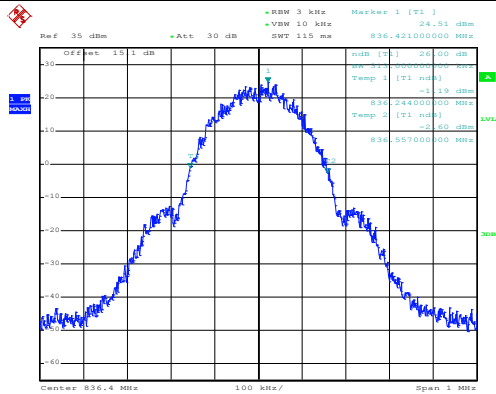

Date: 7.AUG.2017 09:24:30

Middle Channel

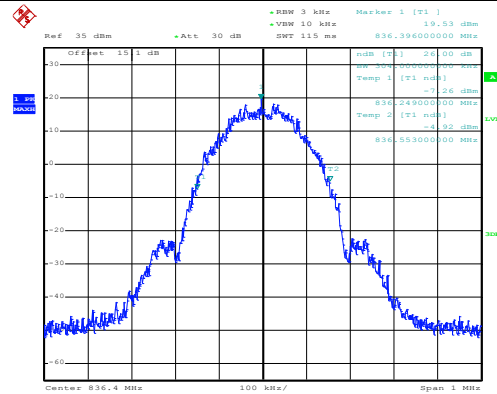

Date: 7.AUG.2017 09:43:13

Highest Channel

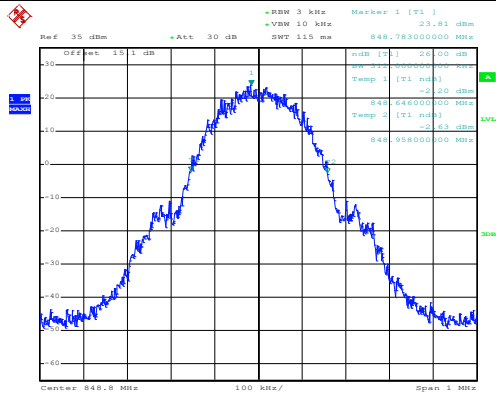

Date: 7.AUG.2017 09:25:51

Highest Channel

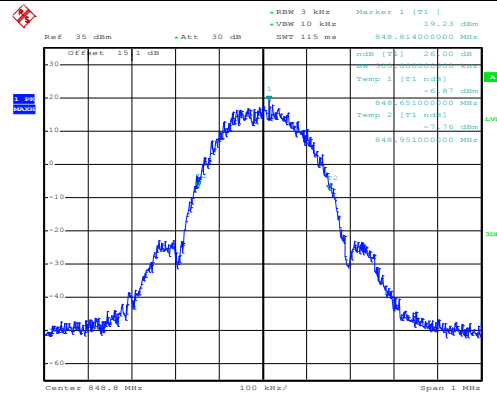

Date: 7.AUG.2017 09:43:52

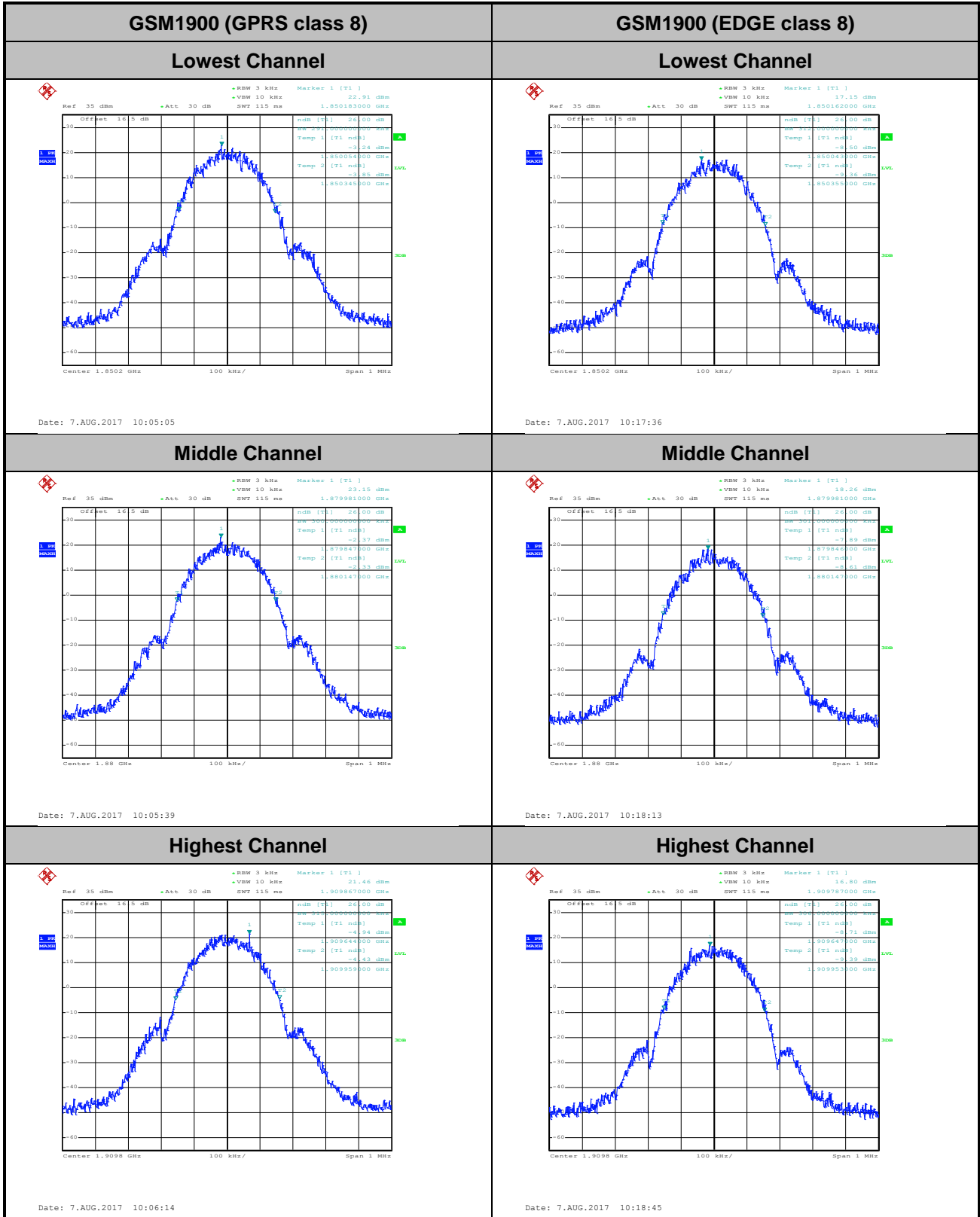



**Occupied Bandwidth**

Mode	GSM850	
Mod.	GSM	EDGE class 8
Lowest CH	0.246	0.245
Middle CH	0.244	0.244
Highest CH	0.244	0.250

Mode	GSM1900	
Mod.	GPRS class 8	EDGE class 8
Lowest CH	0.244	0.249
Middle CH	0.246	0.249
Highest CH	0.245	0.246



GSM850 (GSM)

GSM850 (EDGE class 8)

Lowest Channel

Lowest Channel

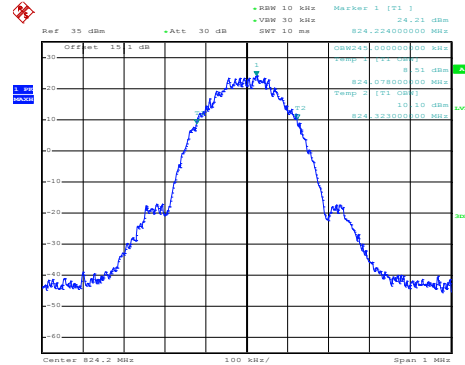
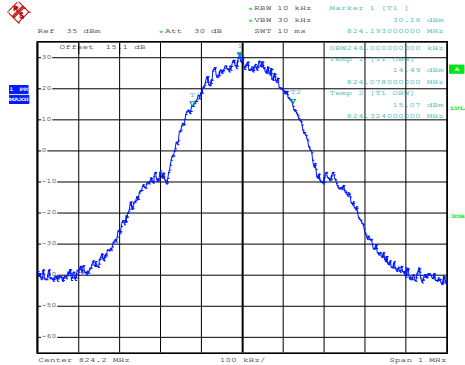

Date: 7.AUG.2017 09:29:56

Date: 7.AUG.2017 09:50:21

Middle Channel

Middle Channel

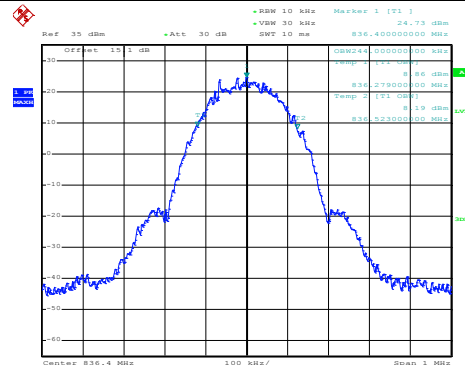
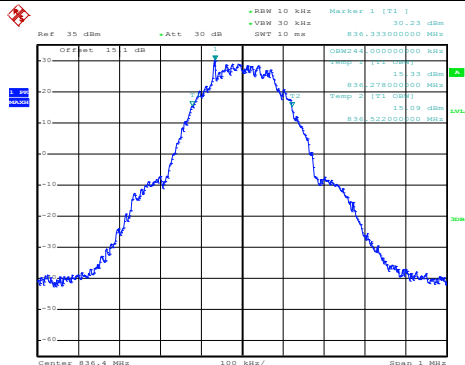

Date: 7.AUG.2017 09:30:39

Date: 7.AUG.2017 09:51:33

Highest Channel

Highest Channel

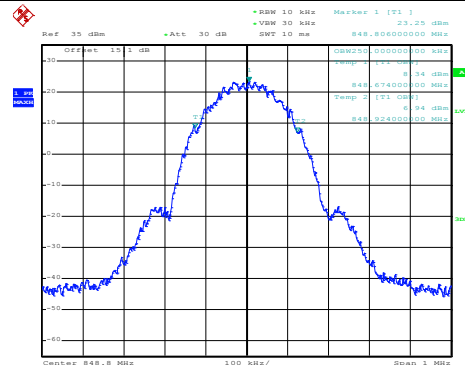
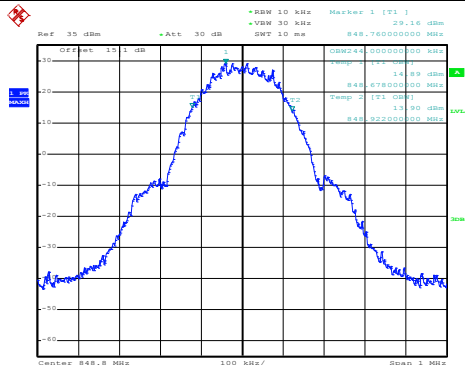

Date: 7.AUG.2017 09:31:08

Date: 7.AUG.2017 09:52:03

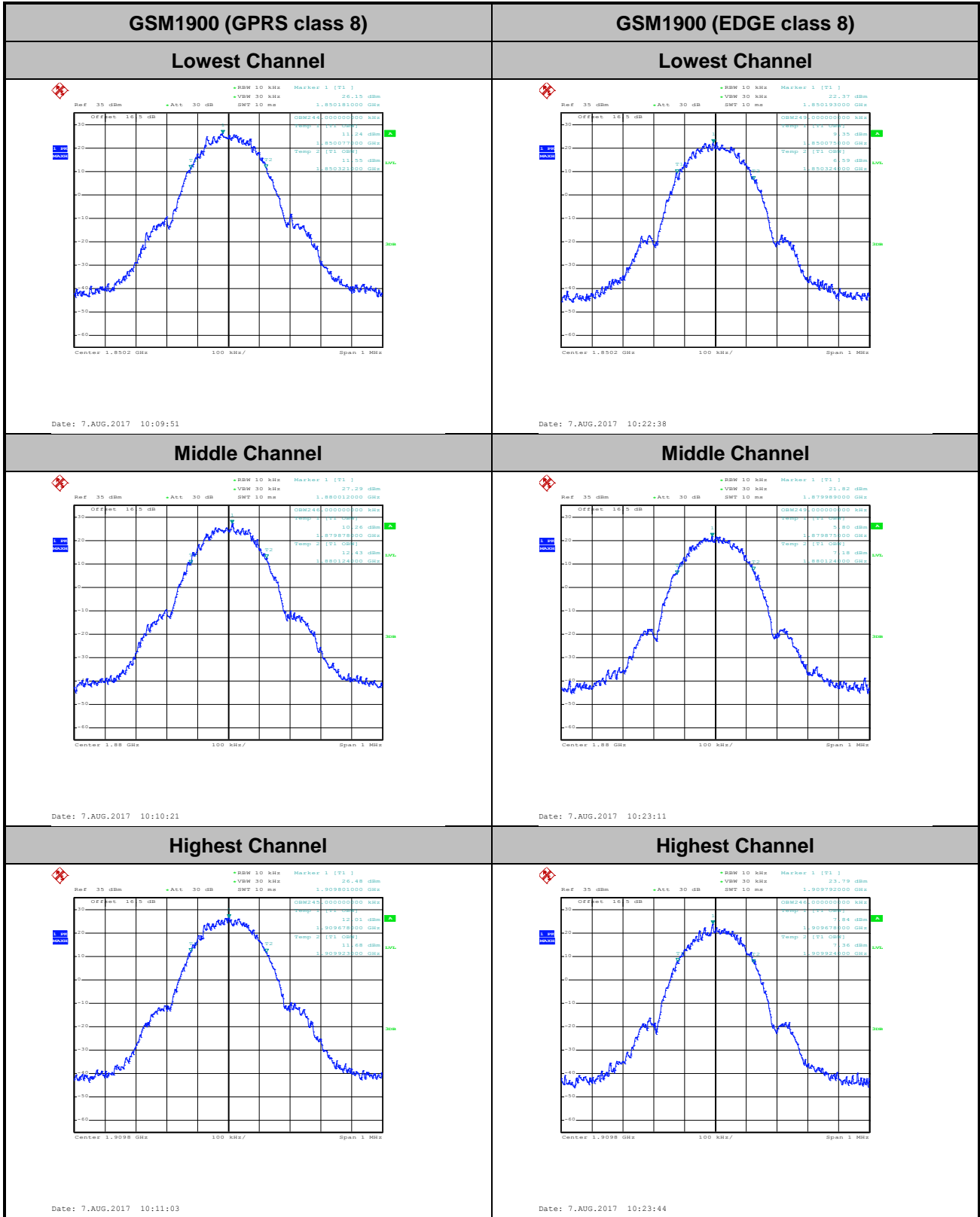



**Conducted Band Edge**





GSM850 (GSM)

Lowest Band Edge

Highest Band Edge

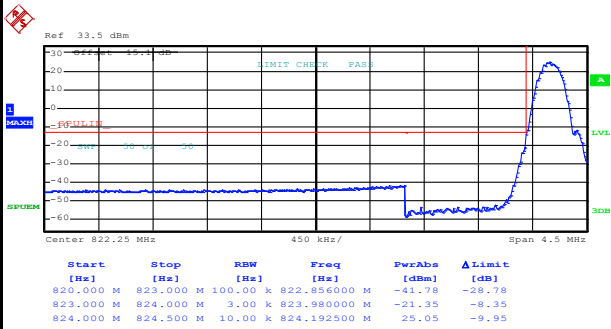

Date: 7.AUG.2017 09:33:18

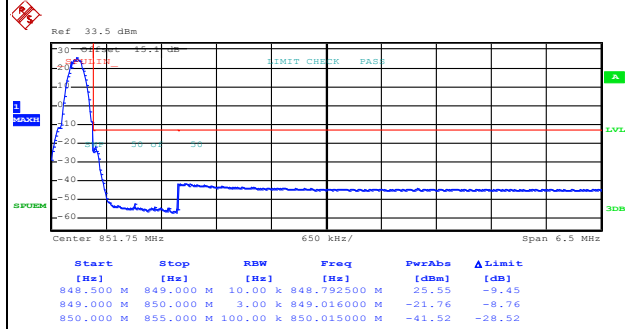

Date: 7.AUG.2017 09:36:06

GSM850 (EDGE class 8)

Lowest Band Edge

Highest Band Edge

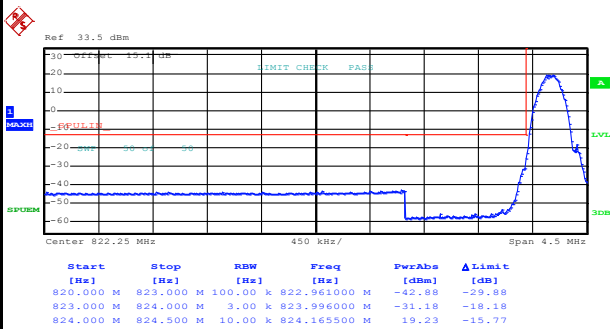

Date: 7.AUG.2017 09:54:30

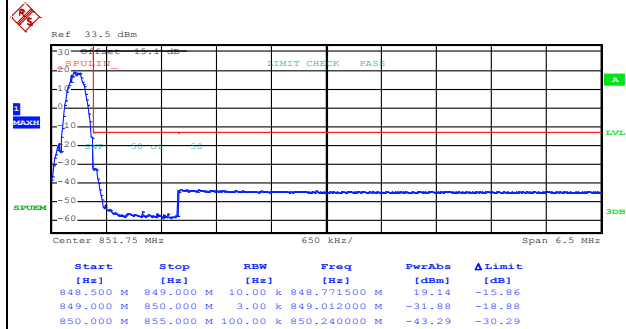

Date: 7.AUG.2017 09:57:48



GSM1900 (GPRS class 8)

Lowest Band Edge

Highest Band Edge

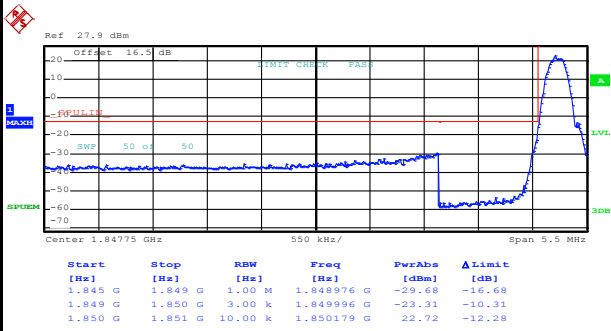

Date: 7.AUG.2017 10:13:53

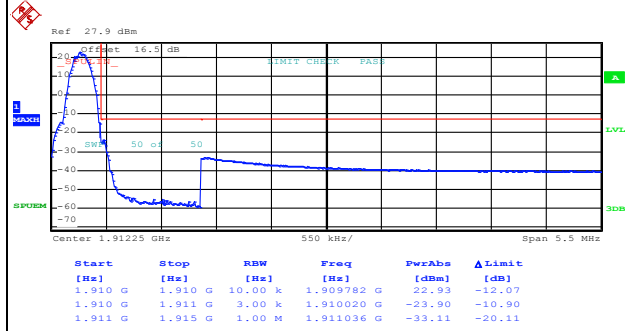

Date: 7.AUG.2017 10:15:35

GSM1900 (EDGE class 8)

Lowest Band Edge

Highest Band Edge

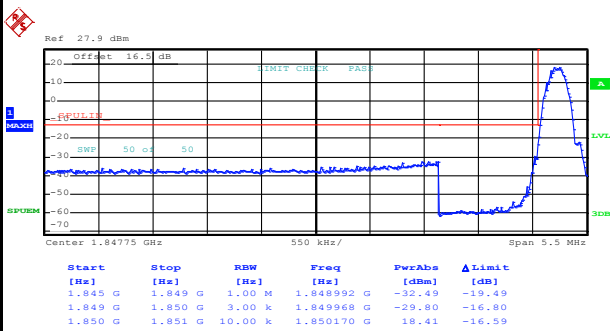

Date: 7.AUG.2017 10:25:55

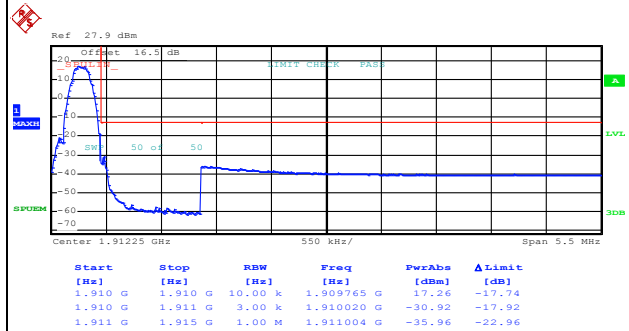

Date: 7.AUG.2017 10:27:26



**Conducted Spurious Emission**

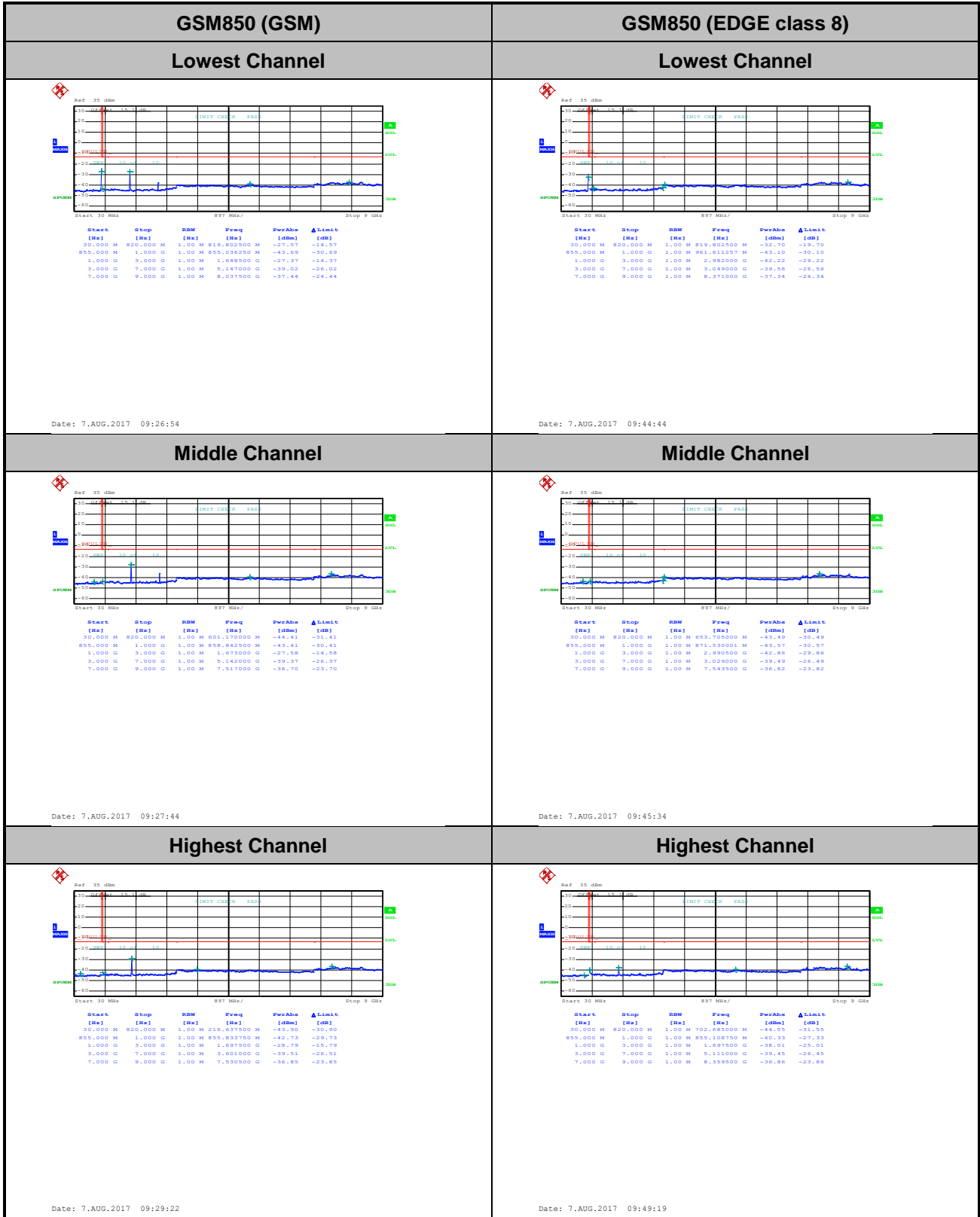

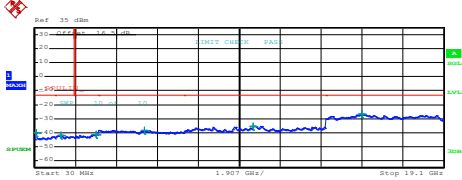
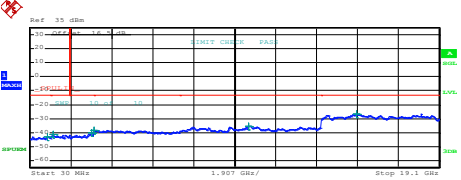
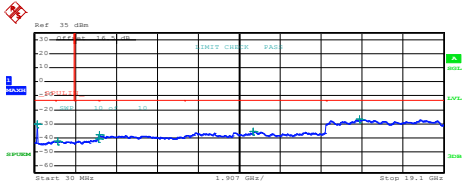
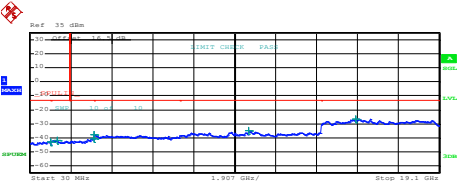
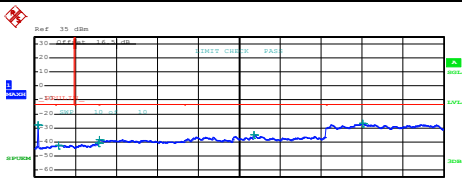
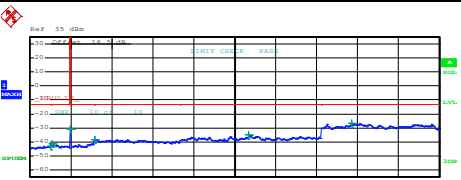

GSM1900 (GPRS class 8)	GSM1900 (EDGE class 8)																																																																																				
Lowest Channel	Lowest Channel																																																																																				
 <table border="1" data-bbox="239 577 638 672"> <thead> <tr> <th>Start [Hz]</th> <th>Stop [Hz]</th> <th>RBW [Hz]</th> <th>Freq [Hz]</th> <th>PwrAve [dBm]</th> <th>ΔLimit [dB]</th> </tr> </thead> <tbody> <tr><td>30.000 M</td><td>1.000 G</td><td>1.00 M</td><td>112.430000 M</td><td>-40.38</td><td>-27.35</td></tr> <tr><td>1.000 G</td><td>1.845 G</td><td>1.00 M</td><td>1.243470 G</td><td>-42.16</td><td>-29.16</td></tr> <tr><td>1.845 G</td><td>3.000 G</td><td>1.00 M</td><td>2.180200 G</td><td>-42.08</td><td>-28.08</td></tr> <tr><td>3.000 G</td><td>7.000 G</td><td>1.00 M</td><td>5.147000 G</td><td>-38.24</td><td>-25.24</td></tr> <tr><td>7.000 G</td><td>13.600 G</td><td>1.00 M</td><td>10.223275 G</td><td>-35.42</td><td>-22.42</td></tr> <tr><td>13.600 G</td><td>19.100 G</td><td>1.00 M</td><td>15.269250 G</td><td>-26.88</td><td>-13.88</td></tr> </tbody> </table> <p>Date: 7.AUG.2017 10:07:22</p>	Start [Hz]	Stop [Hz]	RBW [Hz]	Freq [Hz]	PwrAve [dBm]	ΔLimit [dB]	30.000 M	1.000 G	1.00 M	112.430000 M	-40.38	-27.35	1.000 G	1.845 G	1.00 M	1.243470 G	-42.16	-29.16	1.845 G	3.000 G	1.00 M	2.180200 G	-42.08	-28.08	3.000 G	7.000 G	1.00 M	5.147000 G	-38.24	-25.24	7.000 G	13.600 G	1.00 M	10.223275 G	-35.42	-22.42	13.600 G	19.100 G	1.00 M	15.269250 G	-26.88	-13.88	 <table border="1" data-bbox="893 577 1292 672"> <thead> <tr> <th>Start [Hz]</th> <th>Stop [Hz]</th> <th>RBW [Hz]</th> <th>Freq [Hz]</th> <th>PwrAve [dBm]</th> <th>ΔLimit [dB]</th> </tr> </thead> <tbody> <tr><td>30.000 M</td><td>1.000 G</td><td>1.00 M</td><td>112.430000 M</td><td>-43.19</td><td>-30.19</td></tr> <tr><td>1.000 G</td><td>1.845 G</td><td>1.00 M</td><td>1.089347 G</td><td>-41.25</td><td>-28.25</td></tr> <tr><td>1.845 G</td><td>3.000 G</td><td>1.00 M</td><td>2.892385 G</td><td>-40.08</td><td>-27.08</td></tr> <tr><td>3.000 G</td><td>7.000 G</td><td>1.00 M</td><td>3.031000 G</td><td>-38.21</td><td>-25.21</td></tr> <tr><td>7.000 G</td><td>13.600 G</td><td>1.00 M</td><td>10.224925 G</td><td>-35.51</td><td>-22.51</td></tr> <tr><td>13.600 G</td><td>19.100 G</td><td>1.00 M</td><td>15.258875 G</td><td>-26.63</td><td>-13.63</td></tr> </tbody> </table> <p>Date: 7.AUG.2017 10:19:36</p>	Start [Hz]	Stop [Hz]	RBW [Hz]	Freq [Hz]	PwrAve [dBm]	ΔLimit [dB]	30.000 M	1.000 G	1.00 M	112.430000 M	-43.19	-30.19	1.000 G	1.845 G	1.00 M	1.089347 G	-41.25	-28.25	1.845 G	3.000 G	1.00 M	2.892385 G	-40.08	-27.08	3.000 G	7.000 G	1.00 M	3.031000 G	-38.21	-25.21	7.000 G	13.600 G	1.00 M	10.224925 G	-35.51	-22.51	13.600 G	19.100 G	1.00 M	15.258875 G	-26.63	-13.63
Start [Hz]	Stop [Hz]	RBW [Hz]	Freq [Hz]	PwrAve [dBm]	ΔLimit [dB]																																																																																
30.000 M	1.000 G	1.00 M	112.430000 M	-40.38	-27.35																																																																																
1.000 G	1.845 G	1.00 M	1.243470 G	-42.16	-29.16																																																																																
1.845 G	3.000 G	1.00 M	2.180200 G	-42.08	-28.08																																																																																
3.000 G	7.000 G	1.00 M	5.147000 G	-38.24	-25.24																																																																																
7.000 G	13.600 G	1.00 M	10.223275 G	-35.42	-22.42																																																																																
13.600 G	19.100 G	1.00 M	15.269250 G	-26.88	-13.88																																																																																
Start [Hz]	Stop [Hz]	RBW [Hz]	Freq [Hz]	PwrAve [dBm]	ΔLimit [dB]																																																																																
30.000 M	1.000 G	1.00 M	112.430000 M	-43.19	-30.19																																																																																
1.000 G	1.845 G	1.00 M	1.089347 G	-41.25	-28.25																																																																																
1.845 G	3.000 G	1.00 M	2.892385 G	-40.08	-27.08																																																																																
3.000 G	7.000 G	1.00 M	3.031000 G	-38.21	-25.21																																																																																
7.000 G	13.600 G	1.00 M	10.224925 G	-35.51	-22.51																																																																																
13.600 G	19.100 G	1.00 M	15.258875 G	-26.63	-13.63																																																																																
Middle Channel	Middle Channel																																																																																				
 <table border="1" data-bbox="239 1093 638 1187"> <thead> <tr> <th>Start [Hz]</th> <th>Stop [Hz]</th> <th>RBW [Hz]</th> <th>Freq [Hz]</th> <th>PwrAve [dBm]</th> <th>ΔLimit [dB]</th> </tr> </thead> <tbody> <tr><td>30.000 M</td><td>1.000 G</td><td>1.00 M</td><td>141.792500 M</td><td>-29.97</td><td>-16.97</td></tr> <tr><td>1.000 G</td><td>1.845 G</td><td>1.00 M</td><td>1.089236 G</td><td>-42.21</td><td>-29.21</td></tr> <tr><td>1.845 G</td><td>3.000 G</td><td>1.00 M</td><td>2.986438 G</td><td>-40.91</td><td>-27.91</td></tr> <tr><td>3.000 G</td><td>7.000 G</td><td>1.00 M</td><td>3.054000 G</td><td>-37.83</td><td>-24.83</td></tr> <tr><td>7.000 G</td><td>13.600 G</td><td>1.00 M</td><td>10.227400 G</td><td>-35.36</td><td>-22.36</td></tr> <tr><td>13.600 G</td><td>19.100 G</td><td>1.00 M</td><td>15.175062 G</td><td>-26.97</td><td>-13.97</td></tr> </tbody> </table> <p>Date: 7.AUG.2017 10:08:13</p>	Start [Hz]	Stop [Hz]	RBW [Hz]	Freq [Hz]	PwrAve [dBm]	ΔLimit [dB]	30.000 M	1.000 G	1.00 M	141.792500 M	-29.97	-16.97	1.000 G	1.845 G	1.00 M	1.089236 G	-42.21	-29.21	1.845 G	3.000 G	1.00 M	2.986438 G	-40.91	-27.91	3.000 G	7.000 G	1.00 M	3.054000 G	-37.83	-24.83	7.000 G	13.600 G	1.00 M	10.227400 G	-35.36	-22.36	13.600 G	19.100 G	1.00 M	15.175062 G	-26.97	-13.97	 <table border="1" data-bbox="893 1093 1292 1187"> <thead> <tr> <th>Start [Hz]</th> <th>Stop [Hz]</th> <th>RBW [Hz]</th> <th>Freq [Hz]</th> <th>PwrAve [dBm]</th> <th>ΔLimit [dB]</th> </tr> </thead> <tbody> <tr><td>30.000 M</td><td>1.000 G</td><td>1.00 M</td><td>974.032500 M</td><td>-42.91</td><td>-29.91</td></tr> <tr><td>1.000 G</td><td>1.845 G</td><td>1.00 M</td><td>1.087723 G</td><td>-43.31</td><td>-30.31</td></tr> <tr><td>1.845 G</td><td>3.000 G</td><td>1.00 M</td><td>2.988879 G</td><td>-40.61</td><td>-27.61</td></tr> <tr><td>3.000 G</td><td>7.000 G</td><td>1.00 M</td><td>3.030000 G</td><td>-38.03</td><td>-25.03</td></tr> <tr><td>7.000 G</td><td>13.600 G</td><td>1.00 M</td><td>10.227400 G</td><td>-35.34</td><td>-22.34</td></tr> <tr><td>13.600 G</td><td>19.100 G</td><td>1.00 M</td><td>15.204625 G</td><td>-26.79</td><td>-13.79</td></tr> </tbody> </table> <p>Date: 7.AUG.2017 10:20:26</p>	Start [Hz]	Stop [Hz]	RBW [Hz]	Freq [Hz]	PwrAve [dBm]	ΔLimit [dB]	30.000 M	1.000 G	1.00 M	974.032500 M	-42.91	-29.91	1.000 G	1.845 G	1.00 M	1.087723 G	-43.31	-30.31	1.845 G	3.000 G	1.00 M	2.988879 G	-40.61	-27.61	3.000 G	7.000 G	1.00 M	3.030000 G	-38.03	-25.03	7.000 G	13.600 G	1.00 M	10.227400 G	-35.34	-22.34	13.600 G	19.100 G	1.00 M	15.204625 G	-26.79	-13.79
Start [Hz]	Stop [Hz]	RBW [Hz]	Freq [Hz]	PwrAve [dBm]	ΔLimit [dB]																																																																																
30.000 M	1.000 G	1.00 M	141.792500 M	-29.97	-16.97																																																																																
1.000 G	1.845 G	1.00 M	1.089236 G	-42.21	-29.21																																																																																
1.845 G	3.000 G	1.00 M	2.986438 G	-40.91	-27.91																																																																																
3.000 G	7.000 G	1.00 M	3.054000 G	-37.83	-24.83																																																																																
7.000 G	13.600 G	1.00 M	10.227400 G	-35.36	-22.36																																																																																
13.600 G	19.100 G	1.00 M	15.175062 G	-26.97	-13.97																																																																																
Start [Hz]	Stop [Hz]	RBW [Hz]	Freq [Hz]	PwrAve [dBm]	ΔLimit [dB]																																																																																
30.000 M	1.000 G	1.00 M	974.032500 M	-42.91	-29.91																																																																																
1.000 G	1.845 G	1.00 M	1.087723 G	-43.31	-30.31																																																																																
1.845 G	3.000 G	1.00 M	2.988879 G	-40.61	-27.61																																																																																
3.000 G	7.000 G	1.00 M	3.030000 G	-38.03	-25.03																																																																																
7.000 G	13.600 G	1.00 M	10.227400 G	-35.34	-22.34																																																																																
13.600 G	19.100 G	1.00 M	15.204625 G	-26.79	-13.79																																																																																
Highest Channel	Highest Channel																																																																																				
 <table border="1" data-bbox="239 1608 638 1702"> <thead> <tr> <th>Start [Hz]</th> <th>Stop [Hz]</th> <th>RBW [Hz]</th> <th>Freq [Hz]</th> <th>PwrAve [dBm]</th> <th>ΔLimit [dB]</th> </tr> </thead> <tbody> <tr><td>30.000 M</td><td>1.000 G</td><td>1.00 M</td><td>171.600000 M</td><td>-27.75</td><td>-14.75</td></tr> <tr><td>1.000 G</td><td>1.845 G</td><td>1.00 M</td><td>1.149987 G</td><td>-42.22</td><td>-29.22</td></tr> <tr><td>1.845 G</td><td>3.000 G</td><td>1.00 M</td><td>2.987351 G</td><td>-40.77</td><td>-27.77</td></tr> <tr><td>3.000 G</td><td>7.000 G</td><td>1.00 M</td><td>3.024000 G</td><td>-38.21</td><td>-25.21</td></tr> <tr><td>7.000 G</td><td>13.600 G</td><td>1.00 M</td><td>10.224000 G</td><td>-35.16</td><td>-22.16</td></tr> <tr><td>13.600 G</td><td>19.100 G</td><td>1.00 M</td><td>15.200813 G</td><td>-26.63</td><td>-13.63</td></tr> </tbody> </table> <p>Date: 7.AUG.2017 10:09:07</p>	Start [Hz]	Stop [Hz]	RBW [Hz]	Freq [Hz]	PwrAve [dBm]	ΔLimit [dB]	30.000 M	1.000 G	1.00 M	171.600000 M	-27.75	-14.75	1.000 G	1.845 G	1.00 M	1.149987 G	-42.22	-29.22	1.845 G	3.000 G	1.00 M	2.987351 G	-40.77	-27.77	3.000 G	7.000 G	1.00 M	3.024000 G	-38.21	-25.21	7.000 G	13.600 G	1.00 M	10.224000 G	-35.16	-22.16	13.600 G	19.100 G	1.00 M	15.200813 G	-26.63	-13.63	 <table border="1" data-bbox="893 1608 1292 1702"> <thead> <tr> <th>Start [Hz]</th> <th>Stop [Hz]</th> <th>RBW [Hz]</th> <th>Freq [Hz]</th> <th>PwrAve [dBm]</th> <th>ΔLimit [dB]</th> </tr> </thead> <tbody> <tr><td>30.000 M</td><td>1.000 G</td><td>1.00 M</td><td>965.325000 M</td><td>-43.09</td><td>-30.09</td></tr> <tr><td>1.000 G</td><td>1.845 G</td><td>1.00 M</td><td>1.057671 G</td><td>-41.41</td><td>-28.41</td></tr> <tr><td>1.845 G</td><td>3.000 G</td><td>1.00 M</td><td>1.932071 G</td><td>-39.84</td><td>-27.84</td></tr> <tr><td>3.000 G</td><td>7.000 G</td><td>1.00 M</td><td>3.024000 G</td><td>-38.45</td><td>-25.45</td></tr> <tr><td>7.000 G</td><td>13.600 G</td><td>1.00 M</td><td>10.224925 G</td><td>-34.77</td><td>-21.77</td></tr> <tr><td>13.600 G</td><td>19.100 G</td><td>1.00 M</td><td>15.007312 G</td><td>-26.69</td><td>-13.69</td></tr> </tbody> </table> <p>Date: 7.AUG.2017 10:21:19</p>	Start [Hz]	Stop [Hz]	RBW [Hz]	Freq [Hz]	PwrAve [dBm]	ΔLimit [dB]	30.000 M	1.000 G	1.00 M	965.325000 M	-43.09	-30.09	1.000 G	1.845 G	1.00 M	1.057671 G	-41.41	-28.41	1.845 G	3.000 G	1.00 M	1.932071 G	-39.84	-27.84	3.000 G	7.000 G	1.00 M	3.024000 G	-38.45	-25.45	7.000 G	13.600 G	1.00 M	10.224925 G	-34.77	-21.77	13.600 G	19.100 G	1.00 M	15.007312 G	-26.69	-13.69
Start [Hz]	Stop [Hz]	RBW [Hz]	Freq [Hz]	PwrAve [dBm]	ΔLimit [dB]																																																																																
30.000 M	1.000 G	1.00 M	171.600000 M	-27.75	-14.75																																																																																
1.000 G	1.845 G	1.00 M	1.149987 G	-42.22	-29.22																																																																																
1.845 G	3.000 G	1.00 M	2.987351 G	-40.77	-27.77																																																																																
3.000 G	7.000 G	1.00 M	3.024000 G	-38.21	-25.21																																																																																
7.000 G	13.600 G	1.00 M	10.224000 G	-35.16	-22.16																																																																																
13.600 G	19.100 G	1.00 M	15.200813 G	-26.63	-13.63																																																																																
Start [Hz]	Stop [Hz]	RBW [Hz]	Freq [Hz]	PwrAve [dBm]	ΔLimit [dB]																																																																																
30.000 M	1.000 G	1.00 M	965.325000 M	-43.09	-30.09																																																																																
1.000 G	1.845 G	1.00 M	1.057671 G	-41.41	-28.41																																																																																
1.845 G	3.000 G	1.00 M	1.932071 G	-39.84	-27.84																																																																																
3.000 G	7.000 G	1.00 M	3.024000 G	-38.45	-25.45																																																																																
7.000 G	13.600 G	1.00 M	10.224925 G	-34.77	-21.77																																																																																
13.600 G	19.100 G	1.00 M	15.007312 G	-26.69	-13.69																																																																																



**Frequency Stability**

Test Conditions	Middle Channel	GSM850 (GSM)	GSM850 (EDGE class 8)	Limit 2.5ppm
Temperature (°C)	Voltage (Volt)	Deviation (ppm)		Result
50	Normal Voltage	0.0120	0.0012	PASS
40	Normal Voltage	0.0036	0.0072	
30	Normal Voltage	0.0024	0.0012	
20(Ref.)	Normal Voltage	0.0000	0.0000	
10	Normal Voltage	0.0048	0.0048	
0	Normal Voltage	0.0024	0.0036	
-10	Normal Voltage	0.0036	0.0060	
-20	Normal Voltage	0.0024	0.0012	
-30	Normal Voltage	0.0060	0.0072	
20	Maximum Voltage	0.0096	0.0036	
20	Normal Voltage	0.0048	0.0012	
20	Battery End Point	0.0024	0.0060	

Test Conditions	Middle Channel	GSM1900 (GPRS class 8)	GSM1900 (EDGE class 8)	Limit Note 2.
Temperature (°C)	Voltage (Volt)	Deviation (ppm)		Result
50	Normal Voltage	0.0021	0.0011	PASS
40	Normal Voltage	0.0027	0.0027	
30	Normal Voltage	0.0016	0.0011	
20(Ref.)	Normal Voltage	0.0000	0.0000	
10	Normal Voltage	0.0048	0.0011	
0	Normal Voltage	0.0000	0.0016	
-10	Normal Voltage	0.0016	0.0032	
-20	Normal Voltage	0.0059	0.0005	
-30	Normal Voltage	0.0048	0.0016	
20	Maximum Voltage	0.0027	0.0011	
20	Normal Voltage	0.0043	0.0016	
20	Battery End Point	0.0000	0.0005	

**Note:**

1. Normal Voltage = 4 V. ; Battery End Point (BEP) = 3.6 V. ; Maximum Voltage =4.4 V
2. The frequency fundamental emissions stay within the authorized frequency block based on the frequency deviation measured is small.



## A2. WCDMA

### Peak-to-Average Ratio

Mode	WCDMA Band V	WCDMA Band II	WCDMA Band IV	Limit: 13dB
Mod.	RMC 12.2Kbps	RMC 12.2Kbps	RMC 12.2Kbps	Result
Lowest CH	2.68	2.60	2.36	<b>PASS</b>
Middle CH	2.76	2.80	2.48	
Highest CH	2.16	3.00	2.60	

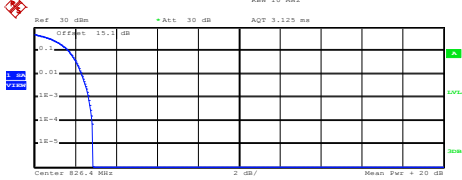
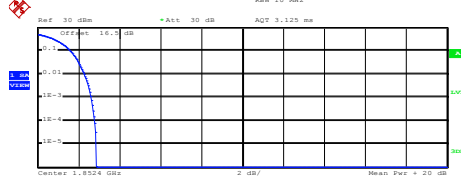
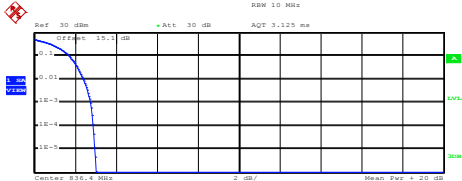
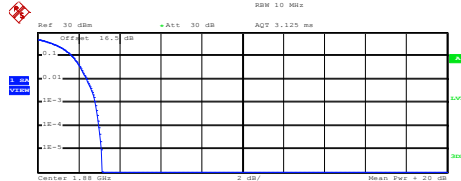
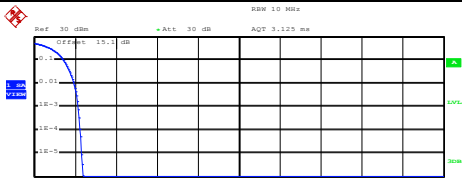
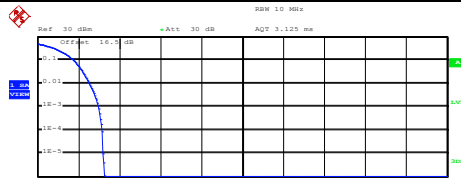

WCDMA Band V (RMC 12.2Kbps)	WCDMA Band II (RMC 12.2Kbps)																
<p style="text-align: center;"><b>Lowest Channel</b></p>  <p>Center 826.4 MHz      2 dB/      Mean Pwr + 20 dB</p> <p>Complementary Cumulative Distribution Function (100000 samples) Trace 1 Mean 22.72 dBm Peak 25.59 dBm Crest 2.87 dB</p> <table border="1"> <tr><td>10 %</td><td>1.68 dB</td></tr> <tr><td>1 %</td><td>2.32 dB</td></tr> <tr><td>.1 %</td><td>2.68 dB</td></tr> <tr><td>.01 %</td><td>2.84 dB</td></tr> </table> <p>Date: 7.AUG.2017 11:00:48</p>	10 %	1.68 dB	1 %	2.32 dB	.1 %	2.68 dB	.01 %	2.84 dB	<p style="text-align: center;"><b>Lowest Channel</b></p>  <p>Center 1.8524 GHz      2 dB/      Mean Pwr + 20 dB</p> <p>Complementary Cumulative Distribution Function (100000 samples) Trace 1 Mean 21.81 dBm Peak 24.68 dBm Crest 2.87 dB</p> <table border="1"> <tr><td>10 %</td><td>1.60 dB</td></tr> <tr><td>1 %</td><td>2.28 dB</td></tr> <tr><td>.1 %</td><td>2.60 dB</td></tr> <tr><td>.01 %</td><td>2.80 dB</td></tr> </table> <p>Date: 7.AUG.2017 10:41:59</p>	10 %	1.60 dB	1 %	2.28 dB	.1 %	2.60 dB	.01 %	2.80 dB
10 %	1.68 dB																
1 %	2.32 dB																
.1 %	2.68 dB																
.01 %	2.84 dB																
10 %	1.60 dB																
1 %	2.28 dB																
.1 %	2.60 dB																
.01 %	2.80 dB																
<p style="text-align: center;"><b>Middle Channel</b></p>  <p>Center 830.4 MHz      2 dB/      Mean Pwr + 20 dB</p> <p>Complementary Cumulative Distribution Function (100000 samples) Trace 1 Mean 22.71 dBm Peak 25.74 dBm Crest 3.03 dB</p> <table border="1"> <tr><td>10 %</td><td>1.72 dB</td></tr> <tr><td>1 %</td><td>2.40 dB</td></tr> <tr><td>.1 %</td><td>2.76 dB</td></tr> <tr><td>.01 %</td><td>2.88 dB</td></tr> </table> <p>Date: 7.AUG.2017 11:00:57</p>	10 %	1.72 dB	1 %	2.40 dB	.1 %	2.76 dB	.01 %	2.88 dB	<p style="text-align: center;"><b>Middle Channel</b></p>  <p>Center 1.88 GHz      2 dB/      Mean Pwr + 20 dB</p> <p>Complementary Cumulative Distribution Function (100000 samples) Trace 1 Mean 21.95 dBm Peak 25.10 dBm Crest 3.15 dB</p> <table border="1"> <tr><td>10 %</td><td>1.68 dB</td></tr> <tr><td>1 %</td><td>2.40 dB</td></tr> <tr><td>.1 %</td><td>2.80 dB</td></tr> <tr><td>.01 %</td><td>3.00 dB</td></tr> </table> <p>Date: 7.AUG.2017 10:42:08</p>	10 %	1.68 dB	1 %	2.40 dB	.1 %	2.80 dB	.01 %	3.00 dB
10 %	1.72 dB																
1 %	2.40 dB																
.1 %	2.76 dB																
.01 %	2.88 dB																
10 %	1.68 dB																
1 %	2.40 dB																
.1 %	2.80 dB																
.01 %	3.00 dB																
<p style="text-align: center;"><b>Highest Channel</b></p>  <p>Center 846.6 MHz      2 dB/      Mean Pwr + 20 dB</p> <p>Complementary Cumulative Distribution Function (100000 samples) Trace 1 Mean 22.72 dBm Peak 25.10 dBm Crest 2.38 dB</p> <table border="1"> <tr><td>10 %</td><td>1.44 dB</td></tr> <tr><td>1 %</td><td>1.96 dB</td></tr> <tr><td>.1 %</td><td>2.16 dB</td></tr> <tr><td>.01 %</td><td>2.24 dB</td></tr> </table> <p>Date: 7.AUG.2017 11:01:06</p>	10 %	1.44 dB	1 %	1.96 dB	.1 %	2.16 dB	.01 %	2.24 dB	<p style="text-align: center;"><b>Highest Channel</b></p>  <p>Center 1.9076 GHz      2 dB/      Mean Pwr + 20 dB</p> <p>Complementary Cumulative Distribution Function (100000 samples) Trace 1 Mean 21.91 dBm Peak 25.17 dBm Crest 3.26 dB</p> <table border="1"> <tr><td>10 %</td><td>1.76 dB</td></tr> <tr><td>1 %</td><td>2.52 dB</td></tr> <tr><td>.1 %</td><td>3.00 dB</td></tr> <tr><td>.01 %</td><td>3.16 dB</td></tr> </table> <p>Date: 7.AUG.2017 10:42:16</p>	10 %	1.76 dB	1 %	2.52 dB	.1 %	3.00 dB	.01 %	3.16 dB
10 %	1.44 dB																
1 %	1.96 dB																
.1 %	2.16 dB																
.01 %	2.24 dB																
10 %	1.76 dB																
1 %	2.52 dB																
.1 %	3.00 dB																
.01 %	3.16 dB																





WCDMA Band IV (RMC 12.2Kbps)

Lowest Channel

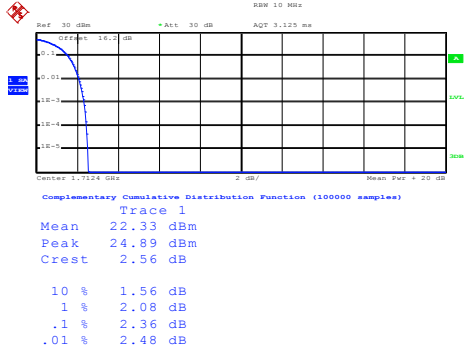

Date: 7.AUG.2017 11:25:41

Middle Channel

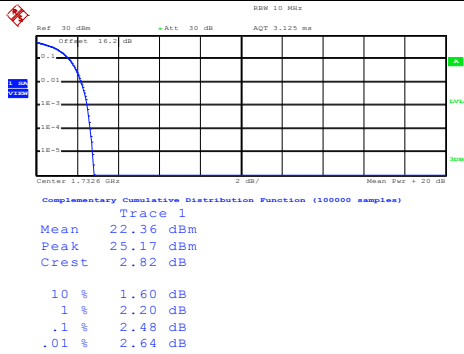

Date: 7.AUG.2017 11:25:50

Highest Channel

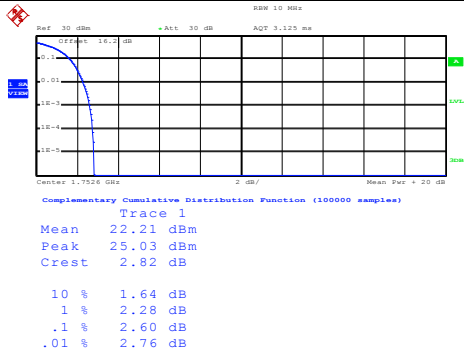

Date: 7.AUG.2017 11:25:58



**26dB Bandwidth**

Mode	WCDMA Band V	WCDMA Band II	WCDMA Band IV
Mod.	RMC 12.2Kbps	RMC 12.2Kbps	RMC 12.2Kbps
Lowest CH	4.68	4.72	4.73
Middle CH	4.70	4.69	4.71
Highest CH	4.73	4.69	4.69

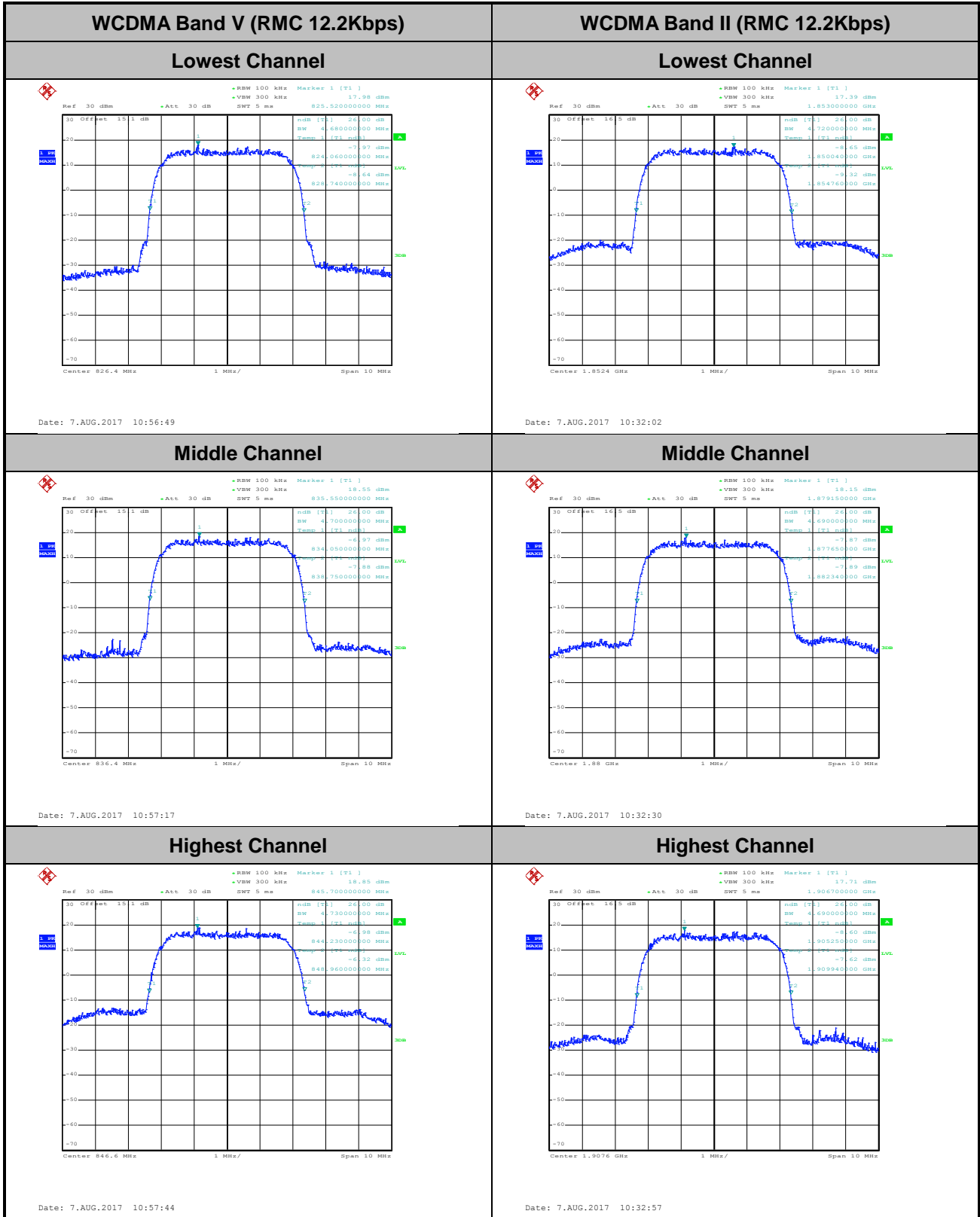



WCDMA Band IV (RMC 12.2Kbps)

Lowest Channel

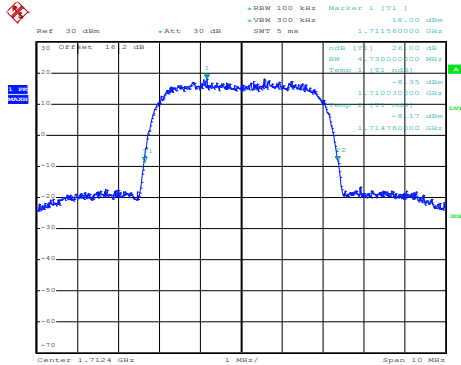

Date: 7.AUG.2017 11:19:38

Middle Channel

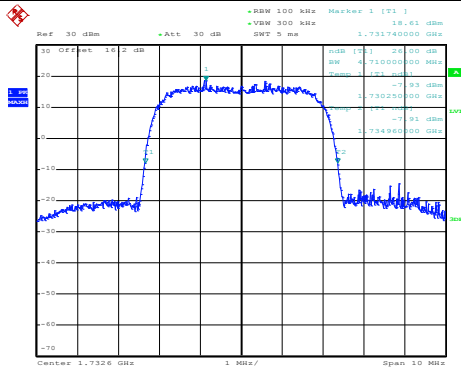

Date: 7.AUG.2017 11:20:06

Highest Channel

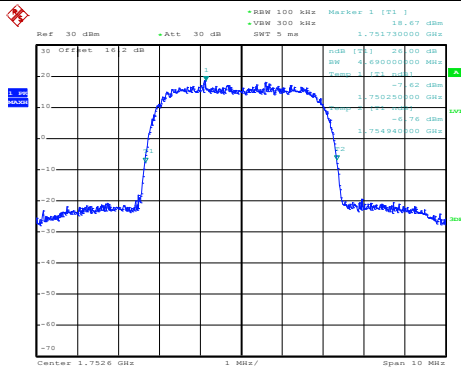

Date: 7.AUG.2017 11:20:34



**Occupied Bandwidth**

Mode	WCDMA Band V	WCDMA Band II	WCDMA Band IV
Mod.	RMC 12.2Kbps	RMC 12.2Kbps	RMC 12.2Kbps
Lowest CH	4.16	4.19	4.18
Middle CH	4.16	4.15	4.17
Highest CH	4.17	4.16	4.16

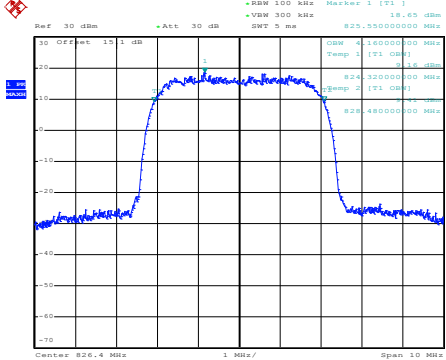
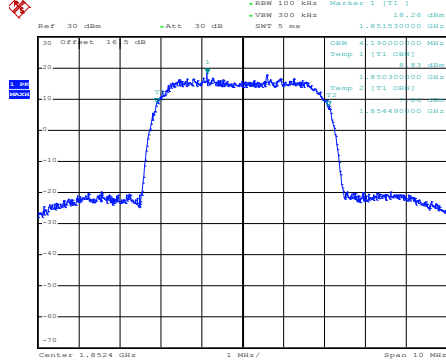
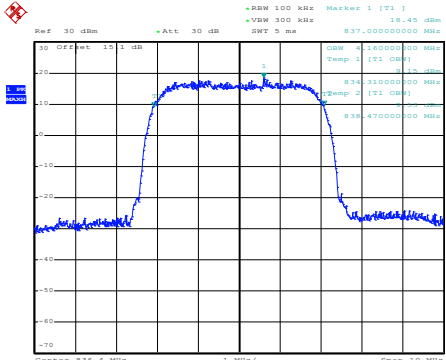
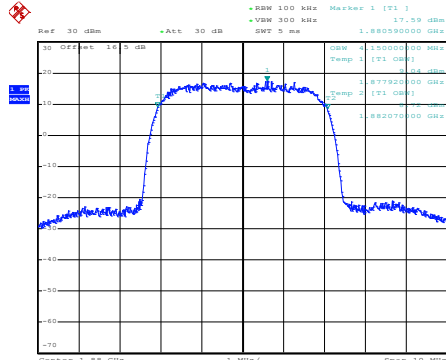
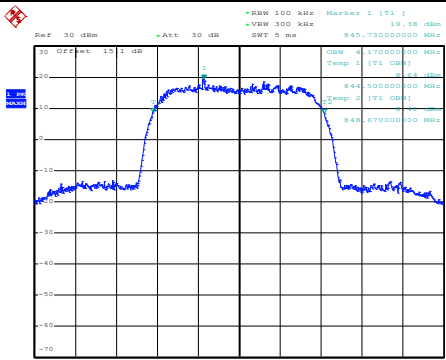
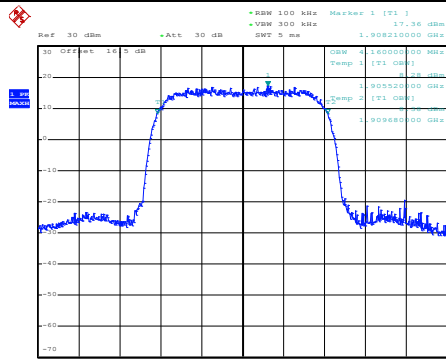

WCDMA Band V (RMC 12.2Kbps)	WCDMA Band II (RMC 12.2Kbps)
<p style="text-align: center;"><b>Lowest Channel</b></p>  <p style="text-align: right;">Date: 7.AUG.2017 11:01:39</p>	<p style="text-align: center;"><b>Lowest Channel</b></p>  <p style="text-align: right;">Date: 7.AUG.2017 10:40:30</p>
<p style="text-align: center;"><b>Middle Channel</b></p>  <p style="text-align: right;">Date: 7.AUG.2017 11:02:07</p>	<p style="text-align: center;"><b>Middle Channel</b></p>  <p style="text-align: right;">Date: 7.AUG.2017 10:40:58</p>
<p style="text-align: center;"><b>Highest Channel</b></p>  <p style="text-align: right;">Date: 7.AUG.2017 11:02:35</p>	<p style="text-align: center;"><b>Highest Channel</b></p>  <p style="text-align: right;">Date: 7.AUG.2017 10:41:26</p>



WCDMA Band IV (RMC 12.2Kbps)

Lowest Channel

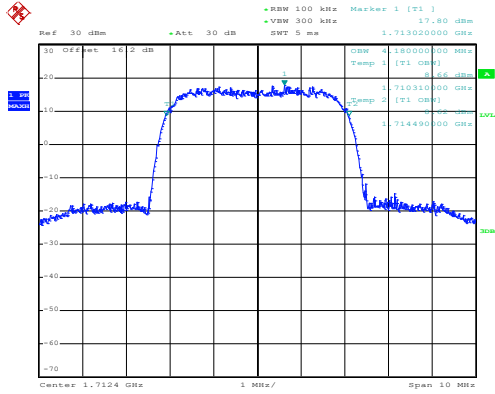

Date: 7.AUG.2017 11:35:59

Middle Channel

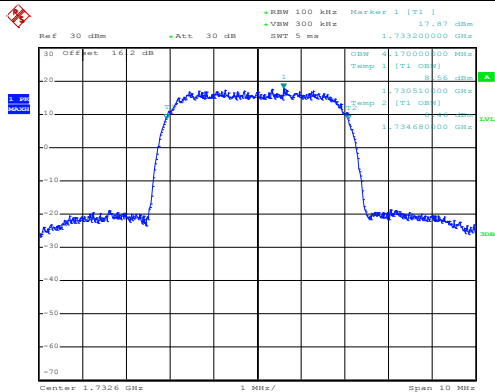

Date: 7.AUG.2017 11:36:27

Highest Channel

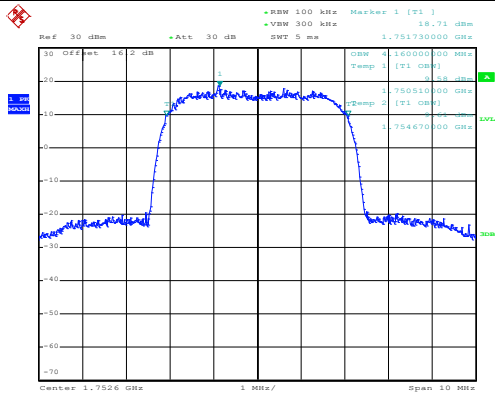

Date: 7.AUG.2017 11:36:55



**Conducted Band Edge**





WCDMA Band V (RMC 12.2Kbps)

Lowest Band Edge

Highest Band Edge

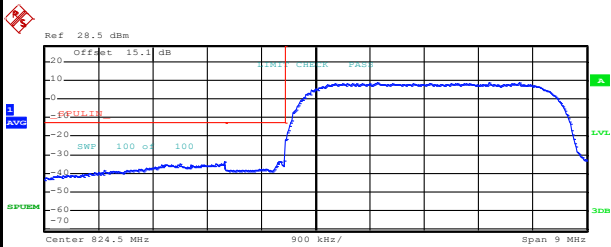

Start [Hz]	Stop [Hz]	RBW [Hz]	Freq [Hz]	PwrAbs [dBm]	ΔLimit [dB]
820.000 M	823.000 M	100.00 k	822.997000 M	-34.00	-21.00
823.000 M	824.000 M	50.00 k	823.996000 M	-33.39	-20.39
824.000 M	829.000 M	100.00 k	827.380000 M	8.88	-26.12

Date: 7.AUG.2017 11:05:27

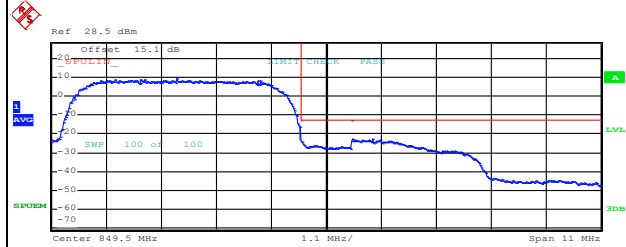

Start [Hz]	Stop [Hz]	RBW [Hz]	Freq [Hz]	PwrAbs [dBm]	ΔLimit [dB]
844.000 M	849.000 M	100.00 k	846.510000 M	9.44	-25.56
849.000 M	850.000 M	50.00 k	849.012000 M	-24.22	-11.22
850.000 M	855.000 M	100.00 k	850.020000 M	-22.84	-9.84

Date: 7.AUG.2017 11:08:10



WCDMA Band II (RMC 12.2Kbps)

Lowest Band Edge

Highest Band Edge

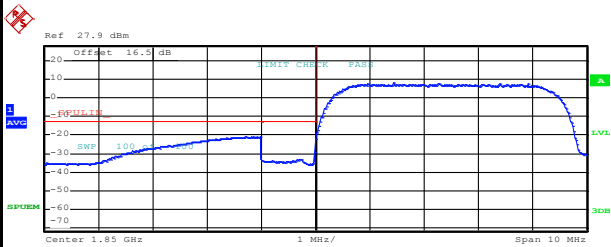

Start [Hz]	Stop [Hz]	RBW [Hz]	Freq [Hz]	PwrAbs [dBm]	ΔLimit [dB]
1.845 G	1.849 G	1.00 M	1.848824 G	-20.88	-7.88
1.849 G	1.850 G	50.00 k	1.849992 G	-31.39	-18.39
1.850 G	1.855 G	100.00 k	1.851430 G	8.22	-26.78

Date: 7.AUG.2017 10:45:04

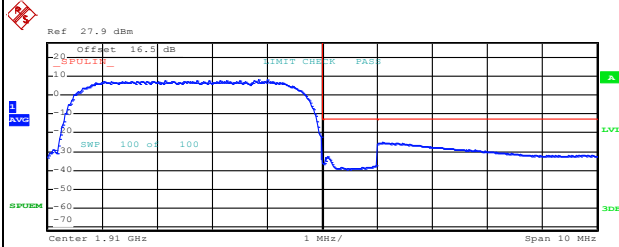

Start [Hz]	Stop [Hz]	RBW [Hz]	Freq [Hz]	PwrAbs [dBm]	ΔLimit [dB]
1.905 G	1.910 G	100.00 k	1.908995 G	8.25	-26.75
1.910 G	1.911 G	50.00 k	1.910100 G	-32.67	-19.67
1.911 G	1.915 G	1.00 M	1.911100 G	-25.29	-12.29

Date: 7.AUG.2017 10:47:46



WCDMA Band IV (RMC 12.2Kbps)

Lowest Band Edge

Highest Band Edge

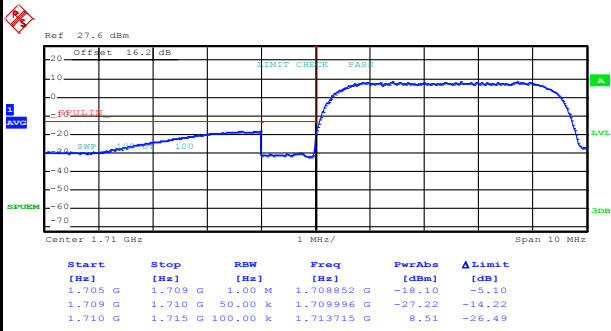

Date: 7.AUG.2017 11:28:43

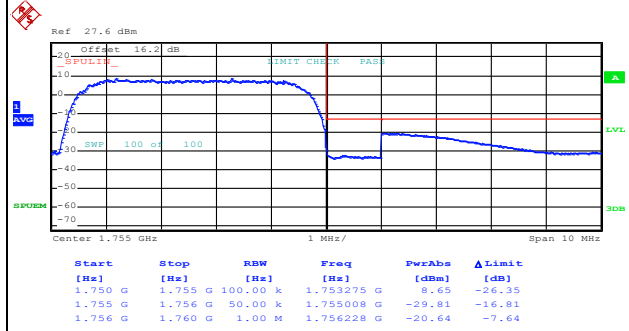

Date: 7.AUG.2017 11:31:25



**Conducted Spurious Emission**

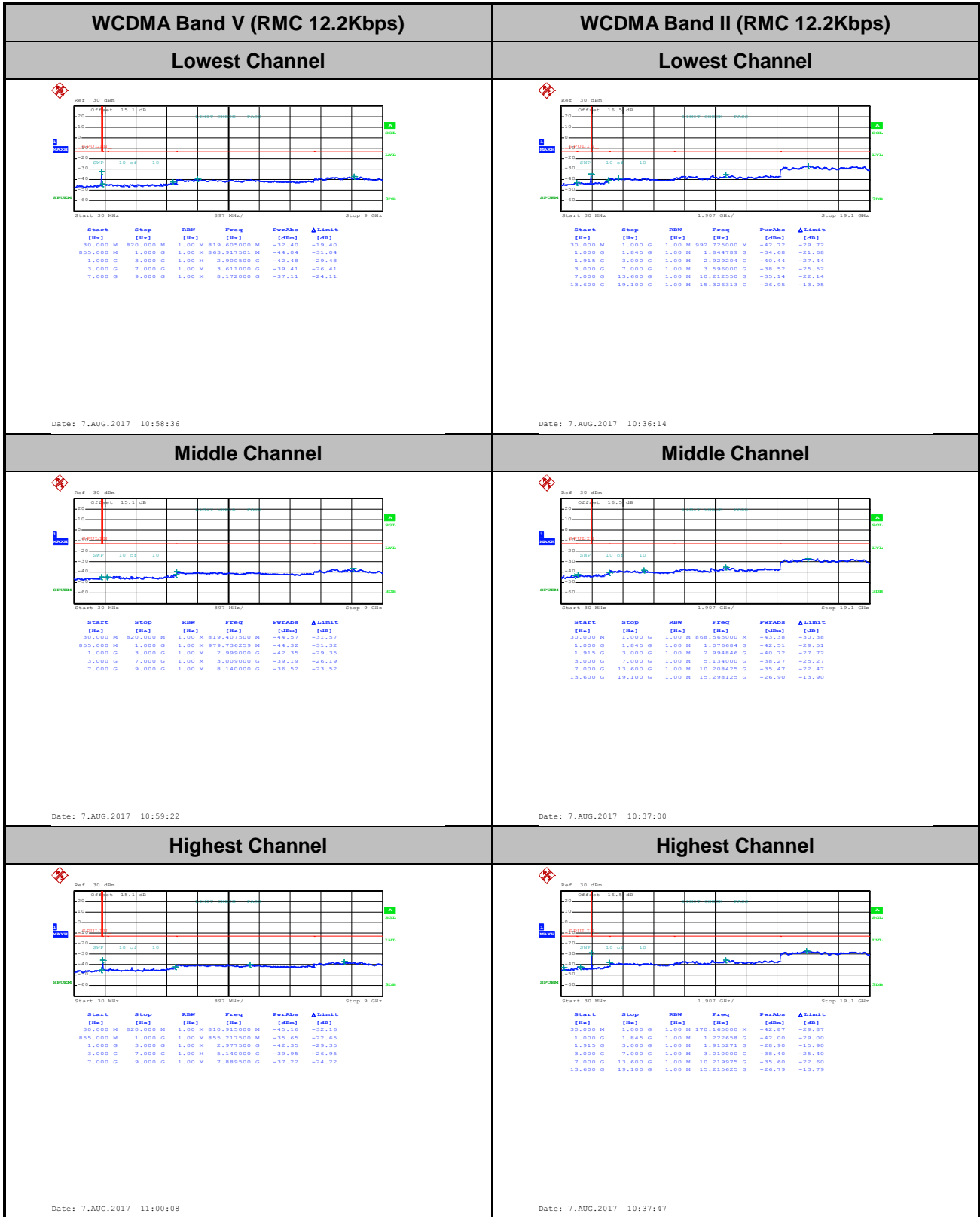



WCDMA Band IV (RMC 12.2Kbps)

Lowest Channel

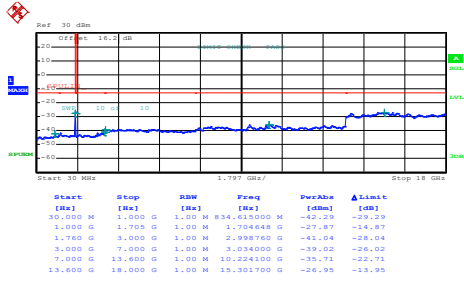

Date: 7.AUG.2017 11:21:33

Middle Channel

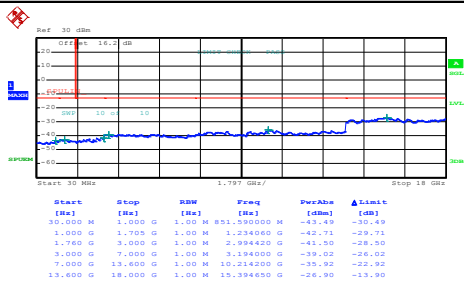

Date: 7.AUG.2017 11:22:19

Highest Channel

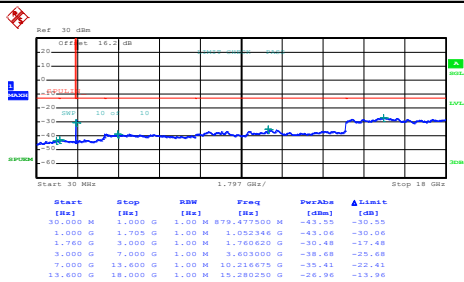

Date: 7.AUG.2017 11:23:05



Frequency Stability

Test Conditions	Middle Channel	WCDMA Band V (RMC 12.2Kbps)	Limit 2.5ppm
Temperature (°C)	Voltage (Volt)	Deviation (ppm)	Result
50	Normal Voltage	0.0048	PASS
40	Normal Voltage	0.0060	
30	Normal Voltage	0.0072	
20(Ref.)	Normal Voltage	0.0000	
10	Normal Voltage	0.0060	
0	Normal Voltage	0.0072	
-10	Normal Voltage	0.0048	
-20	Normal Voltage	0.0024	
-30	Normal Voltage	0.0084	
20	Maximum Voltage	0.0060	
20	Normal Voltage	0.0072	
20	Battery End Point	0.0048	

Test Conditions	Middle Channel	WCDMA Band II (RMC 12.2Kbps)	Limit Note 2.
Temperature (°C)	Voltage (Volt)	Deviation (ppm)	Result
50	Normal Voltage	0.0011	PASS
40	Normal Voltage	0.0027	
30	Normal Voltage	0.0021	
20(Ref.)	Normal Voltage	0.0000	
10	Normal Voltage	0.0005	
0	Normal Voltage	0.0011	
-10	Normal Voltage	0.0000	
-20	Normal Voltage	0.0021	
-30	Normal Voltage	0.0011	
20	Maximum Voltage	0.0032	
20	Normal Voltage	0.0037	
20	Battery End Point	0.0027	



Test Conditions	Middle Channel	WCDMA Band IV (RMC 12.2Kbps)	Limit Note 2.
Temperature (°C)	Voltage (Volt)	Deviation (ppm)	Result
50	Normal Voltage	0.0006	PASS
40	Normal Voltage	0.0012	
30	Normal Voltage	0.0006	
20(Ref.)	Normal Voltage	0.0000	
10	Normal Voltage	0.0006	
0	Normal Voltage	0.0023	
-10	Normal Voltage	0.0012	
-20	Normal Voltage	0.0017	
-30	Normal Voltage	0.0006	
20	Maximum Voltage	0.0006	
20	Normal Voltage	0.0012	
20	Battery End Point	0.0006	

**Note:**

1. Normal Voltage = 4 V. ; Battery End Point (BEP) = 3.6 V. ; Maximum Voltage =4.4 V
2. The frequency fundamental emissions stay within the authorized frequency block based on the frequency deviation measured is small.





## Appendix B. Test Results of ERP/EIRP and Radiated Test

### ERP/EIRP

Channel	Mode	Conducted		ERP		
		Power (dBm)	Power (Watts)	ERP(dBm)	ERP(W)	
Lowest	GSM850	33.09	2.0370	25.74	0.3750	
Middle		33.10	2.0417	25.75	0.3758	
Highest		(GT - LC = -5.2 dB)	33.07	2.0277	25.72	0.3733
Lowest	GSM850	25.97	0.3954	18.62	0.0728	
Middle		EDGE class 8	26.06	0.4036	18.71	0.0743
Highest		(GT - LC = -5.2 dB)	25.99	0.3972	18.64	0.0731
Lowest	WCDMA Band V	22.68	0.1854	15.33	0.0341	
Middle		RMC 12.2Kbps	22.74	0.1879	15.39	0.0346
Highest		(GT - LC = -5.2 dB)	22.77	0.1892	15.42	0.0348
Limit	ERP < 7W	Result		PASS		

Channel	Mode	Conducted		EIRP		
		Power (dBm)	Power (Watts)	EIRP(dBm)	EIRP(W)	
Lowest	GSM1900	29.66	0.9247	27.06	0.5082	
Middle		GPRS class 8	29.80	0.9550	27.20	0.5248
Highest		(GT - LC = -2.6 dB)	29.95	0.9886	27.35	0.5433
Lowest	GSM1900	24.15	0.2600	21.55	0.1429	
Middle		EDGE class 8	24.32	0.2704	21.72	0.1486
Highest		(GT - LC = -2.6 dB)	24.36	0.2729	21.76	0.1500
Lowest	WCDMA Band II	22.42	0.1746	19.82	0.0959	
Middle		RMC 12.2Kbps	22.46	0.1762	19.86	0.0968
Highest		(GT - LC = -2.6 dB)	22.56	0.1803	19.96	0.0991
Limit	EIRP < 2W	Result		PASS		

Channel	Mode	Conducted		EIRP		
		Power (dBm)	Power (Watts)	EIRP(dBm)	EIRP(W)	
Lowest	WCDMA Band IV	23.88	0.2443	20.28	0.1067	
Middle		RMC 12.2Kbps	23.92	0.2466	20.32	0.1076
Highest		(GT - LC = -3.6 dB)	23.82	0.2410	20.22	0.1052
Limit	EIRP < 1W	Result		PASS		



## **Radiated Spurious Emission**



## GSM850

GSM 850									
Channel	Frequency ( MHz )	ERP ( dBm )	Limit ( dBm )	Over Limit ( dB )	SPA Reading (dBm)	S.G. Power ( dBm )	TX Cable loss ( dB )	TX Antenna Gain (dBi)	Polarization (H/V)
Lowest	1648	-45.96	-13	-32.96	-59.46	-47.72	0.98	4.89	H
	2472	-54.63	-13	-41.63	-71.26	-56.51	1.28	5.32	H
	4120	-47.44	-13	-34.44	-69.21	-52.08	1.83	8.62	H
									H
									H
									H
	1648	-45.91	-13	-32.91	-59.41	-47.67	0.98	4.89	V
	2472	-48.39	-13	-35.39	-65.02	-50.27	1.28	5.32	V
	4120	-47.33	-13	-34.33	-69.1	-51.97	1.83	8.62	V
									V
									V
									V
Middle	1672	-49.73	-13	-36.73	-63.3	-51.41	0.99	4.82	H
	2512	-50.82	-13	-37.82	-67.92	-52.79	1.29	5.41	H
	4184	-47.73	-13	-34.73	-69.7	-52.35	1.87	8.64	H
									H
									H
									H
	1672	-44.34	-13	-31.34	-57.91	-46.02	0.99	4.82	V
	2512	-46.47	-13	-33.47	-63.27	-48.44	1.29	5.41	V
	4184	-47.44	-13	-34.44	-69.41	-52.06	1.87	8.64	V
									V
									V
									V
Highest	1696	-48.51	-13	-35.51	-62.14	-50.11	1.00	4.75	H
	2544	-49.30	-13	-36.30	-66.27	-51.28	1.30	5.44	H
	4248	-50.44	-13	-37.44	-72.68	-55.04	1.90	8.65	H
									H
									H
									H
	1696	-47.08	-13	-34.08	-60.71	-48.68	1.00	4.75	V
	2544	-46.26	-13	-33.26	-63.23	-48.24	1.30	5.44	V
	4248	-53.27	-13	-40.27	-75.51	-57.87	1.90	8.65	V
									V
									V
									V

Remark: Spurious emissions within 30-1000MHz were found more than 20dB below limit line.



**EDGE 850**

EDGE 850									
Channel	Frequency ( MHz )	ERP ( dBm )	Limit ( dBm )	Over Limit ( dB )	SPA Reading (dBm)	S.G. Power ( dBm )	TX Cable loss ( dB )	TX Antenna Gain (dBi)	Polarization (H/V)
Lowest	1648	-45.95	-13	-32.95	-59.45	-47.71	0.98	4.89	H
	2472	-49.44	-13	-36.44	-66.07	-51.32	1.28	5.32	H
	4120	-46.67	-13	-33.67	-68.44	-51.31	1.83	8.62	H
									H
									H
									H
	1648	-40.35	-13	-27.35	-53.85	-42.11	0.98	4.89	V
	2472	-50.85	-13	-37.85	-67.48	-52.73	1.28	5.32	V
	4120	-47.58	-13	-34.58	-69.35	-52.22	1.83	8.62	V
									V
									V
									V
Middle	1672	-39.18	-13	-26.18	-52.75	-40.86	0.99	4.82	H
	2512	-51.34	-13	-38.34	-68.14	-53.31	1.29	5.41	H
	4184	-46.92	-13	-33.92	-68.89	-51.54	1.87	8.64	H
									H
									H
									H
	1672	-41.50	-13	-28.50	-55.07	-43.18	0.99	4.82	V
	2512	-45.93	-13	-32.93	-62.73	-47.9	1.29	5.41	V
	4184	-48.12	-13	-35.12	-70.09	-52.74	1.87	8.64	V
									V
									V
									V
Highest	1696	-46.76	-13	-33.76	-60.39	-48.36	1.00	4.75	H
	2544	-49.34	-13	-36.34	-66.31	-51.32	1.30	5.44	H
	3392	-57.71	-13	-44.71	-77.96	-61.51	1.57	7.52	H
	4248	-51.30	-13	-38.30	-73.54	-55.9	1.90	8.65	H
									H
									H
									H
	1696	-42.98	-13	-29.98	-56.61	-44.58	1.00	4.75	V
	2544	-47.45	-13	-34.45	-64.42	-49.43	1.30	5.44	V
	3392	-55.93	-13	-42.93	-76.18	-59.73	1.57	7.52	V
	4248	-51.01	-13	-38.01	-73.25	-55.61	1.90	8.65	V
									V
								V	

Remark: Spurious emissions within 30-1000MHz were found more than 20dB below limit line.



### WCDMA 850

WCDMA 850									
Channel	Frequency ( MHz )	ERP ( dBm )	Limit ( dBm )	Over Limit ( dB )	SPA Reading (dBm)	S.G. Power ( dBm )	TX Cable loss ( dB )	TX Antenna Gain (dBi)	Polarization (H/V)
Lowest	1656	-62.84	-13	-49.84	-76.36	-64.57	0.98	4.86	H
	2480	-61.80	-13	-48.80	-78.43	-63.71	1.28	5.34	H
	3304	-58.80	-13	-45.80	-78.82	-62.24	1.54	7.14	H
									H
									H
									H
	1656	-62.51	-13	-49.51	-76.03	-64.24	0.98	4.86	V
	2480	-61.56	-13	-48.56	-78.19	-63.47	1.28	5.34	V
	3304	-58.72	-13	-45.72	-78.74	-62.16	1.54	7.14	V
									V
									V
									V
Middle	1672	-61.39	-13	-48.39	-74.96	-63.07	0.99	4.82	H
	2512	-61.03	-13	-48.03	-77.83	-63	1.29	5.41	H
	3344	-58.81	-13	-45.81	-78.92	-62.42	1.56	7.31	H
									H
									H
									H
	1672	-63.88	-13	-50.88	-77.45	-65.56	0.99	4.82	V
	2512	-62.06	-13	-49.06	-78.86	-64.03	1.29	5.41	V
	3344	-60.17	-13	-47.17	-80.28	-63.78	1.56	7.31	V
									V
									V
									V
Highest	1688	-62.41	-13	-49.41	-76.01	-64.04	1.00	4.77	H
	2536	-61.11	-13	-48.11	-77.99	-63.09	1.30	5.43	H
	3384	-58.70	-13	-45.70	-78.91	-62.47	1.57	7.49	H
									H
									H
									H
	1688	-62.27	-13	-49.27	-75.87	-63.9	1.00	4.77	V
	2536	-61.15	-13	-48.15	-78.03	-63.13	1.30	5.43	V
	3384	-58.56	-13	-45.56	-78.77	-62.33	1.57	7.49	V
									V
									V
									V

Remark: Spurious emissions within 30-1000MHz were found more than 20dB below limit line.



**WCDMA 1700**

WCDMA 1700									
Channel	Frequency ( MHz )	EIRP ( dBm )	Limit ( dBm )	Over Limit ( dB )	SPA Reading (dBm)	S.G. Power ( dBm )	TX Cable loss ( dB )	TX Antenna Gain (dBi)	Polarization (H/V)
Lowest	3427	-57.75	-13	-44.75	-78.1	-63.85	1.58	7.68	H
	5135	-53.39	-13	-40.39	-79.28	-60.68	2.41	9.70	H
	6850	-47.84	-13	-34.84	-80.16	-55.82	2.64	10.62	H
									H
									H
									H
	3427	-57.60	-13	-44.60	-77.95	-63.7	1.58	7.68	V
	5135	-53.39	-13	-40.39	-79.28	-60.68	2.41	9.70	V
	6850	-46.31	-13	-33.31	-78.63	-54.29	2.64	10.62	V
									V
									V
									V
Middle	3462	-55.17	-13	-42.17	-75.62	-61.41	1.59	7.83	H
	6930	-47.02	-13	-34.02	-79.6	-55.12	2.61	10.72	H
	13860	-31.88	-13	-18.88	-77.68	-42.79	3.15	14.06	H
									H
									H
									H
	3462	-54.96	-13	-41.96	-75.41	-61.2	1.59	7.83	V
	6930	-42.30	-13	-29.30	-74.88	-50.4	2.61	10.72	V
	13860	-32.86	-13	-19.86	-78.66	-43.77	3.15	14.06	V
									V
									V
									V
Highest	3504	-57.26	-13	-44.26	-77.8	-63.66	1.61	8.00	H
	5261	-53.54	-13	-40.54	-79.76	-60.75	2.49	9.70	H
	7010	-46.49	-13	-33.49	-79.32	-54.72	2.59	10.82	H
									H
									H
									H
	3504	-56.45	-13	-43.45	-76.99	-62.85	1.61	8.00	V
	5261	-53.22	-13	-40.22	-79.44	-60.43	2.49	9.70	V
	7010	-46.63	-13	-33.63	-79.46	-54.86	2.59	10.82	V
									V
									V
									V

Remark: Spurious emissions within 30-1000MHz were found more than 20dB below limit line.



**GPRS 1900**

GPRS 1900									
Channel	Frequency ( MHz )	EIRP ( dBm )	Limit ( dBm )	Over Limit ( dB )	SPA Reading (dBm)	S.G. Power ( dBm )	TX Cable loss ( dB )	TX Antenna Gain (dBi)	Polarization (H/V)
Lowest	3700	-45.45	-13	-32.45	-66.27	-52.02	1.67	8.24	H
	5548	-44.69	-13	-31.69	-71.66	-51.76	2.65	9.72	H
	12955	-37.04	-13	-24.04	-80.94	-47.07	2.92	12.94	H
									H
									H
									H
	3700	-45.13	-13	-32.13	-65.95	-51.7	1.67	8.24	V
	5548	-46.63	-13	-33.63	-73.6	-53.7	2.65	9.72	V
	12955	-32.65	-13	-19.65	-76.55	-42.68	2.92	12.94	V
									V
									V
									V
Middle	3763	-45.80	-13	-32.80	-66.71	-52.43	1.69	8.32	H
	5639	-43.28	-13	-30.28	-70.49	-50.33	2.71	9.76	H
	7522	-46.61	-13	-33.61	-80.35	-56	2.42	11.81	H
	13164	-36.39	-13	-23.39	-80.95	-46.65	2.97	13.23	H
									H
									H
									H
	3763	-45.30	-13	-32.30	-66.21	-51.93	1.69	8.32	V
	5639	-45.45	-13	-32.45	-72.66	-52.5	2.71	9.76	V
	7522	-46.66	-13	-33.66	-80.4	-56.05	2.42	11.81	V
	13164	-35.39	-13	-22.39	-79.95	-45.65	2.97	13.23	V
									V
								V	
Highest	3819	-43.15	-13	-30.15	-64.13	-49.83	1.70	8.38	H
	5730	-39.68	-13	-26.68	-67.16	-46.71	2.76	9.79	H
	7634	-46.27	-13	-33.27	-80.17	-55.76	2.39	11.88	H
									H
									H
									H
									H
	3819	-43.87	-13	-30.87	-64.85	-50.55	1.70	8.38	V
	5730	-43.97	-13	-30.97	-71.45	-51	2.76	9.79	V
	7634	-46.45	-13	-33.45	-80.35	-55.94	2.39	11.88	V
									V
									V
								V	

Remark: Spurious emissions within 30-1000MHz were found more than 20dB below limit line.



**EDGE1900**

EDGE 1900									
Channel	Frequency ( MHz )	EIRP ( dBm )	Limit ( dBm )	Over Limit ( dB )	SPA Reading (dBm)	S.G. Power ( dBm )	TX Cable loss ( dB )	TX Antenna Gain (dBi)	Polarization (H/V)
Lowest	3700	-50.92	-13	-37.92	-71.74	-57.49	1.67	8.24	H
	5548	-52.86	-13	-39.86	-79.83	-59.93	2.65	9.72	H
	7403	-47.05	-13	-34.05	-80.59	-56.2	2.46	11.61	H
									H
									H
									H
	3700	-51.98	-13	-38.98	-72.8	-58.55	1.67	8.24	V
	5548	-53.38	-13	-40.38	-80.35	-60.45	2.65	9.72	V
	7403	-47.03	-13	-34.03	-80.57	-56.18	2.46	11.61	V
									V
									V
									V
Middle	3763	-54.89	-13	-41.89	-75.8	-61.52	1.69	8.32	H
	5639	-52.74	-13	-39.74	-79.95	-59.79	2.71	9.76	H
	7522	-46.57	-13	-33.57	-80.31	-55.96	2.42	11.81	H
									H
									H
									H
	3763	-55.22	-13	-42.22	-76.13	-61.85	1.69	8.32	V
	5639	-52.83	-13	-39.83	-80.04	-59.88	2.71	9.76	V
	7522	-46.52	-13	-33.52	-80.26	-55.91	2.42	11.81	V
									V
									V
									V
Highest	3819	-50.49	-13	-37.49	-71.47	-57.17	1.70	8.38	H
	5730	-49.58	-13	-36.58	-77.06	-56.61	2.76	9.79	H
	7627	-46.27	-13	-33.27	-80.17	-55.76	2.39	11.88	H
									H
									H
									H
	3819	-51.28	-13	-38.28	-72.26	-57.96	1.70	8.38	V
	5730	-51.83	-13	-38.83	-79.31	-58.86	2.76	9.79	V
	7627	-46.54	-13	-33.54	-80.44	-56.03	2.39	11.88	V
									V
									V
									V

Remark: Spurious emissions within 30-1000MHz were found more than 20dB below limit line.





**WCDMA 1900**

WCDMA 1900									
Channel	Frequency ( MHz )	EIRP ( dBm )	Limit ( dBm )	Over Limit ( dB )	SPA Reading (dBm)	S.G. Power ( dBm )	TX Cable loss ( dB )	TX Antenna Gain (dBi)	Polarization (H/V)
Lowest	3707	-57.88	-13	-44.88	-78.7	-64.46	1.67	8.25	H
	5555	-53.23	-13	-40.23	-80.2	-60.3	2.66	9.72	H
	7410	-47.22	-13	-34.22	-80.76	-56.38	2.46	11.62	H
									H
									H
									H
	3707	-57.47	-13	-44.47	-78.29	-64.05	1.67	8.25	V
	5555	-53.08	-13	-40.08	-80.05	-60.15	2.66	9.72	V
	7410	-46.80	-13	-33.80	-80.34	-55.96	2.46	11.62	V
									V
									V
									V
Middle	3760	-57.15	-13	-44.15	-78.03	-63.78	1.69	8.31	H
	5639	-51.81	-13	-38.81	-79.02	-58.86	2.71	9.76	H
	7520	-45.89	-13	-32.89	-79.63	-55.28	2.42	11.81	H
									H
									H
									H
	3760	-57.11	-13	-44.11	-78.02	-63.74	1.69	8.31	V
	5639	-51.98	-13	-38.98	-79.19	-59.03	2.71	9.76	V
	7520	-46.63	-13	-33.63	-80.37	-56.02	2.42	11.81	V
									V
									V
									V
Highest	3819	-54.58	-13	-41.58	-75.56	-61.26	1.70	8.38	H
	5730	-51.24	-13	-38.24	-78.72	-58.27	2.76	9.79	H
	7627	-45.33	-13	-32.33	-79.23	-54.82	2.39	11.88	H
									H
									H
									H
	3819	-56.90	-13	-43.90	-77.88	-63.58	1.70	8.38	V
	5730	-52.05	-13	-39.05	-79.53	-59.08	2.76	9.79	V
	7627	-46.00	-13	-33.00	-79.9	-55.49	2.39	11.88	V
									V
									V
									V

Remark: Spurious emissions within 30-1000MHz were found more than 20dB below limit line.