



FCC RF Test Report

APPLICANT : Bullitt Group
EQUIPMENT : Rugged Smart Phone
BRAND NAME : CAT
MODEL NAME : S30
FCC ID : ZL5S30
STANDARD : FCC 47 CFR Part 2, 22(H), 24(E), 27(L)
CLASSIFICATION : PCS Licensed Transmitter Held to Ear (PCE)

The product was received on Jul. 01, 2015 and testing was completed on Jul. 19, 2015. We, SPORTON INTERNATIONAL INC., would like to declare that the tested sample has been evaluated in accordance with the test procedures given in ANSI / TIA / EIA-603-C-2004 and has been in compliance with the applicable technical standards.

The test results in this report apply exclusively to the tested model / sample. Without written approval of SPORTON INTERNATIONAL INC., the test report shall not be reproduced except in full.

Reviewed by: Joseph Lin / Supervisor

Approved by: Jones Tsai / Manager



SPORTON INTERNATIONAL INC.

No. 52, Hwa Ya 1st Rd., Hwa Ya Technology Park, Kwei-Shan District, Tao Yuan City, Taiwan, R.O.C.

SPORTON INTERNATIONAL INC.

TEL : 886-3-327-3456

FAX : 886-3-328-4978

FCC ID : ZL5S30

Page Number : 1 of 118

Report Issued Date : Aug. 13, 2015

Report Version : Rev. 02

Report Template No.: BU5-FG22/24/27 Version 1.2



TABLE OF CONTENTS

REVISION HISTORY..... 3

SUMMARY OF TEST RESULT 4

1 GENERAL DESCRIPTION 5

 1.1 Applicant..... 5

 1.2 Manufacturer 5

 1.3 Product Feature of Equipment Under Test 5

 1.4 Product Specification subjective to this standard 6

 1.5 Modification of EUT 6

 1.6 Maximum ERP/EIRP Power, Frequency Tolerance, and Emission Designator 7

 1.7 Testing Location 8

 1.8 Applicable Standards 8

2 TEST CONFIGURATION OF EQUIPMENT UNDER TEST 9

 2.1 Test Mode..... 9

 2.2 Connection Diagram of Test System 11

 2.3 Support Unit used in test configuration 11

 2.4 Measurement Results Explanation Example 11

3 TEST RESULT 12

 3.1 Conducted Output Power Measurement..... 12

 3.2 Peak-to-Average Ratio 14

 3.3 Effective Radiated Power and Effective Isotropic Radiated Power Measurement 30

 3.4 99% Occupied Bandwidth and 26dB Bandwidth Measurement..... 34

 3.5 Band Edge Measurement..... 58

 3.6 Conducted Spurious Emission Measurement 66

 3.7 Field Strength of Spurious Radiation Measurement 88

 3.8 Frequency Stability Measurement..... 111

4 LIST OF MEASURING EQUIPMENT 117

5 UNCERTAINTY OF EVALUATION 118

APPENDIX A. SETUP PHOTOGRAPHS



REVISION HISTORY

REPORT NO.	VERSION	DESCRIPTION	ISSUED DATE
FG570160A	Rev. 01	Initial issue of report	Aug. 11, 2015
FG570160A	Rev. 02	Update report for adding the antenna used for radiated emissions above 18 GHz in section 4.	Aug. 13, 2015



SUMMARY OF TEST RESULT

Report Section	FCC Rule	Description	Limit	Result	Remark
3.1	§2.1046	Conducted Output Power	Reporting Only	PASS	-
3.2	§24.232(d)	Peak-to-Average Ratio	<13 dB	PASS	-
3.3	§22.913(a)(2)	Effective Radiated Power	< 7 Watts	PASS	-
	§24.232(c)	Equivalent Isotropic Radiated Power	< 2 Watts	PASS	-
	§27.50(d)(4)	Equivalent Isotropic Radiated Power	< 1 Watts	PASS	-
3.4	§2.1049	Occupied Bandwidth	Reporting Only	PASS	-
3.5	§2.1051 §22.917(a) §24.238(a) §27.53(h)	Band Edge Measurement	< 43+10log ₁₀ (P[Watts])	PASS	-
3.6	§2.1051 §22.917(a) §24.238(a) §27.53(h)	Conducted Emission	< 43+10log ₁₀ (P[Watts])	PASS	-
3.7	§2.1053 §22.917(a) §24.238(a) §27.53(h)	Field Strength of Spurious Radiation	< 43+10log ₁₀ (P[Watts])	PASS	Under limit 21.98 dB at 3820.000 MHz
3.8	§2.1055 §22.355	Frequency Stability for Temperature & Voltage	< 2.5 ppm for Part 22 Within Authorized Band	PASS	-
	§2.1055 §24.235 §27.54				



1 General Description

1.1 Applicant

Bullitt Group

One Valpy, Valpy Street, Reading, Berkshire, RG1 1AR United Kingdom

1.2 Manufacturer

Compal Electronics, INC.

No. 385, Yangguang St. Neihu District, Taipei City 11491, Taiwan, R.O.C

1.3 Product Feature of Equipment Under Test

Product Feature	
Equipment	Rugged Smart Phone
Brand Name	CAT
Model Name	S30
FCC ID	ZL5S30
EUT supports Radios application	GSM/EGPRS/WCDMA/HSPA/LTE WLAN 11b/g/n HT20 Bluetooth v4.1 EDR/LE
EUT Stage	Identical Prototype

Remark: The above EUT's information was declared by manufacturer. Please refer to the specifications or user's manual for more detailed description.

<Sample Information>

S30 has 2 different Variant	
Sample 1	Dual SIM
Sample 2	Single SIM
The HW difference is SIM holder	

1.4 Product Specification subjective to this standard

Product Specification subjective to this standard	
Tx Frequency	GSM850: 824.2 MHz ~ 848.8 MHz GSM1900: 1850.2 MHz ~ 1909.8MHz WCDMA Band V: 826.4 MHz ~ 846.6 MHz WCDMA Band IV : 1712.4 MHz ~ 1752.6 MHz WCDMA Band II: 1852.4 MHz ~ 1907.6 MHz
Rx Frequency	GSM850: 869.2 MHz ~ 893.8 MHz GSM1900: 1930.2 MHz ~ 1989.8 MHz WCDMA Band V: 871.4 MHz ~ 891.6 MHz WCDMA Band IV : 2112.4 MHz ~ 2152.6 MHz WCDMA Band II: 1932.4 MHz ~ 1987.6 MHz
Maximum Output Power to Antenna	GSM850 : 33.49 dBm GSM1900 : 30.37 dBm WCDMA Band V : 23.86 dBm WCDMA Band IV : 23.95 dBm WCDMA Band II : 23.84 dBm
99% Occupied Bandwidth	GSM850: 0.25MHz GSM1900: 0.25MHz WCDMA Band V: 4.16MHz WCDMA Band IV : 4.16 MHz WCDMA Band II: 4.16MHz
Antenna Type	PIFA + Coupling type (LDS) Antenna
Type of Modulation	GSM: GMSK GPRS: GMSK EDGE: GMSK / 8PSK WCDMA: QPSK (Uplink) HSDPA: 64QAM (Downlink) HSUPA: QPSK (Uplink)

1.5 Modification of EUT

No modifications are made to the EUT during all test items.



1.6 Maximum ERP/EIRP Power, Frequency Tolerance, and Emission Designator

FCC Rule	System	Type of Modulation	Maximum ERP/EIRP (W)	Frequency Tolerance (ppm)	Emission Designator
Part 22	GSM850 GPRS class 8	GMSK	0.8260	0.0120 ppm	248KGXW
Part 22	GSM850 EDGE class 8	8PSK	0.2051	0.0108 ppm	244KG7W
Part 22	WCDMA Band V RMC 12.2Kbps	QPSK	0.1167	0.0179 ppm	4M16F9W
Part 24	GSM1900 GPRS class 8	GMSK	0.9638	0.0064 ppm	247KGXW
Part 24	GSM1900 EDGE class 8	8PSK	0.3631	0.0043 ppm	246KG7W
Part 24	WCDMA Band II RMC 12.2Kbps	QPSK	0.2438	0.0059 ppm	4M16F9W
Part 27	WCDMA Band IV RMC 12.2Kbps	QPSK	0.1807	0.0075 ppm	4M16F9W



1.7 Testing Location

Sporton Lab is accredited to ISO 17025 by Taiwan Accreditation Foundation (TAF code : 1190) and the FCC designation No. TW1022 under the FCC 2.948(e) by Mutual Recognition Agreement (MRA) in FCC Test.

Test Site	SPORTON INTERNATIONAL INC.
Test Site Location	No. 52, Hwa Ya 1 st Rd., Hwa Ya Technology Park, Kwei-Shan District, Tao Yuan City, Taiwan, R.O.C. TEL: +886-3-327-3456 FAX: +886-3-328-4978
Test Site No.	Sporton Site No.
	TH03-HY

Test Site	SPORTON INTERNATIONAL INC.
Test Site Location	No.58, Aly. 75, Ln. 564, Wenhua 3rd Rd. Guishan Dist, Taoyuan City, Taiwan (R.O.C.) TEL: +886-3-327-0868 FAX: +886-3-327-0855
Test Site No.	Sporton Site No.
	03CH10-HY

1.8 Applicable Standards

According to the specifications of the manufacturer, the EUT must comply with the requirements of the following standards:

- ♦ FCC 47 CFR Part 2, 22(H), 24(E), 27(L)
- ♦ ANSI / TIA / EIA-603-C-2004
- ♦ FCC KDB 971168 D01 Power Meas. License Digital Systems v02r02

Remark:

1. All test items were verified and recorded according to the standards and without any deviation during the test.
2. This EUT has also been tested and complied with the requirements of FCC Part 15, Subpart B, recorded in a separate test report.



2 Test Configuration of Equipment Under Test

2.1 Test Mode

Antenna port conducted and radiated test items were performed according to KDB 971168 D01 Power Meas. License Digital Systems v02r02 with maximum output power.

Radiated measurements were performed with rotating EUT in different three orthogonal test planes to find the maximum emission.

Radiated emissions were investigated as following frequency range:

1. 30 MHz to 9000 MHz for GSM850 and WCDMA Band V.
2. 30 MHz to 18000 MHz for WCDMA Band IV
3. 30 MHz to 19000 MHz for GSM1900 and WCDMA Band II.

All modes and data rates and positions were investigated.

Test modes are chosen to be reported as the worst case configuration below:

Test Modes		
Band	Radiated TCs	Conducted TCs
GSM 850	<ul style="list-style-type: none"> ■ GPRS class 8 Link ■ EDGE class 8 Link 	<ul style="list-style-type: none"> ■ GPRS class 8 Link ■ EDGE class 8 Link
GSM 1900	<ul style="list-style-type: none"> ■ GPRS class 8 Link ■ EDGE class 8 Link 	<ul style="list-style-type: none"> ■ GPRS class 8 Link ■ EDGE class 8 Link
WCDMA Band V	<ul style="list-style-type: none"> ■ RMC 12.2Kbps Link 	<ul style="list-style-type: none"> ■ RMC 12.2Kbps Link
WCDMA Band II	<ul style="list-style-type: none"> ■ RMC 12.2Kbps Link 	<ul style="list-style-type: none"> ■ RMC 12.2Kbps Link
WCDMA Band V	<ul style="list-style-type: none"> ■ RMC 12.2Kbps Link 	<ul style="list-style-type: none"> ■ RMC 12.2Kbps Link

Note:

1. The maximum power levels are chosen to test as the worst case configuration as follows:
 GPRS multi-slot class 8 mode for GMSK modulation,
 EDGE multi-slot class 8 mode for 8PSK modulation,
 RMC 12.2Kbps mode for WCDMA band V and WCDMA band IV,
 RMC 12.2Kbps mode for WCDMA band II, only these modes were used for all tests.
2. All the radiated test cases were performance with Earphone 1, Adapter 1, and Sample 1.



Conducted Power Measurement Results:

Conducted Power (*Unit: dBm)						
Band	GSM850			GSM1900		
Channel	128	189	251	512	661	810
Frequency	824.2	836.4	848.8	1850.2	1880.0	1909.8
GSM	33.44	33.46	33.47	30.31	30.11	30.25
GPRS class 8	33.46	33.47	33.49	30.37	30.13	30.28
GPRS class 10	30.49	30.34	30.29	27.42	27.08	27.37
GPRS class 11	28.39	28.23	28.19	25.38	25.02	25.26
GPRS class 12	27.35	27.25	27.18	24.40	24.07	24.03
EGPRS class 8	27.32	27.18	27.14	25.87	25.58	25.85
EGPRS class 10	27.14	27.01	26.96	25.74	25.47	25.72
EGPRS class 11	27.02	26.95	26.87	25.70	25.39	25.66
EGPRS class 12	26.66	26.61	26.48	25.60	25.27	25.49

Conducted Power (*Unit: dBm)						
Band	WCDMA Band V			WCDMA Band II		
Channel	4132	4182	4233	9262	9400	9538
Frequency	826.4	836.4	846.6	1852.4	1880.0	1907.6
RMC 12.2K	22.50	22.75	22.80	23.75	23.68	23.70
HSDPA Subtest-1	23.61	23.82	23.86	23.84	23.74	23.78
HSDPA Subtest-2	22.69	22.78	22.89	22.82	22.73	22.79
HSDPA Subtest-3	22.66	22.75	22.81	22.81	22.72	22.75
HSDPA Subtest-4	22.25	22.34	22.44	22.30	22.25	22.27
HSUPA Subtest-1	22.69	22.67	22.54	22.85	22.65	22.50
HSUPA Subtest-2	21.50	21.45	21.43	21.50	21.34	21.28
HSUPA Subtest-3	21.76	21.70	21.65	21.89	21.76	21.65
HSUPA Subtest-4	21.80	21.78	21.74	21.95	21.86	21.80
HSUPA Subtest-5	22.57	22.77	22.76	22.74	22.74	22.88

Conducted Power (*Unit: dBm)			
Band	WCDMA Band IV		
Channel	1312	1413	1513
Frequency	1712.4	1732.6	1752.6
RMC 12.2K	23.90	23.76	23.80
HSDPA Subtest-1	23.95	23.80	23.85
HSDPA Subtest-2	22.81	22.75	22.77
HSDPA Subtest-3	22.81	22.71	22.76
HSDPA Subtest-4	22.32	22.21	22.25
HSUPA Subtest-1	22.74	22.53	22.44
HSUPA Subtest-2	21.45	21.28	21.20
HSUPA Subtest-3	21.90	21.76	21.65
HSUPA Subtest-4	21.98	21.84	21.73
HSUPA Subtest-5	22.92	22.71	22.80

2.2 Connection Diagram of Test System

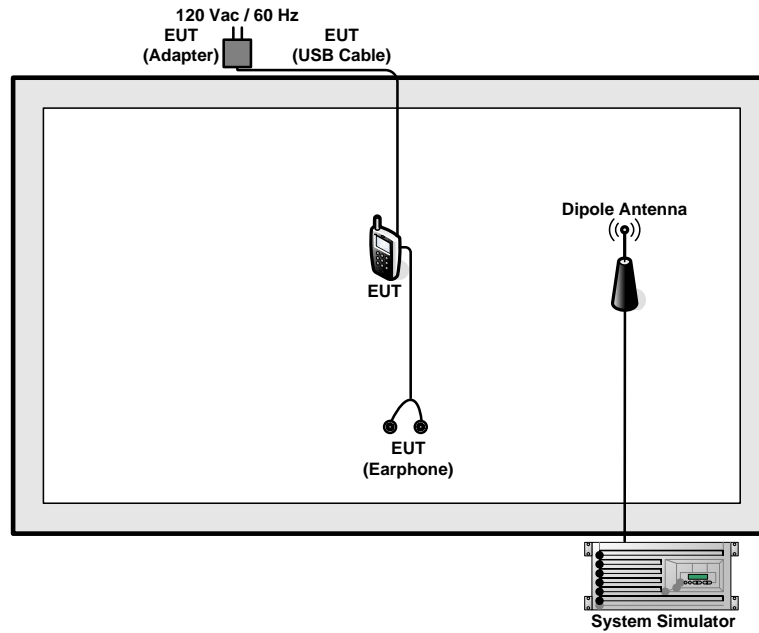

2.3 Support Unit used in test configuration

Item	Equipment	Trade Name	Model No.	FCC ID	Data Cable	Power Cord
1.	System Simulator	Rohde & Schwarz	CMU200	N/A	N/A	Unshielded, 1.8 m

2.4 Measurement Results Explanation Example

For all conducted test items:

The offset level is set in the spectrum analyzer to compensate the RF cable loss and attenuator factor between RF conducted output port and spectrum analyzer. With the offset compensation, the spectrum analyzer reading level will be exactly the RF output level.

The spectrum analyzer offset is derived from RF cable loss and attenuator factor.

Offset = RF cable loss + attenuator factor.

The following shows an offset computation example with RF cable loss 4.2 dB and a 10dB attenuator.

Example :

$$\begin{aligned} \text{Offset(dB)} &= \text{RF cable loss(dB)} + \text{attenuator factor(dB)} \\ &= 4.2 + 10 = 14.2 \text{ (dB)} \end{aligned}$$

3 Test Result

3.1 Conducted Output Power Measurement

3.1.1 Description of the Conducted Output Power Measurement

A system simulator was used to establish communication with the EUT. Its parameters were set to enforce EUT transmitting at the maximum power. The measured power in the radio frequency on the transmitter output terminals shall be reported.

3.1.2 Measuring Instruments

The measuring equipment is listed in the section 4 of this test report.

3.1.3 Test Procedures

1. The transmitter output port was connected to the system simulator.
2. Set EUT at maximum power through system simulator.
3. Select lowest, middle, and highest channels for each band and different modulation.
4. Measure the maximum burst average power for GSM and maximum average power for other modulation signal.

3.1.4 Test Setup

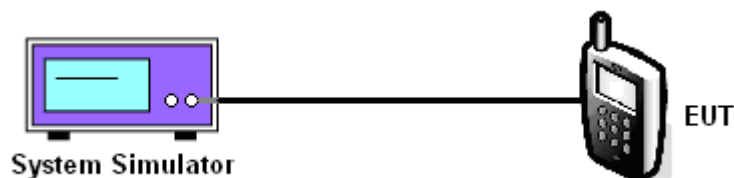



3.1.5 Test Result of Conducted Output Power

Cellular Band									
Modes	GSM850 (GPRS class 8)			GSM850 (EDGE class 8)			WCDMA Band V (RMC 12.2Kbps)		
Channel	128 (Low)	189 (Mid)	251 (High)	128 (Low)	189 (Mid)	251 (High)	4132 (Low)	4182 (Mid)	4233 (High)
Frequency (MHz)	824.2	836.4	848.8	824.2	836.4	848.8	826.4	836.4	846.6
Conducted Power (dBm)	33.46	33.47	33.49	27.32	27.18	27.14	23.61	23.82	23.86

PCS Band									
Modes	GSM1900 (GPRS class 8)			GSM1900 (EDGE class 8)			WCDMA Band II (RMC 12.2Kbps)		
Channel	512 (Low)	661 (Mid)	810 (High)	512 (Low)	661 (Mid)	810 (High)	9262 (Low)	9400 (Mid)	9538 (High)
Frequency (MHz)	1850.2	1880	1909.8	1850.2	1880	1909.8	1852.4	1880	1907.6
Conducted Power (dBm)	30.37	30.13	30.28	25.87	25.58	25.85	23.84	23.74	23.78

AWS Band			
Modes	WCDMA Band IV (RMC 12.2Kbps)		
Channel	1312(Low)	1413 (Mid)	1513 (High)
Frequency (MHz)	1712.4	1732.6	1752.6
Conducted Power (dBm)	23.95	23.80	23.85

Note: maximum burst average power for GSM, and maximum average power for WCDMA .

3.2 Peak-to-Average Ratio

3.2.1 Description of the PAR Measurement

The peak-to-average ratio (PAR) of the transmission may not exceed 13 dB.

3.2.2 Measuring Instruments

The measuring equipment is listed in the section 4 of this test report.

3.2.3 Test Procedures

1. The testing follows FCC KDB 971168 v02r02 Section 5.7.1.
2. The EUT was connected to spectrum analyzer and system simulator via a power divider.
3. Set EUT to transmit at maximum output power.
4. When the duty cycle is less than 98%, then signal gating will be implemented on the spectrum analyzer by triggering from the system simulator.
5. Set the CCDF (Complementary Cumulative Distribution Function) option of the spectrum analyzer.
6. Record the maximum PAPR level associated with a probability of 0.1%.

3.2.4 Test Setup

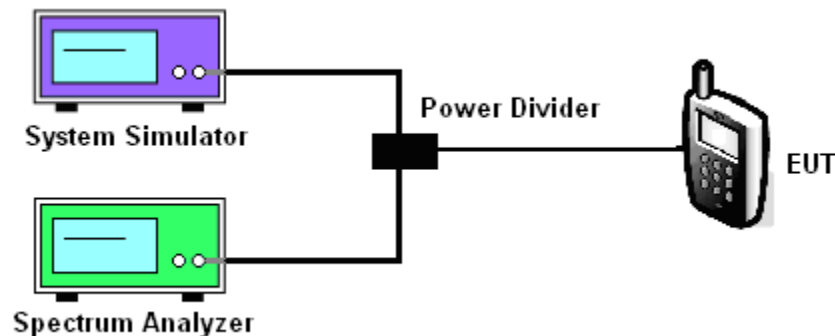



3.2.5 Test Result of Peak-to-Average Ratio

Cellular Band									
Modes	GSM850 (GPRS class 8)			GSM850 (EDGE class 8)			WCDMA Band V (RMC 12.2Kbps)		
Channel	128 (Low)	189 (Mid)	251 (High)	128 (Low)	189 (Mid)	251 (High)	4132 (Low)	4182 (Mid)	4233 (High)
Frequency (MHz)	824.2	836.4	848.8	824.2	836.4	848.8	826.4	836.4	846.6
Peak-to-Average Ratio (dB)	0.28	0.24	0.28	3.44	3.16	3.04	3.36	3.32	3.28

PCS Band									
Modes	GSM1900 (GPRS class 8)			GSM1900 (EDGE class 8)			WCDMA Band II (RMC 12.2Kbps)		
Channel	512 (Low)	661 (Mid)	810 (High)	512 (Low)	661 (Mid)	810 (High)	9262 (Low)	9400 (Mid)	9538 (High)
Frequency (MHz)	1850.2	1880	1909.8	1850.2	1880	1909.8	1852.4	1880	1907.6
Peak-to-Average Ratio (dB)	0.28	0.28	0.28	3.16	3.12	3.28	3.16	3.36	3.36

AWS Band			
Modes	WCDMA Band IV (RMC 12.2Kbps)		
Channel	1312(Low)	1413 (Mid)	1513 (High)
Frequency (MHz)	1712.4	1732.6	1752.6
Peak-to-Average Ratio (dB)	3.32	3.40	3.36



3.2.6 Test Result (Plots) of Peak-to-Average Ratio

Band :	GSM 850	Test Mode :	GPRS class 8 Link (GMSK)
--------	---------	-------------	--------------------------

Peak-to-Average Ratio on Channel 128 (824.2 MHz)

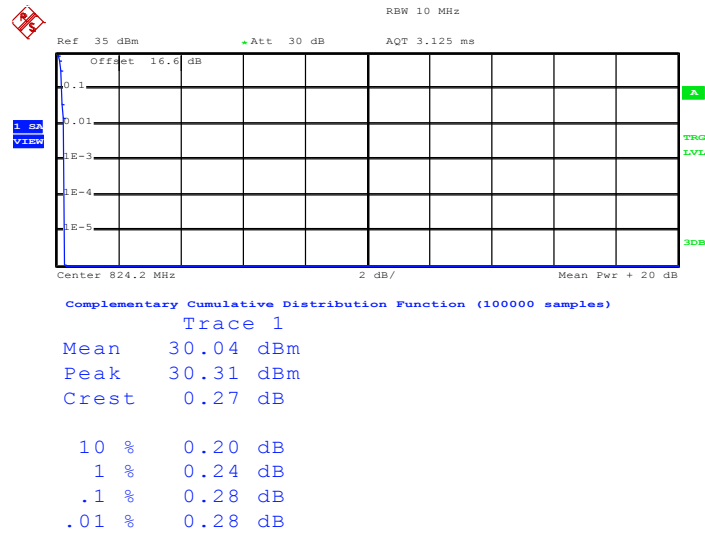

Date: 15.JUL.2015 11:22:25

Peak-to-Average Ratio on Channel 189 (836.4 MHz)

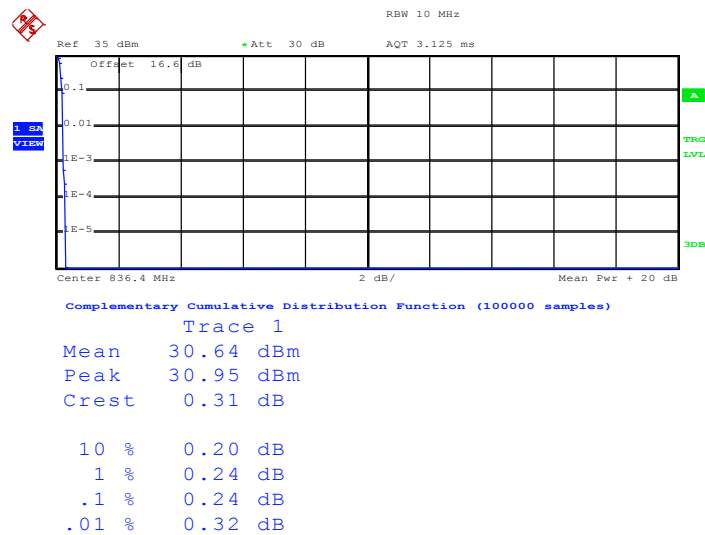

Date: 15.JUL.2015 11:22:39



Peak-to-Average Ratio on Channel 251 (848.8 MHz)

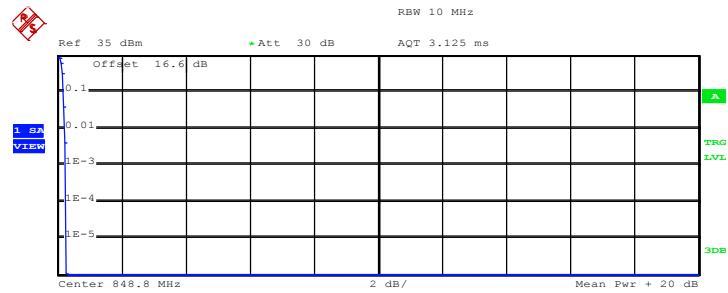

Complementary Cumulative Distribution Function (100000 samples)

Trace 1

Mean	30.67 dBm
Peak	30.95 dBm
Crest	0.27 dB
10 %	0.20 dB
1 %	0.24 dB
.1 %	0.28 dB
.01 %	0.28 dB

Date: 15.JUL.2015 11:22:55



Band :	GSM 850	Test Mode :	EDGE class 8 Link (8PSK)
---------------	---------	--------------------	--------------------------

Peak-to-Average Ratio on Channel 128 (824.2 MHz)

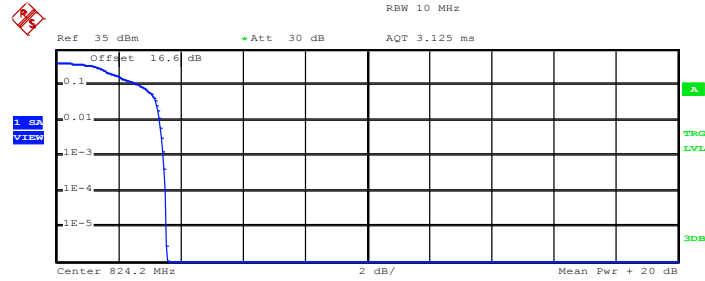

Complementary Cumulative Distribution Function (100000 samples)

Trace 1

Mean	25.70 dBm
Peak	29.26 dBm
Crest	3.55 dB
10 %	2.72 dB
1 %	3.32 dB
.1 %	3.44 dB
.01 %	3.52 dB

Date: 15.JUL.2015 11:32:27

Peak-to-Average Ratio on Channel 189 (836.4 MHz)

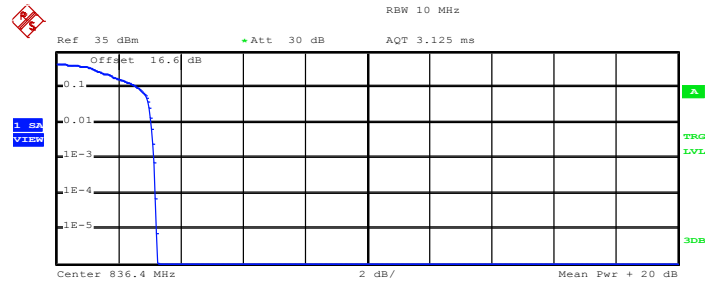

Complementary Cumulative Distribution Function (100000 samples)

Trace 1

Mean	26.51 dBm
Peak	29.75 dBm
Crest	3.24 dB
10 %	2.64 dB
1 %	3.08 dB
.1 %	3.16 dB
.01 %	3.20 dB

Date: 15.JUL.2015 11:32:41



Peak-to-Average Ratio on Channel 251 (848.8 MHz)

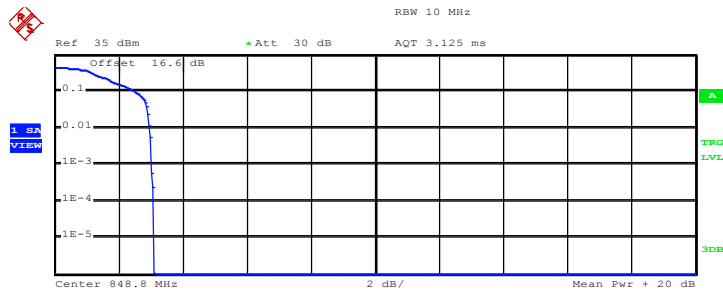

Complementary Cumulative Distribution Function (100000 samples)

Trace 1
 Mean 26.58 dBm
 Peak 29.68 dBm
 Crest 3.10 dB

10 % 2.56 dB
 1 % 2.96 dB
 .1 % 3.04 dB
 .01 % 3.12 dB

Date: 15.JUL.2015 11:33:19



Band :	GSM 1900	Test Mode :	GPRS class 8 Link (GMSK)
---------------	----------	--------------------	--------------------------

Peak-to-Average Ratio on Channel 512 (1850.2 MHz)

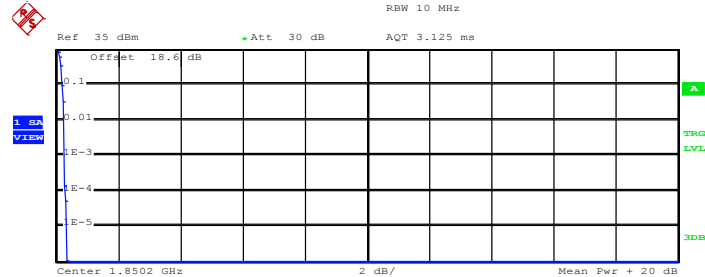

Complementary Cumulative Distribution Function (100000 samples)

Trace 1

Mean	26.79 dBm
Peak	27.14 dBm
Crest	0.35 dB
10 %	0.20 dB
1 %	0.28 dB
.1 %	0.28 dB
.01 %	0.28 dB

Date: 15.JUL.2015 11:45:50

Peak-to-Average Ratio on Channel 661 (1880.0 MHz)

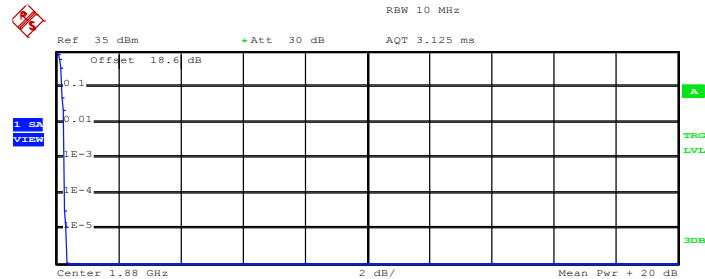

Complementary Cumulative Distribution Function (100000 samples)

Trace 1

Mean	27.01 dBm
Peak	27.35 dBm
Crest	0.34 dB
10 %	0.20 dB
1 %	0.28 dB
.1 %	0.28 dB
.01 %	0.28 dB

Date: 15.JUL.2015 11:46:03



Peak-to-Average Ratio on Channel 810 (1909.8 MHz)

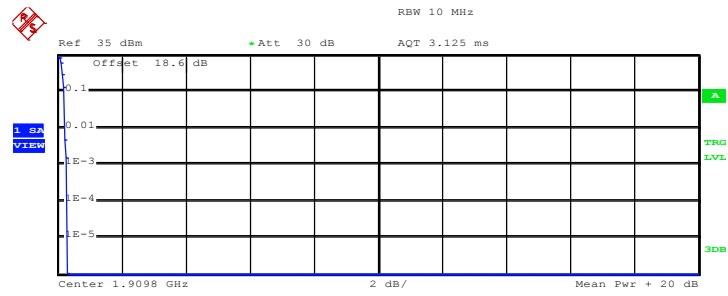

Complementary Cumulative Distribution Function (100000 samples)

Trace 1

Mean 27.05 dBm
 Peak 27.35 dBm
 Crest 0.30 dB

10 % 0.20 dB
 1 % 0.24 dB
 .1 % 0.28 dB
 .01 % 0.32 dB

Date: 15.JUL.2015 11:46:16



Band :	GSM 1900	Test Mode :	EDGE class 8 Link (8PSK)
---------------	----------	--------------------	--------------------------

Peak-to-Average Ratio on Channel 512 (1850.2 MHz)

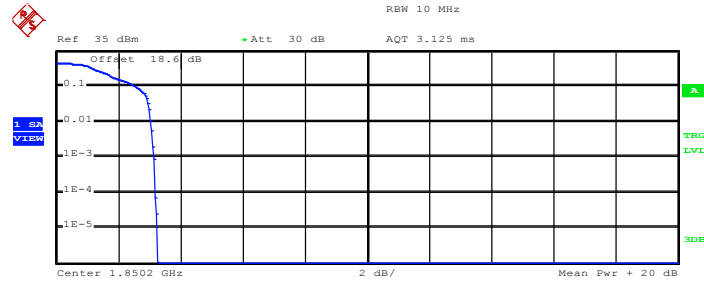

Complementary Cumulative Distribution Function (100000 samples)

Trace 1

Mean	24.73 dBm
Peak	27.99 dBm
Crest	3.25 dB
10 %	2.56 dB
1 %	3.04 dB
.1 %	3.16 dB
.01 %	3.20 dB

Date: 15.JUL.2015 11:55:27

Peak-to-Average Ratio on Channel 661 (1880.0 MHz)

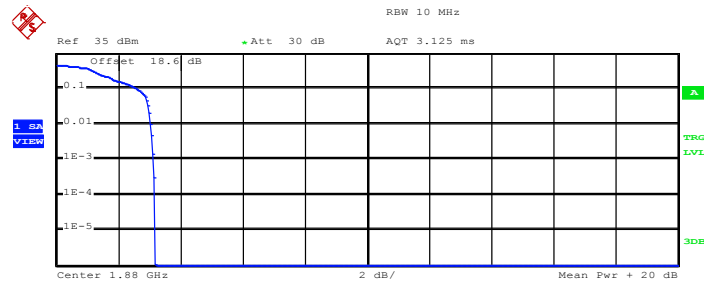

Complementary Cumulative Distribution Function (100000 samples)

Trace 1

Mean	25.10 dBm
Peak	28.27 dBm
Crest	3.16 dB
10 %	2.64 dB
1 %	3.04 dB
.1 %	3.12 dB
.01 %	3.20 dB

Date: 15.JUL.2015 11:55:52



Peak-to-Average Ratio on Channel 810 (1909.8 MHz)

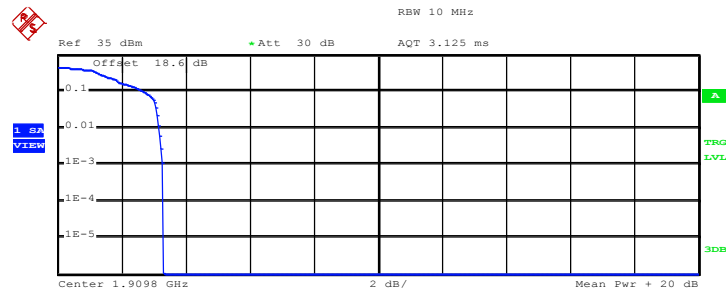

Complementary Cumulative Distribution Function (100000 samples)

Trace 1

Mean 24.89 dBm
 Peak 28.20 dBm
 Crest 3.31 dB

10 % 2.72 dB
 1 % 3.16 dB
 .1 % 3.28 dB
 .01 % 3.32 dB

Date: 15.JUL.2015 11:56:07



Band :	WCDMA Band V	Test Mode :	RMC 12.2Kbps Link (QPSK)
---------------	--------------	--------------------	--------------------------

Peak-to-Average Ratio on Channel 4132 (826.4 MHz)

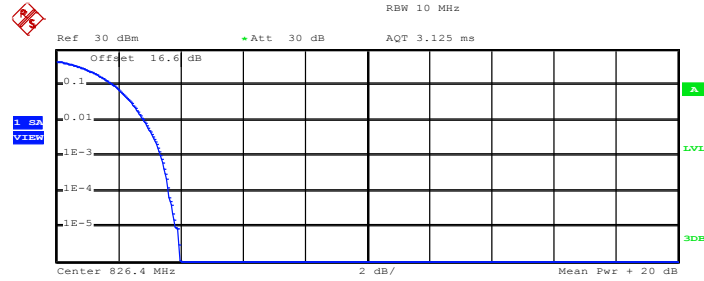

Complementary Cumulative Distribution Function (100000 samples)

Trace 1

Mean	20.07 dBm
Peak	24.04 dBm
Crest	3.98 dB
10 %	1.88 dB
1 %	2.84 dB
.1 %	3.36 dB
.01 %	3.64 dB

Date: 15.JUL.2015 14:32:45

Peak-to-Average Ratio on Channel 4182 (836.4 MHz)

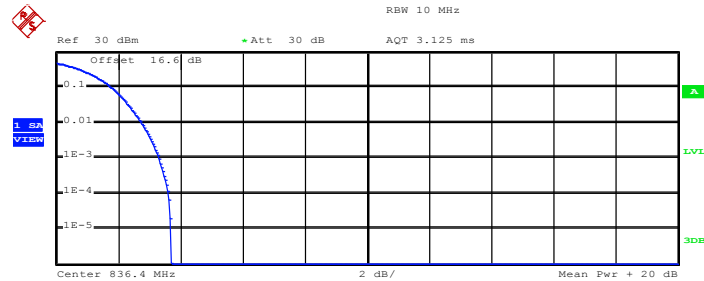

Complementary Cumulative Distribution Function (100000 samples)

Trace 1

Mean	19.86 dBm
Peak	23.55 dBm
Crest	3.69 dB
10 %	1.80 dB
1 %	2.76 dB
.1 %	3.32 dB
.01 %	3.60 dB

Date: 15.JUL.2015 14:32:57



Peak-to-Average Ratio on Channel 4233 (846.6 MHz)

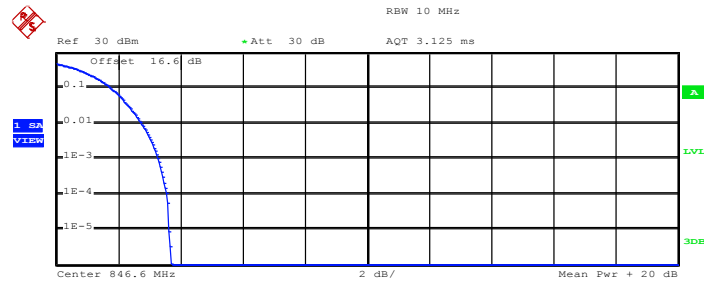

Complementary Cumulative Distribution Function (100000 samples)

Trace 1
 Mean 19.99 dBm
 Peak 23.69 dBm
 Crest 3.70 dB

10 %	1.76 dB
1 %	2.76 dB
.1 %	3.28 dB
.01 %	3.56 dB

Date: 15.JUL.2015 14:33:06



Band :	WCDMA Band IV	Test Mode :	RMC 12.2Kbps Link (QPSK)
---------------	---------------	--------------------	--------------------------

Peak-to-Average Ratio on Channel 1312 (1712.4 MHz)

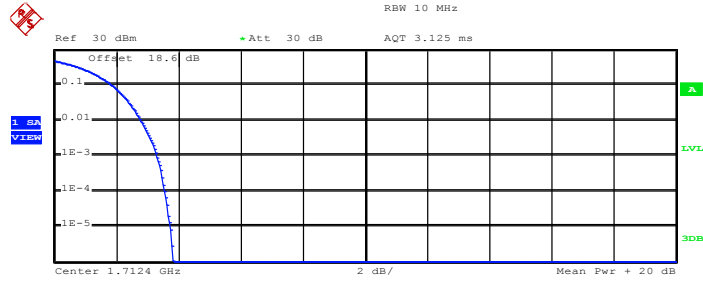

Complementary Cumulative Distribution Function (100000 samples)

Trace 1

Mean	20.37 dBm
Peak	24.18 dBm
Crest	3.81 dB
10 %	1.88 dB
1 %	2.80 dB
.1 %	3.32 dB
.01 %	3.56 dB

Date: 15.JUL.2015 13:46:26

Peak-to-Average Ratio on Channel 1413 (1732.6 MHz)

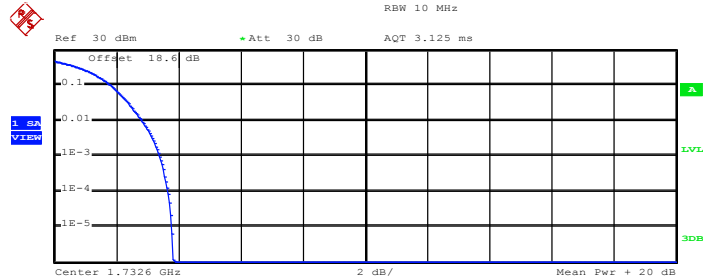

Complementary Cumulative Distribution Function (100000 samples)

Trace 1

Mean	20.34 dBm
Peak	24.18 dBm
Crest	3.84 dB
10 %	1.84 dB
1 %	2.84 dB
.1 %	3.40 dB
.01 %	3.68 dB

Date: 15.JUL.2015 13:46:35



Peak-to-Average Ratio on Channel 1513 (1752.6 MHz)

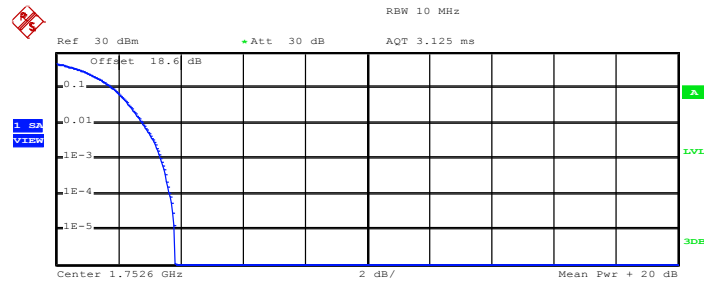

Complementary Cumulative Distribution Function (100000 samples)

Trace 1	
Mean	20.01 dBm
Peak	23.83 dBm
Crest	3.83 dB
10 %	1.84 dB
1 %	2.80 dB
.1 %	3.36 dB
.01 %	3.68 dB

Date: 15.JUL.2015 13:46:46



Band :	WCDMA Band II	Test Mode :	RMC 12.2Kbps Link (QPSK)
---------------	---------------	--------------------	--------------------------

Peak-to-Average Ratio on Channel 9262 (1852.4 MHz)

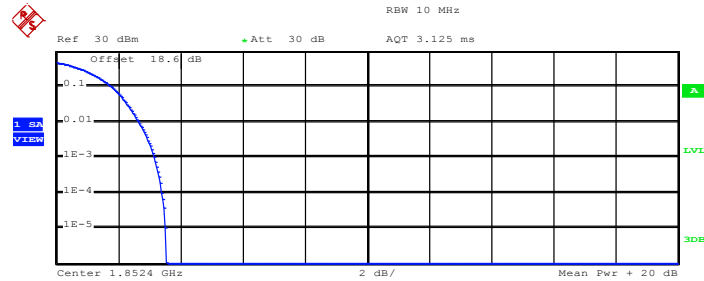

Complementary Cumulative Distribution Function (100000 samples)

Trace 1

Mean 20.44 dBm
 Peak 23.97 dBm
 Crest 3.53 dB

10 % 1.80 dB
 1 % 2.68 dB
 .1 % 3.16 dB
 .01 % 3.40 dB

Date: 15.JUL.2015 14:21:45

Peak-to-Average Ratio on Channel 9400 (1880.0 MHz)

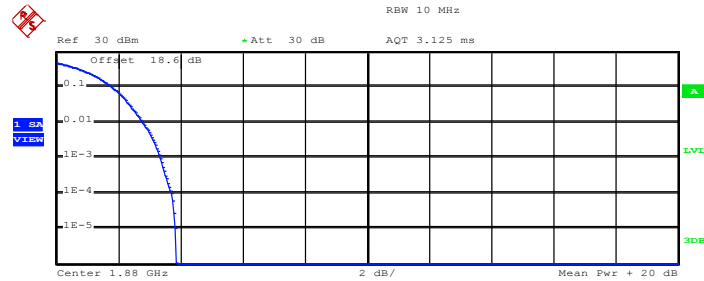

Complementary Cumulative Distribution Function (100000 samples)

Trace 1

Mean 20.18 dBm
 Peak 24.04 dBm
 Crest 3.86 dB

10 % 1.80 dB
 1 % 2.80 dB
 .1 % 3.36 dB
 .01 % 3.72 dB

Date: 15.JUL.2015 14:21:54



Peak-to-Average Ratio on Channel 9538 (1907.6 MHz)

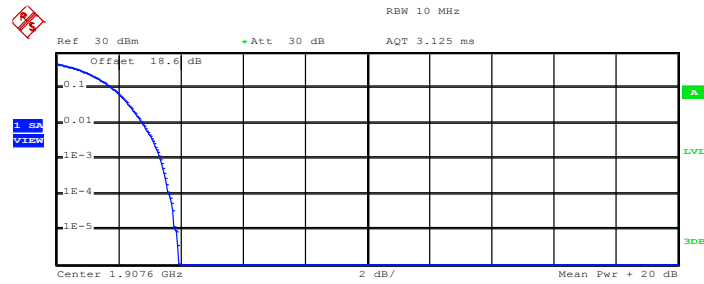

Complementary Cumulative Distribution Function (100000 samples)

Trace 1	
Mean	20.60 dBm
Peak	24.54 dBm
Crest	3.94 dB
10 %	1.80 dB
1 %	2.80 dB
.1 %	3.36 dB
.01 %	3.64 dB

Date: 15.JUL.2015 14:22:03



3.3 Effective Radiated Power and Effective Isotropic Radiated Power Measurement

3.3.1 Description of the ERP/EIRP Measurement

The substitution method, in ANSI / TIA / EIA-603-C-2004, was used for ERP/EIRP measurement, and the spectrum analyzer configuration follows KDB 971168 D01 Power Meas. License Digital Systems v02r02. The ERP of mobile transmitters must not exceed 7 Watts and the EIRP of mobile transmitters are limited to 2 Watts (PCS Band) and 1 Watts (AWS Band).

3.3.2 Measuring Instruments

The measuring equipment is listed in the section 4 of this test report.

3.3.3 Test Procedures

1. The testing follows FCC KDB 971168 v02r02 Section 5.2.1. (for CDMA/WCDMA), Section 5.2.2.2 (for GSM/GPRS/EDGE) and ANSI / TIA-603-C-2004 Section 2.2.17.
2. The EUT was placed on a non-conductive rotating platform 0.8 meters high in a semi-anechoic chamber. The radiated emission at the fundamental frequency was measured at 3 m with a test antenna and a spectrum analyzer with RMS detector per section 5. of KDB 971168 D01.
3. During the measurement, the system simulator parameters were set to force the EUT transmitting at maximum output power. The maximum emission was recorded from analyzer power level (LVL) from the 360 degrees rotation of the turntable and the test antenna raised and lowered over a range from 1 to 4 meters in both horizontally and vertically polarized orientations.
4. Effective Isotropic Radiated Power (EIRP) was measured by substitution method according to TIA/EIA-603-C. The EUT was replaced by the substitution antenna at same location, and then a known power from S.G. was applied into the dipole antenna through a Tx cable, and then recorded the maximum Analyzer reading through raised and lowered the test antenna. The correction factor (in dB) = S.G. - Tx Cable loss + Substitution antenna gain - Analyzer reading. Then the EUT's EIRP was calculated with the correction factor, $EIRP = LVL + \text{Correction factor}$ and $ERP = EIRP - 2.15$. Take the record of the output power at substitution antenna.

	GSM/GPRS/EDGE	WCDMA/HSPA
SPAN	500kHz	10MHz
RBW	10kHz	100kHz
VBW	30kHz	300kHz
Detector	RMS	RMS
Trace	Average	Average
Average Type	Power	Power
Sweep Count	100	100

3.3.4 Test Setup

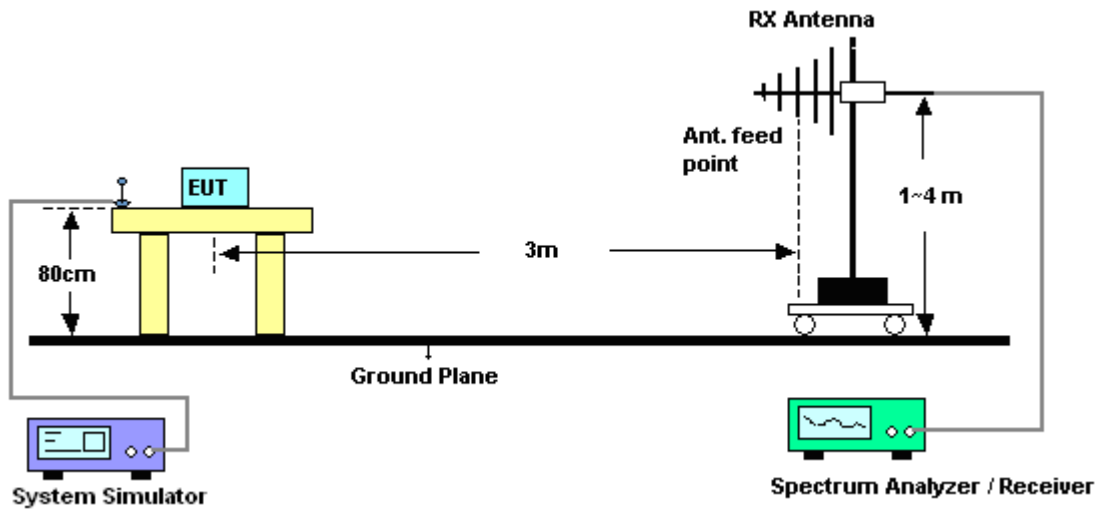



3.3.5 Test Result of ERP

GSM850 (GPRS class 8) Radiated Power ERP					
Channel	Frequency (MHz)	Horizontal		Vertical	
		ERP(dBm)	ERP(W)	ERP(dBm)	ERP(W)
Lowest	824.20	29.17	0.8260	17.30	0.0537
Middle	836.40	28.70	0.7413	17.54	0.0568
Highest	848.80	28.27	0.6714	17.92	0.0619
Limit	ERP < 7W	Result		PASS	

GSM850 (EDGE class 8) Radiated Power ERP					
Channel	Frequency (MHz)	Horizontal		Vertical	
		ERP(dBm)	ERP(W)	ERP(dBm)	ERP(W)
Lowest	824.20	23.12	0.2051	11.24	0.0133
Middle	836.40	22.71	0.1866	9.90	0.0098
Highest	848.80	22.15	0.1641	10.24	0.0106
Limit	ERP < 7W	Result		PASS	

WCDMA Band V (RMC 12.2Kbps) Radiated Power ERP					
Channel	Frequency (MHz)	Horizontal		Vertical	
		ERP(dBm)	ERP(W)	ERP(dBm)	ERP(W)
Lowest	826.40	20.67	0.1167	8.54	0.0071
Middle	836.40	19.95	0.0989	8.85	0.0077
Highest	846.60	19.61	0.0914	8.98	0.0079
Limit	ERP < 7W	Result		PASS	



3.3.6 Test Result of EIRP

GSM1900 (GPRS class 8) Radiated Power EIRP					
Channel	Frequency (MHz)	Horizontal		Vertical	
		EIRP(dBm)	EIRP(W)	EIRP(dBm)	EIRP(W)
Lowest	1850.20	29.60	0.9120	27.35	0.5433
Middle	1880.00	29.84	0.9638	27.15	0.5188
Highest	1909.80	29.81	0.9572	26.86	0.4853
Limit	EIRP < 2W	Result		PASS	

GSM1900 (EDGE class 8) Radiated Power EIRP					
Channel	Frequency (MHz)	Horizontal		Vertical	
		EIRP(dBm)	EIRP(W)	EIRP(dBm)	EIRP(W)
Lowest	1850.20	25.36	0.3436	23.24	0.2109
Middle	1880.00	25.47	0.3524	22.92	0.1959
Highest	1909.80	25.60	0.3631	22.84	0.1923
Limit	EIRP < 2W	Result		PASS	

WCDMA Band II (RMC 12.2Kbps) Radiated Power EIRP					
Channel	Frequency (MHz)	Horizontal		Vertical	
		EIRP(dBm)	EIRP(W)	EIRP(dBm)	EIRP(W)
Lowest	1852.40	23.68	0.2333	21.64	0.1459
Middle	1880.00	23.81	0.2404	21.21	0.1321
Highest	1907.60	23.87	0.2438	21.03	0.1268
Limit	EIRP < 2W	Result		PASS	

WCDMA Band IV(RMC 12.2Kbps) Radiated Power EIRP					
Channel	Frequency (MHz)	Horizontal		Vertical	
		EIRP(dBm)	EIRP(W)	EIRP(dBm)	EIRP(W)
Lowest	1712.40	22.45	0.1758	22.51	0.1782
Middle	1732.60	22.57	0.1807	22.05	0.1603
Highest	1752.60	22.26	0.1683	21.72	0.1486
Limit	EIRP < 1W	Result		PASS	

3.4 99% Occupied Bandwidth and 26dB Bandwidth Measurement

3.4.1 Description of 99% Occupied Bandwidth and 26dB Bandwidth Measurement

The 99% occupied bandwidth is the width of a frequency band such that, below the lower and above the upper frequency limits, the mean powers emitted are each equal to a specified percentage 0.5% of the total mean transmitted power.

The emission bandwidth is defined as the width of the signal between two points, located at the 2 sides of the carrier frequency, outside of which all emissions are attenuated at least 26 dB below the transmitter power.

3.4.2 Measuring Instruments

The measuring equipment is listed in the section 4 of this test report.

3.4.3 Test Procedures

1. The testing follows FCC KDB 971168 v02r02 Section 4.2.
2. The EUT was connected to the spectrum analyzer and system simulator via a power divider.
3. The RF output of the EUT was connected to the spectrum analyzer by RF cable and attenuator. The path loss was compensated to the results for each measurement.
4. The 99% occupied bandwidth were measured, set RBW= 1% of span, VBW= 3*RBW, sample detector, trace maximum hold.
5. The 26dB bandwidth were measured, set RBW= 1% of EBW, VBW= 3*RBW, peak detector, trace maximum hold.

3.4.4 Test Setup

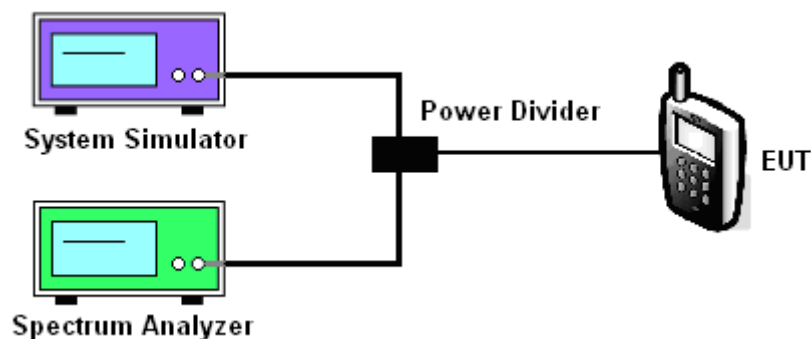



3.4.5 Test Result of Occupied Bandwidth and 26dB Bandwidth

Cellular Band						
Modes	GSM850 (GPRS class 8)			GSM850 (EDGE class 8)		
Channel	128 (Low)	189 (Mid)	251 (High)	128 (Low)	189 (Mid)	251 (High)
Frequency (MHz)	824.2	836.4	848.8	824.2	836.4	848.8
99% OBW (kHz)	246.00	248.00	246.00	243.00	244.00	243.00
26dB BW (kHz)	310.00	314.00	307.00	287.00	295.00	304.00

PCS Band						
Modes	GSM1900 (GPRS class 8)			GSM1900 (EDGE class 8)		
Channel	512 (Low)	661 (Mid)	810 (High)	512 (Low)	661 (Mid)	810 (High)
Frequency (MHz)	1850.2	1880	1909.8	1850.2	1880	1909.8
99% OBW (kHz)	247.00	242.00	245.00	246.00	246.00	243.00
26dB BW (kHz)	317.00	312.00	316.00	304.00	292.00	315.00

Cellular Band			
Modes	WCDMA Band V (RMC 12.2Kbps)		
Channel	4132 (Low)	4182 (Mid)	4233 (High)
Frequency (MHz)	826.4	836.4	846.6
99% OBW (MHz)	4.16	4.14	4.12
26dB BW (MHz)	4.72	4.70	4.71

AWS Band			
Modes	WCDMA Band IV (RMC 12.2Kbps)		
Channel	1312(Low)	1413 (Mid)	1513 (High)
Frequency (MHz)	1712.4	1732.6	1752.6
99% OBW (MHz)	4.16	4.16	4.16
26dB BW (MHz)	4.71	4.71	4.72



PCS Band			
Modes	WCDMA Band II (RMC 12.2Kbps)		
Channel	9262 (Low)	9400 (Mid)	9538 (High)
Frequency (MHz)	1852.4	1880	1907.6
99% OBW (MHz)	4.16	4.16	4.15
26dB BW (MHz)	4.72	4.73	4.71



3.4.6 Test Result (Plots) of Occupied Bandwidth and 26dB Bandwidth

Band :	GSM 850	Test Mode :	GPRS class 8 Link (GMSK)
--------	---------	-------------	--------------------------

99% Occupied Bandwidth Plot on Channel 128 (824.2 MHz)

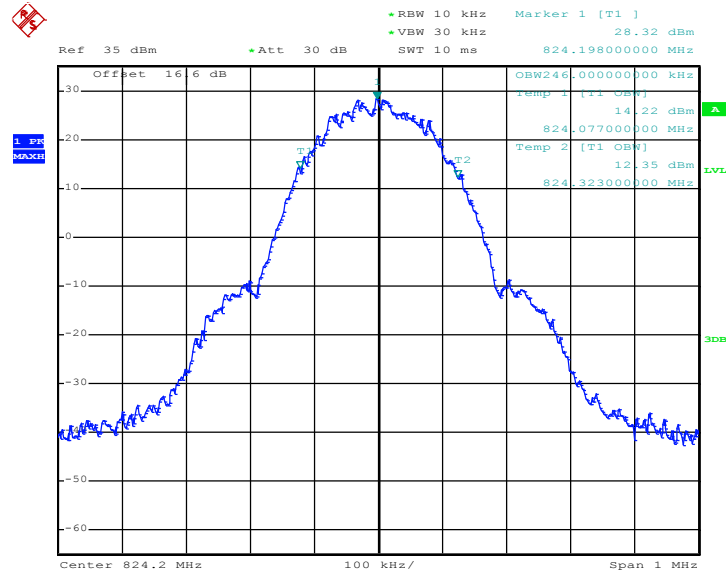

Date: 15.JUL.2015 11:16:21

26dB Bandwidth Plot on Channel 128 (824.2 MHz)

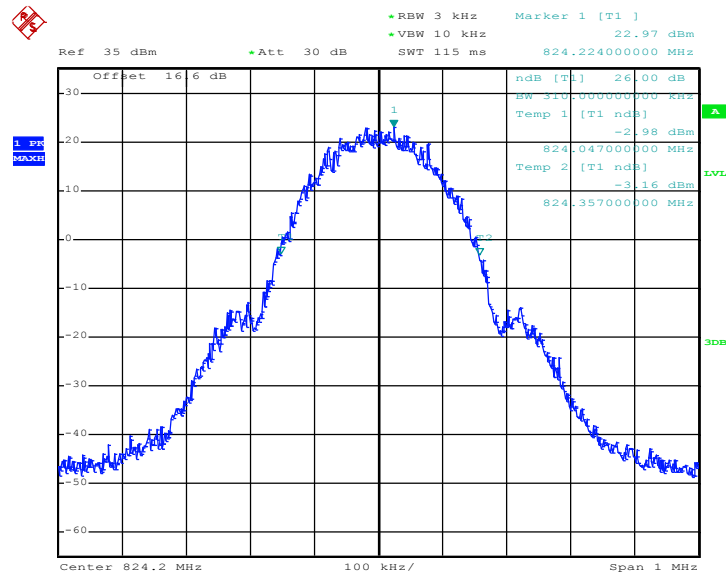

Date: 15.JUL.2015 11:14:22



99% Occupied Bandwidth Plot on Channel 189 (836.4 MHz)

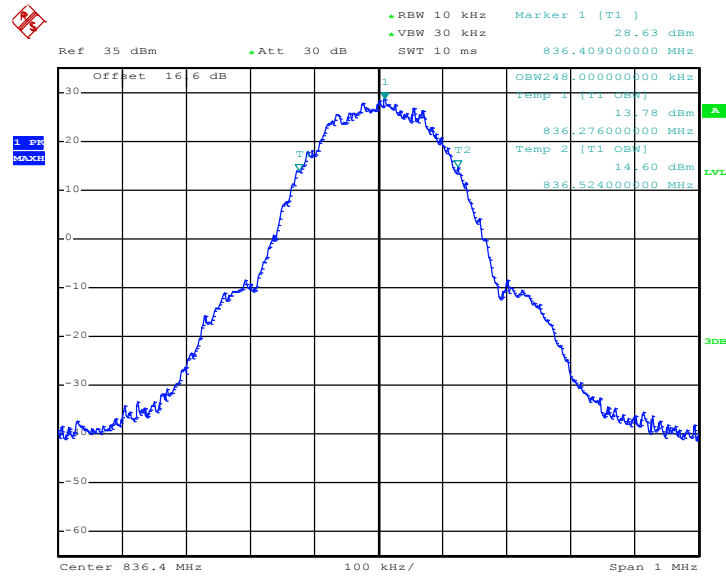

Date: 15.JUL.2015 11:16:49

26dB Bandwidth Plot on Channel 189 (836.4 MHz)

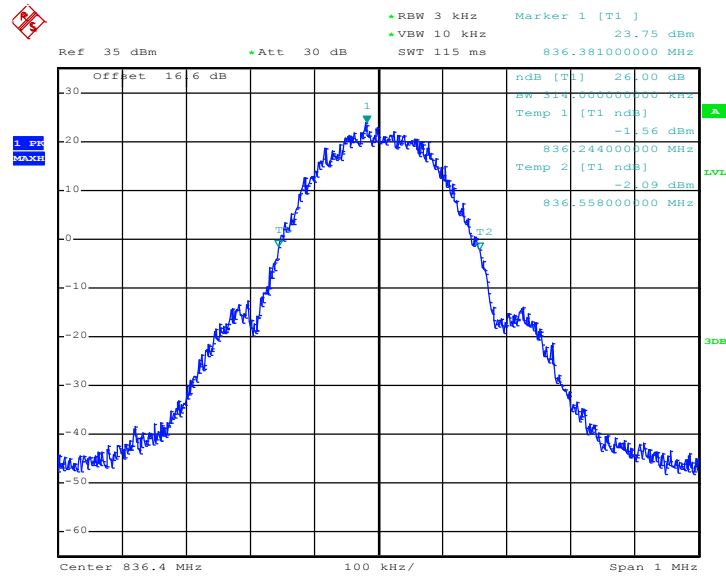

Date: 15.JUL.2015 11:14:50



99% Occupied Bandwidth Plot on Channel 251 (848.8 MHz)

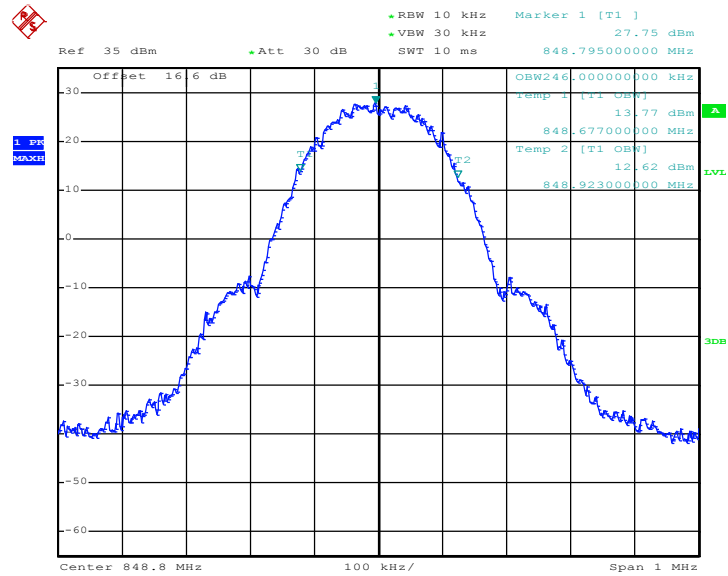

Date: 15.JUL.2015 11:17:18

26dB Bandwidth Plot on Channel 251 (848.8 MHz)

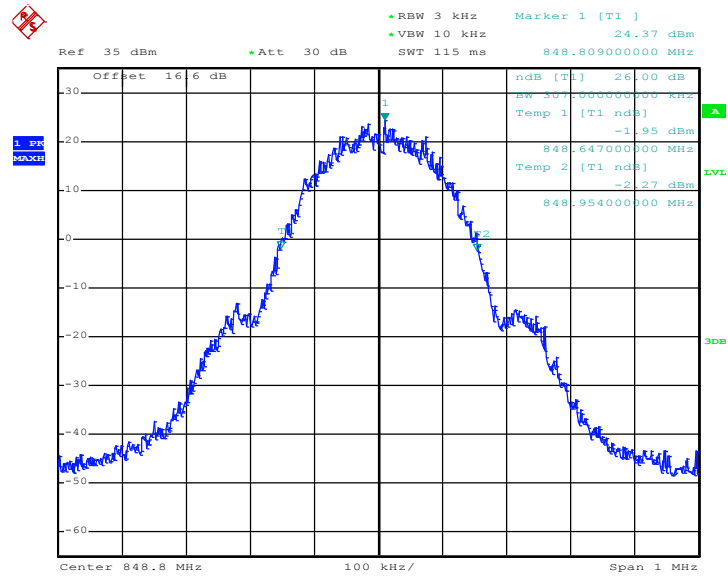

Date: 15.JUL.2015 11:15:19



Band :	GSM 850	Test Mode :	EDGE class 8 Link (8PSK)
---------------	---------	--------------------	--------------------------

99% Occupied Bandwidth Plot on Channel 128 (824.2 MHz)

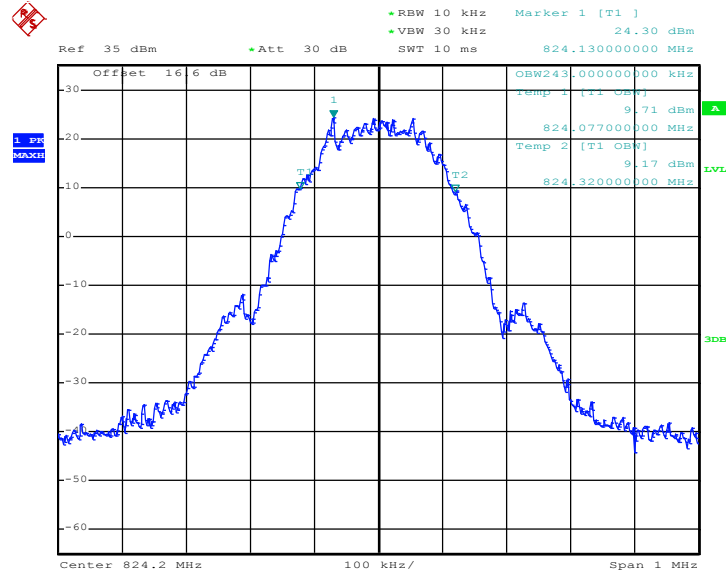

Date: 15.JUL.2015 11:26:35

26dB Bandwidth Plot on Channel 128 (824.2 MHz)

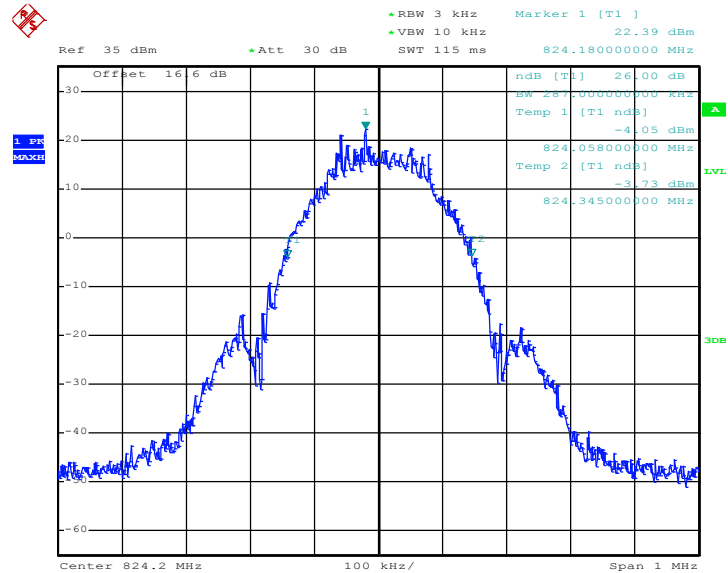

Date: 15.JUL.2015 11:24:31



99% Occupied Bandwidth Plot on Channel 189 (836.4 MHz)

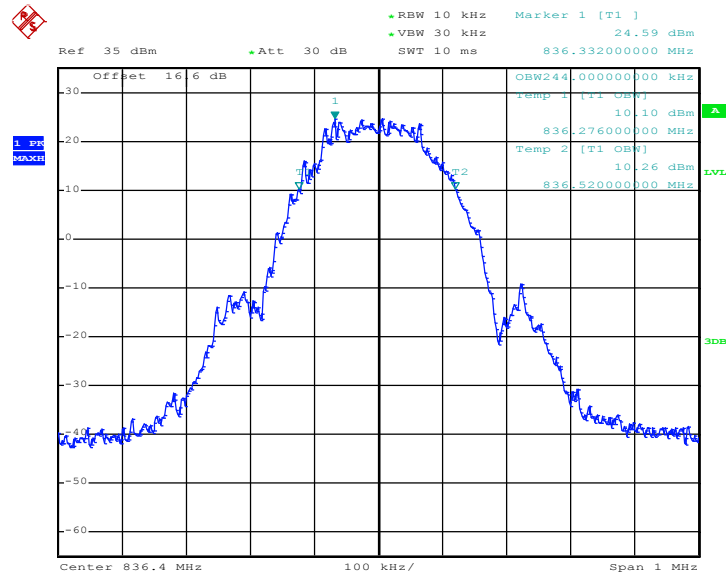

Date: 15.JUL.2015 11:27:03

26dB Bandwidth Plot on Channel 189 (836.4 MHz)

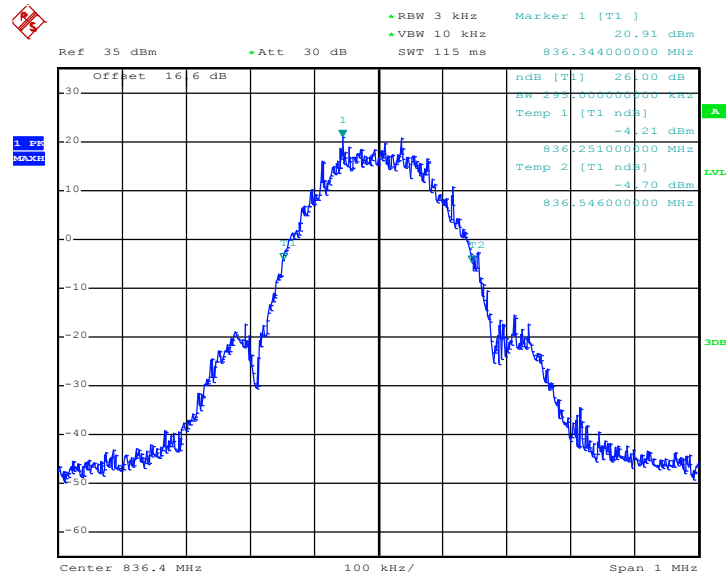

Date: 15.JUL.2015 11:25:00



99% Occupied Bandwidth Plot on Channel 251 (848.8 MHz)

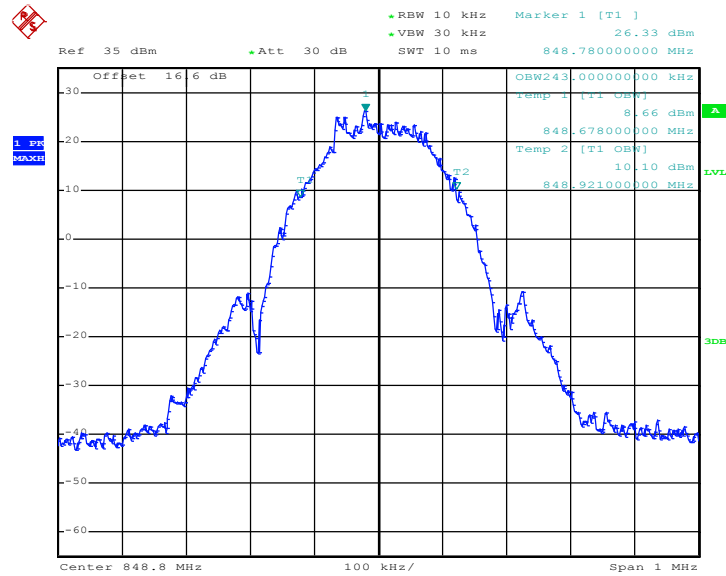

Date: 15.JUL.2015 11:27:31

26dB Bandwidth Plot on Channel 251 (848.8 MHz)

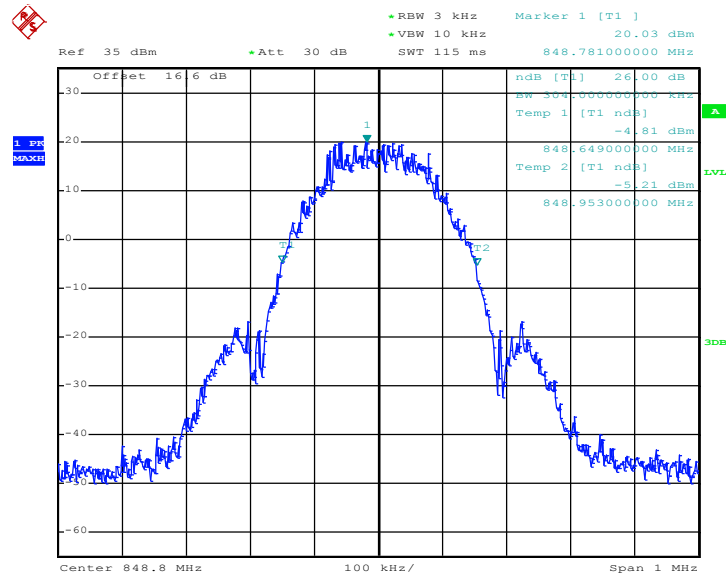

Date: 15.JUL.2015 11:25:28



Band :	GSM 1900	Test Mode :	GPRS class 8 Link (GMSK)
---------------	----------	--------------------	--------------------------

99% Occupied Bandwidth Plot on Channel 512 (1850.2 MHz)

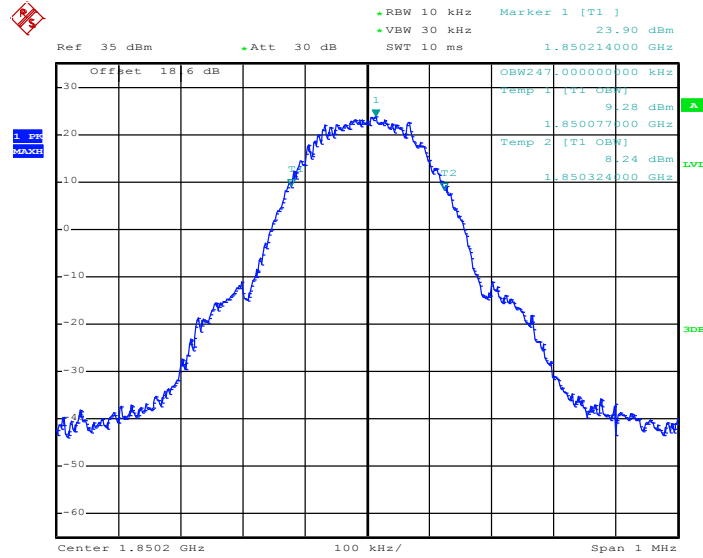

Date: 15.JUL.2015 11:38:16

26dB Bandwidth Plot on Channel 512 (1850.2 MHz)

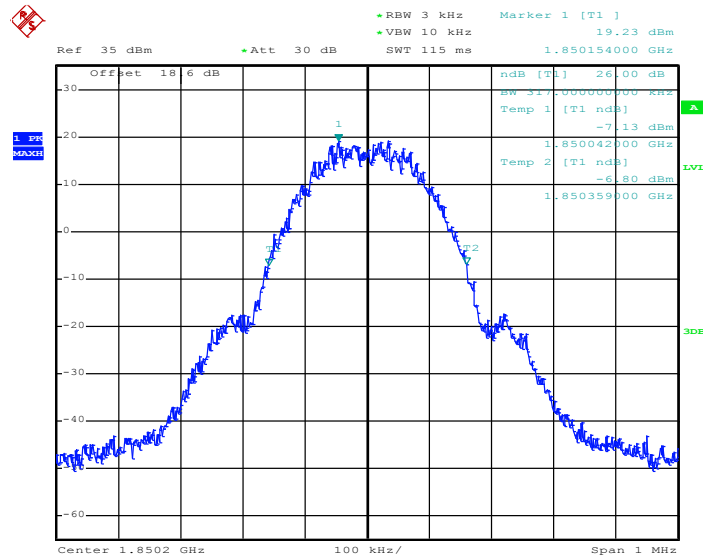

Date: 15.JUL.2015 11:36:22



99% Occupied Bandwidth Plot on Channel 661 (1880.0 MHz)

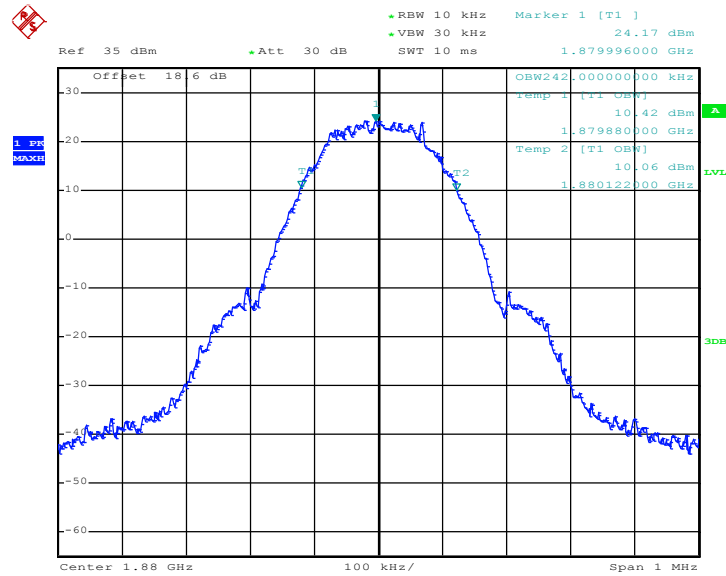

Date: 15.JUL.2015 11:38:45

26dB Bandwidth Plot on Channel 661 (1880.0 MHz)

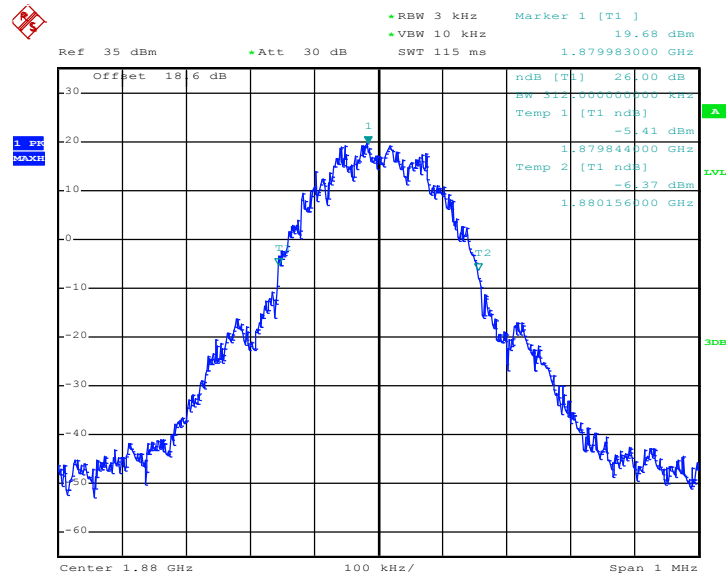

Date: 15.JUL.2015 11:36:51



99% Occupied Bandwidth Plot on Channel 810 (1909.8 MHz)

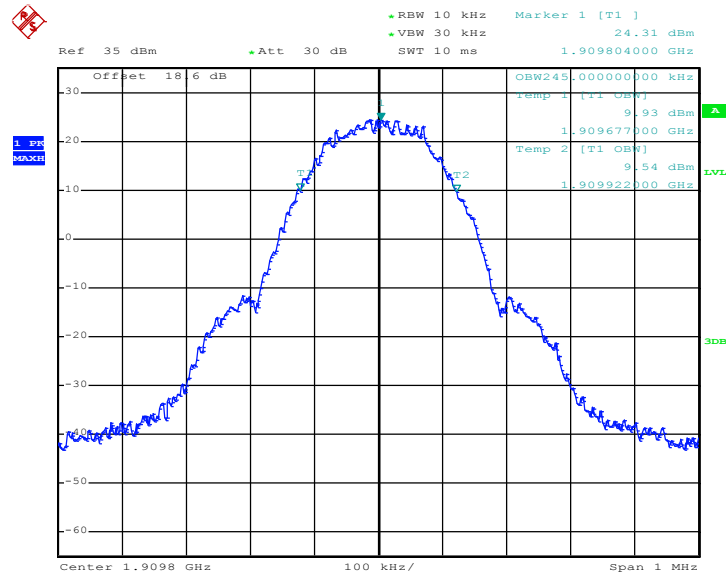

Date: 15.JUL.2015 11:39:13

26dB Bandwidth Plot on Channel 810 (1909.8 MHz)

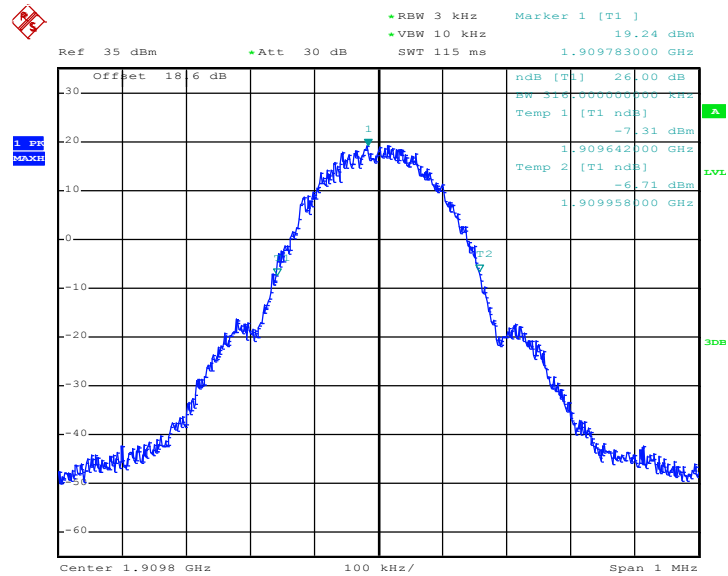

Date: 15.JUL.2015 11:37:19



Band :	GSM 1900	Test Mode :	EDGE class 8 Link (8PSK)
---------------	----------	--------------------	--------------------------

99% Occupied Bandwidth Plot on Channel 512 (1850.2 MHz)

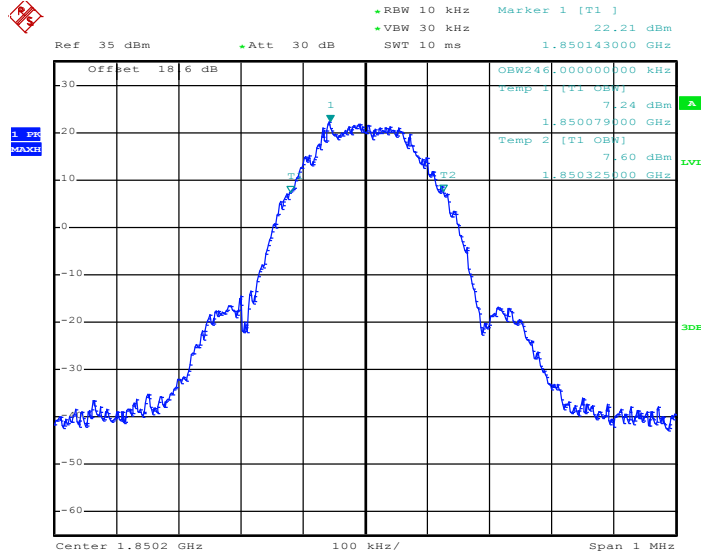

Date: 15.JUL.2015 11:49:11

26dB Bandwidth Plot on Channel 512 (1850.2 MHz)

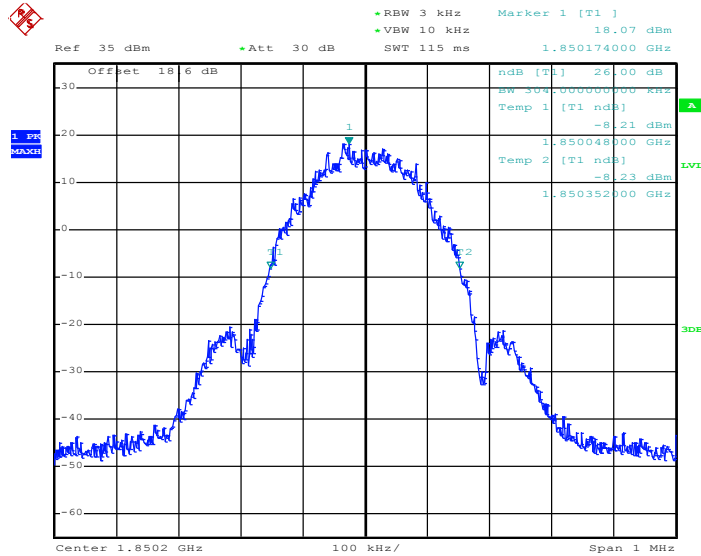

Date: 15.JUL.2015 11:47:40



99% Occupied Bandwidth Plot on Channel 661 (1880.0 MHz)

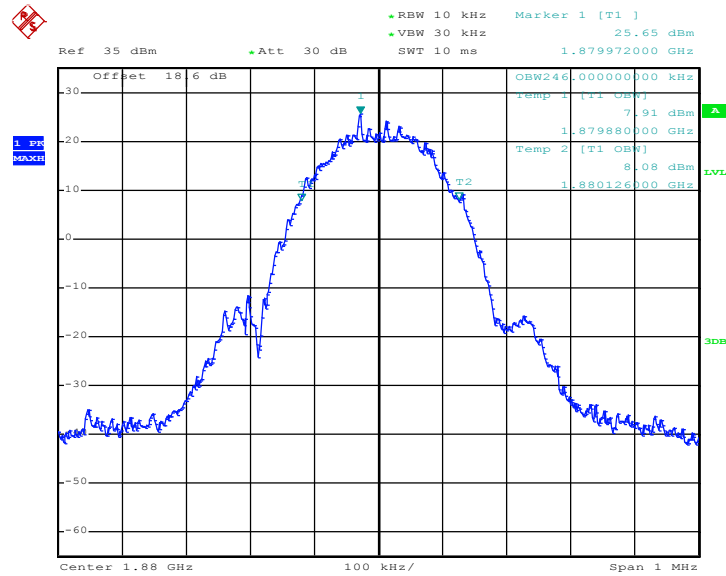

Date: 15.JUL.2015 11:49:40

26dB Bandwidth Plot on Channel 661 (1880.0 MHz)

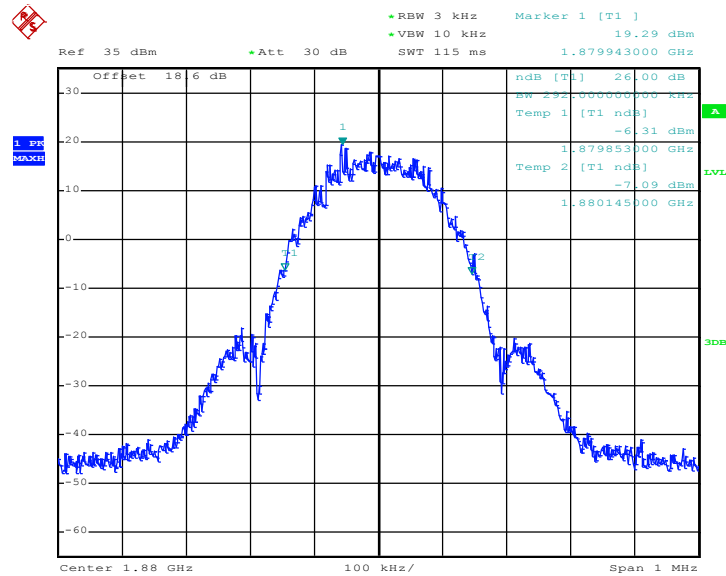

Date: 15.JUL.2015 11:48:08



99% Occupied Bandwidth Plot on Channel 810 (1909.8 MHz)

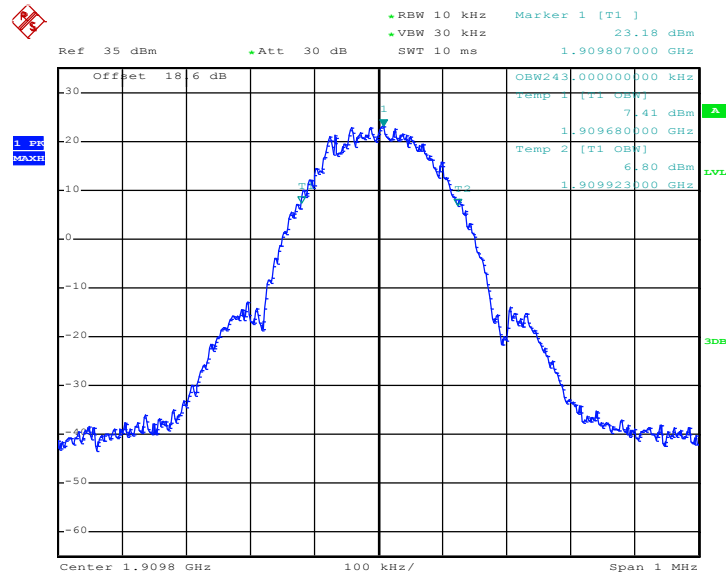

Date: 15.JUL.2015 11:50:08

26dB Bandwidth Plot on Channel 810 (1909.8 MHz)

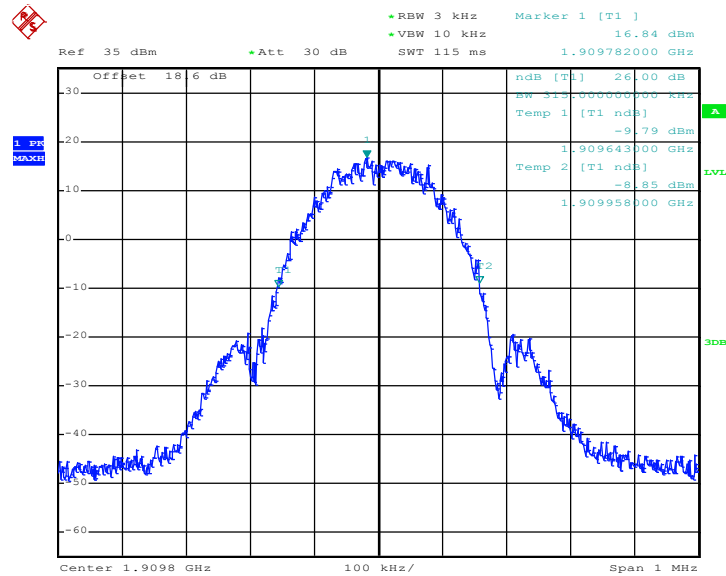

Date: 15.JUL.2015 11:48:36



Band :	WCDMA Band V	Test Mode :	RMC 12.2Kbps Link (QPSK)
---------------	--------------	--------------------	--------------------------

99% Occupied Bandwidth Plot on Channel 4132 (826.4 MHz)

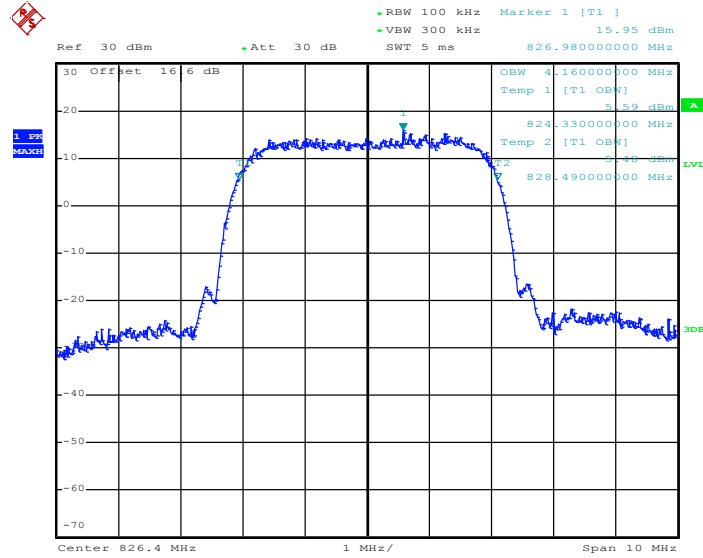

Date: 15.JUL.2015 14:25:29

26dB Bandwidth Plot on Channel 4132 (826.4 MHz)

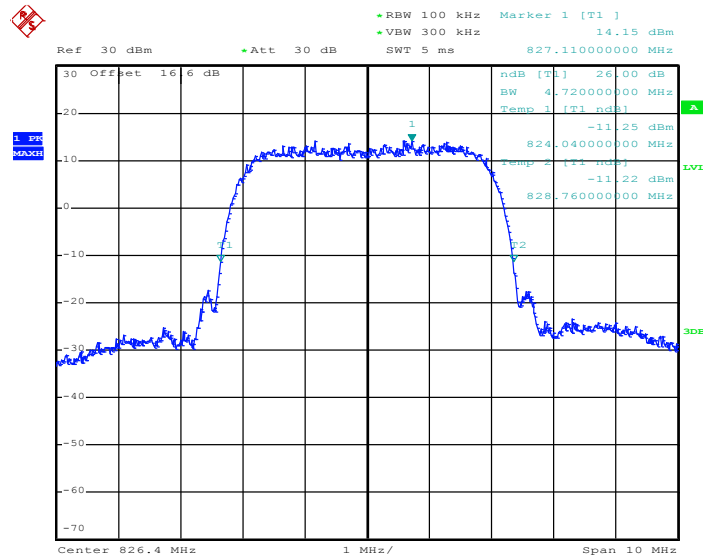

Date: 15.JUL.2015 14:23:42



99% Occupied Bandwidth Plot on Channel 4182 (836.4 MHz)

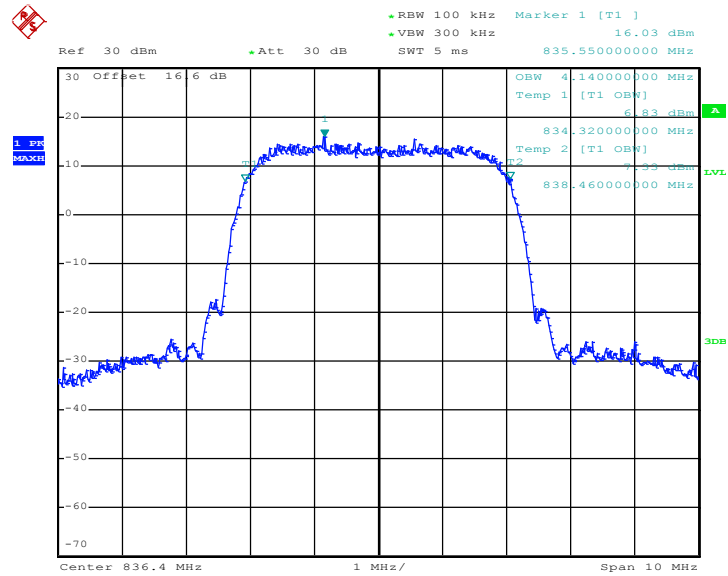

Date: 15.JUL.2015 14:25:57

26dB Bandwidth Plot on Channel 4182 (836.4 MHz)

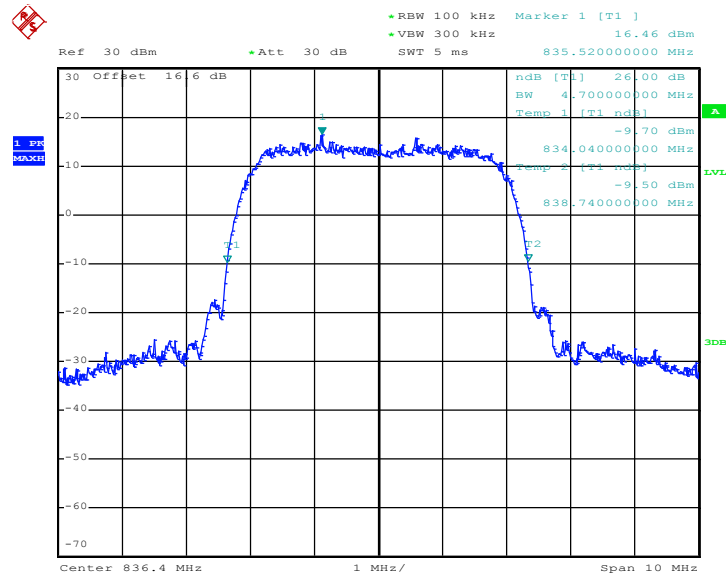

Date: 15.JUL.2015 14:24:10



99% Occupied Bandwidth Plot on Channel 4233 (846.6 MHz)

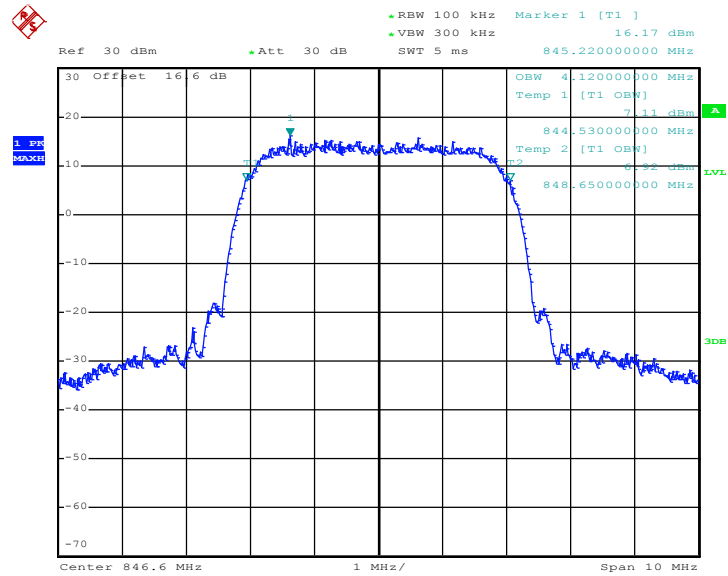

Date: 15.JUL.2015 14:26:25

26dB Bandwidth Plot on Channel 4233 (846.6 MHz)

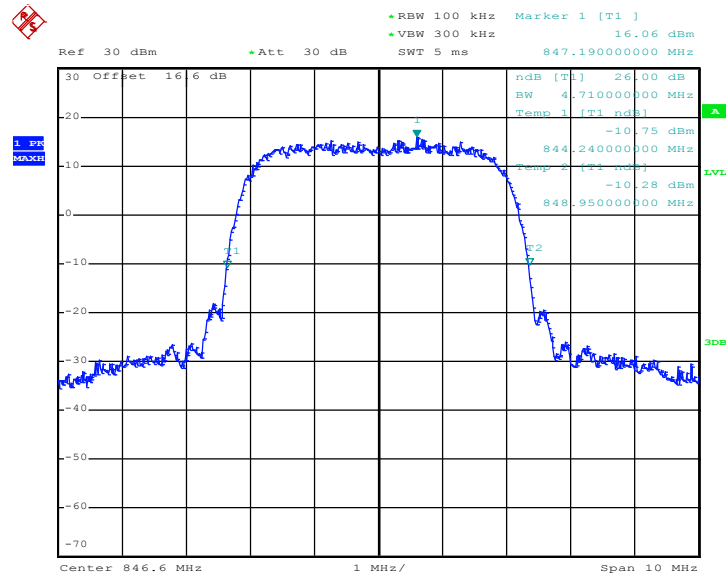

Date: 15.JUL.2015 14:24:38



Band :	WCDMA Band IV	Test Mode :	RMC 12.2Kbps Link (QPSK)
---------------	---------------	--------------------	--------------------------

99% Occupied Bandwidth Plot on Channel 1312 (1712.4 MHz)

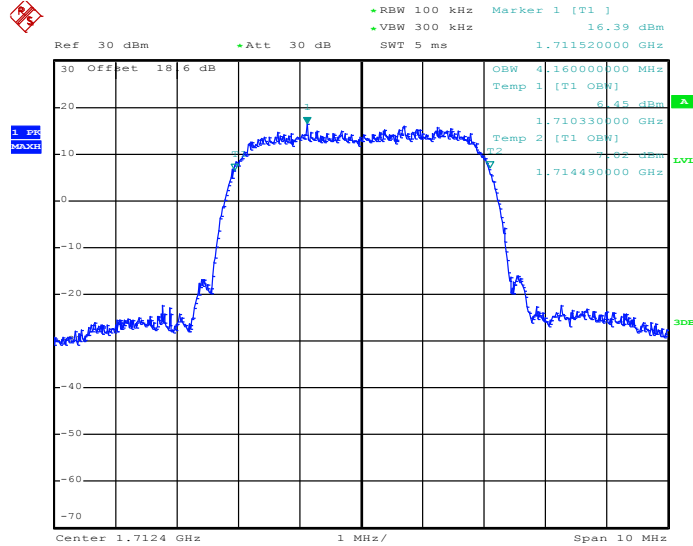

Date: 15.JUL.2015 13:40:35

26dB Bandwidth Plot on Channel 1312 (1712.4 MHz)

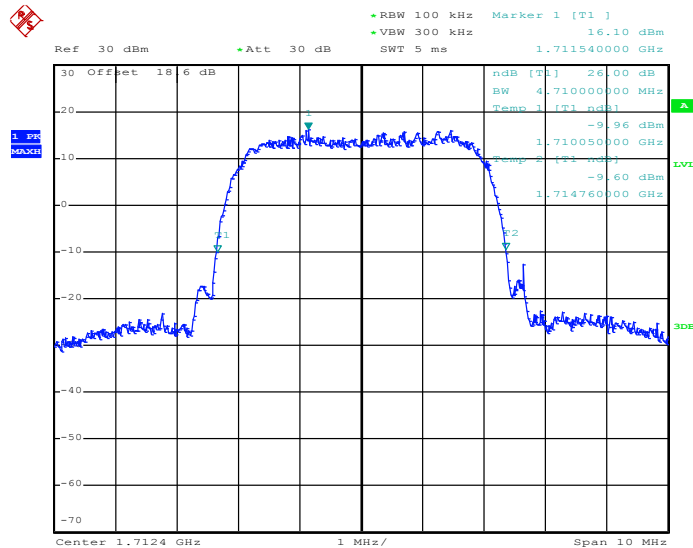

Date: 15.JUL.2015 13:38:29



99% Occupied Bandwidth Plot on Channel 1413 (1732.6 MHz)

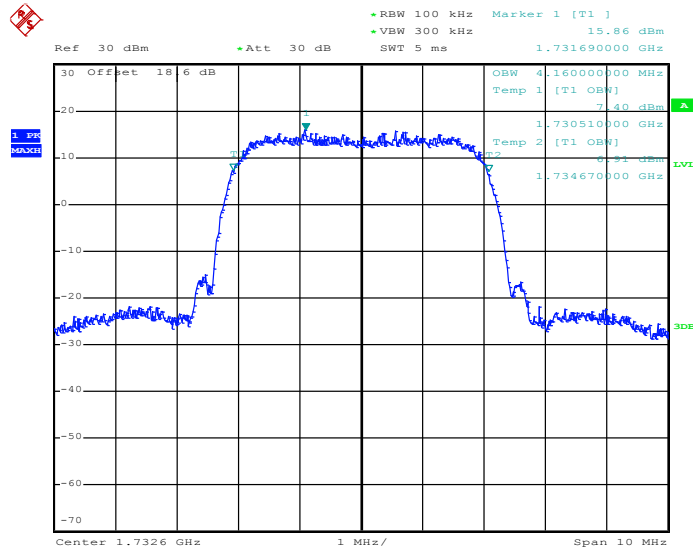

Date: 15.JUL.2015 13:41:03

26dB Bandwidth Plot on Channel 1413 (1732.6 MHz)

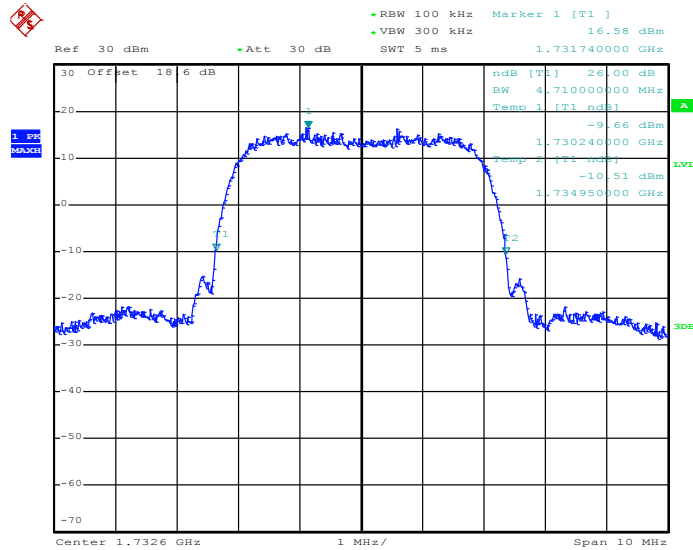

Date: 15.JUL.2015 13:38:57



99% Occupied Bandwidth Plot on Channel 1513 (1752.6 MHz)

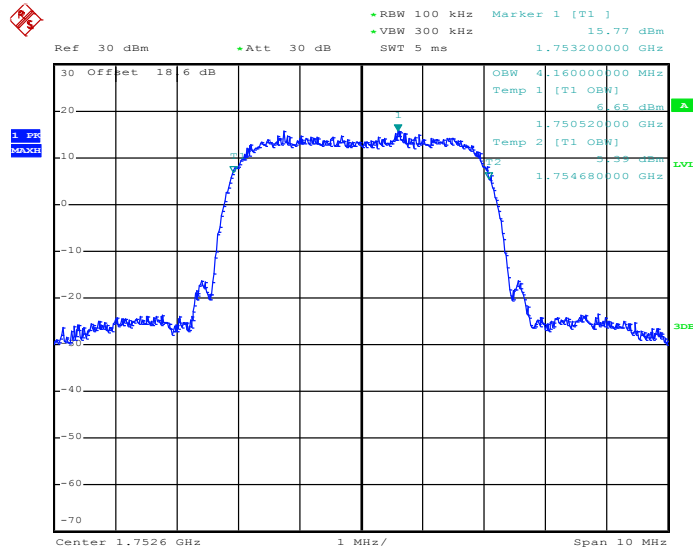

Date: 15.JUL.2015 13:41:31

26dB Bandwidth Plot on Channel 1513 (1752.6 MHz)

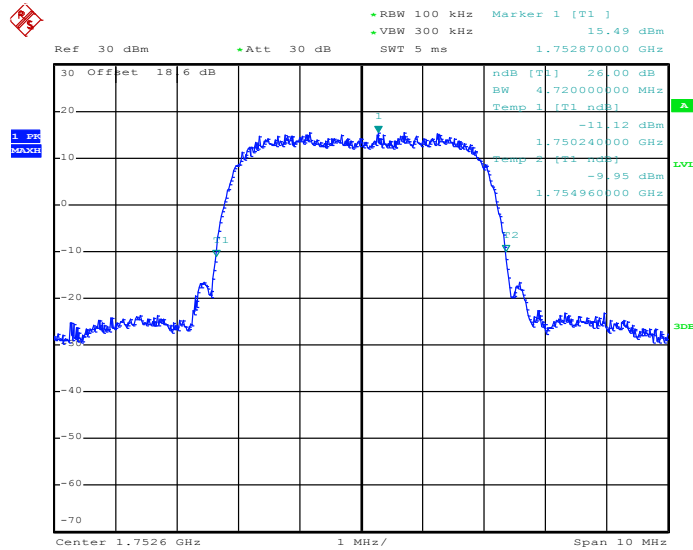

Date: 15.JUL.2015 13:39:25



Band :	WCDMA Band II	Test Mode :	RMC 12.2Kbps Link (QPSK)
---------------	---------------	--------------------	--------------------------

99% Occupied Bandwidth Plot on Channel 9262 (1852.4 MHz)

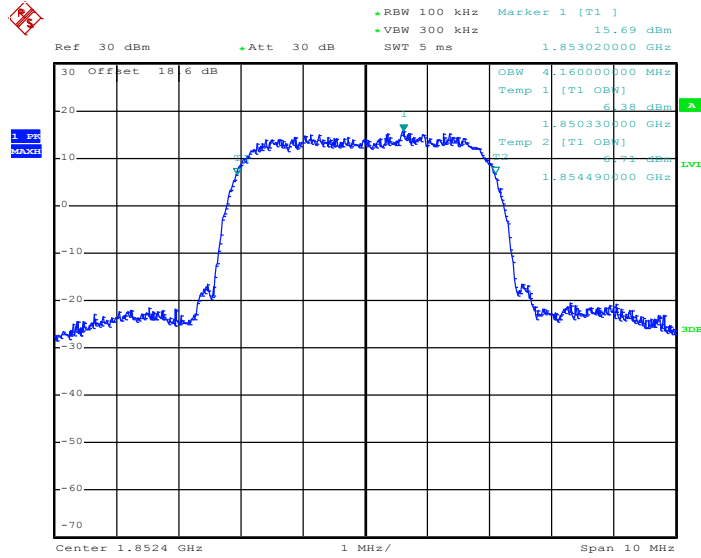

Date: 15.JUL.2015 13:54:54

26dB Bandwidth Plot on Channel 9262 (1852.4 MHz)

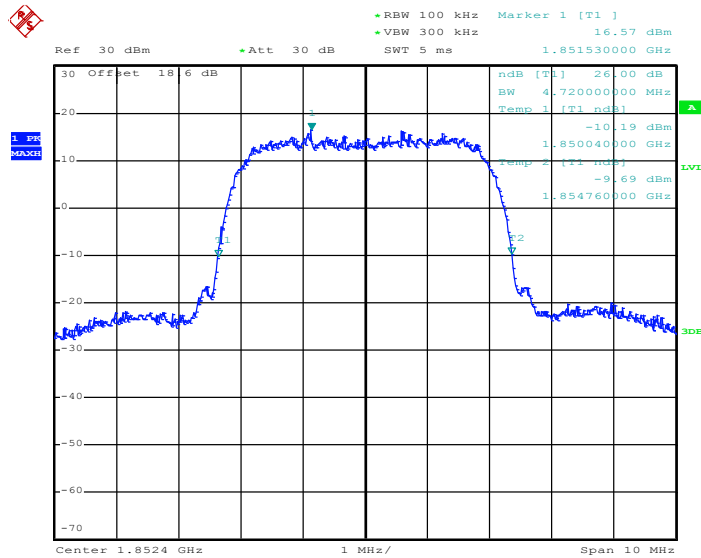

Date: 15.JUL.2015 13:51:21



99% Occupied Bandwidth Plot on Channel 9400 (1880.0 MHz)

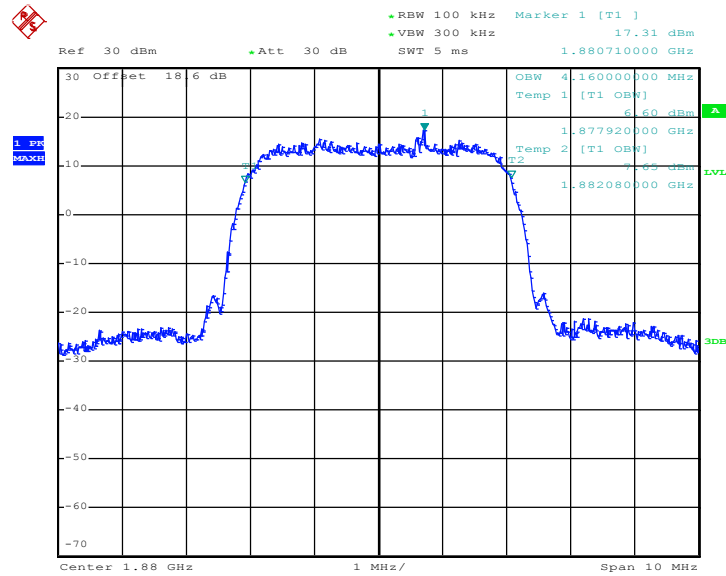

Date: 15.JUL.2015 13:55:22

26dB Bandwidth Plot on Channel 9400 (1880.0 MHz)

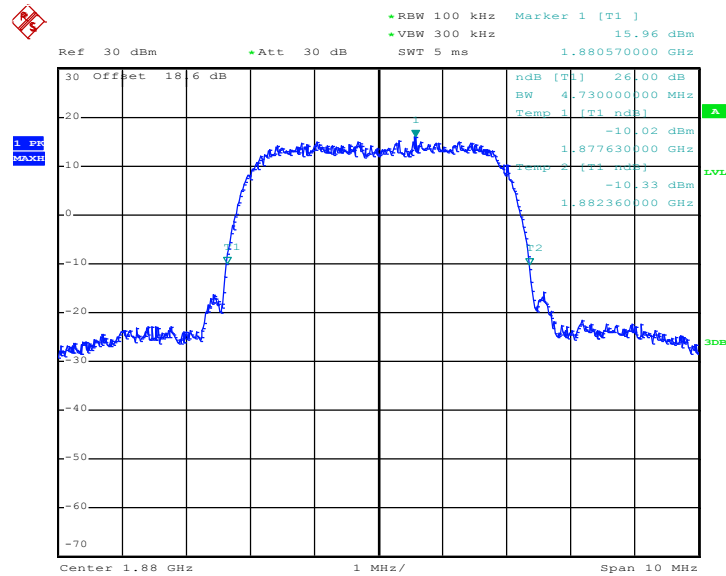

Date: 15.JUL.2015 13:51:49



99% Occupied Bandwidth Plot on Channel 9538 (1907.6 MHz)

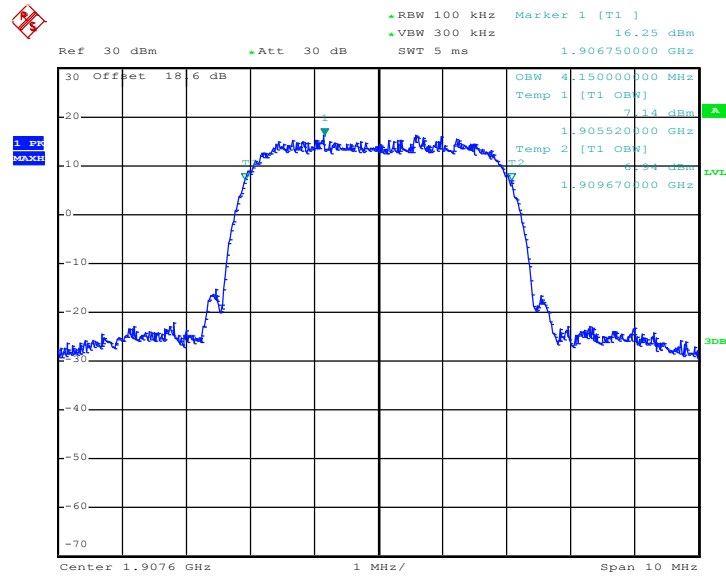

Date: 15.JUL.2015 13:55:50

26dB Bandwidth Plot on Channel 9538 (1907.6 MHz)

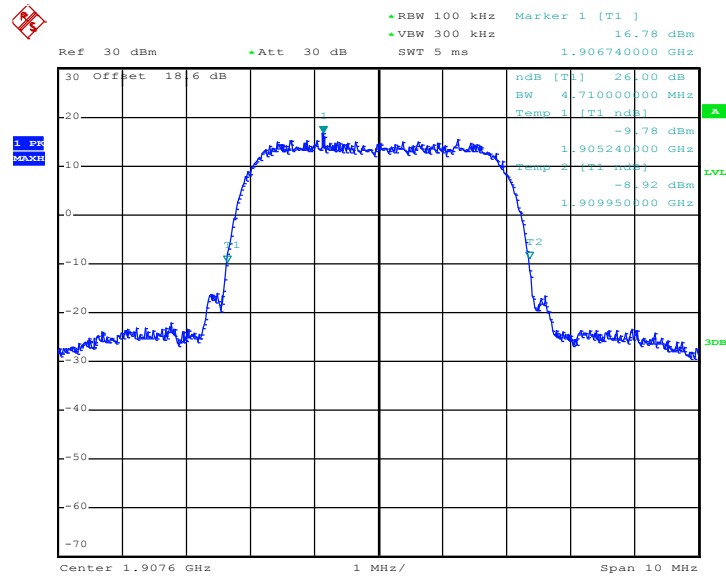

Date: 15.JUL.2015 13:52:17

3.5 Band Edge Measurement

3.5.1 Description of Band Edge Measurement

The power of any emission outside of the authorized operating frequency ranges must be lower than the transmitter power (P) by a factor of at least $43 + 10 \log (P)$ dB.

3.5.2 Measuring Instruments

The measuring equipment is listed in the section 4 of this test report.

3.5.3 Test Procedures

1. The testing follows FCC KDB 971168 v02r02 Section 6.0.
2. The EUT was connected to the spectrum analyzer and system simulator via a power divider.
3. The RF output of EUT was connected to the spectrum analyzer by an RF cable and attenuator. The path loss was compensated to the results for each measurement.
4. The band edges of low and high channels for the highest RF powers were measured.
5. The RF fundamental frequency should be excluded against the limit line in the operating frequency band.
6. The limit line is derived from $43 + 10\log(P)$ dB below the transmitter power P(Watts)
 $= P(W) - [43 + 10\log(P)] \text{ (dB)}$
 $= [30 + 10\log(P)] \text{ (dBm)} - [43 + 10\log(P)] \text{ (dB)}$
 $= -13\text{dBm}.$

3.5.4 Test Setup

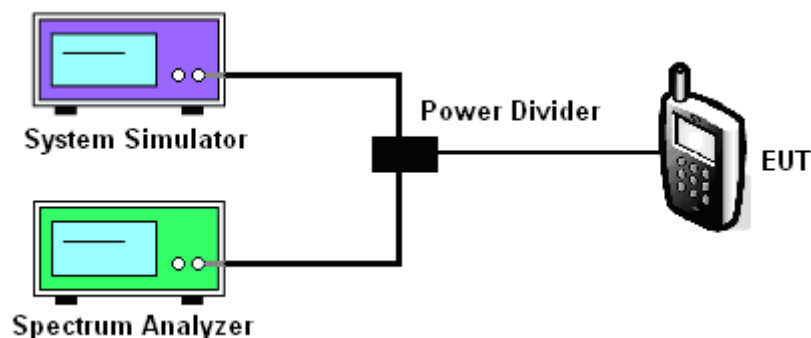



3.5.5 Test Result (Plots) of Conducted Band Edge

Band :	GSM850	Test Mode :	GPRS class 8 Link (GMSK)
--------	--------	-------------	--------------------------

Lower Band Edge Plot on Channel 128 (824.2 MHz)

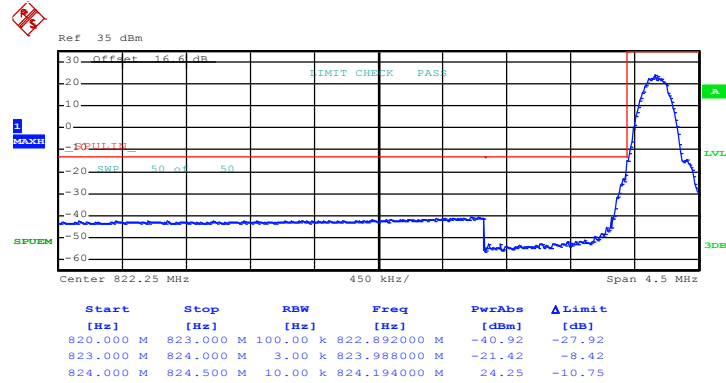

Date: 15.JUL.2015 11:19:05

Higher Band Edge Plot on Channel 251 (848.8 MHz)

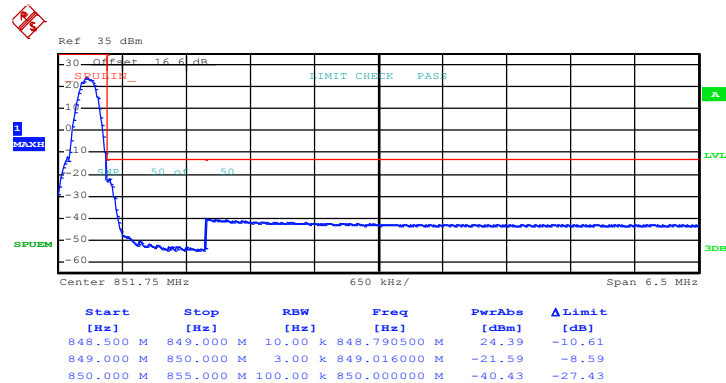

Date: 15.JUL.2015 11:20:28



Band :	GSM850	Test Mode :	EDGE class 8 Link (8PSK)
--------	--------	-------------	--------------------------

Lower Band Edge Plot on Channel 128 (824.2 MHz)

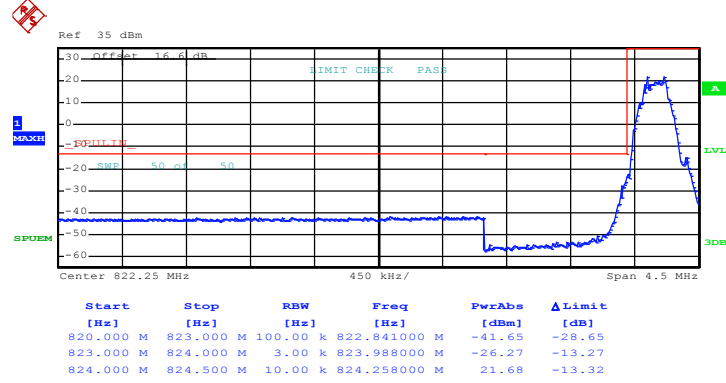

Date: 15.JUL.2015 11:28:56

Higher Band Edge Plot on Channel 251 (848.8 MHz)

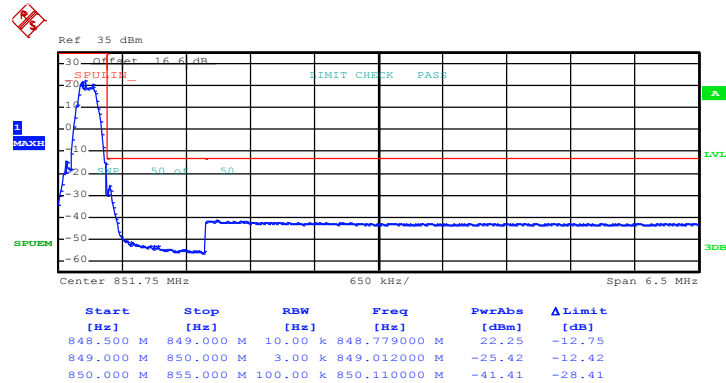

Date: 15.JUL.2015 11:30:19



Band :	GSM1900	Test Mode :	GPRS class 8 Link (GMSK)
--------	---------	-------------	--------------------------

Lower Band Edge Plot on Channel 512 (1850.2 MHz)

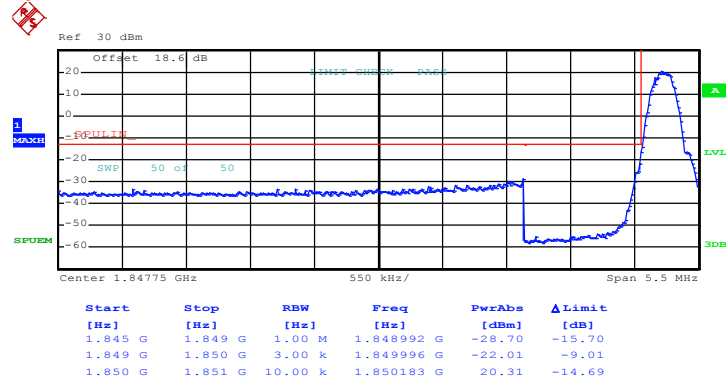

Date: 15.JUL.2015 11:40:54

Higher Band Edge Plot on Channel 810 (1909.8 MHz)

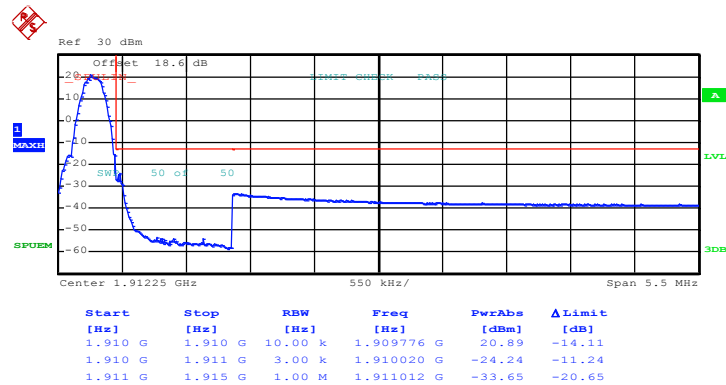

Date: 15.JUL.2015 11:42:16



Band :	GSM1900	Test Mode :	EDGE class 8 Link (8PSK)
--------	---------	-------------	--------------------------

Lower Band Edge Plot on Channel 512 (1850.2 MHz)

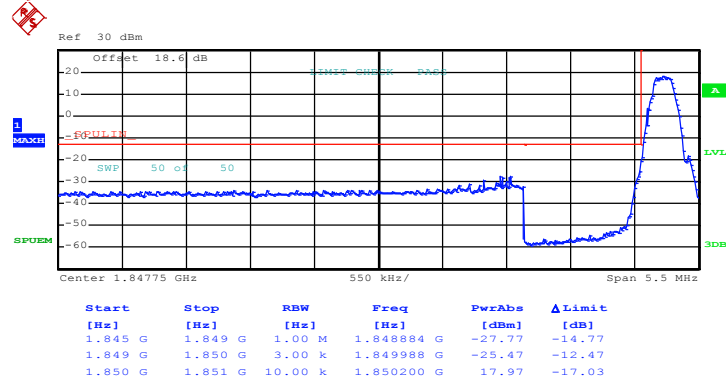

Date: 15.JUL.2015 11:51:40

Higher Band Edge Plot on Channel 810 (1909.8 MHz)

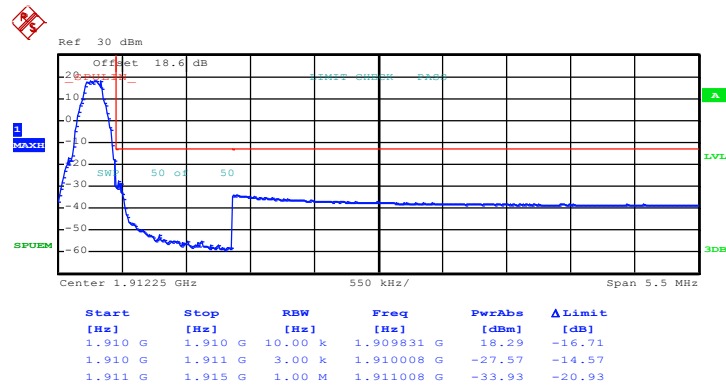

Date: 15.JUL.2015 11:53:03



Band :	WCDMA Band V	Test Mode :	RMC 12.2Kbps Link (QPSK)
--------	--------------	-------------	--------------------------

Lower Band Edge Plot on Channel 4132 (826.4 MHz)

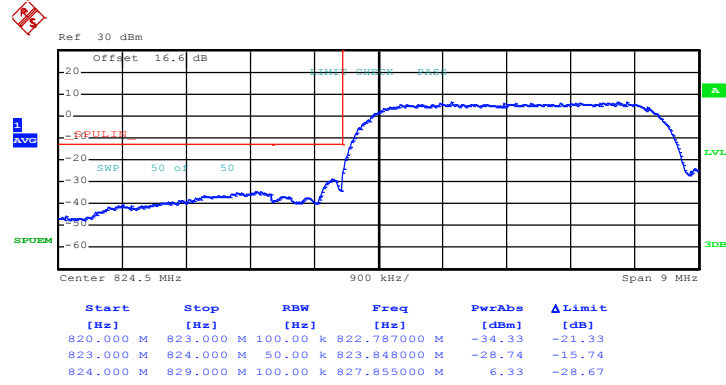

Date: 15.JUL.2015 14:29:16

Higher Band Edge Plot on Channel 4233 (846.6 MHz)

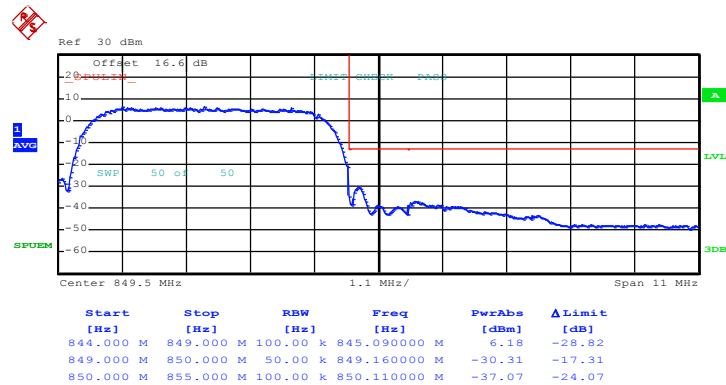

Date: 15.JUL.2015 14:30:39



Band :	WCDMA Band IV	Test Mode :	RMC 12.2Kbps Link (QPSK)
---------------	---------------	--------------------	--------------------------

Lower Band Edge Plot on Channel 1312 (1712.4 MHz)

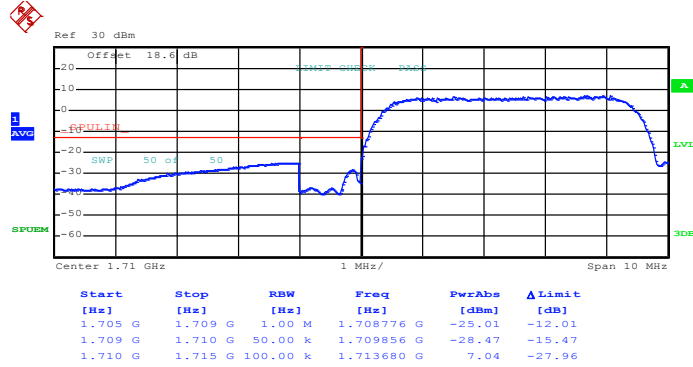

Date: 15.JUL.2015 13:43:10

Higher Band Edge Plot on Channel 1513 (1752.6 MHz)

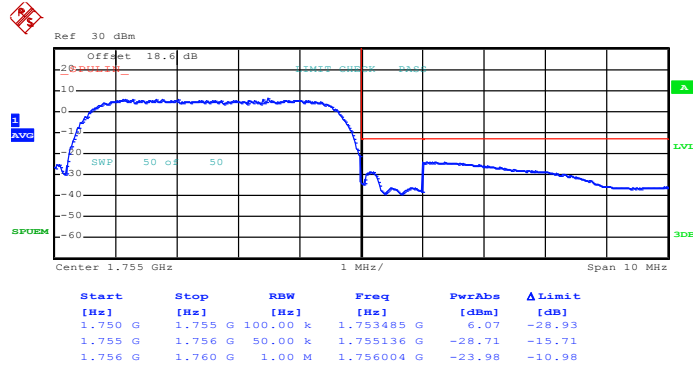

Date: 15.JUL.2015 13:44:32



Band :	WCDMA Band II	Test Mode :	RMC 12.2Kbps Link (QPSK)
--------	---------------	-------------	--------------------------

Lower Band Edge Plot on Channel 9262 (1852.4 MHz)

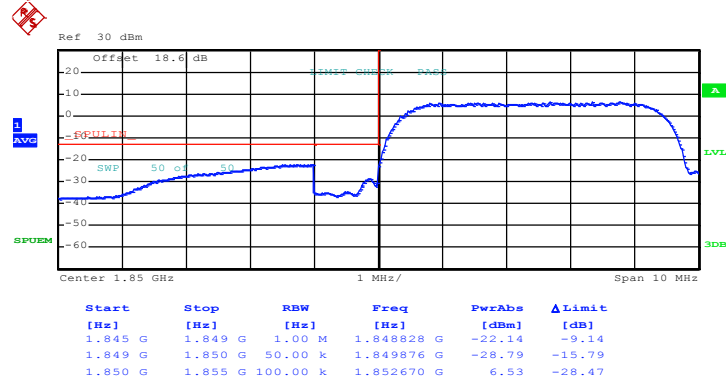

Date: 15.JUL.2015 13:58:44

Higher Band Edge Plot on Channel 9538 (1907.6 MHz)

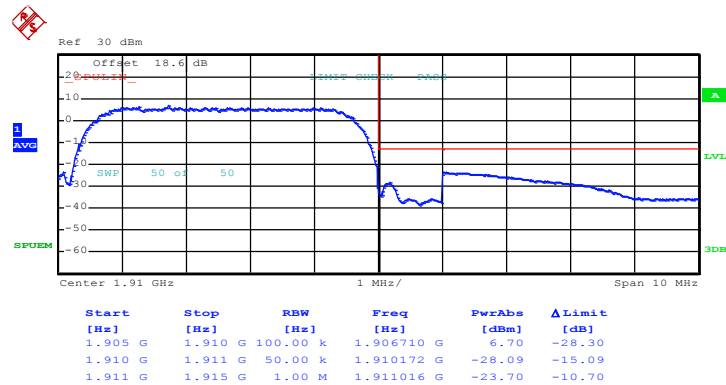

Date: 15.JUL.2015 14:00:06

3.6 Conducted Spurious Emission Measurement

3.6.1 Description of Conducted Spurious Emission Measurement

The power of any emission outside of the authorized operating frequency ranges must be lower than the transmitter power (P) by a factor of at least $43 + 10 \log (P)$ dB.

It is measured by means of a calibrated spectrum analyzer and scanned from 30 MHz up to a frequency including its 10th harmonic.

3.6.2 Measuring Instruments

The measuring equipment is listed in the section 4 of this test report.

3.6.3 Test Procedures

1. The testing follows FCC KDB 971168 v02r02 Section 6.0.
2. The EUT was connected to the spectrum analyzer and system simulator via a power divider.
3. The RF output of EUT was connected to the spectrum analyzer by an RF cable and attenuator. The path loss was compensated to the results for each measurement.
4. The middle channel for the highest RF power within the transmitting frequency was measured.
5. The conducted spurious emission for the whole frequency range was taken.
6. The RF fundamental frequency should be excluded against the limit line in the operating frequency band.
7. The limit line is derived from $43 + 10\log(P)$ dB below the transmitter power P(Watts)
 $= P(W) - [43 + 10\log(P)]$ (dB)
 $= [30 + 10\log(P)]$ (dBm) - $[43 + 10\log(P)]$ (dB)
 $= -13\text{dBm}$.

3.6.4 Test Setup

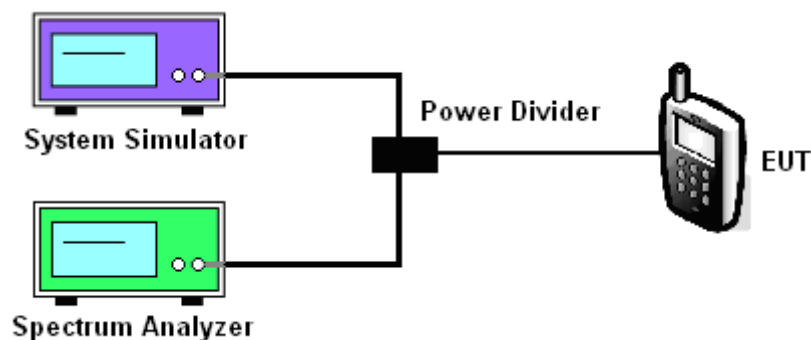



3.6.5 Test Result (Plots) of Conducted Spurious Emission

Band :	GSM850	Channel :	CH128
Test Mode :	GPRS class 8 Link (GMSK)	Frequency :	824.2 MHz

Conducted Spurious Emission Plot between 30MHz ~ 9GHz

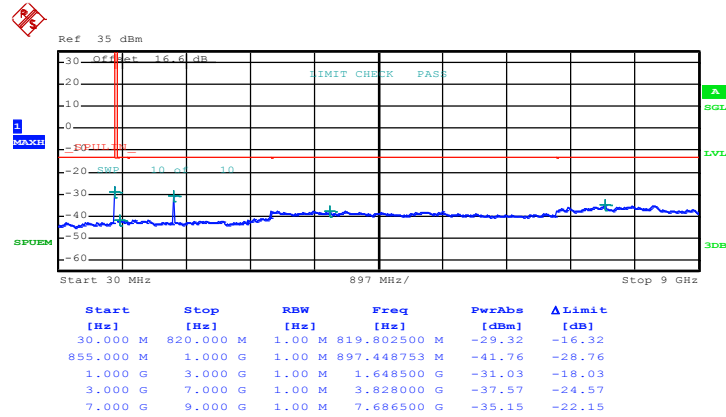

Date: 15.JUL.2015 11:21:04



Band :	GSM850	Channel :	CH189
Test Mode :	GPRS class 8 Link (GMSK)	Frequency :	836.4 MHz

Conducted Spurious Emission Plot between 30MHz ~ 9GHz

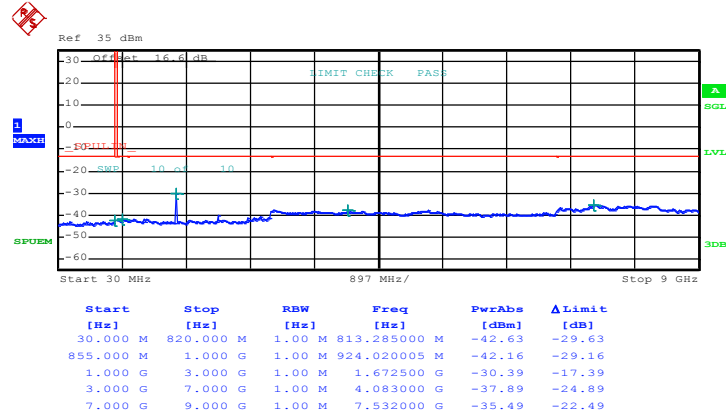

Date: 15.JUL.2015 11:21:29



Band :	GSM850	Channel :	CH251
Test Mode :	GPRS class 8 Link (GMSK)	Frequency :	848.8 MHz

Conducted Spurious Emission Plot between 30MHz ~ 9GHz

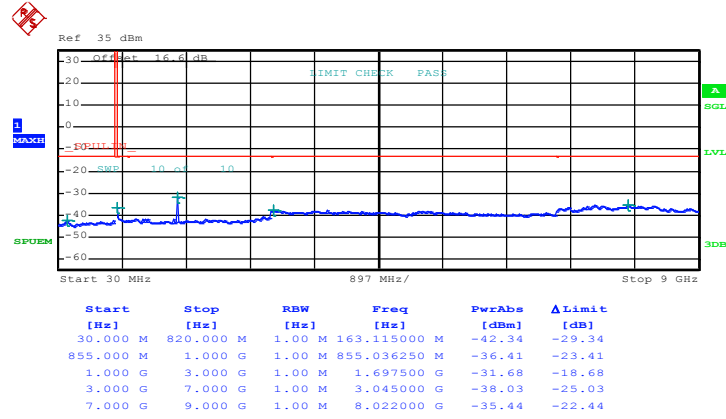

Date: 15.JUL.2015 11:21:54



Band :	GSM850	Channel :	CH128
Test Mode :	EDGE class 8 Link (8PSK)	Frequency :	824.2 MHz

Conducted Spurious Emission Plot between 30MHz ~ 9GHz

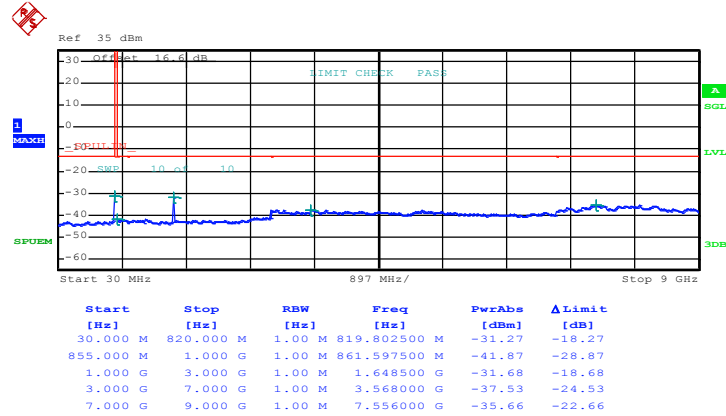

Date: 15.JUL.2015 11:31:01



Band :	GSM850	Channel :	CH189
Test Mode :	EDGE class 8 Link (8PSK)	Frequency :	836.4 MHz

Conducted Spurious Emission Plot between 30MHz ~ 9GHz

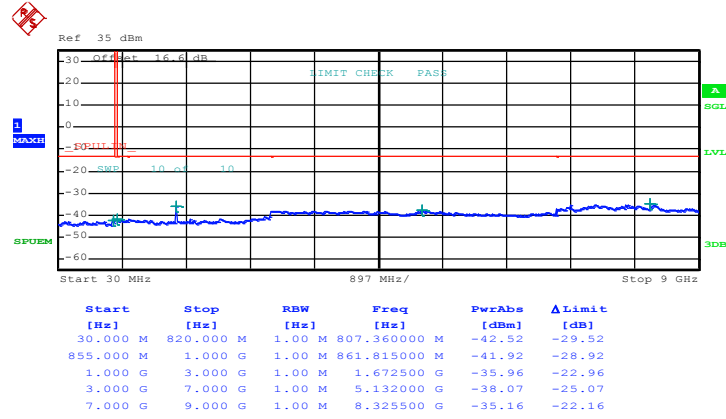

Date: 15.JUL.2015 11:31:26



Band :	GSM850	Channel :	CH251
Test Mode :	EDGE class 8 Link (8PSK)	Frequency :	848.8 MHz

Conducted Spurious Emission Plot between 30MHz ~ 9GHz

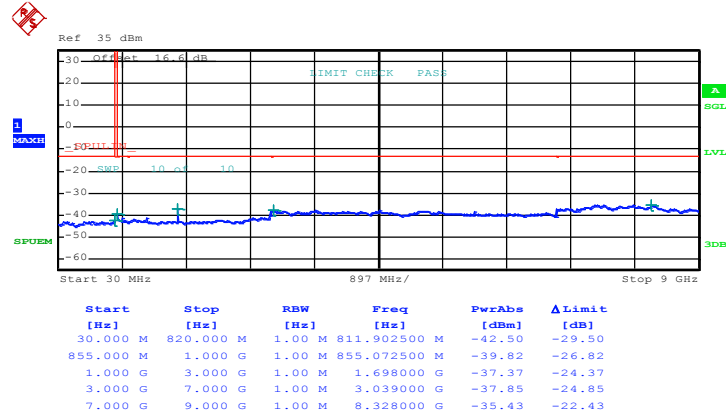

Date: 15.JUL.2015 11:31:51



Band :	GSM1900	Channel :	CH512
Test Mode :	GPRS class 8 Link (GMSK)	Frequency :	1850.2 MHz

Conducted Spurious Emission Plot between 30MHz ~ 19.1GHz

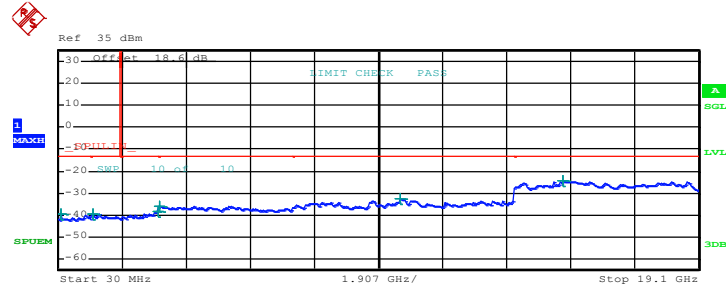

Date: 15.JUL.2015 11:44:29



Band :	GSM1900	Channel :	CH661
Test Mode :	GPRS class 8 Link (GMSK)	Frequency :	1880.0 MHz

Conducted Spurious Emission Plot between 30MHz ~ 19.1GHz

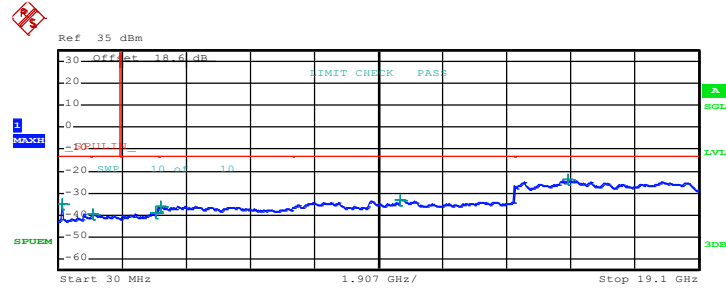

Start [Hz]	Stop [Hz]	RBW [Hz]	Freq [Hz]	PwrAbs [dBm]	Δ Limit [dB]
30.000 M	1.000 G	1.00 M	141.792500 M	-34.90	-21.90
1.000 G	1.845 G	1.00 M	1.067811 G	-39.78	-26.78
1.915 G	3.000 G	1.00 M	2.947106 G	-38.80	-25.80
3.000 G	7.000 G	1.00 M	3.078000 G	-35.91	-22.91
7.000 G	13.600 G	1.00 M	10.223275 G	-33.13	-20.13
13.600 G	19.100 G	1.00 M	15.196375 G	-23.98	-10.98

Date: 15.JUL.2015 11:44:55



Band :	GSM1900	Channel :	CH810
Test Mode :	GPRS class 8 Link (GMSK)	Frequency :	1909.8 MHz

Conducted Spurious Emission Plot between 30MHz ~ 19.1GHz

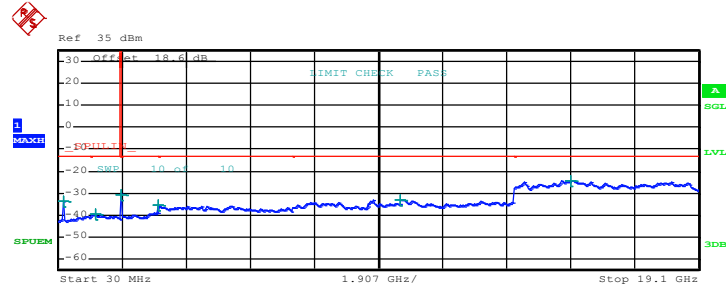

Date: 15.JUL.2015 11:45:20



Band :	GSM1900	Channel :	CH512
Test Mode :	EDGE class 8 Link (8PSK)	Frequency :	1850.2 MHz

Conducted Spurious Emission Plot between 30MHz ~ 19.1GHz

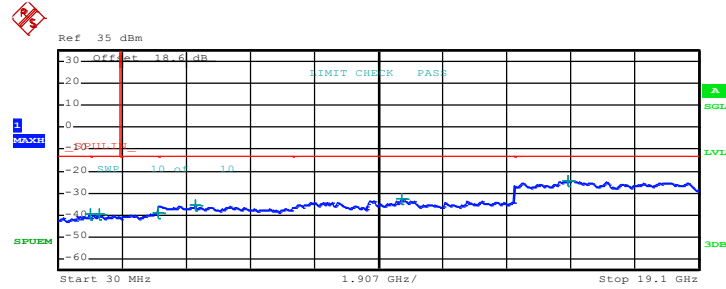

Start [Hz]	Stop [Hz]	RBW [Hz]	Freq [Hz]	PwrAbs [dBm]	ΔLimit [dB]
30.000 M	1.000 G	1.00 M	988.360000 M	-39.56	-26.56
1.000 G	1.845 G	1.00 M	1.247796 G	-39.55	-26.55
1.915 G	3.000 G	1.00 M	2.995931 G	-38.93	-25.93
3.000 G	7.000 G	1.00 M	4.110000 G	-35.71	-22.71
7.000 G	13.600 G	1.00 M	10.234000 G	-32.70	-19.70
13.600 G	19.100 G	1.00 M	15.219063 G	-24.32	-11.32

Date: 15.JUL.2015 11:53:56



Band :	GSM1900	Channel :	CH661
Test Mode :	EDGE class 8 Link (8PSK)	Frequency :	1880.0 MHz

Conducted Spurious Emission Plot between 30MHz ~ 19.1GHz

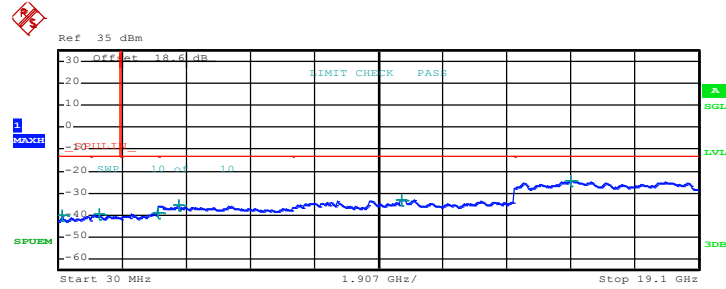

Date: 15.JUL.2015 11:54:22



Band :	GSM1900	Channel :	CH810
Test Mode :	EDGE class 8 Link (8PSK)	Frequency :	1909.8 MHz

Conducted Spurious Emission Plot between 30MHz ~ 19.1GHz

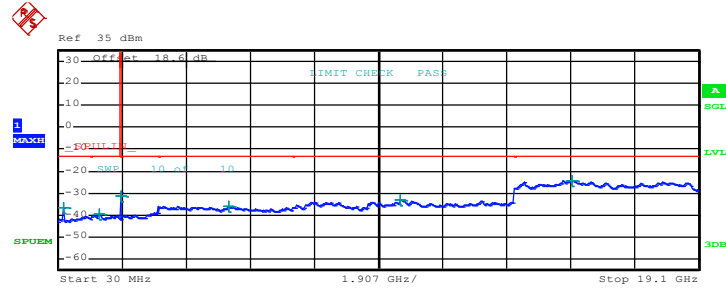

Date: 15.JUL.2015 11:54:48



Band :	WCDMA Band V	Channel :	CH4132
Test Mode :	RMC 12.2Kbps Link (QPSK)	Frequency :	826.4 MHz

Conducted Spurious Emission Plot between 30MHz ~ 9GHz

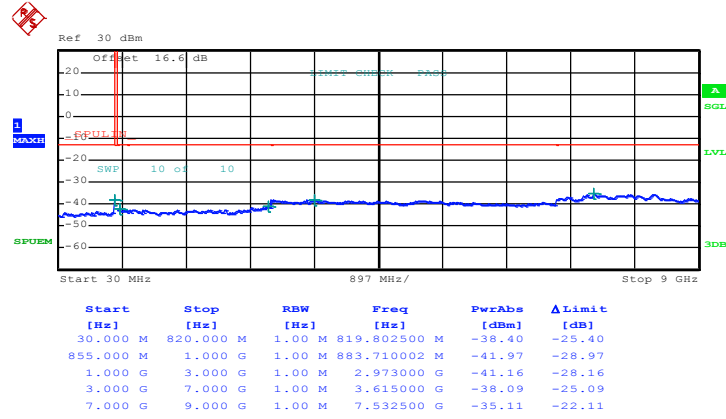

Date: 15.JUL.2015 14:31:27



Band :	WCDMA Band V	Channel :	CH4182
Test Mode :	RMC 12.2Kbps Link (QPSK)	Frequency :	836.4 MHz

Conducted Spurious Emission Plot between 30MHz ~ 9GHz

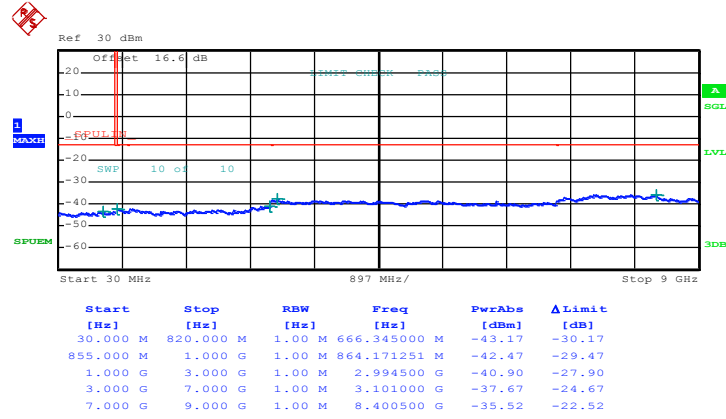

Date: 15.JUL.2015 14:31:52



Band :	WCDMA Band V	Channel :	CH4233
Test Mode :	RMC 12.2Kbps Link (QPSK)	Frequency :	846.6 MHz

Conducted Spurious Emission Plot between 30MHz ~ 9GHz

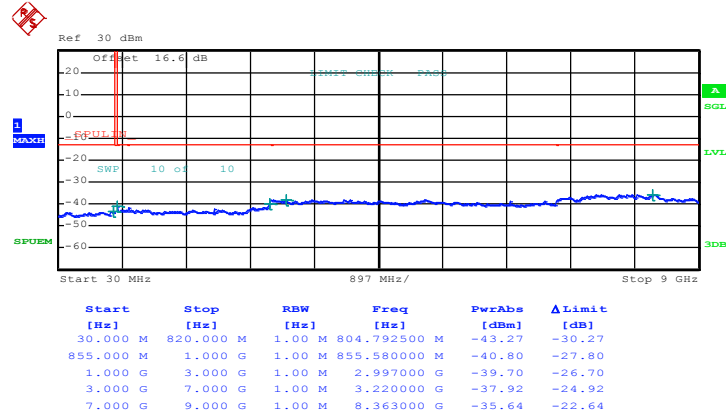

Date: 15.JUL.2015 14:32:16



Band :	WCDMA Band IV	Channel :	CH1312
Test Mode :	RMC 12.2Kbps Link (QPSK)	Frequency :	1712.4 MHz

Conducted Spurious Emission Plot between 30MHz ~ 18GHz

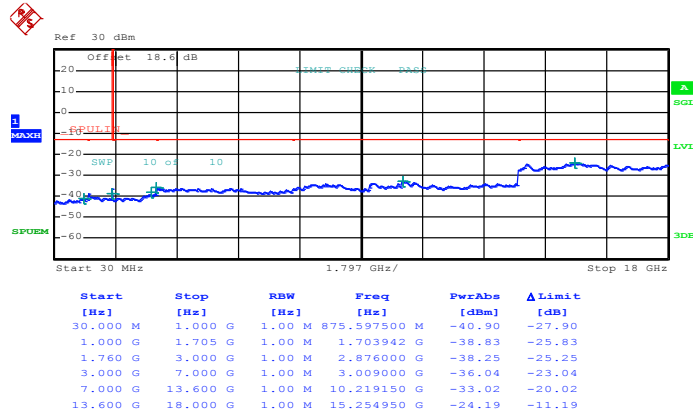

Date: 15.JUL.2015 13:45:02



Band :	WCDMA Band IV	Channel :	CH1413
Test Mode :	RMC 12.2Kbps Link (QPSK)	Frequency :	1732.6 MHz

Conducted Spurious Emission Plot between 30MHz ~ 18GHz

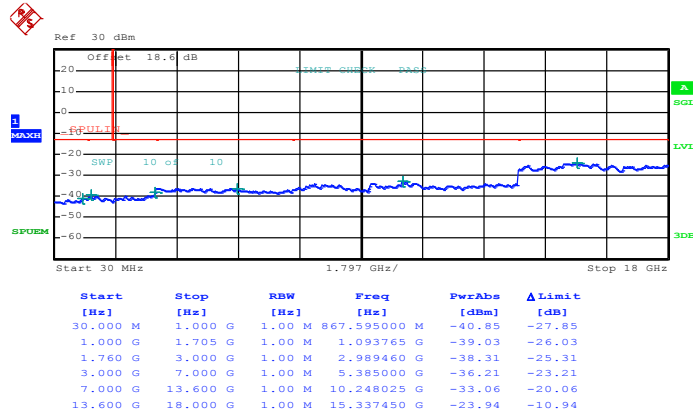

Date: 15.JUL.2015 13:45:27



Band :	WCDMA Band IV	Channel :	CH1513
Test Mode :	RMC 12.2Kbps Link (QPSK)	Frequency :	1752.6 MHz

Conducted Spurious Emission Plot between 30MHz ~ 18GHz

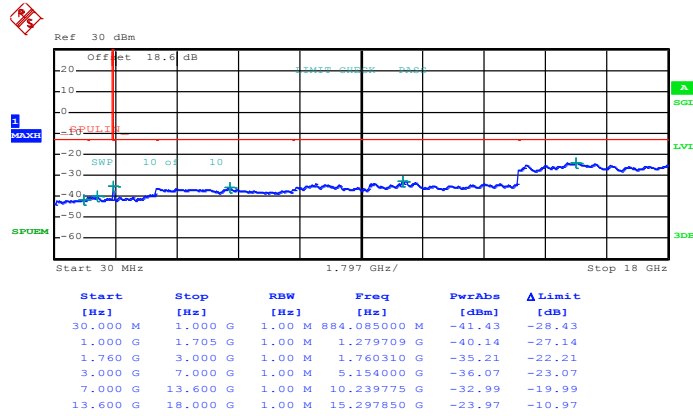

Date: 15.JUL.2015 13:45:52



Band :	WCDMA Band II	Channel :	CH9262
Test Mode :	RMC 12.2Kbps Link (QPSK)	Frequency :	1852.4 MHz

Conducted Spurious Emission Plot between 30MHz ~ 19.1GHz

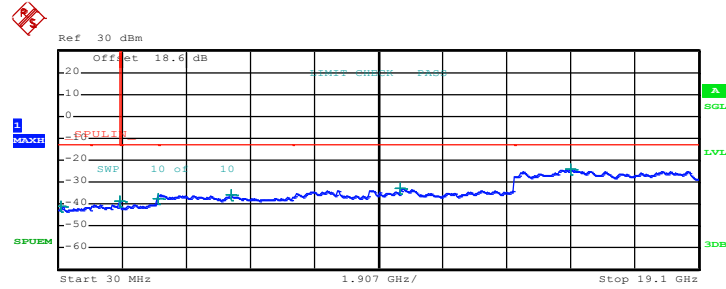

Date: 15.JUL.2015 14:02:03



Band :	WCDMA Band II	Channel :	CH9400
Test Mode :	RMC 12.2Kbps Link (QPSK)	Frequency :	1880.0 MHz

Conducted Spurious Emission Plot between 30MHz ~ 19.1GHz

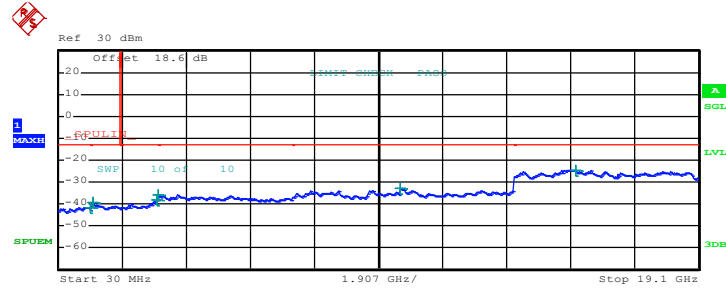

Start [Hz]	Stop [Hz]	RBW [Hz]	Freq [Hz]	PwrAbs [dBm]	ΔLimit [dB]
30.000 M	1.000 G	1.00 M	978.417500 M	-41.56	-28.56
1.000 G	1.845 G	1.00 M	1.076895 G	-39.49	-26.49
1.915 G	3.000 G	1.00 M	2.951989 G	-38.01	-25.01
3.000 G	7.000 G	1.00 M	3.018000 G	-35.92	-22.92
7.000 G	13.600 G	1.00 M	10.211725 G	-32.63	-19.63
13.600 G	19.100 G	1.00 M	15.430813 G	-24.43	-11.43

Date: 15.JUL.2015 14:02:29



Band :	WCDMA Band II	Channel :	CH9538
Test Mode :	RMC 12.2Kbps Link (QPSK)	Frequency :	1907.6 MHz

Conducted Spurious Emission Plot between 30MHz ~ 19.1GHz

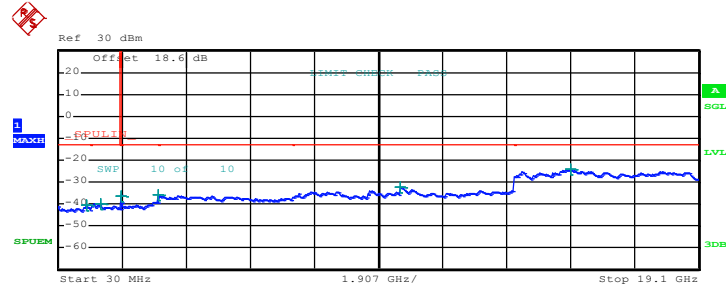

Date: 15.JUL.2015 14:02:54



3.7 Field Strength of Spurious Radiation Measurement

3.7.1 Description of Field Strength of Spurious Radiated Measurement

The power of any emission outside of the authorized operating frequency ranges must be attenuated below the transmitter power (P) by a factor of at least $43 + 10 \log (P)$ dB. The spectrum is scanned from 30 MHz up to a frequency including its 10th harmonic.

3.7.2 Measuring Instruments

The measuring equipment is listed in the section 4 of this test report.

3.7.3 Test Procedures

1. The testing follows FCC KDB 971168 v02r02 Section 5.8 and ANSI / TIA-603-C-2004 Section 2.2.12.
2. The EUT was placed on a rotatable wooden table 0.8 meters above the ground.
3. The EUT was set 3 meters from the receiving antenna, which was mounted on the antenna tower.
4. The table was rotated 360 degrees to determine the position of the highest spurious emission.
5. The height of the receiving antenna is varied between one meter and four meters to search for the maximum spurious emission for both horizontal and vertical polarizations.
6. Make the measurement with the spectrum analyzer's RBW = 1MHz, VBW = 3MHz, taking record of maximum spurious emission.
7. A horn antenna was substituted in place of the EUT and was driven by a signal generator.
8. Tune the output power of signal generator to the same emission level with EUT maximum spurious emission.
9. Taking the record of output power at antenna port.
10. Repeat step 7 to step 8 for another polarization.
11. $EIRP \text{ (dBm)} = S.G. \text{ Power} - Tx \text{ Cable Loss} + Tx \text{ Antenna Gain}$
12. $ERP \text{ (dBm)} = EIRP - 2.15$
13. The RF fundamental frequency should be excluded against the limit line in the operating frequency band.
14. The limit line is derived from $43 + 10\log(P)$ dB below the transmitter power P(Watts)
= $P(W) - [43 + 10\log(P)] \text{ (dB)}$
= $[30 + 10\log(P)] \text{ (dBm)} - [43 + 10\log(P)] \text{ (dB)}$
= -13dBm.

3.7.4 Test Setup

For radiated emissions from 30MHz to 1GHz

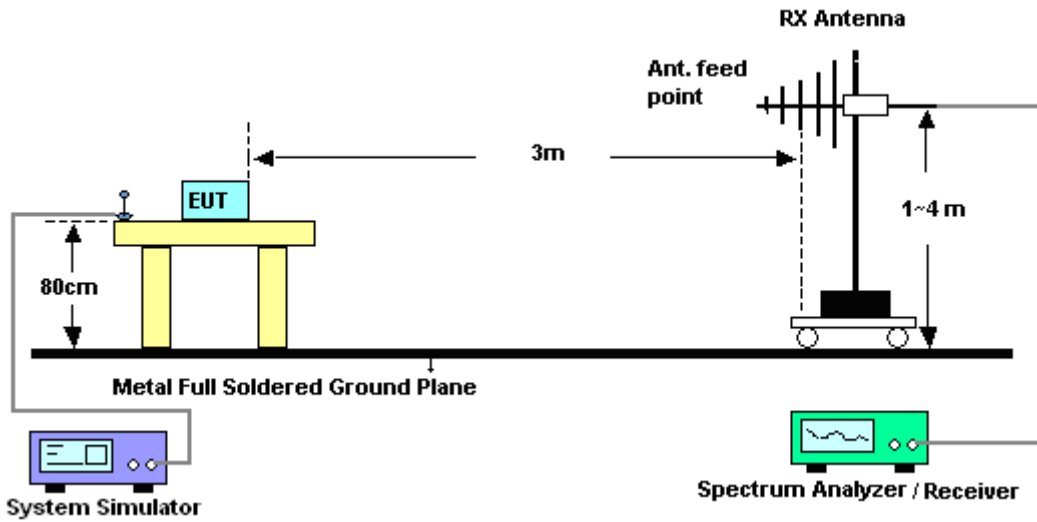

For radiated emissions above 1GHz

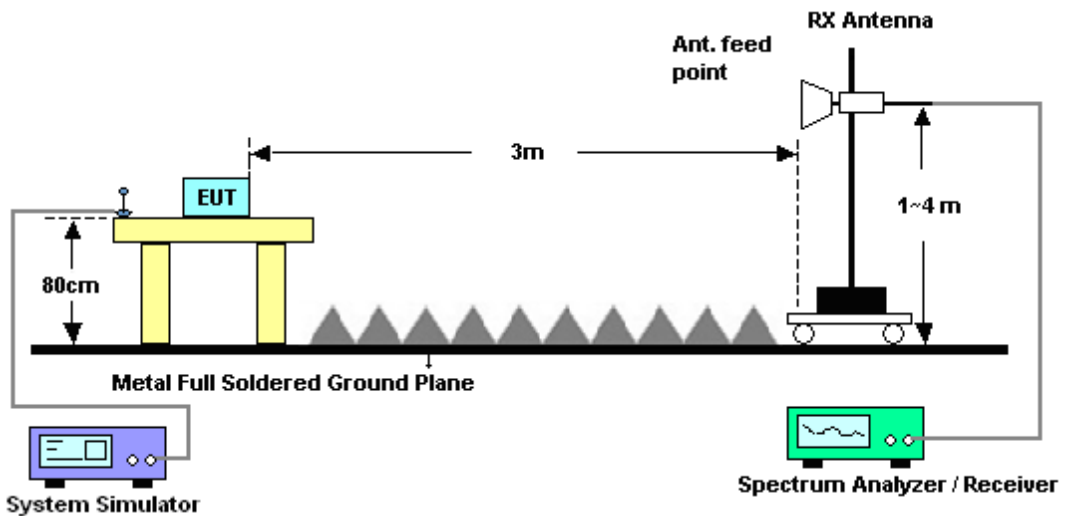



3.7.5 Test Result of Field Strength of Spurious Radiated

<Low Channel>

Band :	GSM850		Temperature :	21~23°C					
Test Mode :	GPRS class 8 Link (GMSK)		Relative Humidity :	41~42%					
Test Engineer :	Stan Hsieh, James Chiu, and Luke Chang		Polarization :	Horizontal					
Remark :	Spurious emissions within 30-1000MHz were found more than 20dB below limit line.								
Frequency (MHz)	ERP (dBm)	Limit (dBm)	Over Limit (dB)	SPA Reading (dBm)	S.G. Power (dBm)	TX Cable loss (dB)	TX Antenna Gain (dBi)	Polarization (H/V)	Result
1651	-62.54	-13	-49.54	-72.21	-64.29	0.98	4.88	H	Pass
2476	-46.33	-13	-33.33	-59.4	-48.22	1.28	5.33	H	Pass
3298	-60.39	-13	-47.39	-76.98	-63.81	1.54	7.11	H	Pass

Band :	GSM850		Temperature :	21~23°C					
Test Mode :	GPRS class 8 Link (GMSK)		Relative Humidity :	41~42%					
Test Engineer :	Stan Hsieh, James Chiu, and Luke Chang		Polarization :	Vertical					
Remark :	Spurious emissions within 30-1000MHz were found more than 20dB below limit line.								
Frequency (MHz)	ERP (dBm)	Limit (dBm)	Over Limit (dB)	SPA Reading (dBm)	S.G. Power (dBm)	TX Cable loss (dB)	TX Antenna Gain (dBi)	Polarization (H/V)	Result
1651	-59.95	-13	-46.95	-67.6	-61.7	0.98	4.88	V	Pass
2476	-44.11	-13	-31.11	-59.38	-46	1.28	5.33	V	Pass
3298	-59.91	-13	-46.91	-75.38	-63.33	1.54	7.11	V	Pass



<Middle Channel>

Band :	GSM850						Temperature :	21~23°C	
Test Mode :	GPRS class 8 Link (GMSK)						Relative Humidity :	41~42%	
Test Engineer :	Stan Hsieh, James Chiu, and Luke Chang						Polarization :	Horizontal	
Remark :	Spurious emissions within 30-1000MHz were found more than 20dB below limit line.								
Frequency (MHz)	ERP (dBm)	Limit (dBm)	Over Limit (dB)	SPA Reading (dBm)	S.G. Power (dBm)	TX Cable loss (dB)	TX Antenna Gain (dBi)	Polarization (H/V)	Result
1675	-61.75	-13	-48.75	-71.14	-63.42	0.99	4.81	H	Pass
2512	-42.93	-13	-29.93	-56.26	-44.9	1.29	5.41	H	Pass
3346	-60.68	-13	-47.68	-76.93	-64.3	1.56	7.32	H	Pass

Band :	GSM850						Temperature :	21~23°C	
Test Mode :	GPRS class 8 Link (GMSK)						Relative Humidity :	41~42%	
Test Engineer :	Stan Hsieh, James Chiu, and Luke Chang						Polarization :	Vertical	
Remark :	Spurious emissions within 30-1000MHz were found more than 20dB below limit line.								
Frequency (MHz)	ERP (dBm)	Limit (dBm)	Over Limit (dB)	SPA Reading (dBm)	S.G. Power (dBm)	TX Cable loss (dB)	TX Antenna Gain (dBi)	Polarization (H/V)	Result
1675	-60.26	-13	-47.26	-67.47	-61.93	0.99	4.81	V	Pass
2512	-40.84	-13	-27.84	-56.25	-42.81	1.29	5.41	V	Pass
3346	-60.38	-13	-47.38	-75.62	-64	1.56	7.32	V	Pass



<High Channel>

Band :	GSM850					Temperature :	21~23°C		
Test Mode :	GPRS class 8 Link (GMSK)					Relative Humidity :	41~42%		
Test Engineer :	Stan Hsieh, James Chiu, and Luke Chang					Polarization :	Horizontal		
Remark :	Spurious emissions within 30-1000MHz were found more than 20dB below limit line.								
Frequency (MHz)	ERP (dBm)	Limit (dBm)	Over Limit (dB)	SPA Reading (dBm)	S.G. Power (dBm)	TX Cable loss (dB)	TX Antenna Gain (dBi)	Polarization (H/V)	Result
1698	-62.02	-13	-49.02	-71.53	-63.62	1.00	4.75	H	Pass
2548	-43.37	-13	-30.37	-57.12	-45.35	1.31	5.44	H	Pass
3394	-60.62	-13	-47.62	-77.1	-64.43	1.57	7.53	H	Pass

Band :	GSM850					Temperature :	21~23°C		
Test Mode :	GPRS class 8 Link (GMSK)					Relative Humidity :	41~42%		
Test Engineer :	Stan Hsieh, James Chiu, and Luke Chang					Polarization :	Vertical		
Remark :	Spurious emissions within 30-1000MHz were found more than 20dB below limit line.								
Frequency (MHz)	ERP (dBm)	Limit (dBm)	Over Limit (dB)	SPA Reading (dBm)	S.G. Power (dBm)	TX Cable loss (dB)	TX Antenna Gain (dBi)	Polarization (H/V)	Result
1698	-62.43	-13	-49.43	-70.21	-64.03	1.00	4.75	V	Pass
2548	-40.22	-13	-27.22	-55.63	-42.2	1.31	5.44	V	Pass
3394	-61.21	-13	-48.21	-77.11	-65.02	1.57	7.53	V	Pass



<Low Channel>

Band :	GSM850						Temperature :	21~23°C	
Test Mode :	EDGE class 8 Link (8PSK)						Relative Humidity :	41~42%	
Test Engineer :	Stan Hsieh, James Chiu, and Luke Chang						Polarization :	Horizontal	
Remark :	Spurious emissions within 30-1000MHz were found more than 20dB below limit line.								
Frequency (MHz)	ERP (dBm)	Limit (dBm)	Over Limit (dB)	SPA Reading (dBm)	S.G. Power (dBm)	TX Cable loss (dB)	TX Antenna Gain (dBi)	Polarization (H/V)	Result
1651	-61.60	-13	-48.60	-71.24	-63.35	0.98	4.88	H	Pass
2476	-55.88	-13	-42.88	-68.95	-57.77	1.28	5.33	H	Pass
3298	-60.41	-13	-47.41	-76.98	-63.83	1.54	7.11	H	Pass

Band :	GSM850						Temperature :	21~23°C	
Test Mode :	EDGE class 8 Link (8PSK)						Relative Humidity :	41~42%	
Test Engineer :	Stan Hsieh, James Chiu, and Luke Chang						Polarization :	Vertical	
Remark :	Spurious emissions within 30-1000MHz were found more than 20dB below limit line.								
Frequency (MHz)	ERP (dBm)	Limit (dBm)	Over Limit (dB)	SPA Reading (dBm)	S.G. Power (dBm)	TX Cable loss (dB)	TX Antenna Gain (dBi)	Polarization (H/V)	Result
1651	-62.20	-13	-49.20	-69.85	-63.95	0.98	4.88	V	Pass
2476	-53.65	-13	-40.65	-68.91	-55.54	1.28	5.33	V	Pass
3298	-61.38	-13	-48.38	-76.85	-64.8	1.54	7.11	V	Pass



<Middle Channel>

Band :	GSM850						Temperature :	21~23°C		
Test Mode :	EDGE class 8 Link (8PSK)						Relative Humidity :	41~42%		
Test Engineer :	Stan Hsieh, James Chiu, and Luke Chang						Polarization :	Horizontal		
Remark :	Spurious emissions within 30-1000MHz were found more than 20dB below limit line.									
Frequency (MHz)	ERP (dBm)	Limit (dBm)	Over Limit (dB)	SPA Reading (dBm)	S.G. Power (dBm)	TX Cable loss (dB)	TX Antenna Gain (dBi)	Polarization (H/V)	Result	
1675	-63.04	-13	-50.04	-72.41	-64.71	0.99	4.81	H	Pass	
2512	-55.63	-13	-42.63	-68.93	-57.6	1.29	5.41	H	Pass	
3346	-60.58	-13	-47.58	-76.82	-64.2	1.56	7.32	H	Pass	

Band :	GSM850						Temperature :	21~23°C		
Test Mode :	EDGE class 8 Link (8PSK)						Relative Humidity :	41~42%		
Test Engineer :	Stan Hsieh, James Chiu, and Luke Chang						Polarization :	Vertical		
Remark :	Spurious emissions within 30-1000MHz were found more than 20dB below limit line.									
Frequency (MHz)	ERP (dBm)	Limit (dBm)	Over Limit (dB)	SPA Reading (dBm)	S.G. Power (dBm)	TX Cable loss (dB)	TX Antenna Gain (dBi)	Polarization (H/V)	Result	
1675	-64.07	-13	-51.07	-71.27	-65.74	0.99	4.81	V	Pass	
2512	-50.05	-13	-37.05	-65.44	-52.02	1.29	5.41	V	Pass	
3346	-60.43	-13	-47.43	-75.71	-64.05	1.56	7.32	V	Pass	



<High Channel>

Band :	GSM850						Temperature :	21~23°C	
Test Mode :	EDGE class 8 Link (8PSK)						Relative Humidity :	41~42%	
Test Engineer :	Stan Hsieh, James Chiu, and Luke Chang						Polarization :	Horizontal	
Remark :	Spurious emissions within 30-1000MHz were found more than 20dB below limit line.								
Frequency (MHz)	ERP (dBm)	Limit (dBm)	Over Limit (dB)	SPA Reading (dBm)	S.G. Power (dBm)	TX Cable loss (dB)	TX Antenna Gain (dBi)	Polarization (H/V)	Result
1698	-64.00	-13	-51.00	-73.49	-65.6	1.00	4.75	H	Pass
2548	-49.78	-13	-36.78	-63.54	-51.76	1.31	5.44	H	Pass
3394	-60.64	-13	-47.64	-77.1	-64.45	1.57	7.53	H	Pass

Band :	GSM850						Temperature :	21~23°C	
Test Mode :	EDGE class 8 Link (8PSK)						Relative Humidity :	41~42%	
Test Engineer :	Stan Hsieh, James Chiu, and Luke Chang						Polarization :	Vertical	
Remark :	Spurious emissions within 30-1000MHz were found more than 20dB below limit line.								
Frequency (MHz)	ERP (dBm)	Limit (dBm)	Over Limit (dB)	SPA Reading (dBm)	S.G. Power (dBm)	TX Cable loss (dB)	TX Antenna Gain (dBi)	Polarization (H/V)	Result
1698	-64.93	-13	-51.93	-72.72	-66.53	1.00	4.75	V	Pass
2548	-47.32	-13	-34.32	-62.73	-51.45	1.31	5.44	V	Pass
3394	-61.08	-13	-48.08	-76.96	-67.04	1.57	7.53	V	Pass



<Low Channel>

Band :	WCDMA Band V				Temperature :	21~23°C			
Test Mode :	RMC 12.2Kbps Link (QPSK)				Relative Humidity :	41~42%			
Test Engineer :	Stan Hsieh, James Chiu, and Luke Chang				Polarization :	Horizontal			
Remark :	Spurious emissions within 30-1000MHz were found more than 20dB below limit line.								
Frequency (MHz)	ERP (dBm)	Limit (dBm)	Over Limit (dB)	SPA Reading (dBm)	S.G. Power (dBm)	TX Cable loss (dB)	TX Antenna Gain (dBi)	Polarization (H/V)	Result
1653	-63.06	-13	-50.06	-72.71	-64.8	0.98	4.87	H	Pass
2480	-61.52	-13	-48.52	-74.61	-63.43	1.28	5.34	H	Pass
3306	-59.55	-13	-46.55	-76.02	-63	1.54	7.15	H	Pass

Band :	WCDMA Band V				Temperature :	21~23°C			
Test Mode :	RMC 12.2Kbps Link (QPSK)				Relative Humidity :	41~42%			
Test Engineer :	Stan Hsieh, James Chiu, and Luke Chang				Polarization :	Vertical			
Remark :	Spurious emissions within 30-1000MHz were found more than 20dB below limit line.								
Frequency (MHz)	ERP (dBm)	Limit (dBm)	Over Limit (dB)	SPA Reading (dBm)	S.G. Power (dBm)	TX Cable loss (dB)	TX Antenna Gain (dBi)	Polarization (H/V)	Result
1653	-59.77	-13	-46.77	-67.41	-61.51	0.98	4.87	V	Pass
2480	-57.43	-13	-44.43	-72.69	-59.34	1.28	5.34	V	Pass
3306	-61.56	-13	-48.56	-76.94	-65.01	1.54	7.15	V	Pass



<Middle Channel>

Band :	WCDMA Band V				Temperature :	21~23°C			
Test Mode :	RMC 12.2Kbps Link (QPSK)				Relative Humidity :	41~42%			
Test Engineer :	Stan Hsieh, James Chiu, and Luke Chang				Polarization :	Horizontal			
Remark :	Spurious emissions within 30-1000MHz were found more than 20dB below limit line.								
Frequency (MHz)	ERP (dBm)	Limit (dBm)	Over Limit (dB)	SPA Reading (dBm)	S.G. Power (dBm)	TX Cable loss (dB)	TX Antenna Gain (dBi)	Polarization (H/V)	Result
1672	-62.77	-13	-49.77	-72.13	-64.45	0.99	4.82	H	Pass
2509	-61.84	-13	-48.84	-75.16	-63.8	1.29	5.41	H	Pass
3346	-59.41	-13	-46.41	-75.65	-63.03	1.56	7.32	H	Pass

Band :	WCDMA Band V				Temperature :	21~23°C			
Test Mode :	RMC 12.2Kbps Link (QPSK)				Relative Humidity :	41~42%			
Test Engineer :	Stan Hsieh, James Chiu, and Luke Chang				Polarization :	Vertical			
Remark :	Spurious emissions within 30-1000MHz were found more than 20dB below limit line.								
Frequency (MHz)	ERP (dBm)	Limit (dBm)	Over Limit (dB)	SPA Reading (dBm)	S.G. Power (dBm)	TX Cable loss (dB)	TX Antenna Gain (dBi)	Polarization (H/V)	Result
1672	-59.63	-13	-46.63	-66.84	-61.31	0.99	4.82	V	Pass
2509	-58.94	-13	-45.94	-74.32	-60.9	1.29	5.41	V	Pass
3346	-60.53	-13	-47.53	-75.82	-64.15	1.56	7.32	V	Pass



<High Channel>

Band :	WCDMA Band V						Temperature :	21~23°C	
Test Mode :	RMC 12.2Kbps Link (QPSK)						Relative Humidity :	41~42%	
Test Engineer :	Stan Hsieh, James Chiu, and Luke Chang						Polarization :	Horizontal	
Remark :	Spurious emissions within 30-1000MHz were found more than 20dB below limit line.								
Frequency (MHz)	ERP (dBm)	Limit (dBm)	Over Limit (dB)	SPA Reading (dBm)	S.G. Power (dBm)	TX Cable loss (dB)	TX Antenna Gain (dBi)	Polarization (H/V)	Result
1694	-61.59	-13	-48.59	-71.09	-63.2	1.00	4.76	H	Pass
2540	-59.25	-13	-46.25	-73	-61.23	1.30	5.43	H	Pass
3388	-57.66	-13	-44.66	-74.05	-61.45	1.57	7.51	H	Pass

Band :	WCDMA Band V						Temperature :	21~23°C	
Test Mode :	RMC 12.2Kbps Link (QPSK)						Relative Humidity :	41~42%	
Test Engineer :	Stan Hsieh, James Chiu, and Luke Chang						Polarization :	Vertical	
Remark :	Spurious emissions within 30-1000MHz were found more than 20dB below limit line.								
Frequency (MHz)	ERP (dBm)	Limit (dBm)	Over Limit (dB)	SPA Reading (dBm)	S.G. Power (dBm)	TX Cable loss (dB)	TX Antenna Gain (dBi)	Polarization (H/V)	Result
1694	-58.79	-13	-45.79	-66.57	-60.4	1.00	4.76	V	Pass
2540	-57.66	-13	-44.66	-73.07	-59.64	1.30	5.43	V	Pass
3388	-59.46	-13	-46.46	-75.13	-63.25	1.57	7.51	V	Pass



<Low Channel>

Band :	GSM1900				Temperature :	21~23°C			
Test Mode :	GPRS class 8 Link (GMSK)				Relative Humidity :	41~42%			
Test Engineer :	Stan Hsieh, James Chiu, and Luke Chang				Polarization :	Horizontal			
Remark :	Spurious emissions within 30-1000MHz were found more than 20dB below limit line.								
Frequency (MHz)	EIRP (dBm)	Limit (dBm)	Over Limit (dB)	SPA Reading (dBm)	S.G. Power (dBm)	TX Cable loss (dB)	TX Antenna Gain (dBi)	Polarization (H/V)	Result
3704	-47.24	-13	-34.24	-65.93	-53.82	1.67	8.24	H	Pass
5556	-50.27	-13	-37.27	-73.96	-57.34	2.66	9.72	H	Pass
7404	-47.17	-13	-34.17	-76.04	-56.32	2.46	11.61	H	Pass

Band :	GSM1900				Temperature :	21~23°C			
Test Mode :	GPRS class 8 Link (GMSK)				Relative Humidity :	41~42%			
Test Engineer :	Stan Hsieh, James Chiu, and Luke Chang				Polarization :	Vertical			
Remark :	Spurious emissions within 30-1000MHz were found more than 20dB below limit line.								
Frequency (MHz)	EIRP (dBm)	Limit (dBm)	Over Limit (dB)	SPA Reading (dBm)	S.G. Power (dBm)	TX Cable loss (dB)	TX Antenna Gain (dBi)	Polarization (H/V)	Result
3704	-45.47	-13	-32.47	-64.06	-52.05	1.67	8.24	V	Pass
5556	-53.22	-13	-40.22	-75.39	-60.29	2.66	9.72	V	Pass
7404	-48.15	-13	-35.15	-76.2	-57.3	2.46	11.61	V	Pass



<Middle Channel>

Band :	GSM1900		Temperature :	21~23°C					
Test Mode :	GPRS class 8 Link (GMSK)		Relative Humidity :	41~42%					
Test Engineer :	Stan Hsieh, James Chiu, and Luke Chang		Polarization :	Horizontal					
Remark :	Spurious emissions within 30-1000MHz were found more than 20dB below limit line.								
Frequency (MHz)	EIRP (dBm)	Limit (dBm)	Over Limit (dB)	SPA Reading (dBm)	S.G. Power (dBm)	TX Cable loss (dB)	TX Antenna Gain (dBi)	Polarization (H/V)	Result
3764	-46.93	-13	-33.93	-66.09	-53.56	1.69	8.32	H	Pass
5644	-47.69	-13	-34.69	-71.45	-54.74	2.71	9.76	H	Pass
7520	-47.31	-13	-34.31	-75.96	-56.7	2.42	11.81	H	Pass

Band :	GSM1900		Temperature :	21~23°C					
Test Mode :	GPRS class 8 Link (GMSK)		Relative Humidity :	41~42%					
Test Engineer :	Stan Hsieh, James Chiu, and Luke Chang		Polarization :	Vertical					
Remark :	Spurious emissions within 30-1000MHz were found more than 20dB below limit line.								
Frequency (MHz)	EIRP (dBm)	Limit (dBm)	Over Limit (dB)	SPA Reading (dBm)	S.G. Power (dBm)	TX Cable loss (dB)	TX Antenna Gain (dBi)	Polarization (H/V)	Result
3764	-43.51	-13	-30.51	-62.15	-50.14	1.69	8.32	V	Pass
5644	-50.21	-13	-37.21	-72.53	-57.26	2.71	9.76	V	Pass
7520	-49.61	-13	-36.61	-77.88	-59	2.42	11.81	V	Pass



<High Channel>

Band :	GSM1900					Temperature :	21~23°C		
Test Mode :	GPRS class 8 Link (GMSK)					Relative Humidity :	41~42%		
Test Engineer :	Stan Hsieh, James Chiu, and Luke Chang					Polarization :	Horizontal		
Remark :	Spurious emissions within 30-1000MHz were found more than 20dB below limit line.								
Frequency (MHz)	EIRP (dBm)	Limit (dBm)	Over Limit (dB)	SPA Reading (dBm)	S.G. Power (dBm)	TX Cable loss (dB)	TX Antenna Gain (dBi)	Polarization (H/V)	Result
3824	-48.49	-13	-35.49	-68.11	-55.17	1.71	8.39	H	Pass
5732	-43.48	-13	-30.48	-67.61	-50.51	2.76	9.79	H	Pass
7640	-49.36	-13	-36.36	-77.79	-58.86	2.38	11.88	H	Pass

Band :	GSM1900					Temperature :	21~23°C		
Test Mode :	GPRS class 8 Link (GMSK)					Relative Humidity :	41~42%		
Test Engineer :	Stan Hsieh, James Chiu, and Luke Chang					Polarization :	Vertical		
Remark :	Spurious emissions within 30-1000MHz were found more than 20dB below limit line.								
Frequency (MHz)	EIRP (dBm)	Limit (dBm)	Over Limit (dB)	SPA Reading (dBm)	S.G. Power (dBm)	TX Cable loss (dB)	TX Antenna Gain (dBi)	Polarization (H/V)	Result
3824	-50.11	-13	-37.11	-68.83	-56.79	1.71	8.39	V	Pass
5732	-45.65	-13	-32.65	-68.82	-52.68	2.76	9.79	V	Pass
7640	-49.85	-13	-36.85	-77.83	-59.35	2.38	11.88	V	Pass



<Low Channel>

Band :	GSM1900						Temperature :	21~23°C	
Test Mode :	EDGE class 8 Link (8PSK)						Relative Humidity :	41~42%	
Test Engineer :	Stan Hsieh, James Chiu, and Luke Chang						Polarization :	Horizontal	
Remark :	Spurious emissions within 30-1000MHz were found more than 20dB below limit line.								
Frequency (MHz)	EIRP (dBm)	Limit (dBm)	Over Limit (dB)	SPA Reading (dBm)	S.G. Power (dBm)	TX Cable loss (dB)	TX Antenna Gain (dBi)	Polarization (H/V)	Result
3704	-53.82	-13	-40.82	-72.47	-60.4	1.67	8.24	H	Pass
5550	-54.45	-13	-41.45	-78.14	-61.52	2.65	9.72	H	Pass
7401	-47.81	-13	-34.81	-76.69	-56.95	2.46	11.60	H	Pass

Band :	GSM1900						Temperature :	21~23°C	
Test Mode :	EDGE class 8 Link (8PSK)						Relative Humidity :	41~42%	
Test Engineer :	Stan Hsieh, James Chiu, and Luke Chang						Polarization :	Vertical	
Remark :	Spurious emissions within 30-1000MHz were found more than 20dB below limit line.								
Frequency (MHz)	EIRP (dBm)	Limit (dBm)	Over Limit (dB)	SPA Reading (dBm)	S.G. Power (dBm)	TX Cable loss (dB)	TX Antenna Gain (dBi)	Polarization (H/V)	Result
3704	-52.02	-13	-39.02	-70.59	-58.6	1.67	8.24	V	Pass
5550	-54.58	-13	-41.58	-76.74	-61.65	2.65	9.72	V	Pass
7401	-49.69	-13	-36.69	-77.76	-58.83	2.46	11.60	V	Pass



<Middle Channel>

Band :	GSM1900		Temperature :	21~23°C					
Test Mode :	EDGE class 8 Link (8PSK)		Relative Humidity :	41~42%					
Test Engineer :	Stan Hsieh, James Chiu, and Luke Chang		Polarization :	Horizontal					
Remark :	Spurious emissions within 30-1000MHz were found more than 20dB below limit line.								
Frequency (MHz)	EIRP (dBm)	Limit (dBm)	Over Limit (dB)	SPA Reading (dBm)	S.G. Power (dBm)	TX Cable loss (dB)	TX Antenna Gain (dBi)	Polarization (H/V)	Result
3764	-54.99	-13	-41.99	-74.17	-61.62	1.69	8.32	H	Pass
5640	-51.97	-13	-38.97	-75.72	-59.02	2.71	9.76	H	Pass
7520	-49.21	-13	-36.21	-77.88	-58.6	2.42	11.81	H	Pass

Band :	GSM1900		Temperature :	21~23°C					
Test Mode :	EDGE class 8 Link (8PSK)		Relative Humidity :	41~42%					
Test Engineer :	Stan Hsieh, James Chiu, and Luke Chang		Polarization :	Vertical					
Remark :	Spurious emissions within 30-1000MHz were found more than 20dB below limit line.								
Frequency (MHz)	EIRP (dBm)	Limit (dBm)	Over Limit (dB)	SPA Reading (dBm)	S.G. Power (dBm)	TX Cable loss (dB)	TX Antenna Gain (dBi)	Polarization (H/V)	Result
3764	-52.37	-13	-39.37	-71	-59	1.69	8.32	V	Pass
5640	-53.97	-13	-40.97	-76.27	-61.02	2.71	9.76	V	Pass
7520	-49.62	-13	-36.62	-77.9	-59.01	2.42	11.81	V	Pass



<High Channel>

Band :	GSM1900		Temperature :	21~23°C					
Test Mode :	EDGE class 8 Link (8PSK)		Relative Humidity :	41~42%					
Test Engineer :	Stan Hsieh, James Chiu, and Luke Chang		Polarization :	Horizontal					
Remark :	Spurious emissions within 30-1000MHz were found more than 20dB below limit line.								
Frequency (MHz)	EIRP (dBm)	Limit (dBm)	Over Limit (dB)	SPA Reading (dBm)	S.G. Power (dBm)	TX Cable loss (dB)	TX Antenna Gain (dBi)	Polarization (H/V)	Result
3824	-53.92	-13	-40.92	-73.52	-60.6	1.71	8.39	H	Pass
5730	-51.34	-13	-38.34	-75.49	-58.37	2.76	9.79	H	Pass
7640	-48.91	-13	-35.91	-77.34	-58.41	2.38	11.88	H	Pass

Band :	GSM1900		Temperature :	21~23°C					
Test Mode :	EDGE class 8 Link (8PSK)		Relative Humidity :	41~42%					
Test Engineer :	Stan Hsieh, James Chiu, and Luke Chang		Polarization :	Vertical					
Remark :	Spurious emissions within 30-1000MHz were found more than 20dB below limit line.								
Frequency (MHz)	EIRP (dBm)	Limit (dBm)	Over Limit (dB)	SPA Reading (dBm)	S.G. Power (dBm)	TX Cable loss (dB)	TX Antenna Gain (dBi)	Polarization (H/V)	Result
3824	-52.47	-13	-39.47	-71.2	-59.15	1.71	8.39	V	Pass
5730	-52.83	-13	-39.83	-76	-59.86	2.76	9.79	V	Pass
7640	-49.50	-13	-36.50	-77.46	-59	2.38	11.88	V	Pass



<Low Channel>

Band :	WCDMA Band II						Temperature :	21~23°C	
Test Mode :	RMC 12.2Kbps Link (QPSK)						Relative Humidity :	41~42%	
Test Engineer :	Stan Hsieh, James Chiu, and Luke Chang						Polarization :	Horizontal	
Remark :	Spurious emissions within 30-1000MHz were found more than 20dB below limit line.								
Frequency (MHz)	EIRP (dBm)	Limit (dBm)	Over Limit (dB)	SPA Reading (dBm)	S.G. Power (dBm)	TX Cable loss (dB)	TX Antenna Gain (dBi)	Polarization (H/V)	Result
3704	-42.53	-13	-29.53	-61.2	-49.11	1.67	8.24	H	Pass
5557	-50.59	-13	-37.59	-74.29	-57.65	2.66	9.72	H	Pass
7410	-46.07	-13	-33.07	-74.92	-55.23	2.46	11.62	H	Pass

Band :	WCDMA Band II						Temperature :	21~23°C	
Test Mode :	RMC 12.2Kbps Link (QPSK)						Relative Humidity :	41~42%	
Test Engineer :	Stan Hsieh, James Chiu, and Luke Chang						Polarization :	Vertical	
Remark :	Spurious emissions within 30-1000MHz were found more than 20dB below limit line.								
Frequency (MHz)	EIRP (dBm)	Limit (dBm)	Over Limit (dB)	SPA Reading (dBm)	S.G. Power (dBm)	TX Cable loss (dB)	TX Antenna Gain (dBi)	Polarization (H/V)	Result
3704	-42.92	-13	-29.92	-61.46	-49.5	1.67	8.24	V	Pass
5557	-53.25	-13	-40.25	-75.4	-60.31	2.66	9.72	V	Pass
7410	-48.20	-13	-35.20	-76.28	-57.36	2.46	11.62	V	Pass



<Middle Channel>

Band :	WCDMA Band II						Temperature :	21~23°C	
Test Mode :	RMC 12.2Kbps Link (QPSK)						Relative Humidity :	41~42%	
Test Engineer :	Stan Hsieh, James Chiu, and Luke Chang						Polarization :	Horizontal	
Remark :	Spurious emissions within 30-1000MHz were found more than 20dB below limit line.								
Frequency (MHz)	EIRP (dBm)	Limit (dBm)	Over Limit (dB)	SPA Reading (dBm)	S.G. Power (dBm)	TX Cable loss (dB)	TX Antenna Gain (dBi)	Polarization (H/V)	Result
3764	-35.47	-13	-22.47	-54.62	-42.1	1.69	8.32	H	Pass
5644	-46.21	-13	-33.21	-69.96	-53.26	2.71	9.76	H	Pass
7520	-43.06	-13	-30.06	-71.73	-52.45	2.42	11.81	H	Pass

Band :	WCDMA Band II						Temperature :	21~23°C	
Test Mode :	RMC 12.2Kbps Link (QPSK)						Relative Humidity :	41~42%	
Test Engineer :	Stan Hsieh, James Chiu, and Luke Chang						Polarization :	Vertical	
Remark :	Spurious emissions within 30-1000MHz were found more than 20dB below limit line.								
Frequency (MHz)	EIRP (dBm)	Limit (dBm)	Over Limit (dB)	SPA Reading (dBm)	S.G. Power (dBm)	TX Cable loss (dB)	TX Antenna Gain (dBi)	Polarization (H/V)	Result
3764	-37.51	-13	-24.51	-56.13	-44.14	1.69	8.32	V	Pass
5644	-49.24	-13	-36.24	-71.57	-56.29	2.71	9.76	V	Pass
7520	-46.51	-13	-33.51	-74.8	-55.9	2.42	11.81	V	Pass



<High Channel>

Band :	WCDMA Band II						Temperature :	21~23°C	
Test Mode :	RMC 12.2Kbps Link (QPSK)						Relative Humidity :	41~42%	
Test Engineer :	Stan Hsieh, James Chiu, and Luke Chang						Polarization :	Horizontal	
Remark :	Spurious emissions within 30-1000MHz were found more than 20dB below limit line.								
Frequency (MHz)	EIRP (dBm)	Limit (dBm)	Over Limit (dB)	SPA Reading (dBm)	S.G. Power (dBm)	TX Cable loss (dB)	TX Antenna Gain (dBi)	Polarization (H/V)	Result
3820	-34.98	-13	-21.98	-54.6	-41.66	1.70	8.38	H	Pass
5724	-45.99	-13	-32.99	-70.12	-53.03	2.75	9.79	H	Pass
7632	-44.14	-13	-31.14	-72.59	-53.63	2.39	11.88	H	Pass

Band :	WCDMA Band II						Temperature :	21~23°C	
Test Mode :	RMC 12.2Kbps Link (QPSK)						Relative Humidity :	41~42%	
Test Engineer :	Stan Hsieh, James Chiu, and Luke Chang						Polarization :	Vertical	
Remark :	Spurious emissions within 30-1000MHz were found more than 20dB below limit line.								
Frequency (MHz)	EIRP (dBm)	Limit (dBm)	Over Limit (dB)	SPA Reading (dBm)	S.G. Power (dBm)	TX Cable loss (dB)	TX Antenna Gain (dBi)	Polarization (H/V)	Result
3820	-37.10	-13	-24.10	-55.81	-43.78	1.70	8.38	V	Pass
5724	-47.68	-13	-34.68	-70.84	-54.72	2.75	9.79	V	Pass
7632	-47.06	-13	-34.06	-75.02	-56.55	2.39	11.88	V	Pass



<Low Channel>

Band :	WCDMA Band IV						Temperature :	21~23°C		
Test Mode :	RMC 12.2Kbps Link (QPSK)						Relative Humidity :	41~42%		
Test Engineer :	Stan Hsieh, James Chiu, and Luke Chang						Polarization :	Horizontal		
Remark :	Spurious emissions within 30-1000MHz were found more than 20dB below limit line.									
Frequency (MHz)	EIRP (dBm)	Limit (dBm)	Over Limit (dB)	SPA Reading (dBm)	S.G. Power (dBm)	TX Cable loss (dB)	TX Antenna Gain (dBi)	Polarization (H/V)	Result	
3424	-51.71	-13	-38.71	-68.43	-57.8	1.58	7.67	H	Pass	
5136	-50.33	-13	-37.33	-73.13	-57.61	2.42	9.70	H	Pass	
6849	-41.22	-13	-28.22	-68.14	-49.2	2.64	10.62	H	Pass	

Band :	WCDMA Band IV						Temperature :	21~23°C		
Test Mode :	RMC 12.2Kbps Link (QPSK)						Relative Humidity :	41~42%		
Test Engineer :	Stan Hsieh, James Chiu, and Luke Chang						Polarization :	Vertical		
Remark :	Spurious emissions within 30-1000MHz were found more than 20dB below limit line.									
Frequency (MHz)	EIRP (dBm)	Limit (dBm)	Over Limit (dB)	SPA Reading (dBm)	S.G. Power (dBm)	TX Cable loss (dB)	TX Antenna Gain (dBi)	Polarization (H/V)	Result	
3424	-52.96	-13	-39.96	-69.37	-59.05	1.58	7.67	V	Pass	
5136	-49.53	-13	-36.53	-71.46	-56.81	2.42	9.70	V	Pass	
6849	-43.27	-13	-30.27	-69.83	-51.25	2.64	10.62	V	Pass	



<Middle Channel>

Band :	WCDMA Band IV						Temperature :	21~23°C		
Test Mode :	RMC 12.2Kbps Link (QPSK)						Relative Humidity :	41~42%		
Test Engineer :	Stan Hsieh, James Chiu, and Luke Chang						Polarization :	Horizontal		
Remark :	Spurious emissions within 30-1000MHz were found more than 20dB below limit line.									
Frequency (MHz)	EIRP (dBm)	Limit (dBm)	Over Limit (dB)	SPA Reading (dBm)	S.G. Power (dBm)	TX Cable loss (dB)	TX Antenna Gain (dBi)	Polarization (H/V)	Result	
3464	-48.38	-13	-35.38	-65.41	-54.63	1.59	7.84	H	Pass	
5196	-49.47	-13	-36.47	-72.2	-56.72	2.45	9.70	H	Pass	
6928	-38.80	-13	-25.80	-66.04	-46.9	2.61	10.71	H	Pass	

Band :	WCDMA Band IV						Temperature :	21~23°C		
Test Mode :	RMC 12.2Kbps Link (QPSK)						Relative Humidity :	41~42%		
Test Engineer :	Stan Hsieh, James Chiu, and Luke Chang						Polarization :	Vertical		
Remark :	Spurious emissions within 30-1000MHz were found more than 20dB below limit line.									
Frequency (MHz)	EIRP (dBm)	Limit (dBm)	Over Limit (dB)	SPA Reading (dBm)	S.G. Power (dBm)	TX Cable loss (dB)	TX Antenna Gain (dBi)	Polarization (H/V)	Result	
3464	-51.85	-13	-38.85	-68.77	-58.1	1.59	7.84	V	Pass	
5196	-46.89	-13	-33.89	-69.12	-54.14	2.45	9.70	V	Pass	
6928	-38.93	-13	-25.93	-65.96	-47.03	2.61	10.71	V	Pass	



<High Channel>

Band :	WCDMA Band IV						Temperature :	21~23°C		
Test Mode :	RMC 12.2Kbps Link (QPSK)						Relative Humidity :	41~42%		
Test Engineer :	Stan Hsieh, James Chiu, and Luke Chang						Polarization :	Horizontal		
Remark :	Spurious emissions within 30-1000MHz were found more than 20dB below limit line.									
Frequency (MHz)	EIRP (dBm)	Limit (dBm)	Over Limit (dB)	SPA Reading (dBm)	S.G. Power (dBm)	TX Cable loss (dB)	TX Antenna Gain (dBi)	Polarization (H/V)	Result	
3504	-50.73	-13	-37.73	-68.02	-57.13	1.61	8.00	H	Pass	
5256	-51.03	-13	-38.03	-73.71	-58.25	2.48	9.70	H	Pass	
7010	-43.21	-13	-30.21	-70.81	-51.44	2.59	10.82	H	Pass	

Band :	WCDMA Band IV						Temperature :	21~23°C		
Test Mode :	RMC 12.2Kbps Link (QPSK)						Relative Humidity :	41~42%		
Test Engineer :	Stan Hsieh, James Chiu, and Luke Chang						Polarization :	Vertical		
Remark :	Spurious emissions within 30-1000MHz were found more than 20dB below limit line.									
Frequency (MHz)	EIRP (dBm)	Limit (dBm)	Over Limit (dB)	SPA Reading (dBm)	S.G. Power (dBm)	TX Cable loss (dB)	TX Antenna Gain (dBi)	Polarization (H/V)	Result	
3504	-53.51	-13	-40.51	-70.95	-59.91	1.61	8.00	V	Pass	
5256	-47.62	-13	-34.62	-70.58	-54.84	2.48	9.70	V	Pass	
7010	-44.67	-13	-31.67	-72.23	-52.9	2.59	10.82	V	Pass	



3.8 Frequency Stability Measurement

3.8.1 Description of Frequency Stability Measurement

The frequency stability shall be measured by variation of ambient temperature and variation of primary supply voltage to ensure that the fundamental emission stays within the authorized frequency block. The frequency stability of the transmitter shall be maintained within $\pm 0.00025\%$ ($\pm 2.5\text{ppm}$) of the center frequency.

3.8.2 Measuring Instruments

The measuring equipment is listed in the section 4 of this test report.

3.8.3 Test Procedures for Temperature Variation

1. The testing follows FCC KDB 971168 v02r02 Section 9.0.
2. The EUT was set up in the thermal chamber and connected with the system simulator.
3. With power OFF, the temperature was decreased to -30°C and the EUT was stabilized before testing. Power was applied and the maximum change in frequency was recorded within one minute.
4. With power OFF, the temperature was raised in 10°C steps up to 50°C . The EUT was stabilized at each step for at least half an hour. Power was applied and the maximum frequency change was recorded within one minute.

3.8.4 Test Procedures for Voltage Variation

1. The testing follows FCC KDB 971168 v02r02 Section 9.0.
2. The EUT was placed in a temperature chamber at $25\pm 5^{\circ}\text{C}$ and connected with the system simulator.
3. The power supply voltage to the EUT was varied from BEP to 115% of the nominal value measured at the input to the EUT.
4. The variation in frequency was measured for the worst case.

3.8.5 Test Setup

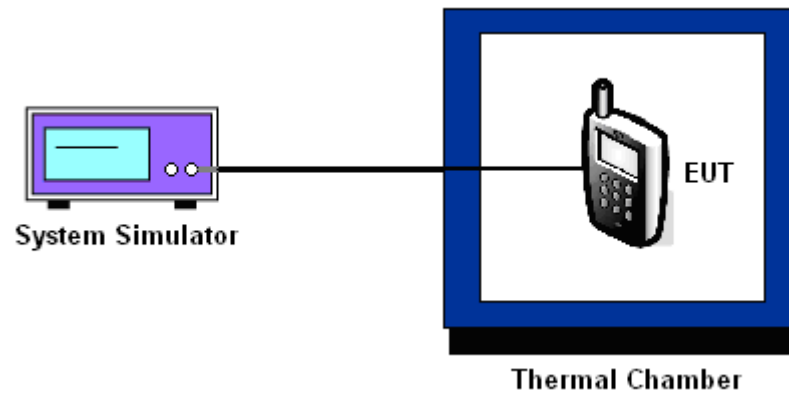



3.8.6 Test Result of Temperature Variation

Band :	GSM 850	Channel :	189
Limit (ppm) :	2.5	Frequency :	836.4 MHz

Temperature (°C)	GPRS class 8	EDGE class 8	Result
	Deviation (ppm)	Deviation (ppm)	
50	0.0096	0.0036	PASS
40	0.0060	0.0012	
30	0.0024	0.0024	
20(Ref.)	0.0000	0.0000	
10	0.0060	0.0060	
0	0.0036	0.0084	
-10	0.0120	0.0108	
-20	0.0048	0.0048	
-30	0.0012	0.0024	

Band :	GSM 1900	Channel :	661
Limit (ppm) :	within authorized band	Frequency :	1880.0 MHz

Temperature (°C)	GPRS class 8	EDGE class 8	Result
	Deviation (ppm)	Deviation (ppm)	
50	0.0005	0.0016	PASS
40	0.0005	0.0027	
30	0.0016	0.0021	
20(Ref.)	0.0000	0.0000	
10	0.0027	0.0011	
0	0.0032	0.0021	
-10	0.0064	0.0037	
-20	0.0032	0.0016	
-30	0.0005	0.0043	

Note: The frequency fundamental emissions stay within the authorized frequency block based on the frequency deviation measured is small.



Band :	WCDMA Band V	Channel :	4182
Limit (ppm) :	2.5	Frequency :	836.4 MHz

Temperature (°C)	RMC 12.2Kbps		Result
	Deviation (ppm)		
50	0.0120		PASS
40	0.0072		
30	0.0048		
20(Ref.)	0.0000		
10	0.0012		
0	0.0096		
-10	0.0024		
-20	0.0179		
-30	0.0024		

Band :	WCDMA Band IV	Channel :	1413
Limit (ppm) :	within authorized band	Frequency :	1732.6 MHz

Temperature (°C)	RMC 12.2Kbps		Result
	Deviation (ppm)		
50	0.0006		PASS
40	0.0012		
30	0.0052		
20(Ref.)	0.0000		
10	0.0058		
0	0.0046		
-10	0.0069		
-20	0.0006		
-30	0.0063		

Note: The frequency fundamental emissions stay within the authorized frequency block based on the frequency deviation measured is small.



Band :	WCDMA Band II	Channel :	9400
Limit (ppm) :	within authorized band	Frequency :	1880.0 MHz

Temperature (°C)	RMC 12.2Kbps	Result
	Deviation (ppm)	
50	0.0053	PASS
40	0.0005	
30	0.0048	
20(Ref.)	0.0000	
10	0.0005	
0	0.0043	
-10	0.0059	
-20	0.0021	
-30	0.0011	

Note: The frequency fundamental emissions stay within the authorized frequency block based on the frequency deviation measured is small.



3.8.7 Test Result of Voltage Variation

Band & Channel	Mode	Voltage (Volt)	Deviation (ppm)	Limit (ppm)	Result
GSM 850 CH189	GPRS class 8	4.35	0.0084	2.5	PASS
		3.90	0.0072		
		BEP	0.0012		
	EDGE class 8	4.35	0.0012		
		3.90	0.0048		
		BEP	0.0012		
GSM 1900 CH661	GPRS class 8	4.35	0.0016	(Note 3.)	
		3.90	0.0005		
		BEP	0.0011		
	EDGE class 8	4.35	0.0005		
		3.90	0.0016		
		BEP	0.0011		
WCDMA Band V CH4182	RMC 12.2Kbps	4.35	0.0108	2.5	
		3.90	0.0084		
		BEP	0.0036		
WCDMA Band IV CH1413	RMC 12.2Kbps	4.35	0.0075	(Note 3.)	
		3.90	0.0012		
		BEP	0.0069		
WCDMA Band II CH9400	RMC 12.2Kbps	4.35	0.0011	(Note 3.)	
		3.90	0.0027		
		BEP	0.0048		

Note:

1. Normal Voltage = 3.90V.
2. Battery End Point (BEP) = 3.50 V.
3. The frequency fundamental emissions stay within the authorized frequency block based on the frequency deviation measured is small.



4 List of Measuring Equipment

Instrument	Manufacturer	Model No.	Serial No.	Characteristics	Calibration Date	Test Date	Due Date	Remark
Spectrum Analyzer	Rohde & Schwarz	FSP30	101329	9kHz~30GHz	Jun. 24, 2015	Jul. 15, 2015	Jun. 23, 2016	Conducted (TH03-HY)
Base Station	Rohde & Schwarz	CMU200	117995	GSM / GPRS / WCDMA / CDMA	Jul. 29, 2014	Jul. 15, 2015	Jul. 28, 2015	Conducted (TH03-HY)
Temperature Chamber	ESPEC	SU-641	92013721	-30°C~70°C	Dec. 01, 2014	Jul. 15, 2015	Nov. 30, 2015	Conducted (TH03-HY)
SHF-EHF Horn Antenna	SCHWARZBEC K	BBHA 9170	BBHA91702 51	18GHz- 40GHz	Oct. 02, 2014	Jul. 18, 2015 ~ Jul. 19, 2015	Oct. 01, 2015	Radiation (03CH10-HY)
Amplifier	SONOMA	310N	187311	9kHz~1GHz	Nov. 24, 2014	Jul. 18, 2015 ~ Jul. 19, 2015	Nov. 23, 2015	Radiation (03CH10-HY)
Bilog Antenna	TESEQ	CBL 6111D	35413	30MHz~1GHz	Oct. 24, 2014	Jul. 18, 2015 ~ Jul. 19, 2015	Oct. 23, 2015	Radiation (03CH10-HY)
Horn Antenna	SCHWARZBEC K	BBHA 9120 D	9120D-1325	1GHz ~ 18GHz	Oct. 03, 2014	Jul. 18, 2015 ~ Jul. 19, 2015	Oct. 02, 2015	Radiation (03CH10-HY)
Preamplifier	Keysight	83017A	MY53270078	1GHz~26.5GHz	Nov. 20, 2014	Jul. 18, 2015 ~ Jul. 19, 2015	Nov. 19, 2015	Radiation (03CH10-HY)
Spectrum Analyzer	Keysight	N9010A	MY54200485	10Hz ~ 44GHZ	Oct. 14, 2014	Jul. 18, 2015 ~ Jul. 19, 2015	Oct. 13, 2015	Radiation (03CH10-HY)
Controller	EMEC	EM 1000	N/A	Control Turn table & Ant Mast	N/A	Jul. 18, 2015 ~ Jul. 19, 2015	N/A	Radiation (03CH10-HY)
Antenna Mast	EMEC	AM-BS-4500-B	N/A	1~4m	N/A	Jul. 18, 2015 ~ Jul. 19, 2015	N/A	Radiation (03CH10-HY)
Turn Table	EMEC	TT 2200	N/A	0-360 degree	N/A	Jul. 18, 2015 ~ Jul. 19, 2015	N/A	Radiation (03CH10-HY)



5 Uncertainty of Evaluation

Uncertainty of Radiated Emission Measurement (30 MHz ~ 1000 MHz)

Measuring Uncertainty for a Level of Confidence of 95% ($U = 2Uc(y)$)	4.50
---	------