



FCC RF Test Report

APPLICANT : Bullitt Group
EQUIPMENT : Rugged Smart Phone
BRAND NAME : Motorola
MODEL NAME : XT2083-9
FCC ID : ZL5MDFE
STANDARD : 47 CFR Part 2, 22(H), 27(M)
CLASSIFICATION : PCS Licensed Transmitter Held to Ear (PCE)

The product was received on Jan. 25, 2021 and completely tested on Mar. 09, 2021. We, Sporton International (ShenZhen) Inc., would like to declare that the tested sample has been evaluated in accordance with the procedures given in ANSI C63.26-2015 and shown compliance with the applicable technical standards.

The test results in this report apply exclusively to the tested model / sample. Without written approval of Sporton International (ShenZhen) Inc., the test report shall not be reproduced except in full.

Reviewed by: Derreck Chen / Supervisor

Approved by: Eric Shih / Manager



Sporton International (ShenZhen) Inc.

1/F, 2/F, Bldg 5, Shiling Industrial Zone, Xinwei Village, Xili, Nanshan, Shenzhen, 518055

People's Republic of China



TABLE OF CONTENTS

REVISION HISTORY... 3
SUMMARY OF TEST RESULT ... 4
1 GENERAL DESCRIPTION ... 5
1.1 Applicant ... 5
1.2 Product Feature of Equipment Under Test... 5
1.3 Product Specification of Equipment Under Test... 5
1.4 Specification of Accessory... 6
1.5 Modification of EUT ... 6
1.6 Maximum ERP/EIRP Power, Frequency Tolerance, and Emission Designator ... 6
1.7 Testing Location ... 8
1.8 Test Software... 8
1.9 Applicable Standards... 9
2 TEST CONFIGURATION OF EQUIPMENT UNDER TEST ... 10
2.1 Test Mode ... 10
2.2 Connection Diagram of Test System ... 11
2.3 Support Unit used in test configuration and system ... 11
2.4 Measurement Results Explanation Example... 11
2.5 Frequency List of Low/Middle/High Channels ... 12
3 CONDUCTED TEST ITEMS ... 13
3.1 Measuring Instruments ... 13
3.2 Test Setup ... 13
3.3 Test Result of Conducted Test ... 13
3.4 Conducted Output Power and ERP/EIRP ... 14
3.5 Peak-to-Average Ratio ... 15
3.6 Occupied Bandwidth ... 16
3.7 Conducted Band Edge ... 17
3.8 Conducted Spurious Emission ... 19
3.9 Frequency Stability ... 20
4 RADIATED TEST ITEMS ... 21
4.1 Measuring Instruments ... 21
4.2 Test Setup ... 21
4.3 Test Result of Radiated Test ... 21
4.4 Radiated Spurious Emission ... 22
5 LIST OF MEASURING EQUIPMENT ... 23
6 UNCERTAINTY OF EVALUATION ... 24
APPENDIX A. TEST RESULTS OF CONDUCTED TEST
APPENDIX B. TEST RESULTS OF RADIATED TEST
APPENDIX C. TEST SETUP PHOTOGRAPHS



REVISION HISTORY

REPORT NO.	VERSION	DESCRIPTION	ISSUED DATE
FG112510	Rev. 01	Initial issue of report	Apr. 19, 2021



SUMMARY OF TEST RESULT

Report Section	FCC Rule	Description	Limit	Result	Remark
3.4	§2.1046	Conducted Output Power	Reporting Only	PASS	-
	§22.913(a)(5)	Effective Radiated Power (Band 26)	ERP < 7 Watt	PASS	
	§27.50(h)(2)	Equivalent Isotropic Radiated Power (Band 38) (Band 41)	EIRP < 2Watt	PASS	
3.5	N/A	Peak-to-Average Ratio	<13 dB	PASS	-
3.6	§2.1049	Occupied Bandwidth	Reporting Only	PASS	-
3.7	§2.1051 §22.917(a)	Conducted Band Edge Measurement (Band 26)	< 43+10log ₁₀ (P[Watts])	PASS	-
	§27.53(m)(4)	Conducted Band Edge Measurement (Band 38) (Band 41)	§27.53(m)(4)		
3.8	§2.1051 §22.917(a)	Conducted Spurious Emission (Band 26)	< 43+10log ₁₀ (P[Watts])	PASS	-
	§2.1051 §27.53(m)(4)	Conducted Spurious Emission (Band 38) (Band 41)	< 55+10log ₁₀ (P[Watts])		
3.9	§2.1055 §22.355	Frequency Stability Temperature & Voltage	< 2.5 ppm for Part 22	PASS	-
	§2.1055 §27.54		Within Authorized Band		
4.4	§2.1053 §22.917(a)	Radiated Spurious Emission (Band 26)	< 43+10log ₁₀ (P[Watts])	PASS	Under limit 7.49 dB at 5168.18 MHz
	§2.1053 §27.53(m)(4)	Radiated Spurious Emission (Band 38) (Band 41)	< 55+10log ₁₀ (P[Watts])		

Declaration of Conformity:

The test results with all measurement uncertainty excluded are presented in accordance with the regulation limits or requirements declared by manufacturers.

Comments and Explanations:

The declared of product specification for EUT presented in the report are provided by the manufacturer, and the manufacturer takes all the responsibilities for the accuracy of product specification.



1 General Description

1.1 Applicant

Bullitt Group

One Valpy Valpy Street, Reading, United Kingdom, RG1 1AR

1.2 Product Feature of Equipment Under Test

Product Feature	
Equipment	Rugged Smart Phone
Brand Name	Motorola
Model Name	XT2083-9
FCC ID	ZL5MDFE
EUT supports Radios application	GSM/WCDMA/LTE/NFC WLAN 2.4GHz 802.11b/g/n HT20 WLAN 5GHz 802.11a/n HT20/HT40 WLAN 5GHz 802.11ac VHT20/VHT40/VHT80 Bluetooth BR / EDR / LE FM Receiver / GNSS
IMEI Code	Conducted: 359618710002961 Radiation: 355986990007230/355986990007248
EUT Stage	Production Unit

1.3 Product Specification of Equipment Under Test

Standards-related Product Specification	
Tx Frequency	LTE Band 26 : 824 MHz ~ 849 MHz LTE Band 38 : 2570 MHz ~ 2620 MHz LTE Band 41 : 2535 MHz ~ 2655 MHz
Rx Frequency	LTE Band 26 : 869 MHz ~ 894 MHz LTE Band 38 : 2570 MHz ~ 2620 MHz LTE Band 41 : 2535 MHz ~ 2655 MHz
Bandwidth	LTE Band 26 : 1.4MHz / 3MHz / 5MHz / 10MHz / 15MHz LTE Band 38 : 5MHz / 10MHz / 15MHz / 20MHz LTE Band 41 : 5MHz / 10MHz / 15MHz / 20MHz
Maximum Output Power to Antenna	LTE Band 26 : 23.55 dBm LTE Band 38 : 23.97 dBm LTE Band 41 : 23.98 dBm
Antenna Gain	LTE Band 26 : -2.7 dBi LTE Band 38 : 0.2 dBi LTE Band 41 : 0.3 dBi
Type of Modulation	QPSK / 16QAM / 64QAM



1.4 Specification of Accessory

Specification of Accessory				
AC Adapter(US)	Brand Name	Motorola (Chenyang)	Model Name	MC-201
Battery	Brand Name	Motorola (Sunwoda)	Model Name	JK50
Earphone	Brand Name	Motorola (Juwei)	Model Name	JWEP1123-T03
USB Cable	Brand Name	Motorola (Yihuaxing)	Model Name	T365-008

1.5 Modification of EUT

No modifications are made to the EUT during all test items.

1.6 Maximum ERP/EIRP Power, Frequency Tolerance, and Emission Designator

LTE Band 26		QPSK			16QAM		
BW (MHz)	Frequency Range (MHz)	Emission Designator (99%OBW)	Frequency Tolerance (ppm)	Maximum ERP(W)	Emission Designator (99%OBW)	Frequency Tolerance (ppm)	Maximum ERP(W)
1.4	824.7 ~ 848.3	1M10G7D	-	0.0689	1M10W7D	-	0.0589
3	825.5 ~ 847.5	2M72G7D	-	0.0682	2M71W7D	-	0.0582
5	826.5 ~ 846.5	4M50G7D	-	0.0687	4M51W7D	-	0.0583
10	829.0 ~ 844.0	9M03G7D	0.0043	0.0723	9M01W7D	-	0.0608
15	831.5 ~ 841.5	13M4G7D	-	0.0741	13M5W7D	-	0.0617
CH26765	821.5	13M5G7D	-	0.0741	13M5W7D	-	0.0617
LTE Band 26		64QAM					
BW (MHz)	Frequency Range (MHz)	Emission Designator (99%OBW)	Frequency Tolerance (ppm)		Maximum ERP(W)		
1.4	824.7 ~ 848.3	1M10G7D	-		0.0449		
3	825.5 ~ 847.5	2M73G7D	-		0.0452		
5	826.5 ~ 846.5	4M53G7D	-		0.0452		
10	829.0 ~ 844.0	9M01G7D	-		0.0470		
15	831.5 ~ 841.5	13M5G7D	-		0.0488		
CH26765	821.5	13M4G7D	-		0.0484		



LTE Band 38		QPSK			16QAM		
BW (MHz)	Frequency Range (MHz)	Emission Designator (99%OBW)	Frequency Tolerance (ppm)	Maximum EIRP(W)	Emission Designator (99%OBW)	Frequency Tolerance (ppm)	Maximum EIRP(W)
5	2572.5 ~ 2617.5	4M49G7D	-	0.2673	4M50W7D	-	0.2089
10	2575.0 ~ 2615.0	9M03G7D	0.0011	0.2559	8M97W7D	-	0.2075
15	2577.5 ~ 2612.5	13M5G7D	-	0.2570	13M5W7D	-	0.1959
20	2580.0 ~ 2610.0	17M9G7D	-	0.2679	17M9W7D	-	0.2113
LTE Band 38		64QAM					
BW (MHz)	Frequency Range (MHz)	Emission Designator (99%OBW)	Frequency Tolerance (ppm)		Maximum ERP(W)		
5	2572.5 ~ 2617.5	4M52G7D	-		0.1687		
10	2575.0 ~ 2615.0	9M05G7D	-		0.1629		
15	2577.5 ~ 2612.5	13M4G7D	-		0.1644		
20	2580.0 ~ 2610.0	17M9G7D	-		0.1476		
LTE Band 41		QPSK			16QAM		
BW (MHz)	Frequency Range (MHz)	Emission Designator (99%OBW)	Frequency Tolerance (ppm)	Maximum EIRP(W)	Emission Designator (99%OBW)	Frequency Tolerance (ppm)	Maximum EIRP(W)
5	2537.5 ~ 2652.5	4M49G7D	-	0.2673	4M50W7D	-	0.2089
10	2540.0 ~ 2650.0	9M03G7D	0.0011	0.2559	8M97W7D	-	0.2075
15	2542.5 ~ 2647.5	13M5G7D	-	0.2570	13M5W7D	-	0.1959
20	2545.0 ~ 2645.0	17M9G7D	-	0.2679	17M9W7D	-	0.2113
LTE Band 41		64QAM					
BW (MHz)	Frequency Range (MHz)	Emission Designator (99%OBW)	Frequency Tolerance (ppm)		Maximum ERP(W)		
5	2537.5 ~ 2652.5	4M52G7D	-		0.1687		
10	2540.0 ~ 2650.0	9M05G7D	-		0.1629		
15	2542.5 ~ 2647.5	13M4G7D	-		0.1644		
20	2545.0 ~ 2645.0	17M9G7D	-		0.1476		

Note: LTE Band 41 overlaps the entire frequency range of LTE Band 38. Therefore, the test results provided in this report covers Band 41 as well as Band 38.



1.7 Testing Location

Sporton International (Shenzhen) Inc. is accredited to ISO/IEC 17025:2017 by American Association for Laboratory Accreditation with Certificate Number 5145.01.

Test Firm	Sporton International (Shenzhen) Inc.		
Test Site Location	1/F, 2/F, Bldg 5, Shiling Industrial Zone, Xinwei Village, Xili, Nanshan, Shenzhen, 518055 People's Republic of China TEL: +86-755-86379589 FAX: +86-755-86379595		
Test Site No.	Sporton Site No.	FCC Designation No.	FCC Test Firm Registration No.
	TH01-SZ	CN1256	421272

Test Firm	Sporton International (Shenzhen) Inc.		
Test Site Location	101, 1st Floor, Block B, Building 1, No. 2, Tengfeng 4th Road, Fenghuang Community, Fuyong Street, Baoan District, Shenzhen City Guangdong Province China 518103 TEL: +86-755-33202398		
Test Site No.	Sporton Site No.	FCC Designation No.	FCC Test Firm Registration No.
	03CH01-SZ	CN1256	421272

1.8 Test Software

Item	Site	Manufacturer	Name	Version
1.	03CH01-SZ	AUDIX	E3	6.2009-8-24



1.9 Applicable Standards

According to the specifications of the manufacturer, the EUT must comply with the requirements of the following standards:

- ♦ 47 CFR Part 2, 22(H), 27(M)
- ♦ ANSI C63.26-2015
- ♦ FCC KDB 971168 D01 Power Meas License Digital Systems v03r01
- ♦ FCC KDB 412172 D01 Determining ERP and EIRP v01r01

Remark:

1. All test items were verified and recorded according to the standards and without any deviation during the test.
2. This EUT has also been tested and complied with the requirements of FCC Part 15, Subpart B, recorded in a separate test report.



2 Test Configuration of Equipment Under Test

2.1 Test Mode

Antenna port conducted and radiated test items listed below are performed according to KDB 971168 D01 Power Meas License Digital Systems v03r01 with maximum output power.

Radiated measurements are performed by rotating the EUT in three different orthogonal test planes to find the maximum emission.

Test Items	Band	Bandwidth (MHz)						Modulation			RB #			Test Channel				
		1.4	3	5	10	15	20	QPSK	16QAM	64QAM	1	Half	Full	L	M	H		
Max. Output Power	26	v	v	v	v	v	-	v	v	v	v	v	v	v	v	v		
	38	-	-	v	v	v	v	v	v	v	v	v	v	v	v	v		
	41	-	-	v	v	v	v	v	v	v	v	v	v	v	v	v		
Peak-to-Average Ratio	26				v		-	v	v	v	v		v	v	v	v		
	41	-	-				v	v	v	v	v		v	v	v	v		
26dB and 99% Bandwidth	26	v	v	v	v	v	-	v	v	v			v	v	v	v		
	41	-	-	v	v	v	v	v	v	v			v	v	v	v		
Conducted Band Edge	26	v	v	v	v	v	-	v	v	v	v		v	v		v		
	41	-	-	v	v	v	v	v	v	v	v		v	v		v		
Conducted Spurious Emission	26	v	v	v	v	v	-	v	v	v	v			v	v	v		
	41	-	-	v	v	v	v	v	v	v	v			v	v	v		
Frequency Stability	26				v		-	v					v		v			
	41	-	-		v			v					v		v			
E.R.P / E.I.R.P	26	v	v	v	v	v	-	v	v	v	v			v	v	v		
	41	-	-	v	v	v	v	v	v	v	v			v	v	v		
Radiated Spurious Emission	26	Worst Case															v	
	41	Worst Case															v	
Note	<ol style="list-style-type: none"> The mark "v " means that this configuration is chosen for testing The mark "- " means that this bandwidth is not supported. The device is investigated from 30MHz to 10 times of fundamental signal for radiated spurious emission test under different RB size/offset and modulations in exploratory test. Subsequently, only the worst case emissions are reported. LTE Band 41 overlaps the entire frequency range of LTE Band 38. Therefore, the test results provided in this report covers Band 41 as well as Band 38. 																	

2.2 Connection Diagram of Test System

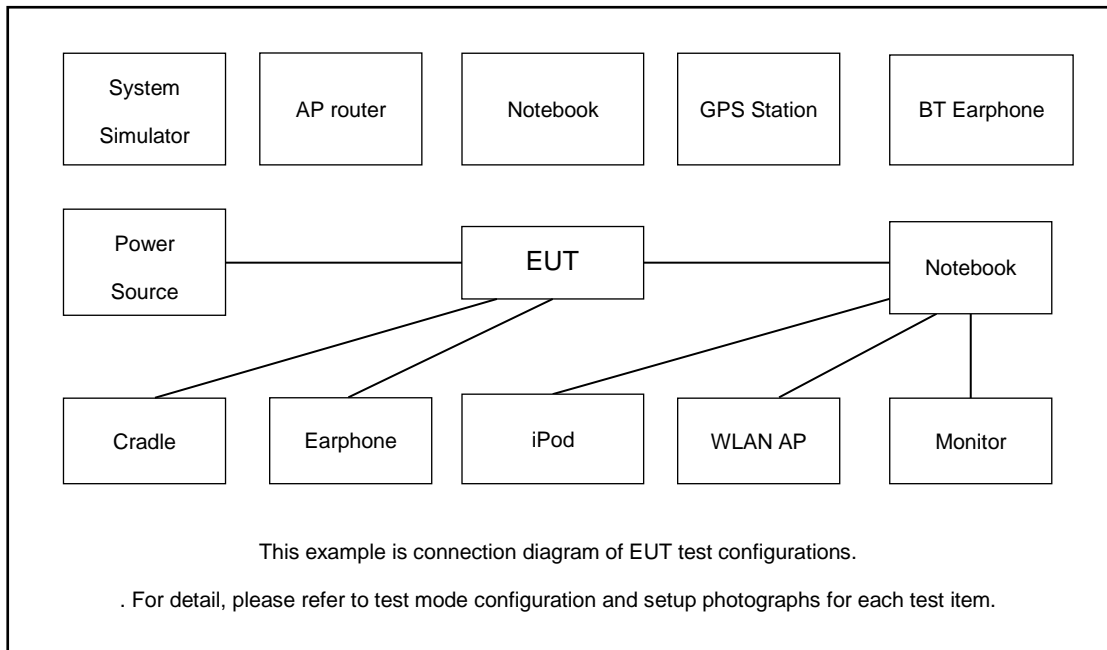

2.3 Support Unit used in test configuration and system

Item	Equipment	Trade Name	Model No.	FCC ID	Data Cable	Power Cord
1.	Power Supply	GWINSTEK	PSS-2002	N/A	N/A	Unshielded, 1.8 m
2.	LTE Base Station	Anritsu	MT8820C	N/A	N/A	Unshielded, 1.8 m

2.4 Measurement Results Explanation Example

For all conducted test items:

The offset level is set in the spectrum analyzer to compensate the RF cable loss and attenuator factor between EUT conducted output port and spectrum analyzer. With the offset compensation, the spectrum analyzer reading level is exactly the EUT RF output level.

The spectrum analyzer offset is derived from RF cable loss and attenuator factor.

Offset = RF cable loss + attenuator factor.

Following shows an offset computation example with cable loss 4 dB and 10dB attenuator.

Example :

$$\begin{aligned} \text{Offset(dB)} &= \text{RF cable loss(dB)} + \text{attenuator factor(dB)}. \\ &= 4 + 10 = 14 \text{ (dB)} \end{aligned}$$



2.5 Frequency List of Low/Middle/High Channels

LTE Band 26 Channel and Frequency List				
BW [MHz]	Channel/Frequency(MHz)	Lowest	Middle	Highest
15	Channel	26865	26915	26965
	Frequency	831.5	836.5	841.5
10	Channel	26840	26915	26990
	Frequency	829	836.5	844
5	Channel	26815	26915	27015
	Frequency	826.5	836.5	846.5
3	Channel	26805	26915	27025
	Frequency	825.5	836.5	847.5
1.4	Channel	26797	26915	27033
	Frequency	824.7	836.5	848.3

LTE Band 38 Channel and Frequency List				
BW [MHz]	Channel/Frequency(MHz)	Lowest	Middle	Highest
20	Channel	37850	38000	38150
	Frequency	2580	2595	2610
15	Channel	37825	38000	38175
	Frequency	2577.5	2595	2612.5
10	Channel	37800	38000	38200
	Frequency	2575	2595	2615
5	Channel	37775	38000	38225
	Frequency	2572.5	2595	2617.5

LTE Band 41 Channel and Frequency List				
BW [MHz]	Channel/Frequency(MHz)	Lowest	Middle	Highest
20	Channel	40140	40640	41140
	Frequency	2545	2595	2645
15	Channel	40115	40640	41165
	Frequency	2542.5	2595	2647.5
10	Channel	40090	40640	41190
	Frequency	2540	2595	2650
5	Channel	40065	40640	41215
	Frequency	2537.5	2595	2652.5

3 Conducted Test Items

3.1 Measuring Instruments

See list of measuring instruments of this test report.

3.2 Test Setup

3.2.1 Conducted Output Power



3.2.2 Peak-to-Average Ratio, Occupied Bandwidth ,Conducted Band-Edge and Conducted Spurious Emission

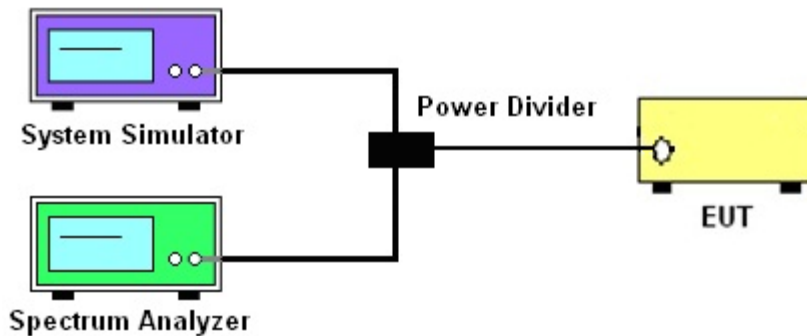

3.2.3 Frequency Stability

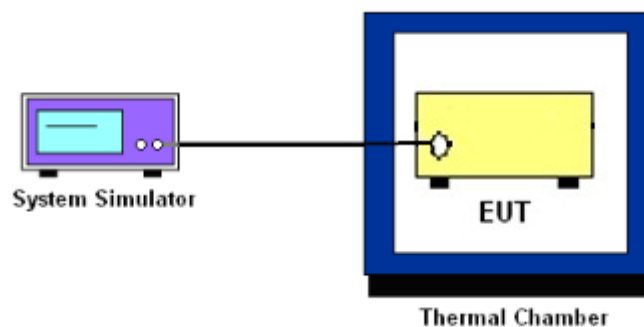

3.3 Test Result of Conducted Test

Please refer to Appendix A.



3.4 Conducted Output Power and ERP/EIRP

3.4.1 Description of the Conducted Output Power Measurement and ERP/EIRP Measurement

A system simulator was used to establish communication with the EUT. Its parameters were set to force the EUT transmitting at maximum output power. The measured power in the radio frequency on the transmitter output terminals shall be reported.

The ERP of mobile transmitters must not exceed 7 Watts for LTE Band 26.

The EIRP of mobile transmitters must not exceed 2 Watts for LTE and Band 38 and Band 41.

According to KDB 412172 D01 Power Approach,

$EIRP = P_T + G_T - L_C$, $ERP = EIRP - 2.15$, where

P_T = transmitter output power in dBm

G_T = gain of the transmitting antenna in dBi

L_C = signal attenuation in the connecting cable between the transmitter and antenna in dB

3.4.2 Test Procedures

1. The testing follows ANSI C63.26 Section 5.2
2. The transmitter output port was connected to the system simulator.
3. Set EUT at maximum power through the system simulator.
4. Select lowest, middle, and highest channels for each band and different modulation.
5. Measure and record the power level from the system simulator.



3.5 Peak-to-Average Ratio

3.5.1 Description of the PAR Measurement

Power Complementary Cumulative Distribution Function (CCDF) curves provide a means for characterizing the power peaks of a digitally modulated signal on a statistical basis. A CCDF curve depicts the probability of the peak signal amplitude exceeding the average power level. Most contemporary measurement instrumentation include the capability to produce CCDF curves for an input signal provided that the instrument's resolution bandwidth can be set wide enough to accommodate the entire input signal bandwidth. In measuring transmissions in this band using an average power technique, the peak-to-average ratio (PAR) of the transmission may not exceed 13 dB.

3.5.2 Test Procedures

1. The testing follows ANSI C63.26 Section 5.2.3.4 (CCDF).
2. The EUT was connected to spectrum and system simulator via a power divider.
3. Set the CCDF (Complementary Cumulative Distribution Function) option in spectrum analyzer.
4. The highest RF powers were measured and recorded the maximum PAPR level associated with a probability of 0.1 %.
5. Record the deviation as Peak to Average Ratio.



3.6 Occupied Bandwidth

3.6.1 Description of Occupied Bandwidth Measurement

The occupied bandwidth is the width of a frequency band such that, below the lower and above the upper frequency limits, the mean powers emitted are each equal to a specified percentage 0.5% of the total mean transmitted power.

The 26 dB emission bandwidth is defined as the frequency range between two points, one above and one below the carrier frequency, at which the spectral density of the emission is attenuated 26 dB below the maximum in-band spectral density of the modulated signal. Spectral density (power per unit bandwidth) is to be measured with a detector of resolution bandwidth equal to approximately 1.0% of the emission bandwidth.

3.6.2 Test Procedures

1. The testing follows ANSI C63.26 Section 5.4
2. The EUT was connected to spectrum analyzer and system simulator via a power divider.
3. The spectrum analyzer center frequency is set to the nominal EUT channel center frequency. The span range for the spectrum analyzer shall be between two and five times the anticipated OBW.
4. The nominal resolution bandwidth (RBW) shall be in the range of 1 to 5 % of the anticipated OBW, and the VBW shall be at least 3 times the RBW.
5. Set the detection mode to peak, and the trace mode to max hold.
6. Determine the reference value: Set the EUT to transmit a modulated signal. Allow the trace to stabilize. Set the spectrum analyzer marker to the highest level of the displayed trace.
(this is the reference value)
7. Determine the “-26 dB down amplitude” as equal to (Reference Value – X).
8. Place two markers, one at the lowest and the other at the highest frequency of the envelope of the spectral display such that each marker is at or slightly below the “-X dB down amplitude” determined in step 6. If a marker is below this “-X dB down amplitude” value it shall be placed as close as possible to this value. The OBW is the positive frequency difference between the two markers.
9. Use the 99 % power bandwidth function of the spectrum analyzer and report the measured bandwidth.



3.7 Conducted Band Edge

3.7.1 Description of Conducted Band Edge Measurement

22.917(a)

For operations in the 824 – 849 MHz band, the FCC limit is $43 + 10\log_{10}(P[\text{Watts}])$ dB below the transmitter power $P(\text{Watts})$ in a 100kHz bandwidth. However, in the 1MHz bands immediately outside and adjacent to the licensee's frequency block, a resolution bandwidth of at least one percent of the emission bandwidth of the fundamental emission of the transmitter may be employed.

27.53(m)(4)

For mobile digital stations, the attenuation factor shall be not less than $40 + 10 \log (P)$ dB on all frequencies between the channel edge and 5 megahertz from the channel edge, $43 + 10 \log (P)$ dB on all frequencies between 5 megahertz and X megahertz from the channel edge, and $55 + 10 \log (P)$ dB on all frequencies more than X megahertz from the channel edge, where X is the greater of 6 megahertz or the actual emission bandwidth as defined in paragraph (m)(6) of this section. In addition, the attenuation factor shall not be less that $43 + 10 \log (P)$ dB on all frequencies between 2490.5 MHz and 2496 MHz and $55 + 10 \log (P)$ dB at or below 2490.5 MHz. Mobile Satellite Service licensees operating on frequencies below 2495 MHz may also submit a documented interference complaint against BRS licensees operating on channel BRS Channel 1 on the same terms and conditions as adjacent channel BRS or EBS licensees.



3.7.2 Test Procedures

1. The testing follows ANSI C63.26 section 5.7
2. The EUT was connected to spectrum analyzer and system simulator via a power divider.
3. The band edges of low and high channels for the highest RF powers were measured.
4. Set RBW \geq 1% EBW in the 1MHz band immediately outside and adjacent to the band edge.
5. Beyond the 1 MHz band from the band edge, RBW=1MHz was used or a narrower RBW was used and the measured power was integrated over the full required measurement bandwidth of 1 MHz.
6. Set spectrum analyzer with RMS detector.
7. The RF fundamental frequency should be excluded against the limit line in the operating frequency band.
8. Checked that all the results comply with the emission limit line.

Example:

The limit line is derived from $43 + 10\log(P)$ dB below the transmitter power P(Watts)

$$= P(W) - [43 + 10\log(P)] \text{ (dB)}$$

$$= [30 + 10\log(P)] \text{ (dBm)} - [43 + 10\log(P)] \text{ (dB)} = -13\text{dBm}.$$

9. For LTE Band 7, 38, 41, the other 40 dB, and 55 dB have additionally applied same calculation above.



3.8 Conducted Spurious Emission

3.8.1 Description of Conducted Spurious Emission Measurement

The power of any emission outside of the authorized operating frequency ranges must be lower than the transmitter power (P) by a factor of at least $43 + 10 \log (P)$ dB.

For Band 7,38,41:

The power of any emission outside of the authorized operating frequency ranges must be lower than the transmitter power (P) by a factor of at least $55 + 10 \log (P)$ dB.

It is measured by means of a calibrated spectrum analyzer and scanned from 30 MHz up to a frequency including its 10th harmonic.

3.8.2 Test Procedures

1. The testing follows ANSI C63.26 section 5.7
2. The EUT was connected to spectrum analyzer and system simulator via a power divider.
3. The RF output of EUT was connected to the spectrum analyzer by RF cable and attenuator. The path loss was compensated to the results for each measurement.
4. The middle channel for the highest RF power within the transmitting frequency was measured.
5. The conducted spurious emission for the whole frequency range was taken.
6. Make the measurement with the spectrum analyzer's RBW = 1MHz, VBW = 3MHz.
7. Set spectrum analyzer with RMS detector.
8. Taking the record of maximum spurious emission.
9. The RF fundamental frequency should be excluded against the limit line in the operating frequency band.
10. The limit line is derived from $43 + 10\log(P)$ dB below the transmitter power P(Watts)
 $= P(W) - [43 + 10\log(P)]$ (dB)
 $= [30 + 10\log(P)]$ (dBm) - $[43 + 10\log(P)]$ (dB)
 $= -13$ dBm.
11. For Band 7, 38, 41
The limit line is derived from $55 + 10\log(P)$ dB below the transmitter power P(Watts)
 $= P(W) - [55 + 10\log(P)]$ (dB)
 $= [30 + 10\log(P)]$ (dBm) - $[55 + 10\log(P)]$ (dB)
 $= -25$ dBm.



3.9 Frequency Stability

3.9.1 Description of Frequency Stability Measurement

The frequency stability shall be measured by variation of ambient temperature and variation of primary supply voltage to ensure that the fundamental emission stays within the authorized frequency block. The frequency stability of the transmitter shall be maintained within $\pm 0.00025\%$ ($\pm 2.5\text{ppm}$) of the center frequency.

3.9.2 Test Procedures for Temperature Variation

1. The testing follows ANSI C63.26 section 5.6.4
2. The EUT was set up in the thermal chamber and connected with the system simulator.
3. With power OFF, the temperature was decreased to -30°C and the EUT was stabilized before testing. Power was applied and the maximum change in frequency was recorded within one minute.
4. With power OFF, the temperature was raised in 10°C step up to 50°C . The EUT was stabilized at each step for at least half an hour. Power was applied and the maximum frequency change was recorded within one minute.

3.9.3 Test Procedures for Voltage Variation

1. The testing follows ANSI C63.26 section 5.6.5
2. The EUT was placed in a temperature chamber at $20\pm 5^{\circ}\text{C}$ and connected with the system simulator.
3. The power supply voltage to the EUT was varied from 85% to 115% of the nominal value for other than hand carried battery equipment.
4. For hand carried, battery powered equipment, reduce the primary ac or dc supply voltage to the battery operating end point, which shall be specified by the manufacturer.
5. The variation in frequency was measured for the worst case.

4 Radiated Test Items

4.1 Measuring Instruments

See list of measuring instruments of this test report.

4.2 Test Setup

4.2.1 For radiated test from 30MHz to 1GHz

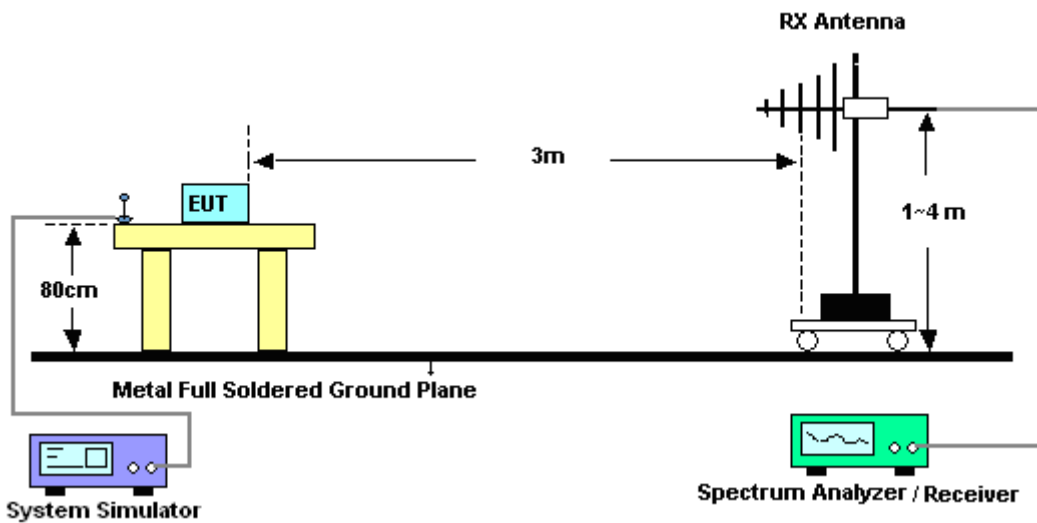

4.2.2 For radiated test above 1GHz

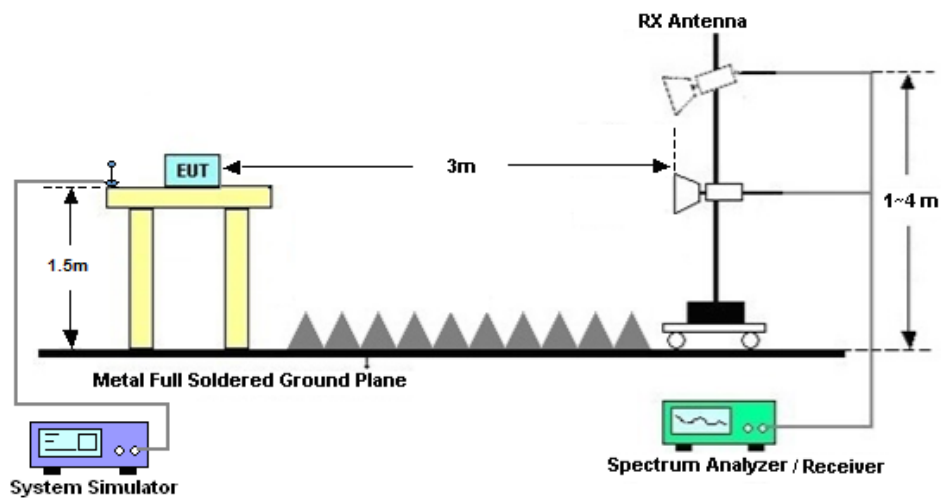

4.3 Test Result of Radiated Test

Please refer to Appendix B.



4.4 Radiated Spurious Emission

4.4.1 Description of Radiated Spurious Emission

The radiated spurious emission was measured by substitution method according to ANSI C63.26. The power of any emission outside of the authorized operating frequency ranges must be attenuated below the transmitter power (P) by a factor of at least $43 + 10 \log (P)$ dB.

For Band 7, 38, 41

The power of any emission outside of the authorized operating frequency ranges must be attenuated below the transmitter power (P) by a factor of at least $55 + 10 \log (P)$ dB.

The spectrum is scanned from 30 MHz up to a frequency including its 10th harmonic.

4.4.2 Test Procedures

1. The testing follows ANSI C63.26 Section 5.5
2. The EUT was placed on a turntable with 0.8 meter height for frequency below 1GHz and 1.5 meter height for frequency above 1GHz respectively above ground.
3. The EUT was set 3 meters from the receiving antenna mounted on the antenna tower.
4. The table was rotated 360 degrees to determine the position of the highest spurious emission.
5. The height of the receiving antenna is varied between 1m to 4m to search the maximum spurious emission for both horizontal and vertical polarizations.
6. During the measurement, the system simulator parameters were set to force the EUT transmitting at maximum output power.
7. Make the measurement with the spectrum analyzer's RBW = 1MHz, VBW = 3MHz, taking the record of maximum spurious emission.
8. A horn antenna was substituted in place of the EUT and was driven by a signal generator.
9. Tune the output power of signal generator to the same emission level with EUT maximum spurious emission.
10. $EIRP (dBm) = S.G. Power - Tx Cable Loss + Tx Antenna Gain$
11. $ERP (dBm) = EIRP - 2.15$
12. The RF fundamental frequency should be excluded against the limit line in the operating frequency band.

The limit line is derived from $43 + 10\log(P)$ dB below the transmitter power P(Watts)
 $= P(W) - [43 + 10\log(P)] (dB)$
 $= [30 + 10\log(P)] (dBm) - [43 + 10\log(P)] (dB)$
 $= -13dBm.$

13. For Band 7, 38, 41:

The limit line is derived from $55 + 10\log(P)$ dB below the transmitter power P(Watts)



5 List of Measuring Equipment

Instrument	Manufacturer	Model No.	Serial No.	Characteristics	Calibration Date	Test Date	Due Date	Remark
Spectrum Analyzer	R&S	FSV40	101078	10Hz~40GHz	Apr. 17, 2020	Feb. 07, 2021~ Feb. 09, 2021	Apr. 16, 2021	Conducted (TH01-SZ)
Thermal Chamber	Ten Billion Hongzhangroup	LP-150U	H2014081803	-40~+150°C	Jul. 22, 2020	Feb. 07, 2021~ Feb. 09, 2021	Jul. 21, 2021	Conducted (TH01-SZ)
EMI Test Receiver&SA	Agilent	N9038A	MY52260185	20Hz~26.5GHz	Jul. 21, 2020	Mar. 09, 2021	Jul. 20, 2021	Radiation (03CH01-SZ)
HF Amplifier	KEYSIGHT	83017A	MY53270104	0.5GHz~26.5GHz	Dec. 27, 2020	Mar. 09, 2021	Dec. 26, 2021	Radiation (03CH01-SZ)
Bilog Antenna	TeseQ	CBL6112D	35407	30MHz-2GHz	Jul. 15, 2020	Mar. 09, 2021	Jul. 14, 2021	Radiation (03CH01-SZ)
Double Ridge Horn Antenna	ETS-Lindgren	3117	00119436	1GHz~18GHz	Jul. 25, 2020	Mar. 09, 2021	Jul. 24, 2021	Radiation (03CH01-SZ)
SHF-EHF Horn	com-power	AH-840	101071	18GHz-40GHz	Apr. 23, 2020	Mar. 09, 2021	Apr. 22, 2021	Radiation (03CH01-SZ)
LF Amplifier	Burgeon	BPA-530	102209	0.01~3000Mhz	Apr. 17, 2020	Mar. 09, 2021	Apr. 16, 2021	Radiation (03CH01-SZ)
HF Amplifier	MITEQ	AMF-7D-00 101800-30-1 0P-R	1943528	1GHz~18GHz	Oct. 17, 2020	Mar. 09, 2021	Oct. 16, 2021	Radiation (03CH01-SZ)
HF Amplifier	MITEQ	TTA1840-35 -HG	1871923	18GHz~40GHz	Jul. 21, 2020	Mar. 09, 2021	Jul. 20, 2021	Radiation (03CH01-SZ)
AC Power Source	Chroma	61601	616010001985	N/A	NCR	Mar. 09, 2021	NCR	Radiation (03CH01-SZ)
Turn Table	EM	EM1000	N/A	0~360 degree	NCR	Mar. 09, 2021	NCR	Radiation (03CH01-SZ)
Antenna Mast	EM	EM1000	N/A	1 m~4 m	NCR	Mar. 09, 2021	NCR	Radiation (03CH01-SZ)

NCR: No Calibration Required



6 Uncertainty of Evaluation

The measurement uncertainties shown below were calculated in accordance with the requirements of ANSI 63.26-2015. All the measurement uncertainty value were shown with a coverage K=2 to indicate 95% level of confidence. The measurement data show herein meets or exceeds the CISPR measurement uncertainty values specified in CISPR 16-4-2 and can be compared directly to specified limit to determine compliance.

Uncertainty of Radiated Emission Measurement (30 MHz ~ 1000 MHz)

Measuring Uncertainty for a Level of Confidence of 95% (U = 2Uc(y))	2.48dB
---	--------

Uncertainty of Radiated Emission Measurement (1 GHz ~ 18 GHz)

Measuring Uncertainty for a Level of Confidence of 95% (U = 2Uc(y))	3.53dB
---	--------

Uncertainty of Radiated Emission Measurement (18 GHz ~ 40 GHz)

Measuring Uncertainty for a Level of Confidence of 95% (U = 2Uc(y))	4.02dB
---	--------



Appendix A. Test Results of Conducted Test

Conducted Output Power(Average power)

LTE Band 26

BW [MHz]	Modulation	RB Size	RB Offset	Power Low Ch. / Freq.	Power Middle Ch. / Freq.	Power High Ch. / Freq.
Channel				26765	26865	26965
Frequency (MHz)				821.5	831.5	841.5
15	QPSK	1	0	23.24	23.21	23.18
15	QPSK	1	37	23.30	23.26	23.27
15	QPSK	1	74	23.55	23.48	23.23
15	QPSK	36	0	22.40	22.29	22.39
15	QPSK	36	20	22.12	22.11	22.05
15	QPSK	36	39	22.10	22.08	22.04
15	QPSK	75	0	22.20	22.12	22.15
15	16QAM	1	0	22.75	22.51	22.71
15	16QAM	1	37	22.42	22.36	22.25
15	16QAM	1	74	22.71	22.73	22.42
15	16QAM	36	0	21.27	21.25	21.41
15	16QAM	36	20	21.10	21.13	21.06
15	16QAM	36	39	21.05	21.08	21.09
15	16QAM	75	0	21.13	21.09	21.13
15	64QAM	1	0	21.46	21.37	21.73
15	64QAM	1	37	21.24	21.17	21.22
15	64QAM	1	74	21.70	21.70	21.38
15	64QAM	36	0	20.31	20.35	20.46
15	64QAM	36	20	20.13	20.17	20.12
15	64QAM	36	39	20.14	20.12	19.88
15	64QAM	75	0	20.13	20.09	20.14
Channel				26740	26865	26990
Frequency (MHz)				819	831.5	844
10	QPSK	1	0	23.13	23.38	23.09
10	QPSK	1	25	23.32	23.29	23.13
10	QPSK	1	49	23.40	23.44	23.18
10	QPSK	25	0	22.15	22.21	22.15
10	QPSK	25	12	22.18	22.24	22.04
10	QPSK	25	25	22.21	22.34	22.07
10	QPSK	50	0	22.19	22.27	22.07
10	16QAM	1	0	22.67	22.68	22.64
10	16QAM	1	25	22.41	22.50	22.32
10	16QAM	1	49	22.58	22.69	22.47
10	16QAM	25	0	21.13	21.20	21.17



10	16QAM	25	12	21.14	21.23	21.03
10	16QAM	25	25	21.23	21.33	21.05
10	16QAM	50	0	21.19	21.21	21.10
10	64QAM	1	0	21.54	21.55	21.57
10	64QAM	1	25	21.18	21.30	21.14
10	64QAM	1	49	21.53	21.54	21.28
10	64QAM	25	0	20.14	20.22	20.17
10	64QAM	25	12	20.16	20.25	20.06
10	64QAM	25	25	20.25	20.34	20.07
10	64QAM	50	0	20.16	20.24	20.12
Channel				26715	26865	27015
Frequency (MHz)				816.5	831.5	846.5
5	QPSK	1	0	23.19	23.12	22.84
5	QPSK	1	12	23.16	23.17	22.86
5	QPSK	1	24	23.10	23.22	22.88
5	QPSK	12	0	22.21	22.25	21.99
5	QPSK	12	7	22.07	22.21	21.95
5	QPSK	12	13	22.06	22.22	21.92
5	QPSK	25	0	22.10	22.18	21.96
5	16QAM	1	0	22.47	22.43	22.25
5	16QAM	1	12	22.30	22.42	22.13
5	16QAM	1	24	22.42	22.51	22.15
5	16QAM	12	0	21.26	21.27	21.02
5	16QAM	12	7	21.09	21.23	20.97
5	16QAM	12	13	21.09	21.24	20.95
5	16QAM	25	0	21.07	21.21	20.96
5	64QAM	1	0	21.40	21.35	21.10
5	64QAM	1	12	21.19	21.37	21.07
5	64QAM	1	24	21.21	21.36	21.02
5	64QAM	12	0	20.24	20.30	20.02
5	64QAM	12	7	20.15	20.28	20.02
5	64QAM	12	13	20.14	20.28	19.99
5	64QAM	25	0	20.07	20.21	19.97
Channel				26705	26865	27025
Frequency (MHz)				815.5	831.5	847.5
3	QPSK	1	0	23.06	23.19	23.00
3	QPSK	1	8	23.07	23.17	22.92
3	QPSK	1	14	23.05	23.16	22.87
3	QPSK	8	0	22.20	22.11	21.88
3	QPSK	8	4	22.20	22.19	21.90
3	QPSK	8	7	22.15	22.17	21.87
3	QPSK	15	0	22.14	22.16	21.90
3	16QAM	1	0	22.33	22.50	22.20
3	16QAM	1	8	22.47	22.44	22.19
3	16QAM	1	14	22.28	22.46	22.23



3	16QAM	8	0	21.24	21.17	20.93
3	16QAM	8	4	21.22	21.24	20.95
3	16QAM	8	7	21.20	21.21	20.92
3	16QAM	15	0	21.20	21.17	20.95
3	64QAM	1	0	21.30	21.40	21.08
3	64QAM	1	8	21.33	21.38	21.04
3	64QAM	1	14	21.22	21.31	21.08
3	64QAM	8	0	20.20	20.15	19.90
3	64QAM	8	4	20.25	20.24	19.94
3	64QAM	8	7	20.18	20.21	19.94
3	64QAM	15	0	20.21	20.19	19.98
Channel				26697	26865	27033
Frequency (MHz)				814.7	831.5	848.3
1.4	QPSK	1	0	23.07	23.12	22.98
1.4	QPSK	1	3	23.04	23.10	22.89
1.4	QPSK	1	5	23.15	23.11	22.86
1.4	QPSK	3	0	23.17	23.15	22.85
1.4	QPSK	3	1	23.23	23.18	22.86
1.4	QPSK	3	3	23.22	23.17	22.89
1.4	QPSK	6	0	22.18	22.10	21.84
1.4	16QAM	1	0	22.52	22.39	22.11
1.4	16QAM	1	3	22.44	22.46	22.22
1.4	16QAM	1	5	22.55	22.41	22.19
1.4	16QAM	3	0	22.24	22.17	21.89
1.4	16QAM	3	1	22.22	22.20	21.90
1.4	16QAM	3	3	22.10	22.15	21.93
1.4	16QAM	6	0	21.18	21.17	20.92
1.4	64QAM	1	0	21.29	21.28	20.97
1.4	64QAM	1	3	21.33	21.37	21.14
1.4	64QAM	1	5	21.28	21.33	21.06
1.4	64QAM	3	0	21.34	21.27	20.98
1.4	64QAM	3	1	21.36	21.29	21.01
1.4	64QAM	3	3	21.31	21.30	21.03
1.4	64QAM	6	0	20.14	20.13	19.87



LTE Band 38

BW [MHz]	Modulation	RB Size	RB Offset	Power Low Ch. / Freq.	Power Middle Ch. / Freq.	Power High Ch. / Freq.
Channel				37850	38000	38150
Frequency (MHz)				2580	2595	2610
20	QPSK	1	0	23.57	23.44	23.51
20	QPSK	1	49	23.97	23.58	23.59
20	QPSK	1	99	23.67	23.52	23.39
20	QPSK	50	0	22.88	22.85	22.54
20	QPSK	50	24	22.96	22.84	22.59
20	QPSK	50	50	22.83	22.77	22.55
20	QPSK	100	0	22.77	22.45	22.67
20	16QAM	1	0	22.83	22.66	22.49
20	16QAM	1	49	22.93	22.81	22.46
20	16QAM	1	99	22.81	22.79	22.57
20	16QAM	50	0	21.66	21.48	21.50
20	16QAM	50	24	21.96	21.58	21.58
20	16QAM	50	50	21.94	21.68	21.61
20	16QAM	100	0	21.88	21.60	21.52
20	64QAM	1	0	21.55	21.23	21.57
20	64QAM	1	49	21.59	21.25	21.51
20	64QAM	1	99	21.64	21.38	21.26
20	64QAM	50	0	20.75	20.35	20.98
20	64QAM	50	24	20.94	20.68	20.90
20	64QAM	50	50	20.92	20.58	20.52
20	64QAM	100	0	20.87	20.63	20.54
Channel				37825	38000	20.58
Frequency (MHz)				2577.5	2595	20.65
15	QPSK	1	0	23.69	23.50	23.35
15	QPSK	1	37	23.53	23.34	23.44
15	QPSK	1	74	23.65	23.50	23.60
15	QPSK	36	0	22.67	22.54	22.53
15	QPSK	36	20	22.89	22.55	22.62
15	QPSK	36	39	22.92	22.50	22.63
15	QPSK	75	0	22.85	22.54	22.52
15	16QAM	1	0	22.77	22.50	22.54
15	16QAM	1	37	22.99	22.86	22.96
15	16QAM	1	74	22.86	22.82	22.66
15	16QAM	36	0	21.69	21.50	21.50
15	16QAM	36	20	21.92	21.53	21.73
15	16QAM	36	39	21.88	21.60	21.46
15	16QAM	75	0	21.86	21.48	21.65
15	64QAM	1	0	21.62	21.07	21.22



15	64QAM	1	37	21.36	21.28	21.41
15	64QAM	1	74	21.61	21.32	21.36
15	64QAM	36	0	20.85	20.65	20.56
15	64QAM	36	20	20.85	20.57	20.57
15	64QAM	36	39	21.00	20.55	20.61
15	64QAM	75	0	20.76	20.50	20.60
Channel				37800	38000	38200
Frequency (MHz)				2575	2595	2615
10	QPSK	1	0	23.66	23.71	23.81
10	QPSK	1	25	23.81	23.73	23.68
10	QPSK	1	49	23.94	23.86	23.65
10	QPSK	25	0	22.98	22.66	22.74
10	QPSK	25	12	22.93	22.63	22.71
10	QPSK	25	25	22.95	22.72	22.81
10	QPSK	50	0	22.96	22.67	22.75
10	16QAM	1	0	22.93	22.94	22.91
10	16QAM	1	25	22.96	22.82	22.84
10	16QAM	1	49	22.93	22.97	22.70
10	16QAM	25	0	21.92	21.69	21.76
10	16QAM	25	12	21.91	21.58	21.76
10	16QAM	25	25	21.94	21.76	21.76
10	16QAM	50	0	21.97	21.73	21.83
10	64QAM	1	0	21.85	21.53	21.69
10	64QAM	1	25	21.65	21.45	21.51
10	64QAM	1	49	21.87	21.68	21.50
10	64QAM	25	0	20.94	20.72	20.82
10	64QAM	25	12	20.93	20.62	20.63
10	64QAM	25	25	20.94	20.83	20.84
10	64QAM	50	0	20.95	20.73	20.77
Channel				37775	38000	38225
Frequency (MHz)				2572.5	2595	2617.5
5	QPSK	1	0	23.75	23.81	23.52
5	QPSK	1	12	23.74	23.75	23.69
5	QPSK	1	24	23.95	23.62	23.67
5	QPSK	12	0	22.93	22.70	22.73
5	QPSK	12	7	22.98	22.64	22.77
5	QPSK	12	13	22.97	22.72	22.71
5	QPSK	25	0	22.96	22.65	22.80
5	16QAM	1	0	23.00	22.76	22.91
5	16QAM	1	12	22.92	22.85	22.83
5	16QAM	1	24	22.99	22.74	22.91
5	16QAM	12	0	21.95	21.67	21.61
5	16QAM	12	7	21.92	21.73	21.77
5	16QAM	12	13	21.94	21.72	21.71
5	16QAM	25	0	21.99	21.70	21.86



5	64QAM	1	0	21.85	21.74	21.61
5	64QAM	1	12	21.87	21.54	21.82
5	64QAM	1	24	21.75	21.55	21.51
5	64QAM	12	0	20.99	20.75	20.68
5	64QAM	12	7	20.97	20.80	20.75
5	64QAM	12	13	21.00	20.80	20.80
5	64QAM	25	0	20.92	20.65	20.82

LTE Band 41

BW [MHz]	Modulation	RB Size	RB Offset	Power Low Ch. / Freq.	Power Middle Ch. / Freq.	Power High Ch. / Freq.
Channel				40140	40640	41140
Frequency (MHz)				2545	2595	2645
20	QPSK	1	0	23.66	23.68	23.56
20	QPSK	1	49	23.81	23.98	23.75
20	QPSK	1	99	23.60	23.67	23.58
20	QPSK	50	0	22.87	22.96	22.65
20	QPSK	50	24	22.93	22.70	22.69
20	QPSK	50	50	22.94	22.73	22.90
20	QPSK	100	0	22.70	22.80	22.60
20	16QAM	1	0	22.86	22.76	22.68
20	16QAM	1	49	22.95	22.92	22.57
20	16QAM	1	99	22.60	22.51	22.53
20	16QAM	50	0	21.91	21.80	21.98
20	16QAM	50	24	21.96	21.80	21.93
20	16QAM	50	50	21.85	21.64	21.93
20	16QAM	100	0	21.85	21.60	21.48
20	64QAM	1	0	21.39	21.34	21.71
20	64QAM	1	49	21.65	21.52	21.59
20	64QAM	1	99	21.38	21.25	21.61
20	64QAM	50	0	20.85	20.64	20.60
20	64QAM	50	24	20.54	20.76	20.53
20	64QAM	50	50	20.75	20.58	20.43
20	64QAM	100	0	20.82	20.66	20.63
Channel				40115	40640	41165
Frequency (MHz)				2542.5	2595	2647.5
15	QPSK	1	0	23.80	23.61	23.68
15	QPSK	1	37	23.79	23.65	23.58
15	QPSK	1	74	23.78	23.66	23.68
15	QPSK	36	0	22.93	22.83	22.89
15	QPSK	36	20	22.98	22.74	22.92
15	QPSK	36	39	22.98	22.70	22.98
15	QPSK	75	0	22.94	22.97	22.93



15	16QAM	1	0	22.62	22.61	22.45
15	16QAM	1	37	22.48	22.59	22.37
15	16QAM	1	74	22.50	22.47	22.34
15	16QAM	36	0	21.90	21.97	21.85
15	16QAM	36	20	21.98	21.99	21.90
15	16QAM	36	39	21.99	21.71	22.00
15	16QAM	75	0	21.91	21.69	21.95
15	64QAM	1	0	21.57	21.56	21.86
15	64QAM	1	37	21.74	21.54	21.72
15	64QAM	1	74	21.75	21.84	21.77
15	64QAM	36	0	20.84	20.89	20.80
15	64QAM	36	20	21.00	20.93	20.80
15	64QAM	36	39	20.93	20.89	20.78
15	64QAM	75	0	20.91	20.92	20.65
Channel				40090	40640	41190
Frequency (MHz)				2540	2595	2650
10	QPSK	1	0	23.72	23.74	23.53
10	QPSK	1	25	23.78	23.66	23.48
10	QPSK	1	49	23.77	23.61	23.41
10	QPSK	25	0	22.95	22.74	22.89
10	QPSK	25	12	22.96	22.73	22.72
10	QPSK	25	25	22.93	22.71	22.68
10	QPSK	50	0	22.99	22.67	22.78
10	16QAM	1	0	22.81	22.77	22.52
10	16QAM	1	25	22.56	22.87	22.47
10	16QAM	1	49	22.74	22.52	22.61
10	16QAM	25	0	21.95	21.71	21.80
10	16QAM	25	12	22.00	21.80	21.81
10	16QAM	25	25	21.93	21.69	21.81
10	16QAM	50	0	21.93	21.76	21.91
10	64QAM	1	0	21.70	21.59	21.60
10	64QAM	1	25	21.75	21.60	21.82
10	64QAM	1	49	21.55	21.46	21.48
10	64QAM	25	0	20.87	20.90	20.64
10	64QAM	25	12	20.95	20.86	20.65
10	64QAM	25	25	20.87	20.75	20.77
10	64QAM	50	0	20.92	20.84	20.67
Channel				40065	40640	41215
Frequency (MHz)				2537.5	2595	2652.5
5	QPSK	1	0	23.97	23.94	23.66
5	QPSK	1	12	23.61	23.96	23.52
5	QPSK	1	24	23.96	23.88	23.56
5	QPSK	12	0	22.98	22.92	22.91
5	QPSK	12	7	22.93	22.89	22.73
5	QPSK	12	13	22.88	22.81	22.79



5	QPSK	25	0	22.89	22.81	22.83
5	16QAM	1	0	22.90	22.85	22.78
5	16QAM	1	12	22.87	22.89	22.61
5	16QAM	1	24	22.80	22.88	22.58
5	16QAM	12	0	21.92	21.94	21.99
5	16QAM	12	7	21.81	21.83	22.00
5	16QAM	12	13	21.76	21.75	21.76
5	16QAM	25	0	22.00	21.91	21.99
5	64QAM	1	0	21.76	21.67	21.73
5	64QAM	1	12	21.97	21.73	21.81
5	64QAM	1	24	21.63	21.63	21.49
5	64QAM	12	0	20.78	20.75	20.53
5	64QAM	12	7	20.69	20.75	20.51
5	64QAM	12	13	20.65	20.65	20.48
5	64QAM	25	0	20.75	20.80	20.61



ERP/EIRP

LTE Band 26 (GT - LC = -2.70 dB) QPSK									
Bandwidth	1.4M			3M			5M		
Channel	26797	26915	27033	26805	26915	27025	26815	26915	27015
	(Low)	(Mid)	(High)	(Low)	(Mid)	(High)	(Low)	(Mid)	(High)
Frequency	824.7	836.5	848.3	825.5	836.5	847.5	826.5	836.5	846.5
(MHz)									
Conducted Power (dBm)	23.23	23.18	22.86	23.06	23.19	23.00	23.10	23.22	22.88
Conducted Power (Watts)	0.2104	0.2080	0.1932	0.2023	0.2084	0.1995	0.2042	0.2099	0.1941
ERP(dBm)	18.38	18.33	18.01	18.21	18.34	18.15	18.25	18.37	18.03
ERP(Watts)	0.0689	0.0681	0.0632	0.0662	0.0682	0.0653	0.0668	0.0687	0.0635

LTE Band 26 (GT - LC = -2.70 dB) QPSK							
Bandwidth	10M			15M			15M
Channel	26840	26915	26990	26865	26915	26965	26765
	(Low)	(Mid)	(High)	(Low)	(Mid)	(High)	(Low)
Frequency	829	836.5	844	831.5	836.5	841.5	821.5
(MHz)							
Conducted Power (dBm)	23.40	23.44	23.18	23.55	23.48	23.23	23.55
Conducted Power (Watts)	0.2188	0.2208	0.2080	0.2265	0.2228	0.2104	0.2265
ERP(dBm)	18.55	18.59	18.33	18.70	18.63	18.38	18.70
ERP(Watts)	0.0716	0.0723	0.0681	0.0741	0.0729	0.0689	0.0741



LTE Band 26 (GT - LC = -2.70 dB) 16QAM									
Bandwidth	1.4M			3M			5M		
Channel	26797	26915	27033	26805	26915	27025	26815	26915	27015
	(Low)	(Mid)	(High)	(Low)	(Mid)	(High)	(Low)	(Mid)	(High)
Frequency	824.7	836.5	848.3	825.5	836.5	847.5	826.5	836.5	846.5
(MHz)									
Conducted Power (dBm)	22.55	22.41	22.19	22.33	22.50	22.20	22.42	22.51	22.15
Conducted Power (Watts)	0.1799	0.1742	0.1656	0.1710	0.1778	0.1660	0.1746	0.1782	0.1641
ERP(dBm)	17.70	17.56	17.34	17.48	17.65	17.35	17.57	17.66	17.30
ERP(Watts)	0.0589	0.0570	0.0542	0.0560	0.0582	0.0543	0.0571	0.0583	0.0537

LTE Band 26 (GT - LC = -2.70 dB) 16QAM							
Bandwidth	10M			15M			15M
Channel	26840	26915	26990	26865	26915	26965	26765
	(Low)	(Mid)	(High)	(Low)	(Mid)	(High)	(Low)
Frequency	829	836.5	844	831.5	836.5	841.5	821.5
(MHz)							
Conducted Power (dBm)	22.58	22.69	22.47	22.75	22.51	22.71	22.75
Conducted Power (Watts)	0.1811	0.1858	0.1766	0.1884	0.1782	0.1866	0.1884
ERP(dBm)	17.73	17.84	17.62	17.90	17.66	17.86	17.90
ERP(Watts)	0.0593	0.0608	0.0578	0.0617	0.0583	0.0611	0.0617



LTE Band 26 (GT - LC = -2.70 dB) 64QAM									
Bandwidth	1.4M			3M			5M		
Channel	26797	26915	27033	26805	26915	27025	26815	26915	27015
	(Low)	(Mid)	(High)	(Low)	(Mid)	(High)	(Low)	(Mid)	(High)
Frequency	824.7	836.5	848.3	825.5	836.5	847.5	826.5	836.5	846.5
(MHz)									
Conducted Power (dBm)	21.33	21.37	21.14	21.30	21.40	21.08	21.40	21.35	21.10
Conducted Power (Watts)	0.1358	0.1371	0.1300	0.1349	0.1380	0.1282	0.1380	0.1365	0.1288
ERP(dBm)	16.48	16.52	16.29	16.45	16.55	16.23	16.55	16.50	16.25
ERP(Watts)	0.0445	0.0449	0.0426	0.0442	0.0452	0.0420	0.0452	0.0447	0.0422

LTE Band 26 (GT - LC = -2.70 dB) 64QAM							
Bandwidth	10M			15M			15M
Channel	26840	26915	26990	26865	26915	26965	26765
	(Low)	(Mid)	(High)	(Low)	(Mid)	(High)	(Low)
Frequency	829	836.5	844	831.5	836.5	841.5	821.5
(MHz)							
Conducted Power (dBm)	21.54	21.55	21.57	21.46	21.37	21.73	21.70
Conducted Power (Watts)	0.1426	0.1429	0.1435	0.1400	0.1371	0.1489	0.1479
ERP(dBm)	16.69	16.70	16.72	16.61	16.52	16.88	16.85
ERP(Watts)	0.0467	0.0468	0.0470	0.0458	0.0449	0.0488	0.0484



LTE Band 41 (G _T - L _C = 0.30dB) QPSK									
Bandwidth	5M			10M			15M		
Channel	40065	40640	41215	40090	40640	41190	40115	40640	41165
	(Low)	(Mid)	(High)	(Low)	(Mid)	(High)	(Low)	(Mid)	(High)
Frequency (MHz)	2537.5	2595	2652.5	2540	2595	2650	25423.5	2595	2647.5
Conducted Power (dBm)	23.97	23.94	23.66	23.78	23.66	23.48	23.80	23.61	23.68
Conducted Power (Watts)	0.2495	0.2477	0.2323	0.2388	0.2323	0.2228	0.2399	0.2296	0.2333
EIRP(dBm)	24.27	24.24	23.96	24.08	23.96	23.78	24.10	23.91	23.98
EIRP(Watts)	0.2673	0.2655	0.2489	0.2559	0.2489	0.2388	0.2570	0.2460	0.2500

LTE Band 41 (G _T - L _C = 0.30dB) QPSK			
Bandwidth	20M		
Channel	40140	40640	41140
	(Low)	(Mid)	(High)
Frequency (MHz)	2545	2595	2645
Conducted Power (dBm)	23.81	23.98	23.75
Conducted Power (Watts)	0.2404	0.2500	0.2371
EIRP(dBm)	24.11	24.28	24.05
EIRP(Watts)	0.2576	0.2679	0.2541



LTE Band 41 ($G_T - L_C = 0.30\text{dB}$) 16QAM									
Bandwidth	5M			10M			15M		
Channel	40065	40640	41215	40065	40640	41215	40065	40640	41215
	(Low)	(Mid)	(High)	(Low)	(Mid)	(High)	(Low)	(Mid)	(High)
Frequency (MHz)	2537.5	2595	2652.5	2537.5	2595	2652.5	2537.5	2595	2652.5
Conducted Power (dBm)	22.90	22.85	22.78	22.56	22.87	22.47	22.62	22.61	22.45
Conducted Power (Watts)	0.1950	0.1928	0.1897	0.1803	0.1936	0.1766	0.1828	0.1824	0.1758
EIRP(dBm)	23.20	23.15	23.08	22.86	23.17	22.77	22.92	22.91	22.75
EIRP(Watts)	0.2089	0.2065	0.2032	0.1932	0.2075	0.1892	0.1959	0.1954	0.1884

LTE Band 41 ($G_T - L_C = 0.30\text{dB}$) 16QAM			
Bandwidth	20M		
Channel	40140	40640	41140
	(Low)	(Mid)	(High)
Frequency (MHz)	2545	2595	2645
Conducted Power (dBm)	22.95	22.92	22.57
Conducted Power (Watts)	0.1972	0.1959	0.1807
EIRP(dBm)	23.25	23.22	22.87
EIRP(Watts)	0.2113	0.2099	0.1936



LTE Band 41 ($G_T - L_C = 0.30\text{dB}$) 64QAM									
Bandwidth	5M			10M			15M		
Channel	40065	40640	41215	40065	40640	41215	40065	40640	41215
	(Low)	(Mid)	(High)	(Low)	(Mid)	(High)	(Low)	(Mid)	(High)
Frequency (MHz)	2537.5	2595	2652.5	2537.5	2595	2652.5	2537.5	2595	2652.5
Conducted Power (dBm)	21.97	21.73	21.81	21.75	21.60	21.82	21.57	21.56	21.86
Conducted Power (Watts)	0.1574	0.1489	0.1517	0.1496	0.1445	0.1521	0.1435	0.1432	0.1535
EIRP(dBm)	22.27	22.03	22.11	22.05	21.90	22.12	21.87	21.86	22.16
EIRP(Watts)	0.1687	0.1596	0.1626	0.1603	0.1549	0.1629	0.1538	0.1535	0.1644

LTE Band 41 ($G_T - L_C = 0.30\text{dB}$) 64QAM			
Bandwidth	20M		
Channel	40140	40640	41140
	(Low)	(Mid)	(High)
Frequency (MHz)	2545	2595	2645
Conducted Power (dBm)	21.39	21.34	21.71
Conducted Power (Watts)	0.1377	0.1361	0.1483
EIRP(dBm)	21.69	21.64	22.01
EIRP(Watts)	0.1476	0.1459	0.1589



LTE Band 26

Peak-to-Average Ratio

Mode	LTE Band 26 / 15MHz				
Mod.	QPSK		16QAM		Limit: 13dB
RB Size	1RB	Full RB	1RB	Full RB	Result
Lowest CH	4.49	5.10	5.54	5.94	PASS
Middle CH	4.49	4.99	5.01	5.88	
Highest CH	4.46	5.04	5.07	5.94	
Mode	LTE Band 26 / 15MHz				
Mod.	64QAM				Limit: 13dB
RB Size	1RB	Full RB			Result
Lowest CH	6.23	6.52	-	-	PASS
Middle CH	6.23	6.46	-	-	
Highest CH	6.14	6.46	-	-	



LTE Band 26 / 15MHz / QPSK

Lowest Channel / 1RB

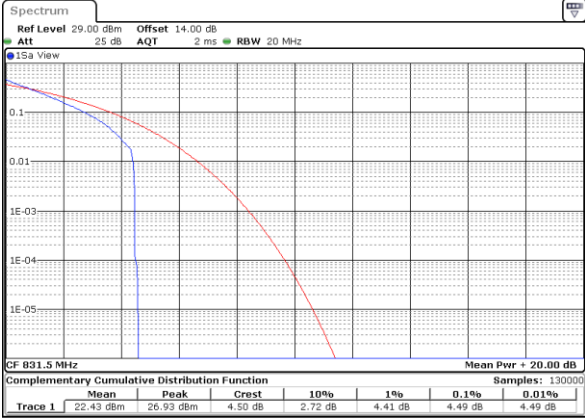

Date: 7.FEB.2021 16:25:36

Lowest Channel / Full RB

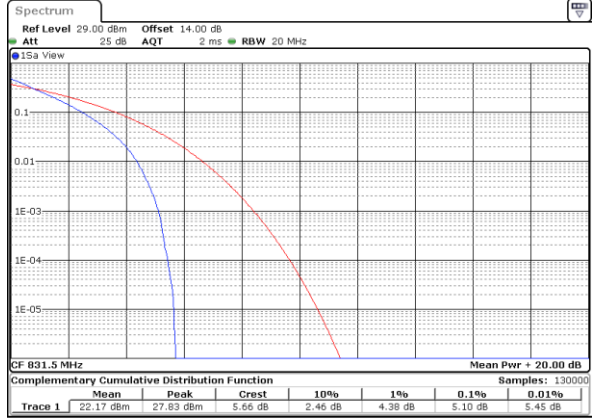

Date: 7.FEB.2021 16:24:20

Middle Channel / 1RB

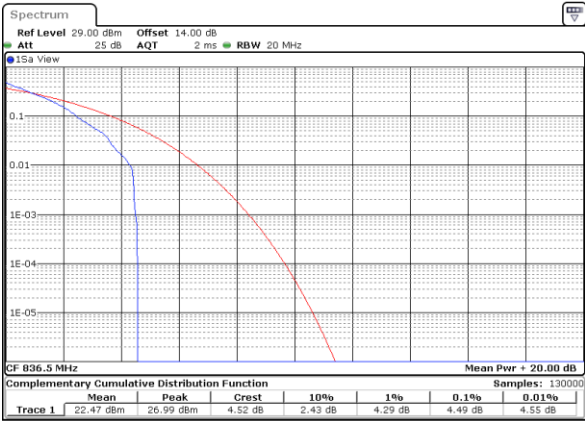

Date: 7.FEB.2021 16:22:42

Middle Channel / Full RB



Date: 7.FEB.2021 16:23:56

Highest Channel / 1RB

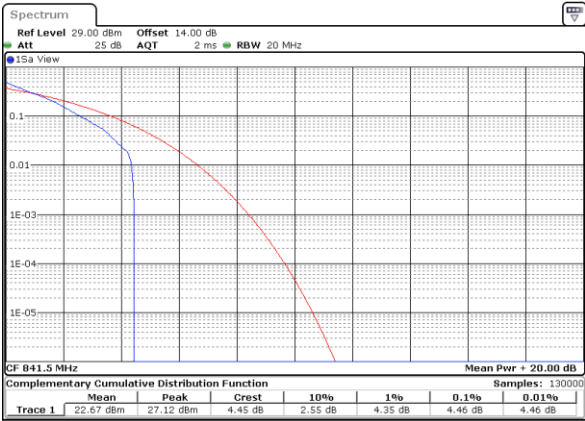

Date: 7.FEB.2021 16:22:02

Highest Channel / Full RB

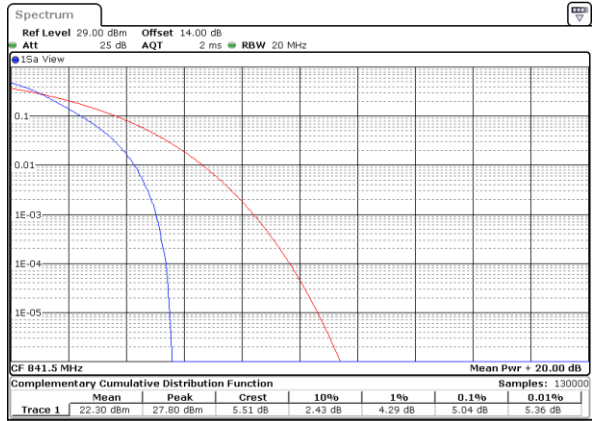

Date: 7.FEB.2021 16:21:44



LTE Band 26 / 15MHz / 16QAM

Lowest Channel / 1RB

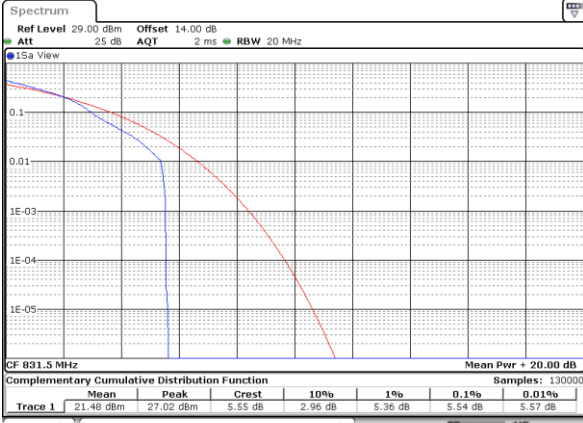

Date: 7.FEB.2021 16:25:18

Lowest Channel / Full RB

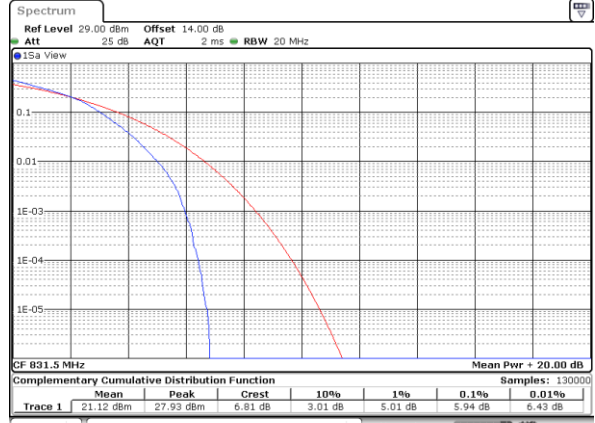

Date: 7.FEB.2021 16:24:36

Middle Channel / 1RB

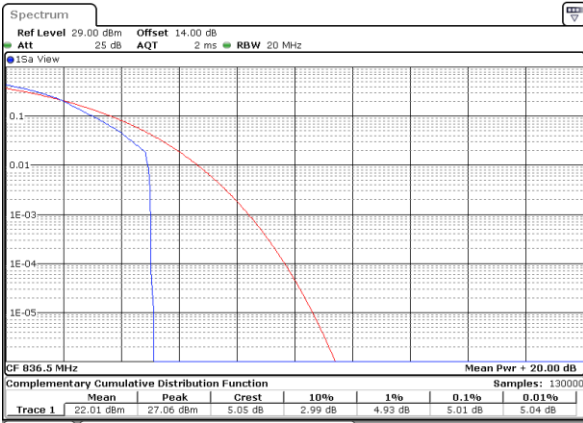

Date: 7.FEB.2021 16:22:57

Middle Channel / Full RB

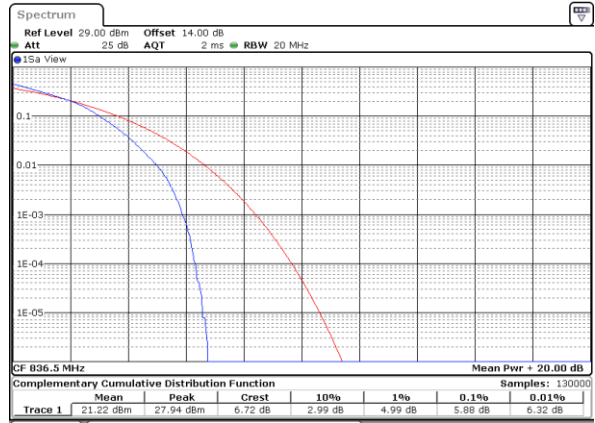

Date: 7.FEB.2021 16:23:39

Highest Channel / 1RB

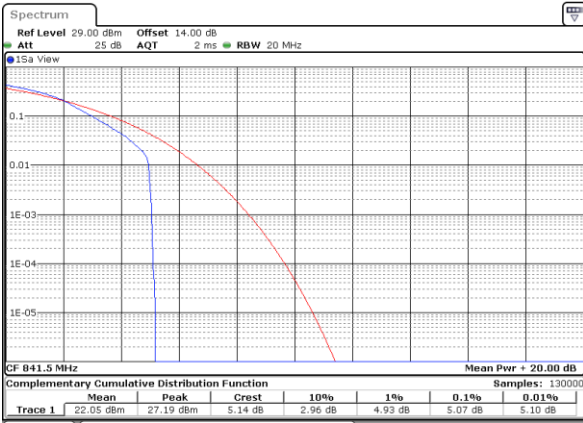

Date: 7.FEB.2021 16:22:13

Highest Channel / Full RB

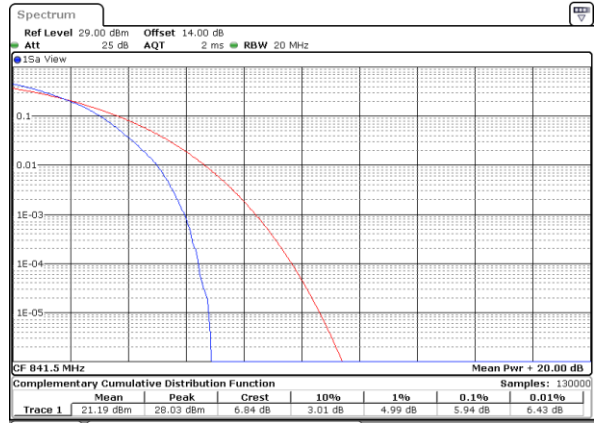

Date: 7.FEB.2021 16:21:29



LTE Band 26 / 15MHz / 64QAM

Lowest Channel / 1RB



Date: 7.FEB.2021 16:25:06

Lowest Channel / Full RB

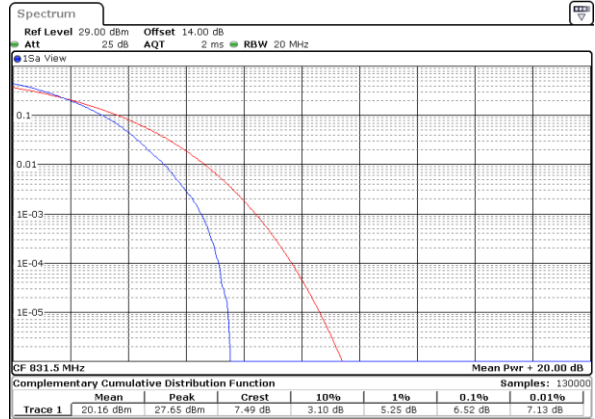

Date: 7.FEB.2021 16:24:47

Middle Channel / 1RB

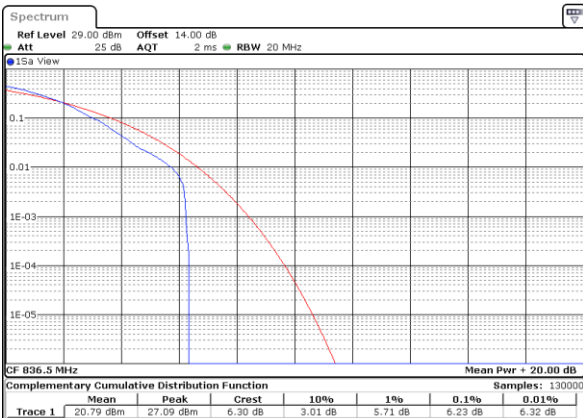

Date: 7.FEB.2021 16:23:12

Middle Channel / Full RB

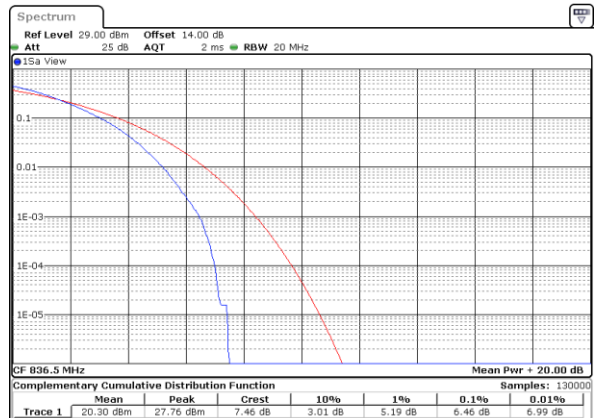

Date: 7.FEB.2021 16:23:27

Highest Channel / 1RB



Date: 7.FEB.2021 16:22:24

Highest Channel / Full RB

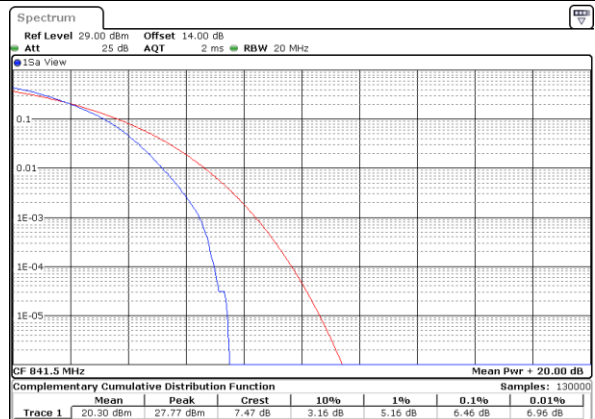

Date: 7.FEB.2021 16:20:52



26dB Bandwidth

Mode	LTE Band 26 : 26dB BW(MHz)											
BW	1.4MHz		3MHz		5MHz		10MHz		15MHz		20MHz	
Mod.	QPSK	16QAM	QPSK	16QAM	QPSK	16QAM	QPSK	16QAM	QPSK	16QAM	QPSK	16QAM
Lowest CH	1.28	1.28	3.02	3.01	4.94	5.01	9.77	9.89	14.39	14.45	-	-
Middle CH	1.26	1.26	3.02	3.05	4.94	4.95	9.91	9.65	14.36	14.48	-	-
Highest CH	1.26	1.29	3.00	3.04	4.85	4.93	9.87	9.61	14.30	14.15	-	-
Mode	LTE Band 26 : 26dB BW(MHz)											
BW	1.4MHz		3MHz		5MHz		10MHz		15MHz		20MHz	
Mod.	64QAM		64QAM		64QAM		64QAM		64QAM		64QAM	
Lowest CH	1.29	-	3.03	-	4.92	-	9.83	-	14.75	-	-	-
Middle CH	1.27	-	3.00	-	4.87	-	9.87	-	14.57	-	-	-
Highest CH	1.29	-	2.96	-	4.90	-	9.83	-	14.39	-	-	-



LTE Band 26

Lowest Channel / 1.4MHz / QPSK

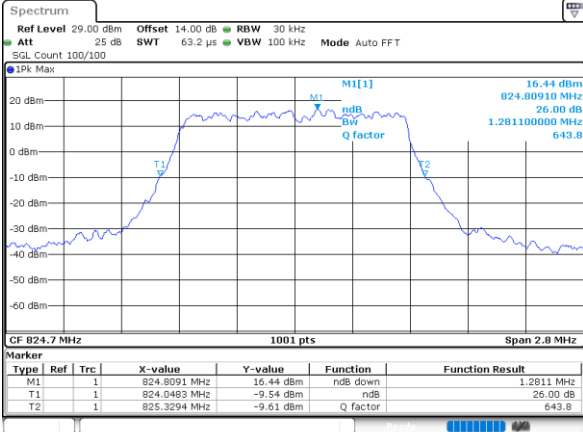

Date: 7.FEB.2021 09:41:28

Lowest Channel / 1.4MHz / 16QAM

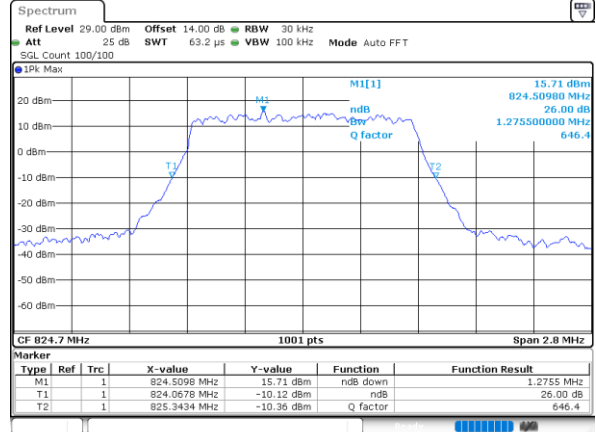

Date: 7.FEB.2021 09:42:03

Middle Channel / 1.4MHz / QPSK

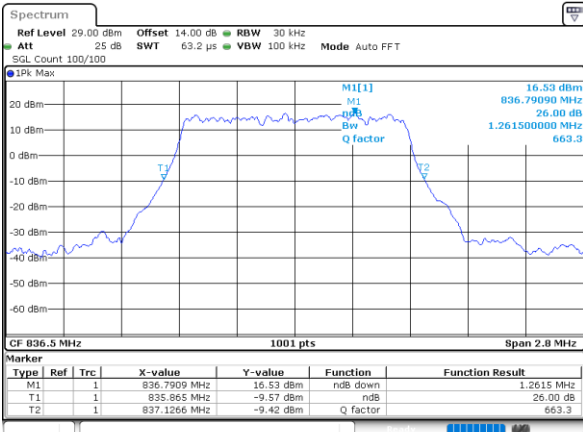

Date: 7.FEB.2021 10:10:35

Middle Channel / 1.4MHz / 16QAM

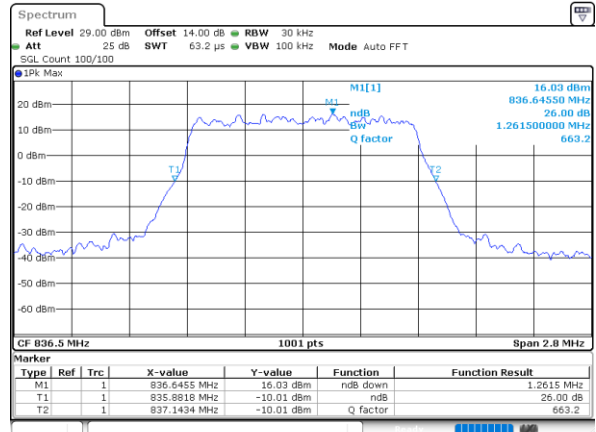

Date: 7.FEB.2021 10:10:09

Highest Channel / 1.4MHz / QPSK

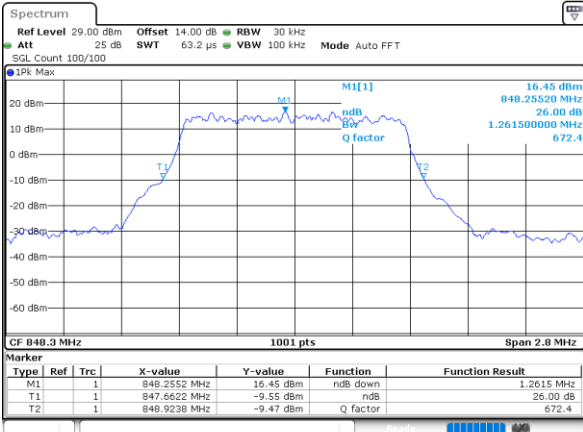

Date: 7.FEB.2021 10:11:59

Highest Channel / 1.4MHz / 16QAM

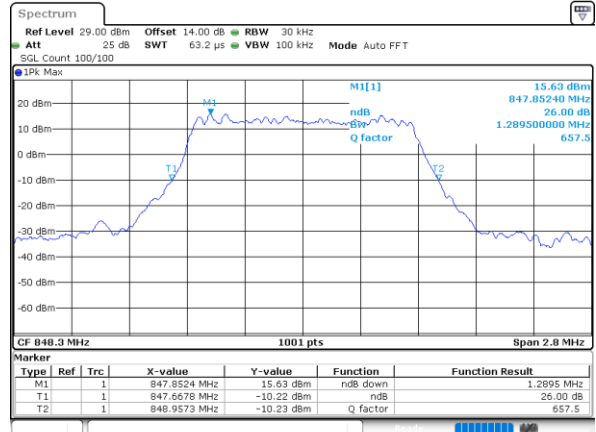

Date: 7.FEB.2021 10:26:06



LTE Band 26

Lowest Channel / 3MHz / QPSK

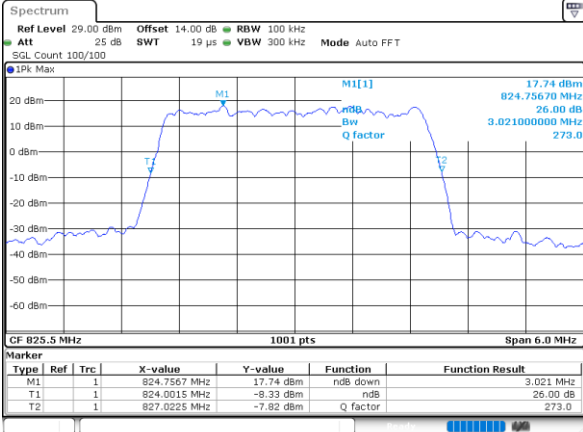

Date: 7.FEB.2021 10:53:22

Lowest Channel / 3MHz / 16QAM

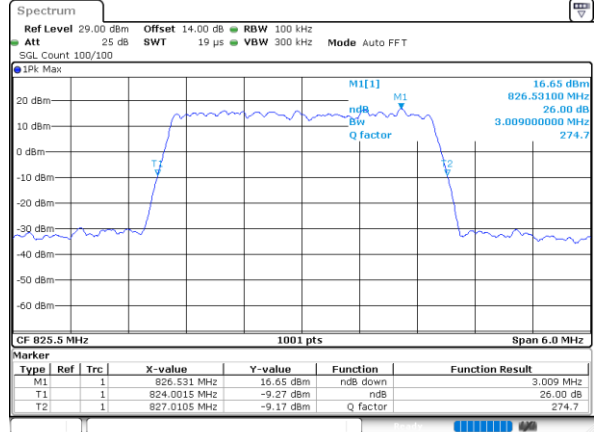

Date: 7.FEB.2021 10:53:49

Middle Channel / 3MHz / QPSK

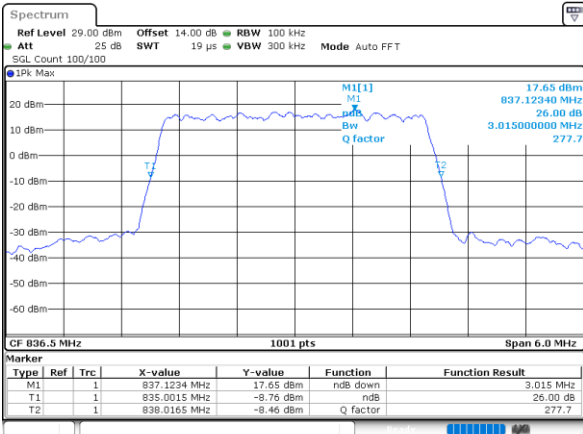

Date: 7.FEB.2021 11:09:20

Middle Channel / 3MHz / 16QAM

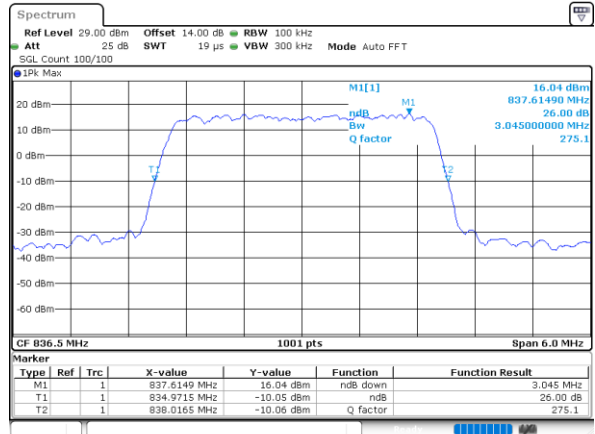

Date: 7.FEB.2021 11:08:33

Highest Channel / 3MHz / QPSK

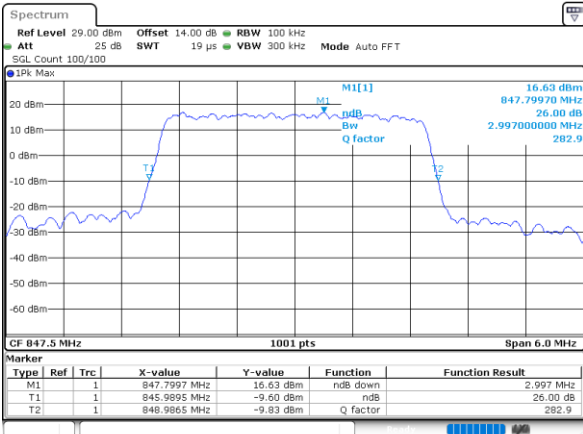

Date: 7.FEB.2021 11:10:17

Highest Channel / 3MHz / 16QAM

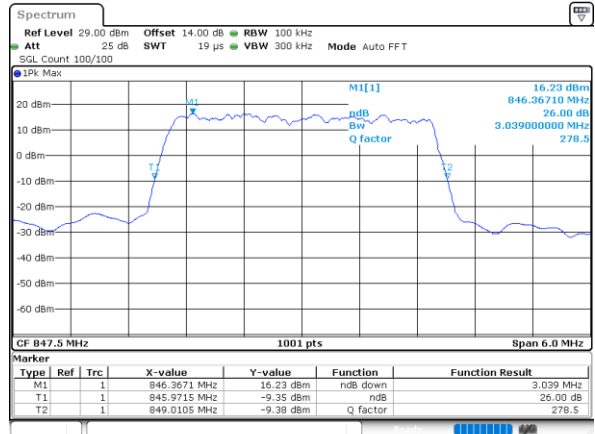

Date: 7.FEB.2021 11:12:14



LTE Band 26

Lowest Channel / 5MHz / QPSK

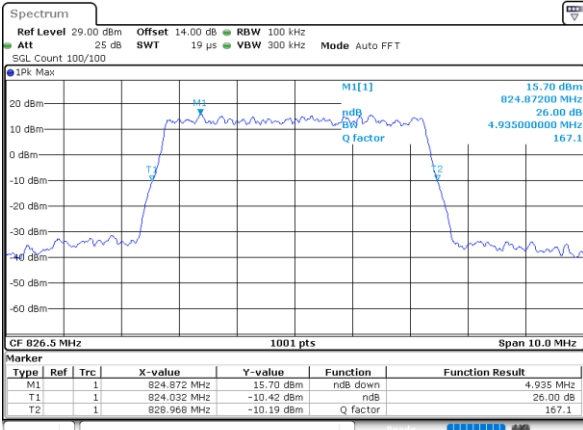

Date: 7.FEB.2021 11:38:35

Lowest Channel / 5MHz / 16QAM

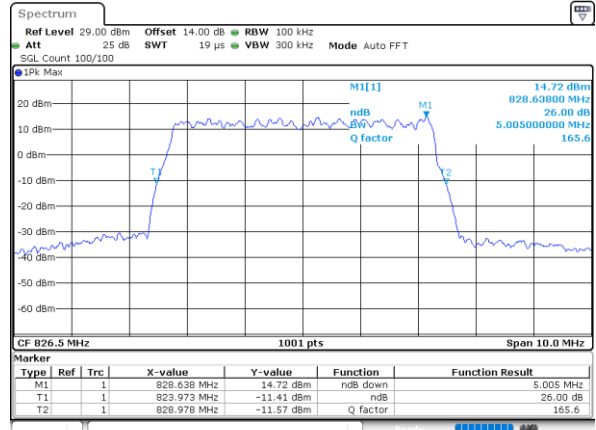

Date: 7.FEB.2021 11:37:12

Middle Channel / 5MHz / QPSK

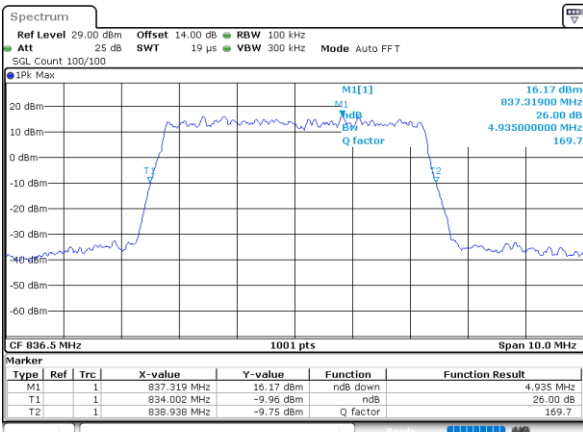

Date: 7.FEB.2021 11:40:32

Middle Channel / 5MHz / 16QAM

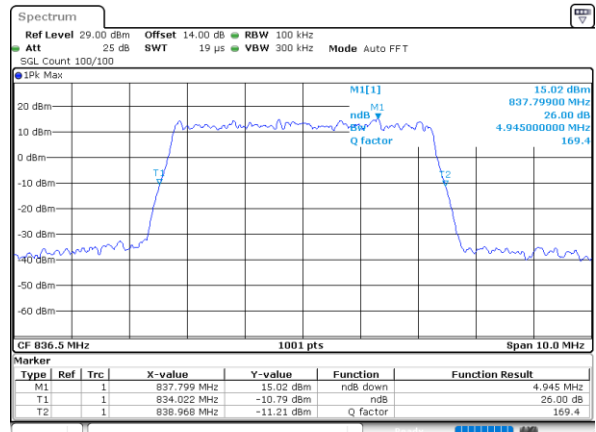

Date: 7.FEB.2021 11:41:34

Highest Channel / 5MHz / QPSK

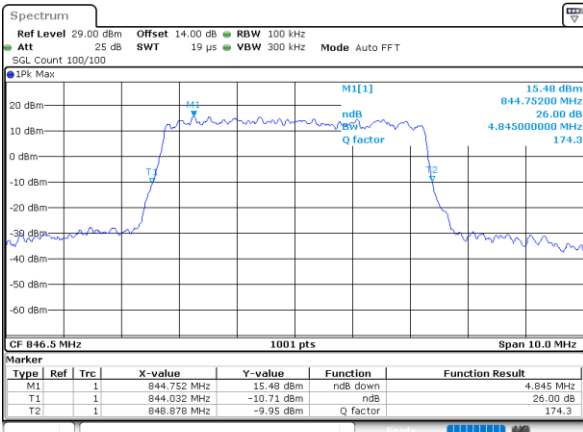

Date: 7.FEB.2021 14:23:08

Highest Channel / 5MHz / 16QAM

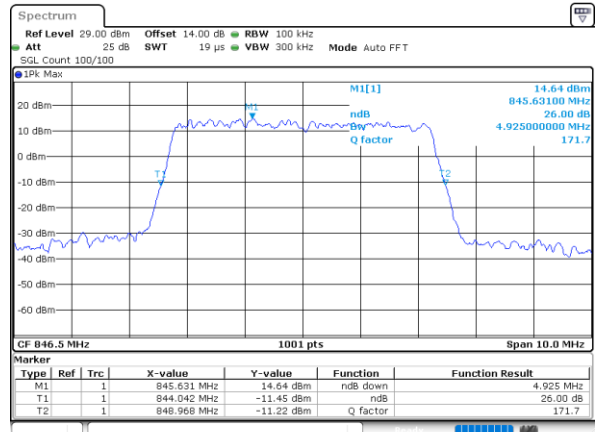

Date: 7.FEB.2021 14:21:01



LTE Band 26

Lowest Channel / 10MHz / QPSK

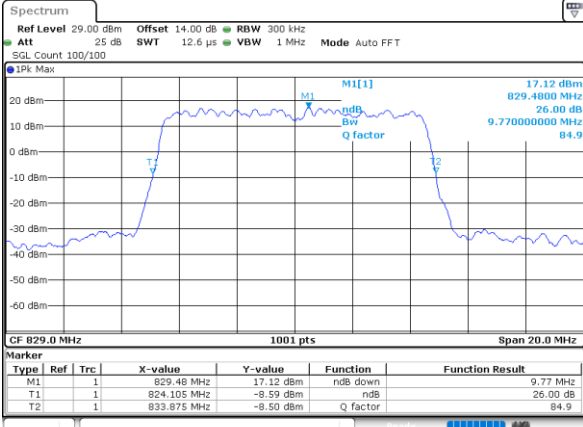

Date: 7.FEB.2021 14:26:04

Lowest Channel / 10MHz / 16QAM

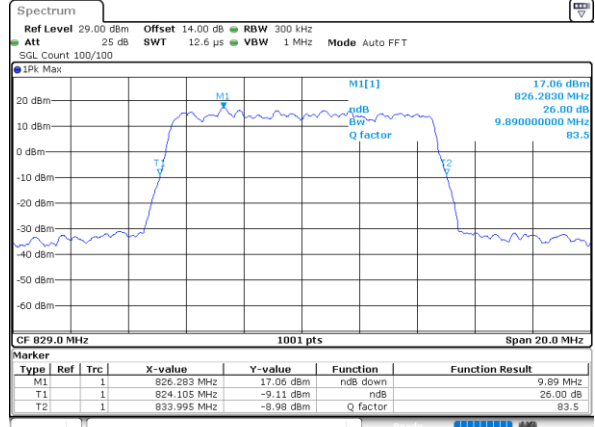

Date: 7.FEB.2021 14:30:58

Middle Channel / 10MHz / QPSK

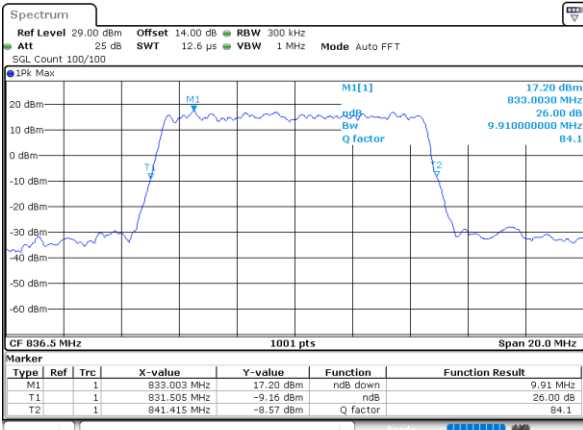

Date: 7.FEB.2021 14:46:43

Middle Channel / 10MHz / 16QAM

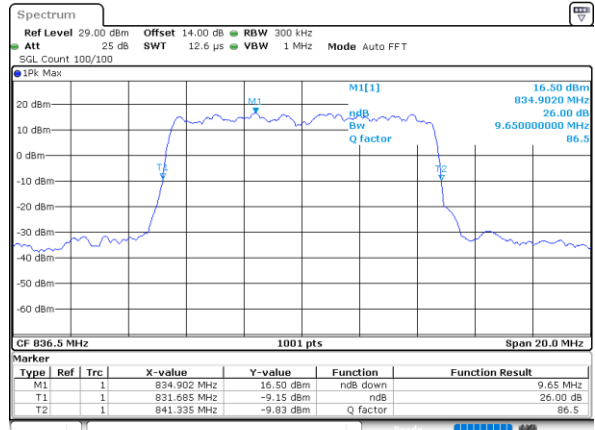

Date: 7.FEB.2021 14:46:58

Highest Channel / 10MHz / QPSK

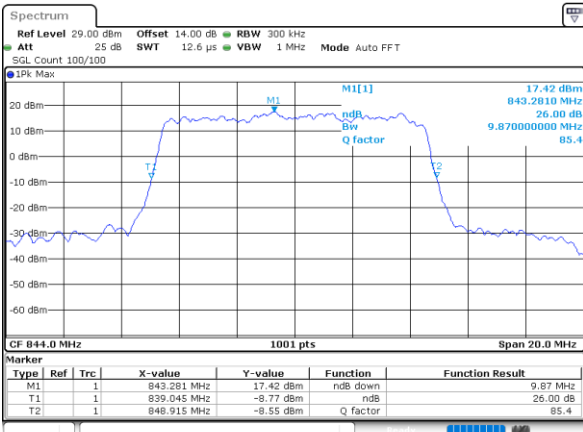

Date: 7.FEB.2021 14:49:52

Highest Channel / 10MHz / 16QAM

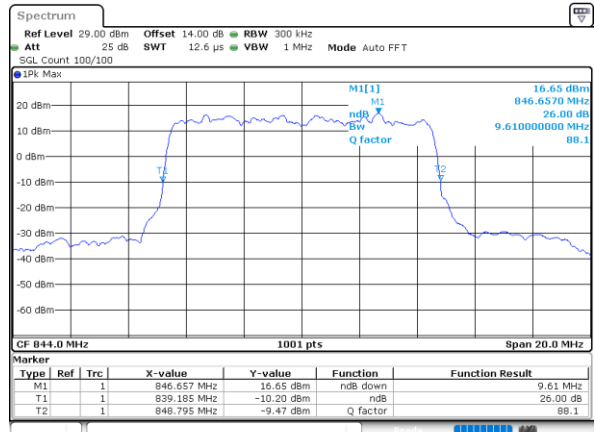

Date: 7.FEB.2021 14:52:08



LTE Band 26

Lowest Channel / 15MHz / QPSK

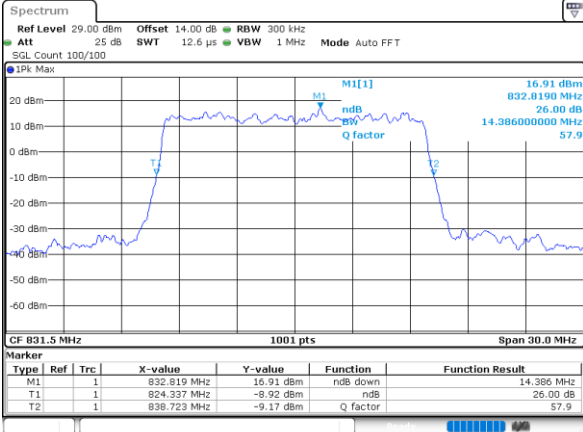

Date: 7.FEB.2021 15:41:00

Lowest Channel / 15MHz / 16QAM

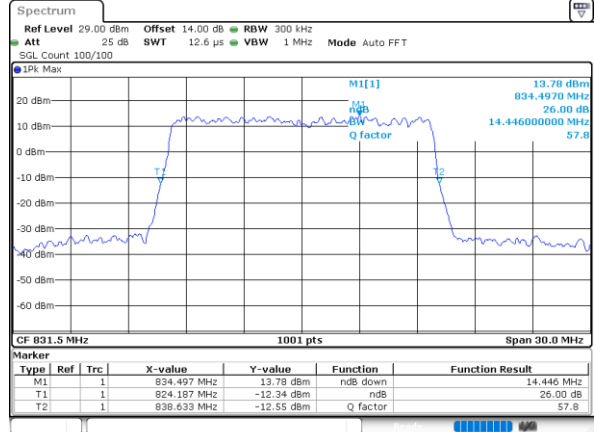

Date: 7.FEB.2021 15:38:57

Middle Channel / 15MHz / QPSK

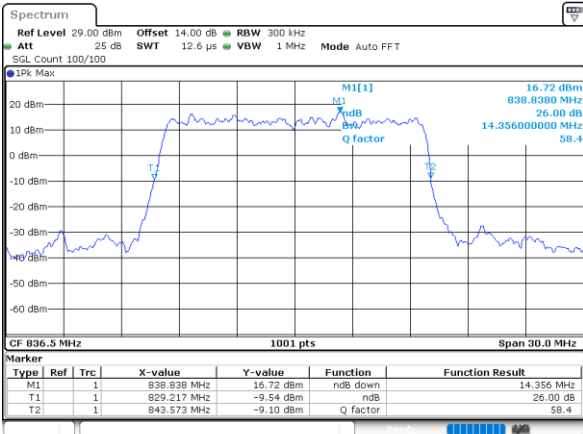

Date: 7.FEB.2021 15:42:34

Middle Channel / 15MHz / 16QAM

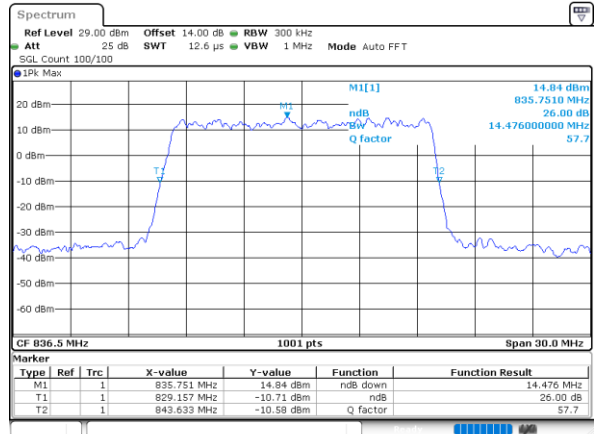

Date: 7.FEB.2021 15:43:05

Highest Channel / 15MHz / QPSK

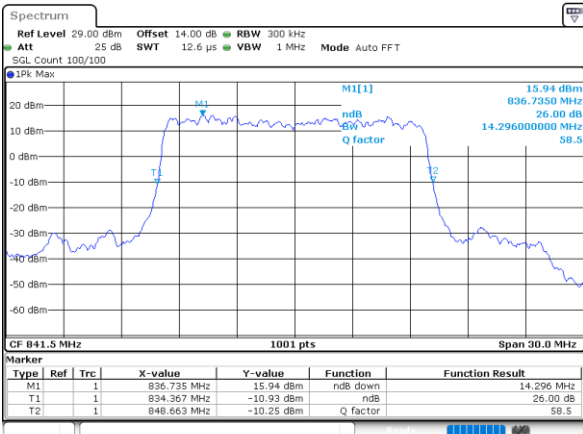

Date: 7.FEB.2021 16:00:11

Highest Channel / 15MHz / 16QAM

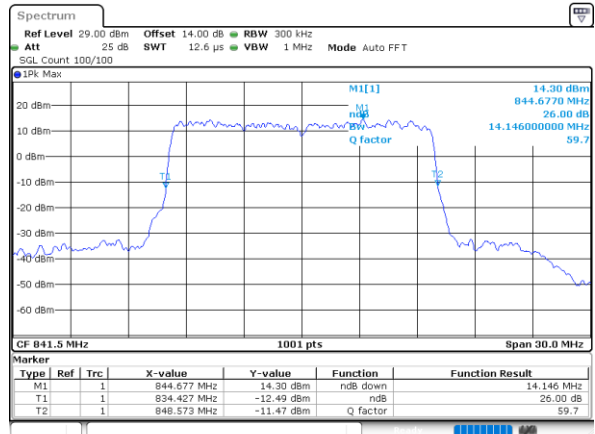

Date: 7.FEB.2021 16:02:05



LTE Band 26

Lowest Channel / 1.4MHz / 64QAM

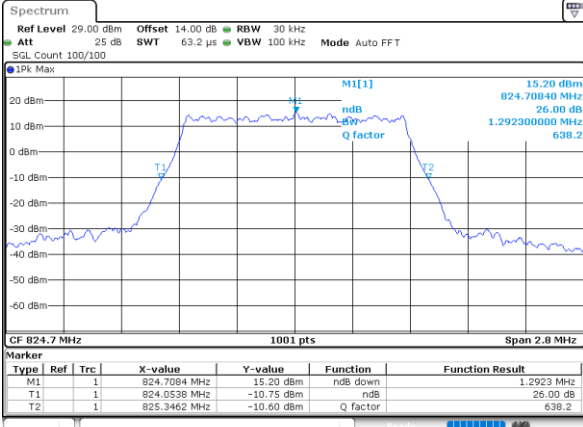

Date: 7.FEB.2021 09:42:52

Lowest Channel / 3MHz / 64QAM

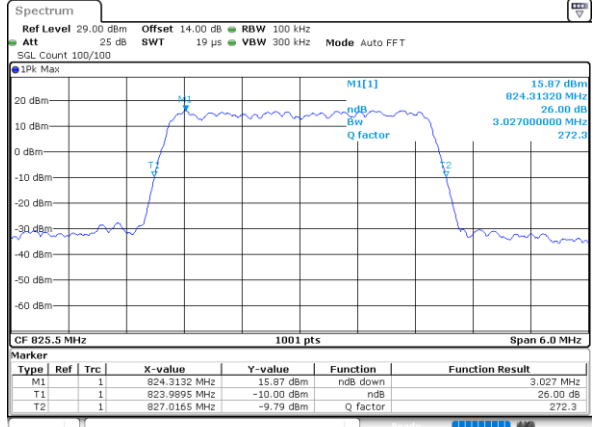

Date: 7.FEB.2021 10:55:12

Middle Channel / 1.4MHz / 64QAM

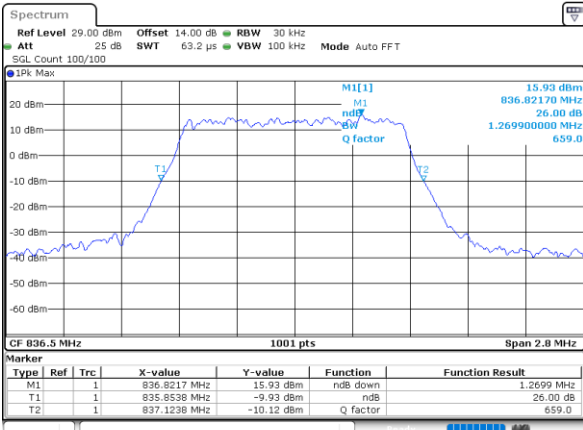

Date: 7.FEB.2021 10:09:45

Middle Channel / 3MHz / 64QAM

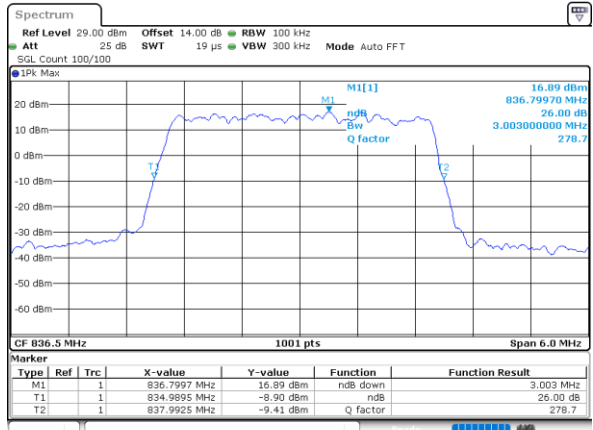

Date: 7.FEB.2021 11:08:08

Highest Channel / 1.4MHz / 64QAM

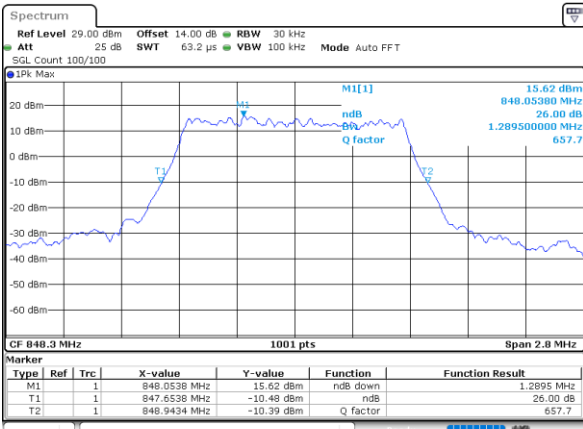

Date: 7.FEB.2021 10:27:55

Highest Channel / 3MHz / 64QAM

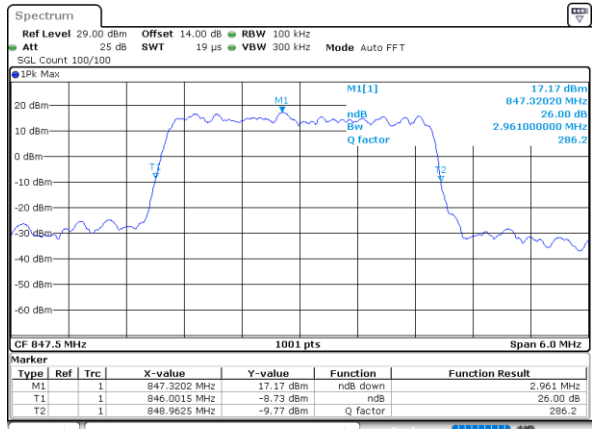

Date: 7.FEB.2021 11:13:51



LTE Band 26

Lowest Channel / 5MHz / 64QAM

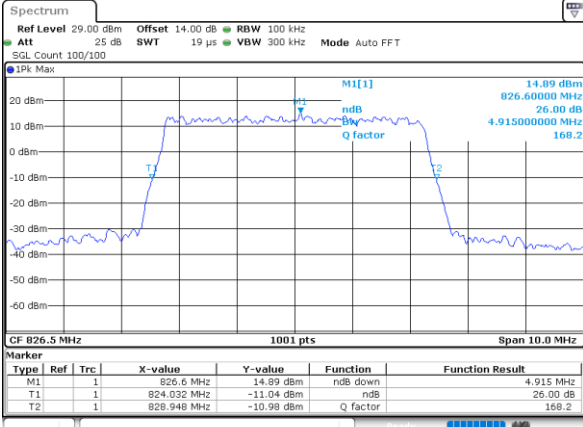

Date: 7.FEB.2021 11:35:27

Lowest Channel / 10MHz / 64QAM

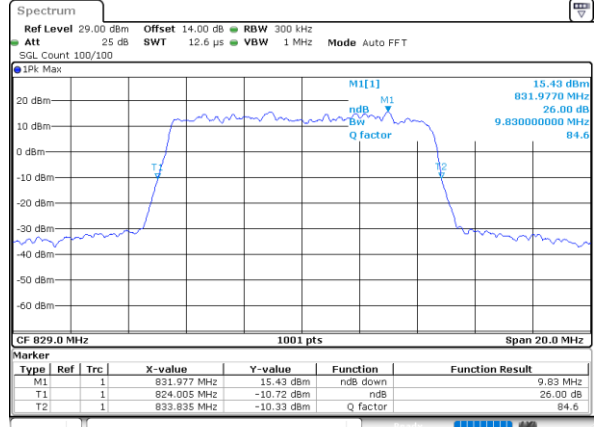

Date: 7.FEB.2021 14:32:23

Middle Channel / 5MHz / 64QAM

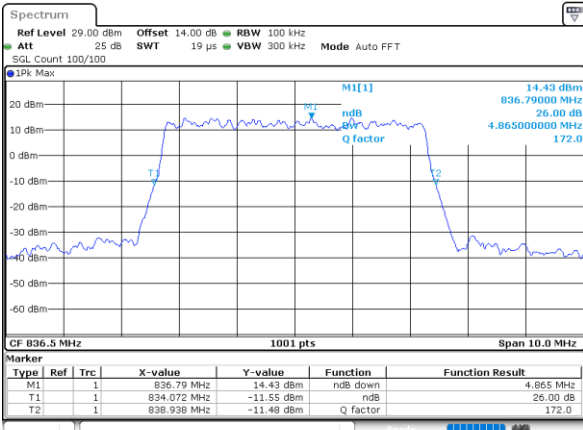

Date: 7.FEB.2021 11:43:08

Middle Channel / 10MHz / 64QAM

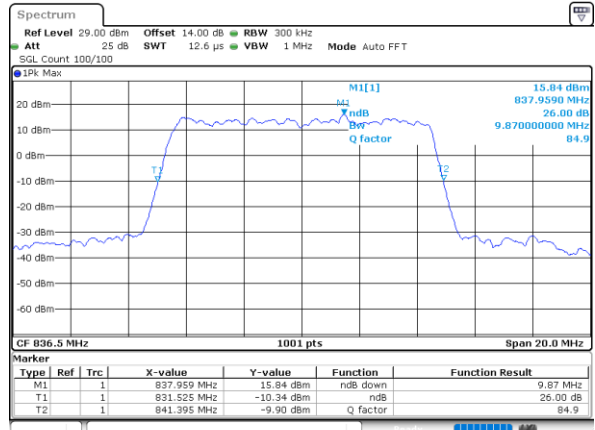

Date: 7.FEB.2021 14:47:52

Highest Channel / 5MHz / 64QAM

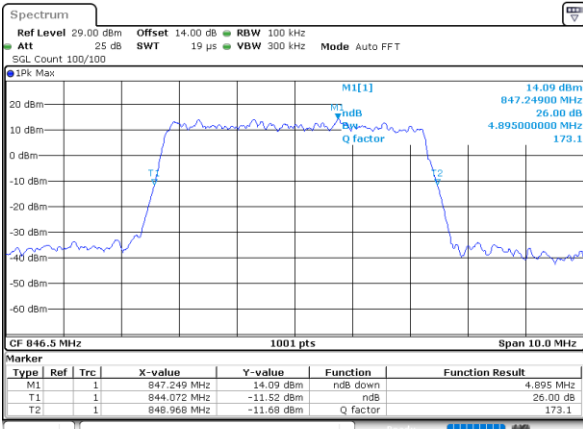

Date: 7.FEB.2021 14:11:36

Highest Channel / 10MHz / 64QAM

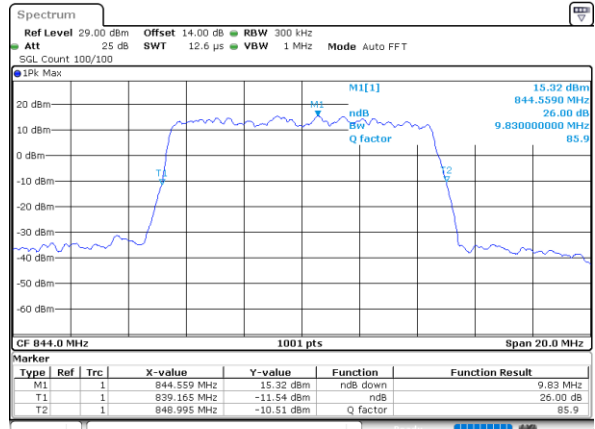

Date: 7.FEB.2021 14:54:23

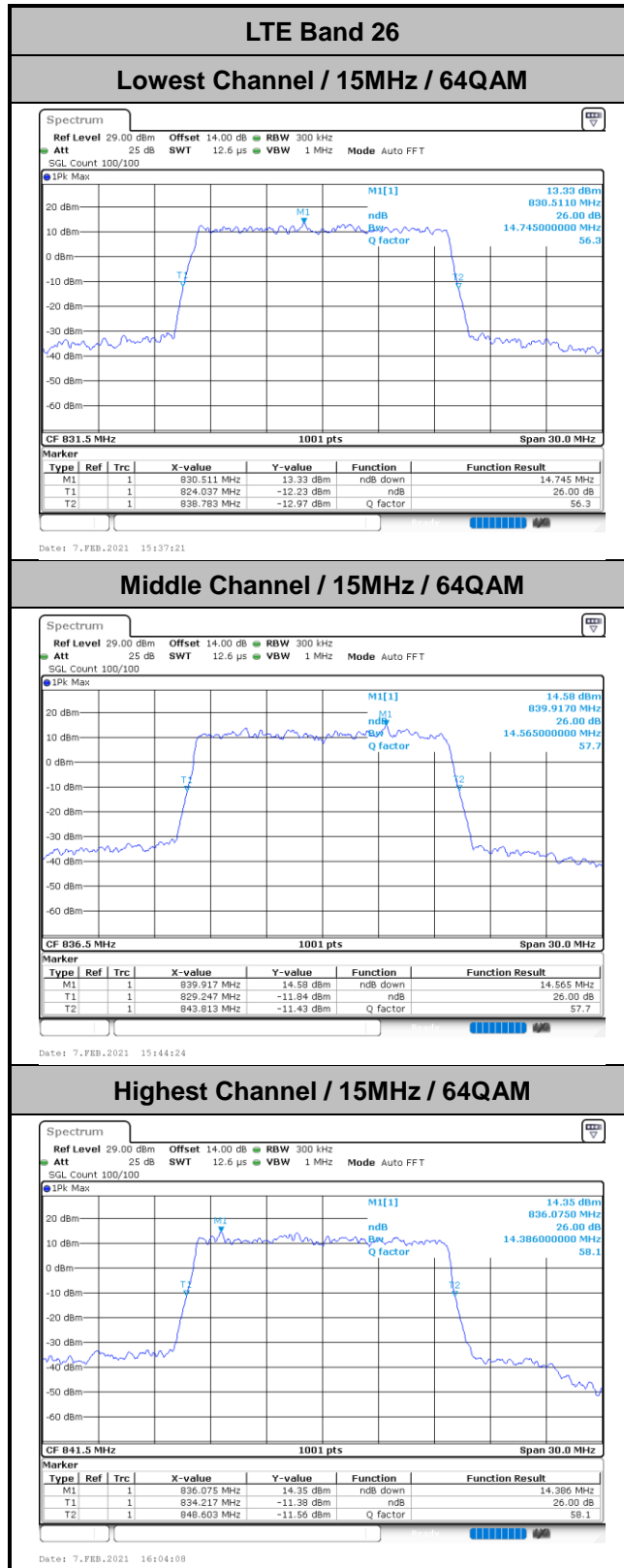



Occupied Bandwidth

Mode	LTE Band 26 : 99%OBW(MHz)											
BW	1.4MHz		3MHz		5MHz		10MHz		15MHz		CH26765	
Mod.	QPSK	16QAM	QPSK	16QAM	QPSK	16QAM	QPSK	16QAM	QPSK	16QAM	QPSK	16QAM
Lowest CH	1.10	1.09	2.70	2.70	4.49	4.51	9.03	9.01	13.43	13.52	13.46	13.49
Middle CH	1.09	1.10	2.71	2.70	4.50	4.49	9.01	8.99	13.43	13.43	-	-
Highest CH	1.10	1.10	2.72	2.71	4.50	4.50	8.97	8.95	13.43	13.46	-	-
Mode	LTE Band 26 : 99%OBW(MHz)											
BW	1.4MHz		3MHz		5MHz		10MHz		15MHz		CH26765	
Mod.	64QAM		64QAM		64QAM		64QAM		64QAM		64QAM	
Lowest CH	1.09	-	2.72	-	4.53	-	8.99	-	13.46	-	13.40	-
Middle CH	1.10	-	2.73	-	4.49	-	9.01	-	13.43	-	-	-
Highest CH	1.09	-	2.71	-	4.50	-	8.97	-	13.43	-	-	-



LTE Band 26

Lowest Channel / 1.4MHz / QPSK

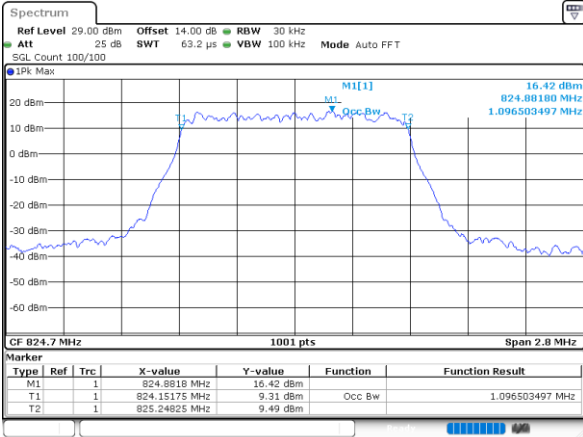

Lowest Channel / 1.4MHz / 16QAM

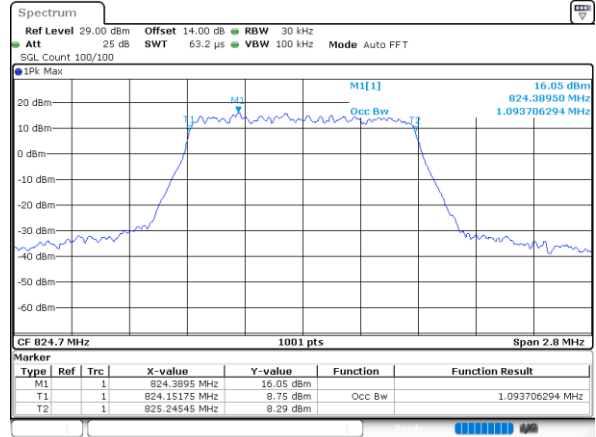

Middle Channel / 1.4MHz / QPSK

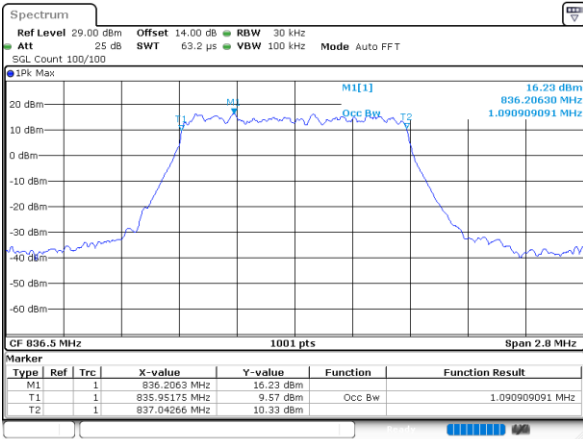

Middle Channel / 1.4MHz / 16QAM

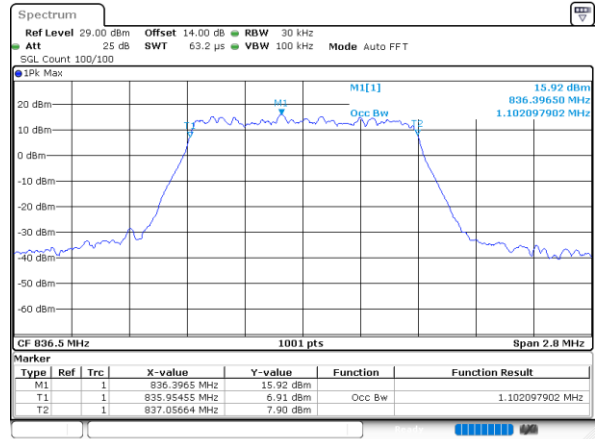

Highest Channel / 1.4MHz / QPSK

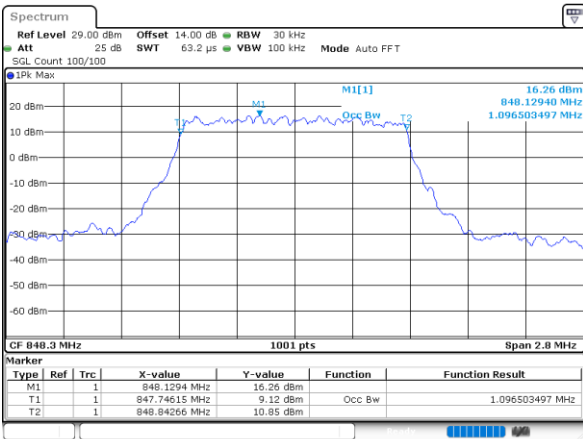

Highest Channel / 1.4MHz / 16QAM

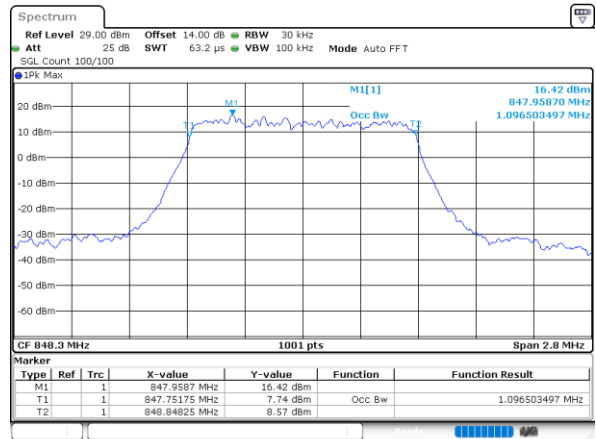



LTE Band 26

Lowest Channel / 3MHz / QPSK

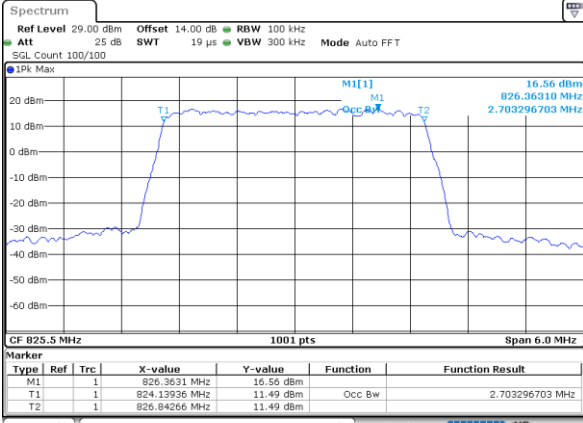

Date: 7.FEB.2021 10:53:13

Lowest Channel / 3MHz / 16QAM

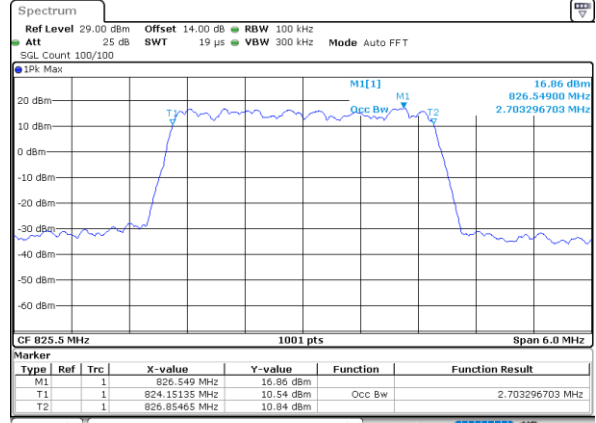

Date: 7.FEB.2021 10:53:35

Middle Channel / 3MHz / QPSK

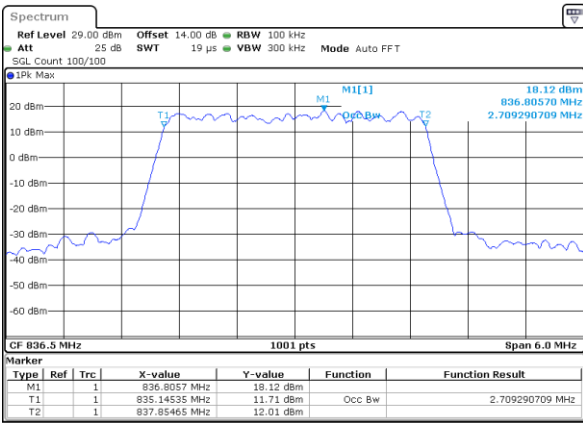

Date: 7.FEB.2021 11:09:02

Middle Channel / 3MHz / 16QAM

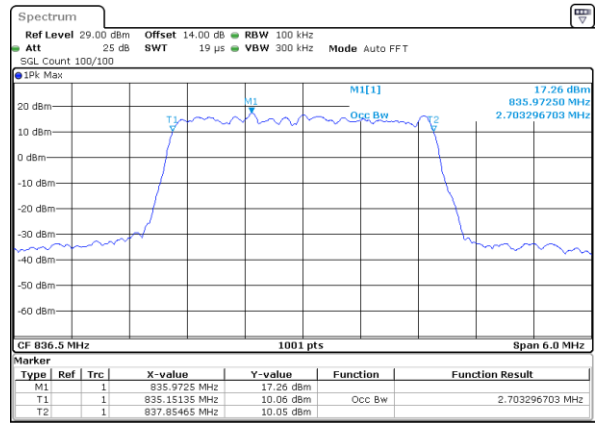

Date: 7.FEB.2021 11:08:20

Highest Channel / 3MHz / QPSK

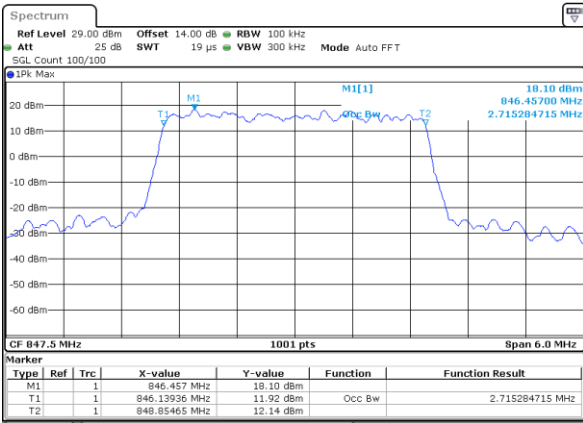

Date: 7.FEB.2021 11:10:04

Highest Channel / 3MHz / 16QAM

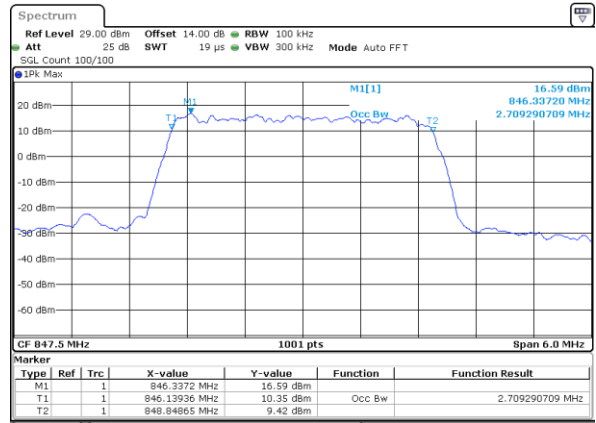

Date: 7.FEB.2021 11:16:12



LTE Band 26

Lowest Channel / 5MHz / QPSK

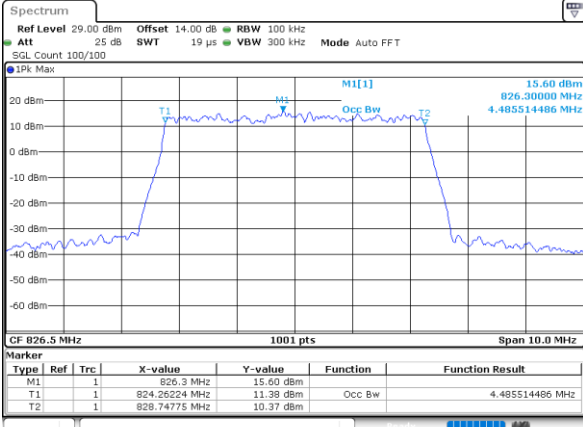

Date: 7.FEB.2021 11:38:25

Lowest Channel / 5MHz / 16QAM

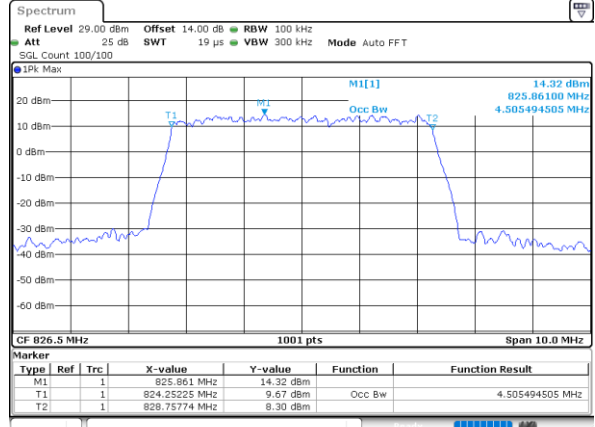

Date: 7.FEB.2021 11:36:52

Middle Channel / 5MHz / QPSK

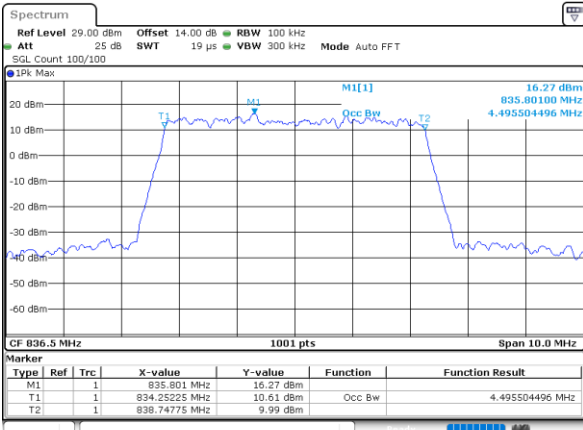

Date: 7.FEB.2021 11:40:06

Middle Channel / 5MHz / 16QAM

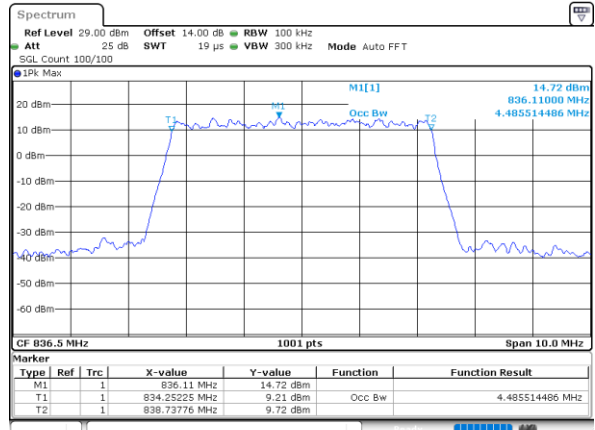

Date: 7.FEB.2021 11:41:04

Highest Channel / 5MHz / QPSK

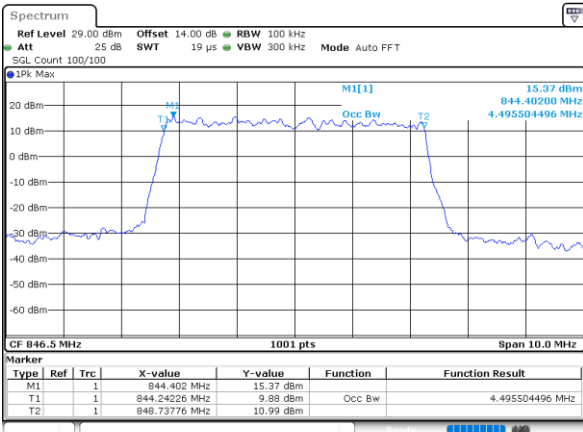

Date: 7.FEB.2021 14:22:17

Highest Channel / 5MHz / 16QAM

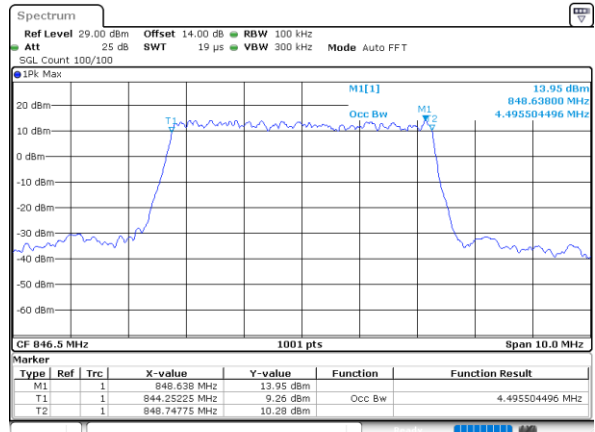

Date: 7.FEB.2021 14:20:50



LTE Band 26

Lowest Channel / 10MHz / QPSK

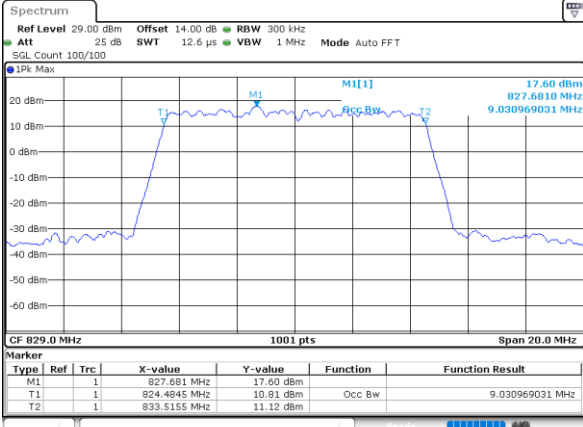

Date: 7.FEB.2021 14:25:18

Lowest Channel / 10MHz / 16QAM

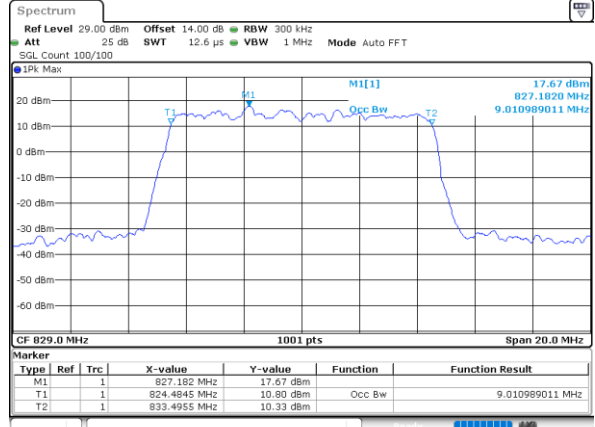

Date: 7.FEB.2021 14:29:55

Middle Channel / 10MHz / QPSK

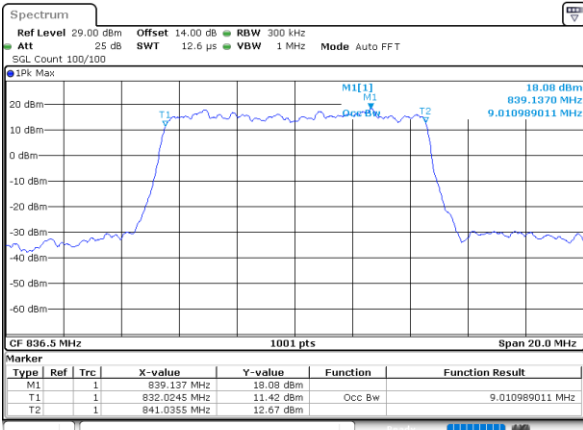

Date: 7.FEB.2021 14:48:33

Middle Channel / 10MHz / 16QAM

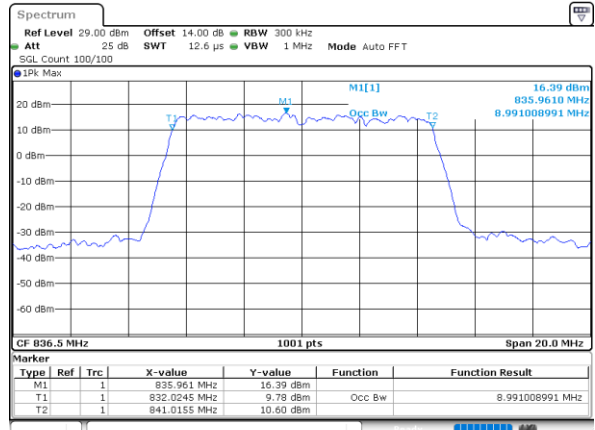

Date: 7.FEB.2021 14:46:48

Highest Channel / 10MHz / QPSK

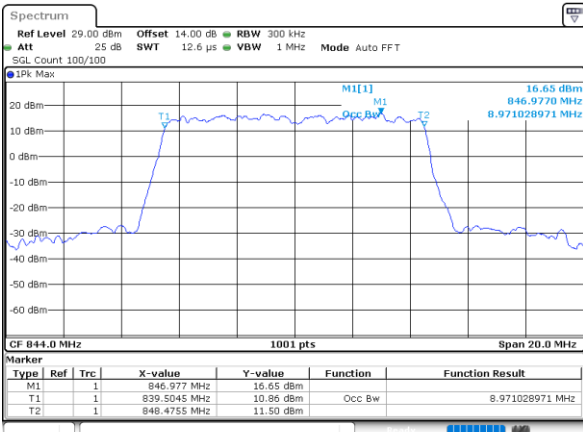

Date: 7.FEB.2021 14:49:37

Highest Channel / 10MHz / 16QAM

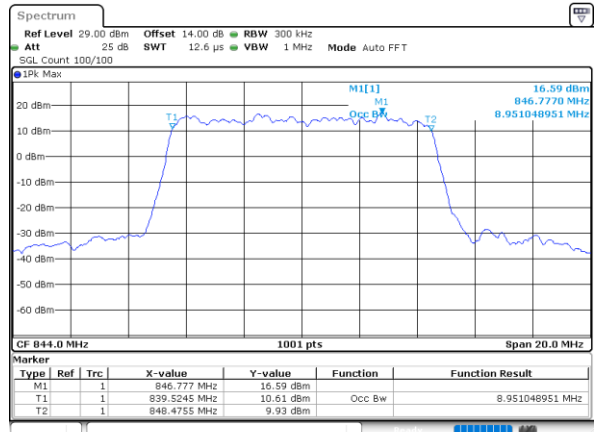

Date: 7.FEB.2021 14:51:37



LTE Band 26

Lowest Channel / 15MHz / QPSK

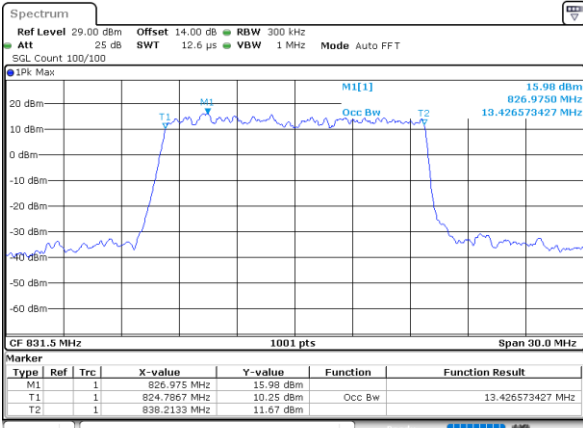

Date: 7.FEB.2021 15:40:00

Lowest Channel / 15MHz / 16QAM

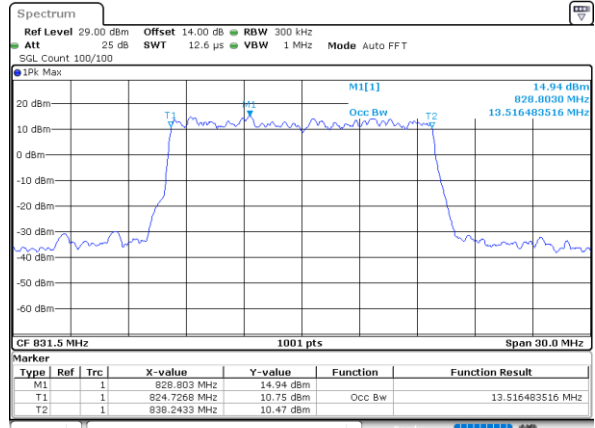

Date: 7.FEB.2021 15:38:23

Middle Channel / 15MHz / QPSK

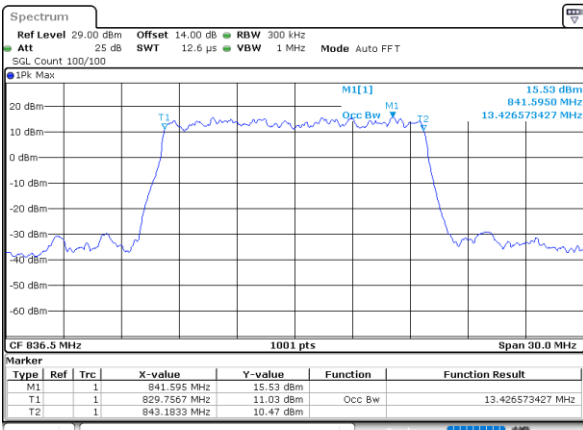

Date: 7.FEB.2021 15:42:21

Middle Channel / 15MHz / 16QAM

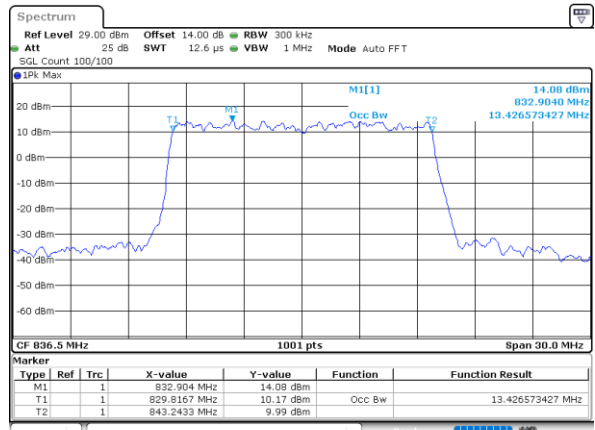

Date: 7.FEB.2021 15:42:53

Highest Channel / 15MHz / QPSK

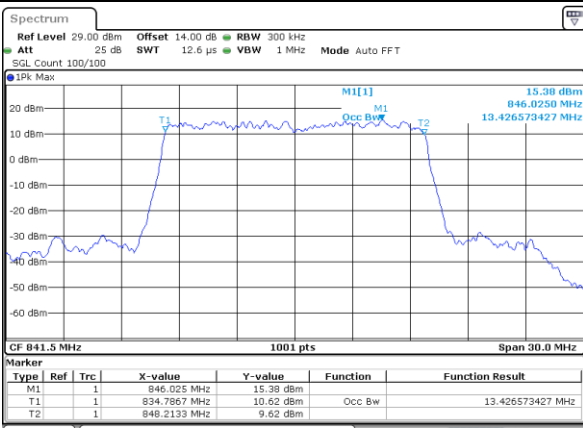

Date: 7.FEB.2021 15:59:38

Highest Channel / 15MHz / 16QAM

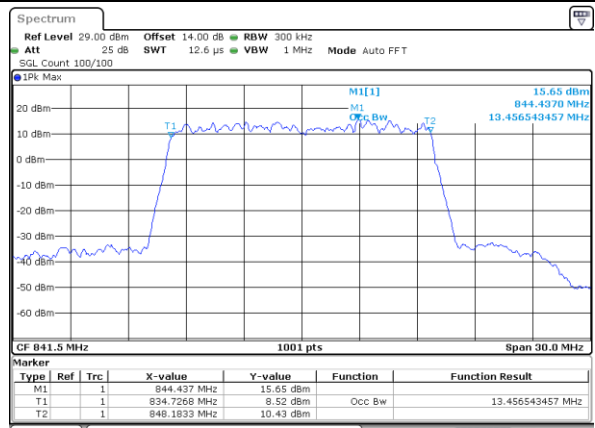

Date: 7.FEB.2021 16:01:48



LTE Band 26

Lowest Channel / 1.4MHz / 64QAM

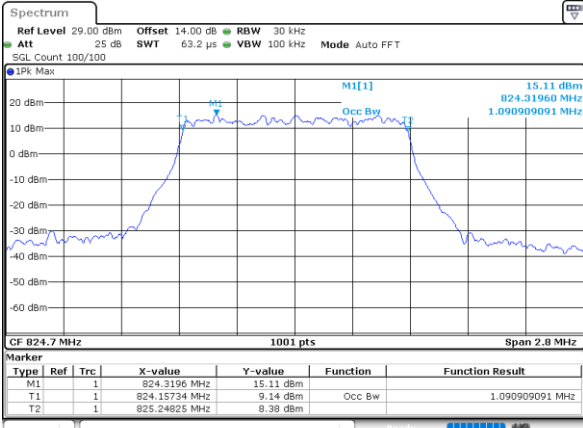

Date: 7.FEB.2021 09:42:14

Lowest Channel / 3MHz / 64QAM

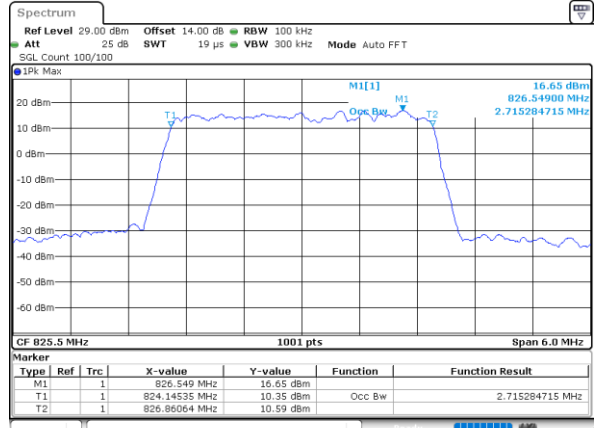

Date: 7.FEB.2021 10:55:02

Middle Channel / 1.4MHz / 64QAM

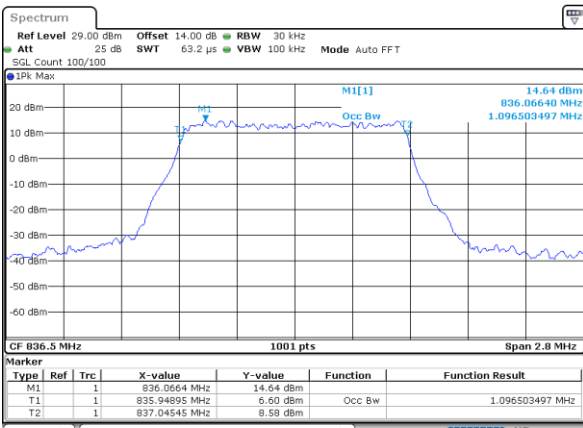

Date: 7.FEB.2021 10:09:21

Middle Channel / 3MHz / 64QAM

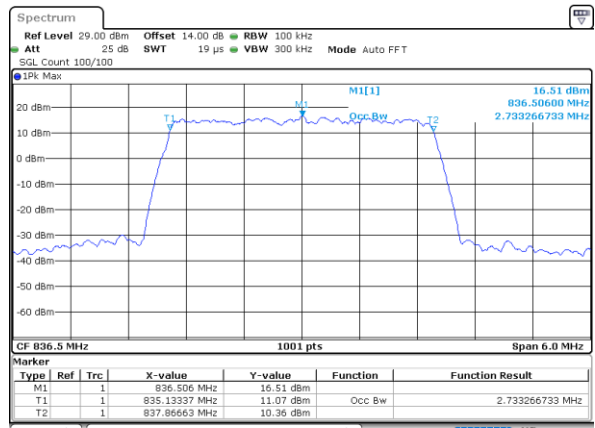

Date: 7.FEB.2021 11:07:53

Highest Channel / 1.4MHz / 64QAM

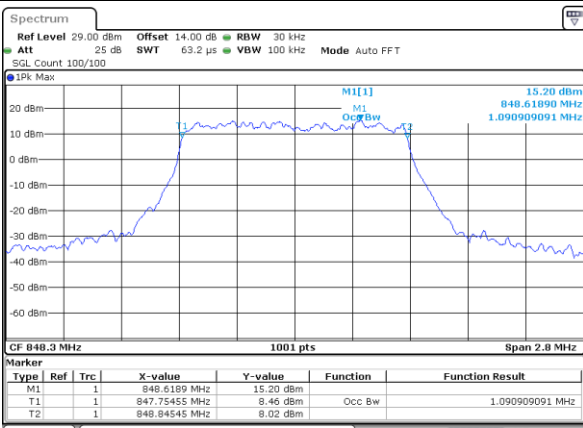

Date: 7.FEB.2021 10:27:44

Highest Channel / 3MHz / 64QAM

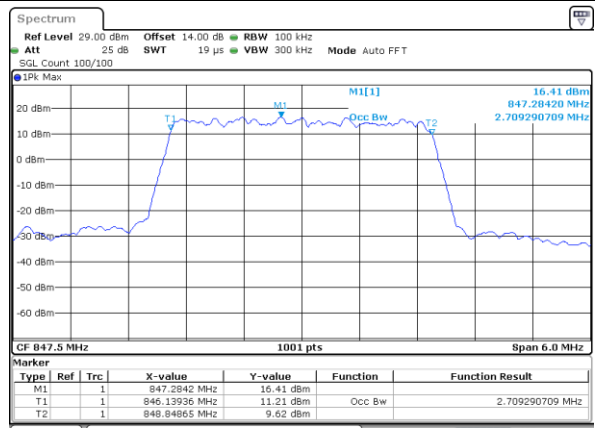

Date: 7.FEB.2021 11:13:35



LTE Band 26

Lowest Channel / 5MHz / 64QAM

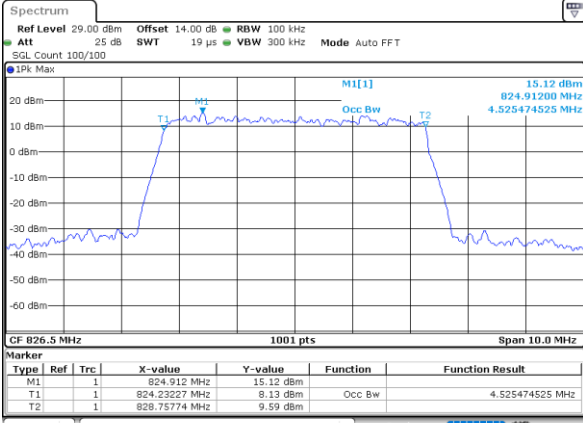

Date: 7.FEB.2021 11:35:09

Lowest Channel / 10MHz / 64QAM

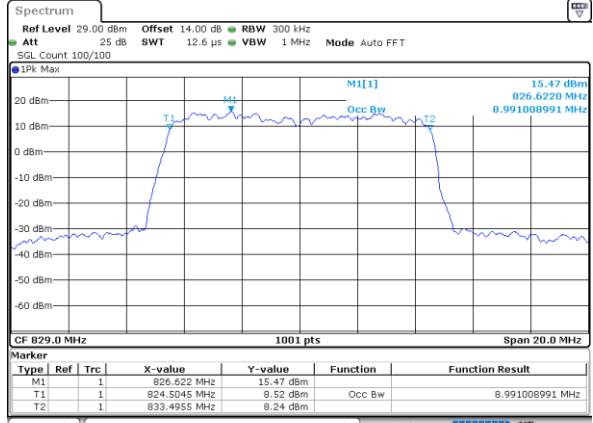

Date: 7.FEB.2021 14:32:12

Middle Channel / 5MHz / 64QAM

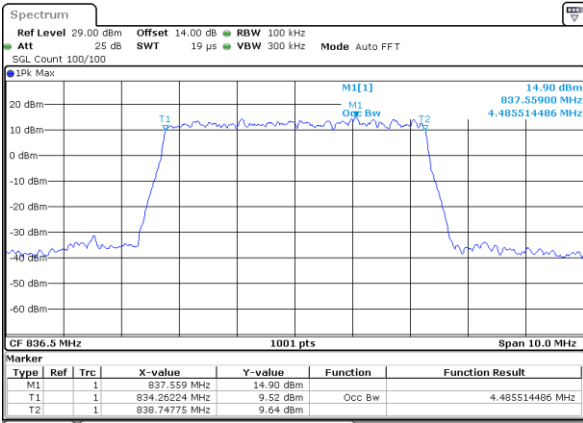

Date: 7.FEB.2021 11:42:45

Middle Channel / 10MHz / 64QAM

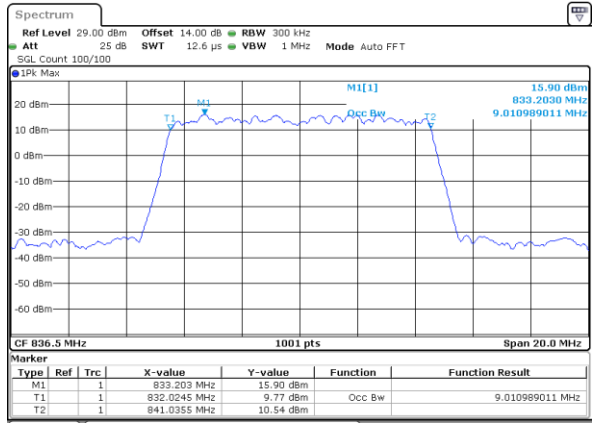

Date: 7.FEB.2021 14:47:35

Highest Channel / 5MHz / 64QAM

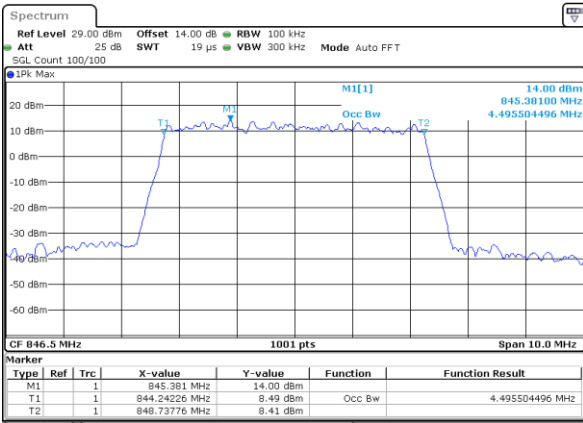

Date: 7.FEB.2021 14:19:27

Highest Channel / 10MHz / 64QAM

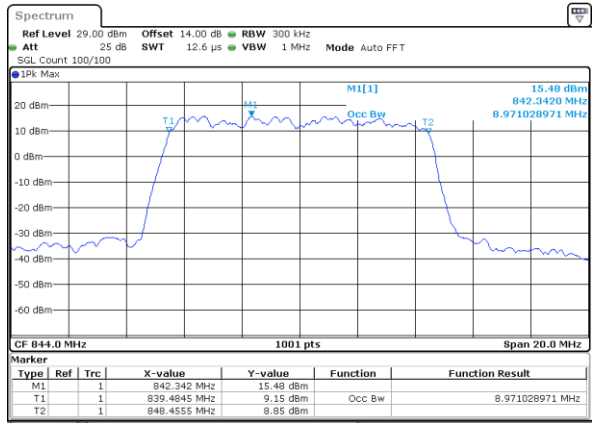

Date: 7.FEB.2021 14:53:55



LTE Band 26

Lowest Channel / 15MHz / 64QAM

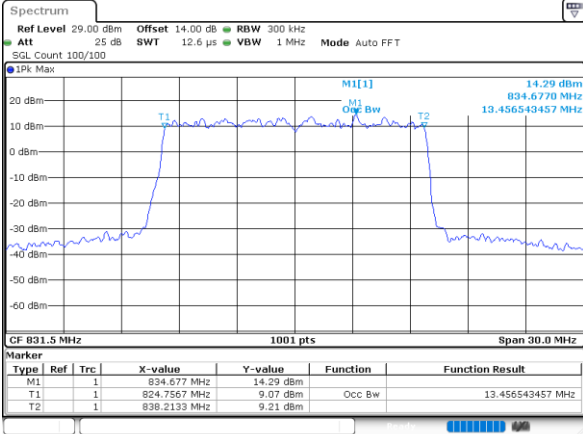

Date: 7.FEB.2021 15:36:47

Lowest Channel / CH26765 / QPSK

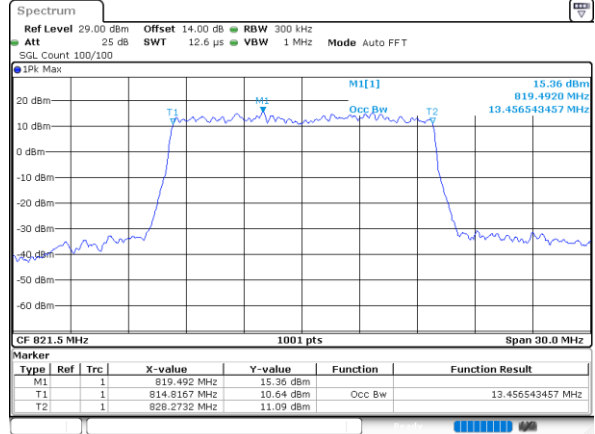

Date: 8.FEB.2021 09:14:22

Middle Channel / 15MHz / 64QAM

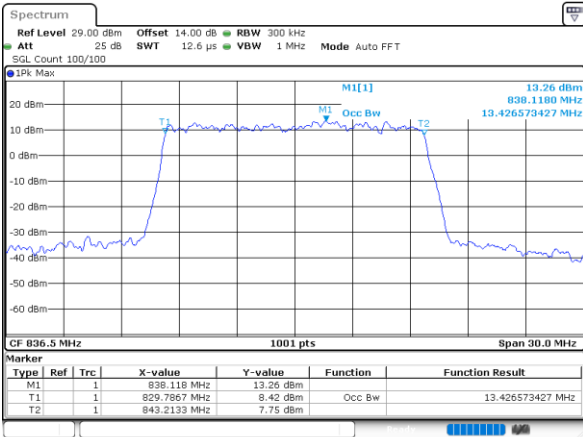

Date: 7.FEB.2021 15:43:47

Lowest Channel / CH26765 / 16QAM

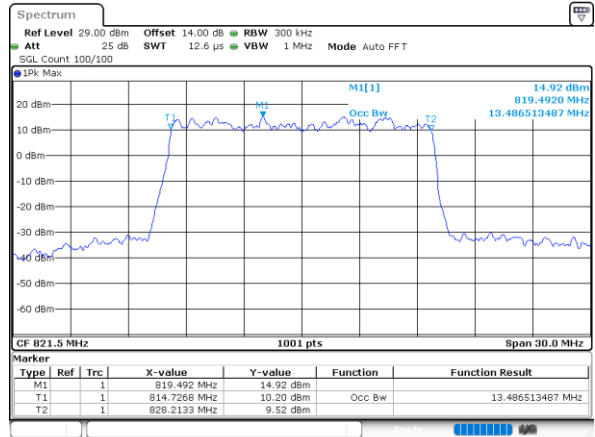

Date: 8.FEB.2021 09:14:32

Highest Channel / 15MHz / 64QAM

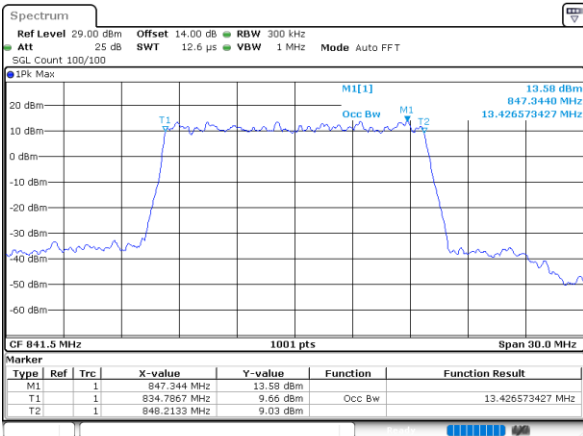

Date: 7.FEB.2021 16:03:45

Lowest Channel / CH26765 / 64QAM

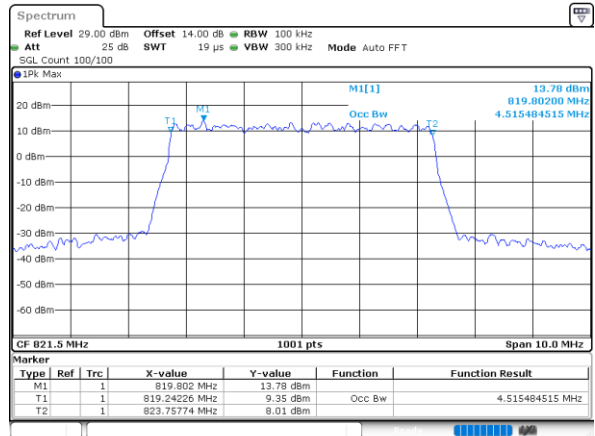

Date: 8.FEB.2021 08:47:11