



FCC RF Test Report

APPLICANT : Bullitt Group
EQUIPMENT : Smartphone
BRAND NAME : KODAK
MODEL NAME : EKTRA
MARKETING NAME : KODAK EKTRA Smartphone
FCC ID : ZL5EKTRA
STANDARD : FCC Part 15 Subpart C §15.247
CLASSIFICATION : (DSS) Spread Spectrum Transmitter

The product was received on Mar. 07, 2017 and testing was completed on Apr. 13, 2017. We, Sporton International (KunShan) INC., would like to declare that the tested sample has been evaluated in accordance with the test procedures and has been in compliance with the applicable technical standards.

The test results in this report apply exclusively to the tested model / sample. Without written approval of Sporton International (KunShan) INC., the test report shall not be reproduced except in full.

Prepared by: James Huang / Manager

Approved by: Jones Tsai / Manager



Sporton International (KunShan) INC.
No.3-2, Pingxiang Road, Kunshan Development Zone, Jiangsu, China



TABLE OF CONTENTS

1 GENERAL DESCRIPTION..... 5

1.1 Applicant 5

1.2 Manufacturer..... 5

1.3 Product Feature of Equipment Under Test..... 5

1.4 Product Specification of Equipment Under Test..... 6

1.5 Modification of EUT 6

1.6 Testing Location 7

1.7 Applicable Standards..... 7

2 TEST CONFIGURATION OF EQUIPMENT UNDER TEST..... 8

2.1 Descriptions of Test Mode 8

2.2 Test Mode..... 9

2.3 Connection Diagram of Test System..... 10

2.4 Support Unit used in test configuration and system 11

2.5 EUT Operation Test Setup 11

2.6 Measurement Results Explanation Example..... 12

3 TEST RESULT 13

3.1 Number of Channel Measurement 13

3.2 Hopping Channel Separation Measurement 15

3.3 Dwell Time Measurement..... 22

3.4 20dB and 99% Bandwidth Measurement 25

3.5 Peak Output Power Measurement 38

3.6 Conducted Band Edges Measurement..... 40

3.7 Conducted Spurious Emission Measurement 47

3.8 Radiated Band Edges and Spurious Emission Measurement 57

3.9 AC Conducted Emission Measurement..... 63

3.10 Antenna Requirements..... 67

4 LIST OF MEASURING EQUIPMENT..... 68

5 UNCERTAINTY OF EVALUATION..... 69

APPENDIX A. RADIATED SPURIOUS EMISSION

APPENDIX B. SETUP PHOTOGRAPHS



SUMMARY OF TEST RESULT

Report Section	FCC Rule	IC Rule	Description	Limit	Result	Remark
3.1	15.247(a)(1)	RSS-247 5.1(d)	Number of Channels	≥ 15Chs	Pass	-
3.2	15.247(a)(1)	RSS-247 5.1(b)	Hopping Channel Separation	≥ 2/3 of 20dB BW	Pass	-
3.3	15.247(a)(1)	RSS-247 5.1(d)	Dwell Time of Each Channel	≤ 0.4sec in 31.6sec period	Pass	-
3.4	15.247(a)(1)	RSS-247 5.1(a)	20dB Bandwidth	NA	Pass	-
3.4	-	RSS-Gen 6.6	99% Bandwidth	-	Pass	-
3.5	15.247(b)(1)	RSS-247 5.4(b)	Peak Output Power	≤ 125 mW	Pass	-
3.6	15.247(d)	RSS-247 5.5	Conducted Band Edges	≤ 20dBc	Pass	-
3.7	15.247(d)	RSS-247 5.5	Conducted Spurious Emission	≤ 20dBc	Pass	-
3.8	15.247(d)	RSS-247 5.5	Radiated Band Edges and Radiated Spurious Emission	15.209(a) & 15.247(d)	Pass	Under limit 7.02 dB at 202.660 MHz
3.9	15.207	RSS-Gen 8.8	AC Conducted Emission	15.207(a)	Pass	Under limit 7.68 dB at 0.567 MHz
3.10	15.203 & 15.247(b)	N/A	Antenna Requirement	N/A	Pass	-



1 General Description

1.1 Applicant

Bullitt Group

One Valpy, Valpy Street, Reading, Berkshire, RG1 1AR, UK

1.2 Manufacturer

Shanghai Sunrise Simcom Limited

No. 888, Shengli Rd., Qingpu, Shanghai, P.R.China 201700

1.3 Product Feature of Equipment Under Test

Product Feature	
Equipment	Smartphone
Brand Name	KODAK
Model Name	EKTRA
Marketing Name	KODAK EKTRA Smartphone
FCC ID	ZL5EKTRA
EUT supports Radios application	GSM/GPRS/EGPRS/WCDMA/HSPA/ DC-HSDPA/HSPA+/LTE/NFC WLAN 2.4GHz 802.11b/g/n TH20/HT40 WLAN 5GHz 802.11a/n HT20/HT40 WLAN 5GHz 802.11ac VHT20/VHT40/VHT80 Bluetooth v3.0 + EDR/Bluetooth v4.0 LE/Bluetooth v4.1 LE
IMEI Code	Conducted: 357682080001005 Radiation: N/A Conduction: 357682080000874
EUT Stage	Identical Prototype

Remark: The above EUT's information was declared by manufacturer. Please refer to the specifications or user's manual for more detailed description.



1.4 Product Specification of Equipment Under Test

Standards-related Product Specification	
Tx/Rx Frequency Range	2402 MHz ~ 2480 MHz
Number of Channels	79
Carrier Frequency of Each Channel	2402+n*1 MHz; n=0~78
Maximum Output Power to Antenna	Bluetooth BR(1Mbps) : 7.29 dBm (0.0054 W) Bluetooth EDR (2Mbps) : 7.11 dBm (0.0051 W) Bluetooth EDR (3Mbps) : 7.24 dBm (0.0053 W)
99% Occupied Bandwidth	Bluetooth BR(1Mbps) : 0.900MHz Bluetooth EDR (2Mbps) : 1.164MHz Bluetooth EDR (3Mbps) : 1.152MHz
Antenna Type / Gain	PIFA Antenna with gain -0.12 dBi
Type of Modulation	Bluetooth BR (1Mbps) : GFSK Bluetooth EDR (2Mbps) : $\pi/4$ -DQPSK Bluetooth EDR (3Mbps) : 8-DPSK

1.5 Modification of EUT

No modifications are made to the EUT during all test items.



1.6 Testing Location

Test Site	Sporton International (KunShan) INC.	
Test Site Location	No.3-2, Pingxiang Road, Kunshan Development Zone, Jiangsu, China TEL: +86-0512-5790-0158 FAX: +86-0512-5790-0958	
Test Site No.	Sporton Site No.	
	TH01-KS	CO01-KS

Test Site	SPORTON International (ShenZhen) INC.	
Test Site Location	No. 3 Building, the third floor of south, Shahe River west, Fengzeyuan warehouse, Nanshan District, Shenzhen, Guangdong, P. R. China TEL: +86-755- 3320-2398	
Test Site No.	Sporton Site No.	FCC/IC Registration No.
	03CH03-SZ	565805/4086F

Note: The test site complies with ANSI C63.4 2014 requirement.

1.7 Applicable Standards

According to the specifications of the manufacturer, the EUT must comply with the requirements of the following standards:

- ♦ FCC Part 15 Subpart C §15.247
- ♦ ANSI C63.10-2013
- ♦ IC RSS-247 Issue 2
- ♦ IC RSS-Gen Issue 4

Remark:

1. All test items were verified and recorded according to the standards and without any deviation during the test.
2. This EUT has also been tested and complied with the requirements of FCC Part 15, Subpart B, recorded in a separate test report.



2 Test Configuration of Equipment Under Test

2.1 Descriptions of Test Mode

Preliminary tests were performed in different data rates and recorded the RF output power in the following table:

Channel	Frequency	Bluetooth RF Output Power		
		Data Rate / Modulation		
		GFSK	$\pi/4$ -DQPSK	8-DPSK
		1Mbps	2Mbps	3Mbps
Ch00	2402MHz	6.77 dBm	6.53 dBm	6.64 dBm
Ch39	2441MHz	7.29 dBm	7.11 dBm	7.24 dBm
Ch78	2480MHz	6.68 dBm	6.51 dBm	6.67 dBm

Remark:

1. All the test data for each data rate were verified, but only the worst case was reported.
 2. The data rate was set in 1Mbps for all the test items due to the highest RF output power.
- a. The EUT has been associated with peripherals and configuration operated in a manner tended to maximize its emission characteristics in a typical application. Frequency range investigated: conduction (150 kHz to 30 MHz), radiation (9 kHz to the 10th harmonic of the highest fundamental frequency or to 40 GHz, whichever is lower). Pre-scanned tests, X, Y, Z in three orthogonal panels, and different data rates were conducted to determine the final configuration (X plane as worst plane) from all possible combinations, and the worst mode of radiated spurious emissions is Bluetooth 1Mbps mode, and recorded in this report.
 - b. AC power line Conducted Emission was tested under maximum output power.



2.2 Test Mode

The following summary table is showing all test modes to demonstrate in compliance with the standard.

Summary table of Test Cases			
Test Item	Data Rate / Modulation		
	Bluetooth BR 1Mbps GFSK	Bluetooth EDR 2Mbps $\pi/4$ -DQPSK	Bluetooth EDR 3Mbps 8-DPSK
Conducted Test Cases	Mode 1: CH00_2402 MHz Mode 2: CH39_2441 MHz Mode 3: CH78_2480 MHz	Mode 4: CH00_2402 MHz Mode 5: CH39_2441 MHz Mode 6: CH78_2480 MHz	Mode 7: CH00_2402 MHz Mode 8: CH39_2441 MHz Mode 9: CH78_2480 MHz
Radiated Test Cases	Bluetooth BR 1Mbps GFSK Mode 1: CH00_2402 MHz Mode 2: CH39_2441 MHz Mode 3: CH78_2480 MHz		
AC Conducted Emission	Mode 1 :GSM850 Idle + Bluetooth Link + WLAN (2.4G) Link + Earphone + USB Cable (Charging from Adapter)		
Remark:			
<ol style="list-style-type: none"> For radiated test cases, the worst mode data rate 1Mbps was reported only, because this data rate has the highest RF output power at preliminary tests, and no other significantly frequencies found in conducted spurious emission. For Radiated Test Cases, The tests were performance with Adapter , Earphone, and USB Cable. 			

2.3 Connection Diagram of Test System

<Bluetooth Tx Mode>

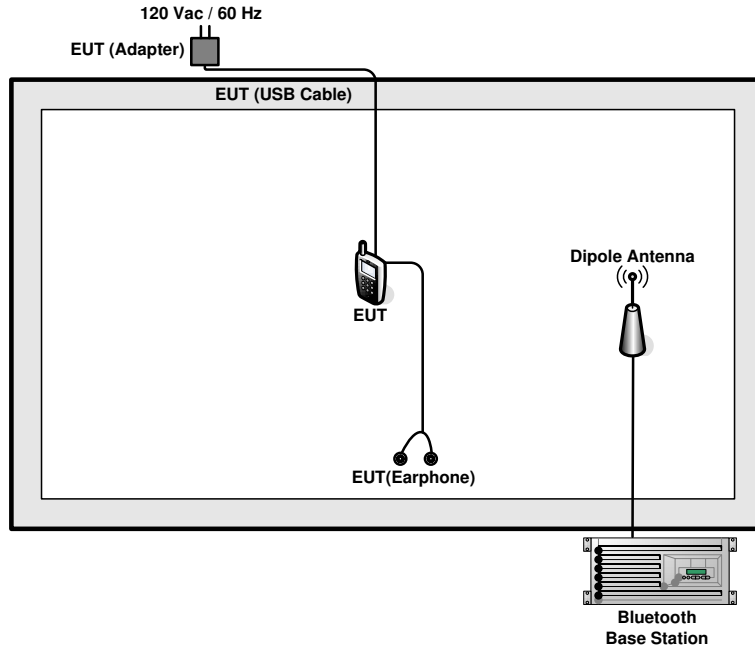

<AC Conducted Emission Mode>

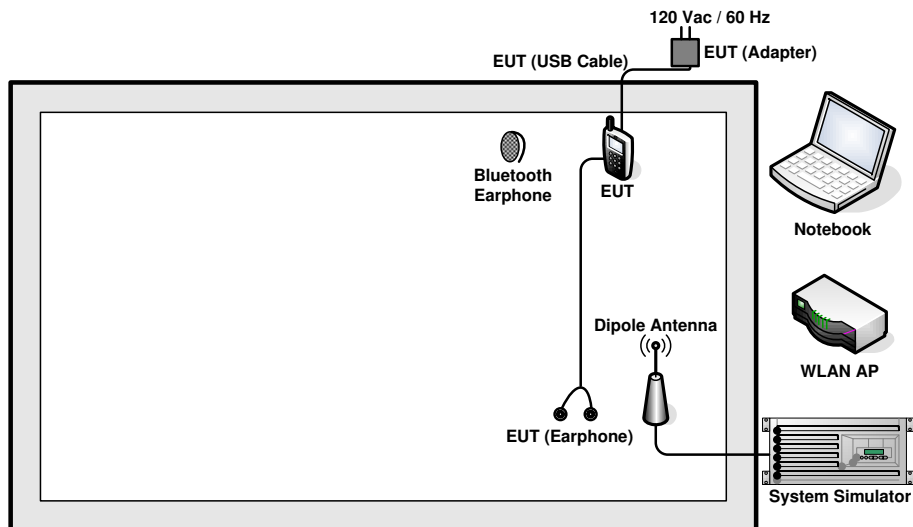

2.4 Support Unit used in test configuration and system

Item	Equipment	Trade Name	Model Name	FCC ID	Data Cable	Power Cord
1.	System Simulator	R&S	CMU 200	N/A	N/A	Unshielded, 1.8 m
2.	Bluetooth Base Station	R&S	CBT	N/A	N/A	Unshielded, 1.8 m
3.	WLAN AP	LINKSYS	WRT600N	Q87-WRT600NV11	N/A	Unshielded, 1.8 m
4.	Notebook	Lenovo	G480	N/A	N/A	AC I/P: Unshielded, 1.8 m DC O/P: Shielded, 1.8 m
5.	Bluetooth Earphone	Lenovo	LBH308	N/A	N/A	N/A

2.5 EUT Operation Test Setup

For Bluetooth function, the engineering test program was provided and enabled to make EUT connect with Bluetooth base station to continuous transmit/receive.

For AC power line conducted emissions, the EUT was set to connect with the WLAN AP under large package sizes transmission.



2.6 Measurement Results Explanation Example

For all conducted test items:

The offset level is set in the spectrum analyzer to compensate the RF cable loss between EUT conducted output port and spectrum analyzer. With the offset compensation, the spectrum analyzer reading level is exactly the EUT RF output level.

Example :

The spectrum analyzer offset is derived from RF cable loss.

Offset = RF cable loss.

Following shows an offset computation example with cable loss 5.6 dB.

$$\begin{aligned} \text{Offset(dB)} &= \text{RF cable loss(dB)}. \\ &= 5.6 \text{ (dB)} \end{aligned}$$

3 Test Result

3.1 Number of Channel Measurement

3.1.1 Limits of Number of Hopping Frequency

Frequency hopping systems in the 2400-2483.5 MHz band shall use at least 15 channels.

3.1.2 Measuring Instruments

The measuring equipment is listed in the section 4 of this test report.

3.1.3 Test Procedure

1. The testing follows ANSI C63.10-2013 clause 7.8.3.
2. The RF output of EUT was connected to the spectrum analyzer by RF cable and attenuator. The path loss was compensated to the results for each measurement.
3. Set to the maximum power setting and enable the EUT transmit continuously.
4. Enable the EUT hopping function.
5. Use the following spectrum analyzer settings: Span = the frequency band of operation; RBW = 300kHz; VBW ≥ RBW; Sweep = auto; Detector function = peak; Trace = max hold.
6. The number of hopping frequency used is defined as the number of total channel.
7. Record the measurement data derived from spectrum analyzer.

3.1.4 Test Setup

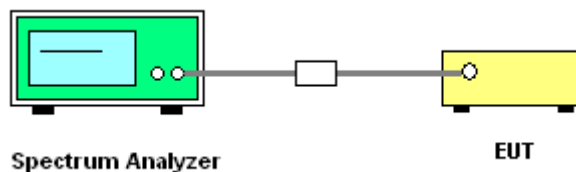

3.1.5 Test Result of Number of Hopping Frequency

Test Mode :	1Mbps	Temperature :	21~25°C
Test Engineer :	Silent Hai	Relative Humidity :	51~55%
Number of Hopping (Channel)	Adaptive Frequency Hopping (Channel)	Limits (Channel)	Pass/Fail
79	20	> 15	Pass



Number of Hopping Channel Plot on Channel 00 - 78

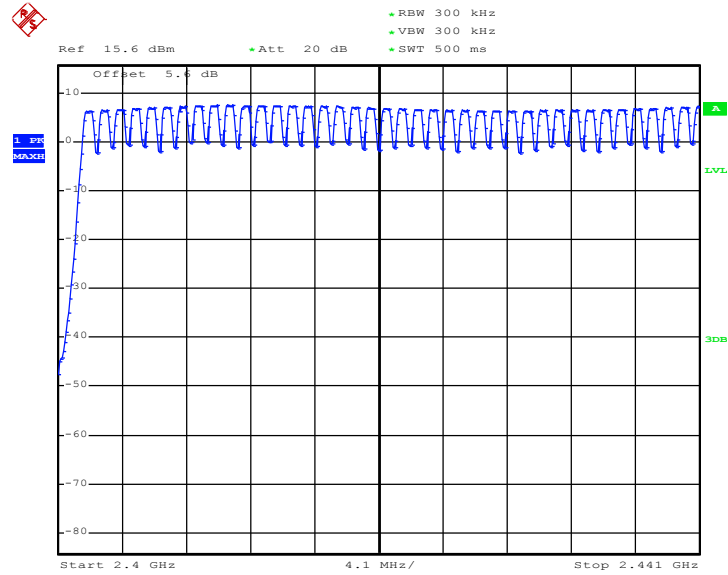

Date: 18.MAR.2017 01:34:28

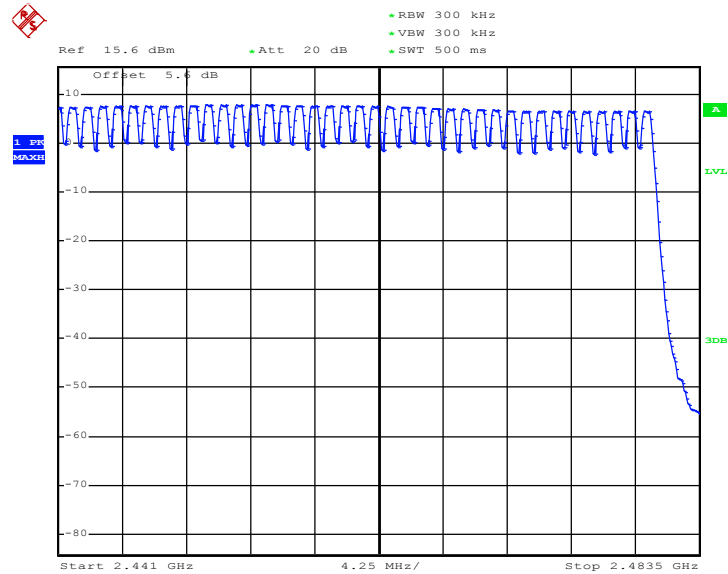

Date: 18.MAR.2017 01:40:39

3.2 Hopping Channel Separation Measurement

3.2.1 Limit of Hopping Channel Separation

Frequency hopping systems operating in the 2400-2483.5 MHz band may have hopping channel carrier frequencies that are separated by 25 kHz or two-thirds of the 20 dB bandwidth of the hopping channel, whichever is greater.

3.2.2 Measuring Instruments

The measuring equipment is listed in the section 4 of this test report.

3.2.3 Test Procedures

1. The testing follows ANSI C63.10-2013 clause 7.8.2.
2. The RF output of EUT was connected to the spectrum analyzer by RF cable and attenuator. The path loss was compensated to the results for each measurement.
3. Set to the maximum power setting and enable the EUT transmit continuously.
4. Enable the EUT hopping function.
5. Use the following spectrum analyzer settings:
Span = wide enough to capture the peaks of two adjacent channels;
RBW = 300kHz; VBW \geq RBW; Sweep = auto; Detector function = peak; Trace = max hold.
6. Measure and record the results in the test report.

3.2.4 Test Setup

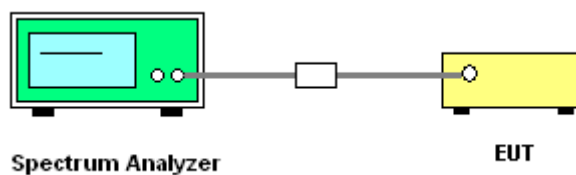



3.2.5 Test Result of Hopping Channel Separation

Test Mode :	1Mbps	Temperature :	21~25°C
Test Engineer :	Silent Hai	Relative Humidity :	51~55%

Channel	Frequency (MHz)	Frequency Separation (MHz)	(2/3 of 20dB BW) Limits (MHz)	Pass/Fail
00	2402	1.008	0.6480	Pass
39	2441	1.008	0.6453	Pass
78	2480	1.008	0.5973	Pass

Channel Separation Plot on Channel 00 - 01

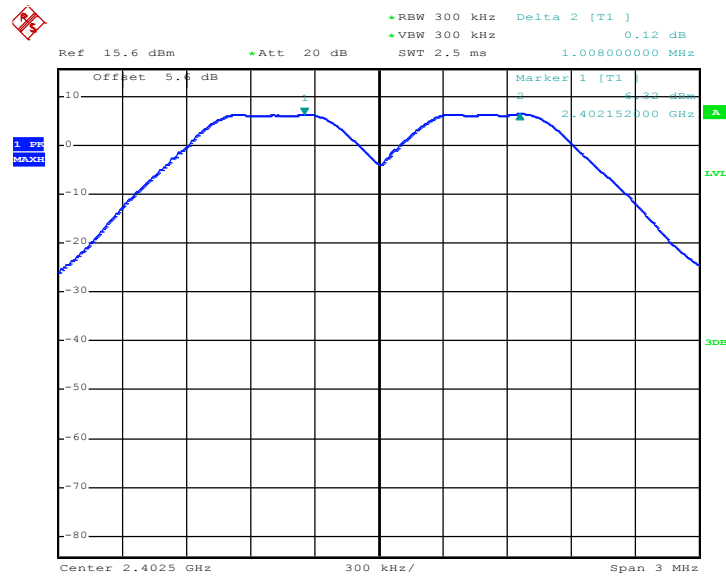

Date: 18.MAR.2017 01:04:16



Channel Separation Plot on Channel 39 - 40

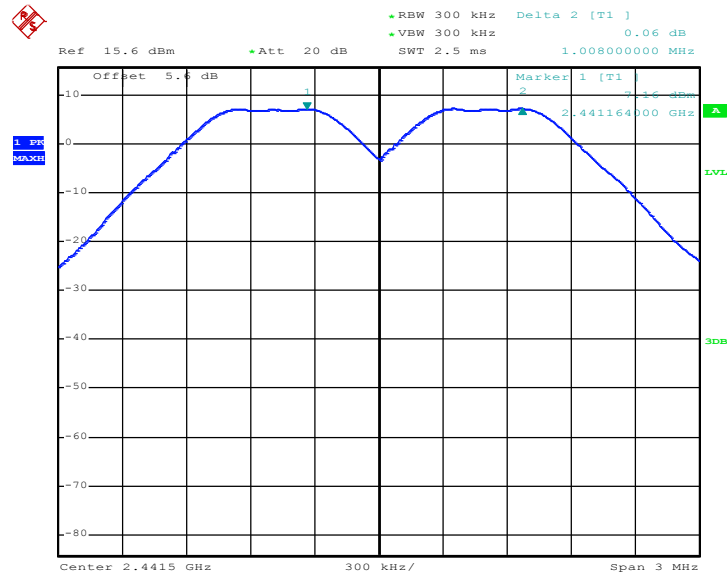

Date: 18.MAR.2017 01:04:58

Channel Separation Plot on Channel 77 - 78

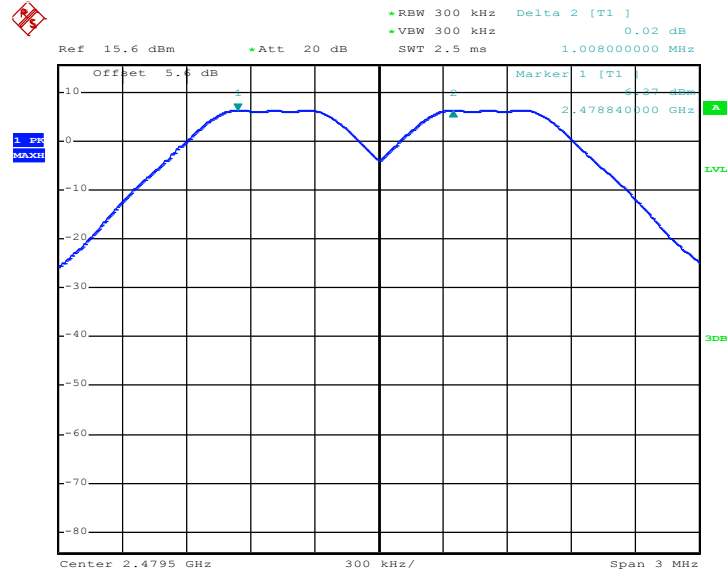

Date: 18.MAR.2017 01:07:39



Test Mode :	2Mbps	Temperature :	21~25°C
Test Engineer :	Silent Hai	Relative Humidity :	51~55%

Channel	Frequency (MHz)	Frequency Separation (MHz)	(2/3 of 20dB BW) Limits (MHz)	Pass/Fail
00	2402	1.008	0.8400	Pass
39	2441	1.008	0.8440	Pass
78	2480	1.002	0.8280	Pass

Channel Separation Plot on Channel 00 - 01

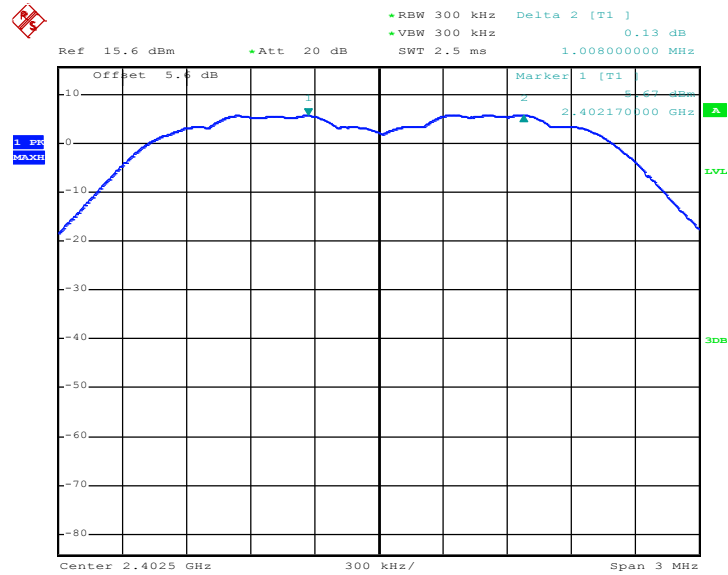

Date: 18.MAR.2017 01:09:19



Channel Separation Plot on Channel 39 - 40

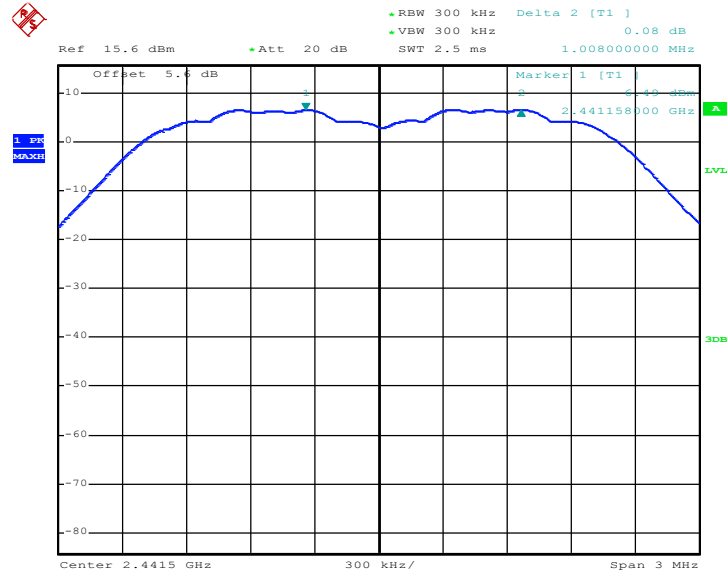

Date: 18.MAR.2017 01:09:58

Channel Separation Plot on Channel 77 - 78

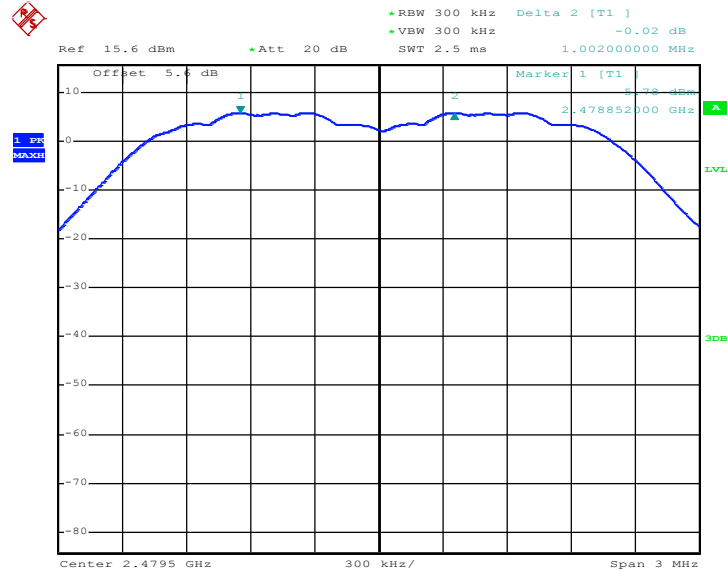

Date: 18.MAR.2017 01:12:51



Test Mode :	3Mbps	Temperature :	21~25°C
Test Engineer :	Silent Hai	Relative Humidity :	51~55%

Channel	Frequency (MHz)	Frequency Separation (MHz)	(2/3 of 20dB BW) Limits (MHz)	Pass/Fail
00	2402	1.002	0.8320	Pass
39	2441	1.002	0.8320	Pass
78	2480	1.002	0.8360	Pass

Channel Separation Plot on Channel 00 - 01

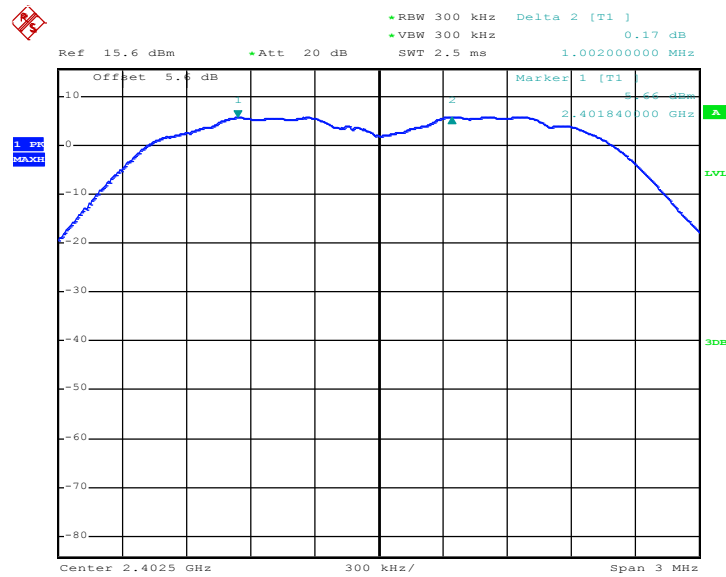

Date: 18.MAR.2017 01:14:30



Channel Separation Plot on Channel 39 - 40

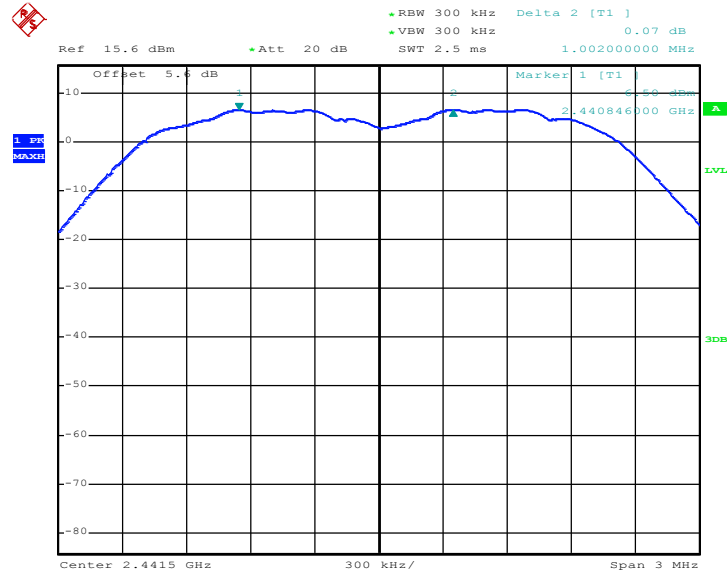

Date: 18.MAR.2017 01:15:10

Channel Separation Plot on Channel 77 - 78

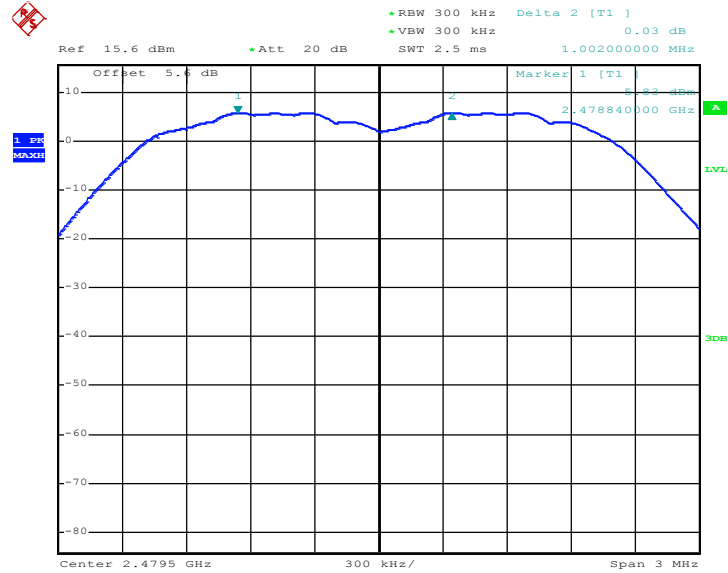

Date: 18.MAR.2017 01:16:42

3.3 Dwell Time Measurement

3.3.1 Limit of Dwell Time

The average time of occupancy on any channel shall not be greater than 0.4 seconds within a period of 0.4 seconds multiplied by the number of hopping channels employed.

3.3.2 Measuring Instruments

The measuring equipment is listed in the section 4 of this test report.

3.3.3 Test Procedures

1. The testing follows ANSI C63.10-2013 clause 7.8.4.
2. The RF output of EUT was connected to the spectrum analyzer by RF cable and attenuator. The path loss was compensated to the results for each measurement.
3. Set to the maximum power setting and enable the EUT transmit continuously.
4. Enable the EUT hopping function.
5. Use the following spectrum analyzer settings: Span = zero span, centered on a hopping channel; RBW = 1 MHz; VBW \geq RBW; Sweep = as necessary to capture the entire dwell time per hopping channel; Detector function = peak; Trace = max hold.
6. Measure and record the results in the test report.

3.3.4 Test Setup

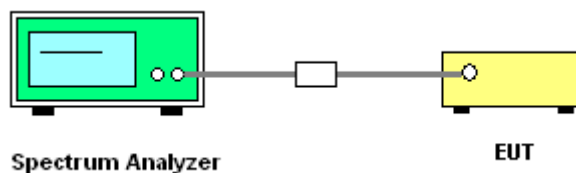



3.3.5 Test Result of Dwell Time

Test Mode :	DH5	Temperature :	21~25°C
Test Engineer :	Silent Hai	Relative Humidity :	51~55%

Mode	Hopping Channel Number	Hops Over Occupancy Time(hops)	Package Transfer Time (msec)	Dwell Time (sec)	Limits (sec)	Pass/Fail
Normal	79	106.67	2.8667	0.31	0.4	Pass
AFH	20	53.33	2.8667	0.15	0.4	Pass

Remark:

- In normal mode, hopping rate is 1600 hops/s with 6 slots in 79 hopping channels.
With channel hopping rate (1600 / 6 / 79) in Occupancy Time Limit (0.4 x 79) (s),
Hops Over Occupancy Time comes to (1600 / 6 / 79) x (0.4 x 79) = 106.67 hops.
- In AFH mode, hopping rate is 800 hops/s with 6 slots in 20 hopping channels.
With channel hopping rate (800 / 6 / 20) in Occupancy Time Limit (0.4 x 20) (s),
Hops Over Occupancy Time comes to (800 / 6 / 20) x (0.4 x 20) = 53.33 hops.
- Dwell Time(s) = Hops Over Occupancy Time (hops) x Package Transfer Time



Package Transfer Time Plot

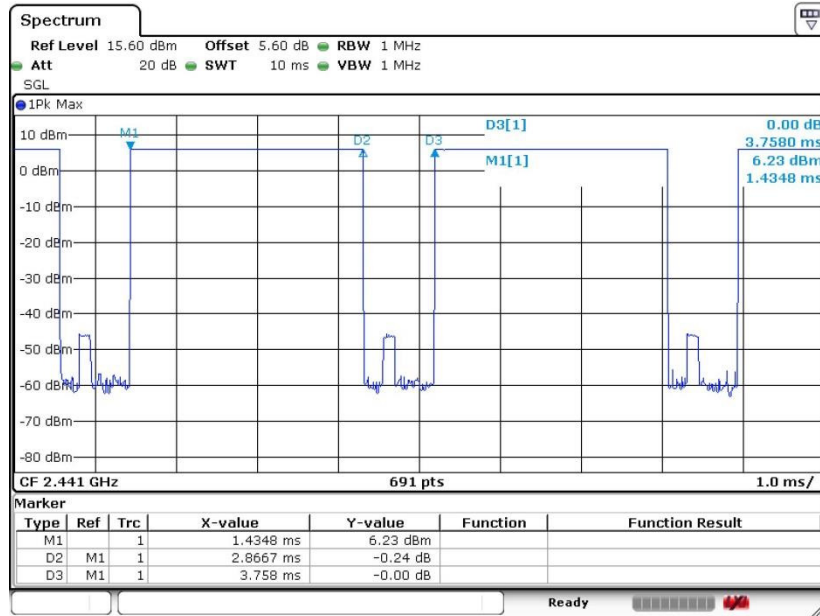

Date: 16.MAR.2017 15:50:39

3.4 20dB and 99% Bandwidth Measurement

3.4.1 Limit of 20dB and 99% Bandwidth

Reporting only

3.4.2 Measuring Instruments

The measuring equipment is listed in the section 4 of this test report.

3.4.3 Test Procedures

1. The testing follows ANSI C63.10-2013 clause 6.9.2 and 6.9.3.
2. The RF output of EUT was connected to the spectrum analyzer by RF cable and attenuator. The path loss was compensated to the results for each measurement.
3. Set to the maximum power setting and enable the EUT transmit continuously.
4. Use the following spectrum analyzer settings for 20dB Bandwidth measurement.
Span = approximately 2 to 5 times the 20 dB bandwidth, centered on a hopping channel;
RBW \geq 1% of the 20 dB bandwidth; VBW \geq RBW; Sweep = auto; Detector function = peak;
Trace = max hold.
5. Use the following spectrum analyzer settings for 99 % Bandwidth measurement.
Span = approximately 1.5 to 5 times the 99% bandwidth, centered on a hopping channel;
RBW \geq 1% of the 99% bandwidth; VBW \geq RBW; Sweep = auto; Detector function = sample;
Trace = max hold.
6. Measure and record the results in the test report.

3.4.4 Test Setup

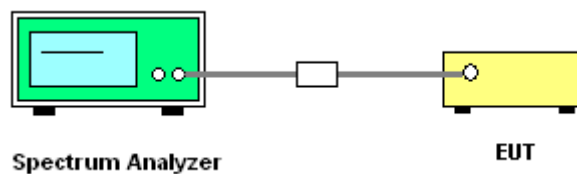



3.4.5 Test Result of 20dB Bandwidth

Test Mode :	1Mbps	Temperature :	21~25°C
Test Engineer :	Silent Hai	Relative Humidity :	51~55%

Channel	Frequency (MHz)	20dB Bandwidth (MHz)
00	2402	0.972
39	2441	0.968
78	2480	0.896

20 dB Bandwidth Plot on Channel 00

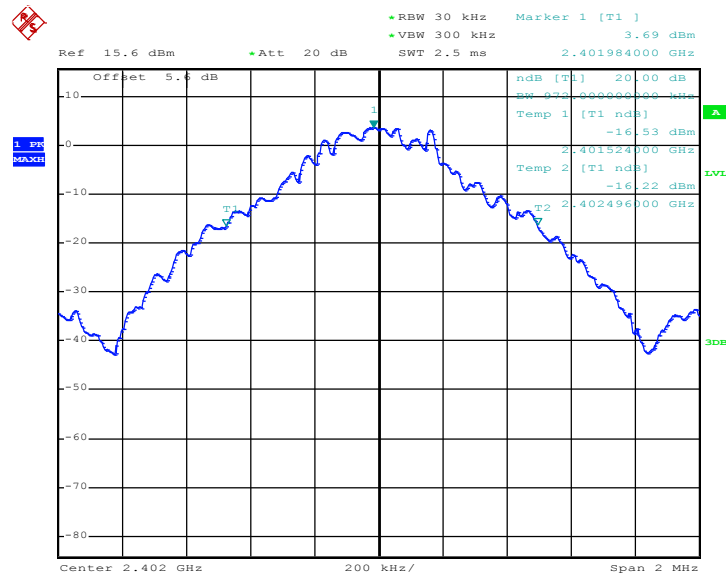

Date: 18.MAR.2017 01:16:59



20 dB Bandwidth Plot on Channel 39

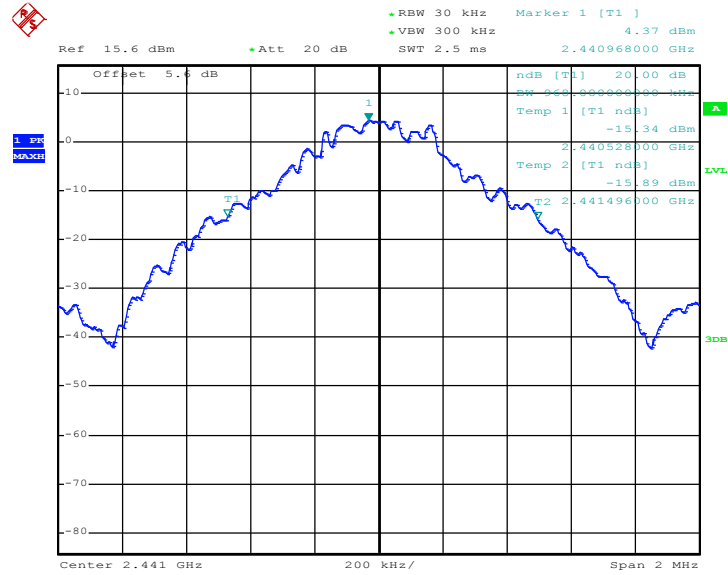

Date: 18.MAR.2017 01:17:11

20 dB Bandwidth Plot on Channel 78

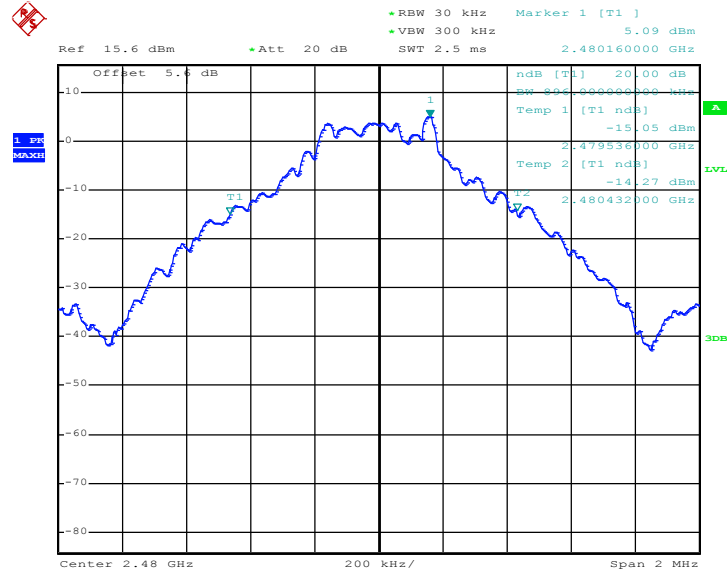

Date: 18.MAR.2017 01:17:25



Test Mode :	2Mbps	Temperature :	21~25°C
Test Engineer :	Silent Hai	Relative Humidity :	51~55%

Channel	Frequency (MHz)	20dB Bandwidth (MHz)
00	2402	1.260
39	2441	1.266
78	2480	1.242

20 dB Bandwidth Plot on Channel 00

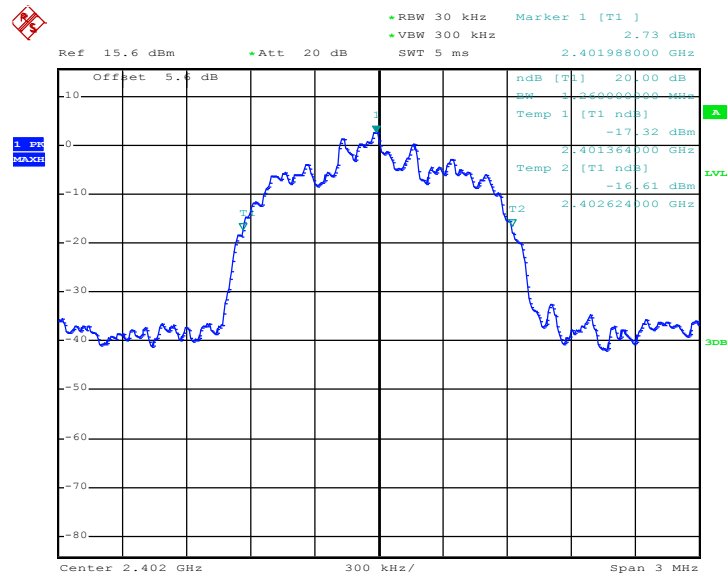

Date: 18.MAR.2017 01:17:37



20 dB Bandwidth Plot on Channel 39

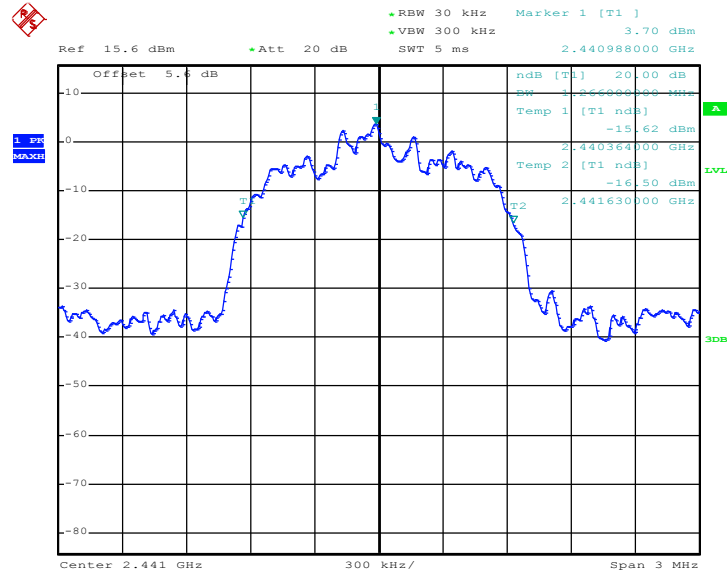

Date: 18.MAR.2017 01:17:56

20 dB Bandwidth Plot on Channel 78

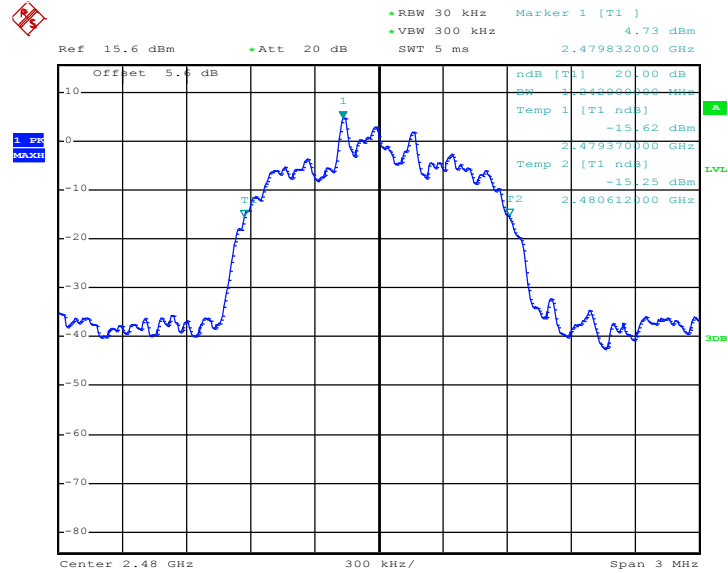

Date: 18.MAR.2017 01:18:09



Test Mode :	3Mbps	Temperature :	21~25°C
Test Engineer :	Silent Hai	Relative Humidity :	51~55%

Channel	Frequency (MHz)	20dB Bandwidth (MHz)
00	2402	1.248
39	2441	1.248
78	2480	1.254

20 dB Bandwidth Plot on Channel 00

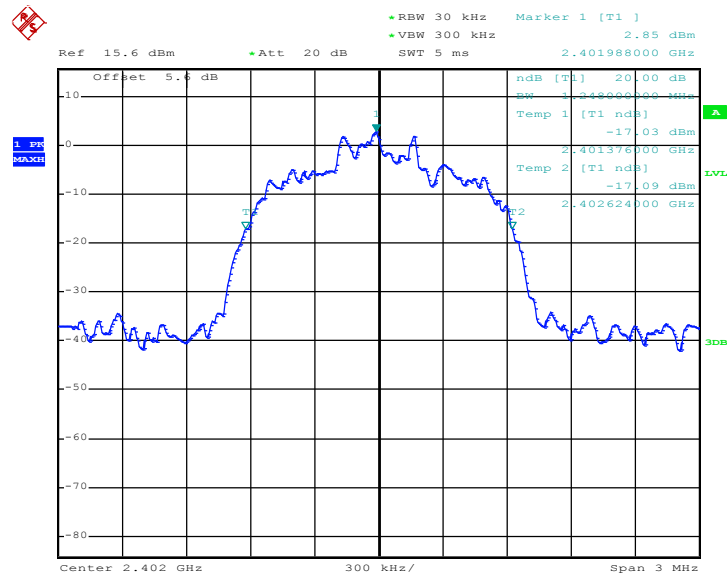

Date: 18.MAR.2017 01:18:22



20 dB Bandwidth Plot on Channel 39

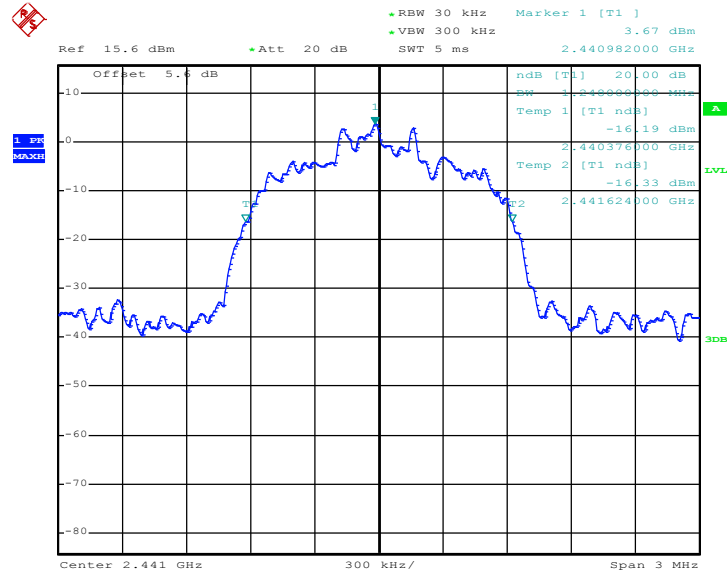

Date: 18.MAR.2017 01:18:35

20 dB Bandwidth Plot on Channel 78

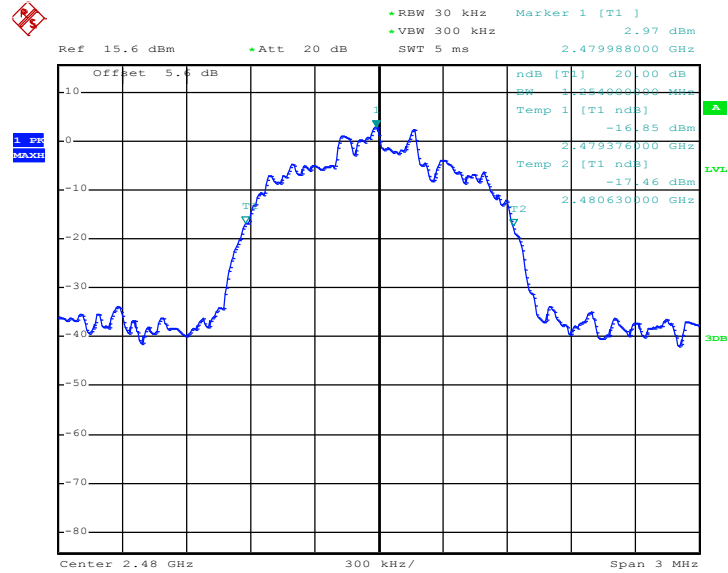

Date: 18.MAR.2017 01:18:51



3.4.6 Test Result of 99% Occupied Bandwidth

Test Mode :	1Mbps	Temperature :	21~25°C
Test Engineer :	Silent Hai	Relative Humidity :	51~55%

Channel	Frequency (MHz)	99% Occupied Bandwidth (MHz)
00	2402	0.876
39	2441	0.900
78	2480	0.900

99% Occupied Bandwidth Plot on Channel 00

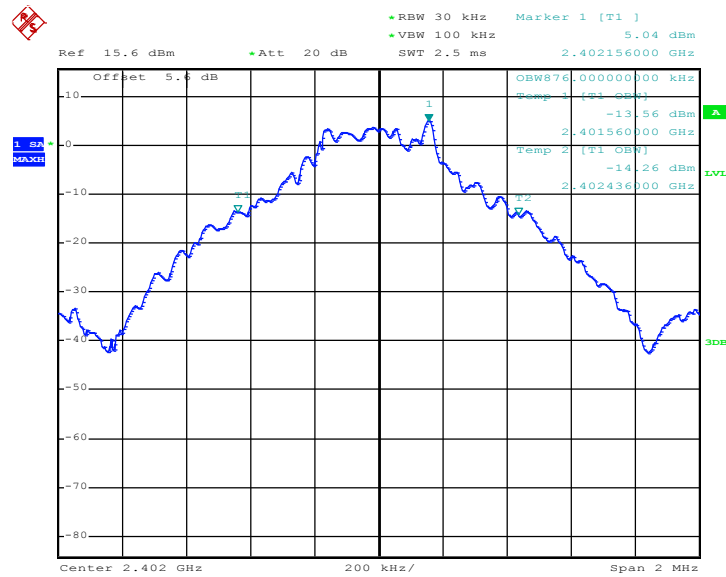

Date: 18.MAR.2017 01:24:39



99% Occupied Bandwidth Plot on Channel 39

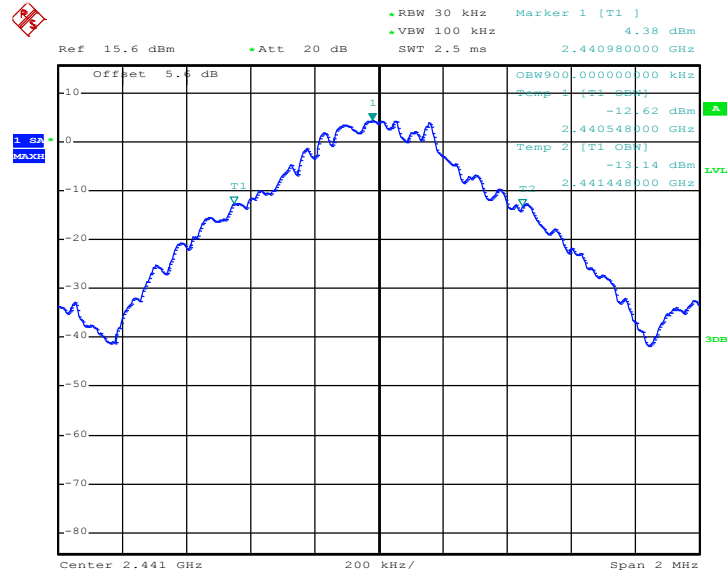

Date: 18.MAR.2017 01:25:15

99% Occupied Bandwidth Plot on Channel 78

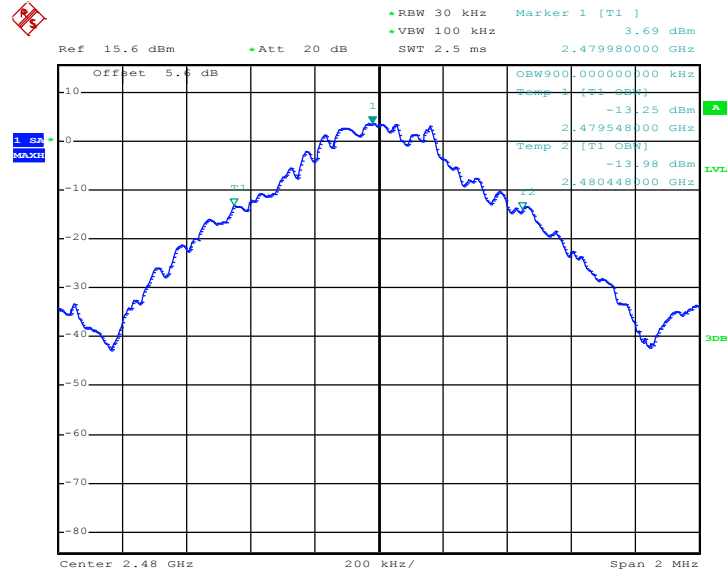

Date: 18.MAR.2017 01:25:51



Test Mode :	2Mbps	Temperature :	21~25°C
Test Engineer :	Silent Hai	Relative Humidity :	51~55%

Channel	Frequency (MHz)	99% Occupied Bandwidth (MHz)
00	2402	1.152
39	2441	1.164
78	2480	1.164

99% Occupied Bandwidth Plot on Channel 00

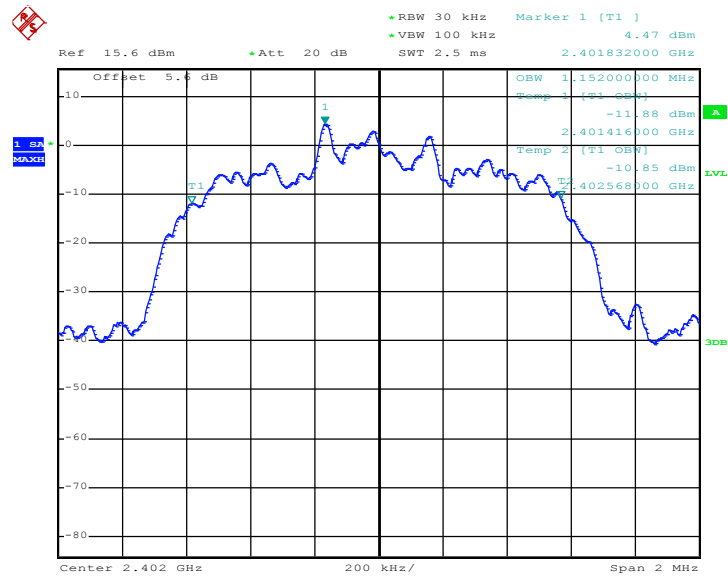

Date: 18.MAR.2017 01:26:27



99% Occupied Bandwidth Plot on Channel 39

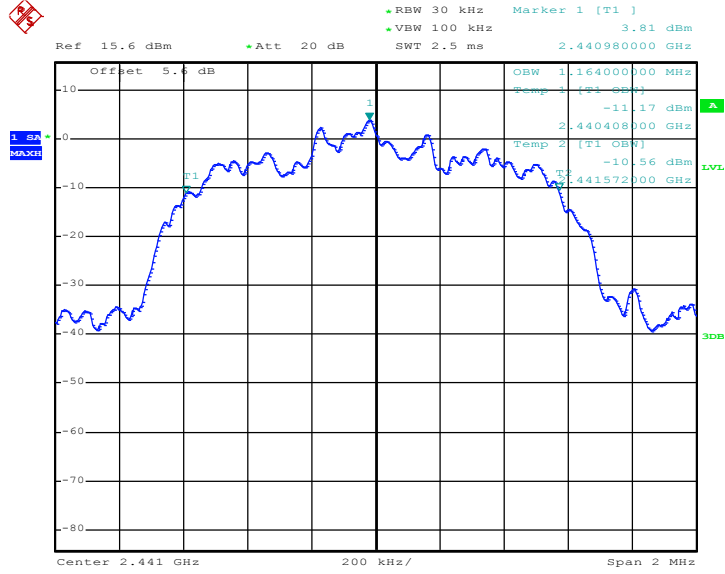

Date: 18.MAR.2017 01:27:04

99% Occupied Bandwidth Plot on Channel 78

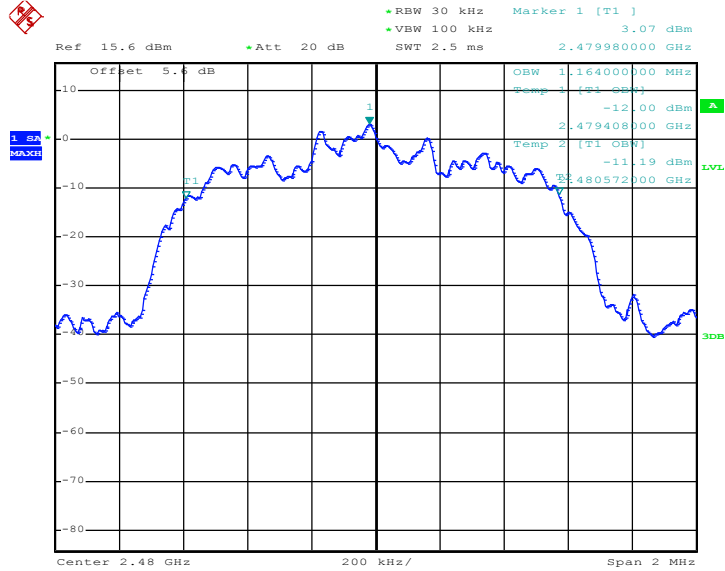

Date: 18.MAR.2017 01:27:40



Test Mode :	3Mbps	Temperature :	21~25°C
Test Engineer :	Silent Hai	Relative Humidity :	51~55%

Channel	Frequency (MHz)	99% Occupied Bandwidth (MHz)
00	2402	1.144
39	2441	1.148
78	2480	1.152

99% Occupied Bandwidth Plot on Channel 00

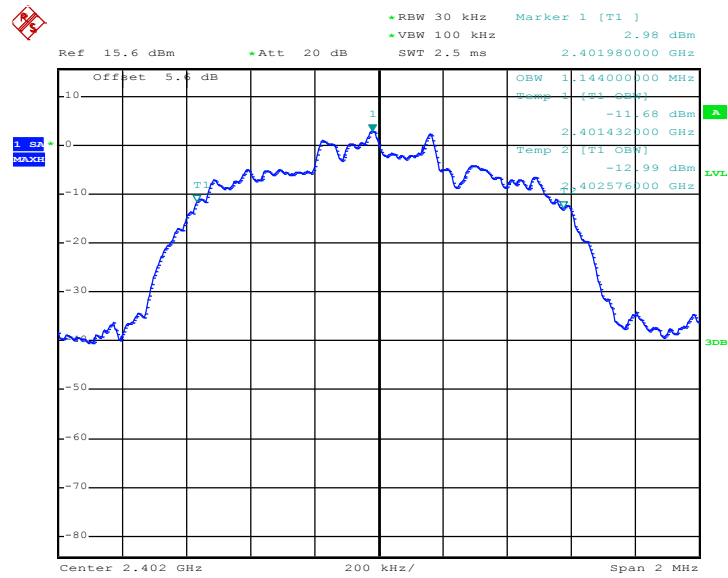

Date: 18.MAR.2017 01:28:16



99% Occupied Bandwidth Plot on Channel 39

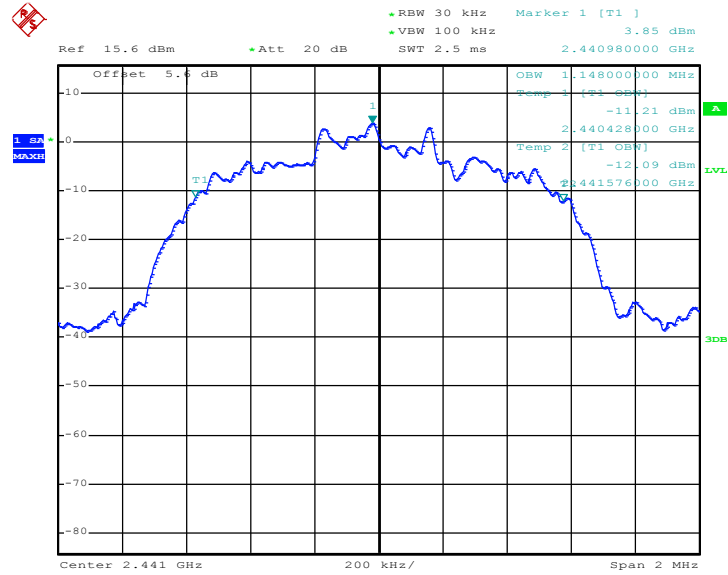

Date: 18.MAR.2017 01:28:52

99% Occupied Bandwidth Plot on Channel 78

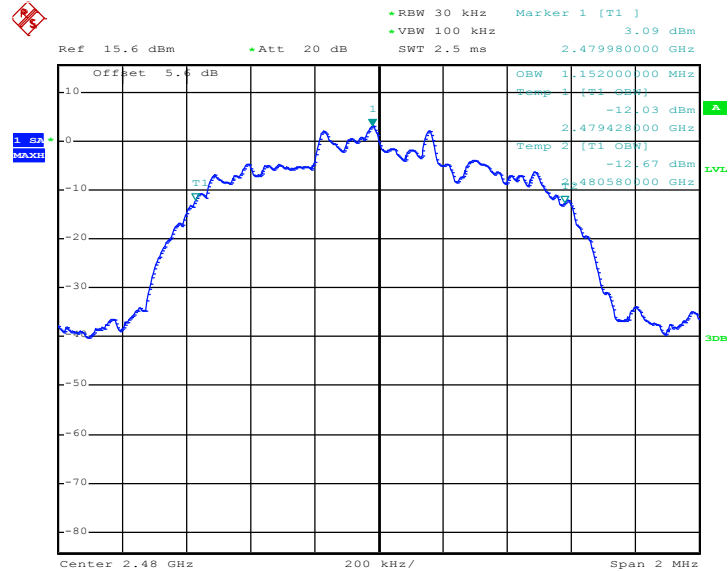

Date: 18.MAR.2017 01:29:28

Note : The occupied channel bandwidth is maintained within the band of operation for all of the modulations.

3.5 Peak Output Power Measurement

3.5.1 Limit of Peak Output Power

The maximum peak conducted output power of the intentional radiator shall not exceed the following:
(1) For frequency hopping systems operating in the 2400-2483.5 MHz band employing at least 75 non-overlapping hopping channels, and all frequency hopping systems in the 5725-5850 MHz band: 1 watt. For all other frequency hopping systems in the 2400-2483.5 MHz band 0.125 watts.

3.5.2 Measuring Instruments

The measuring equipment is listed in the section 4 of this test report.

3.5.3 Test Procedures

1. The testing follows ANSI C63.10-2013 clause 7.8.5.
2. The RF output of EUT was connected to the power meter by RF cable and attenuator. The path loss was compensated to the results for each measurement.
3. Set to the maximum power setting and enable the EUT transmit continuously.
4. Measure the conducted output power with cable loss and record the results in the test report.
5. Measure and record the results in the test report.

3.5.4 Test Setup

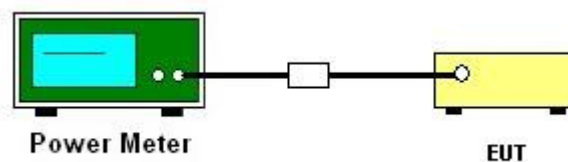



3.5.5 Test Result of Peak Output Power

Test Mode :	1Mbps	Temperature :	21~25°C
Test Engineer :	Silent Hai	Relative Humidity :	51~55%

Channel	Frequency (MHz)	RF Power (dBm)		
		GFSK	Max. Limits (dBm)	Pass/Fail
		1 Mbps		
00	2402	6.77	20.97	Pass
39	2441	7.29	20.97	Pass
78	2480	6.68	20.97	Pass

Test Mode :	2Mbps	Temperature :	21~25°C
Test Engineer :	Silent Hai	Relative Humidity :	51~55%

Channel	Frequency (MHz)	RF Power (dBm)		
		$\pi/4$ -DQPSK	Max. Limits (dBm)	Pass/Fail
		2 Mbps		
00	2402	6.53	20.97	Pass
39	2441	7.11	20.97	Pass
78	2480	6.51	20.97	Pass

Test Mode :	3Mbps	Temperature :	21~25°C
Test Engineer :	Silent Hai	Relative Humidity :	51~55%

Channel	Frequency (MHz)	RF Power (dBm)		
		8-DPSK	Max. Limits (dBm)	Pass/Fail
		3 Mbps		
00	2402	6.64	20.97	Pass
39	2441	7.24	20.97	Pass
78	2480	6.67	20.97	Pass

3.6 Conducted Band Edges Measurement

3.6.1 Limit of Band Edges

In any 100 kHz bandwidth outside the intentional radiation frequency band, the radio frequency power shall be at least 20 dB below the highest level of the radiated power. In addition, radiated emissions which fall in the restricted bands must also comply with the radiated emission limits.

3.6.2 Measuring Instruments

The measuring equipment is listed in the section 4 of this test report.

3.6.3 Test Procedures

1. The testing follows ANSI C63.10-2013 clause 7.8.6.
2. Set to the maximum power setting and enable the EUT transmit continuously.
3. Set RBW = 100kHz, VBW = 300kHz. Band edge emissions must be at least 20 dB down from the highest emission level within the authorized band as measured with a 100kHz RBW. The attenuation shall be 30 dB instead of 20 dB when RMS conducted output power procedure is used.
4. Enable hopping function of the EUT and then repeat step 2. and 3.
5. Measure and record the results in the test report.

3.6.4 Test Setup

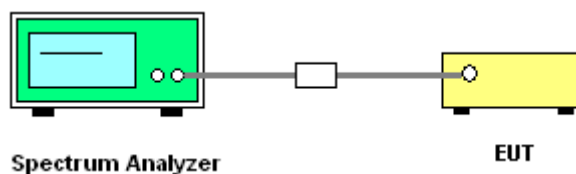



3.6.5 Test Result of Conducted Band Edges

Test Mode :	1Mbps	Temperature :	21~25°C
Test Channel :	00 and 78	Relative Humidity :	51~55%
		Test Engineer :	Silent Hai

Low Band Edge Plot on Channel 00

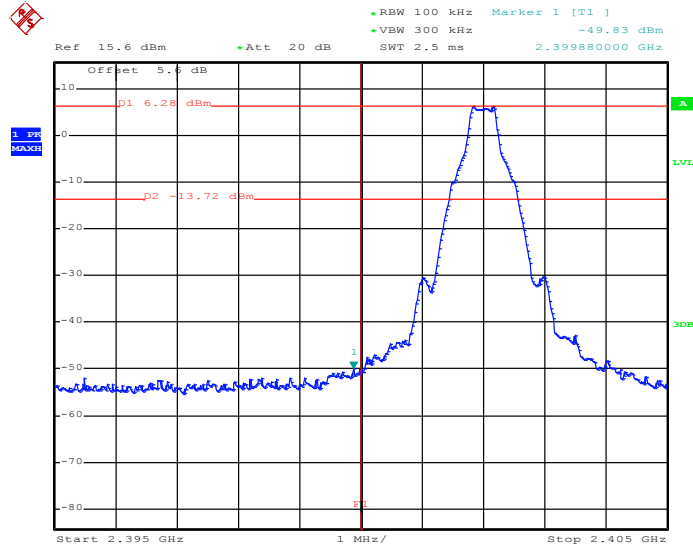

Date: 18.MAR.2017 01:19:44

High Band Edge Plot on Channel 78

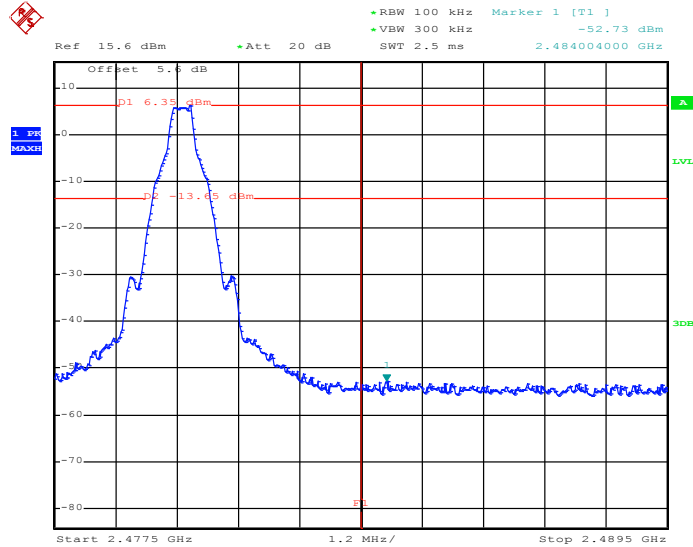

Date: 18.MAR.2017 01:41:58



Test Mode :	2Mbps	Temperature :	21~25°C
Test Channel :	00 and 78	Relative Humidity :	51~55%
		Test Engineer :	Silent Hai

Low Band Edge Plot on Channel 00

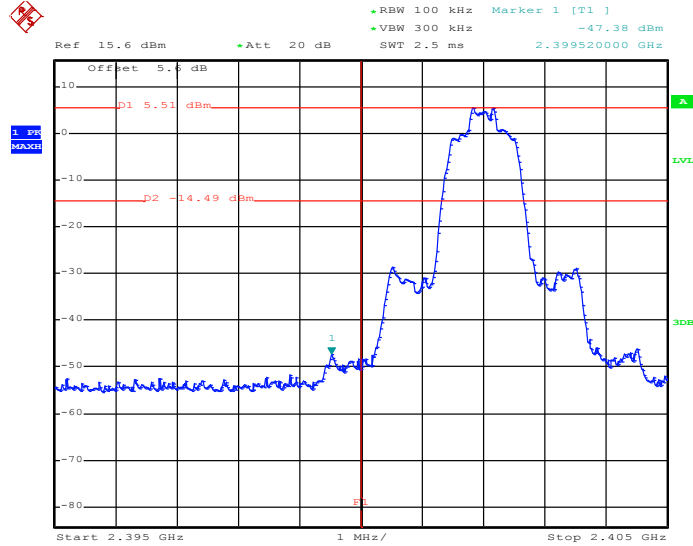

Date: 18.MAR.2017 01:21:27

High Band Edge Plot on Channel 78

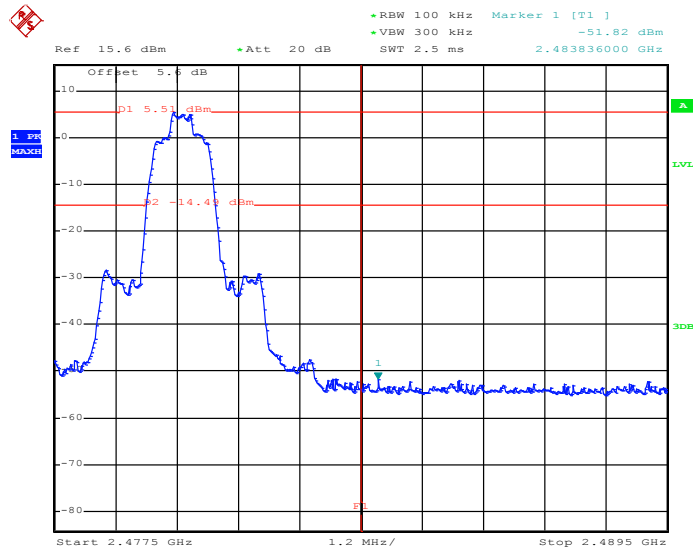

Date: 18.MAR.2017 01:22:19



Test Mode :	3Mbps	Temperature :	21~25°C
Test Channel :	00 and 78	Relative Humidity :	51~55%
		Test Engineer :	Silent Hai

Low Band Edge Plot on Channel 00

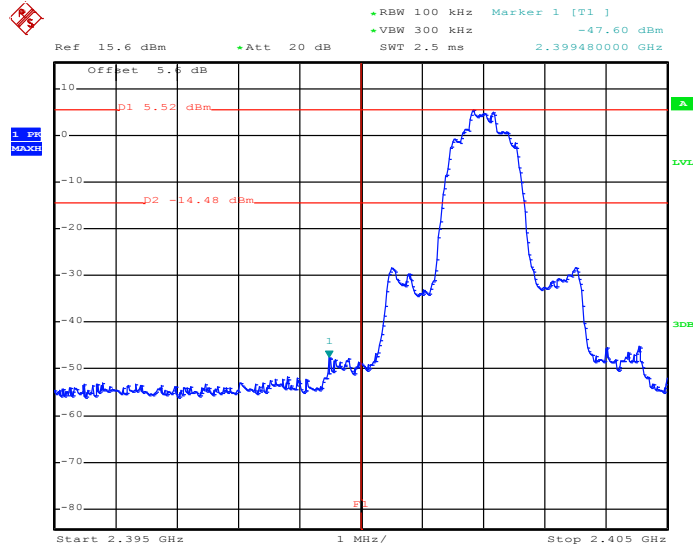

Date: 18.MAR.2017 01:46:23

High Band Edge Plot on Channel 78

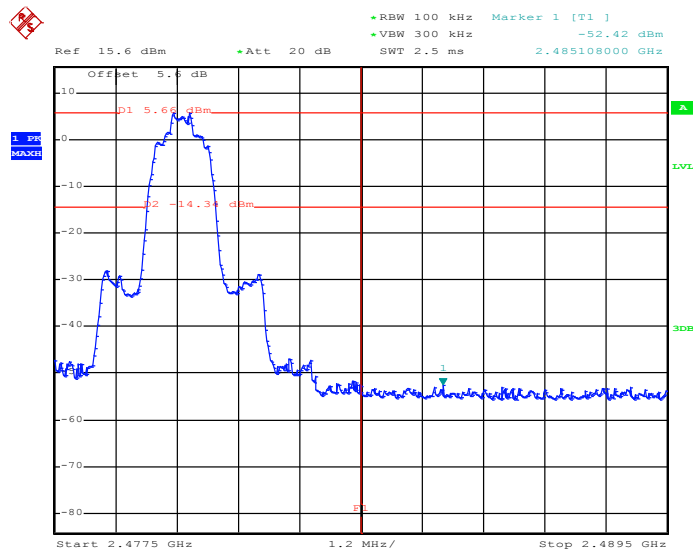

Date: 18.MAR.2017 01:44:41



3.6.6 Test Result of Conducted Hopping Mode Band Edges

Test Mode :	1Mbps	Temperature :	21~25°C
Test Engineer :	Silent Hai	Relative Humidity :	51~55%

1Mbps Hopping Mode Low Band Edge Plot

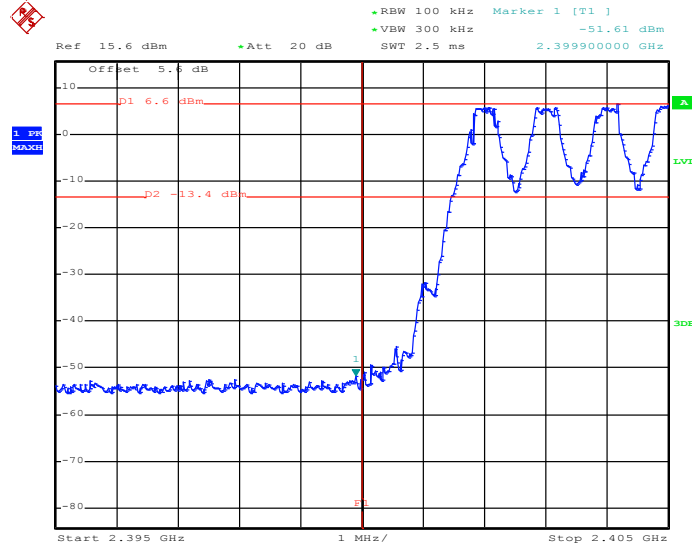

Date: 18.MAR.2017 02:00:08

1Mbps Hopping Mode High Band Edge Plot

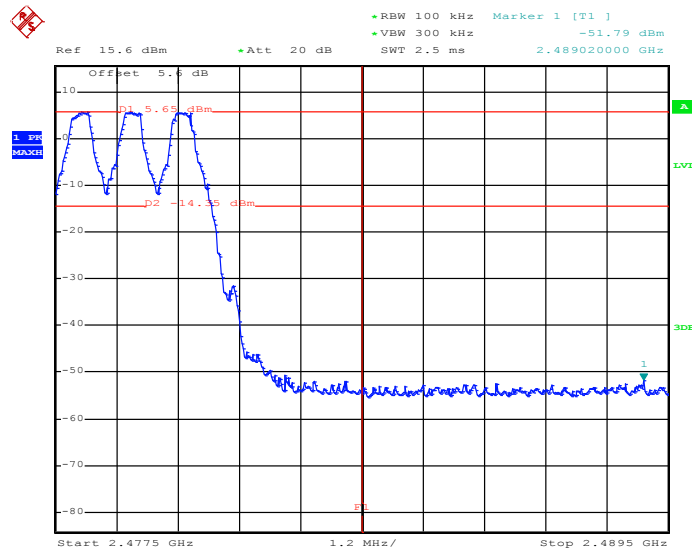

Date: 18.MAR.2017 02:01:13



Test Mode :	2Mbps	Temperature :	21~25°C
Test Engineer :	Silent Hai	Relative Humidity :	51~55%

2Mbps Hopping Mode Low Band Edge Plot

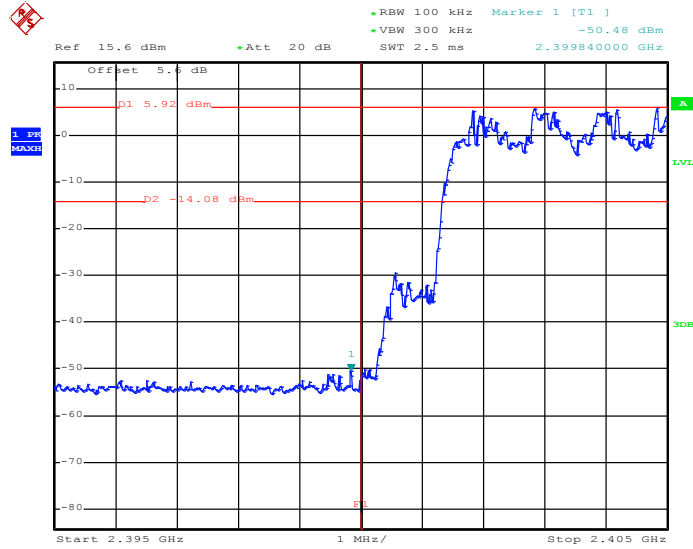

Date: 18.MAR.2017 01:58:35

2Mbps Hopping Mode High Band Edge Plot

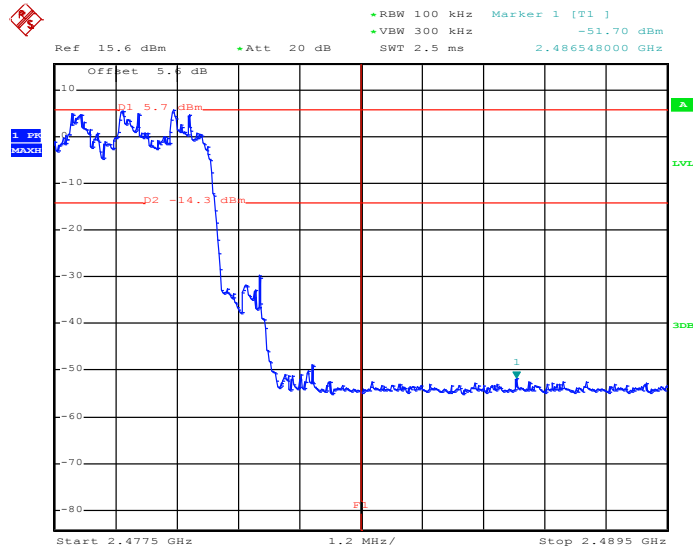

Date: 18.MAR.2017 01:51:26



Test Mode :	3Mbps	Temperature :	21~25°C
Test Engineer :	Silent Hai	Relative Humidity :	51~55%

3Mbps Hopping Mode Low Band Edge Plot

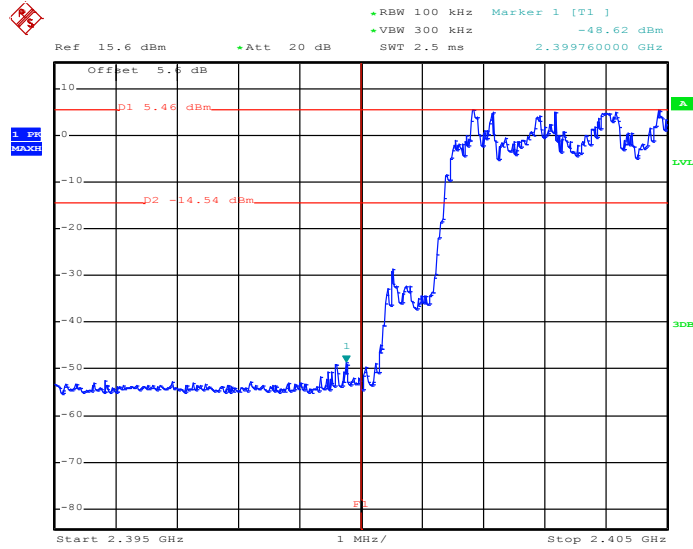

Date: 18.MAR.2017 01:48:45

3Mbps Hopping Mode High Band Edge Plot

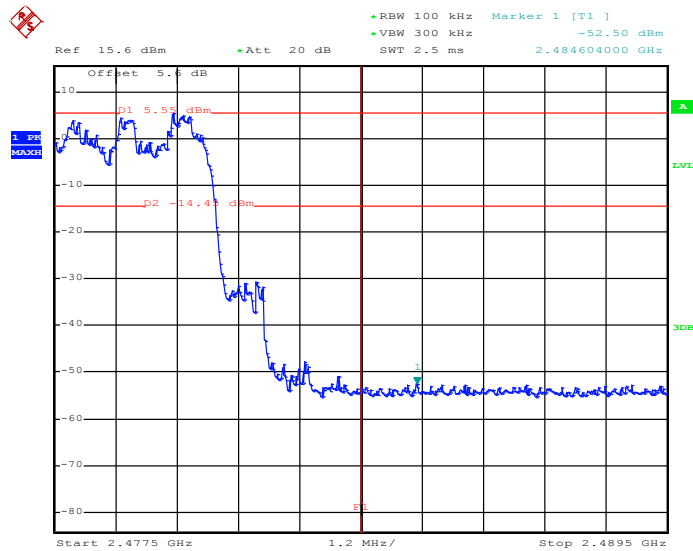

Date: 18.MAR.2017 01:55:50

3.7 Conducted Spurious Emission Measurement

3.7.1 Limit of Spurious Emission Measurement

In any 100 kHz bandwidth outside the intentional radiation frequency band, the radio frequency power shall be at least 20 dB below the highest level of the radiated power. In addition, radiated emissions which fall in the restricted bands must also comply with the radiated emission limits.

3.7.2 Measuring Instruments

The measuring equipment is listed in the section 4 of this test report.

3.7.3 Test Procedure

1. The testing follows ANSI C63.10-2013 clause 7.8.8.
2. The RF output of EUT was connected to the spectrum analyzer by RF cable and attenuator. The path loss was compensated to the results for each measurement.
3. Set to the maximum power setting and enable the EUT transmit continuously.
4. Set RBW = 100 kHz, VBW = 300kHz, scan up through 10th harmonic. All harmonics / spurs must be at least 20 dB down from the highest emission level within the authorized band as measured with a 100 kHz RBW.
5. Measure and record the results in the test report.
6. The RF fundamental frequency should be excluded against the limit line in the operating frequency band.

3.7.4 Test Setup

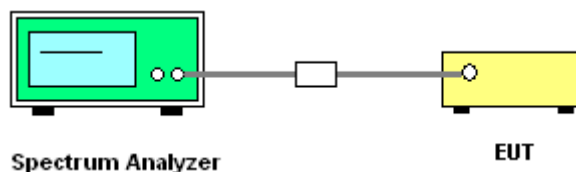



3.7.5 Test Result of Conducted Spurious Emission

Test Mode :	1Mbps	Temperature :	21~25°C
Test Channel :	00	Relative Humidity :	51~55%
		Test Engineer :	Silent Hai

1Mbps CSE Plot on Ch 00 between 30MHz ~ 3 GHz

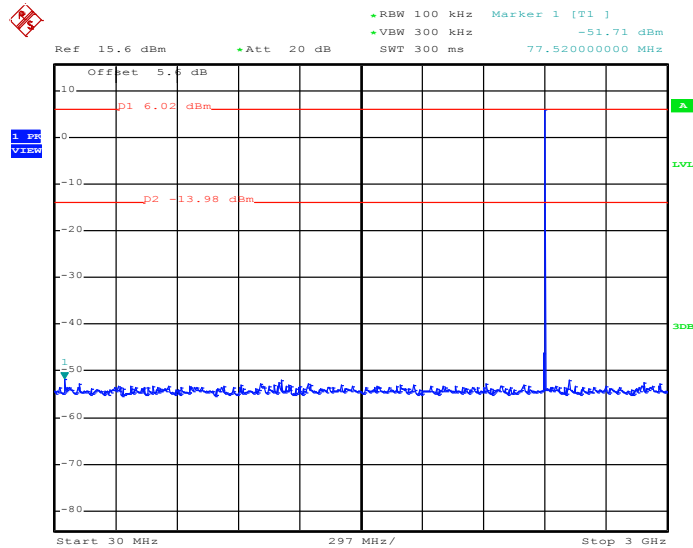

Date: 18.MAR.2017 02:09:41

1Mbps CSE Plot on Ch 00 between 2 GHz ~ 25 GHz

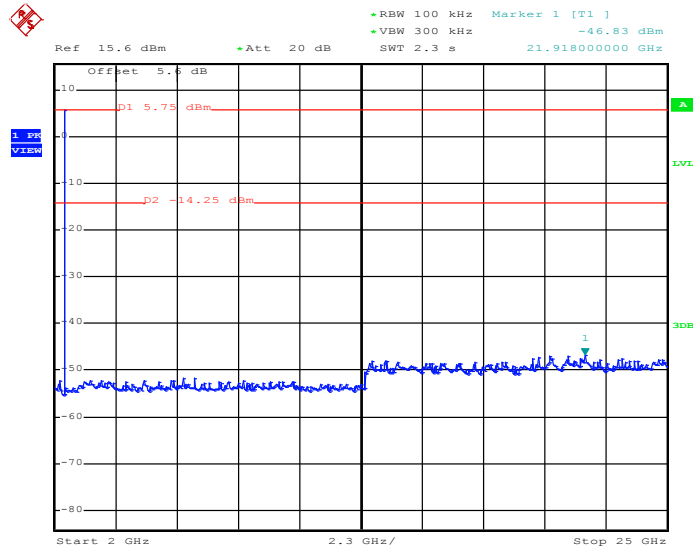

Date: 18.MAR.2017 02:14:12



Test Mode :	1Mbps	Temperature :	21~25°C
Test Channel :	39	Relative Humidity :	51~55%
		Test Engineer :	Silent Hai

1Mbps CSE Plot on Ch 39 between 30MHz ~ 3 GHz

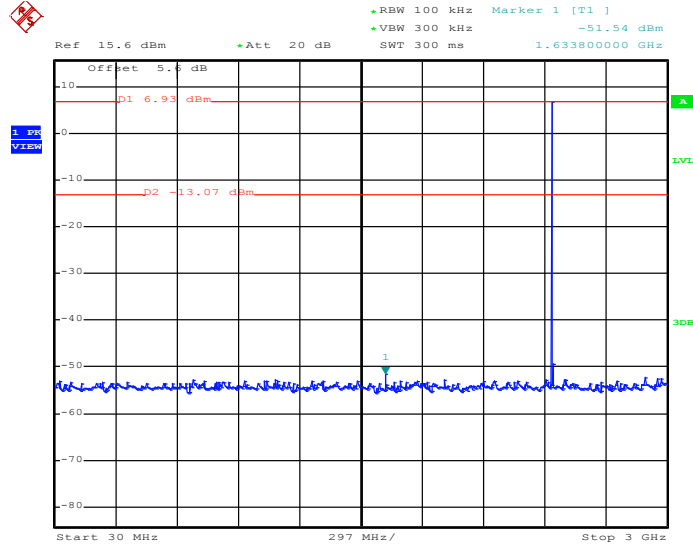

Date: 18.MAR.2017 02:04:34

1Mbps CSE Plot on Ch 39 between 2 GHz ~ 25 GHz

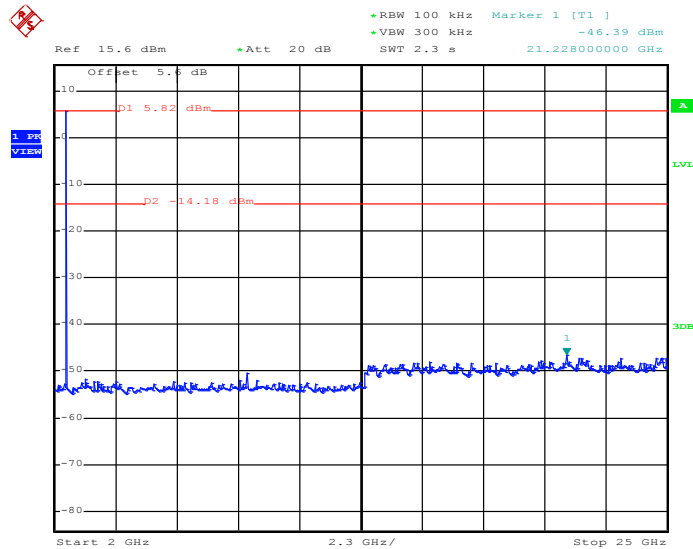

Date: 18.MAR.2017 02:04:56



Test Mode :	1Mbps	Temperature :	21~25°C
Test Channel :	78	Relative Humidity :	51~55%
		Test Engineer :	Silent Hai

1Mbps CSE Plot on Ch 78 between 30MHz ~ 3 GHz

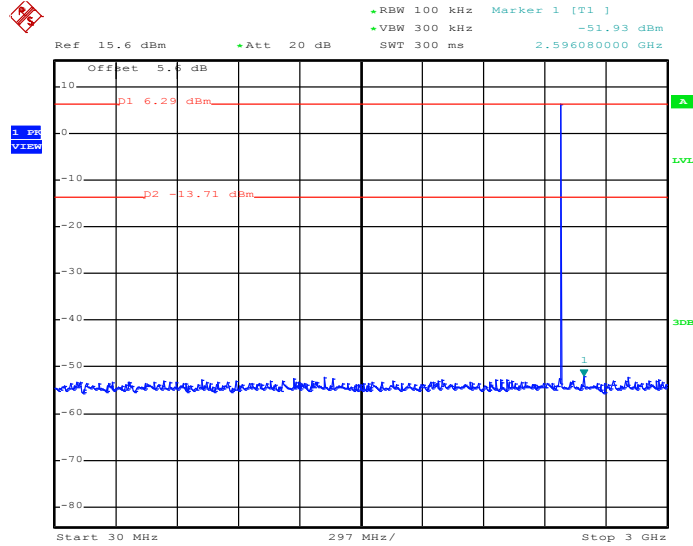

Date: 18.MAR.2017 02:05:57

1Mbps CSE Plot on Ch 78 between 2 GHz ~ 25 GHz

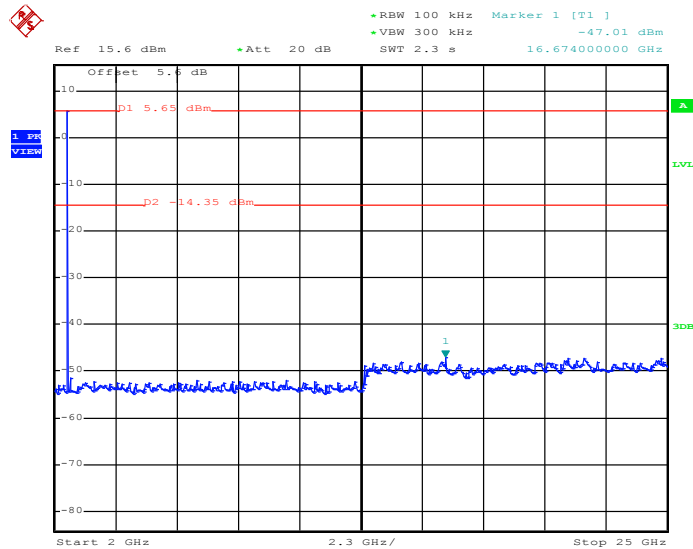

Date: 18.MAR.2017 02:06:19



Test Mode :	2Mbps	Temperature :	21~25°C
Test Channel :	00	Relative Humidity :	51~55%
		Test Engineer :	Silent Hai

2Mbps CSE Plot on Ch 00 between 30MHz ~ 3 GHz

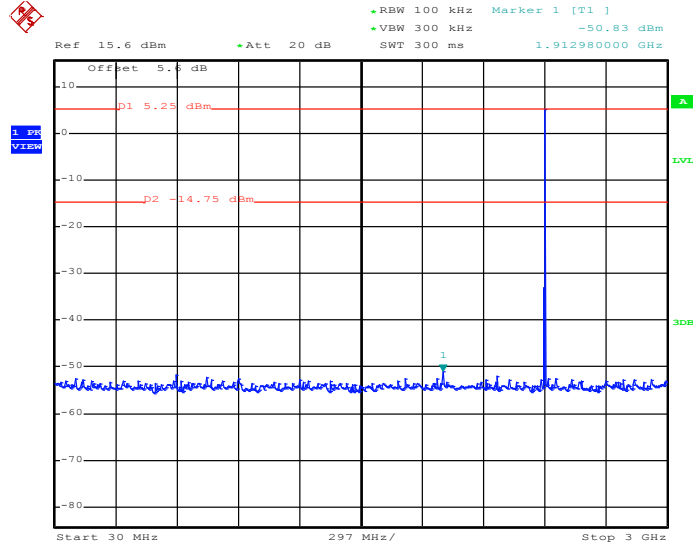

Date: 18.MAR.2017 02:16:37

2Mbps CSE Plot on Ch 00 between 2 GHz ~ 25 GHz

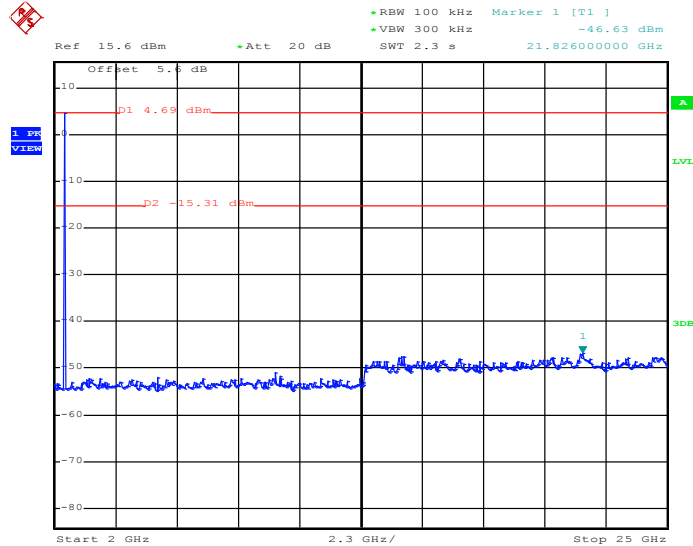

Date: 18.MAR.2017 02:16:59



Test Mode :	2Mbps	Temperature :	21~25°C
Test Channel :	39	Relative Humidity :	51~55%
		Test Engineer :	Silent Hai

2Mbps CSE Plot on Ch 39 between 30MHz ~ 3 GHz

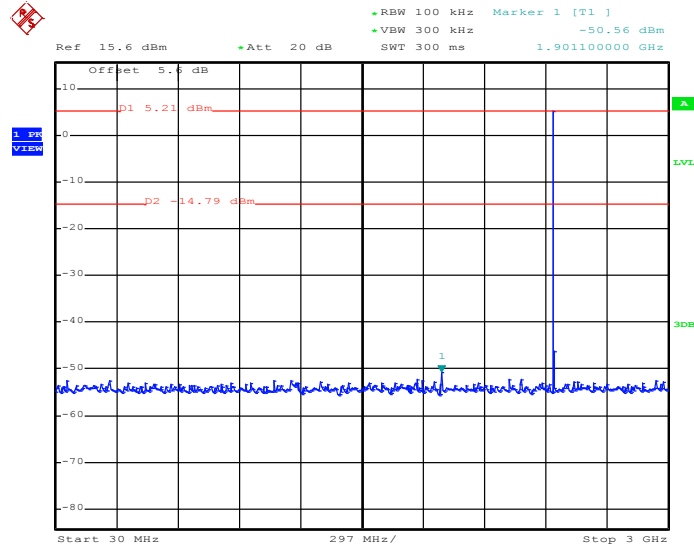

Date: 18.MAR.2017 02:18:01

2Mbps CSE Plot on Ch 39 between 2 GHz ~ 25 GHz

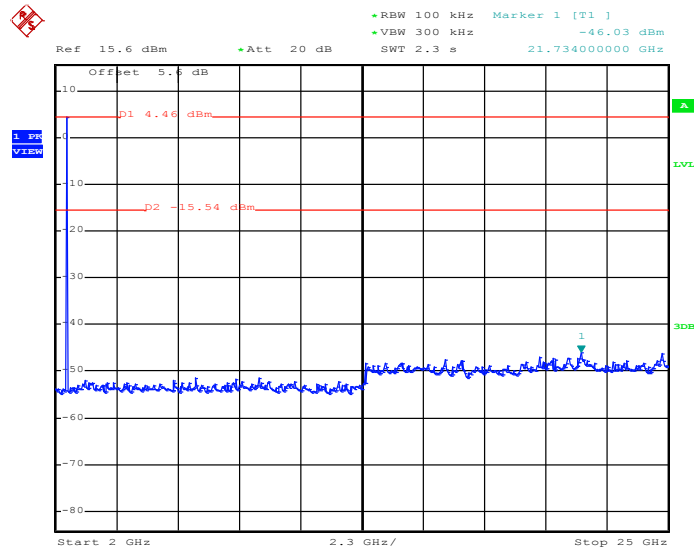

Date: 18.MAR.2017 02:19:12



Test Mode :	2Mbps	Temperature :	21~25°C
Test Channel :	78	Relative Humidity :	51~55%
		Test Engineer :	Silent Hai

2Mbps CSE Plot on Ch 78 between 30MHz ~ 3 GHz

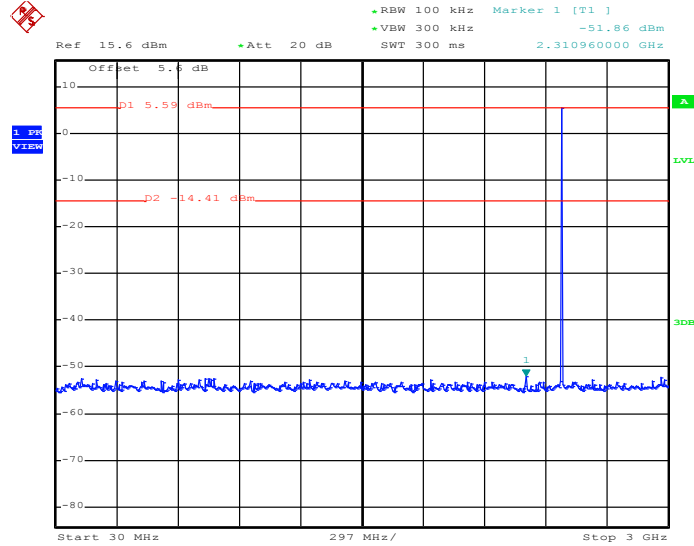

Date: 18.MAR.2017 02:20:30

2Mbps CSE Plot on Ch 78 between 2 GHz ~ 25 GHz

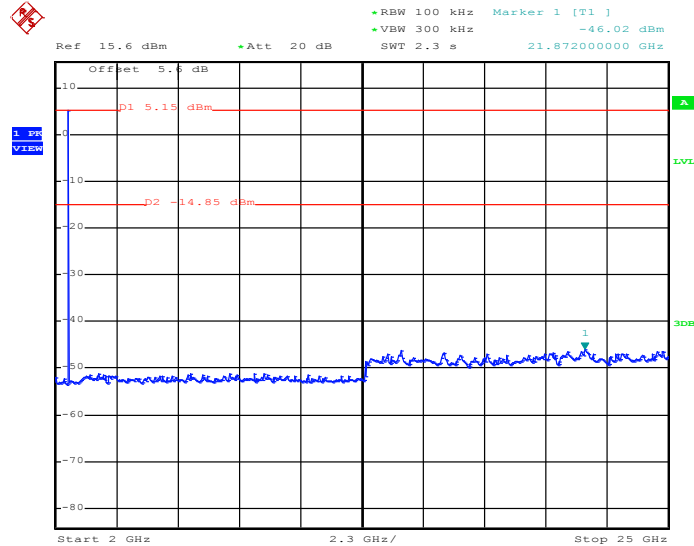

Date: 18.MAR.2017 03:09:21



Test Mode :	3Mbps	Temperature :	21~25°C
Test Channel :	00	Relative Humidity :	51~55%
		Test Engineer :	Silent Hai

3Mbps CSE Plot on Ch 00 between 30MHz ~ 3 GHz

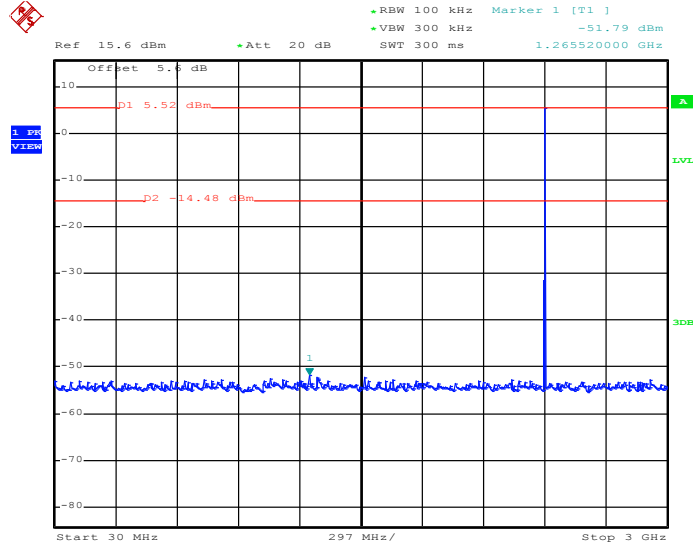

Date: 18.MAR.2017 02:37:18

3Mbps CSE Plot on Ch 00 between 2 GHz ~ 25 GHz

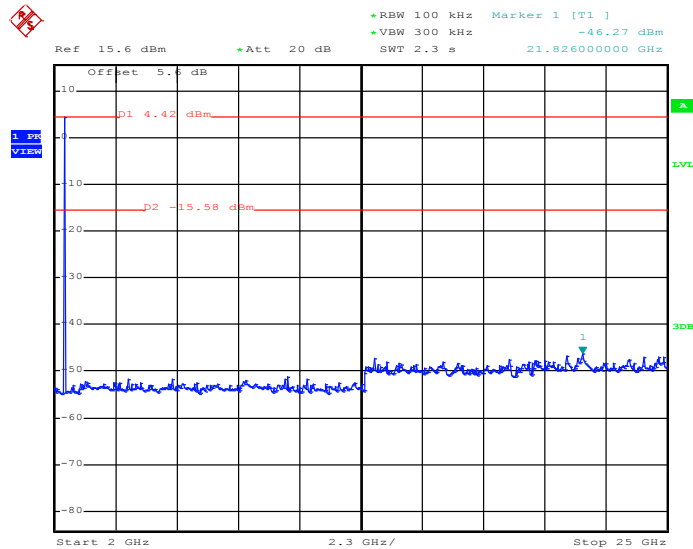

Date: 18.MAR.2017 02:39:31



Test Mode :	3Mbps	Temperature :	21~25°C
Test Channel :	39	Relative Humidity :	51~55%
		Test Engineer :	Silent Hai

3Mbps CSE Plot on Ch 39 between 30MHz ~ 3 GHz

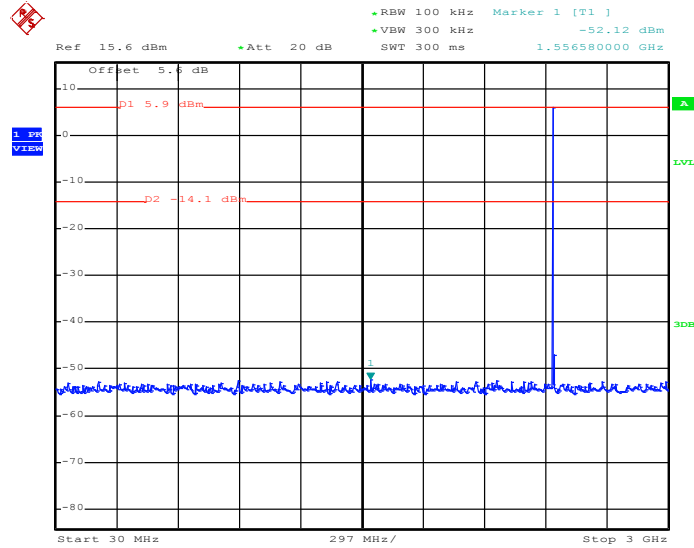

Date: 18.MAR.2017 02:46:48

3Mbps CSE Plot on Ch 39 between 2 GHz ~ 25 GHz

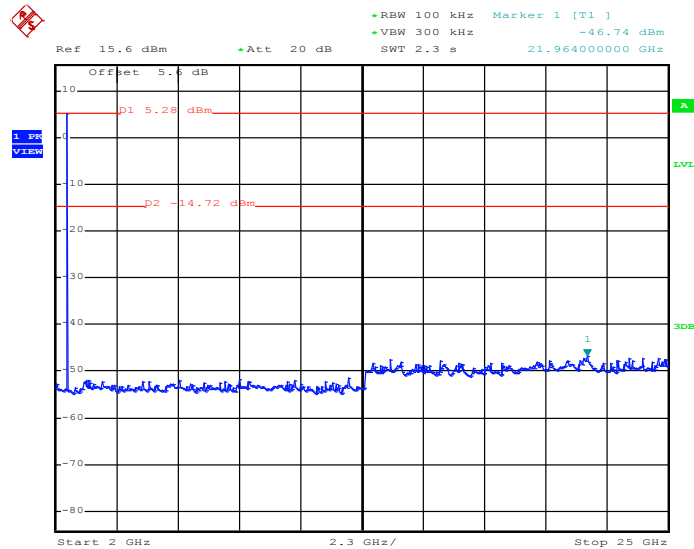

Date: 18.MAR.2017 02:43:06



Test Mode :	3Mbps	Temperature :	21~25°C
Test Channel :	78	Relative Humidity :	51~55%
		Test Engineer :	Silent Hai

3Mbps CSE Plot on Ch 78 between 30MHz ~ 3 GHz

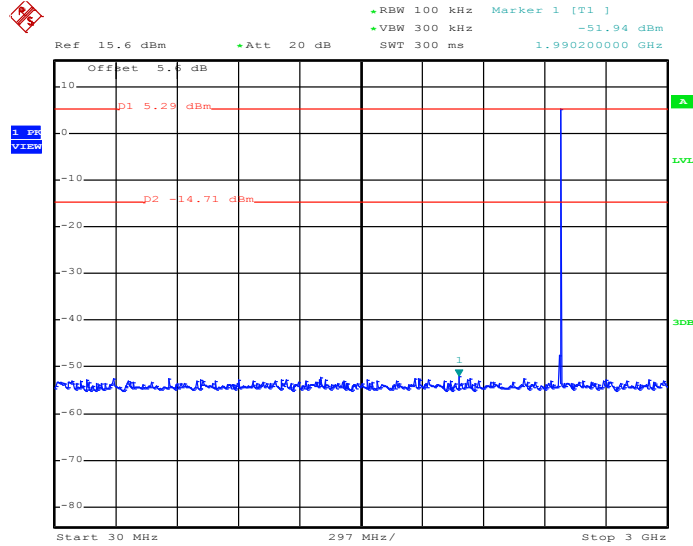

Date: 18.MAR.2017 02:55:07

3Mbps CSE Plot on Ch 78 between 2 GHz ~ 25 GHz

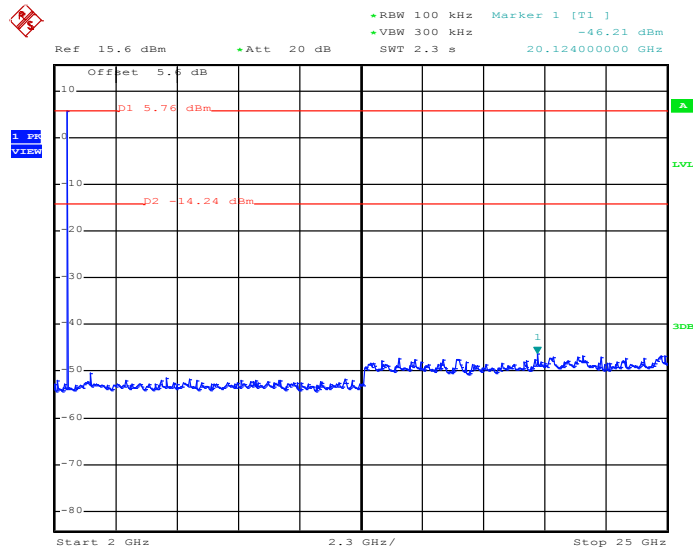

Date: 18.MAR.2017 02:53:30



3.8 Radiated Band Edges and Spurious Emission Measurement

3.8.1 Limit of Radiated Band Edges and Spurious Emission

In any 100 kHz bandwidth outside the intentional radiator frequency band, all harmonics/spurious must be at least 20 dB below the highest emission level within the authorized band. In addition, radiated emissions which fall in the restricted bands must also comply with the limits as below.

Frequency (MHz)	Field Strength (microvolts/meter)	Measurement Distance (meters)
0.009 – 0.490	2400/F(kHz)	300
0.490 – 1.705	24000/F(kHz)	30
1.705 – 30.0	30	30
30 – 88	100	3
88 – 216	150	3
216 - 960	200	3
Above 960	500	3

3.8.2 Measuring Instruments

The measuring equipment is listed in the section 4 of this test report.



3.8.3 Test Procedures

1. The EUT was placed on a turntable with 0.8 meter for frequency below 1GHz and 1.5 meter for frequency above 1GHz respectively above ground.
2. The EUT was set 3 meters from the interference receiving antenna, which was mounted on the top of a variable height antenna tower.
3. For each suspected emission, the EUT was arranged to its worst case and then tune the Antenna tower (from 1 m to 4 m) and turntable (from 0 degree to 360 degrees) to find the maximum reading. A pre-amp and a high pass filter are used for the test in order to get better signal level to comply with the guidelines.
4. Set to the maximum power setting and enable the EUT transmit continuously.
5. Use the following spectrum analyzer settings:
 - (1) Span shall wide enough to fully capture the emission being measured;
 - (2) Set RBW=100 kHz for $f < 1 \text{ GHz}$, RBW=1MHz for $f > 1\text{GHz}$; VBW \geq RBW; Sweep = auto; Detector function = peak; Trace = max hold for peak
 - (3) For average measurement: use duty cycle correction factor method per 15.35(c).
Duty cycle = On time/100 milliseconds
On time = $N_1 * L_1 + N_2 * L_2 + \dots + N_{n-1} * L_{n-1} + N_n * L_n$
Where N_1 is number of type 1 pulses, L_1 is length of type 1 pulses, etc.
Average Emission Level = Peak Emission Level + $20 * \log(\text{Duty cycle})$
6. Corrected Reading: Antenna Factor + Cable Loss + Read Level - Preamp Factor = Level

Note: The average levels were calculated from the peak level corrected with duty cycle correction factor (-24.85dB) derived from $20 \log(\text{dwell time}/100\text{ms})$. This correction is only for signals that hop with the fundamental signal, such as band-edge and harmonic. Other spurious signals that are independent of the hopping signal would not use this correction.

3.8.4 Test Setup

For radiated emissions below 30MHz

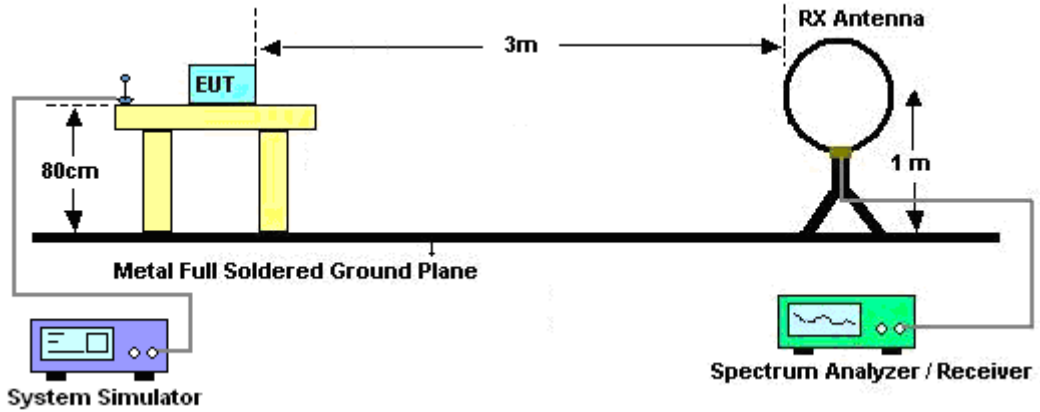

For radiated emissions from 30MHz to 1GHz

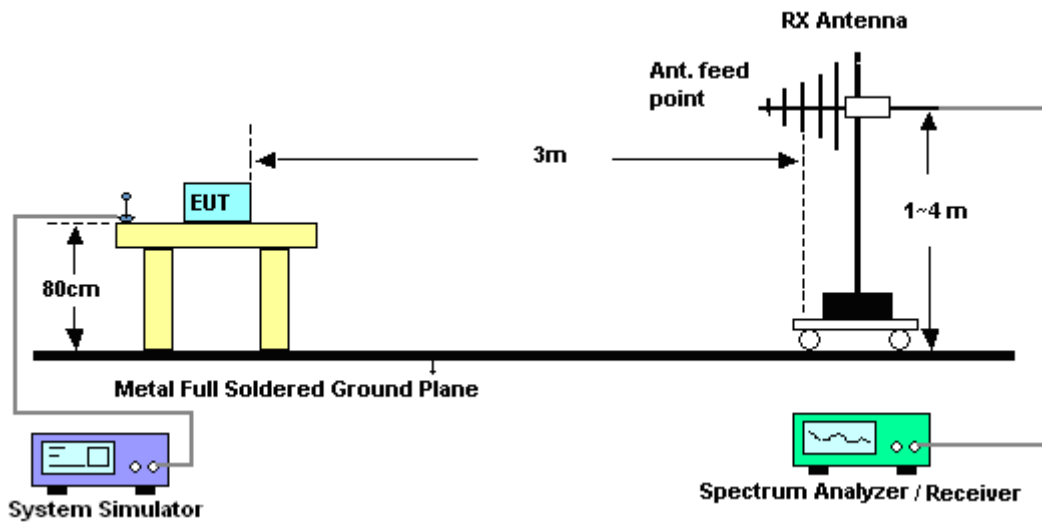

For radiated emissions above 1GHz

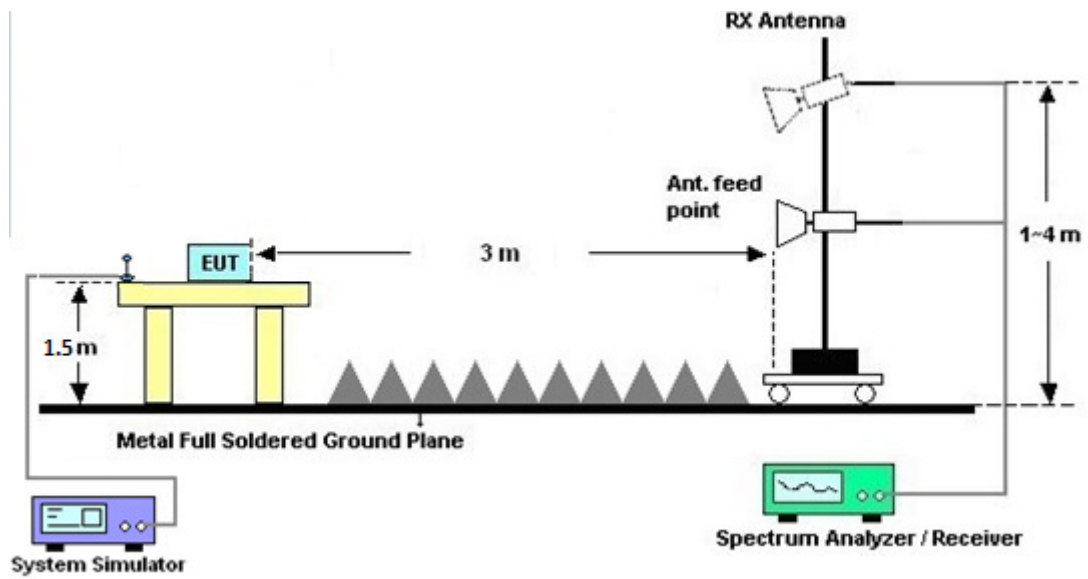

3.8.5 Test Results of Radiated Spurious Emissions (9 kHz ~ 30 MHz)

The low frequency, which started from 9 kHz to 30MHz, was pre-scanned and the result which was 20dB lower than the limit line was not reported.



3.8.6 Duty cycle correction factor for average measurement

DH5 on time (One Pulse) Plot on Channel 39

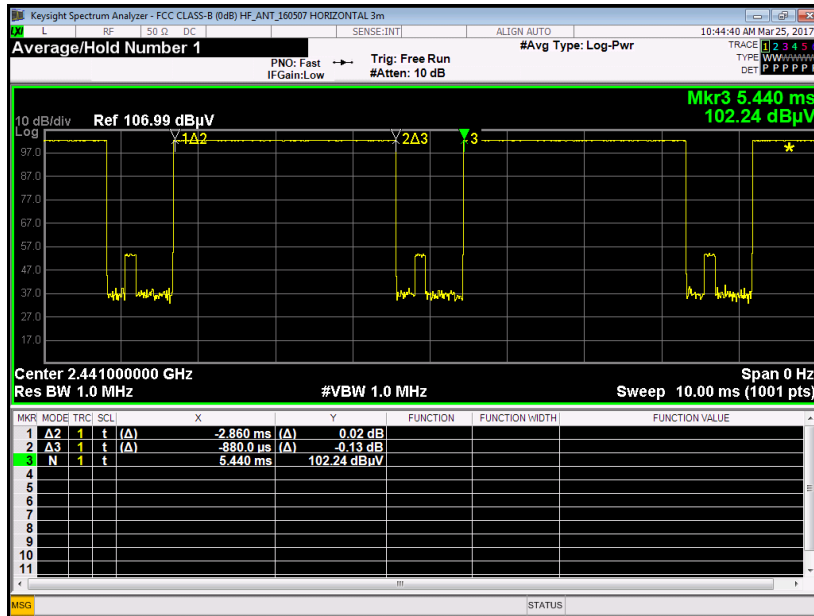

DH5 on time (Count Pulses) Plot on Channel 39

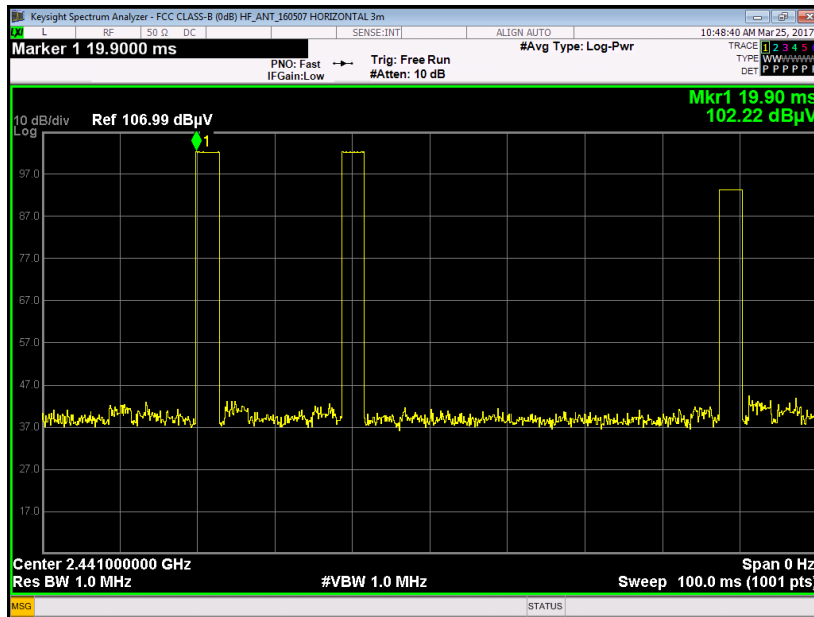

Note:

1. Worst case Duty cycle = on time/100 milliseconds = $2 * 2.86 / 100 = 5.72 \%$
2. Worst case Duty cycle correction factor = $20 * \log(\text{Duty cycle}) = -24.85 \text{ dB}$
3. DH5 has the highest duty cycle worst case and is reported.



Duty Cycle Correction Factor Consideration for AFH mode:

Bluetooth normal hopping rate is 1600Hz and reduced to 800Hz in AFH mode; due to the reduced number of hopping frequencies, with the same packet configuration the dwell time in each channel frequency within 100msec period is longer in AFH mode than normal mode.

In AFH mode, the minimum hopping frequencies are 20, to get the longest dwell time DH5 packet is observed; the period to have DH5 packet completing one hopping sequence is

$$2.86 \text{ ms} \times 20 \text{ channels} = 57.2 \text{ ms}$$

There cannot be 2 complete hopping sequences within 100ms period, considering the random hopping behavior, maximum 2 hops can be possibly observed within the period. $[100\text{ms} / 57.2\text{ms}] = 2 \text{ hops}$

Thus, the maximum possible ON time:

$$2.86 \text{ ms} \times 2 = 5.72 \text{ ms}$$

Worst case Duty Cycle Correction factor, which is derived from the maximum possible ON time,

$$20 \times \log(5.72 \text{ ms}/100\text{ms}) = -24.85 \text{ dB}$$

3.8.7 Test Result of Radiated Spurious at Band Edges

Please refer to Appendix A.

3.8.8 Test Result of Radiated Spurious Emission (30MHz ~ 10th Harmonic)

Please refer to Appendix A.



3.9 AC Conducted Emission Measurement

3.9.1 Limit of AC Conducted Emission

For equipment that is designed to be connected to the public utility (AC) power line, the radio frequency voltage that is conducted back onto the AC power line on any frequency or frequencies within the band 150 kHz to 30 MHz shall not exceed the limits in the following table.

Frequency of emission (MHz)	Conducted limit (dBµV)	
	Quasi-peak	Average
0.15-0.5	66 to 56*	56 to 46*
0.5-5	56	46
5-30	60	50

*Decreases with the logarithm of the frequency.

3.9.2 Measuring Instruments

The measuring equipment is listed in the section 4 of this test report.

3.9.3 Test Procedures

1. The EUT was placed 0.4 meter from the conducting wall of the shielding room was kept at least 80 centimeters from any other grounded conducting surface.
2. Connect EUT to the power mains through a line impedance stabilization network (LISN).
3. All the support units are connecting to the other LISN.
4. The LISN provides 50 ohm coupling impedance for the measuring instrument.
5. The FCC states that a 50 ohm, 50 microhenry LISN should be used.
6. Both sides of AC line were checked for maximum conducted interference.
7. The frequency range from 150 kHz to 30 MHz was searched.
8. Set the test-receiver system to Peak Detect Function and specified bandwidth (IF Bandwidth = 9kHz) with Maximum Hold Mode. Then measurement is also conducted by Average Detector and Quasi-Peak Detector Function respectively.

3.9.4 Test Setup

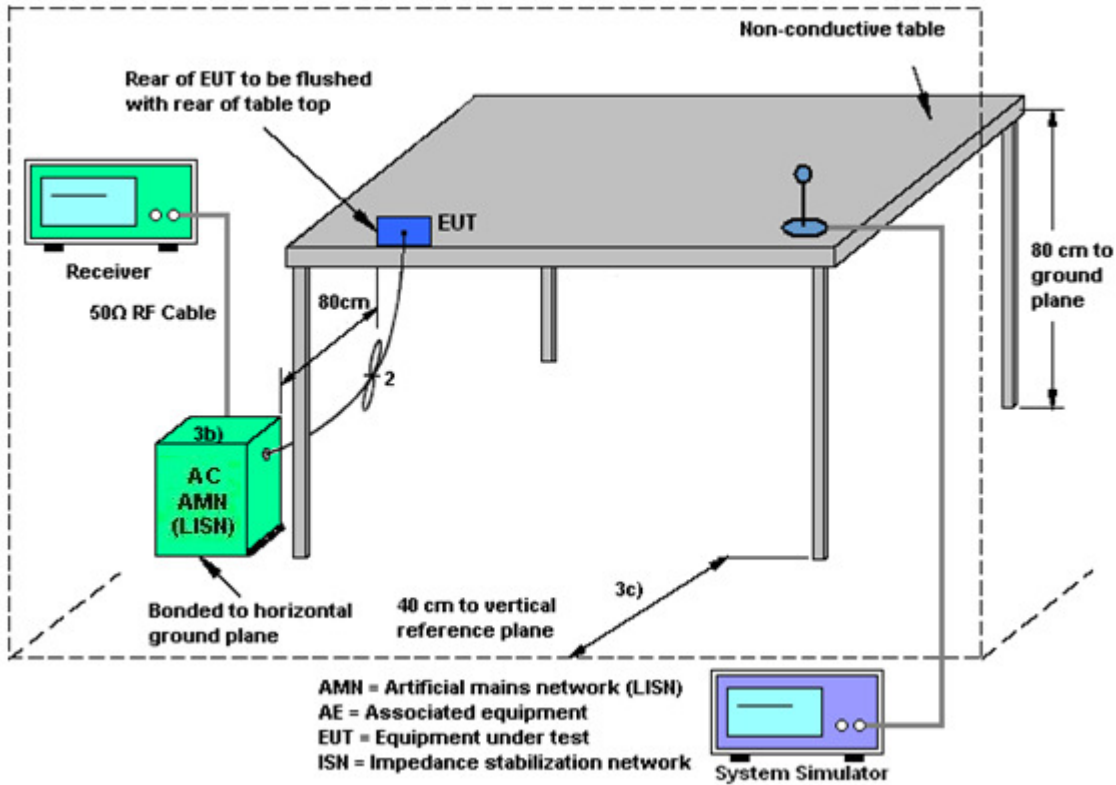



3.9.5 Test Result of AC Conducted Emission

Test Mode :	Mode 1	Temperature :	22~24°C
Test Engineer :	Amos Zhang	Relative Humidity :	42~46%
Test Voltage :	120Vac / 60Hz	Phase :	Line
Function Type :	GSM850 Idle + Bluetooth Link + WLAN (2.4G) Link + Earphone + USB Cable (Charging from Adapter)		

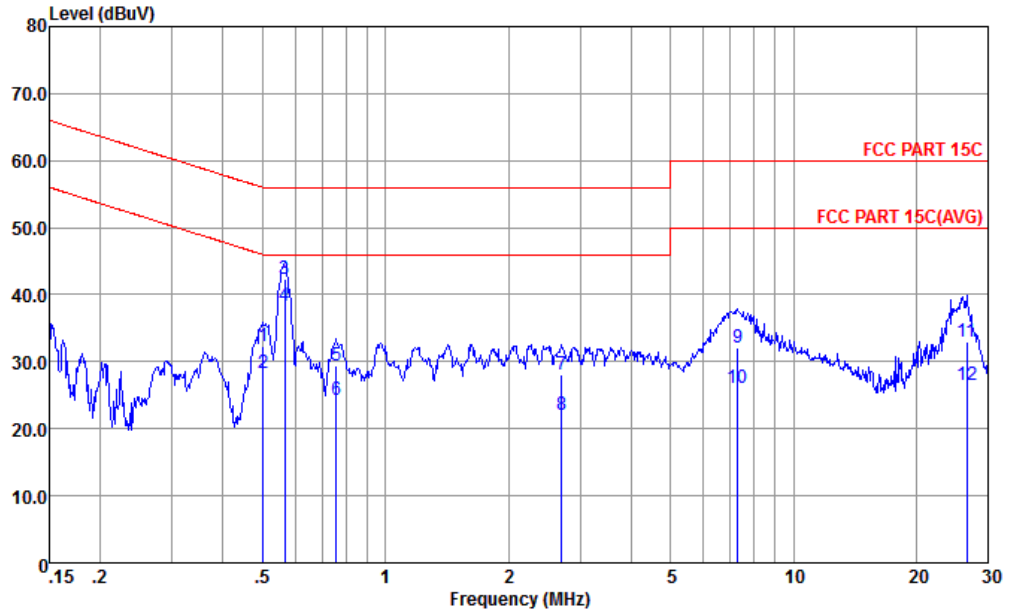

Site : CO01-KS
Condition : FCC PART 15C LISN-L-20151024 LINE

mode : Mode 1
IMEI : 357682080000874

	Freq	Level	Over Limit	Limit Line	Read Level	LISN Factor	Cable Loss	Remark
	MHz	dBuV	dB	dBuV	dBuV	dB	dB	
1	0.502	32.22	-23.78	56.00	21.80	0.23	10.19	QP
2	0.502	28.32	-17.68	46.00	17.90	0.23	10.19	Average
3	0.567	42.32	-13.68	56.00	31.91	0.23	10.18	QP
4 *	0.567	38.32	-7.68	46.00	27.91	0.23	10.18	Average
5	0.759	29.32	-26.68	56.00	18.91	0.24	10.17	QP
6	0.759	24.32	-21.68	46.00	13.91	0.24	10.17	Average
7	2.707	27.99	-28.01	56.00	17.60	0.18	10.21	QP
8	2.707	21.99	-24.01	46.00	11.60	0.18	10.21	Average
9	7.290	32.12	-27.88	60.00	21.60	0.23	10.29	QP
10	7.290	26.12	-23.88	50.00	15.60	0.23	10.29	Average
11	26.558	32.90	-27.10	60.00	21.90	0.22	10.78	QP
12	26.558	26.60	-23.40	50.00	15.60	0.22	10.78	Average



Test Mode :	Mode 1	Temperature :	22~24°C
Test Engineer :	Amos Zhang	Relative Humidity :	42~46%
Test Voltage :	120Vac / 60Hz	Phase :	Neutral
Function Type :	GSM850 Idle + Bluetooth Link + WLAN (2.4G) Link + Earphone + USB Cable (Charging from Adapter)		

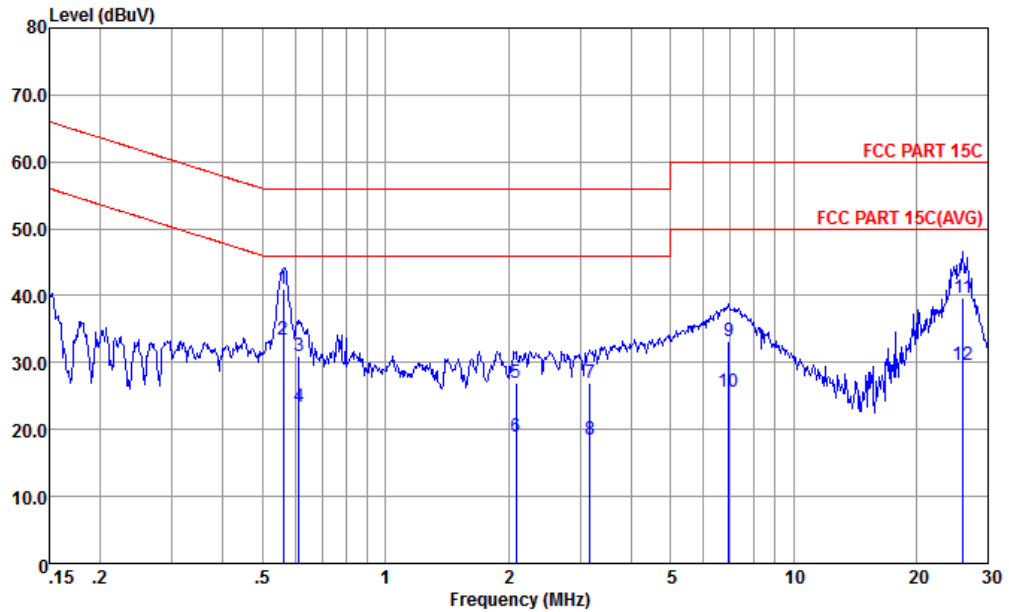

Site : CO01-KS
Condition : FCC PART 15C LISN-N-20151024 NEUTRAL

mode : Mode 1
IMEI : 357682080000874

	Freq	Level	Over Limit	Limit Line	Read Level	LISN Factor	Cable Loss	Remark
	MHz	dBuV	dB	dBuV	dBuV	dB	dB	
1	0.561	41.11	-14.89	56.00	30.60	0.33	10.18	QP
2 *	0.561	33.41	-12.59	46.00	22.90	0.33	10.18	Average
3	0.614	31.01	-24.99	56.00	20.50	0.33	10.18	QP
4	0.614	23.41	-22.59	46.00	12.90	0.33	10.18	Average
5	2.088	26.87	-29.13	56.00	16.30	0.38	10.19	QP
6	2.088	18.87	-27.13	46.00	8.30	0.38	10.19	Average
7	3.173	26.89	-29.11	56.00	16.30	0.37	10.22	QP
8	3.173	18.49	-27.51	46.00	7.90	0.37	10.22	Average
9	6.951	33.17	-26.83	60.00	22.60	0.29	10.28	QP
10	6.951	25.67	-24.33	50.00	15.10	0.29	10.28	Average
11	26.001	39.60	-20.40	60.00	28.60	0.24	10.76	QP
12	26.001	29.60	-20.40	50.00	18.60	0.24	10.76	Average



3.10 Antenna Requirements

3.10.1 Standard Applicable

If directional gain of transmitting antennas is greater than 6dBi, the power shall be reduced by the same level in dB comparing to gain minus 6dBi. The use of a permanently attached antenna or of an antenna that uses a unique coupling to the intentional radiator shall be considered sufficient to comply with the rule.

3.10.2 Antenna Anti-Replacement Construction

An embedded-in antenna design is used.

3.10.3 Antenna Gain

The antenna peak gain of EUT is less than 6 dBi. Therefore, it is not necessary to reduce maximum peak output power limit.



4 List of Measuring Equipment

Instrument	Manufacturer	Model No.	Serial No.	Characteristics	Calibration Date	Test Date	Due Date	Remark
Spectrum Analyzer	R&S	FSV40	101040	10Hz~40GHz	Aug. 09, 2016	Mar. 16, 2017~ Mar. 18, 2017	Aug. 08, 2017	Conducted (TH01-KS)
Spectrum Analyzer	R&S	FSP40	100319	9kHz~40GHz	Oct. 13, 2016	Mar. 16, 2017~ Mar. 18, 2017	Oct. 12, 2017	Conducted (TH01-KS)
Pulse Power Sensor	Anritsu	MA2411B	0917070	300MHz~40GHz	Jan. 19, 2017	Mar. 16, 2017~ Mar. 18, 2017	Jan. 18, 2018	Conducted (TH01-KS)
Power Meter	Anritsu	ML2495A	1005002	50MHz Bandwidth	Jan. 19, 2017	Mar. 16, 2017~ Mar. 18, 2017	Jan. 18, 2018	Conducted (TH01-KS)
EMI Test Receiver&SA	KEYSIGHT	N9038A	MY54450083	20Hz~8.4GHz	May 07, 2016	Mar. 25, 2017~ Apr. 13, 2017	May 06, 2017	Radiation (03CH03-SZ)
EXA Spectrum Analyzer	KEYSIGHT	N9010A	MY55150246	10Hz~44GHz	May 07, 2016	Mar. 25, 2017~ Apr. 13, 2017	May 06, 2017	Radiation (03CH03-SZ)
Loop Antenna	R&S	HFH2-Z2	100354	9kHz~30MHz	May 07, 2016	Mar. 25, 2017~ Apr. 13, 2017	May 06, 2017	Radiation (03CH03-SZ)
Bilog Antenna	TeseQ	CBL6112D	35408	30MHz~2GHz	May 21, 2016	Mar. 25, 2017~ Apr. 13, 2017	May 20, 2017	Radiation (03CH03-SZ)
Double Ridge Horn Antenna	SCHWARZBECK	BBHA9120D	9120D-1355	1GHz~18GHz	May 07, 2016	Mar. 25, 2017~ Apr. 13, 2017	May 06, 2017	Radiation (03CH03-SZ)
SHF-EHF Horn	com-power	AH-840	101071	18GHz~40GHz	Aug. 10, 2016	Mar. 25, 2017~ Apr. 13, 2017	Aug. 09, 2017	Radiation (03CH03-SZ)
Amplifier	Burgeon	BPA-530	102210	0.01Hz~3000MHz	Oct. 11, 2016	Mar. 25, 2017~ Apr. 13, 2017	Oct. 10, 2017	Radiation (03CH03-SZ)
Amplifier	Agilent Technologies	83017A	MY39501302	500MHz~26.5GHz	Jan. 06, 2017	Mar. 25, 2017~ Apr. 13, 2017	Jan. 05, 2018	Radiation (03CH03-SZ)
HF Amplifier	MITEQ	TTA1840-35-HG	1871923	18GHz~40GHz	Jul. 16, 2016	Mar. 25, 2017~ Apr. 13, 2017	Jul. 15, 2017	Radiation (03CH03-SZ)
AC Power Source	Chroma	61601	616010001985	N/A	NCR	Mar. 25, 2017~ Apr. 13, 2017	NCR	Radiation (03CH03-SZ)
Turn Table	EM	EM1000	N/A	0~360 degree	NCR	Mar. 25, 2017~ Apr. 13, 2017	NCR	Radiation (03CH03-SZ)
Antenna Mast	EM	EM1000	N/A	1 m~4 m	NCR	Mar. 25, 2017~ Apr. 13, 2017	NCR	Radiation (03CH03-SZ)
EMI Receiver	R&S	ESCI7	100768	9kHz~7GHz	Apr. 29, 2016	Apr. 12, 2017	Apr. 28, 2017	Conduction (CO01-KS)
AC LISN	MessTec	AN3016	060103	9kHz~30MHz	Oct. 13, 2016	Apr. 12, 2017	Oct. 12, 2017	Conduction (CO01-KS)
AC LISN (for auxiliary equipment)	MessTec	AN3016	060105	9kHz~30MHz	Oct. 13, 2016	Apr. 12, 2017	Oct. 12, 2017	Conduction (CO01-KS)
AC Power Source	Chroma	61602	ABP000000811	AC 0V~300V, 45Hz~1000Hz	Oct. 13, 2016	Apr. 12, 2017	Oct. 12, 2017	Conduction (CO01-KS)

NCR: No Calibration Required



5 Uncertainty of Evaluation

Uncertainty of Conducted Emission Measurement (150 kHz ~ 30 MHz)

Measuring Uncertainty for a Level of Confidence of 95% ($U = 2Uc(y)$)	2.3dB
---	-------

Uncertainty of Radiated Emission Measurement (30 MHz ~ 1000 MHz)

Measuring Uncertainty for a Level of Confidence of 95% ($U = 2Uc(y)$)	5.1dB
---	-------

Uncertainty of Radiated Emission Measurement (1000 MHz ~ 18000 MHz)

Measuring Uncertainty for a Level of Confidence of 95% ($U = 2Uc(y)$)	5.0dB
---	-------

Uncertainty of Radiated Emission Measurement (18000 MHz ~ 40000 MHz)

Measuring Uncertainty for a Level of Confidence of 95% ($U = 2Uc(y)$)	5.0dB
---	-------



Appendix A. Radiated Spurious Emission

2.4GHz 2400~2483.5MHz

BT (Band Edge @ 3m)

BT	Note	Frequency	Level	Over Limit	Limit Line	Read Level	Antenna Factor	Cable Loss	Preamp Factor	Ant Pos	Table Pos	Peak Avg.	Pol.	
		(MHz)	(dBμV/m)	(dB)	(dBμV/m)	(dBμV)	(dB/m)	(dB)	(dB)	(cm)	(deg)	(P/A)	(H/V)	
BT CH00 2402MHz		2384.88	41.05	-32.95	74	42.09	27.26	5.92	34.22	150	275	P	H	
		2384.88	16.2	-37.8	54	-	-	-	-	150	275	A	H	
	*	2402	99.88	-	-	100.87	27.29	5.92	34.2	150	275	P	H	
	*	2402	75.03	-	-	-	-	-	-	150	275	A	H	
		2385.92	41.06	-32.94	74	42.07	27.29	5.92	34.22	152	236	P	V	
		2385.92	16.21	-37.79	54	-	-	-	-	152	236	A	V	
	*	2402	89.37	-	-	90.36	27.29	5.92	34.2	152	236	P	V	
	*	2402	64.52	-	-	-	-	-	-	152	236	A	V	
BT CH 39 2441MHz		2345.53	41.24	-32.76	74	42.41	27.19	5.88	34.24	182	142	P	H	
		2345.53	16.39	-37.61	54	-	-	-	-	182	142	A	H	
	*	2441	101.57	-	-	102.39	27.4	5.93	34.15	182	142	P	H	
	*	2441	76.72	-	-	-	-	-	-	182	142	A	H	
		2483.5	40.94	-33.06	74	41.65	27.47	5.95	34.13	182	142	P	H	
		2483.5	16.09	-37.91	54	-	-	-	-	182	142	A	H	
		2337.74	41.07	-32.93	74	42.3	27.19	5.84	34.26	150	317	P	V	
		2337.74	16.22	-37.78	54	-	-	-	-	150	317	A	V	
		2441	92.01				92.83	27.4	5.93	34.15	150	317	P	V
	*	2441	67.16	-	-	-	-	-	-	150	317	A	V	
		2489.74	41.14	-32.86	74	41.82	27.5	5.95	34.13	150	317	P	V	
		2489.74	16.29	-37.71	54	-	-	-	-	150	317	A	V	



BT CH 78 2480MHz	*	2480	100.21	-	-	100.92	27.47	5.95	34.13	174	146	P	H
	*	2480	75.36	-	-	-	-	-	-	174	146	A	H
		2483.5	43.57	-30.43	74	44.28	27.47	5.95	34.13	174	146	P	H
		2483.5	18.72	-35.28	54	-	-	-	-	174	146	A	H
	*	2480	90.6	-	-	91.31	27.47	5.95	34.13	150	321	P	V
	*	2480	65.75	-	-	-	-	-	-	150	321	A	V
		2494.47	41.96	-32.04	74	42.62	27.5	5.95	34.11	150	321	P	V
		2494.47	17.11	-36.89	54	-	-	-	-	150	321	A	V
Remark	1. No other spurious found. 2. All results are PASS against Peak and Average limit line.												



2.4GHz 2400~2483.5MHz
BT (Harmonic @ 3m)

BT	Note	Frequency (MHz)	Level (dBμV/m)	Over Limit (dB)	Limit Line (dBμV/m)	Read Level (dBμV)	Antenna Factor (dB/m)	Cable Loss (dB)	Preamp Factor (dB)	Ant Pos (cm)	Table Pos (deg)	Peak Avg. (P/A)	Pol. (H/V)
BT CH 00 2402MHz		4804	43.15	-30.85	74	60.1	32.52	8.87	58.34	151	219	P	H
		4804	18.3	-35.7	54	-	-	-	-	151	219	A	H
		4804	43.83	-30.17	74	60.78	32.52	8.87	58.34	151	219	P	V
		4804	18.98	-35.02	54	-	-	-	-	151	219	A	V
BT CH 39 2441MHz		4882	43.27	-30.73	74	60.12	32.66	8.82	58.33	150	258	P	H
		4882	18.42	-35.58	54	-	-	-	-	150	258	A	H
		7323	50.09	-23.91	74	60.81	37.67	11.02	59.41	152	309	P	H
		7323	25.24	-28.76	54	-	-	-	-	152	309	A	H
		4882	43.4	-30.6	74	60.25	32.66	8.82	58.33	150	258	P	V
		4882	18.55	-35.45	54	-	-	-	-	150	258	A	V
		7323	50.13	-23.87	74	60.85	37.67	11.02	59.41	152	309	P	V
		7323	25.28	-28.72	54	-	-	-	-	152	309	A	V
BT CH 78 2480MHz		4960	43.35	-30.65	74	60.07	32.83	8.77	58.32	158	289	P	H
		4960	18.5	-35.5	54	-	-	-	-	158	289	A	H
		7440	49.93	-24.07	74	60.76	37.69	10.95	59.47	158	273	P	H
		7440	25.08	-28.92	54	-	-	-	-	158	273	A	H
		4960	44.13	-29.87	74	60.85	32.83	8.77	58.32	158	289	P	V
		4960	19.28	-34.72	54	-	-	-	-	158	289	A	V
		7440	48.88	-25.12	74	59.71	37.69	10.95	59.47	158	273	P	V
		7440	24.03	-29.97	54	-	-	-	-	158	273	A	V
Remark	1. No other spurious found. 2. All results are PASS against Peak and Average limit line.												



Emission below 1GHz

2.4GHz BT (LF)

BT	Note	Frequency	Level	Over	Limit	Read	Antenna	Cable	Preamp	Ant	Table	Peak	Pol.
		(MHz)	(dBμV/m)	(dB)	(dBμV/m)	(dBμV)	(dB/m)	(dB)	(dB)	(cm)	(deg)	(P/A)	(H/V)
2.4GHz BT LF		30.97	27.79	-12.21	40	33.17	26.28	0.34	32	-	-	P	H
		101.78	26.48	-17.02	43.5	38.66	18.76	0.8	31.74	-	-	P	H
		154.16	28.92	-14.58	43.5	41.71	17.63	1.08	31.5	-	-	P	H
		202.66	36.48	-7.02	43.5	50.81	15.74	1.26	31.33	120	50	P	H
		444.19	30.91	-15.09	46	35.02	25.03	2.02	31.16	-	-	P	H
		718.7	30.5	-15.5	46	31.54	27.55	2.65	31.24	-	-	P	H
		44.55	29.7	-10.3	40	41.52	19.7	0.46	31.98	130	55	P	V
		99.84	28.74	-14.76	43.5	40.89	18.8	0.79	31.74	-	-	P	V
		204.6	29.88	-13.62	43.5	44.12	15.83	1.27	31.34	-	-	P	V
		427.7	28.54	-17.46	46	32.35	25.39	1.99	31.19	-	-	P	V
		862.26	31.98	-14.02	46	32.12	28.2	2.9	31.24	-	-	P	V
		944.71	32.05	-13.95	46	30.88	29.31	3.06	31.2	-	-	P	V

Remark	1. No other spurious found.
	2. All results are PASS against limit line.



Note symbol

*	Fundamental Frequency which can be ignored. However, the level of any unwanted emissions shall not exceed the level of the fundamental frequency.
!	Test result is over limit line.
P/A	Peak or Average
H/V	Horizontal or Vertical



A calculation example for radiated spurious emission is shown as below:

WIFI	Note	Frequency	Level	Over	Limit	Read	Antenna	Cable	Preamp	Ant	Table	Peak	Pol.
Ant.				Limit	Line	Level	Factor	Loss	Factor	Pos	Pos	Avg.	
1+2		(MHz)	(dBμV/m)	(dB)	(dBμV/m)	(dBμV)	(dB/m)	(dB)	(dB)	(cm)	(deg)	(P/A)	(H/V)
802.11b		2390	55.45	-18.55	74	54.51	32.22	4.58	35.86	103	308	P	H
CH 01													
2412MHz		2390	43.54	-10.46	54	42.6	32.22	4.58	35.86	103	308	A	H

- Level(dBμV/m) =
Antenna Factor(dB/m) + Cable Loss(dB) + Read Level(dBμV) - Preamp Factor(dB)
- Over Limit(dB) = Level(dBμV/m) – Limit Line(dBμV/m)

For Peak Limit @ 2390MHz:

- Level(dBμV/m)
= Antenna Factor(dB/m) + Cable Loss(dB) + Read Level(dBμV) - Preamp Factor(dB)
= 32.22(dB/m) + 4.58(dB) + 54.51(dBμV) – 35.86 (dB)
= 55.45 (dBμV/m)
- Over Limit(dB)
= Level(dBμV/m) – Limit Line(dBμV/m)
= 55.45(dBμV/m) – 74(dBμV/m)
= -18.55(dB)

For Average Limit @ 2390MHz:

- Level(dBμV/m)
= Antenna Factor(dB/m) + Cable Loss(dB) + Read Level(dBμV) - Preamp Factor(dB)
= 32.22(dB/m) + 4.58(dB) + 42.6(dBμV) – 35.86 (dB)
= 43.54 (dBμV/m)
- Over Limit(dB)
= Level(dBμV/m) – Limit Line(dBμV/m)
= 43.54(dBμV/m) – 54(dBμV/m)
= -10.46(dB)

Both peak and average measured complies with the limit line, so test result is “PASS”.