



FCC RF Test Report

APPLICANT : Bullitt Group
EQUIPMENT : Smartphone
BRAND NAME : KODAK
MODEL NAME : EKTRA
MARKETING NAME : KODAK EKTRA Smartphone
FCC ID : ZL5EKTRA
STANDARD : FCC Part 15 Subpart E §15.407
CLASSIFICATION : (NII) Unlicensed National Information Infrastructure

The product was received on Mar. 07, 2017 and testing was completed on Apr. 13, 2017. We, Sporton International (KunShan) INC., would like to declare that the tested sample has been evaluated in accordance with the test procedures and has been in compliance with the applicable technical standards.

The test results in this report apply exclusively to the tested model / sample. Without written approval of Sporton International (KunShan) INC., the test report shall not be reproduced except in full.

Prepared by: James Huang / Manager

Approved by: Jones Tsai / Manager



Sporton International (KunShan) INC.

No.3-2, Pingxiang Road, Kunshan Development Zone, Jiangsu, China



TABLE OF CONTENTS

REVISION HISTORY 3

SUMMARY OF TEST RESULT 4

1 GENERAL DESCRIPTION 5

 1.1. Applicant 5

 1.2. Manufacturer 5

 1.3. Product Feature of Equipment Under Test 5

 1.4. Product Specification of Equipment Under Test 6

 1.5. Modification of EUT 6

 1.6. Testing Location 6

 1.7. Applicable Standards 7

2 TEST CONFIGURATION OF EQUIPMENT UNDER TEST 8

 2.1 Carrier Frequency and Channel 8

 2.2 Test Mode 9

 2.3 Connection Diagram of Test System 10

 2.4 Support Unit used in test configuration and system 11

 2.5 EUT Operation Test Setup 11

 2.6 Measurement Results Explanation Example 12

3 TEST RESULT 13

 3.1 6dB and 26dB and 99% Occupied Bandwidth Measurement 13

 3.2 Maximum Conducted Output Power Measurement 16

 3.3 Power Spectral Density Measurement 17

 3.4 Unwanted Emissions Measurement 20

 3.5 AC Conducted Emission Measurement 25

 3.6 Frequency Stability Measurement 29

 3.7 Automatically Discontinue Transmission 30

 3.8 Antenna Requirements 31

4 LIST OF MEASURING EQUIPMENT 32

5 UNCERTAINTY OF EVALUATION 33

APPENDIX A. CONDUCTED TEST RESULTS

APPENDIX B. RADIATED SPURIOUS EMISSION

APPENDIX C. DUTY CYCLE PLOTS

APPENDIX D. SETUP PHOTOGRAPHS



REVISION HISTORY

REPORT NO.	VERSION	DESCRIPTION	ISSUED DATE
FR730704F	Rev. 01	Initial issue of report	Apr. 14, 2017



SUMMARY OF TEST RESULT

Report Section	FCC Rule	Description	Limit	Result	Remark
3.1	15.403(i)	6dB, 26dB and 99% Occupied Bandwidth	> 500kHz	Pass	-
3.2	15.407(a)	Maximum Conducted Output Power	≤ 30 dBm	Pass	-
3.3	15.407(a)	Power Spectral Density	≤ 30 dBm/500kHz	Pass	-
3.4	15.407(b)	Unwanted Emissions	15.407(b)(4)(i) 15.209(a)	Pass	Under limit 2.67 dB at 11650.000 MHz
3.5	15.207	AC Conducted Emission	15.207(a)	Pass	Under limit 11.69 dB at 0.567 MHz
3.6	15.407(g)	Frequency Stability	Within Operation Band	Pass	-
3.7	15.407(c)	Automatically Discontinue Transmission	Discontinue Transmission	Pass	-
3.8	15.203 & 15.407(a)	Antenna Requirement	N/A	Pass	-



1 General Description

1.1. Applicant

Bullitt Group

One Valpy, Valpy Street, Reading, Berkshire, RG1 1AR, UK

1.2. Manufacturer

Shanghai Sunrise Simcom Limited

No. 888, Shengli Rd., Qingpu, Shanghai, P.R.China 201700

1.3. Product Feature of Equipment Under Test

Product Feature	
Equipment	Smartphone
Brand Name	KODAK
Model Name	EKTRA
Marketing Name	KODAK EKTRA Smartphone
FCC ID	ZL5EKTRA
EUT supports Radios application	GSM/GPRS/EGPRS/WCDMA/HSPA/ DC-HSDPA/HSPA+/LTE/NFC WLAN 2.4GHz 802.11b/g/n HT20/HT40 WLAN 5GHz 802.11a/n HT20/HT40 WLAN 5GHz 802.11ac VHT20/VHT40/VHT80 Bluetooth v3.0 + EDR/Bluetooth v4.0 LE/Bluetooth v4.1 LE
IMEI Code	Conducted: 357682080001005 Conduction: 357682080000874 Radiation: NA
EUT Stage	Identical Prototype

Remark: The above EUT's information was declared by manufacturer. Please refer to the specifications or user's manual for more detailed description.



1.4. Product Specification of Equipment Under Test

Standards-related Product Specification	
Tx/Rx Channel Frequency Range	5745 MHz ~ 5825 MHz
Maximum Output Power	802.11a : 12.26 dBm / 0.0168 W 802.11n HT20 : 12.11 dBm / 0.0163 W 802.11n HT40 : 12.19 dBm / 0.0166 W 802.11ac VHT80 : 12.08 dBm / 0.0161 W
99% Occupied Bandwidth	802.11a : 17.93 MHz 802.11n HT20 : 18.28 MHz 802.11n HT40 : 36.46 MHz 802.11ac VHT80 : 75.52 MHz
Type of Modulation	802.11a/n : OFDM (BPSK / QPSK / 16QAM / 64QAM) 802.11ac : OFDM (BPSK / QPSK / 16QAM / 64QAM / 256QAM)
Antenna Type / Gain	PIFA Antenna with gain -3 dBi

Note: For 802.11n HT20 / ac VHT20 and 802.11n HT40 / ac VHT40 mode, the whole testing have assessed only 802.11n HT20/ HT40 by referring to their maximum conducted power.

1.5. Modification of EUT

No modifications are made to the EUT during all test items.

1.6. Testing Location

Test Site	Sporton International (KunShan) INC.	
Test Site Location	No.3-2, Pingxiang Road, Kunshan Development Zone, Jiangsu, China TEL: +86-0512-5790-0158 FAX: +86-0512-5790-0958	
Test Site No.	Sporton Site No.	
	TH01-KS	CO01-KS

Test Site	SPORTON International (ShenZhen) INC.	
Test Site Location	No. 3 Building, the third floor of south, Shahe River west, Fengzeyuan warehouse, Nanshan District, Shenzhen, Guangdong, P. R. China TEL: +86-755- 3320-2398	
Test Site No.	Sporton Site No.	FCC Registration No.
	03CH03-SZ	565805

Note: The test site complies with ANSI C63.4 2014 requirement.



1.7. Applicable Standards

According to the specifications of the manufacturer, the EUT must comply with the requirements of the following standards:

- ♦ FCC Part 15 Subpart E
- ♦ FCC KDB 789033 D02 General UNII Test Procedures New Rules v01r03
- ♦ FCC KDB 644545 D03 Guidance for IEEE 802.11ac New Rules v01
- ♦ ANSI C63.10-2013

Remark:

1. All test items were verified and recorded according to the standards and without any deviation during the test.
2. This EUT has also been tested and complied with the requirements of FCC Part 15, Subpart B, recorded in a separate test report.



2 Test Configuration of Equipment Under Test

The EUT has been associated with peripherals and configuration operated in a manner tended to maximize its emission characteristics in a typical application. Frequency range investigated: conducted emission (150 kHz to 30 MHz) and radiated emission (9 kHz to the 10th harmonic of the highest fundamental frequency or to 40 GHz, whichever is lower). For radiated measurement, pre-scanned in three orthogonal panels, X, Y, Z. The worst cases (Y plane) were recorded in this report.

2.1 Carrier Frequency and Channel

Frequency Band	Channel	Freq. (MHz)	Channel	Freq. (MHz)
5745-5825 MHz Band 4 (U-NII-3)	149	5745	157	5785
	151*	5755	159*	5795
	153	5765	161	5805
	155#	5775	165	5825

Note:

1. The above Frequency and Channel in "*" were 802.11n HT40 and 802.11ac VHT40.
2. The above Frequency and Channel in "#" were 802.11ac VHT80.



2.2 Test Mode

Final test mode of conducted test items and radiated spurious emissions are considering the modulation and worse data rates from the power table described in section 2.2.

Modulation	Data Rate
802.11a	6 Mbps
802.11n HT20	MCS0
802.11n HT40	MCS0
802.11ac VHT80	MCS0

AC Conducted Emission	Mode 1 : GSM850 Idle + Bluetooth Link + WLAN Link (5G) + USB Cable (Charging from Adapter 1) + Earphone
Remark:	
1. For Radiated TCs, the tests were performed with Adapter, Earphone, and USB Cable.	

Ch. #		Band IV : 5745-5825 MHz		
		802.11a	802.11n HT20	802.11n HT40
L	Low	149	149	151
M	Middle	157	157	-
H	High	165	165	159

Ch. #		Band IV : 5745-5825 MHz
		802.11ac VHT80
L	Low	-
M	Middle	155
H	High	-

2.3 Connection Diagram of Test System

<WLAN Tx Mode>

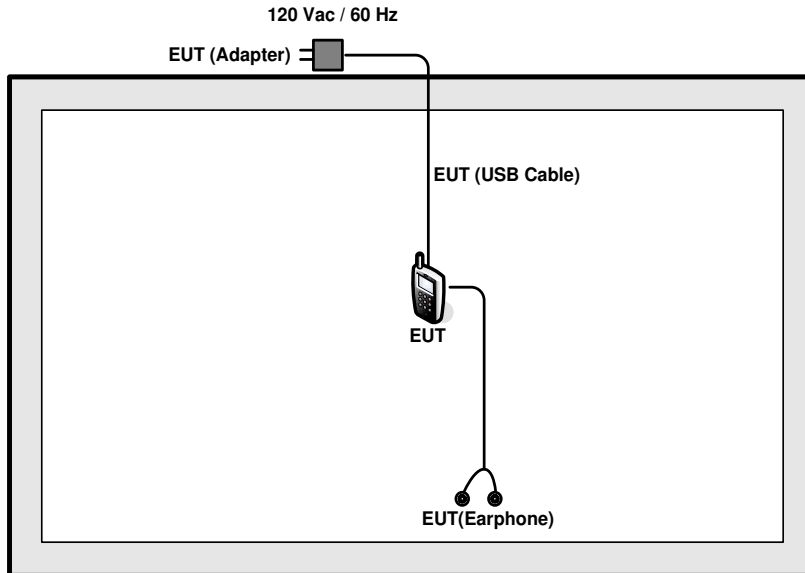

<AC Conducted Emission Mode>

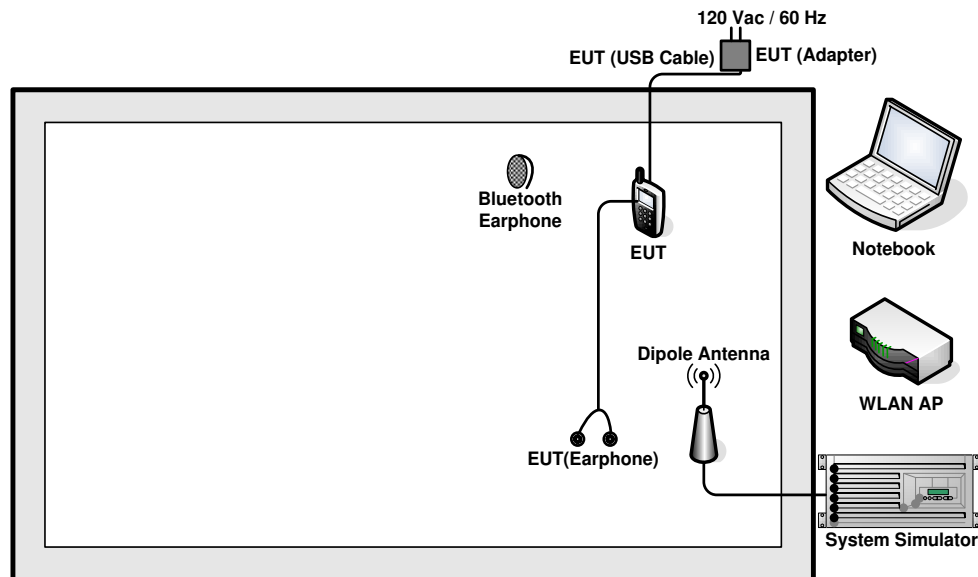



2.4 Support Unit used in test configuration and system

Item	Equipment	Trade Name	Model Name	FCC ID	Data Cable	Power Cord
1.	System Simulator	R&S	CMU 200	N/A	N/A	Unshielded, 1.8 m
2.	WLAN AP	LINKSYS	WRT600N	Q87-WRT600NV11	N/A	Unshielded, 1.8 m
3.	Notebook	Lenovo	G480	N/A	N/A	AC I/P: Unshielded, 1.8 m DC O/P: Shielded, 1.8 m
4.	Bluetooth Earphone	Lenovo	LBH308	N/A	N/A	N/A

2.5 EUT Operation Test Setup

For WLAN RF test items, an engineering test program was provided and enabled to make EUT continuously transmit/receive.

For AC power line conducted emissions, the EUT was set to connect with the Notebook under large package sizes transmission.



2.6 Measurement Results Explanation Example

For all conducted test items:

The offset level is set in the spectrum analyzer to compensate the RF cable loss between EUT conducted output port and spectrum analyzer. With the offset compensation, the spectrum analyzer reading level is exactly the EUT RF output level.

Example:

The spectrum analyzer offset is derived from RF cable loss.

Offset = RF cable loss.

Following shows an offset computation example with cable loss 6.9 dB.

$$\begin{aligned}\text{Offset (dB)} &= \text{RF cable loss(dB)} \\ &= 6.9 \text{ (dB)}\end{aligned}$$

3 Test Result

3.1 6dB and 26dB and 99% Occupied Bandwidth Measurement

3.1.1 Description of 6dB and 26dB and 99% Occupied Bandwidth

The minimum 6 dB bandwidth shall be at least 500 kHz.

26dB and 99% Occupied bandwidth are reporting only.

3.1.2 Measuring Instruments

The measuring equipment is listed in the section 4 of this test report.

3.1.3 Test Procedures

1. The testing follows FCC KDB 789033 D02 General UNII Test Procedures New Rules v01r03.
Section C) Emission bandwidth for the band 5.725-5.85GHz
2. Set RBW = 100kHz.
3. Set the VBW $\geq 3 \times$ RBW.
4. Detector = Peak.
5. Trace mode = max hold
6. Measure the maximum width of the emission that is 6 dB down from the peak of the emission.
7. Measure and record the results in the test report.

3.1.4 Test Setup

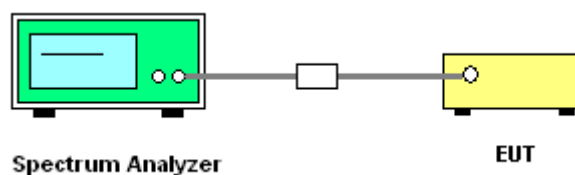



3.1.5 Test Result of 26dB & 6dB & 99% Occupied Bandwidth Plots

Please refer to Appendix A.

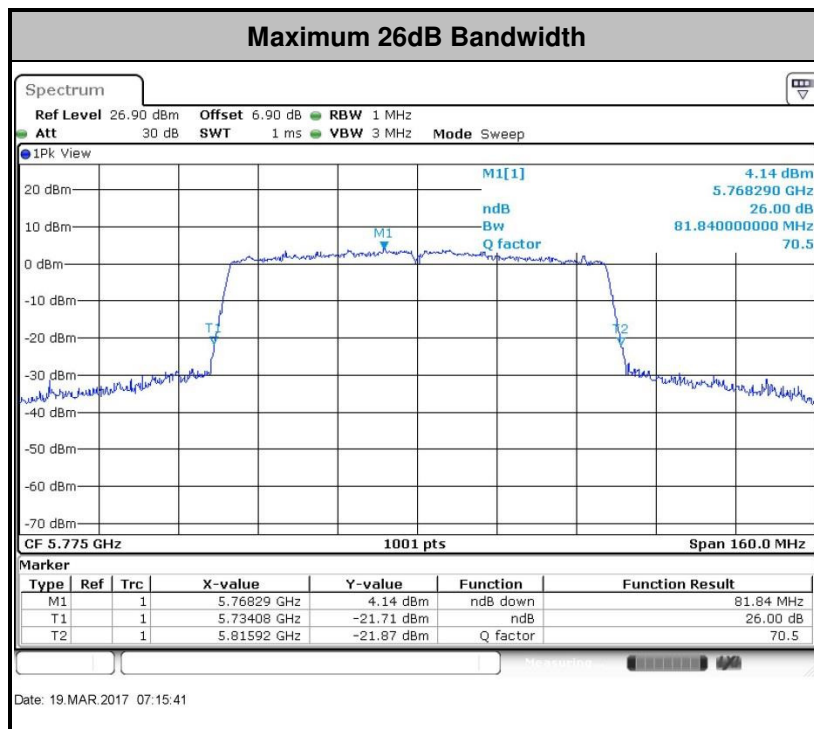
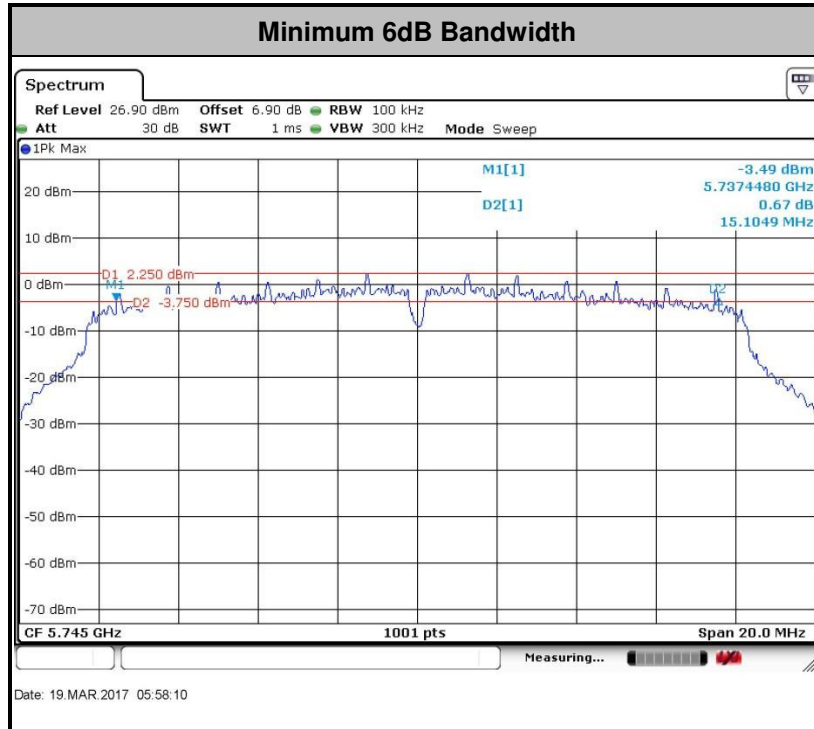

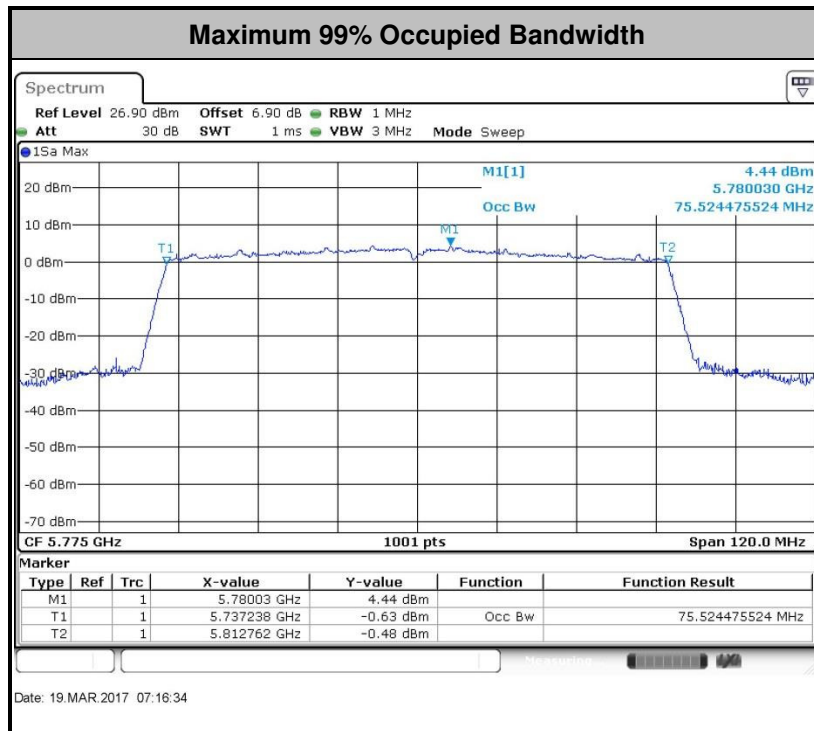

Note: The occupied channel bandwidth is maintained within the band of operation for all of the modulations.

3.2 Maximum Conducted Output Power Measurement

3.2.1 Limit of Maximum Conducted Output Power

For the band 5.725–5.85 GHz, the maximum conducted output power over the frequency band of operation shall not exceed 1 W.

If transmitting antennas of directional gain greater than 6 dBi are used, the peak output power shall be reduced by the amount in dB that the directional gain of the antenna exceeds 6 dBi.

3.2.2 Measuring Instruments

The measuring equipment is listed in the section 4 of this test report.

3.2.3 Test Procedures

The testing follows Method PM of FCC KDB 789033 D02 General UNII Test Procedures New Rules v01r03.

Method PM (Measurement using an RF average power meter):

1. Measurement is performed using a wideband RF power meter.
2. The EUT is configured to transmit continuously with a consistent duty cycle at its maximum power control level.
3. Measure the average power of the transmitter, and the average power is corrected with duty factor, $10 \log(1/x)$, where x is the duty cycle.

3.2.4 Test Setup

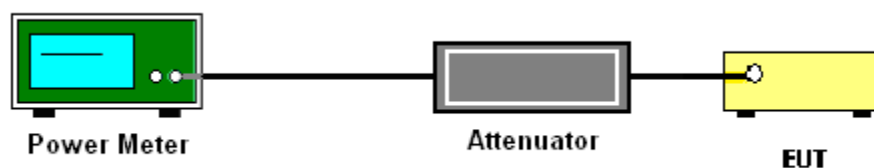

3.2.5 Test Result of Maximum Conducted Output Power

Please refer to Appendix A.



3.3 Power Spectral Density Measurement

3.3.1 Limit of Power Spectral Density

For the band 5.725–5.85 GHz, the maximum power spectral density shall not exceed 30 dBm in any 500-kHz band.

If transmitting antennas of directional gain greater than 6 dBi are used, the peak output power shall be reduced by the amount in dB that the directional gain of the antenna exceeds 6 dBi.

3.3.2 Measuring Instruments

The measuring equipment is listed in the section 4 of this test report.

3.3.3 Test Procedures

The testing follows FCC KDB 789033 D02 General UNII Test Procedures New Rules v01r03. Section F) Maximum power spectral density.

Method SA-2

(trace averaging across on and off times of the EUT transmissions, followed by duty cycle correction).

- Measure the duty cycle.
- Set span to encompass the entire emission bandwidth (EBW) of the signal.
- Set RBW = 300 kHz.
- Set VBW \geq 1 MHz.
- Number of points in sweep \geq 2 Span / RBW.
- Sweep time = auto.
- Detector = RMS
- Trace average at least 100 traces in power averaging mode.
- Add $10 \log(500\text{kHz}/\text{RBW})$ to the test result.
- Add $10 \log(1/x)$, where x is the duty cycle, to the measured power in order to compute the average power during the actual transmission times. For example, add $10 \log(1/0.25) = 6$ dB if the duty cycle is 25 percent.



3.3.5 Test Result of Power Spectral Density

Please refer to Appendix A.

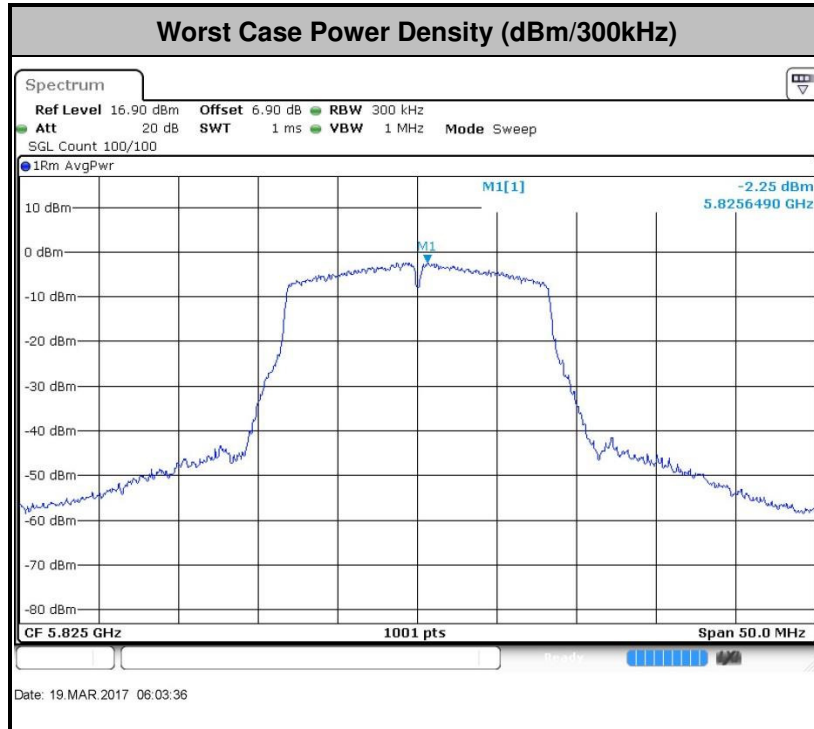



3.4 Unwanted Emissions Measurement

This section as specified in FCC Part 15.407(b) is to measure unwanted emissions through radiated measurement for band edge spurious emissions and out of band emissions measurement. The unwanted emissions shall comply with 15.407(b)(1) to (6), and restricted bands per FCC Part15.205.

3.4.1 Limit of Unwanted Emissions

(1) For transmitters operating in the 5.725-5.85 GHz band:

15.407(b)(4)(i) All emissions shall be limited to a level of -27 dBm/MHz at 75 MHz or more above or below the band edge increasing linearly to 10 dBm/MHz at 25 MHz above or below the band edge, and from 25 MHz above or below the band edge increasing linearly to a level of 15.6 dBm/MHz at 5 MHz above or below the band edge, and from 5 MHz above or below the band edge increasing linearly to a level of 27 dBm/MHz at the band edge.

(2) Unwanted spurious emissions fallen in restricted bands shall comply with the general field strength limits as below table

Frequency (MHz)	Field Strength (microvolts/meter)	Measurement Distance (meters)
0.009 – 0.490	2400/F(kHz)	300
0.490 – 1.705	24000/F(kHz)	30
1.705 – 30.0	30	30
30 – 88	100	3
88 – 216	150	3
216 - 960	200	3
Above 960	500	3

Note: The following formula is used to convert the EIRP to field strength.

$$E = \frac{1000000\sqrt{30P}}{3} \mu V/m, \text{ where } P \text{ is the eirp (Watts)}$$



EIRP (dBm)	Field Strength at 3m (dBµV/m)
-17	78.3
- 27	68.3

(3) KDB 789033 D02 General UNII Test Procedures New Rules v01r03 G)2)c) As specified in 15.407(b), emissions above 1000 MHz that are outside of the restricted bands are subject to a peak emission limit of -27 dBm/MHz (or -17 dBm/MHz as specified in 15.407(b)(4)). However, an out-of-band emission that complies with both the average and peak limits of 15.209 is not required to satisfy the -27 dBm/MHz or -17 dBm/MHz peak emission limit.

3.4.2 Measuring Instruments

The measuring equipment is listed in the section 4 of this test report.

3.4.3 Test Procedures

1. The testing follows FCC KDB 789033 D02 General UNII Test Procedures New Rules v01r03. Section G) Unwanted emissions measurement.

(1) Procedure for Unwanted Emissions Measurements Below 1000MHz

- RBW = 120 kHz
- VBW = 300 kHz
- Detector = Peak
- Trace mode = max hold

(2) Procedure for Peak Unwanted Emissions Measurements Above 1000 MHz

- RBW = 1 MHz
- VBW ≥ 3 MHz
- Detector = Peak
- Sweep time = auto
- Trace mode = max hold

(3) Procedures for Average Unwanted Emissions Measurements Above 1000MHz

- RBW = 1 MHz
- VBW = 10 Hz, when duty cycle is no less than 98 percent.
- VBW ≥ 1/T, when duty cycle is less than 98 percent where T is the minimum transmission duration over which the transmitter is on and is transmitting at its maximum power control level for the tested mode of operation.

2. The EUT was placed on a turntable with 0.8 meter for frequency below 1GHz and 1.5 meter for frequency above 1GHz respectively above ground.
3. The EUT was set 3 meters from the interference receiving antenna which was mounted on the top of a variable height antenna tower.
4. The antenna is a broadband antenna and its height is adjusted between one meter and four meters above ground to find the maximum value of the field strength for both horizontal polarization and vertical polarization of the antenna.
5. For each suspected emission, the EUT was arranged to its worst case and then adjust the antenna tower (from 1 m to 4 m) and turntable (from 0 degree to 360 degrees) to find the maximum reading.
6. For testing below 1GHz, if the emission level of the EUT in peak mode was 3 dB lower than the limit specified, then peak values of EUT will be reported, otherwise, the emissions will be repeated one by one using the CISPR quasi-peak method and reported.
7. For testing above 1GHz, the emission level of the EUT in peak mode was 20dB lower than average limit (that means the emission level in average mode also complies with the limit in average mode), then peak values of EUT will be reported, otherwise, the emissions will be measured in average mode again and reported.

3.4.4 Test Setup

For radiated emissions below 30MHz

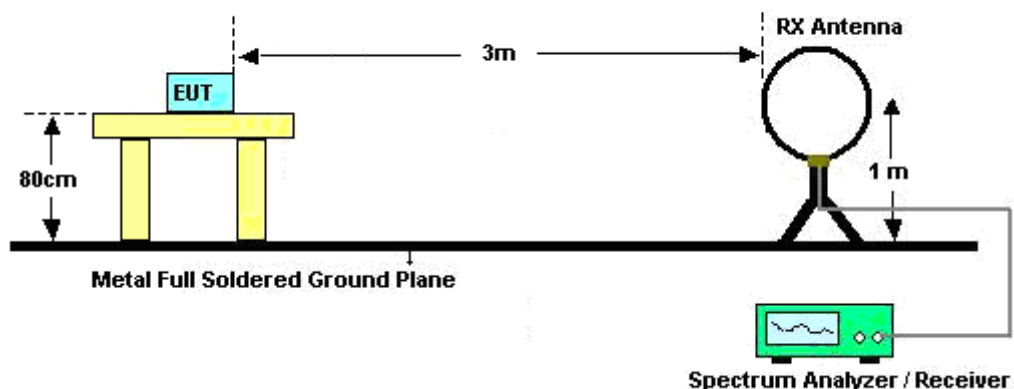

For radiated emissions from 30MHz to 1GHz

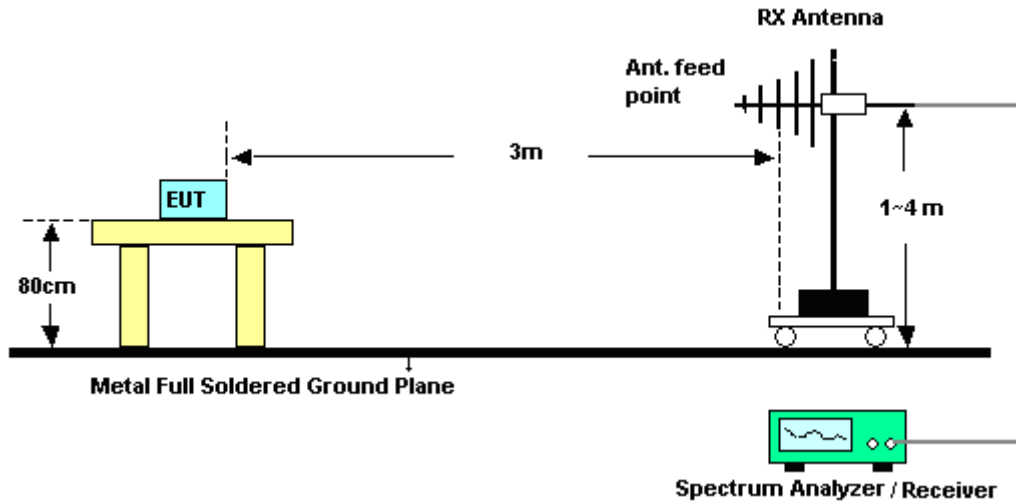

For radiated emissions above 1GHz

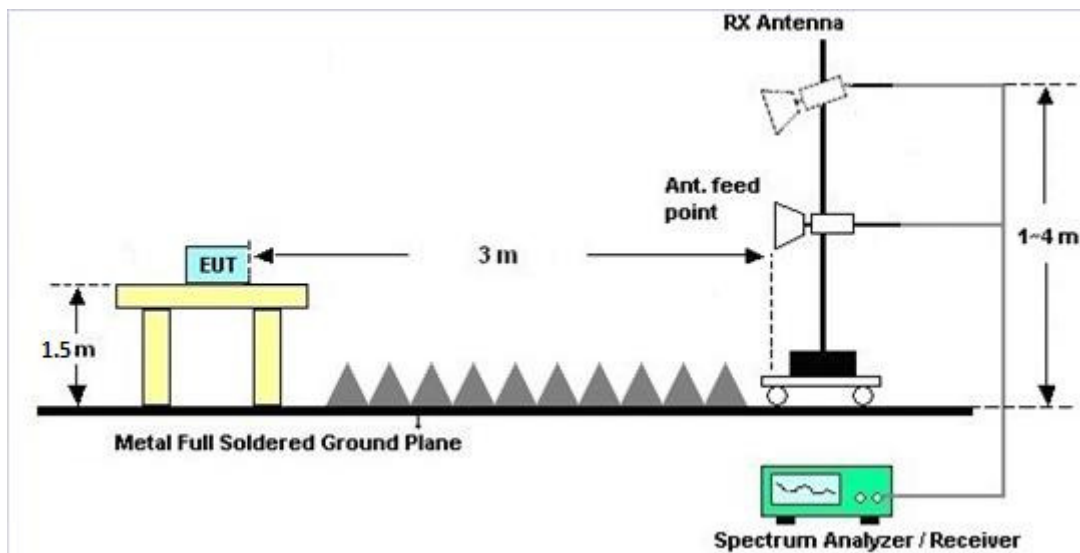



3.4.5 Test Results of Radiated Spurious Emissions (9 kHz ~ 30 MHz)

The low frequency, which started from 9 kHz to 30MHz, was pre-scanned and the result which was 20dB lower than the limit line was not reported.

3.4.6 Test Result of Radiated Spurious at Band Edges

Please refer to Appendix B.

3.4.7 Duty Cycle

Please refer to Appendix C.

3.4.8 Test Result of Radiated Spurious Emissions (30MHz ~ 10th Harmonic)

Please refer to Appendix B.



3.5 AC Conducted Emission Measurement

3.5.1 Limit of AC Conducted Emission

For equipment that is designed to be connected to the public utility (AC) power line, the radio frequency voltage that is conducted back onto the AC power line on any frequency or frequencies within the band 150 kHz to 30 MHz shall not exceed the limits in the following table.

Frequency of emission (MHz)	Conducted limit (dBµV)	
	Quasi-peak	Average
0.15-0.5	66 to 56*	56 to 46*
0.5-5	56	46
5-30	60	50

*Decreases with the logarithm of the frequency.

3.5.2 Measuring Instruments

The measuring equipment is listed in the section 4 of this test report.

3.5.3 Test Procedures

1. The EUT was placed 0.4 meter from the conducting wall of the shielding room was kept at least 80 centimeters from any other grounded conducting surface.
2. Connect EUT to the power mains through a line impedance stabilization network (LISN).
3. All the support units are connecting to the other LISN.
4. The LISN provides 50 ohm coupling impedance for the measuring instrument.
5. The FCC states that a 50 ohm, 50 microhenry LISN should be used.
6. Both sides of AC line were checked for maximum conducted interference.
7. The frequency range from 150 kHz to 30 MHz was searched.
8. Set the test-receiver system to Peak Detect Function and specified bandwidth with Maximum Hold Mode.

3.5.4 Test Setup

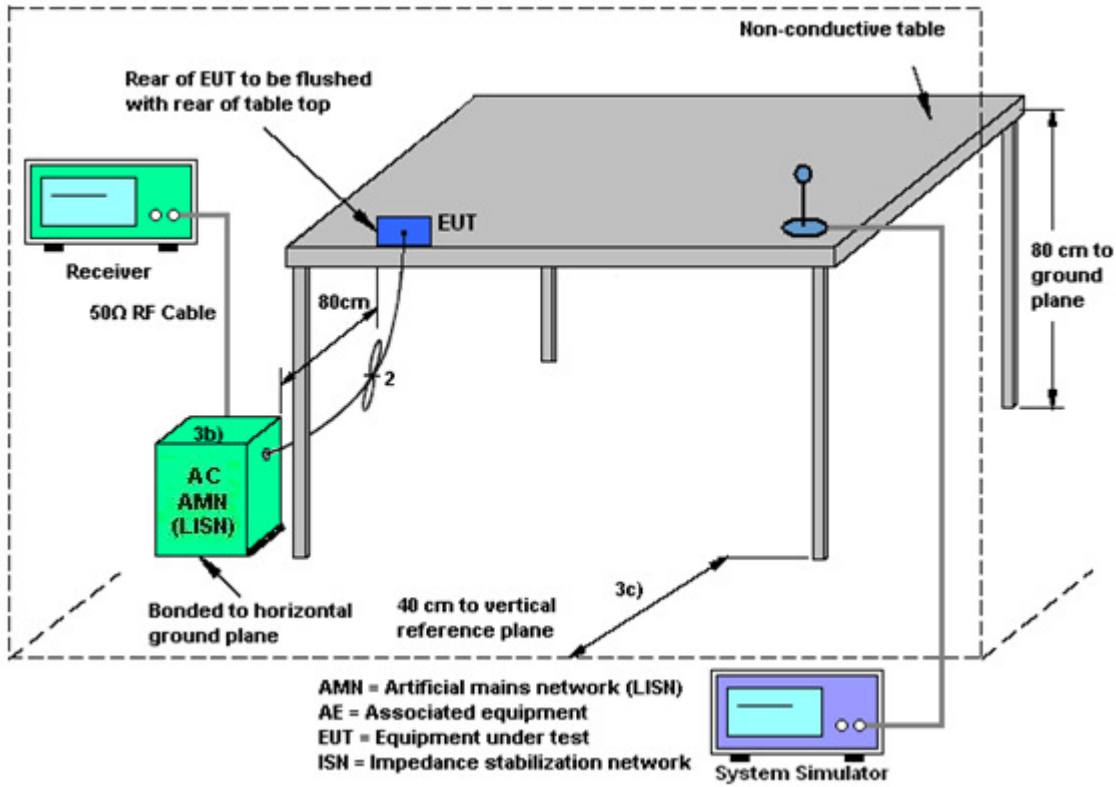



3.5.5 Test Result of AC Conducted Emission

Test Mode :	Mode 1	Temperature :	22~24°C
Test Engineer :	Amos Zhang	Relative Humidity :	42~46%
Test Voltage :	120Vac / 60Hz	Phase :	Line
Function Type :	GSM850 Idle + Bluetooth Link + WLAN Link (5G) + USB Cable (Charging from Adapter 1) + Earphone		

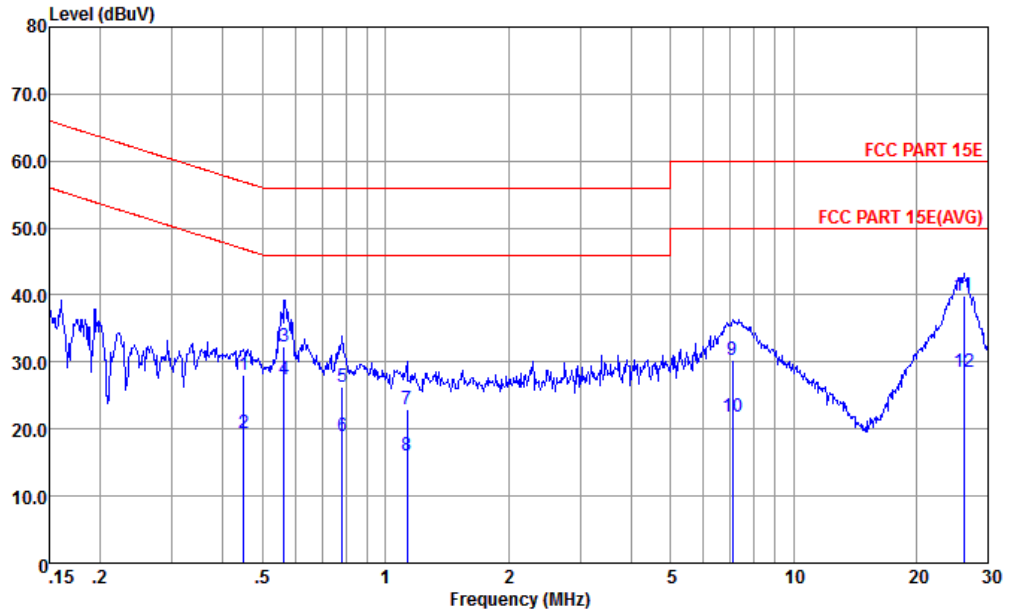

Site : CO01-KS
 Condition : FCC PART 15E LISN-L-20151024 LINE
 mode : Mode 1
 IMEI : 357682080000874

	Freq	Level	Over Limit	Limit Line	Read Level	LISN Factor	Cable Loss	Remark
	MHz	dBuV	dB	dBuV	dBuV	dB	dB	
1	0.449	28.02	-28.87	56.89	17.60	0.23	10.19	QP
2	0.449	19.32	-27.57	46.89	8.90	0.23	10.19	Average
3	0.564	32.32	-23.68	56.00	21.91	0.23	10.18	QP
4 *	0.564	27.32	-18.68	46.00	16.91	0.23	10.18	Average
5	0.783	26.32	-29.68	56.00	15.91	0.24	10.17	QP
6	0.783	19.02	-26.98	46.00	8.61	0.24	10.17	Average
7	1.129	23.03	-32.97	56.00	12.60	0.24	10.19	QP
8	1.129	16.03	-29.97	46.00	5.60	0.24	10.19	Average
9	7.100	30.42	-29.58	60.00	19.90	0.23	10.29	QP
10	7.100	21.82	-28.18	50.00	11.30	0.23	10.29	Average
11	26.139	39.89	-20.11	60.00	28.90	0.22	10.77	QP
12	26.139	28.59	-21.41	50.00	17.60	0.22	10.77	Average



Test Mode :	Mode 1	Temperature :	22~24°C
Test Engineer :	Amos Zhang	Relative Humidity :	42~46%
Test Voltage :	120Vac / 60Hz	Phase :	Neutral
Function Type :	GSM850 Idle + Bluetooth Link + WLAN Link (5G) + USB Cable (Charging from Adapter 1) + Earphone		

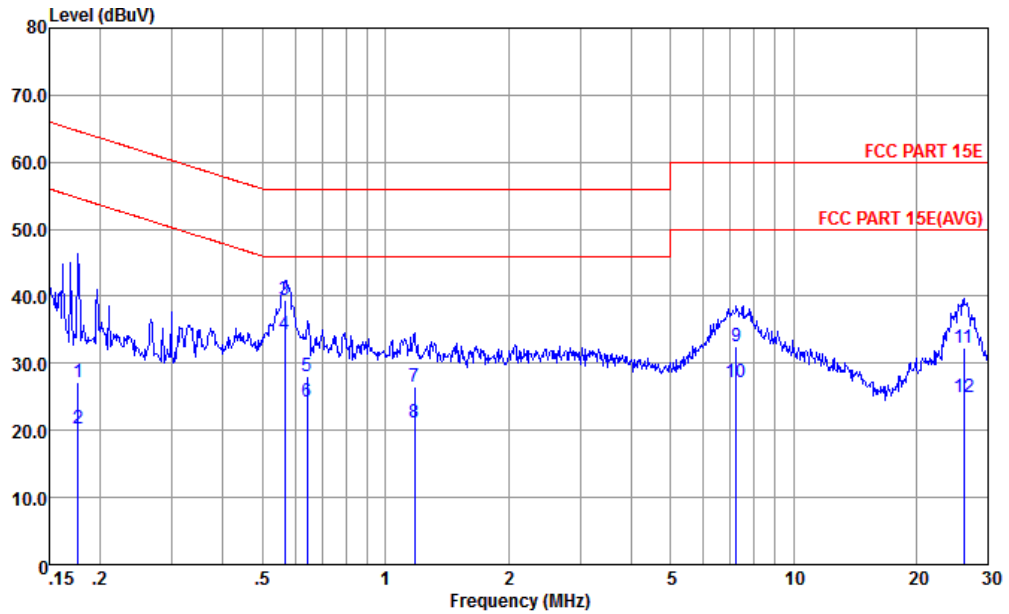

Site : CO01-KS
 Condition : FCC PART 15E LISN-N-20151024 NEUTRAL

mode : Mode 1
 IMEI : 357682080000874

	Freq	Level	Over Limit	Limit Line	Read Level	LISN Factor	Cable Loss	Remark
	MHz	dBuV	dB	dBuV	dBuV	dB	dB	
1	0.177	27.26	-37.38	64.64	16.59	0.31	10.36	QP
2	0.177	20.26	-34.38	54.64	9.59	0.31	10.36	Average
3	0.567	39.41	-11.69	56.00	28.90	0.33	10.18	QP
4 *	0.567	34.31	-11.69	46.00	23.80	0.33	10.18	Average
5	0.644	28.11	-27.89	56.00	17.60	0.33	10.18	QP
6	0.644	24.31	-21.69	46.00	13.80	0.33	10.18	Average
7	1.178	26.46	-29.54	56.00	15.90	0.37	10.19	QP
8	1.178	21.16	-24.84	46.00	10.60	0.37	10.19	Average
9	7.252	32.48	-27.52	60.00	21.90	0.29	10.29	QP
10	7.252	27.18	-22.82	50.00	16.60	0.29	10.29	Average
11	26.139	32.21	-27.79	60.00	21.20	0.24	10.77	QP
12	26.139	24.91	-25.09	50.00	13.90	0.24	10.77	Average

3.6 Frequency Stability Measurement

3.6.1 Limit of Frequency Stability

Manufacturers of U-NII devices are responsible for ensuring frequency stability such that an emission is maintained within the band of operation under all conditions of normal operation as specified in the user's manual.

3.6.2 Measuring Instruments

The measuring equipment is listed in the section 4 of this test report.

3.6.3 Test Procedures

1. To ensure emission at the band edge is maintained within the authorized band, those values shall be measured by radiation emissions at upper and lower frequency points, and finally compensated by frequency deviation as procedures below.
2. The EUT was operated at the maximum output power, and connected to the spectrum analyzer, which is set to maximum hold function and peak detector. The peak value of the power envelope was measured and noted. The upper and lower frequency points were respectively measured relatively 10dB lower than the measured peak value.
3. The frequency deviation was calculated by adding the upper frequency point and the lower frequency point divided by two. Those detailed values of frequency deviation are provided in table below.

3.6.4 Test Setup

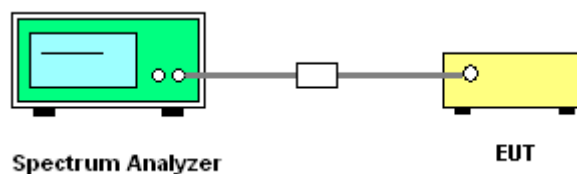

3.6.5 Test Result of Frequency Stability

Please refer to Appendix A.



3.7 Automatically Discontinue Transmission

3.7.1 Limit of Automatically Discontinue Transmission

The device shall automatically discontinue transmission in case of either absence of information to transmit or operational failure. These provisions are not intended to preclude the transmission of control or signaling information or the use of repetitive codes used by certain digital technologies to complete frame or burst intervals. Applicants shall include in their application for equipment authorization to describe how this requirement is met.

3.7.2 Measuring Instruments

The measuring equipment is listed in the section 4 of this test report.

3.7.3 Test Result of Automatically Discontinue Transmission

While the EUT is not transmitting any information, the EUT can automatically discontinue transmission and become standby mode for power saving. The EUT can detect the controlling signal of ACK message transmitting from remote device and verify whether it shall resend or discontinue transmission.



3.8 Antenna Requirements

3.8.1 Standard Applicable

If transmitting antenna directional gain is greater than 6 dBi, both the peak transmit power and the peak power spectral density shall be reduced by the amount in dB that the directional gain of the antenna exceeds 6 dBi.

3.8.2 Antenna Anti-Replacement Construction

An embedded-in antenna design is used.

3.8.3 Antenna Gain

The antenna gain is less than 6 dBi. Therefore, it is not necessary to reduce maximum peak output power limit.



4 List of Measuring Equipment

Instrument	Manufacturer	Model No.	Serial No.	Characteristics	Calibration Date	Test Date	Due Date	Remark
Spectrum Analyzer	R&S	FSV40	101040	10Hz~40GHz	Aug. 09, 2016	Mar. 16, 2017~ Mar. 19, 2017	Aug. 08, 2017	Conducted (TH01-KS)
Pulse Power Sensor	Anritsu	MA2411B	0917070	300MHz~40GHz	Jan. 19, 2017	Mar. 16, 2017~ Mar. 19, 2017	Jan. 18, 2018	Conducted (TH01-KS)
Power Meter	Anritsu	ML2495A	1005002	50MHz Bandwidth	Jan. 19, 2017	Mar. 16, 2017~ Mar. 19, 2017	Jan. 18, 2018	Conducted (TH01-KS)
Thermal Chamber	Ten Billion	TTC-B3S	TBN-960502	-40~+150°C	Oct. 13, 2016	Mar. 16, 2017~ Mar. 19, 2017	Oct. 12, 2017	Conducted (TH01-KS)
EMI Test Receiver&SA	KEYSIGHT	N9038A	MY54450083	20Hz~8.4GHz	May 07, 2016	Mar. 16, 2017~ Apr. 13, 2017	May 06, 2017	Radiation (03CH03-SZ)
EXA Spectrum Analyzer	KEYSIGHT	N9010A	MY55150246	10Hz~44GHz	May 07, 2016	Mar. 16, 2017~ Apr.13, 2017	May 06, 2017	Radiation (03CH03-SZ)
Loop Antenna	R&S	HFH2-Z2	100354	9kHz~30MHz	May 07, 2016	Mar. 16, 2017~ Apr. 13, 2017	May 06, 2017	Radiation (03CH03-SZ)
Bilog Antenna	TeseQ	CBL6112D	35408	30MHz~2GHz	May 21, 2016	Mar. 16, 2017~ Apr.13, 2017	May 20, 2017	Radiation (03CH03-SZ)
Double Ridge Horn Antenna	SCHWARZBECK	BBHA9120D	9120D-1355	1GHz~18GHz	May 07, 2016	Mar. 16, 2017~ Apr. 13, 2017	May 06, 2017	Radiation (03CH03-SZ)
SHF-EHF Horn	com-power	AH-840	101071	18GHz~40GHz	Aug. 10, 2016	Mar. 16, 2017~ Apr.13, 2017	Aug. 09, 2017	Radiation (03CH03-SZ)
Amplifier	Burgeon	BPA-530	102210	0.01Hz~3000MHz	Oct. 11, 2016	Mar. 16, 2017~ Apr. 13, 2017	Oct. 10, 2017	Radiation (03CH03-SZ)
Amplifier	Agilent Technologies	83017A	MY39501302	500MHz~26.5GHz	Jan. 06, 2017	Mar. 16, 2017~ Apr.13, 2017	Jan. 05, 2018	Radiation (03CH03-SZ)
HF Amplifier	MITEQ	TTA1840-35-HG	1871923	18GHz~40GHz	Jul. 16, 2016	Mar. 16, 2017~ Apr. 13, 2017	Jul. 15, 2017	Radiation (03CH03-SZ)
AC Power Source	Chroma	61601	616010001985	N/A	NCR	Mar. 16, 2017~ Apr.13, 2017	NCR	Radiation (03CH03-SZ)
Turn Table	EM	EM1000	N/A	0~360 degree	NCR	Mar. 16, 2017~ Apr. 13, 2017	NCR	Radiation (03CH03-SZ)
Antenna Mast	EM	EM1000	N/A	1 m~4 m	NCR	Mar. 16, 2017~ Apr.13, 2017	NCR	Radiation (03CH03-SZ)
EMI Receiver	R&S	ESCI7	100768	9kHz~7GHz	Apr. 29, 2016	Apr. 11, 2017	Apr. 28, 2017	Conduction (CO01-KS)
AC LISN	MessTec	AN3016	060103	9kHz~30MHz	Oct. 13, 2016	Apr. 11, 2017	Oct. 12, 2017	Conduction (CO01-KS)
AC LISN (for auxiliary equipment)	MessTec	AN3016	060105	9kHz~30MHz	Oct. 13, 2016	Apr. 11, 2017	Oct. 12, 2017	Conduction (CO01-KS)
AC Power Source	Chroma	61602	ABP000000811	AC 0V~300V, 45Hz~1000Hz	Oct. 13, 2016	Apr. 11, 2017	Oct. 12, 2017	Conduction (CO01-KS)

NCR: No Calibration Required



5 Uncertainty of Evaluation

Uncertainty of Conducted Emission Measurement (150kHz ~ 30MHz)

Measuring Uncertainty for a Level of Confidence of 95% ($U = 2Uc(y)$)	2.3dB
---	-------

Uncertainty of Radiated Emission Measurement (30 MHz ~ 1000 MHz)

Measuring Uncertainty for a Level of Confidence of 95% ($U = 2Uc(y)$)	5.1dB
---	-------

Uncertainty of Radiated Emission Measurement (1GHz ~ 18GHz)

Measuring Uncertainty for a Level of Confidence of 95% ($U = 2Uc(y)$)	5.0dB
---	-------

Uncertainty of Radiated Emission Measurement (18GHz ~ 40GHz)

Measuring Uncertainty for a Level of Confidence of 95% ($U = 2Uc(y)$)	5.0dB
---	-------



Appendix A. Conducted Test Results

Report Number : FR730704F

Test Engineer:	Silent Hai	Temperature:	21~25	°C
Test Date:	2017/3/16~2017/3/19	Relative Humidity:	51~55	%

TEST RESULTS DATA
6dB and 26dB EBW and 99% OBW

Band IV									
Mod.	Data Rate	NTX	CH.	Freq. (MHz)	99% Bandwidth (MHz)	26 dB Bandwidth (MHz)	6 dB Bandwidth (MHz)	6dB Bandwidth min. Limit (MHz)	Pass/Fail
11a	6M bps	1	149	5745	17.93	21.18	15.10	0.5	Pass
11a	6Mbps	1	157	5785	17.93	21.28	15.10	0.5	Pass
11a	6Mbps	1	165	5825	17.93	21.08	15.10	0.5	Pass
HT20	MCS 0	1	149	5745	18.28	21.18	15.10	0.5	Pass
HT20	MCS 0	1	157	5785	18.28	22.38	15.10	0.5	Pass
HT20	MCS 0	1	165	5825	18.28	21.33	15.10	0.5	Pass
HT40	MCS 0	1	151	5755	36.26	41.36	35.05	0.5	Pass
HT40	MCS 0	1	159	5795	36.46	41.63	35.05	0.5	Pass
VHT80	MCS 0	1	155	5775	75.52	81.84	75.12	0.5	Pass

TEST RESULTS DATA
Average Power Table

Band IV										
Mod.	Data Rate	NTX	CH.	Freq. (MHz)	Duty Factor (dB)	Average Conducted Power (dBm)	FCC Conducted Power Limit (dBm)	DG (dBi)		Pass/Fail
11a	6M bps	1	149	5745	0.11	12.08	30.00	-3.00		Pass
11a	6Mbps	1	157	5785	0.11	12.23	30.00	-3.00		Pass
11a	6Mbps	1	165	5825	0.11	12.26	30.00	-3.00		Pass
HT20	MCS 0	1	149	5745	0.12	12.06	30.00	-3.00		Pass
HT20	MCS 0	1	157	5785	0.12	12.10	30.00	-3.00		Pass
HT20	MCS 0	1	165	5825	0.12	12.11	30.00	-3.00		Pass
HT40	MCS 0	1	151	5755	0.24	12.06	30.00	-3.00		Pass
HT40	MCS 0	1	159	5795	0.24	12.19	30.00	-3.00		Pass
VHT80	MCS 0	1	155	5775	0.46	12.08	30.00	-3.00		Pass

TEST RESULTS DATA
Power Spectral Density

Band IV										
Mod.	Data Rate	NTX	CH.	Freq. (MHz)	Duty Factor (dB)	10log (500kHz /RBW) Factor (dB)	Average Power Density (dBm/500kHz)	Average PSD Limit (dBm/500kHz)	DG (dBi)	Pass/Fail
11a	6M bps	1	149	5745	0.11	2.22	0.04	30.00	-3.00	Pass
11a	6Mbps	1	157	5785	0.11	2.22	-0.08	30.00	-3.00	Pass
11a	6Mbps	1	165	5825	0.11	2.22	0.08	30.00	-3.00	Pass
HT20	MCS 0	1	149	5745	0.12	2.22	-0.34	30.00	-3.00	Pass
HT20	MCS 0	1	157	5785	0.12	2.22	-0.48	30.00	-3.00	Pass
HT20	MCS 0	1	165	5825	0.12	2.22	0.08	30.00	-3.00	Pass
HT40	MCS 0	1	151	5755	0.24	2.22	-3.41	30.00	-3.00	Pass
HT40	MCS 0	1	159	5795	0.24	2.22	-3.66	30.00	-3.00	Pass
VHT80	MCS 0	1	155	5775	0.46	2.22	-6.88	30.00	-3.00	Pass

TEST RESULTS DATA
Frequency Stability

Band IV										
Mod.	Data Rate	NTX	CH.	Freq. (MHz)	Center Frequency (MHz)	Frequency Deviation (MHz)	Frequency Stability (ppm)	Temperature (°C)	Voltage (V)	Note
11a	6M bps	1	149	5745	5745.025	0.025	4.35	50	3.85	
11a	6M bps	1	149	5745	5745.000	0.000	0.00	-30	3.85	
11a	6M bps	1	149	5745	5745.025	0.025	4.35	20	4.4	
11a	6M bps	1	149	5745	5745.025	0.025	4.35	20	3.5	
11a	6M bps	1	149	5745	5745.025	0.025	4.35	20	3.85	



Appendix B. Radiated Spurious Emission

Band 4 - 5725~5850MHz
WIFI 802.11a (Band Edge @ 3m)

WIFI Ant.	Note	Frequency	Level	Over Limit	Limit Line	Read Level	Antenna Factor	Cable Loss	Preamp Factor	Ant Pos	Table Pos	Peak Avg.	Pol.
1		(MHz)	(dBμV/m)	(dB)	(dBμV/m)	(dBμV)	(dB/m)	(dB)	(dB)	(cm)	(deg)	(P/A)	(H/V)
802.11a CH 149 5745MHz		5648.8	50.7	-17.6	68.3	40.36	33.17	9.25	32.08	162	18	P	H
		5683	52.24	-40.52	92.76	41.69	33.21	9.35	32.01	162	18	P	H
		5707.4	53.26	-54.11	107.37	42.55	33.25	9.44	31.98	162	18	P	H
		5724.6	56.7	-64.69	121.39	45.97	33.27	9.44	31.98	162	18	P	H
		5745	106.47	-	-	95.58	33.29	9.54	31.94	162	18	P	H
	*	5745	95.75	-	-	84.86	33.29	9.54	31.94	162	18	A	H
		5605.2	50.15	-18.15	68.3	40	33.12	9.15	32.12	155	322	P	V
		5696	52.93	-49.42	102.35	42.36	33.23	9.35	32.01	155	322	P	V
		5719.2	52.1	-58.58	110.68	41.37	33.27	9.44	31.98	155	322	P	V
		5724	54.32	-65.7	120.02	43.59	33.27	9.44	31.98	155	322	P	V
		5745	104.97	-	-	94.08	33.29	9.54	31.94	155	322	P	V
		5745	94.58	-	-	83.69	33.29	9.54	31.94	155	322	A	V



WIFI Ant. 1	Note	Frequency (MHz)	Level (dBμV/m)	Over Limit (dB)	Limit Line (dBμV/m)	Read Level (dBμV)	Antenna Factor (dB/m)	Cable Loss (dB)	Preamp Factor (dB)	Ant Pos (cm)	Table Pos (deg)	Peak Avg. (P/A)	Pol. (H/V)
		5620.8	50.78	-17.52	68.3	40.61	33.14	9.15	32.12	163	63	P	H
		5691.6	51.59	-47.52	99.11	41.02	33.23	9.35	32.01	163	63	P	H
		5718.6	51.79	-58.72	110.51	41.06	33.27	9.44	31.98	163	63	P	H
		5721.6	51.76	-62.79	114.55	41.03	33.27	9.44	31.98	163	63	P	H
		5785	108.08	-	-	96.98	33.33	9.64	31.87	163	63	P	H
		5785	99.12	-	-	88.02	33.33	9.64	31.87	163	63	A	H
		5852.6	51.03	-65.34	116.37	39.75	33.41	9.67	31.8	163	63	P	H
		5864	51.98	-56.4	108.38	40.6	33.43	9.71	31.76	163	63	P	H
		5889	51.95	-42.96	94.91	40.48	33.48	9.71	31.72	163	63	P	H
		5941.4	51.95	-16.35	68.3	40.28	33.54	9.78	31.65	163	63	P	H
		5648.8	49.68	-18.62	68.3	39.34	33.17	9.25	32.08	152	259	P	V
		5688.2	50.64	-45.96	96.6	40.07	33.23	9.35	32.01	152	259	P	V
		5715.2	51.05	-58.51	109.56	40.34	33.25	9.44	31.98	152	259	P	V
		5720.6	49.73	-62.54	112.27	39	33.27	9.44	31.98	152	259	P	V
		5785	105.87	-	-	94.77	33.33	9.64	31.87	152	259	P	V
		5785	97.64	-	-	86.54	33.33	9.64	31.87	152	259	A	V
		5850.6	51.56	-69.37	120.93	40.28	33.41	9.67	31.8	152	259	P	V
		5863	51.67	-56.99	108.66	40.29	33.43	9.71	31.76	152	259	P	V
		5893.2	51.93	-39.87	91.8	40.46	33.48	9.71	31.72	152	259	P	V
		5944.6	51.12	-17.18	68.3	39.45	33.54	9.78	31.65	152	259	P	V



WIFI Ant. 1	Note	Frequency (MHz)	Level (dBμV/m)	Over Limit (dB)	Limit Line (dBμV/m)	Read Level (dBμV)	Antenna Factor (dB/m)	Cable Loss (dB)	Preamp Factor (dB)	Ant Pos (cm)	Table Pos (deg)	Peak Avg. (P/A)	Pol. (H/V)
802.11a CH 165 5825MHz		5825	106.84	-	-	95.61	33.39	9.67	31.83	162	65	P	H
		5825	99.46	-	-	88.23	33.39	9.67	31.83	162	65	A	H
		5850.2	53.59	-68.25	121.84	42.31	33.41	9.67	31.8	162	65	P	H
		5861.2	53.83	-55.33	109.16	42.45	33.43	9.71	31.76	162	65	P	H
		5877.6	53.31	-50.06	103.37	41.9	33.46	9.71	31.76	162	65	P	H
		5927.4	50.95	-17.35	68.3	39.38	33.52	9.74	31.69	162	65	P	H
		5825	105.43	-	-	94.2	33.39	9.67	31.83	150	258	P	V
		5825	97.06	-	-	85.83	33.39	9.67	31.83	150	258	A	V
		5853.2	53.76	-61.24	115	42.48	33.41	9.67	31.8	150	258	P	V
		5866.2	52.27	-55.49	107.76	40.89	33.43	9.71	31.76	150	258	P	V
		5918.8	52.37	-20.5	72.87	40.82	33.5	9.74	31.69	150	258	P	V
		5928	51.18	-17.12	68.3	39.61	33.52	9.74	31.69	150	258	P	V
Remark	<ol style="list-style-type: none"> No other spurious found. All results are PASS against Peak and Average limit line. 												



Band 4 5725~5850MHz

WIFI 802.11a (Harmonic @ 3m)

WIFI Ant. 1	Note	Frequency (MHz)	Level (dBμV/m)	Over Limit (dB)	Limit Line (dBμV/m)	Read Level (dBμV)	Antenna Factor (dB/m)	Cable Loss (dB)	Preamp Factor (dB)	Ant Pos (cm)	Table Pos (deg)	Peak Avg. (P/A)	Pol. (H/V)
802.11a CH 149 5745MHz		11490	56.38	-17.62	74	62.9	39.7	13.41	59.63	145	265	P	H
		11490	45.36	-8.64	54	51.88	39.7	13.41	59.63	145	265	A	H
		17235	51.68	-16.62	68.3	55.42	40.06	16.29	60.09	174	321	P	H
		11490	59.32	-14.68	74	65.84	39.7	13.41	59.63	145	265	P	V
		11490	48.87	-5.13	54	55.39	39.7	13.41	59.63	145	265	A	V
		17235	51.6	-16.7	68.3	55.34	40.06	16.29	60.09	174	321	P	V
802.11a CH 157 5785MHz		11570	57.91	-16.09	74	64.44	39.66	13.46	59.65	105	198	P	H
		11570	47.71	-6.29	54	54.24	39.66	13.46	59.65	105	198	A	H
		17355	51.64	-16.66	68.3	55.04	40.34	16.36	60.1	189	185	P	H
		11570	58.49	-15.51	74	65.02	39.66	13.46	59.65	105	198	P	V
		11570	47.81	-6.19	54	54.34	39.66	13.46	59.65	105	198	A	V
		17355	51.42	-16.88	68.3	54.82	40.34	16.36	60.1	189	185	P	V
802.11a CH 165 5825MHz		11650	57.13	-16.87	74	63.68	39.62	13.5	59.67	146	347	P	H
		11650	46.95	-7.05	54	53.5	39.62	13.5	59.67	146	347	A	H
		17475	52.54	-15.76	68.3	55.61	40.62	16.43	60.12	100	360	P	H
		11650	59.09	-14.91	74	65.64	39.62	13.5	59.67	146	347	P	V
		11650	49.65	-4.35	54	56.2	39.62	13.5	59.67	146	347	A	V
		17475	52.25	-16.05	68.3	55.32	40.62	16.43	60.12	100	360	P	V
Remark	1. No other spurious found. 2. All results are PASS against Peak and Average limit line.												



Band 4 5725~5850MHz
WIFI 802.11n HT20 (Band Edge @ 3m)

Table with 14 columns: WIFI Ant. 1, Note, Frequency (MHz), Level (dBµV/m), Over Limit (dB), Limit Line (dBµV/m), Read Level (dBµV), Antenna Factor (dB/m), Cable Loss (dB), Preamp Factor (dB), Ant Pos (cm), Table Pos (deg), Peak Avg. (P/A), Pol. (H/V). Rows include frequency measurements from 5619.4 to 5745 MHz.



WIFI Ant. 1	Note	Frequency (MHz)	Level (dBμV/m)	Over Limit (dB)	Limit Line (dBμV/m)	Read Level (dBμV)	Antenna Factor (dB/m)	Cable Loss (dB)	Preamp Factor (dB)	Ant Pos (cm)	Table Pos (deg)	Peak Avg. (P/A)	Pol. (H/V)
802.11n HT20 CH 157 5785MHz		5625	50.44	-17.86	68.3	40.17	33.14	9.25	32.12	166	67	P	H
		5699	52.39	-52.17	104.56	41.82	33.23	9.35	32.01	166	67	P	H
		5704.8	53.09	-53.56	106.65	42.38	33.25	9.44	31.98	166	67	P	H
		5720.8	51.15	-61.57	112.72	40.42	33.27	9.44	31.98	166	67	P	H
		5785	106.31	-	-	95.21	33.33	9.64	31.87	166	67	P	H
		5785	98.62	-	-	87.52	33.33	9.64	31.87	166	67	A	H
		5851	51.22	-68.8	120.02	39.94	33.41	9.67	31.8	166	67	P	H
		5863.2	52.88	-55.72	108.6	41.5	33.43	9.71	31.76	166	67	P	H
		5918.8	52.08	-20.79	72.87	40.53	33.5	9.74	31.69	166	67	P	H
		5947.4	51.12	-17.18	68.3	39.45	33.54	9.78	31.65	166	67	P	H
		5650	51.47	-16.83	68.3	41.11	33.19	9.25	32.08	150	258	P	V
		5650	51.47	-16.83	68.3	41.11	33.19	9.25	32.08	150	258	P	V
		5711.8	51.75	-56.86	108.61	41.04	33.25	9.44	31.98	150	258	P	V
		5721.2	50.45	-63.19	113.64	39.72	33.27	9.44	31.98	150	258	P	V
		5785	105.87	-	-	94.77	33.33	9.64	31.87	150	258	P	V
		5785	96.93	-	-	85.83	33.33	9.64	31.87	150	258	A	V
		5850.8	51.61	-68.87	120.48	40.33	33.41	9.67	31.8	150	258	P	V
		5866.6	52.92	-54.73	107.65	41.54	33.43	9.71	31.76	150	258	P	V
	5915.4	52.95	-22.43	75.38	41.4	33.5	9.74	31.69	150	258	P	V	
	5948	51.21	-17.09	68.3	39.54	33.54	9.78	31.65	150	258	P	V	



WiFi Ant. 1	Note	Frequency (MHz)	Level (dBμV/m)	Over Limit (dB)	Limit Line (dBμV/m)	Read Level (dBμV)	Antenna Factor (dB/m)	Cable Loss (dB)	Preamp Factor (dB)	Ant Pos (cm)	Table Pos (deg)	Peak Avg. (P/A)	Pol. (H/V)
802.11n HT20 CH 165 5825MHz		5825	107.01	-	-	95.78	33.39	9.67	31.83	150	44	P	H
		5825	97.51	-	-	86.28	33.39	9.67	31.83	150	44	A	H
		5850	53.81	-68.49	122.3	42.53	33.41	9.67	31.8	150	44	P	H
		5859.4	53.88	-55.79	109.67	42.5	33.43	9.71	31.76	150	44	P	H
		5912.2	52.5	-25.24	77.74	40.95	33.5	9.74	31.69	150	44	P	H
		5948	52.02	-16.28	68.3	40.35	33.54	9.78	31.65	150	44	P	H
		5825	105.71	-	-	94.48	33.39	9.67	31.83	150	259	P	V
		5825	96.72	-	-	85.49	33.39	9.67	31.83	150	259	A	V
		5854.8	52.45	-58.91	111.36	41.15	33.43	9.67	31.8	150	259	P	V
		5868.2	53.17	-54.03	107.2	41.79	33.43	9.71	31.76	150	259	P	V
		5899.6	52.67	-34.39	87.06	41.17	33.48	9.74	31.72	150	259	P	V
	5928.6	53.32	-14.98	68.3	41.75	33.52	9.74	31.69	150	259	P	V	
Remark	1. No other spurious found. 2. All results are PASS against Peak and Average limit line.												



Band 4 5725~5850MHz
WIFI 802.11n HT20 (Harmonic @ 3m)

WIFI Ant. 1	Note	Frequency (MHz)	Level (dBμV/m)	Over Limit (dB)	Limit Line (dBμV/m)	Read Level (dBμV)	Antenna Factor (dB/m)	Cable Loss (dB)	Preamp Factor (dB)	Ant Pos (cm)	Table Pos (deg)	Peak Avg. (P/A)	Pol. (H/V)
802.11n HT20 CH 149 5745MHz		11490	57.43	-16.57	74	63.95	39.7	13.41	59.63	145	265	P	H
		11490	47.32	-6.68	54	53.84	39.7	13.41	59.63	145	265	A	H
		17235	52.85	-15.45	68.3	56.59	40.06	16.29	60.09	174	321	P	H
		11490	59.64	-14.36	74	66.16	39.7	13.41	59.63	145	265	P	V
		11490	49.34	-4.66	54	55.86	39.7	13.41	59.63	145	265	A	V
		17235	50.88	-17.42	68.3	54.62	40.06	16.29	60.09	174	321	P	V
802.11n HT20 CH 157 5785MHz		11570	55.96	-18.04	74	62.49	39.66	13.46	59.65	105	198	P	H
		11570	45.32	-8.68	54	51.85	39.66	13.46	59.65	105	198	A	H
		17355	51.78	-16.52	68.3	55.18	40.34	16.36	60.1	189	185	P	H
		11570	60.91	-13.09	74	67.44	39.66	13.46	59.65	105	198	P	V
		11570	50.58	-3.42	54	57.11	39.66	13.46	59.65	105	198	A	V
		17355	51.47	-16.83	68.3	54.87	40.34	16.36	60.1	189	185	P	V
802.11n HT20 CH 165 5825MHz		11650	57.44	-16.56	74	63.99	39.62	13.5	59.67	146	347	P	H
		11650	47.31	-6.69	54	53.86	39.62	13.5	59.67	146	347	A	H
		17475	52.21	-16.09	68.3	55.28	40.62	16.43	60.12	100	360	P	H
		11650	59.47	-14.53	74	66.02	39.62	13.5	59.67	146	347	P	V
		11650	49.01	-4.99	54	55.56	39.62	13.5	59.67	146	347	A	V
		17475	53.35	-14.95	68.3	56.42	40.62	16.43	60.12	100	360	P	V
Remark	1. No other spurious found. 2. All results are PASS against Peak and Average limit line.												



Band 4 5725~5850MHz
WIFI 802.11n HT40 (Band Edge @ 3m)

Table with 14 columns: WIFI Ant. 1, Note, Frequency (MHz), Level (dBµV/m), Over Limit (dB), Limit Line (dBµV/m), Read Level (dBµV), Antenna Factor (dB/m), Cable Loss (dB), Preamp Factor (dB), Ant Pos (cm), Table Pos (deg), Peak Avg. (P/A), Pol. (H/V). Rows include frequency measurements from 5647 to 5925 MHz.



WIFI Ant. 1	Note	Frequency (MHz)	Level (dBμV/m)	Over Limit (dB)	Limit Line (dBμV/m)	Read Level (dBμV)	Antenna Factor (dB/m)	Cable Loss (dB)	Preamp Factor (dB)	Ant Pos (cm)	Table Pos (deg)	Peak Avg. (P/A)	Pol. (H/V)
802.11n HT40 CH 159 5795MHz		5646.6	50.97	-17.33	68.3	40.63	33.17	9.25	32.08	150	44	P	H
		5693.4	51.79	-48.64	100.43	41.22	33.23	9.35	32.01	150	44	P	H
		5702.8	52.09	-54	106.09	41.41	33.25	9.44	32.01	150	44	P	H
		5721.4	52.56	-61.53	114.09	41.83	33.27	9.44	31.98	150	44	P	H
		5795	104.34	-	-	93.22	33.35	9.64	31.87	150	44	P	H
		5795	95.57	-	-	84.45	33.35	9.64	31.87	150	44	A	H
		5854	53.49	-59.69	113.18	42.19	33.43	9.67	31.8	150	44	P	H
		5865.4	52.43	-55.56	107.99	41.05	33.43	9.71	31.76	150	44	P	H
		5886	53.02	-44.11	97.13	41.57	33.46	9.71	31.72	150	44	P	H
		5932.6	51.99	-16.31	68.3	40.42	33.52	9.74	31.69	150	44	P	H
		5623.6	50.3	-18	68.3	40.03	33.14	9.25	32.12	150	279	P	V
		5694.2	52.26	-48.76	101.02	41.69	33.23	9.35	32.01	150	279	P	V
		5703.6	52.08	-54.23	106.31	41.4	33.25	9.44	32.01	150	279	P	V
		5724.2	50.79	-69.69	120.48	40.06	33.27	9.44	31.98	150	279	P	V
		5795	102.75	-	-	91.63	33.35	9.64	31.87	150	279	P	V
		5795	94.66	-	-	83.54	33.35	9.64	31.87	150	279	A	V
		5850.6	53.28	-67.65	120.93	42	33.41	9.67	31.8	150	279	P	V
		5868.8	53.1	-53.93	107.03	41.72	33.43	9.71	31.76	150	279	P	V
	5893	52.91	-39.03	91.94	41.44	33.48	9.71	31.72	150	279	P	V	
	5933.6	51.21	-17.09	68.3	39.6	33.52	9.78	31.69	150	279	P	V	
Remark	1. No other spurious found. 2. All results are PASS against Peak and Average limit line.												



Band 4 5725~5850MHz
WIFI 802.11n HT40 (Harmonic @ 3m)

WIFI Ant. 1	Note	Frequency (MHz)	Level (dBμV/m)	Over Limit (dB)	Limit Line (dBμV/m)	Read Level (dBμV)	Antenna Factor (dB/m)	Cable Loss (dB)	Preamp Factor (dB)	Ant Pos (cm)	Table Pos (deg)	Peak Avg. (P/A)	Pol. (H/V)
802.11n HT40 CH 151 5755MHz		11510	54.24	-19.76	74	60.76	39.7	13.41	59.63	100	360	P	H
		11510	43.38	-10.62	54	49.9	39.7	13.41	59.63	100	360	A	H
		17265	51.89	-16.41	68.3	55.53	40.14	16.32	60.1	100	360	P	H
		11510	57.44	-16.56	74	63.96	39.7	13.41	59.63	100	360	P	V
		11510	47.27	-6.73	54	53.79	39.7	13.41	59.63	100	360	A	V
		17265	51.31	-16.99	68.3	54.95	40.14	16.32	60.1	100	360	P	V
802.11n HT40 CH 159 5795MHz		11590	54.83	-19.17	74	61.36	39.65	13.48	59.66	100	300	P	H
		11590	45.45	-8.55	54	51.98	39.65	13.48	59.66	100	300	A	H
		17385	52.28	-16.02	68.3	55.58	40.42	16.39	60.11	100	200	P	H
		11590	56.47	-17.53	74	63	39.65	13.48	59.66	100	300	P	V
		11590	46.32	-7.68	54	52.85	39.65	13.48	59.66	100	300	A	V
		17385	51.94	-16.36	68.3	55.24	40.42	16.39	60.11	100	200	P	V
Remark	1. No other spurious found. 2. All results are PASS against Peak and Average limit line.												



Band 4 5725~5850MHz
WIFI 802.11ac VHT20 (Band Edge @ 3m)

Table with 14 columns: WIFI Ant. 1, Note, Frequency (MHz), Level (dBµV/m), Over Limit (dB), Limit Line (dBµV/m), Read Level (dBµV), Antenna Factor (dB/m), Cable Loss (dB), Preamp Factor (dB), Ant Pos (cm), Table Pos (deg), Peak Avg. (P/A), Pol. (H/V). Rows include frequencies from 5644.4 to 5745 MHz.



WIFI Ant. 1	Note	Frequency (MHz)	Level (dBμV/m)	Over Limit (dB)	Limit Line (dBμV/m)	Read Level (dBμV)	Antenna Factor (dB/m)	Cable Loss (dB)	Preamp Factor (dB)	Ant Pos (cm)	Table Pos (deg)	Peak Avg. (P/A)	Pol. (H/V)
		5642.8	50.63	-17.67	68.3	40.29	33.17	9.25	32.08	150	44	P	H
		5688.4	52.15	-44.59	96.74	41.58	33.23	9.35	32.01	150	44	P	H
		5711.2	53.16	-55.28	108.44	42.45	33.25	9.44	31.98	150	44	P	H
		5723.4	51	-67.65	118.65	40.27	33.27	9.44	31.98	150	44	P	H
		5785	107.77	-	-	96.67	33.33	9.64	31.87	150	44	P	H
		5785	98.45	-	-	87.35	33.33	9.64	31.87	150	44	A	H
		5850.2	51.54	-70.3	121.84	40.26	33.41	9.67	31.8	150	44	P	H
		5855.6	52.65	-58.08	110.73	41.31	33.43	9.71	31.8	150	44	P	H
		5884.8	51.97	-46.05	98.02	40.52	33.46	9.71	31.72	150	44	P	H
		5928.4	51.34	-16.96	68.3	39.77	33.52	9.74	31.69	150	44	P	H
		5619.6	50.53	-17.77	68.3	40.36	33.14	9.15	32.12	150	269	P	V
		5693	51.64	-48.5	100.14	41.07	33.23	9.35	32.01	150	269	P	V
		5707.4	53.25	-54.12	107.37	42.54	33.25	9.44	31.98	150	269	P	V
		5720.8	50.63	-62.09	112.72	39.9	33.27	9.44	31.98	150	269	P	V
		5785	106.74	-	-	95.64	33.33	9.64	31.87	150	269	P	V
		5785	97.49	-	-	86.39	33.33	9.64	31.87	150	269	A	V
		5853	51.24	-64.22	115.46	39.96	33.41	9.67	31.8	150	269	P	V
		5856.2	53.1	-57.46	110.56	41.76	33.43	9.71	31.8	150	269	P	V
		5875	52.64	-52.66	105.3	41.23	33.46	9.71	31.76	150	269	P	V
		5925.2	50.14	-18.16	68.3	38.57	33.52	9.74	31.69	150	269	P	V



WIFI Ant. 1	Note	Frequency (MHz)	Level (dBμV/m)	Over Limit (dB)	Limit Line (dBμV/m)	Read Level (dBμV)	Antenna Factor (dB/m)	Cable Loss (dB)	Preamp Factor (dB)	Ant Pos (cm)	Table Pos (deg)	Peak Avg. (P/A)	Pol. (H/V)
802.11ac VHT20 CH 165 5825MHz		5825	107.32	-	-	96.09	33.39	9.67	31.83	150	46	P	H
		5825	98.61	-	-	87.38	33.39	9.67	31.83	150	46	A	H
		5854	54.28	-58.9	113.18	42.98	33.43	9.67	31.8	150	46	P	H
		5856.8	54.48	-55.92	110.4	43.14	33.43	9.71	31.8	150	46	P	H
		5878	53.82	-49.25	103.07	42.41	33.46	9.71	31.76	150	46	P	H
		5937.8	52.5	-15.8	68.3	40.85	33.52	9.78	31.65	150	46	P	H
		5825	105.82	-	-	94.59	33.39	9.67	31.83	150	281	P	V
		5825	97.48	-	-	86.25	33.39	9.67	31.83	150	281	A	V
		5852	51.99	-65.75	117.74	40.71	33.41	9.67	31.8	150	281	P	V
		5860.4	54.03	-55.36	109.39	42.65	33.43	9.71	31.76	150	281	P	V
	5915.2	53.09	-22.44	75.53	41.54	33.5	9.74	31.69	150	281	P	V	
Remark	1. No other spurious found. 2. All results are PASS against Peak and Average limit line.												



Band 4 5725~5850MHz
WIFI 802.11ac VHT20 (Harmonic @ 3m)

WIFI Ant. 1	Note	Frequency (MHz)	Level (dBμV/m)	Over Limit (dB)	Limit Line (dBμV/m)	Read Level (dBμV)	Antenna Factor (dB/m)	Cable Loss (dB)	Preamp Factor (dB)	Ant Pos (cm)	Table Pos (deg)	Peak Avg. (P/A)	Pol. (H/V)
802.11ac VHT20 CH 149 5745MHz		11490	56.99	-17.01	74	63.51	39.7	13.41	59.63	145	265	P	H
		11490	46.76	-7.24	54	53.28	39.7	13.41	59.63	145	265	A	H
		17235	51.56	-16.74	68.3	55.3	40.06	16.29	60.09	174	321	P	H
		11490	59.52	-14.48	74	66.04	39.7	13.41	59.63	145	265	P	V
		11490	49.15	-4.85	54	55.67	39.7	13.41	59.63	145	265	A	V
		17235	51.59	-16.71	68.3	55.33	40.06	16.29	60.09	174	321	P	V
802.11ac VHT20 CH 157 5785MHz		11570	57.57	-16.43	74	64.1	39.66	13.46	59.65	105	198	P	H
		11570	47.35	-6.65	54	53.88	39.66	13.46	59.65	105	198	A	H
		17355	51.94	-16.36	68.3	55.34	40.34	16.36	60.1	189	185	P	H
		11570	60.14	-13.86	74	66.67	39.66	13.46	59.65	105	198	P	V
		11570	49.71	-4.29	54	56.24	39.66	13.46	59.65	105	198	A	V
		17355	52.04	-16.26	68.3	55.44	40.34	16.36	60.1	189	185	P	V
802.11ac VHT20 CH 165 5825MHz		11650	57.39	-16.61	74	63.94	39.62	13.5	59.67	146	347	P	H
		11650	47.06	-6.94	54	53.61	39.62	13.5	59.67	146	347	A	H
		17475	52.94	-15.36	68.3	56.01	40.62	16.43	60.12	100	360	P	H
		11650	61.36	-12.64	74	67.91	39.62	13.5	59.67	146	347	P	V
		11650	51.33	-2.67	54	57.88	39.62	13.5	59.67	146	347	A	V
		17475	52.04	-16.26	68.3	55.11	40.62	16.43	60.12	100	360	P	V
Remark	1. No other spurious found. 2. All results are PASS against Peak and Average limit line.												



Band 4 5725~5850MHz
WIFI 802.11ac VHT40 (Band Edge @ 3m)

Table with 14 columns: WIFI Ant. 1, Note, Frequency (MHz), Level (dBµV/m), Over Limit (dB), Limit Line (dBµV/m), Read Level (dBµV), Antenna Factor (dB/m), Cable Loss (dB), Preamp Factor (dB), Ant Pos (cm), Table Pos (deg), Peak Avg. (P/A), Pol. (H/V). Rows include frequency data for 802.11ac VHT40 CH 151 5755MHz.



WIFI Ant. 1	Note	Frequency (MHz)	Level (dBμV/m)	Over Limit (dB)	Limit Line (dBμV/m)	Read Level (dBμV)	Antenna Factor (dB/m)	Cable Loss (dB)	Preamp Factor (dB)	Ant Pos (cm)	Table Pos (deg)	Peak Avg. (P/A)	Pol. (H/V)
802.11ac VHT40 CH 159 5795MHz		5644.4	50.6	-17.7	68.3	40.26	33.17	9.25	32.08	159	69	P	H
		5685.6	51.22	-43.46	94.68	40.65	33.23	9.35	32.01	159	69	P	H
		5707.4	53.23	-54.14	107.37	42.52	33.25	9.44	31.98	159	69	P	H
		5720.8	53.2	-59.52	112.72	42.47	33.27	9.44	31.98	159	69	P	H
		5795	104.81	-	-	93.69	33.35	9.64	31.87	159	69	P	H
		5795	96.44	-	-	85.32	33.35	9.64	31.87	159	69	A	H
		5851.2	51.79	-67.77	119.56	40.51	33.41	9.67	31.8	159	69	P	H
		5861	53.76	-55.46	109.22	42.38	33.43	9.71	31.76	159	69	P	H
		5876.8	53.1	-50.86	103.96	41.69	33.46	9.71	31.76	159	69	P	H
		5941.8	50.69	-17.61	68.3	39.02	33.54	9.78	31.65	159	69	P	H
		5638	49.54	-18.76	68.3	39.2	33.17	9.25	32.08	152	281	P	V
		5698.8	51.95	-52.47	104.42	41.38	33.23	9.35	32.01	152	281	P	V
		5719.6	52.13	-58.66	110.79	41.4	33.27	9.44	31.98	152	281	P	V
		5725	51.23	-71.07	122.3	40.5	33.27	9.44	31.98	152	281	P	V
		5795	103.18	-	-	92.06	33.35	9.64	31.87	152	281	P	V
		5795	95.14	-	-	84.02	33.35	9.64	31.87	152	281	A	V
		5852.6	52.01	-64.36	116.37	40.73	33.41	9.67	31.8	152	281	P	V
		5858.4	53.87	-56.08	109.95	42.49	33.43	9.71	31.76	152	281	P	V
	5876.6	52.84	-51.27	104.11	41.43	33.46	9.71	31.76	152	281	P	V	
	5940	51	-17.3	68.3	39.33	33.54	9.78	31.65	152	281	P	V	
Remark	1. No other spurious found. 2. All results are PASS against Peak and Average limit line.												



Band 4 5725~5850MHz

WIFI 802.11ac VHT40 (Harmonic @ 3m)

WIFI Ant. 1	Note	Frequency (MHz)	Level (dBμV/m)	Over Limit (dB)	Limit Line (dBμV/m)	Read Level (dBμV)	Antenna Factor (dB/m)	Cable Loss (dB)	Preamp Factor (dB)	Ant Pos (cm)	Table Pos (deg)	Peak Avg. (P/A)	Pol. (H/V)
802.11ac VHT40 CH 151 5755MHz		11510	55.11	-18.89	74	61.63	39.7	13.41	59.63	100	360	P	H
		11510	45.34	-8.66	54	51.86	39.7	13.41	59.63	100	360	A	H
		17265	51.41	-16.89	68.3	55.05	40.14	16.32	60.1	100	360	P	H
		11510	56.58	-17.42	74	63.1	39.7	13.41	59.63	100	360	P	V
		11510	46.3	-7.7	54	52.82	39.7	13.41	59.63	100	360	A	V
		17265	51.03	-17.27	68.3	54.67	40.14	16.32	60.1	100	360	P	V
802.11ac VHT40 CH 159 5795MHz		11590	55.23	-18.77	74	61.76	39.65	13.48	59.66	100	300	P	H
		11590	44.74	-9.26	54	51.27	39.65	13.48	59.66	100	300	A	H
		17385	51.41	-16.89	68.3	54.71	40.42	16.39	60.11	100	200	P	H
		11590	56.77	-17.23	74	63.3	39.65	13.48	59.66	100	300	P	V
		11590	46.28	-7.72	54	52.81	39.65	13.48	59.66	100	300	A	V
		17385	51.7	-16.6	68.3	55	40.42	16.39	60.11	100	200	P	V
Remark	1. No other spurious found. 2. All results are PASS against Peak and Average limit line.												



Band 4 5725~5850MHz
WIFI 802.11ac VHT80 (Band Edge @ 3m)

WIFI Ant. 1	Note	Frequency (MHz)	Level (dBμV/m)	Over Limit (dB)	Limit Line (dBμV/m)	Read Level (dBμV)	Antenna Factor (dB/m)	Cable Loss (dB)	Preamp Factor (dB)	Ant Pos (cm)	Table Pos (deg)	Peak Avg. (P/A)	Pol. (H/V)
802.11ac VHT80 CH 155 5775MHz		5642	59.26	-9.04	68.3	48.92	33.17	9.25	32.08	150	68	P	H
		5698.6	59.38	-44.89	104.27	48.81	33.23	9.35	32.01	150	68	P	H
		5716.8	64.21	-45.8	110.01	53.5	33.25	9.44	31.98	150	68	P	H
		5724.8	64.47	-57.37	121.84	53.74	33.27	9.44	31.98	150	68	P	H
		5775	101.43	-	-	90.46	33.33	9.54	31.9	150	68	P	H
		5775	92.91	-	-	81.94	33.33	9.54	31.9	150	68	A	H
		5850.6	57.9	-63.03	120.93	46.62	33.41	9.67	31.8	150	68	P	H
		5864	66.36	-42.02	108.38	54.98	33.43	9.71	31.76	150	68	P	H
		5910.6	60.85	-18.07	78.92	49.3	33.5	9.74	31.69	150	68	P	H
		5944.8	52.28	-16.02	68.3	40.61	33.54	9.78	31.65	150	68	P	H
		5633	59.12	-9.18	68.3	48.78	33.17	9.25	32.08	159	269	P	V
		5684.6	65.33	-28.61	93.94	54.76	33.23	9.35	32.01	159	269	P	V
		5717.2	64.09	-46.03	110.12	53.38	33.25	9.44	31.98	159	269	P	V
		5723.8	64.14	-55.42	119.56	53.41	33.27	9.44	31.98	159	269	P	V
		5775	100.37	-	-	89.4	33.33	9.54	31.9	159	269	P	V
		5775	92.07	-	-	81.1	33.33	9.54	31.9	159	269	A	V
		5850.6	57.67	-63.26	120.93	46.39	33.41	9.67	31.8	159	269	P	V
		5870.8	62.58	-43.89	106.47	51.17	33.46	9.71	31.76	159	269	P	V
	5888.6	62.71	-32.49	95.2	51.24	33.48	9.71	31.72	159	269	P	V	
	5932.8	50.6	-17.7	68.3	39.03	33.52	9.74	31.69	159	269	P	V	

Remark

- No other spurious found.
- All results are PASS against Peak and Average limit line.



Band 4 5725~5850MHz

WIFI 802.11ac VHT80 (Harmonic @ 3m)

WIFI Ant. 1	Note	Frequency (MHz)	Level (dBμV/m)	Over Limit (dB)	Limit Line (dBμV/m)	Read Level (dBμV)	Antenna Factor (dB/m)	Cable Loss (dB)	Preamp Factor (dB)	Ant Pos (cm)	Table Pos (deg)	Peak Avg. (P/A)	Pol. (H/V)
802.11ac VHT80 CH 155 5775MHz		11550	52.9	-21.1	74	59.42	39.67	13.46	59.65	250	0	P	H
		11550	43.32	-10.68	54	49.84	39.67	13.46	59.65	250	0	A	H
		17325	50.29	-18.01	68.3	53.77	40.26	16.36	60.1	150	0	P	H
		11550	55.14	-18.86	74	61.66	39.67	13.46	59.65	250	0	P	V
		11550	44.69	-9.31	54	51.21	39.67	13.46	59.65	250	0	A	V
		17325	50.54	-17.76	68.3	54.02	40.26	16.36	60.1	150	0	P	V
Remark	1. No other spurious found. 2. All results are PASS against Peak and Average limit line.												



Emission below 1GHz

5GHz WIFI 802.11ac VHT20 (LF @ 3m)

WIFI	Note	Frequency	Level	Over	Limit	Read	Antenna	Cable	Preamp	Ant	Table	Peak	Pol.
Ant.				Limit	Line	Level	Factor	Loss	Factor	Pos	Pos	Avg.	
1		(MHz)	(dBμV/m)	(dB)	(dBμV/m)	(dBμV)	(dB/m)	(dB)	(dB)	(cm)	(deg)	(P/A)	(H/V)
5GHz 802.11ac VHT 20 LF		30	26.05	-13.95	40	31.02	26.7	0.33	32	-	-	P	H
		100.81	24.08	-19.42	43.5	36.24	18.78	0.8	31.74	-	-	P	H
		155.13	29.53	-13.97	43.5	42.37	17.58	1.08	31.5	-	-	P	H
		182.29	29.94	-13.56	43.5	43.83	16.38	1.13	31.4	-	-	P	H
		204.6	35.3	-8.2	43.5	49.54	15.83	1.27	31.34	100	90	P	H
		448.07	30.41	-15.59	46	34.59	24.94	2.03	31.15	-	-	P	H
		40.67	29.49	-10.51	40	39.12	21.94	0.42	31.99	100	80	P	V
		67.83	24.29	-15.71	40	42.18	13.38	0.6	31.87	-	-	P	V
		107.6	26.99	-16.51	43.5	39.21	18.65	0.84	31.71	-	-	P	V
		204.6	30.54	-12.96	43.5	44.78	15.83	1.27	31.34	-	-	P	V
		436.43	29.45	-16.55	46	33.41	25.2	2.01	31.17	-	-	P	V
	885.54	31.77	-14.23	46	31.62	28.38	2.97	31.2	-	-	P	V	
Remark	1. No other spurious found. 2. All results are PASS against limit line.												



Note symbol

*	Fundamental Frequency which can be ignored. However, the level of any unwanted emissions shall not exceed the level of the fundamental frequency.
!	Test result is over limit line.
P/A	Peak or Average
H/V	Horizontal or Vertical



A calculation example for radiated spurious emission is shown as below:

WIFI	Note	Frequency	Level	Over	Limit	Read	Antenna	Cable	Preamp	Ant	Table	Peak	Pol.
Ant.				Limit	Line	Level	Factor	Loss	Factor	Pos	Pos	Avg.	
1+2		(MHz)	(dBμV/m)	(dB)	(dBμV/m)	(dBμV)	(dB/m)	(dB)	(dB)	(cm)	(deg)	(P/A)	(H/V)
802.11b		2390	55.45	-18.55	74	54.51	32.22	4.58	35.86	103	308	P	H
CH 01													
2412MHz		2390	43.54	-10.46	54	42.6	32.22	4.58	35.86	103	308	A	H

- Level(dBμV/m) =
Antenna Factor(dB/m) + Cable Loss(dB) + Read Level(dBμV) - Preamp Factor(dB)
- Over Limit(dB) = Level(dBμV/m) – Limit Line(dBμV/m)

For Peak Limit @ 2390MHz:

- Level(dBμV/m)
= Antenna Factor(dB/m) + Cable Loss(dB) + Read Level(dBμV) - Preamp Factor(dB)
= 32.22(dB/m) + 4.58(dB) + 54.51(dBμV) – 35.86 (dB)
= 55.45 (dBμV/m)
- Over Limit(dB)
= Level(dBμV/m) – Limit Line(dBμV/m)
= 55.45(dBμV/m) – 74(dBμV/m)
= -18.55(dB)

For Average Limit @ 2390MHz:

- Level(dBμV/m)
= Antenna Factor(dB/m) + Cable Loss(dB) + Read Level(dBμV) - Preamp Factor(dB)
= 32.22(dB/m) + 4.58(dB) + 42.6(dBμV) – 35.86 (dB)
= 43.54 (dBμV/m)
- Over Limit(dB)
= Level(dBμV/m) – Limit Line(dBμV/m)
= 43.54(dBμV/m) – 54(dBμV/m)
= -10.46(dB)

Both peak and average measured complies with the limit line, so test result is “PASS”.



Appendix C. Duty Cycle Plots

Band	Duty Cycle(%)	T(ms)	1/T(kHz)	VBW Setting
802.11a	97.47	1.394	0.717	1kHz
802.11n HT20	97.30	1.307	0.765	1kHz
802.11n HT40	94.71	0.649	1.540	3kHz
802.11ac VHT20	94.52	0.675	1.481	3kHz
802.11ac VHT40	94.74	0.652	1.533	3kHz
802.11ac VHT80	89.96	0.325	3.080	10kHz

802.11a

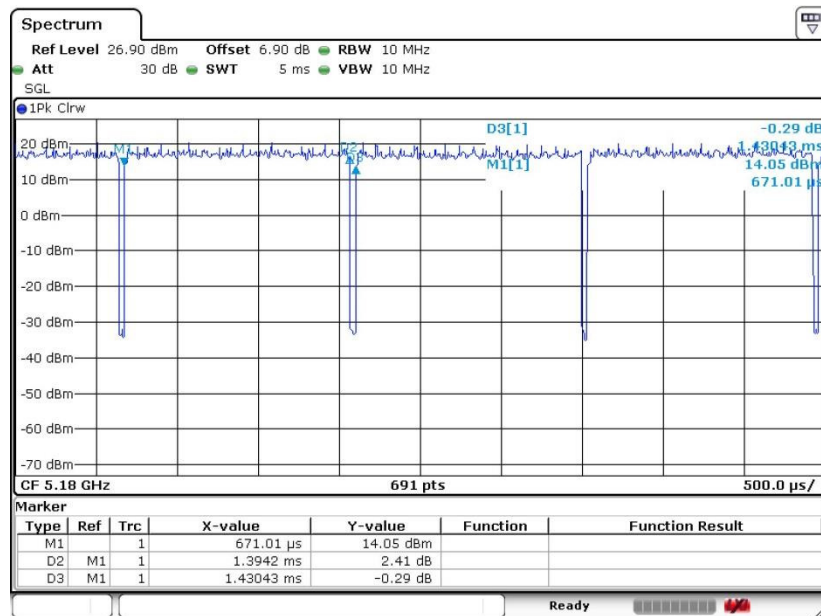

Date: 16.MAR.2017 17:10:50



802.11n HT20

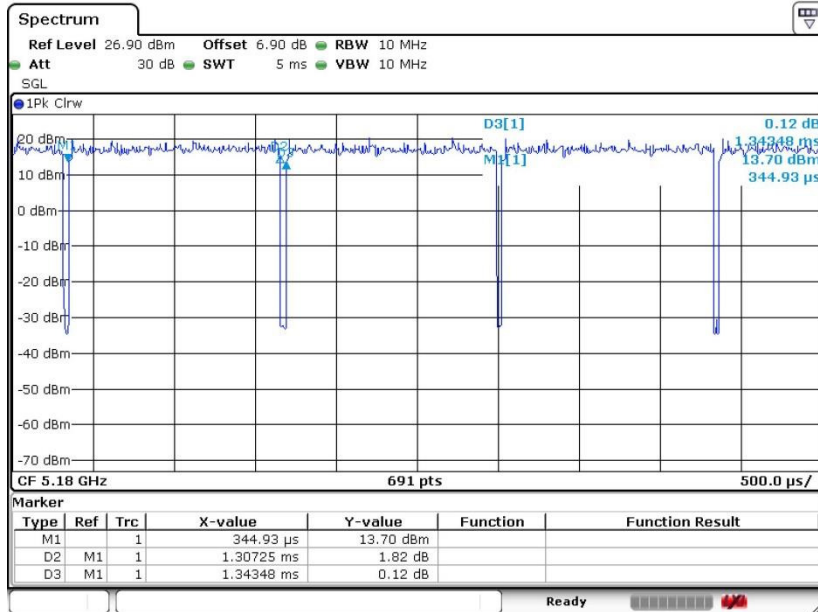

Date: 16.MAR.2017 17:11:37

802.11n HT40

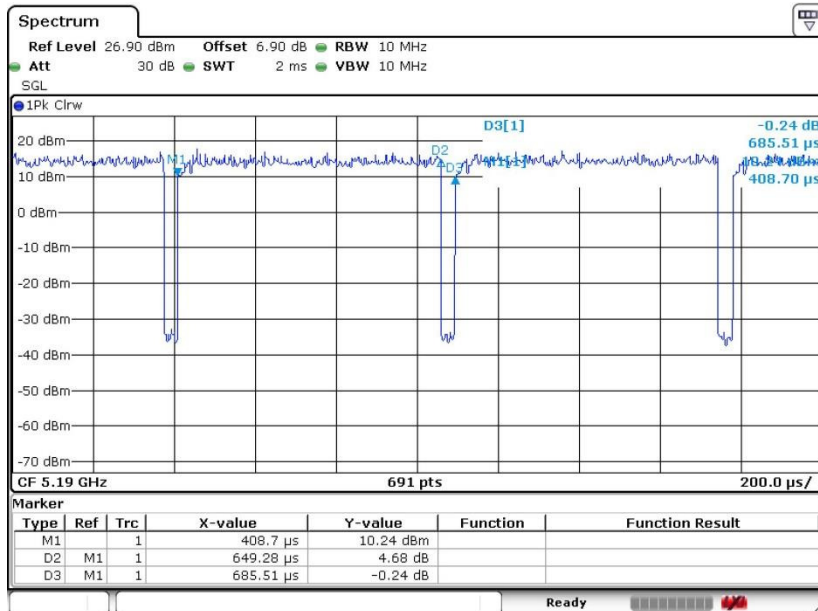

Date: 16.MAR.2017 17:34:37



802.11ac VHT20

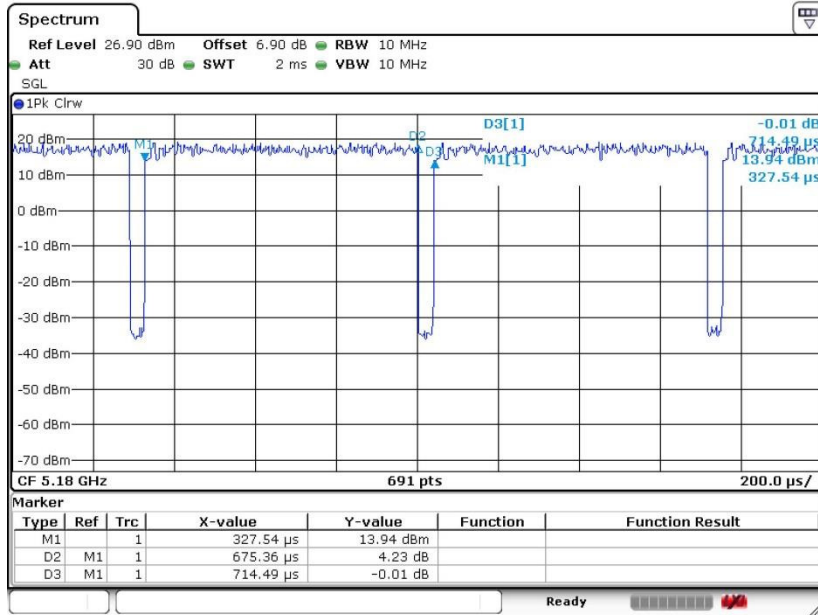

Date: 16.MAR.2017 18:06:31

802.11ac VHT40

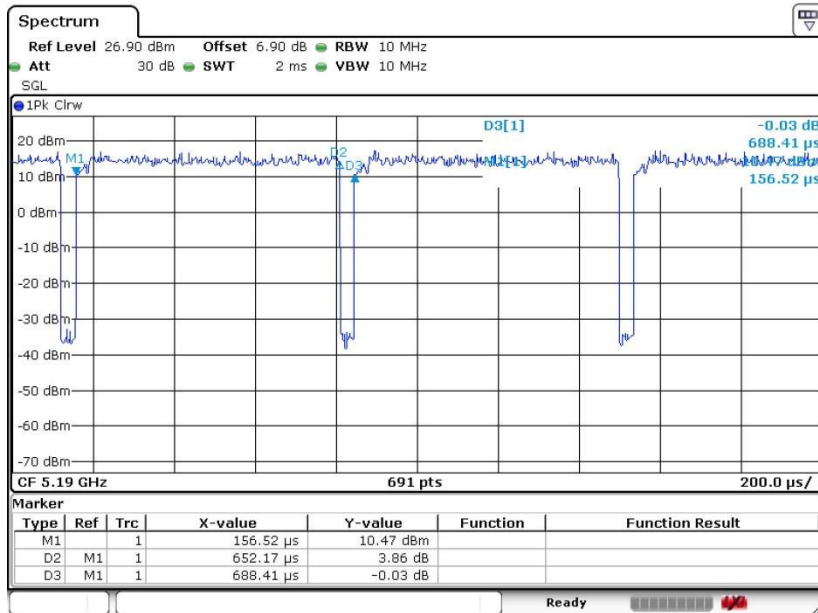

Date: 16.MAR.2017 18:07:24



802.11ac VHT80

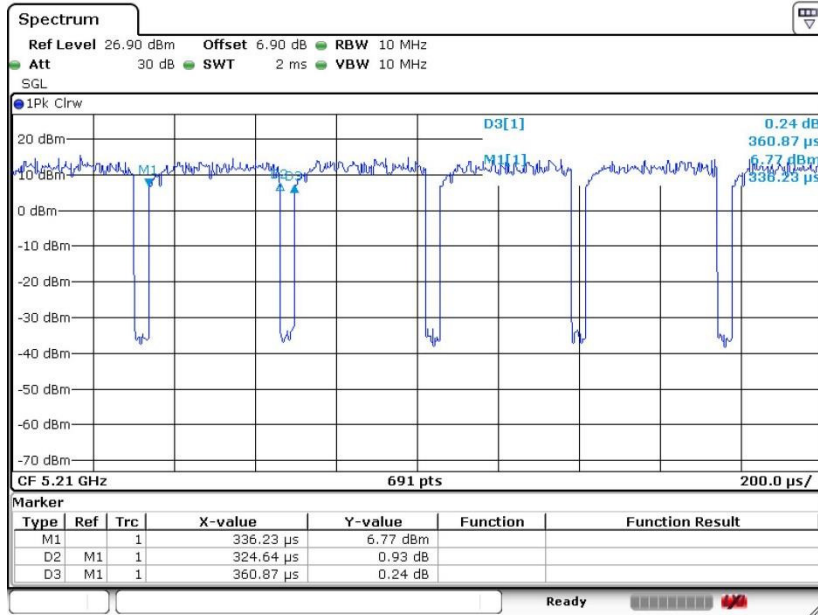

Date: 16.MAR.2017 18:08:36