



Cat® S53

User Manual

PLEASE READ BEFORE FIRST USE SAFETY PRECAUTIONS

- Please read this manual and the recommended safety precautions to ensure the correct use of this device.
- If used in saltwater, rinse the device afterwards to avoid salt corrosion.
- Avoid hitting, throwing, crushing, puncturing or bending the device.
- Do not switch on the device in a circumstance when it is prohibited or where it may cause interference or danger.
- When driving please ensure you adhere to local laws regarding the use of phones.
- Always follow any device use rules in hospitals and health care facilities.
- Please consult your doctor and the device manufacturer to determine if operation of your device may interfere with the operation of your medical device.
- Switch off the device or activate flight mode when in an aircraft.
- Do not switch on the device in a circumstance where the use of mobile phones is prohibited, or in a situation where the device may cause interference or danger.
- Please be aware that disassembling your device may impact the device warranty.
- Take caution and follow guidelines when using the device in environments with flammable gas, such as a gas station.
- Keep the device and its accessories away from young children. Do not allow children to use the device without guidance.
- It is recommended to use a Cat Phones approved chargers to charge your device.
- Observe any laws or regulations on the use of wireless devices. Respect others' privacy and legal rights when using the wireless device.
- Turn off your device when in areas signed to turn off 'two-way radios' or 'electronic devices' to avoid interfering with other equipment.

LEGAL NOTICE

© 2022 Caterpillar. All Rights Reserved.

CAT, CATERPILLAR, LET'S DO THE WORK, their respective logos, "Caterpillar Yellow", the "Power Edge" and Cat "Modern Hex" trade dress as well as corporate and product identity used herein, are trademarks of Caterpillar and may not be used without permission.

Bullitt Mobile Ltd. is a licensee of Caterpillar Inc.

Bullitt Mobile Ltd.'s and third-party trademarks are the property of their respective owners.

No part of this document may be reproduced or transmitted in any form or by any means without prior written consent of Caterpillar Inc.

The product described in this manual may include copyrighted software and possible licensors. Customers shall not in any manner reproduce, distribute, modify, decompile, disassemble, decrypt, extract, reverse engineer, lease, assign, or sublicense the said software or hardware, unless such restrictions are prohibited by applicable laws, or such actions are approved by respective copyright holders under licenses.

The contents of this manual are provided "as is". Except as required by applicable laws, no warranties of any kind, either express or implied, including but not limited to the implied warranties of merchantability and fitness for a particular purpose, are made in relation to the accuracy, reliability, or contents of this manual.

To the maximum extent permitted by applicable law, in no case shall the manufacturer be liable for any special, incidental, indirect, or consequential damages, or lost profits, business, revenue, data, goodwill or anticipated savings.

Wi-Fi® is a registered trademark of Wi-Fi Alliance®.

The Bluetooth® word mark and logos are registered trademarks owned by the Bluetooth SIG, Inc. and any use of such marks by Bullitt Group Ltd is under license. All other third-party trademarks and trade names are those of their respective owners.

Google, Android, Google Play and other marks are trademarks of Google LLC.

All other third-party trademarks and trade names, including the Bullitt trademark, are those of their respective owners.

NOTICE

Some features of the product and its accessories described herein rely on the software installed, capacities and settings of local network, and may not be activated or may be limited by local network operators or network service providers. Therefore, the descriptions in this manual may not exactly match the purchased product or its accessories.

The manufacturer reserves the right to change or modify any information or specifications contained in this manual without prior notice or obligation.

The manufacturer is not responsible for the legitimacy and quality of any products that you upload or download through this device including text, pictures, music, movies, and non-built-in software with copyright protection. Any consequences arising from the installation or usage of the preceding products on this device is accountable to you.

IMPORT AND EXPORT REGULATIONS

Customers shall comply with all applicable export or import laws and regulations. Customers must obtain all necessary governmental permits and licenses to export, re-export or import the product mentioned in this manual including the software and technical data.

CONTENTS

WELCOME TO THE CAT® S53	7
RUGGED CREDENTIALS	7
WHAT'S IN THE BOX	7
KEY FUNCTIONS	8
GETTING STARTED	8
INSTALLING SIM CARD AND MEMORY CARD.....	8
CHARGING THE BATTERY	9
IMPORTANT INFORMATION REGARDING FUTURE USE OF THE BATTERY	10
POWERING YOUR DEVICE ON/OFF	10
TOUCHSCREEN	11
HOME SCREEN	11
LOCKING AND UNLOCKING THE SCREEN/PHONE	11
LOCKING THE SCREEN.....	11
UNLOCKING THE PHONE.....	11
DISPLAY	11
DISPLAY LAYOUT.....	11
NOTIFICATIONS AND STATUS INFORMATION.....	11
NOTIFICATION PANEL	13
SHORTCUT ICONS	13
WIDGETS	13
FOLDERS	14
WALLPAPERS	14
TRANSFERRING MEDIA TO AND FROM YOUR DEVICE	14
USING AIRPLANE MODE	15
MAKING A PHONE CALL	15
CONTACTS	16
USING THE ON-SCREEN KEYBOARD	18
DISPLAYING THE KEYBOARD PANEL.....	18
USING THE LANDSCAPE KEYBOARD.....	18
CUSTOMIZING YOUR KEYBOARD SETTINGS.....	18
WI-FI®	18
SMS AND MMS	18
BLUETOOTH®	20
TAKING PHOTOS AND RECORDING VIDEOS	21
ENJOYING MUSIC	23
USING GOOGLE PLAY	23
SYNCHRONIZING INFORMATION	25

USING OTHER APPS	27
MANAGING THE DEVICE	28
SETTING THE DATE AND TIME	28
PERSONALIZING THE DISPLAY	29
SETTING YOUR RINGTONE	29
SETTING PHONE SERVICES	30
USING NFC	30
PROTECTING THE DEVICE	31
MANAGING APPS	31
RESETTING THE DEVICE	31
APPENDIX	33
VIEWING THE E-LABEL	33
PREVENTION OF HEARING LOSS.....	33
HEARING AID COMPATIBILITY (HAC).....	33
EMERGENCY CALL.....	34
FCC REGULATION.....	34
RF EXPOSURE INFORMATION (SAR).....	34
DISPOSAL AND RECYCLING INFORMATION	35
SAFETY INSTRUCTION	36
CAT@ S53 SPECIFICATION.....	39

WELCOME TO THE CAT® S53

The Cat S53 is robust and reliable. It's not just tough on the outside, it's sleek and sophisticated on the inside too. This latest addition to the Cat phones portfolio includes notable upgrades. Faster 5G connectivity, a better camera, and more memory.

We designed the Cat S53 for dependability in extreme situations. With extended battery life, and a big bright screen you can read in full sunlight and that works with gloves on, and of course it's drop-proof. And you can scrub it with hot water and soap. Useful in these times of essential hygiene vigilance.

RUGGED CREDENTIALS

DROPPING YOUR DEVICE:

- Do: Use your device up to a height of 1.8 meters – it is drop proof within this height range.
- Don't: Throw it with force or drop from above the 1.8 meters; it is durable, but not indestructible.

WATERPROOFING:

- Do: Use your device in damp and wet conditions. Ensure all components and covers are properly closed before using in water. The device can withstand a depth of 1.5 meters, for up to 30 minutes.
- Don't: Attempt to use it for longer than 30 minutes in 1.5 meters depth or beyond.

DUSTPROOF AND SCRATCHPROOF:

- Do: Use your device in dirty, dusty environments. The Cat® S53 is certified to IP68 and IP69K, an industry standard measure for durability.

EXTREME TEMPERATURES:

- Do: Use your device within the operational temperature range of -25°C to 55°C. It can also handle extreme changes in temperature: shifting between cold and hot, or vice versa very quickly.
- Don't: Use it outside the range of 0°C to 45°C without the use of protective gloves.

WHAT'S IN THE BOX

- Device
- Quick start guide
- USB cable
- Factory-fitted screen protector (already on device)

Note:

Your device comes with a factory-fitted screen protector. Please ensure that the screen protector remains in place. Removal of the screen protector may mean that any subsequent damage requiring repairs will be considered to be 'Out of Warranty'. Please visit <https://www.catphones.com/screen-protectors> should you require a replacement screen protector.

Some variants may also include a charger or headset

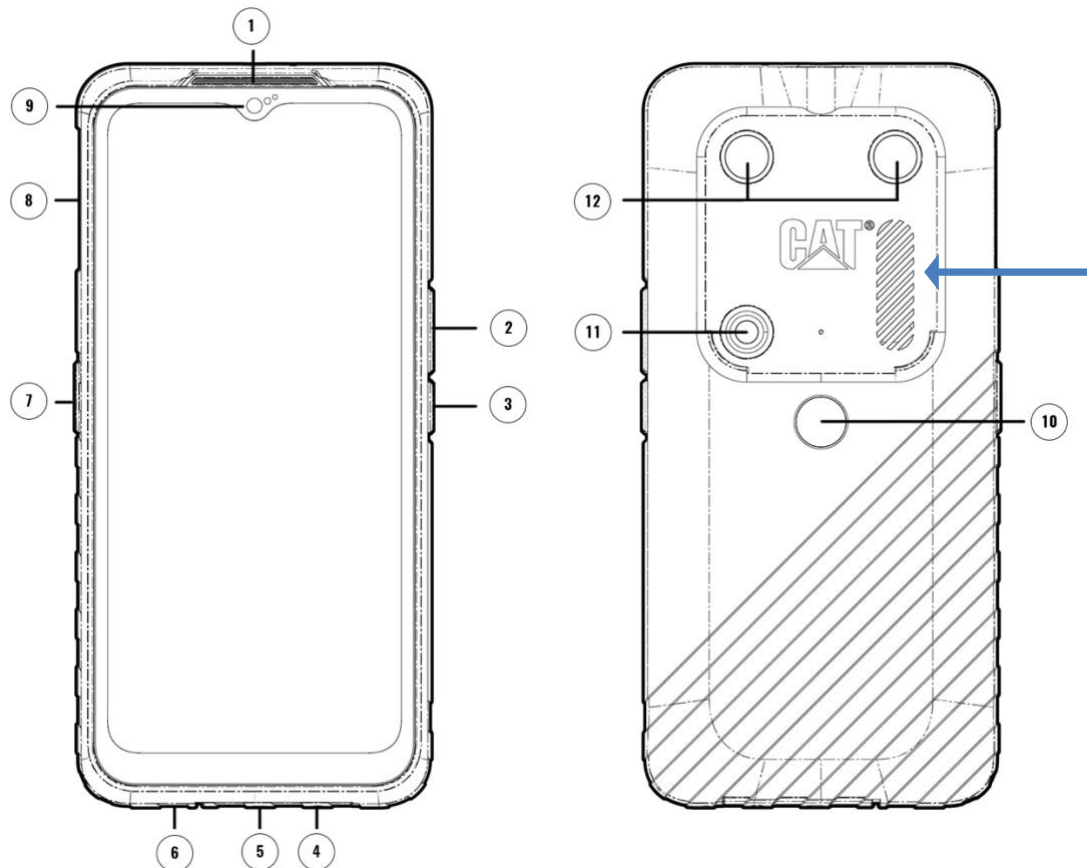

- 1. Earpiece
- 2. Volume Up/Down Keys
- 3. Power button
- 4. Speaker 3.5mm headphone port
- 5. USB Port
- 6. Delete
- 7. Programmable Key

- 8. SIM/SD door
- 9. Front Camera
- 10. Fingerprint Scanner
- 11. Flash
- 12. Rear Cameras

KEY FUNCTIONS

VOLUME UP/DOWN KEY

- Volume – press the Volume Up key to increase, or the Volume Down key to decrease the volume of the call, ringtone, media or alarm
- Screenshot – press Power and Volume Down keys simultaneously (Screenshots are saved in the photo album)
- Camera app – press Volume Up or Down key to take photo.

GETTING STARTED

INSTALLING SIM CARD AND MEMORY CARD

1. Place your device on a flat, clean surface with the display facing up.
2. Use your fingertip to pull out the SIM/SD door and the SIM/SD tray.
3. Place the SIM card in the SIM tray with gold pins of the SIM card (facing up, towards back of phone).

4. If you would like to use a microSD card, place this on the microSD tray with gold pins of the memory card also facing up.

5. Carefully insert the tray back into the SIM card slot and reposition the door.

NOTE

Push the SIM/SD door back in until it is closed securely.

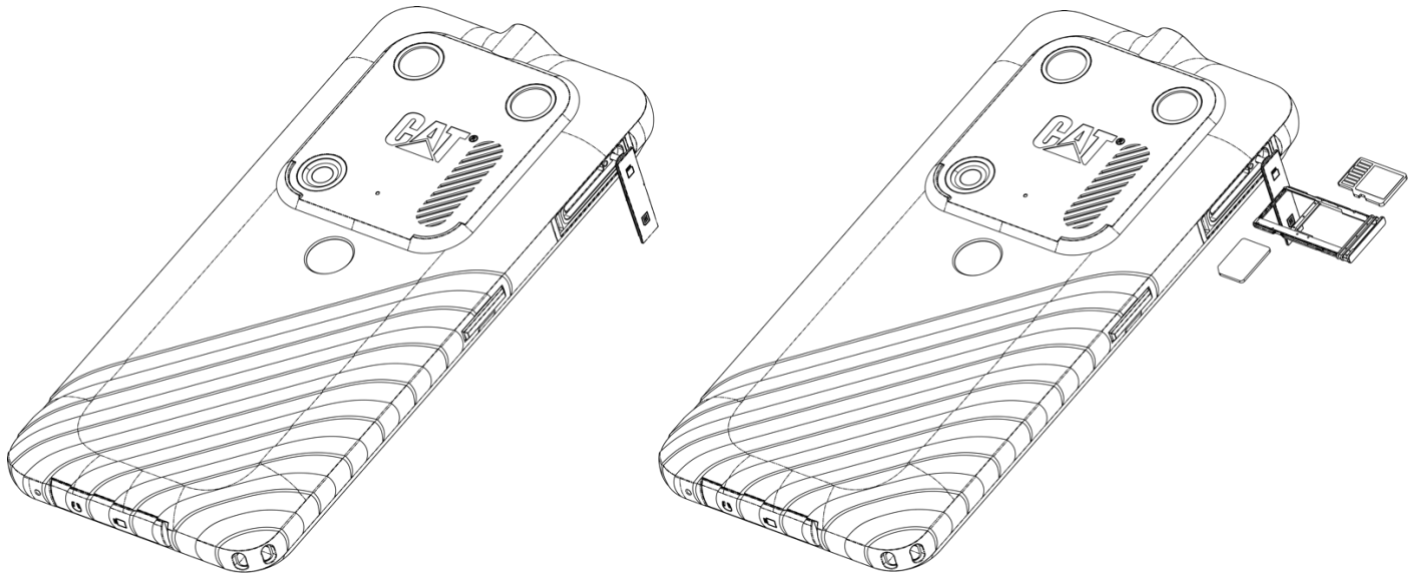

CHARGING THE BATTERY

The S53 battery cannot be removed from the device. To charge it:

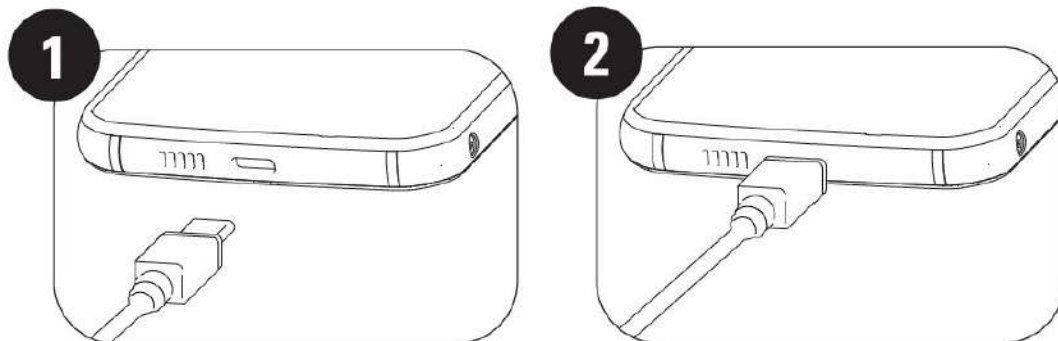

1. Connect the USB power cable to the charging power adapter and insert USB cable into USB port and then

IMPORTANT INFORMATION REGARDING FUTURE USE OF THE BATTERY

When the battery power level is low, the device displays a prompt. When the battery power is almost exhausted, your device will power off automatically. The time required to charge the battery depends on its age and the environmental temperature.

If the battery is completely exhausted, your device may not power on immediately after charging starts. Allow the battery to charge for a few minutes before attempting to turn it on. The on-screen charge animation may not be displayed during this period.

POWERING YOUR DEVICE ON/OFF

POWER ON

- Press and hold the Power Key to turn on your phone.

The first time you turn on your phone, you will see a Welcome Screen. Select your preferred language and tap START to continue the set-up.

- Press and hold to open the power off options (Power off/ Restart/ Emergency) when the device is on.
- Press to lock or wake the screen when the device is idle.

NOTE:

A Wi-Fi or Data connection is required to access data and services.

If personal identification number (PIN) protection is enabled on your SIM Card, you will be asked to enter your PIN before the Welcome Screen.

A Google Account is required to use some of the Google services on your device. You will be asked to sign in with your existing Google Account or set up a new account later.

You may also record one or several of your fingerprints using the fingerprint scanner on the rear of the device. This provides a secure way to unlock your device. You must also define a PIN code or pattern as a secondary method for unlocking your device.

POWER OFF

1. Press and hold the Power Key to open the Power Off options menu.
2. Tap Power off.

TOUCHSCREEN

TOUCHSCREEN ACTIONS

- **Tap:** Use your finger to select an item, confirm a selection or start an app on the screen.
- **Tap and hold:** Tap an item with your finger and continue to press until the screen responds (e.g. to open the options menu for the active screen, tap the screen and hold until the menu appears).
- **Swipe:** Move your finger across the screen either vertically or horizontally (e.g. swipe left or right to switch between screens).
- **Drag:** To move an item, tap and hold it with your fingertip then drag it to any part of the screen.

HOME SCREEN

The Home Screen is the starting point for accessing your device's features. It displays app icons, widgets, shortcuts and more.

You can customize your Home Screen with different wallpapers and adjust it to display your preferred items.

LOCKING AND UNLOCKING THE SCREEN/PHONE

LOCKING THE SCREEN

1. If your device is turned on, press the **Power** Key to lock the screen. You can still receive messages and calls if the screen is locked.
2. If the device is left undisturbed for a certain period, the screen will lock automatically. You can adjust the length of this in the setting menu.

UNLOCKING THE PHONE

Use the fingerprint sensor to unlock. You will be prompted to configure this during the set-up wizard. If you want to add more fingerprints go to Settings > Security > FingerprintNOTE:

When enrolling your fingerprints please make sure that you press your finger hard against the sensor. Failure to do so may see inconsistent results when using the fingerprint sensor.

Press the **Power** key to wake up the screen. Swipe up to unlock the screen. Enter pattern or PIN code if pre-set.

DISPLAY

DISPLAY LAYOUT

NOTIFICATIONS AND STATUS INFORMATION

The **Status Bar** appears at the top of every screen. This displays notification icons, such as missed calls or received messages, along with the current time (on the left) and phone status icons, such as battery status (on the right).

STATUS ICONS



NOTIFICATIONS ICONS

5G	Connected to 5G mobile network		Problem with sign-in or sync
4G LTE	Connected to 4G LTE mobile network		Cellular signal
LTE	Connected to LTE mobile network		Vibrate mode
3G	Connected to 3G mobile network		Location service is being used
G	Connected to GPRS mobile network		Battery is full
E	Connected to EDGE mobile network		Battery is charging
H	Connected to HSDPA mobile network		A Screenshot is captured
H+	Connected to HSPA+ mobile network		Airplane mode
R	Roaming		Connected to a Wi-Fi network
VoLTE	VoLTE		Upcoming event
VoWiFi	VoWiFi		Connected to a Bluetooth device
	Mobile network signal strength		Missed call
	NFC enabled		Speakerphone is activated
	New email message		Phone microphone is muted
	Alarm is set		Downloading data
	Data is syncing		New text message

NAVIGATION BAR

The navigation bar is located at the bottom of the screen. While the device is in full screen mode, please swipe up from the bottom of the device to make the navigation bar appears.

- If you would like to access all apps, please swipe up from the bar.



The bar contains three main soft buttons:

Back Button	• Tap to return to the previous screen.
Home Button	• Tap to return to the home screen • Tap and hold to talk to Google
Recent App Button	• Tap to select the previous opened apps.

NOTIFICATION PANEL

You will get a notification when you receive a new message, miss a call, or have an upcoming event. Open the notification panel to see alarms, wireless network operators or to view a message, reminder or event notification.

OPENING THE NOTIFICATION PANEL

1. When a new icon appears, swipe down the notification panel and then drag down to open the notification panel.
2. Tap a notification to open the related app.

CLOSING THE NOTIFICATION PANEL

1. To close the notification panel, slide the bottom of the panel upwards.
2. To close a notification (without viewing), hold the notification and drag it to the left/right of the screen.

NOTE:

Notifications preferences can be changed in **Settings > Apps & notifications**.

SHORTCUT ICONS

ADDING A NEW HOME SCREEN ITEM

1. From the Home Screen, swipe up.
2. To add an item to your Home Screen, drag its icon to your chosen position.

MOVING A HOME SCREEN ITEM

1. Tap and hold an app icon on the Home Screen until it moves.
2. Without lifting your finger, drag the icon to the chosen position on the screen, then release it.

NOTE:

There must be enough space for an icon to fit on the Home Screen panel.

REMOVING A HOME SCREEN ITEM

1. Tap and hold an app icon on the Home Screen until it moves.
2. Without lifting your finger, drag the icon to **Remove**, then release.

WIDGETS

A widget lets you preview, or use an app. You can place widgets on your Home Screen as icons or preview windows. Several widgets are already installed on your phone, while more can be downloaded on **Google Play**.

ADDING A WIDGET

1. Tap and hold the Home Screen.
2. Tap the Widgets option to see what is available.
3. Drag your chosen widget to the Home Screen.

REMOVING A WIDGET

1. Tap and hold the widget icon on the Home Screen until it moves.
2. Without lifting your finger, drag the icon to **Remove** at the top of the screen, then release.

FOLDERS

CREATING A FOLDER

You can group certain apps on your Home Screen by dragging an icon or shortcut and releasing it on top of another. This will create a new folder that you can add to as you choose.

RENAMING A FOLDER

1. Tap a folder to open it.
2. Enter a new folder name in the title bar.
3. Then touch the screen anywhere outside of the folder.

WALLPAPERS

CHANGING YOUR WALLPAPER

1. Tap and hold the Home Screen.
2. Tap **Wallpapers**.
3. Scroll through the available options.
4. Tap **Set Wallpaper** on chosen image – then choose whether to set it as **Lock Screen wallpaper**, **Home Screen** wallpaper or both.

TRANSFERRING MEDIA TO AND FROM YOUR DEVICE

Transfer your favorite music and pictures between your device and PC in Media Device MTP mode.

1. Connect your device to your PC with the USB power cable.
2. Open the notification panel and the USB connection options. Tap **Charging this device via USB** to access more options.
3. Tap **File transfer** to share files to/from your PC.
4. Your device should be displayed as a removable device displaying the phone's internal storage. If a memory card is inserted, microSD card will also be visible. Copy the chosen files to your device.

Your device will be displayed as a removable device, showing the phone's internal storage. If a memory card is inserted, the microSD card details will also be visible.

NOTE:

If you are using a MAC, the drivers must be downloaded from: <http://www.android.com/filetransfer/>

USING AIRPLANE MODE

Some locations may require you to switch off data connections. Instead of turning off your device, you can set it to Airplane Mode.

1. From the **Home Screen**, swipe down the notification panel and tap  to switch on Airplane mode.

NOTE:

You can also access Airplane Mode from the **Setting** menu.

MAKING A PHONE CALL

There are multiple ways to place a call. You can either:



1. Tap **Phone** icon > Dial a number into the keypad.
2. Select a number from your **Contacts** list.
3. Select a number from a web page or document that contains a phone number.

NOTE:

When you're on a call, you can either answer incoming calls or send them to your voicemail. You can also set up conference calls with several participants.

When you're on a call, press the Home button to return to the Home Screen and use other functions. To return to the calling screen, drag the notification bar down and tap **Current call**.

MAKING A PHONE CALL WITH THE KEYPAD



1. From the **Home Screen**, tap . Then tap  to show the keypad.
2. Tap the numeric keys to dial the phone number.
3. After you enter the number, or select the contact, tap .

Tip: Your device supports the **SmartDial** function. As you type a number into the keypad, it automatically searches your contacts and lists options for ones that match the number. You can close the keypad to view more possible matches.

MAKING A PHONE CALL FROM CONTACTS

1. Swipe up from the Home Screen > **Contacts** to display the contact list. From the **Phone**, tap the  tab to see the contact list.
2. Select a contact.
3. Tap the phone number to call the contact.

MAKING A PHONE CALL FROM THE CALL LOG

1. Swipe up from the Home Screen > **Phone**  to see a list of latest calls. If you cannot find the desired contact, tap  > **Call history** to display all call history.
2. Select a contact from the list and tap to make a call.

ANSWERING AND REJECTING A PHONE CALL

When you receive a phone call, the incoming call screen will show the caller ID, and any additional caller information that you have entered in Contacts.

- To answer a call, tap **ANSWER**.
- To reject the call, tap **DECLINE**.
- To reject the call and send a message directly to the caller, tap the call notification banner and then tap  . Select one of the available template message options or tap Write your own to compose a personal message.

ENDING A PHONE CALL

During a phone call, press **Hang up**  to hang up.

CONTACTS

The **Contacts** app lets you save and manage information about your contacts.

OPENING THE CONTACTS APP

When you set up the device, **Contacts** will display a message outlining how to start adding contacts. To open the app, do one of the following:

- Swipe up from the Home Screen and then tap **Contacts**  .
- All of your contacts are displayed alphabetically in a scrolling list. Tap on them to see more details.

COPYING CONTACTS

You can copy your contacts from the SIM card or saved in internal storage or a memory card.

1. In the contacts list, tap  > **Settings** > **Import**.

2. Do one of the following:

To import contacts from the SIM card:

- Tap **SIM card**. Select the contact(s) and tap **IMPORT** to import the selected contact(s).

To import contacts from the internal storage or memory card:

- Tap **.vcf file**. Select the location where to import the contacts and tap the *.vcf file to import the contacts.

BACK UP CONTACTS

You can copy contacts to internal storage.

1. In the contacts list, tap  > **Settings** > **Export**.
2. Select the location where to save the contacts and tap **SAVE**.

ADD A NEW CONTACT

1. In the contacts list, tap  to add a new contact.
2. Enter the contact's name, and then add any detailed information such as phone number or address.
3. Tap **Save** to store the contact information.

ADDING A NEW CONTACT TO YOUR FAVORITE

1. Tap the contact you want to add to favorite.
2. Tap  at the top right corner.

SEARCHING FOR A CONTACT

1. In the contacts list, tap  to search for a contact.
2. Enter the name of the contact for which you are searching. As you type, contacts with matching names appear below the search box.

EDITING A CONTACT

You can always make changes to the information you have stored for a contact.

1. In the contacts list, tap the contact you want to edit.
2. Tap the edit icon .
3. Make the desired changes to the contact information, then tap **Save**. To cancel any changes press **X**.

DELETING A CONTACT

1. In the contacts list, tap the contact you want to delete.
2. Tap  > Delete.
3. Tap Delete again to confirm.

USING THE ON-SCREEN KEYBOARD

DISPLAYING THE KEYBOARD PANEL

Some apps open the keyboard automatically. In others, tap a text field to open the keyboard. Press the Back button to hide the keyboard.

USING THE LANDSCAPE KEYBOARD

If you find it difficult to use the keyboard in portrait orientation, simply turn the device sideways. The screen will now display the keyboard in landscape orientation, providing you with a wider keyboard layout.



CUSTOMIZING YOUR KEYBOARD SETTINGS

1. Swipe up from the Home Screen > **Settings**  > **System** > **Languages & input**.
2. Do any of the following:
 - Tap On-screen keyboard to configure the Google keyboard and Google voice typing settings.
 - Tap Physical keyboard to configure the external keyboard settings.
 - Tap Advanced to access the input assistance related settings.

WI-FI®

Access to wireless access points (hotspots) is required to use Wi-Fi on your device.

TURNING ON WI-FI AND CONNECTING TO A WIRELESS NETWORK

1. Swipe up from the Home Screen > **Settings**  > **Network & Internet**.
2. Tap **Wi-Fi** and slide the Wi-Fi switch to the right .
3. Choose a Wi-Fi network to connect to from the list.
4. If you select an open network, the device will connect automatically. If you select a network that is secured, you must enter a password and tap **Connect**.

NOTE:

- You will not have to re-enter the password for a secured network if you have connected to it before, unless the device has been reset to its default settings, or if the Wi-Fi password has been changed.
- Obstacles blocking the Wi-Fi signal will reduce its strength.

Tip: On the Wi-Fi settings screen, tap **+ Add network** to add an invisible Wi-Fi network.

SMS AND MMS

OPENING MESSAGING

To open the app, do one of the following:

- Tap  on the **Home Screen**.

- Swipe up from the Home Screen > **Messages** 

CREATING AND SENDING A TEXT MESSAGE



You can create a new text message or open an ongoing message thread.

1. Tap **Start chat** to start a new text message or tap an existing message thread to open it.
2. Enter a phone number or contact name into the To field. When you type, the **SmartDial** will attempt to match it with the device's contacts. Either tap a suggested recipient or continue to type. If you want to open an existing message thread, simply tap it.
3. Tap the text box to compose your message. If you press the < **Back** button while composing a message, it will save as a draft in the message list. Tap the message to resume.
4. When your message is ready to send, tap  .

NOTE:

- As you view and send additional messages, a message thread is created.

CREATING AND SENDING A MULTIMEDIA MESSAGE

1. On the messaging screen, tap **Start chat**.
2. Enter a phone number or contact name into the **To** field or scroll down the contact list to find the contact you wish to message. Tap to start a group conversation.
3. Tap the text box to compose a message.
4. Tap  and select the type of media file. Select the file to attach.
5. Your device is now in multimedia mode. Once you're done, tap  .

OPENING AND REPLYING TO A MESSAGE

1. In the message list, tap a text or multimedia message thread to open it.
2. Tap the text box to compose a message.
3. When ready, tap  .

BLUETOOTH®

Your Cat® S53 device has Bluetooth. It can create a wireless connection with other Bluetooth devices, so you can share files with your friends, talk hands-free with a Bluetooth headset, or even transfer photos from your device to a PC.

If you are using Bluetooth, remember to stay within 10 meters of the Bluetooth device you want to connect to. Be aware that obstacles like walls or other electronic equipment may interfere with the Bluetooth connection.

TURNING ON BLUETOOTH

1. Swipe up from the **Home Screen** > **Settings** > **Connected devices**.

2. Tap **Connection preference** > **Bluetooth** and slide the switch  to the right to enable the function.

When Bluetooth is turned on, the Bluetooth icon  appears in the notification bar.

PAIRING AND CONNECTING A BLUETOOTH DEVICE

Bluetooth lets you do the following:

- Use a hands-free Bluetooth device.
- Use a mono or stereo Bluetooth headset.
- Control what plays through the Bluetooth headset remotely.

Before you use Bluetooth, you need to pair your device with another Bluetooth device as follows:

1. Ensure that the Bluetooth function on your device is enabled.
2. Tap **+ Pair new device**. Your device will then search for Bluetooth devices in range.
3. Tap the device you want to pair with.
4. Follow the on-screen instructions to complete the connection.

NOTE:

- Once a partnership has been created, you will no longer have to enter a password if you connect to that Bluetooth device again.

SENDING FILES VIA BLUETOOTH

With Bluetooth, you can share pictures, videos, or music files with family and friends. To send files via Bluetooth:

1. Tap the file you want to send.
2. Tap  > **Bluetooth**, then select a paired device.

DISCONNECTING OR UNPAIRING A BLUETOOTH DEVICE

1. Swipe up from the **Home Screen** > **Settings** > **Connected devices**.

2. Tap **Previously connected devices**.





3. Tap  and then tap **FORGET** to confirm the disconnection.

TAKING PHOTOS AND RECORDING VIDEOS

You can use your Cat® S53 to shoot and share pictures and videos.

OPENING YOUR CAMERA AND TAKING A PHOTO

To open the camera app, do the following:

- Tap  on the Home Screen.
- By default, the app opens in Camera mode. If not, tap **Photo** at bottom of the screen.
- To switch between front and rear camera, tap  .
- Compose your photo within the photo capture screen.
- Tap the screen to focus on a specific area.
- Pinch to zoom in/out of the subject.
- Scrolling left and right will change the camera mode
- Tap  to change the camera and video settings.
- Tap  to take your photo.
- you can also take photos by pressing the **Volume up/down** keys.

VIEWING PHOTOS

To view your photos, do one of the following:



- When in the **Camera** app, tap the thumbnail of the latest captured photo in the bottom left corner to access the gallery app.
- Swipe up from the **Home Screen** > **Photos**  to view all photos and videos.



NOTE:

To go back to Camera view, press the camera icon in the top left corner or swipe to the right until the capture screen appears again.







EDIT AND SHARE PHOTOS

As you browse through your photos, the following options are available:

- Share: Tap  to share your photos through various apps available on your device.
- Edit: Tap  to edit your photos with a range of options available.

- Search: Tap  to see the search similar image online.
- Delete: Tap  to delete the photos you don't want.
- Details: Swipe up to see the details of the photos.

SHOOTING A VIDEO

1. Tap  on the Home Screen.
- By default, the app opens in Camera mode.
2. Swipe to the right to switch to Video mode.
- To switch between front and rear camera, tap .
3. Tap  to start recording.
 4. While recording, do one of the following:
 - Pinch to zoom in/out on the subject.
 - Tap  to pause the recording. Tap again to resume.
 - Tap  to take a photo.
 - Tap  to stop shooting.

VIEWING YOUR VIDEOS

To view a video after recording, tap the thumbnail of the latest captured video in the bottom left hand corner to access the gallery app. You can also view this in **Photos** .

USING PHOTOS

The **Photos** app automatically searches for pictures and videos saved to your device or memory card. Select the album/folder and play as a slideshow or select items to share with other apps.

OPENING PHOTOS

Swipe up from the **Home Screen** > **Photos**  to open the application. The Photos app categorizes your pictures and videos by storage location and stores these files in folders. Tap a folder to view the pictures or videos inside.

VIEWING A PHOTO

1. In **Photos**, tap a folder to view the photos inside.
2. Tap the picture to view it in full-screen mode, then swipe left or right to view the previous or next picture.
3. To zoom in on the image, pinch two fingers apart from each other at the location of the screen where you want to zoom in. In zoom mode, swipe your finger up or down and left or right.

ENJOYING MUSIC

Music files can be transferred from a PC onto your Cat® S53 so you can listen to music wherever you are.

COPYING MUSIC TO YOUR DEVICE

1. Connect your device to a computer with the USB cable and swipe down from the top of the screen and select **File Transfer** on the device.
2. On the PC, navigate to the USB drive (called Cat® S53) and open it.
3. Create a folder in the root directory of your device or in the SD card (for example, Music).
4. Copy your music from the PC to the new folder.
5. To safely remove your device from the PC, wait until the music has finished copying, then eject the drive as required by your PC's operating system. Disconnect the USB cable.

OPENING YouTube Music and PLAYING MUSIC



- Swipe up from the **Home Screen**, then tap **YT Music** 
- Tap **Library**, then tap **Downloads** to add songs into your playlist, or tap the **Search** button on the right top corner to search your songs online.

USING GOOGLE PLAY

You must sign into a Google Account to use Gmail, Google Calendar, and to download and use other Google apps.

CREATING A GOOGLE ACCOUNT

If you chose not to create a Google Account during set up, it's easy to create one:

1. Swipe up from the **Home Screen** > Settings .
2. Tap **Accounts** > **Add account**.
3. Tap **Google** , then follow the on-screen instructions.

USING GMAIL

During set-up, you may have configured your device to an existing Google Account. The first time you open the **Gmail** app on your phone, your inbox will contain the messages from this account.



OPENING GMAIL

Swipe up from the **Home Screen** > Gmail 



SWITCHING BETWEEN ACCOUNTS

Tap on the account picture in the top right of the screen, and the account selection box will appear for you to switch to the account you want to view.

CREATING AND SENDING AN EMAIL

1. On the Inbox screen, tap **Compose**.
2. Enter the message recipient's email address in the **To** field.
 - To send the email to several recipients, separate the email addresses with spaces.
 - To **Cc** or **Bcc** other recipients, tap  to display the **Cc/Bcc** fields.
3. Enter the email subject and compose your message.
 - If you want to add a picture attachment, tap  > **Attach file**, to select a file.
4. To send, tap .

REPLYING OR FORWARDING EMAIL

1. Select the email on the Inbox screen.
2. Tap  to reply or tap  to select **Reply all** or **Forward**.

CUSTOMIZING YOUR GMAIL SETTINGS

3. On the Gmail home screen, tap  > **Settings**.
4. Choose General settings, or an email account.
5. Tap an option and change the necessary settings.

USING GOOGLE PLAY

Download and install apps and games on **Google Play**.

OPENING GOOGLE PLAY

Swipe up from the **Home Screen** > **Google Play**.

SEARCHING FOR APPS

To find apps on **Google Play** home screen, you can:

- List apps by category: Tap a category and scroll through.
- Use Search: Enter search keywords in the field.

INSTALLING AN APP

1. Swipe up from the **Home Screen** > **Google Play**.
2. Tap a category, and then tap the item you want to download for added information.

3. To install the item, tap **Install**.

NOTE:

Charges may apply to some of the content in Google Play. You can check the progress of a download in the notification panel.

UNINSTALLING AN APP

1. Swipe up from the Home Screen to access the App drawer.

2. Hold your finger on the app that you wish to uninstall and drag it up to Uninstall in the top right of the screen.

NOTE:

Apps can also be managed by going to the main phone **Settings > Apps & notifications**.

SYNCHRONIZING INFORMATION

Some apps (for example, Gmail and Calendar) on your Cat® S53 provide access to the same information that you can add, view and edit on other devices. If you add, change or delete information in any of these apps on other devices, the updated information will also appear on your device.

This is made possible through over-the-air data synchronization. The process occurs in the background and does not interfere with your device. When your device is synchronizing, a data synchronization icon will be shown in the notification bar.

MANAGING YOUR ACCOUNTS

You can synchronize contacts, email and other information on your device with multiple Google Accounts or other accounts, depending on the apps you have installed.

For example, adding a personal Google Account means your personal email, contacts, and calendar entries are always available. You can also add a work account, so your work-related emails, contacts and calendar entries are kept separate.

ADDING AN ACCOUNT

1. Swipe up from the **Home Screen > Settings**.

2. Tap **Accounts**. The screen will show your current synchronization settings and a list of your current accounts being used in related applications.

NOTE:

- In some cases, account details may need to be obtained from your network administrator support. For example, you may need to know the account's domain or server address.

3. Tap **+ Add account**.

4. Tap the account type to add.

5. Follow the on-screen instructions to enter the required and optional information about your account. Most accounts require a username and password, but the details depend on the kind of account and the configuration of the service to which you are connecting to.

6. When you are finished, your account will be added to the list in the **Accounts** settings screen.

REMOVING AN ACCOUNT

An account and all information associated with it can be removed from your device, including email, contacts, settings, etc. Some accounts, however, cannot be removed, such as the first account you signed into on your device. If you attempt to remove certain accounts, be aware that all personal information associated with it will be deleted.

1. On the **Accounts** settings screen, tap the account to delete.
2. Tap **REMOVE ACCOUNT**, then again when prompted to confirm.



CUSTOMIZING YOUR ACCOUNT SYNCHRONIZATION

Background data use and synchronization options can be configured for all the applications on your device. You can also configure the kind of data synchronized for each account. Some applications, such as Contacts and Gmail, can synchronize data from multiple applications.

Synchronizing is two-directional for some accounts and changes made to the information on your device are made to the copy of that information on the web. Some accounts support only one-way synchronization and the information on your device is read-only.

CHANGING AN ACCOUNT'S SYNCHRONIZATION SETTINGS

1. On the **Accounts** settings screen, tap the account.
2. Tap **Account sync**. The data and synchronization screen will open, displaying a list of information that the account can synchronize.
3. Enable the items you want to sync by:



- Sliding the respective data switch to the right .
- To disable automatic sync, slide the respective data switch to the left .

USING OTHER APPS

USING THE CALENDAR

Use **Calendar** to create and manage events, meetings and appointments. Depending on your synchronization settings, the calendar on the device stays in synchronization with the calendar on your other devices.

OPENING THE CALENDAR

Swipe up from the **Home Screen** > **Calendar**  to open the app. Tap  to display the various view and settings options.

CREATING AN EVENT

1. On any calendar view, tap  > **Event**, to start adding an event.
2. Enter the event title, location, or the contacts.

- If there is a time frame for the event, tap the beginning and end date, and times.
- If it is a special occasion such as a birthday or a day-long event, slide the All-day switch to the right  .
- 3. Set the time of your event reminder, invite people, set a color and add any notes or attachments.
- 4. Once all information is entered and settings are complete, tap **Save**.

SETTING AN EVENT REMINDER

1. On any calendar view, tap an event to view its details.
2. Tap  to start editing the event.
3. Tap **Add notification** to set the reminder for the event.
4. Tap **Save** to save it.



USING THE CLOCK AND RELATED FUNCTIONS

Within the Clock app there is a host of other functionality including Alarm, Timer, Stopwatch, and Bedtime.

OPENING THE CLOCK

Swipe up from the **Home Screen** > Clock  .

ADDING AN ALARM

1. On the alarm list screen, tap  to add an alarm.
2. To set your alarm, do the following:
 - Set the hour and minutes by navigating around the dial, tap **OK**.
 - To set repeat mode, tap the **Repeat** check box. Tap one or more options.
 - To set the alarm sound, tap  , then select an option.
 - If you want your device to vibrate when the alarm sounds, tap the **Vibrate** check box.
 - To add an alarm label, tap **Label**. Enter the label, then tap **OK**.

NOTE:

- By default, the alarm is automatically activated.

SETTING A TIMER

1. Select **Timer**, insert the duration of the timer and press [icon].
2. When the timer expires an alert will sound.

USING THE STOPWATCH

1. Tap the screen to start and stop the stopwatch.
2. Press [icon] to reset the timer.

BEDTIME

The Bedtime function allows you to configure how your phone performs at night. This includes alarm times and setting Do not disturb.

CALCULATOR

Your Cat® S53 is equipped with a calculator that has both a standard and advanced mode.

OPENING THE CALCULATOR

1. Swipe up from the **Home Screen** > Calculator  to open the app.
2. Swipe left or rotate the device to horizontal to access the Advanced calculator mode.

MANAGING THE DEVICE

To configure your device, swipe up from the **Home Screen** > **Settings**.

SETTING THE DATE AND TIME

When you first turn on your device, there is an option to update the time and date automatically, using the time provided by your network.

NOTE:

You cannot set the date, time and time zone manually if using the automatic option.

If you wish to set the date and time settings manually, do the following:

- 1 On the Settings screen, tap **System** > **Date & time**.
2. Slide the **Use network-provided time/time zone** switches to the left  to disable the functions.
3. Tap **Date**, then select the desired date and tap **OK**.
4. Tap **Time**. On the set time screen, tap the hour or minute field and move the pointer up or down to set the time. Tap **OK** when the configuration is complete.
5. Tap **Time zone**, and then select the desired time zone from the list.
6. Enable or disable the Use 24-hour format function to switch between 24-hour and 12-hour formats.

PERSONALIZING THE DISPLAY

ADJUSTING THE SCREEN BRIGHTNESS

1. On the **Settings** screen, tap **Display** > **Brightness level**.
2. Drag the slider left to make the screen darker, or right to make it brighter.

3. Lift your finger off the slider to save your settings automatically.

Tip: Slide the Adaptive Brightness switch to the right to enable the device to automatically adjust the brightness of the screen depending on the light level around you.

AUTO-ROTATE SCREEN

To enable the display to rotate when you turn your device between landscape and portrait, tap **Advanced** and slide the Auto-rotate switch to the right .

ADJUSTING THE IDLE TIME BEFORE THE SCREEN TURNS OFF

If your device is idle for a period of time, the screen will turn off to save battery power. To set a longer or shorter idle time:

1. On the **Settings** screen, tap **Display > Advanced > Screen timeout**.
2. Select the duration you want the screen to be illuminated for before it turns off.

NOTE:

When your device is asleep, use the fingerprint sensor or press **Power** to wake the screen.

SETTING YOUR RINGTONE

TURNING ON SILENT MODE

- Press the Volume key until the volume control panel appears on the screen. Then tap the first icon until  is displayed.
- All sounds except media and alarms will be silenced.

ADJUSTING THE RINGTONE VOLUME

You can adjust the ringtone volume from the **Home Screen**, or from any app (except during a call or when playing music or videos). Press the **Volume up/down key** then  to adjust the ringtone volume to your chosen level. You can also adjust the ringtone volume on the **Settings** screen.

1. On the **Settings** screen, tap **Sound**.
2. In **Ring volume**, drag the slider to adjust the volume level.

CHANGING THE RINGTONE

1. On the **Settings** screen, tap **Sound**.
2. Tap **Phone ringtone**.
3. Select the ringtone you want to use. A preview will play when selected.
4. Tap **OK**.

SETTING THE DEVICE TO VIBRATE FOR INCOMING CALLS

On the **Settings** screen, tap **Sound**. Then slide the **Vibrate for calls** switch to the right



SETTING PHONE SERVICES

TURNING ON DATA ROAMING

1. On the **Settings** screen, tap **Network & Internet > Mobile network**.
2. Slide the **Roaming** switch to the right

NOTE:

- Remember that accessing data services while roaming may incur considerable additional charges. Check with your network service provider about data roaming fees.

DISABLE DATA SERVICE

1. On the **Settings** screen, tap **Network & Internet > Mobile network**.
2. Slide the **Mobile data** switch to the left

USING NFC

NFC allows the exchange of data between two NFC-enabled devices, when both devices are either touching or no more than a few inches apart.

ACTIVATING THE NFC FUNCTION

1. On the **Settings** screen, tap **Connected devices > Connection preferences**.
2. Slide the NFC switch to the right
3. The Android™ Beam function will also be enabled automatically.

BEAMING CONTENT VIA NFC

1. Enable the NFC and Android Beam functions.
2. Open the content to be shared (you can share web content, YouTube videos, contacts and much more)

3. Place the devices back-to-back, when prompted Tap to beam, tap your screen.

PROTECTING THE DEVICE

PROTECTING THE DEVICE WITH A SCREEN LOCK

To keep the data on your Cat® S53 more secure you can use a screen lock method.

1. On the **Settings** screen, tap **Security > Screen lock**.
2. Select the one of the available options.
 - **Swipe**: Swipe the lock icon up to unlock the screen.
 - **Pattern**: Trace the correct unlock pattern to unlock the screen.
 - **PIN**: Enter a PIN number to unlock the screen.
 - **Password**: Enter a password to unlock the screen.
3. Follow the on-screen instructions to complete the set-up of your chosen screen lock method.

MANAGING APPS

VIEWING AN INSTALLED APP

1. On the **Settings** screen, tap **Apps & notifications**.
2. Here you can do any of the following:
 - Tap an app to view its details directly.
 - Tap **Notifications** to configure the notification settings.
 - Tap **Default apps** to set, or clear default apps.
 - Tap **Advanced > Permission manager** to adjust what information the app can access.
 - Tap **Advanced > Emergency alerts** to change your emergency alert settings.
 - Tap **Advanced > Special app access** to configure which apps can access special features listed here.

RESETTING THE DEVICE

BACKING UP PERSONAL SETTINGS

Your personal settings can be backed up to Google servers with a Google Account. If you replace your device, the backed-up settings will be transferred onto a new device the first time it is signed into from a Google Account.

1. On the **Settings** screen, tap **System > Backup**.
2. Slide the **Back up to Google Drive** switch to the right .

RESTORING FACTORY DATA

If you restore the factory data, your device will reset to the settings that were configured at the factory. All of your personal data from the internal device storage, including account information, the system and application settings, and any downloaded applications will be erased.

Resetting your device does not erase any system software updates that have been downloaded or any files on a microSD card, such as music or photos.

1. On the **Settings** screen, tap **System > Advanced > Reset options > Erase all data (factory reset)**.
2. When prompted, tap **RESET PHONE**, and then tap **ERASE EVERYTHING**. The device will reset to the original factory settings, and then restart.

APPENDIX

OPERATING TEMPERATURE

- Keep the ambient temperature between -25°C to 55°C for using the device powered by a battery. While charging the device, the ambient temperature should be between 0°C to 40°C . Please wear protective gloves while using it outside the range of 0°C to 45°C .

VIEWING THE E-LABEL

To view the regulatory information on your device, do the following:

1. From the Home Screen, tap > Settings.
2. On the Settings screen, tap About phone > Regulatory information.

PREVENTION OF HEARING LOSS



To prevent possible hearing damage, do not listen at high volume levels for long periods.

EMERGENCY CALL

This device can be used for emergency calls in the service area. The connection, however, cannot be guaranteed in all conditions. The device should not be relied on solely for essential communications.

CE SAR COMPLIANCE

This device meets the EU requirements (1999/519/EC) on the limitation of exposure of the general public to electromagnetic fields by way of health protection.

The limits are part of extensive recommendations for the protection of the general public. These recommendations have been developed and checked by independent scientific organizations through regular and thorough evaluations of scientific studies. The unit of measurement for the European Council's recommended limit for mobile devices is the "Specific Absorption Rate" (SAR), and the SAR limit is 2.0 W/ kg averaged over 10 gram of tissue. It meets the requirements of the International Commission on Non-Ionizing Radiation Protection (ICNIRP).

For body worn operation, this device has been tested and meets the ICNIRP exposure guidelines and the European Standard EN 62209-2, for use with dedicated accessories. Use of other accessories which contain metals may not ensure compliance with ICNIRP exposure guidelines.

SAR is measured with the device at a separation of 5 mm to the body, while transmitting at the highest certified output power level in all of the device's frequency bands.

The highest reported SAR values under the CE regulatory for the phone are listed below:

Head SAR : 1.179 W/kg, Body SAR : 1.362 W/kg, Limbs SAR : 1.624 W/Kg

To reduce exposure to RF energy, use a hands-free accessory or other, similar options to keep this device away from your head and body. The device must be carried 5mm from the body to ensure exposure levels remain at or below the as-tested levels. Choose the belt clips, holsters, or other similar body-worn accessories which do not contain metallic components to support operation in this manner. Cases with metal parts may change the RF performance of the device, including its compliance with RF exposure guidelines in a manner that has not been tested or certified. Thus, use of such accessories should be avoided.

To reduce the level of exposure to radiation, please do the following:

- Use the mobile phone in good reception conditions to reduce the amount of radiation received (in particular in underground car parks and on train or car journeys).
- Use a hand free kit
- For pregnant women, please keep the device away from the stomach
- Use the device away from genital parts

FCC REGULATION

This mobile phone complies with part 15 of the FCC Rules. Operation is subject to the following two conditions:

- (1) This device may not cause harmful interference, and (2) this device must accept any interference received, including interference that may cause undesired operation.

This mobile phone has been tested and found to comply with the limits for a Class B digital device, pursuant to Part 15 of the FCC Rules. These limits are designed to provide reasonable protection against harmful interference in a residential installation. This equipment generates, uses and can radiated radio frequency energy and, if not installed and used in accordance with the instructions, may cause harmful interference to radio communications.

However, there is no guarantee that interference will not occur in a particular installation. If this equipment does cause harmful interference to radio or television reception, which can be determined by turning the equipment off and on, the user is encouraged to try to correct the interference by one or more of the following measures:

- Reorient or relocate the receiving antenna.
- Increase the separation between the equipment and receiver.
- Connect the equipment into an outlet on a circuit different from that to which the receiver is connected.
- Consult the dealer or an experienced radio/TV technician for help.

FCC NOTE:

Caution: Changes or modifications not expressly approved by the party responsible for compliance could void the user's authority to operate the equipment.

RF EXPOSURE INFORMATION (SAR)

This mobile phone is designed and manufactured not to exceed the emission limits for exposure to radio frequency (RF) energy set by the Federal Communications Commission of the United States.

During SAR testing, this device was set to transmit at its highest certified power level in all tested frequency bands, and placed in positions that simulate RF exposure in usage against the head with no separation, and near the body with the separation of 10 mm. Although the SAR is determined at the highest certified power level, the actual SAR level of the device while operating can be well below the maximum value. This is because the phone is designed to operate at multiple power levels so as to use only the power required to reach the network. In general, the closer you are to a wireless base station antenna, the lower the power output.

The exposure standard for wireless devices employing a unit of measurement is known as the Specific Absorption Rate, or SAR.

The SAR limit set by the FCC is 1.60 W/kg.

This mobile phone is complied with SAR for general population /uncontrolled exposure limits in ANSI/IEEE C95.1-1992 and had been tested in accordance with the measurement methods and procedures specified in IEEE1528. The FCC has granted an Equipment Authorization for this model phone with all reported SAR levels evaluated as in compliance with the FCC RF exposure guidelines. SAR information on this model phone is on file with the FCC and can be found under the Display Grant section of www.fcc.gov/oet/ea/fccid after searching on FCC ID: ZL5BM1S4LE.

The highest reported SAR values under the FCC regulatory for the phone are listed below:

Head SAR: 0.513 W/kg,

Body SAR: 1.166W/kg,

Wireless Router SAR: 1.166W/kg

While there may be differences between the SAR levels of various phones and at various positions, they all meet the government requirements.

SAR compliance for body-worn operation is based on a separation distance of 10 mm between the unit and the human body. Carry this device at least 10 mm away from your body to ensure RF exposure level compliant or lower to the reported level. To support body-worn operation, choose the belt clips or holsters, which do not contain metallic components, to maintain a separation of 10 mm between this device and your body.

RF exposure compliance with any body-worn accessory, which contains metal, was not tested and certified, and as such body-worn accessories should be avoided.

DISPOSAL AND RECYCLING INFORMATION



This symbol on the device (and any included batteries) indicates that they should not be disposed of as normal household garbage. Do not dispose of the device or batteries as unsorted municipal waste. The device (and any batteries) should be handed over to a certified collection point for recycling or proper disposal at the end of their life.

For more detailed information about the recycling of the device or batteries, contact your local city office, the household waste disposal service, or the retail store where you purchased this device.

The disposal of the device is subject to the Waste from Electrical and Electronic Equipment (WEEE) directive of

the European Union. The reason for separating WEEE and batteries from other waste is to minimize the potential environmental impacts on human health from any of the hazardous substances that may be present.

SAFETY INSTRUCTIONS

WARNINGS AND PRECAUTIONS

This section contains important information relating to the operating instructions for this device. It also contains information about how to use the device safely. Read this information carefully before using the device.

WATERPROOF CASING

The SIM/SD door must be closed securely to ensure the device is waterproof.

DO NOT USE YOUR DEVICE IN THE FOLLOWING CONDITIONS:

Power off the device if you're in a situation where using it is prohibited, for example:

- Hospitals and healthcare facilities – this is to prevent possible interference with sensitive medical equipment.
- Medical devices - please consult your doctor and the device manufacturer to determine if operation of your device may interfere with the operation of your medical device. Follow the rules and regulations set forth by hospitals and healthcare facilities.
- Pacemaker manufacturers recommend that a minimum distance of 5.9 inches be maintained between a device and a pacemaker to prevent potential interference with the pacemaker. If you have a pacemaker, use the device on the opposite side of the pacemaker and do not carry the device in your front pocket.
- Aircraft – consult airline staff about the use of wireless devices on board the aircraft. If your device offers a 'flight mode', this must be enabled prior to boarding an aircraft.
- Other devices – do not use your device in a place where it could cause damage or interfere with other electronic devices.
- Potentially explosive atmosphere – power off the device in any area with a potentially explosive atmosphere and comply with all signs and instructions. Areas that may have potentially explosive atmospheres include the areas where it is advised to turn off a vehicle engine. Triggering of sparks in such areas could cause an explosion or a fire, resulting in bodily injuries or even death. Do not turn on the device at refueling points such as service stations. Comply with restrictions on the use of radio equipment in fuel depots, storage, and distribution areas, and chemical plants. In addition, adhere to restrictions in areas where blasting operations are in progress. Before using your device, watch out for areas that have potentially explosive atmospheres that are often, but not always, clearly marked. Such locations include areas below the deck on boats, chemical transfer or storage facilities, and areas where the air contains chemicals or particles such as grain, dust, or metal powders. Ask the manufacturers of vehicles using liquefied petroleum gas (such as propane or butane) whether this device can be safely used in their vicinity.
- A small percentage of people may be susceptible to blackouts or seizures (even if they have never had one before) when exposed to flashing lights or light patterns such as when using LED flashlight, playing games or watching video. If you have experienced seizures or blackouts or have a family history of such occurrences, you should consult your doctor before using those functions.

TRAFFIC SECURITY

Observe local laws and regulations while using this device. In addition, if you need to use the device while driving a vehicle, comply with the following guidelines:

- Concentrate on driving. The first responsibility is to drive safely.
- Do not talk on your device while driving. Use hands-free accessories.
- To make or answer a call, park the vehicle at the roadside before using the device.
- RF signals may affect the electronic systems of motor vehicles. For more information, consult the vehicle manufacturer.
- In a motor vehicle, do not place the device over the air bag or in the air bag deployment area. If the air bag was to inflate, the strong force with your device on top could cause serious injury.
- If travelling by aircraft, turn your device to flight mode. Using wireless devices in an aircraft may cause danger to the operation of the aircraft and disrupt the wireless telephone network. It may also be considered illegal.
- Do not engage in distracting conversations that are emotional or stressful. In order to reduce the potential of diverting driver's attention, please ensure the persons in the conversation are aware that you are driving.

OPERATING ENVIRONMENT

- The device complies with the RF specifications when the device is used near your ear or at a distance of 0.4 inches from your body. Ensure that the device accessories such as a device case and a device holster are not composed of metal components. Keep the device 0.4 inches away from your body to meet the requirement earlier mentioned.
- On a stormy day with thunder, do not use the device when it is being charged to prevent any danger caused by lightning.
- While using the device, observe the local laws and regulations, and respect others' privacy and legal rights.
- The maximum use altitude: not more than 2000 m above sea level.

PREVENTION OF HEARING DAMAGE

Using a headset at high volume can damage your hearing. To reduce the risk of damage to hearing, lower the headset volume to a safe and comfortable level.

SAFETY OF CHILDREN

Comply with all precautions regarding children's safety. Letting a child play with this device or its accessories, which may include parts that can be detached from the device, may be dangerous, as it may present a choking hazard. Ensure that small children are kept away from the device and its accessories.

ACCESSORIES

Choose only chargers and accessories approved for use with this model by the device manufacturer. The use of any other type of charger or accessory may invalidate any warranty for the device, may be in violation of local rules or laws, and may be dangerous. Please contact your device retailer for information about the availability of approved chargers and accessories in the area.

BATTERY AND CHARGER

- Unplug the charger from the electrical plug and the device when not in use.
- The battery can be charged and discharged hundreds of times before it eventually wears out.

- Do not expose the battery in sunlight or smoky, dusty environment. A battery subjected to extremely low air pressure that may result in an explosion or the leakage of flammable liquid or gas.
- In the extremely unlikely event that battery electrolyte leaks out, ensure that the electrolyte does not come into contact with skin and eyes. If the electrolyte touches skin or splashes into eyes, wash eyes with clean water immediately and consult a doctor.
- If there is a case of battery deformation, color change, or abnormal heating while charging, stop using the device immediately. Otherwise, it may lead to battery leakage, overheating, explosion, or fire.
- Do not dispose of this device in fire as it may explode. Battery may also explode if pierced or severely damaged.
- Do not modify or remanufacture, attempt to insert foreign objects into the battery, immerse or expose to water or other liquids, expose to fire, explosion or other hazards.
- Do not disassemble or open, crush, bend or deform, puncture, or shred.
- Only use the battery for the system for which it is specified
- Do not short circuit a battery or allow metallic conductive objects to contact battery terminals.
- Avoid dropping the device. If the device is dropped, especially on a hard surface, and you suspect damage, take it to a qualified service center for inspection. Improper use may result in a fire, explosion or other hazard.
- Replace the battery only with another battery that has been qualified with the system. Use of an unqualified battery may present a risk of fire, explosion, leakage, or other hazards. Only authorized service providers shall replace battery. (The Cat® S53 battery is not user replaceable)
- Promptly dispose of used devices in accordance with local regulations.
- Battery usage by children should be supervised.
- Connecting to device with improperly grounded equipment can result in an electric shock to the device and may permanently damage the device
- The USB power cable is considered as a separate device to the charging adapter.
- If the USB power cable is damaged (for example, the cord is exposed or broken), or the plug loosens, stop using the cable at once. Otherwise, it may lead to an electric shock, a short circuit of the charger, or a fire.
- Use the AC power supply defined in the specifications of the charger. An improper power voltage may cause a fire or a malfunction of the charger.

CLEANING AND MAINTENANCE

- The charger is not water-resistant. Keep it dry. Protect the charger from water or vapor. Do not touch the charger with wet hands, otherwise it may lead to a short circuit, a malfunction of the device and may cause you an electric shock.
- Do not place your device and charger in places where they can get damaged by impact. Otherwise, it may lead to battery leakage, device malfunction, overheating, fire or explosion.
- Do not place magnetic storage media such as magnetic cards and floppy disks near the device. Radiation from the device may erase the information stored on them.
- Do not leave this device and charger in a place with an extreme high or low temperature. Otherwise, they may not function properly and may lead to a fire or an explosion. When the temperature is lower than 32°F, performance of the battery will be affected.
- Do not place sharp metal objects such as pins near the earpiece. The earpiece may attract these objects and hurt you.

- Before cleaning or maintaining this device, power it off and disconnect from the charger.
- Do not dismantle the device or accessories. Otherwise, the warranty of the device and accessories will be invalidated, and the manufacturer is not liable to pay for the damage.
- If the device screen is broken by colliding with hard objects, do not touch or try to remove the broken part. In this case, stop using the device immediately, and contact an authorized service center.

REDUCTION OF HAZARDOUS SUBSTANCES

This device is compliant with the EU Registration, Evaluation, Authorization and Restriction of Chemicals (REACH) Regulation (EU Regulation (EC) No 1907/2006 (REACH) of the European Parliament and of the Council) and the EU Restriction of Hazardous Substances (RoHS).

Directive (Directive 2011/65/EU (RoHS) and its amendment directive (EU) 2015/863 of the European Parliament and of the Council). It is recommended to visit the Web site regularly for up-to-date information.

EU REGULATORY CONFORMANCE

Hereby, Bullitt Mobile Ltd. declares that this device is compliant with the essential requirements and other relevant provisions of Directive 2014/53/EU. For the declaration of conformity, visit the website:

<https://www.catphones.com/download/Certification>

Authorised Representative:

Authorised Representative Service

77 Camden Street Lower

Dublin D02 XE80

Ireland

EU COMPLIANCE STATEMENT

This device is restricted to indoor use only when operating in the 5150 to 5350 MHz frequency range.

Restrictions in: Belgium (BE), Bulgaria (BG), Czech Republic (CZ), Denmark (DK), Germany (DE), Estonia (EE), Ireland (IE), Greece (EL), Spain (ES), France (FR), Croatia (HR), Italy (IT), Cyprus (CY), Latvia (LV), Lithuania (LT), Luxembourg (LU), Hungary (HU), Malta (MT), Netherlands (NL), Austria (AT), Poland (PL), Portugal (PT), Romania (RO), Slovenia (SI), Slovakia (SK), Finland (FI), Sweden (SE), North Ireland(UK(NI)), Switzerland (CH), Norway (NO), Iceland (IS), Liechtenstein (LI) and Turkey (TR).

NOTE:

Observe the national local regulations in the location where the device is to be used. This device may be restricted for use in some or all member states of the European Union (EU).

Some bands may not be available in all countries or all areas. Please contact the local carrier for more details.

Maximum radio-frequency power transmitted in the frequency bands in which the radio equipment operates: The maximum power for all bands is less than the highest limit value specified in the related Harmonized Standard.

The frequency bands and transmitting power nominal limits applicable to this radio equipment are as follows:

SPECTRUM AND POWER TABLE (EU Variant Only)

Frequency Band	Conducted Power(dB)
GSM 900	32
GSM 1800	30
WCDMA Band I	24
WCDMA Band VIII	24
FDD-LTE B1	24
FDD-LTE B3	24
FDD-LTE B7	24
FDD-LTE B8	24

FDD-LTE B20	24
FDD-LTE B28	25
TDD-LTE B34	24
TDD-LTE B38	24
TDD-LTE B40	24
5G NR SA Band n1	24
5G NR SA Band n3	24
5G NR SA Band n7	24
5G NR SA Band n8	24
5G NR SA Band n28	24
5G NR SA Band n41	25
5G NR SA Band n77	25
5G NR SA Band n78	25
5G NR NSA EN-DC_1_n78 : 1920 - 1980 MHz	24
5G NR NSA EN-DC_3_n78: 1710 - 1785 MHz	24
5G NR NSA EN-DC_8_n78 : 880 - 915 MHz	24
5G NR NSA EN-DC_3_n41: 2496 - 2690 MHz	25
5G NR NSA EN-DC_1_n78 :3300 - 3800 MHz	25
5G NR NSA EN-DC_3_n78 : 3300 - 3800 MHz	25
5G NR NSA EN-DC_8_n78 :3300 - 3800 MHz	25
5G NR NSA EN-DC_3_n41 : 1710 - 1785 MHz	22
BT-BR/EDR	8
BT-BLE	4
WiFi 2.4G	18
WiFi : 5180 - 5240 MHz	18
WiFi : 5260 - 5320 MHz	18
WiFi : 5500 - 5700 MHz	18
WiFi : 5745 - 5825 MHz	14
NFC : 13.553-13.567 MHz	8 dBuA/m

UKCA REGULATORY CONFORMANCE

Hereby, Bullitt Mobile Ltd. declares that the radio equipment with this declaration and bearing the UKCA Mark is in compliance with UK Radio Equipment Regulations 2017. The full text of the UK declaration of conformity is available at the following internet address: <https://www.catphones.com/download/Certification>



UKCA COMPLIANCE STATEMENT

Restriction in the UK: 5150 to 5350 MHz indoor-use only

CAT® S53 SPECIFICATION

Operation System	Android 11
Processor	Qualcomm SD480
Memory	<ul style="list-style-type: none"> Internal Memory: 128GB eMMC / 6GB LPDDR4X SDRAM External Memory: SDXC, Class 10/Ultra high speed/up to 256GB

Cellular Network	5G band: n1, n2, n3, n5, n7 n8, n28, n41, n66, n77, n78 LTE: 1,2,3,4,5,7,8,12,13,17,18,19,20,25,26,28,34,38,39,40,41,66 WCDMA: 1,2,4,5,6,8,19 GSM: 850,900,1800,1900
Display	Size 6.5" HD+ with wet finger & glove support
Camera	<ul style="list-style-type: none"> • Rear Camera: 48MP and 2MP PDAF single LED flash • Front Camera: 16MP
Sensor	<ul style="list-style-type: none"> • Ambient Light • Accelerometer • Gyroscope • Compass • Proximity
Connectivity	<ul style="list-style-type: none"> • Bluetooth: 5.1 • USB: 2.0 • WiFi 802.11 a/b/g/n/ac • GPS, aGPS, GLONASS, Gaileo, EGNOS, SBAS, Beidou • NFC • SIM type: Nano SIM
Battery	3.85V, 5500mAH
Others	Ingress Protection: IP68 & IP69K Drop: 1.8m Waterproof: 1.5m for up to 30mins Programmable Key with PTT mode USB, Wireless charging
Dimensions	171*81*16mm
Weight	290g

* Design and specifications are subject to change without prior notice.



© 2022 Caterpillar. All Rights Reserved. CAT, CATERPILLAR, LET'S DO THE WORK, their respective logos, "Caterpillar Yellow", the "Power Edge" and Cat "Modern Hex" trade dress as well as corporate and product identity used herein, are trademarks of Caterpillar and may not be used without permission. www.cat.com / www.caterpillar.com

Bullitt Mobile Ltd. is a licensee of Caterpillar Inc.

Bullitt Mobile Ltd.'s and third-party trademarks are the property of their respective owners. Bullitt Mobile Ltd. One Valpy, Valpy Street, Reading, Berkshire RG1 1AR, United Kingdom