



RF TEST REPORT

Applicant Bullitt Group
FCC ID ZL5B40E
Product Mobile Phone
Brand CAT
Model B40
Report No. R2101A0004-R3V1
Issue Date March 19, 2021

TA Technology (Shanghai) Co., Ltd. tested the above equipment in accordance with the requirements in **FCC CFR47 Part 2 (2019)/ FCC CFR47 Part 27C (2019)**. The test results show that the equipment tested is capable of demonstrating compliance with the requirements as documented in this report.

Prepared by: Peng Tao

Approved by: Kai Xu

TA Technology (Shanghai) Co., Ltd.

No.145, Jintang Rd, Tangzhen Industry Park, Pudong Shanghai, China

TEL: +86-021-50791141/2/3

FAX: +86-021-50791141/2/3-8000



TABLE OF CONTENT

1	Test Laboratory.....	5
1.1	Notes of the Test Report.....	5
1.2	Test facility.....	5
1.3	Testing Location.....	5
2	General Description of Equipment under Test.....	6
2.1	Applicant and Manufacturer Information.....	6
2.2	General information.....	6
3	Applied Standards.....	8
4	Test Configuration.....	9
5	Test Case Results.....	10
5.1	RF Power Output and Effective Isotropic Radiated Power Ambient condition.....	10
5.2	Occupied Bandwidth.....	15
5.3	Band Edge Compliance.....	21
5.4	Peak-to-Average Power Ratio (PAPR).....	29
5.5	Frequency Stability.....	31
5.6	Spurious Emissions at Antenna Terminals.....	34
5.7	Radiates Spurious Emission.....	38
6	Main Test Instruments.....	42
	ANNEX A: The EUT Appearance.....	43
	ANNEX B: Test Setup Photos.....	44



Version	Revision description	Issue Date
Rev.0	Initial issue of report.	March 17, 2021
Rev.1	Update information.	March 19, 2021

Note: This revised report (Report No. R2101A0004-R3V1) supersedes and replaces the previously issued report (Report No. R2101A0004-R3). Please discard or destroy the previously issued report and dispose of it accordingly.



Summary of Measurement Results

Number	Test Case	Clause in FCC rules	Verdict
1	RF Power Output and Effective Isotropic Radiated Power	2.1046/27.50(h)(2)	PASS
2	Occupied Bandwidth	2.1049	PASS
3	Band Edge Compliance	27.53(m)	PASS
4	Peak-to-Average Power Ratio	27.50(d)/KDB971168 D01(5.7)	PASS
5	Frequency Stability	2.1055 / 27.54	PASS
6	Spurious Emissions at Antenna Terminals	2.1051/27.53(m)	PASS
7	Radiates Spurious Emission	2.1053/27.53(m)	PASS

Date of Testing: January 11, 2021 ~ February 19, 2021

Date of Sample Received: January 4, 2021

Note: PASS: The EUT complies with the essential requirements in the standard.

FAIL: The EUT does not comply with the essential requirements in the standard.

All indications of Pass/Fail in this report are opinions expressed by TA Technology (Shanghai) Co., Ltd. based on interpretations and/or observations of test results. Measurement Uncertainties were not taken into account and are published for informational purposes only.



1 Test Laboratory

1.1 Notes of the Test Report

This report shall not be reproduced in full or partial, without the written approval of **TA technology (shanghai) co., Ltd.** The results documented in this report apply only to the tested sample, under the conditions and modes of operation as described herein .Measurement Uncertainties were not taken into account and are published for informational purposes only. This report is written to support regulatory compliance of the applicable standards stated above.

1.2 Test facility

FCC (Designation number: CN1179, Test Firm Registration Number: 446626)

TA Technology (Shanghai) Co., Ltd. has been listed on the US Federal Communications Commission list of test facilities recognized to perform measurements.

A2LA (Certificate Number: 3857.01)

TA Technology (Shanghai) Co., Ltd. has been listed by American Association for Laboratory Accreditation to perform measurement.

1.3 Testing Location

Company: TA Technology (Shanghai) Co., Ltd.
Address: No.145, Jintang Rd, Tangzhen Industry Park, Pudong Shanghai, China
City: Shanghai
Post code: 201201
Country: P. R. China
Contact: Xu Kai
Telephone: +86-021-50791141/2/3
Fax: +86-021-50791141/2/3-8000
Website: <http://www.ta-shanghai.com>
E-mail: xukai@ta-shanghai.com

2 General Description of Equipment under Test

2.1 Applicant and Manufacturer Information

Applicant	Bullitt Group
Applicant address	One Valpy, Valpy Street, Reading, Berkshire, RG1 1AR, United Kingdom
Manufacturer	Bullitt Mobile Limited
Manufacturer address	One Valpy, Valpy Street, Reading, Berkshire, RG1 1AR, United Kingdom

2.2 General information

EUT Description			
Model	B40		
IMEI	IMEI 1:351743660016965 IMEI 2:351743660016973		
Hardware Version	V00		
Radio Version	Dual SIM: LTE_D03140.10_B40 Single SIM: LTE_S03140.10_B40		
Power Supply	Battery / AC adapter		
Antenna Type	PIFA Antenna		
Antenna Gain	-1dBi		
Test Mode(s)	LTE Band 7		
Test Modulation	(LTE)QPSK 16QAM;		
LTE Release	12		
Maximum E.I.R.P.	LTE Band 7:	20.48dBm	
Rated Power Supply Voltage:	3.8V		
Extreme Voltage	Minimum: 3.23V Maximum: 4.37V		
Extreme Temperature	Lowest: -30°C Highest: +55°C		
Operating Voltage	Minimum: 3.6V Maximum: 4.35V		
Operating Temperature	Lowest: -25°C Highest: +55°C		
Operating Frequency Range(s)	Mode	Tx (MHz)	Rx (MHz)
	LTE Band 7	2500 ~ 2570	2620 ~ 2690
EUT Accessory			
Battery	Manufacturer: NINGBO VEKEN BATTERY CO., LTD Model: 178205511		
Earphone	Manufacturer: JIU JIANG JUWEI ELECTRONICS CO.,LTD Model: JWEP1192-M01H		
USB Cable	Manufacturer: SHENZHEN FKY-QY HARDWARE ELECTRONIC CO.,LTD		



Model: MO36B2000100

Note: 1. The EUT is sent from the applicant to TA and the information of the EUT is declared by the applicant.

Difference Configuration Statement				
Configuration	Configuration 1		Configuration 2	
	Dual card slots	Single card slot	Dual card slots	Single card slot
Memory	DOS DS35M1GA-IB		ESMT F50D1G41LB-83YG2ME	
LCD	Sanlong CT024TN01 (CTC glass)		HLT HTB040WB085 (HSD glass)	
Antibacterial	No		Yes	
Radio Version	LTE_D03140.10_ B40	LTE_S03140.10_ B40	LTE_D03140.10_ B40	LTE_S03140.10_ B40
SIM Card Slot	SIM 1, SIM 2	SIM 1 (SIM 2 slot closed)	SIM 1, SIM 2	SIM 1 (SIM 2 slot closed)
Others	The same		The same	

Customer declared that the difference between the four EUT is only the Memory, LCD, Antibacterial, Radio Version and the quantity of SIM Card Slot. There are more than one Configure, each one should be applied throughout the compliance test respectively, however, only the worst case (Configure 1, Dual card slots) will be recorded in this report.



3 Applied Standards

According to the specifications of the manufacturer, it must comply with the requirements of the following standards:

Test standards:

FCC CFR47 Part 27C (2019)

ANSI C63.26 (2015)

Reference standard:

FCC CFR47 Part 2 (2019)

KDB 971168 D01 Power Meas License Digital Systems v03r01

4 Test Configuration

There is more than one SIM card slot, each one should be applied throughout the compliance test respectively, and however, only the worst case (SIM 1) will be recorded in this report

Radiated measurements are performed by rotating the EUT in three different orthogonal test planes. EUT stand-up position (Z axis), lie-down position (X, Y axis). Receiver antenna polarization (horizontal and vertical), the worst emission was found in position (X axis, vertical polarization) and the worst case was recorded.

All mode and data rates and positions and modulations were investigated.

Subsequently, only the worst case emissions are reported.

The following testing in LTE is set based on the maximum RF Output Power.

The following testing in different Bandwidth is set to detailin the following table:

Test modes are chosen to be reported as the worst case configuration below for LTE Band 7:

Test items	Bandwidth (MHz)				Modulation		RB			Test Channel		
	5	10	15	20	QPSK	16QAM	1	50%	100%	L	M	H
RF Power Output and Effective Isotropic Radiated Power	0	0	0	0	0	0	0	0	0	0	0	0
Occupied Bandwidth	0	0	0	0	0	0	-	-	0	0	0	0
Band Edge Compliance	0	0	0	0	0	0	0	-	0	0	-	0
Peak-to-Average Power Ratio	0	0	0	0	0	0	-	-	0	0	0	0
Frequency Stability	0	0	0	0	0	0	0	0	0	0	0	0
Spurious Emissions at Antenna Terminals	0	0	0	0	0	-	0	-	-	0	0	0
Radiates Spurious Emission	0	-	-	0	0	-	0	-	-	-	0	-
Note	1. The mark "O" means that this configuration is chosen for testing. 2. The mark "-" means that this configuration is not testing.											

5 Test Case Results

5.1 RF Power Output and Effective Isotropic Radiated Power Ambient condition

Temperature	Relative humidity	Pressure
23°C ~25°C	45%~50%	101.5kPa

Methods of Measurement

During the process of the testing, The EUT was connected to the Base Station Simulator with a known loss. The EUT is controlled by the Base Station Simulator test set to ensure max power transmission with proper modulation.

ERP can then be calculated as follows:

$$\text{EIRP (dBm)} = \text{Output Power (dBm)} - \text{Losses (dB)} + \text{Antenna Gain (dBi)}$$

where:dBd refers to gain relative to an ideal dipole.

$$\text{EIRP (dBm)} = \text{ERP (dBm)} + 2.15 \text{ (dB.)}$$

Test Setup

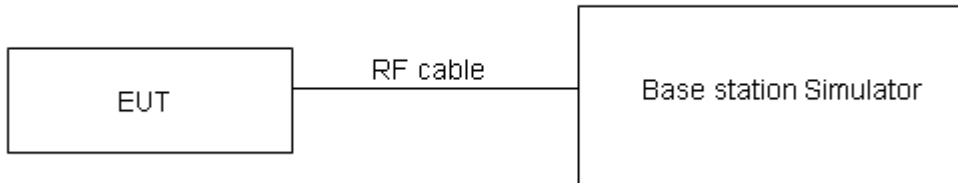

Limits

No specific RF power output requirements in part 2.1046.

Rule Part 27.50(h) (2) specifies that “Mobile and other user stations. Mobile stations are limited to 2.0 watts EIRP. All user stations are limited to 2.0 watts transmitter output power.”

Part 27.50(h)(2) Limit	$\leq 2 \text{ W}$ (33 dBm)
------------------------	-----------------------------

Measurement Uncertainty

The assessed measurement uncertainty to ensure 95% confidence level for the normal distribution is with the coverage factor $k = 2$, $U=0.4$ dB for RF power output, $k = 2$, $U= 1.19$ dB for ERP/EIRP.



Test Results

Band	Bandwidth (MHz)	UL Channel	RB Size	RB Position	Modulation	Maximum Output Power (dBm)	EIRP (dBm)	Verdict
LTE Band 7	5	20775	1	#0	QPSK	20.95	19.95	PASS
LTE Band 7	5	20775	1	#Mid	QPSK	20.98	19.98	PASS
LTE Band 7	5	20775	1	#Max	QPSK	21.04	20.04	PASS
LTE Band 7	5	20775	12	#0	QPSK	20.07	19.07	PASS
LTE Band 7	5	20775	12	#Mid	QPSK	20.10	19.10	PASS
LTE Band 7	5	20775	12	#Max	QPSK	20.14	19.14	PASS
LTE Band 7	5	20775	25	#0	QPSK	20.04	19.04	PASS
LTE Band 7	5	20775	1	#0	16QAM	20.06	19.06	PASS
LTE Band 7	5	20775	1	#Mid	16QAM	20.10	19.10	PASS
LTE Band 7	5	20775	1	#Max	16QAM	20.17	19.17	PASS
LTE Band 7	5	20775	12	#0	16QAM	19.01	18.01	PASS
LTE Band 7	5	20775	12	#Mid	16QAM	19.03	18.03	PASS
LTE Band 7	5	20775	12	#Max	16QAM	19.22	18.22	PASS
LTE Band 7	5	20775	25	#0	16QAM	19.23	18.23	PASS
LTE Band 7	5	21100	1	#0	QPSK	21.02	20.02	PASS
LTE Band 7	5	21100	1	#Mid	QPSK	20.97	19.97	PASS
LTE Band 7	5	21100	1	#Max	QPSK	20.96	19.96	PASS
LTE Band 7	5	21100	12	#0	QPSK	20.25	19.25	PASS
LTE Band 7	5	21100	12	#Mid	QPSK	20.09	19.09	PASS
LTE Band 7	5	21100	12	#Max	QPSK	20.11	19.11	PASS
LTE Band 7	5	21100	25	#0	QPSK	20.11	19.11	PASS
LTE Band 7	5	21100	1	#0	16QAM	19.97	18.97	PASS
LTE Band 7	5	21100	1	#Mid	16QAM	20.01	19.01	PASS
LTE Band 7	5	21100	1	#Max	16QAM	20.03	19.03	PASS
LTE Band 7	5	21100	12	#0	16QAM	19.17	18.17	PASS
LTE Band 7	5	21100	12	#Mid	16QAM	19.17	18.17	PASS
LTE Band 7	5	21100	12	#Max	16QAM	19.74	18.74	PASS
LTE Band 7	5	21100	25	#0	16QAM	19.10	18.10	PASS
LTE Band 7	5	21425	1	#0	QPSK	21.05	20.05	PASS
LTE Band 7	5	21425	1	#Mid	QPSK	20.99	19.99	PASS
LTE Band 7	5	21425	1	#Max	QPSK	21.00	20.00	PASS
LTE Band 7	5	21425	12	#0	QPSK	20.01	19.01	PASS
LTE Band 7	5	21425	12	#Mid	QPSK	20.02	19.02	PASS
LTE Band 7	5	21425	12	#Max	QPSK	20.05	19.05	PASS
LTE Band 7	5	21425	25	#0	QPSK	19.92	18.92	PASS
LTE Band 7	5	21425	1	#0	16QAM	19.69	18.69	PASS
LTE Band 7	5	21425	1	#Mid	16QAM	19.72	18.72	PASS
LTE Band 7	5	21425	1	#Max	16QAM	19.72	18.72	PASS
LTE Band 7	5	21425	12	#0	16QAM	19.60	18.60	PASS



LTE Band 7	5	21425	12	#Mid	16QAM	19.62	18.62	PASS
LTE Band 7	5	21425	12	#Max	16QAM	19.06	18.06	PASS
LTE Band 7	5	21425	25	#0	16QAM	19.75	18.75	PASS
LTE Band 7	10	20800	1	#0	QPSK	21.10	20.10	PASS
LTE Band 7	10	20800	1	#Mid	QPSK	21.20	20.20	PASS
LTE Band 7	10	20800	1	#Max	QPSK	21.27	20.27	PASS
LTE Band 7	10	20800	25	#0	QPSK	20.17	19.17	PASS
LTE Band 7	10	20800	25	#Mid	QPSK	20.12	19.12	PASS
LTE Band 7	10	20800	25	#Max	QPSK	20.11	19.11	PASS
LTE Band 7	10	20800	50	#0	QPSK	20.03	19.03	PASS
LTE Band 7	10	20800	1	#0	16QAM	19.61	18.61	PASS
LTE Band 7	10	20800	1	#Mid	16QAM	19.71	18.71	PASS
LTE Band 7	10	20800	1	#Max	16QAM	19.71	18.71	PASS
LTE Band 7	10	20800	25	#0	16QAM	19.30	18.30	PASS
LTE Band 7	10	20800	25	#Mid	16QAM	19.20	18.20	PASS
LTE Band 7	10	20800	25	#Max	16QAM	19.27	18.27	PASS
LTE Band 7	10	20800	50	#0	16QAM	19.19	18.19	PASS
LTE Band 7	10	21100	1	#0	QPSK	21.00	20.00	PASS
LTE Band 7	10	21100	1	#Mid	QPSK	20.96	19.96	PASS
LTE Band 7	10	21100	1	#Max	QPSK	21.05	20.05	PASS
LTE Band 7	10	21100	25	#0	QPSK	20.07	19.07	PASS
LTE Band 7	10	21100	25	#Mid	QPSK	20.07	19.07	PASS
LTE Band 7	10	21100	25	#Max	QPSK	20.12	19.12	PASS
LTE Band 7	10	21100	50	#0	QPSK	20.11	19.11	PASS
LTE Band 7	10	21100	1	#0	16QAM	19.92	18.92	PASS
LTE Band 7	10	21100	1	#Mid	16QAM	19.91	18.91	PASS
LTE Band 7	10	21100	1	#Max	16QAM	19.91	18.91	PASS
LTE Band 7	10	21100	25	#0	16QAM	19.27	18.27	PASS
LTE Band 7	10	21100	25	#Mid	16QAM	19.29	18.29	PASS
LTE Band 7	10	21100	25	#Max	16QAM	19.81	18.81	PASS
LTE Band 7	10	21100	50	#0	16QAM	19.35	18.35	PASS
LTE Band 7	10	21400	1	#0	QPSK	21.08	20.08	PASS
LTE Band 7	10	21400	1	#Mid	QPSK	20.95	19.95	PASS
LTE Band 7	10	21400	1	#Max	QPSK	20.99	19.99	PASS
LTE Band 7	10	21400	25	#0	QPSK	19.99	18.99	PASS
LTE Band 7	10	21400	25	#Mid	QPSK	19.97	18.97	PASS
LTE Band 7	10	21400	25	#Max	QPSK	19.95	18.95	PASS
LTE Band 7	10	21400	50	#0	QPSK	20.00	19.00	PASS
LTE Band 7	10	21400	1	#0	16QAM	20.30	19.30	PASS
LTE Band 7	10	21400	1	#Mid	16QAM	20.23	19.23	PASS
LTE Band 7	10	21400	1	#Max	16QAM	20.23	19.23	PASS
LTE Band 7	10	21400	25	#0	16QAM	19.22	18.22	PASS
LTE Band 7	10	21400	25	#Mid	16QAM	19.25	18.25	PASS



LTE Band 7	10	21400	25	#Max	16QAM	19.71	18.71	PASS
LTE Band 7	10	21400	50	#0	16QAM	19.11	18.11	PASS
LTE Band 7	15	20825	1	#0	QPSK	21.09	20.09	PASS
LTE Band 7	15	20825	1	#Mid	QPSK	21.06	20.06	PASS
LTE Band 7	15	20825	1	#Max	QPSK	21.15	20.15	PASS
LTE Band 7	15	20825	36	#0	QPSK	20.07	19.07	PASS
LTE Band 7	15	20825	36	#Mid	QPSK	20.14	19.14	PASS
LTE Band 7	15	20825	36	#Max	QPSK	20.23	19.23	PASS
LTE Band 7	15	20825	75	#0	QPSK	20.04	19.04	PASS
LTE Band 7	15	20825	1	#0	16QAM	20.01	19.01	PASS
LTE Band 7	15	20825	1	#Mid	16QAM	20.13	19.13	PASS
LTE Band 7	15	20825	1	#Max	16QAM	20.07	19.07	PASS
LTE Band 7	15	20825	36	#0	16QAM	19.19	18.19	PASS
LTE Band 7	15	20825	36	#Mid	16QAM	19.20	18.20	PASS
LTE Band 7	15	20825	36	#Max	16QAM	19.23	18.23	PASS
LTE Band 7	15	20825	75	#0	16QAM	19.26	18.26	PASS
LTE Band 7	15	21100	1	#0	QPSK	21.05	20.05	PASS
LTE Band 7	15	21100	1	#Mid	QPSK	21.00	20.00	PASS
LTE Band 7	15	21100	1	#Max	QPSK	21.17	20.17	PASS
LTE Band 7	15	21100	36	#0	QPSK	20.12	19.12	PASS
LTE Band 7	15	21100	36	#Mid	QPSK	20.15	19.15	PASS
LTE Band 7	15	21100	36	#Max	QPSK	20.16	19.16	PASS
LTE Band 7	15	21100	75	#0	QPSK	20.13	19.13	PASS
LTE Band 7	15	21100	1	#0	16QAM	20.05	19.05	PASS
LTE Band 7	15	21100	1	#Mid	16QAM	19.97	18.97	PASS
LTE Band 7	15	21100	1	#Max	16QAM	20.06	19.06	PASS
LTE Band 7	15	21100	36	#0	16QAM	19.33	18.33	PASS
LTE Band 7	15	21100	36	#Mid	16QAM	19.36	18.36	PASS
LTE Band 7	15	21100	36	#Max	16QAM	19.33	18.33	PASS
LTE Band 7	15	21100	75	#0	16QAM	19.32	18.32	PASS
LTE Band 7	15	21375	1	#0	QPSK	21.00	20.00	PASS
LTE Band 7	15	21375	1	#Mid	QPSK	20.99	19.99	PASS
LTE Band 7	15	21375	1	#Max	QPSK	20.97	19.97	PASS
LTE Band 7	15	21375	36	#0	QPSK	20.06	19.06	PASS
LTE Band 7	15	21375	36	#Mid	QPSK	19.98	18.98	PASS
LTE Band 7	15	21375	36	#Max	QPSK	20.02	19.02	PASS
LTE Band 7	15	21375	75	#0	QPSK	19.94	18.94	PASS
LTE Band 7	15	21375	1	#0	16QAM	20.43	19.43	PASS
LTE Band 7	15	21375	1	#Mid	16QAM	20.39	19.39	PASS
LTE Band 7	15	21375	1	#Max	16QAM	20.38	19.38	PASS
LTE Band 7	15	21375	36	#0	16QAM	19.65	18.65	PASS
LTE Band 7	15	21375	36	#Mid	16QAM	19.66	18.66	PASS
LTE Band 7	15	21375	36	#Max	16QAM	19.78	18.78	PASS



LTE Band 7	15	21375	75	#0	16QAM	19.23	18.23	PASS
LTE Band 7	20	20850	1	#0	QPSK	20.98	19.98	PASS
LTE Band 7	20	20850	1	#Mid	QPSK	21.09	20.09	PASS
LTE Band 7	20	20850	1	#Max	QPSK	21.15	20.15	PASS
LTE Band 7	20	20850	50	#0	QPSK	20.05	19.05	PASS
LTE Band 7	20	20850	50	#Mid	QPSK	20.06	19.06	PASS
LTE Band 7	20	20850	50	#Max	QPSK	20.22	19.22	PASS
LTE Band 7	20	20850	100	#0	QPSK	20.24	19.24	PASS
LTE Band 7	20	20850	1	#0	16QAM	19.59	18.59	PASS
LTE Band 7	20	20850	1	#Mid	16QAM	19.79	18.79	PASS
LTE Band 7	20	20850	1	#Max	16QAM	19.84	18.84	PASS
LTE Band 7	20	20850	50	#0	16QAM	19.25	18.25	PASS
LTE Band 7	20	20850	50	#Mid	16QAM	19.24	18.24	PASS
LTE Band 7	20	20850	50	#Max	16QAM	19.47	18.47	PASS
LTE Band 7	20	20850	100	#0	16QAM	19.80	18.80	PASS
LTE Band 7	20	21100	1	#0	QPSK	21.42	20.42	PASS
LTE Band 7	20	21100	1	#Mid	QPSK	21.41	20.41	PASS
LTE Band 7	20	21100	1	#Max	QPSK	21.48	20.48	PASS
LTE Band 7	20	21100	50	#0	QPSK	20.11	19.11	PASS
LTE Band 7	20	21100	50	#Mid	QPSK	20.15	19.15	PASS
LTE Band 7	20	21100	50	#Max	QPSK	20.13	19.13	PASS
LTE Band 7	20	21100	100	#0	QPSK	20.12	19.12	PASS
LTE Band 7	20	21100	1	#0	16QAM	20.04	19.04	PASS
LTE Band 7	20	21100	1	#Mid	16QAM	20.10	19.10	PASS
LTE Band 7	20	21100	1	#Max	16QAM	20.06	19.06	PASS
LTE Band 7	20	21100	50	#0	16QAM	19.27	18.27	PASS
LTE Band 7	20	21100	50	#Mid	16QAM	19.27	18.27	PASS
LTE Band 7	20	21100	50	#Max	16QAM	19.27	18.27	PASS
LTE Band 7	20	21100	100	#0	16QAM	19.18	18.18	PASS
LTE Band 7	20	21350	1	#0	QPSK	21.29	20.29	PASS
LTE Band 7	20	21350	1	#Mid	QPSK	21.21	20.21	PASS
LTE Band 7	20	21350	1	#Max	QPSK	21.26	20.26	PASS
LTE Band 7	20	21350	50	#0	QPSK	20.04	19.04	PASS
LTE Band 7	20	21350	50	#Mid	QPSK	20.12	19.12	PASS
LTE Band 7	20	21350	50	#Max	QPSK	20.08	19.08	PASS
LTE Band 7	20	21350	100	#0	QPSK	20.02	19.02	PASS
LTE Band 7	20	21350	1	#0	16QAM	20.07	19.07	PASS
LTE Band 7	20	21350	1	#Mid	16QAM	19.92	18.92	PASS
LTE Band 7	20	21350	1	#Max	16QAM	19.97	18.97	PASS
LTE Band 7	20	21350	50	#0	16QAM	19.25	18.25	PASS
LTE Band 7	20	21350	50	#Mid	16QAM	19.21	18.21	PASS
LTE Band 7	20	21350	50	#Max	16QAM	19.14	18.14	PASS
LTE Band 7	20	21350	100	#0	16QAM	19.77	18.77	PASS

5.2 Occupied Bandwidth

Ambient condition

Temperature	Relative humidity	Pressure
23°C ~25°C	45%~50%	101.5kPa

Method of Measurement

The EUT was connected to Spectrum Analyzer and Base Station Simulator via power Splitter. The occupied bandwidth is measured using spectrum analyzer.

RBW is set to 100 kHz, VBW is set to 300 kHz for LTE Band 7 (5MHz).

RBW is set to 200 kHz, VBW is set to 620kHz for LTE Band7 (10MHz).

RBW is set to 300 kHz, VBW is set to 910kHz for LTE Band 7 (15MHz).

RBW is set to 430 kHz, VBW is set to 1.2MHz for LTE Band 7 (20MHz)

99% power and -26dBc occupied bandwidths are recorded. Spectrum analyzer plots are included on the following pages.

Test Setup

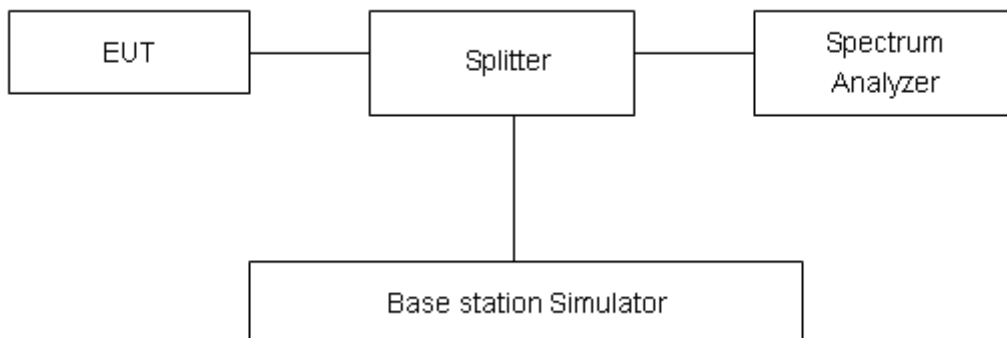

Limits

No specific occupied bandwidth requirements in part 2.1049.

Measurement Uncertainty

The assessed measurement uncertainty to ensure 95% confidence level for the normal distribution is with the coverage factor $k = 2$, $U=624\text{Hz}$.



Test Result

LTE Band 7						
RB	Modulation	Bandwidth (MHz)	Channel	Frequency (MHz)	99% Power Bandwidth(MHz)	-26dBc Bandwidth(MHz)
100%	QPSK	5	20775	2502.5	4.4952	4.896
			21100	2535	4.5155	4.957
			21425	2567.5	4.5146	4.954
		10	20800	2505	9.0378	9.949
			21100	2535	8.9858	9.859
			21400	2565	8.9805	9.865
		15	20825	2507.5	13.484	14.82
			21100	2535	13.500	14.79
			21375	2562.5	13.468	14.84
		20	20850	2510	18.011	19.51
			21100	2535	18.011	19.65
			21350	2560	17.961	19.71
	16QAM	5	20775	2502.5	4.5358	4.986
			21100	2535	4.5004	4.982
			21425	2567.5	4.5020	4.992
		10	20800	2505	8.9997	9.925
			21100	2535	8.9845	9.924
			21400	2565	8.9870	9.935
		15	20825	2507.5	13.513	14.95
			21100	2535	13.483	14.82
			21375	2562.5	13.480	14.67
		20	20850	2510	17.971	19.65
			21100	2535	18.046	19.74
			21350	2560	17.945	19.72



LTE Band 7 QPSK 5MHz CH-Low

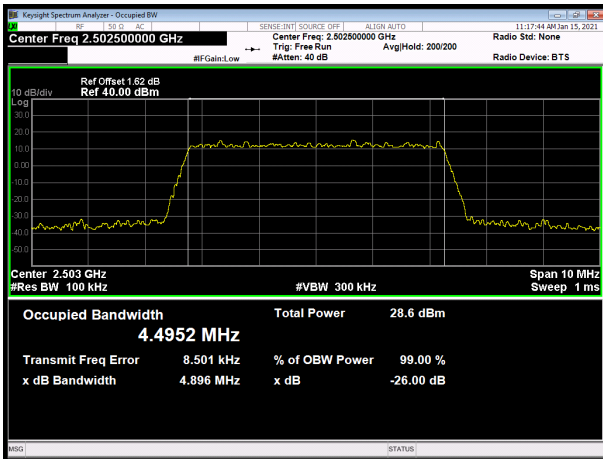

LTE Band 7 QPSK 10MHz CH-Low

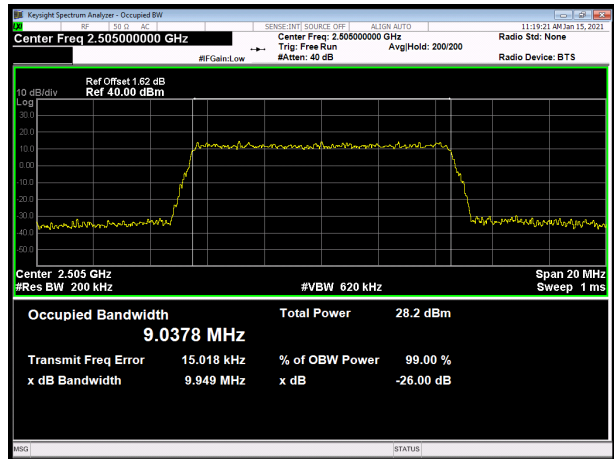

LTE Band 7 QPSK 5MHz CH-Middle

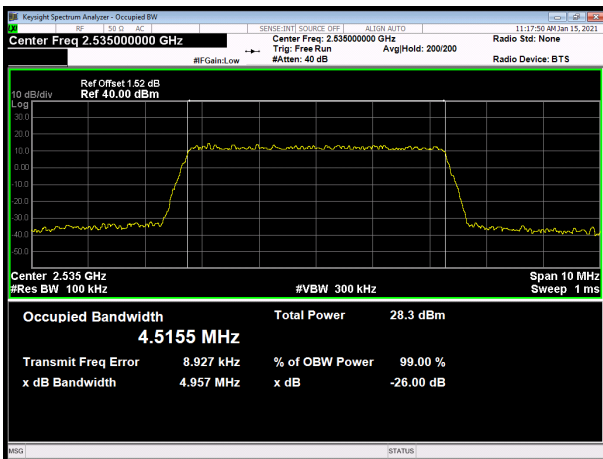

LTE Band 7 QPSK 10MHz CH-Middle

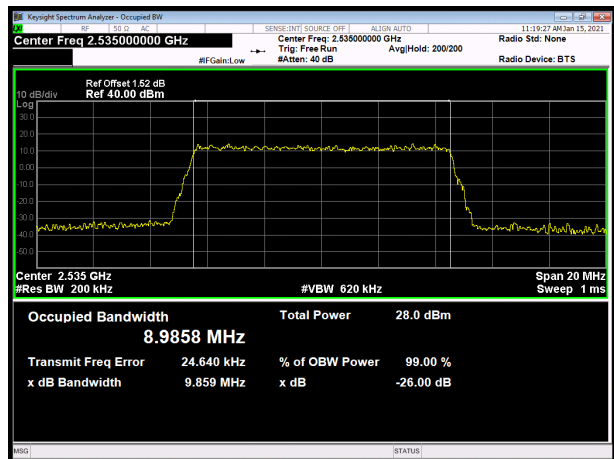

LTE Band 7 QPSK 5MHz CH-High

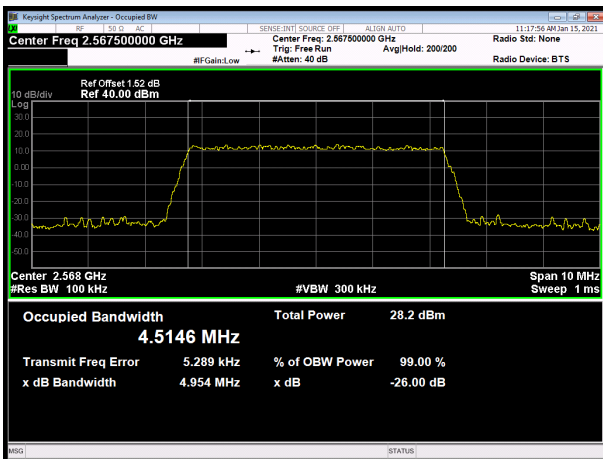

LTE Band 7 QPSK 10MHz CH-High

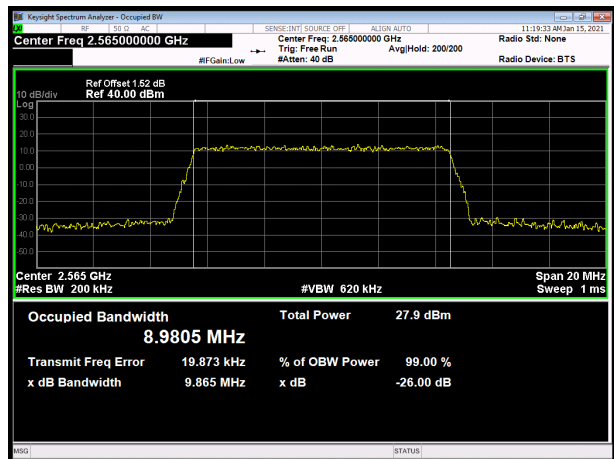



LTE Band 7 QPSK 15MHz CH-Low

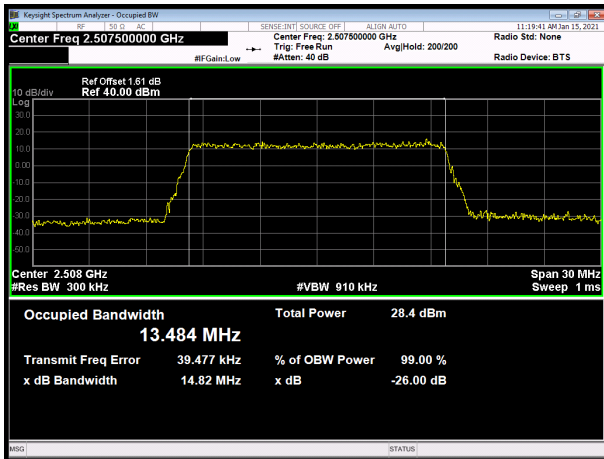

LTE Band 7 QPSK 20MHz CH-Low

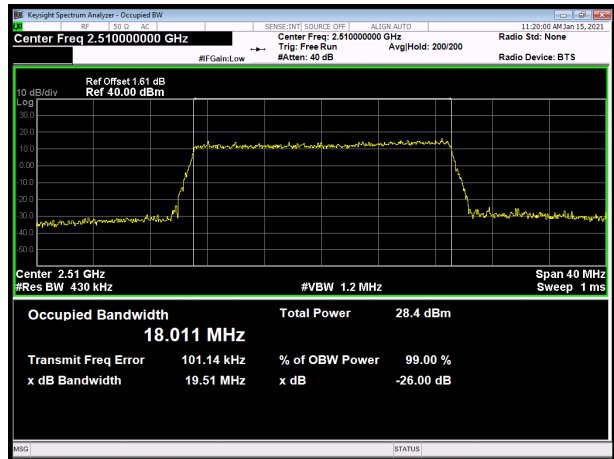

LTE Band 7 QPSK 15MHz CH-Middle

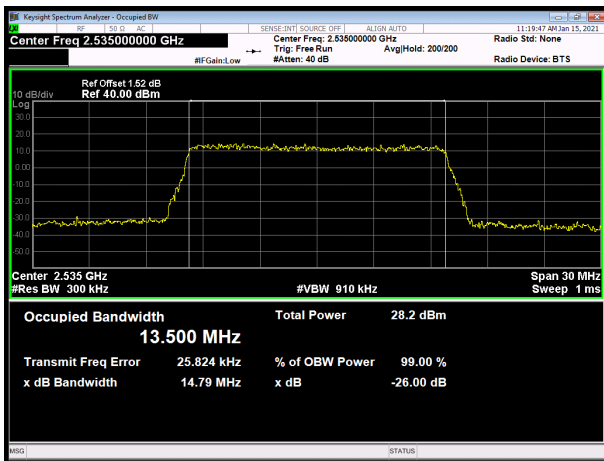

LTE Band 7 QPSK 20MHz CH-Middle

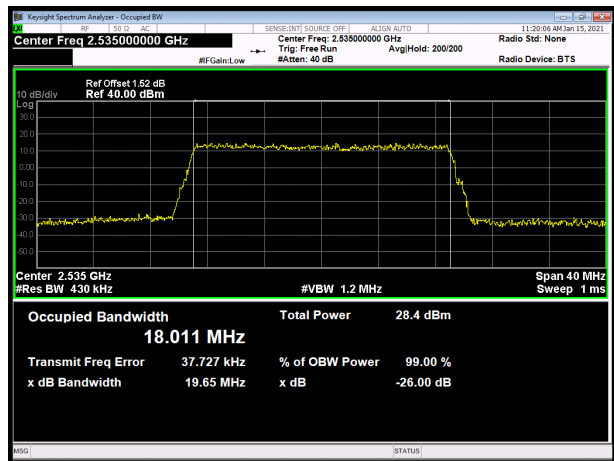

LTE Band 7 QPSK 15MHz CH-High

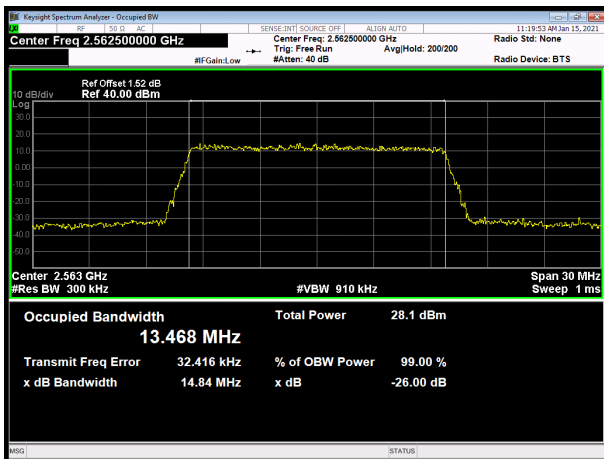

LTE Band 7 QPSK 20MHz CH-High

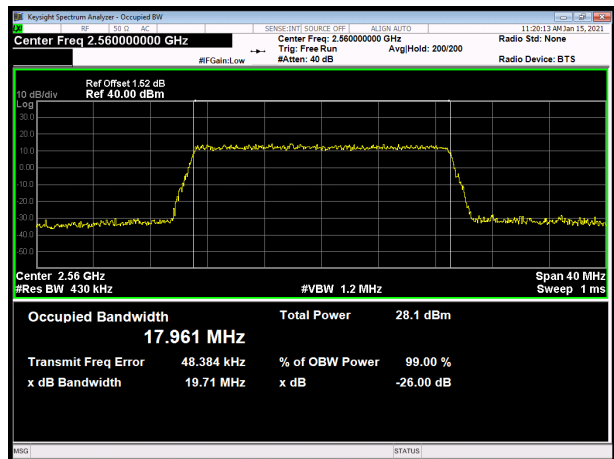



LTE Band 7 16QAM 5MHz CH-Low

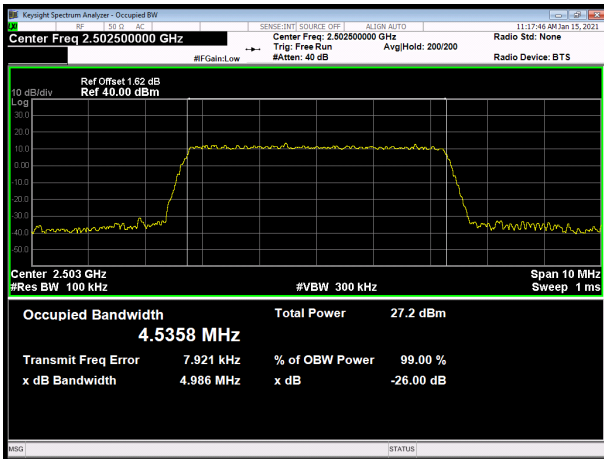

LTE Band 7 16QAM 10MHz CH-Low

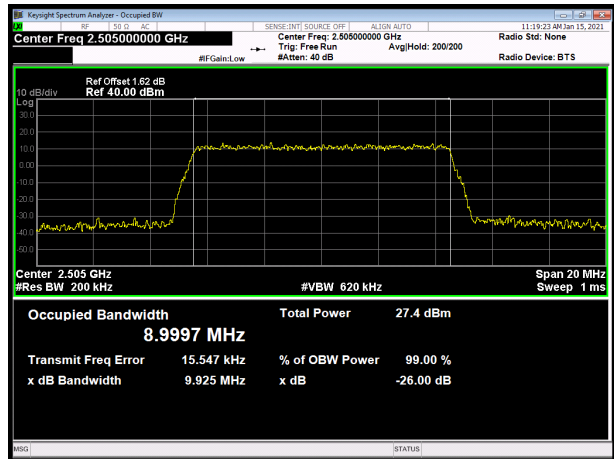

LTE Band 7 16QAM 5MHz CH-Middle

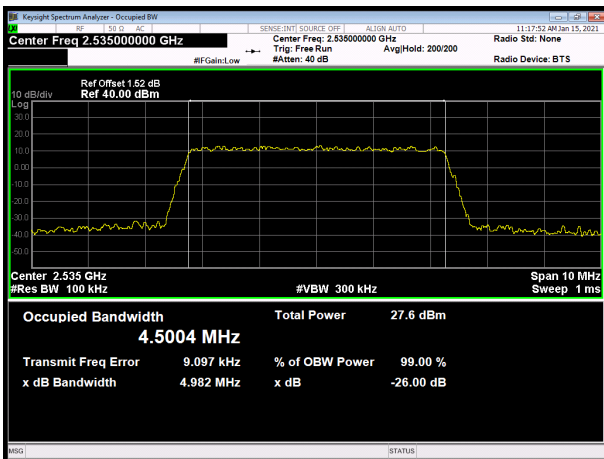

LTE Band 7 16QAM 10MHz CH-Middle

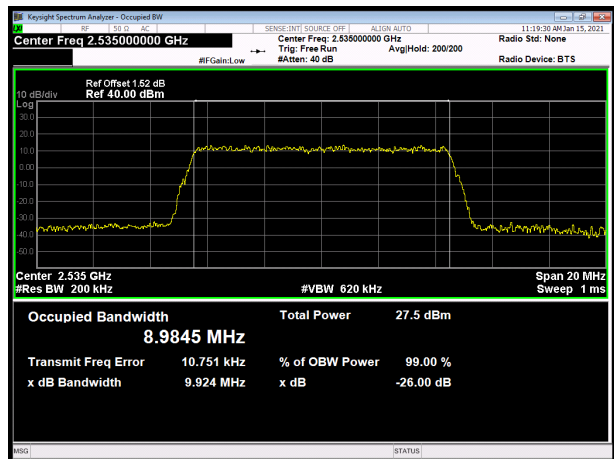

LTE Band 7 16QAM 5MHz CH-High

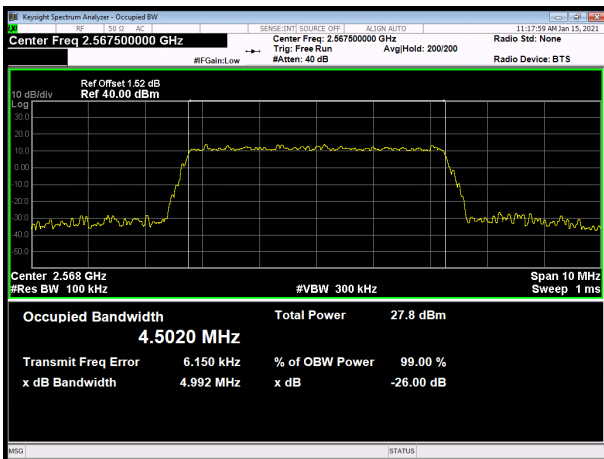

LTE Band 7 16QAM 10MHz CH-High

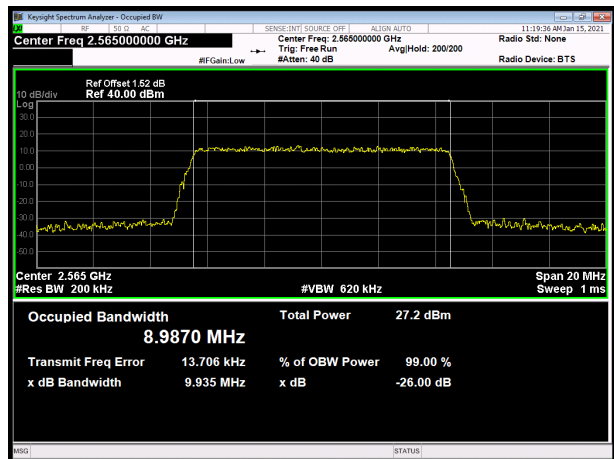



LTE Band 7 16QAM 15MHz CH-Low

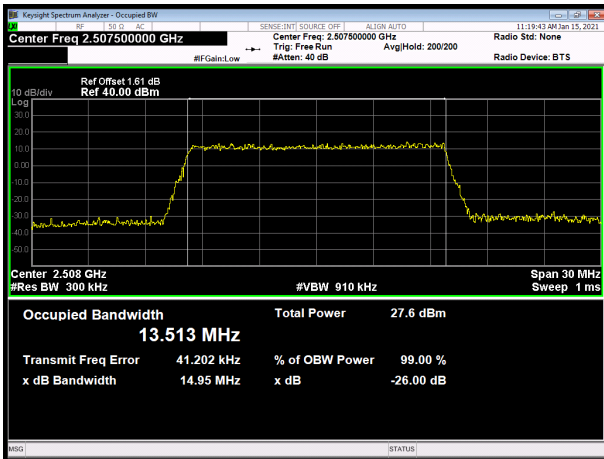

LTE Band 7 16QAM 20MHz CH-Low

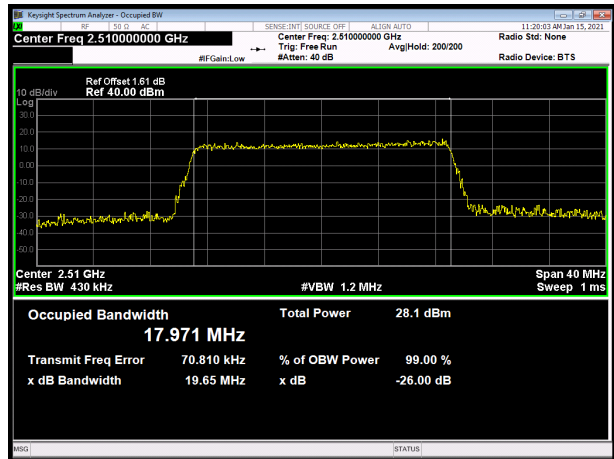

LTE Band 7 16QAM 15MHz CH-Middle

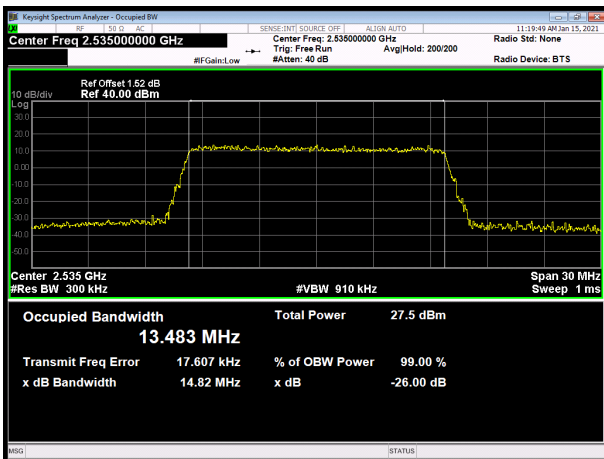

LTE Band 7 16QAM 20MHz CH-Middle

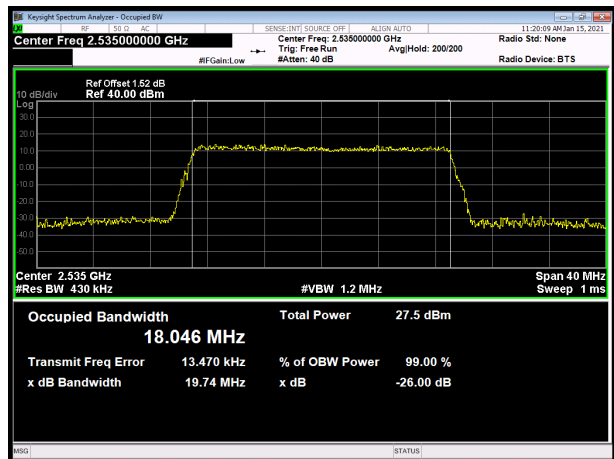

LTE Band 7 16QAM 15MHz CH-High

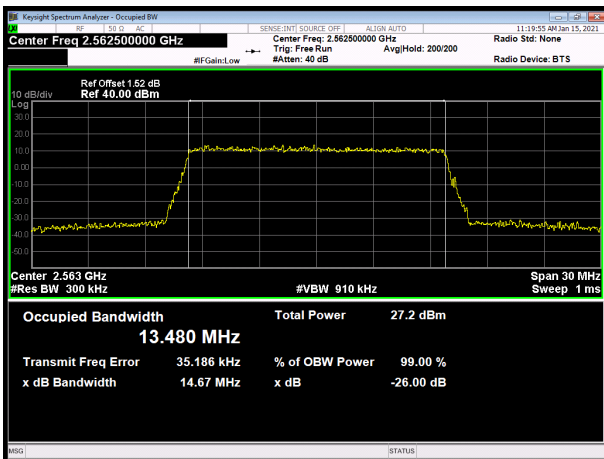

LTE Band 7 16QAM 20MHz CH-High

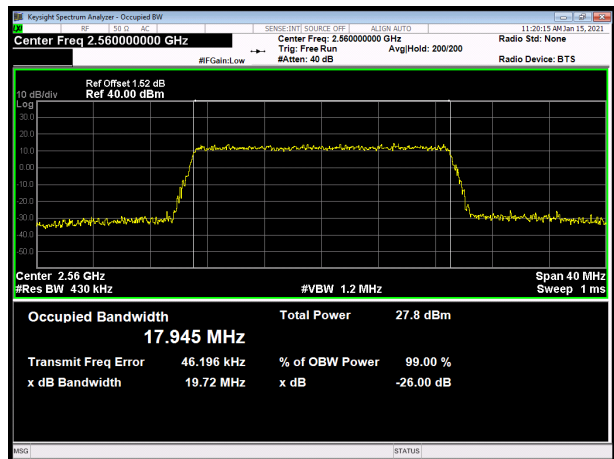

5.3 Band Edge Compliance

Ambient condition

Temperature	Relative humidity	Pressure
23°C ~25°C	45%~50%	101.5kPa

Method of Measurement

The EUT was connected to Spectrum Analyzer and Base Station Simulator via power Splitter. The band edge of the lowest and highest channels were measured.

The testing follows KDB 971168 D01 v03r01 Section 6.0

The EUT was connected to spectrum analyzer and system simulator via a power divider.

The band edges of low and high channels for the highest RF powers were measured.

Set RBW \geq 1% EBW in the 1MHz band immediately outside and adjacent to the band edge. Beyond the 1 MHz band from the band edge, RBW=1MHz was used.

on spectrum analyzer.

Set spectrum analyzer with RMS detector.

The RF fundamental frequency should be excluded against the limit line in the operating frequency band.

Checked that all the results comply with the emission limit line.

Test Setup

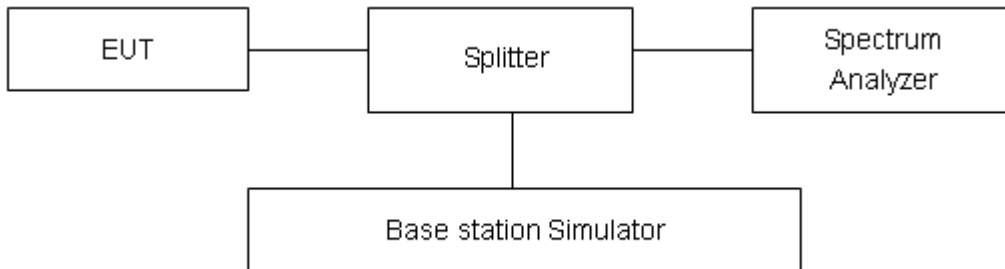

Limits

Rule Part 27.53(i) By a factor of not less than $43 + 10 \log (P)$ dB on all frequencies between 2305 and 2320 MHz.

Rule Part 27.53(m) (4) specifies that “for BRS and EBS stations. For mobile digital stations, the attenuation factor shall be not less than $40 + 10 \log (P)$ dB on all frequencies between the channel edge and 5 megahertz from the channel edge, $43 + 10 \log (P)$ dB on all frequencies between 5 megahertz and X megahertz from the channel edge, and $55 + 10 \log (P)$ dB on all frequencies more than X megahertz from the channel edge, where X is the greater of 6 megahertz or the actual emission bandwidth as defined in paragraph (m)(4) of this section. In addition, the attenuation factor shall not be less that $43 + 10 \log (P)$ dB on all frequencies between 2490.5 MHz and 2496 MHz and



55 + 10 log (P) dB at or below 2490.5 MHz. Mobile Satellite Service licensees operating on frequencies below 2495 MHz may also submit a documented interference complaint against BRS licensees operating on channel BRS Channel 1 on the same terms and conditions as adjacent channel BRS or EBS licensees.

Example:

The limit line is derived from 43 + 10log (P) dB below the transmitter power P(Watts)

$$= P(W) - [43 + 10\log(P)] \text{ (dB)}$$

$$= [30 + 10\log (P)] \text{ (dBm)} - [43 + 10\log(P)] \text{ (dB)} = -13\text{dBm}.$$

Measurement Uncertainty

The assessed measurement uncertainty to ensure 95% confidence level for the normal distribution is with the coverage factor $k = 1.96$, $U=0.684\text{dB}$.



Test Result

All the test traces in the plots shows the test results clearly.

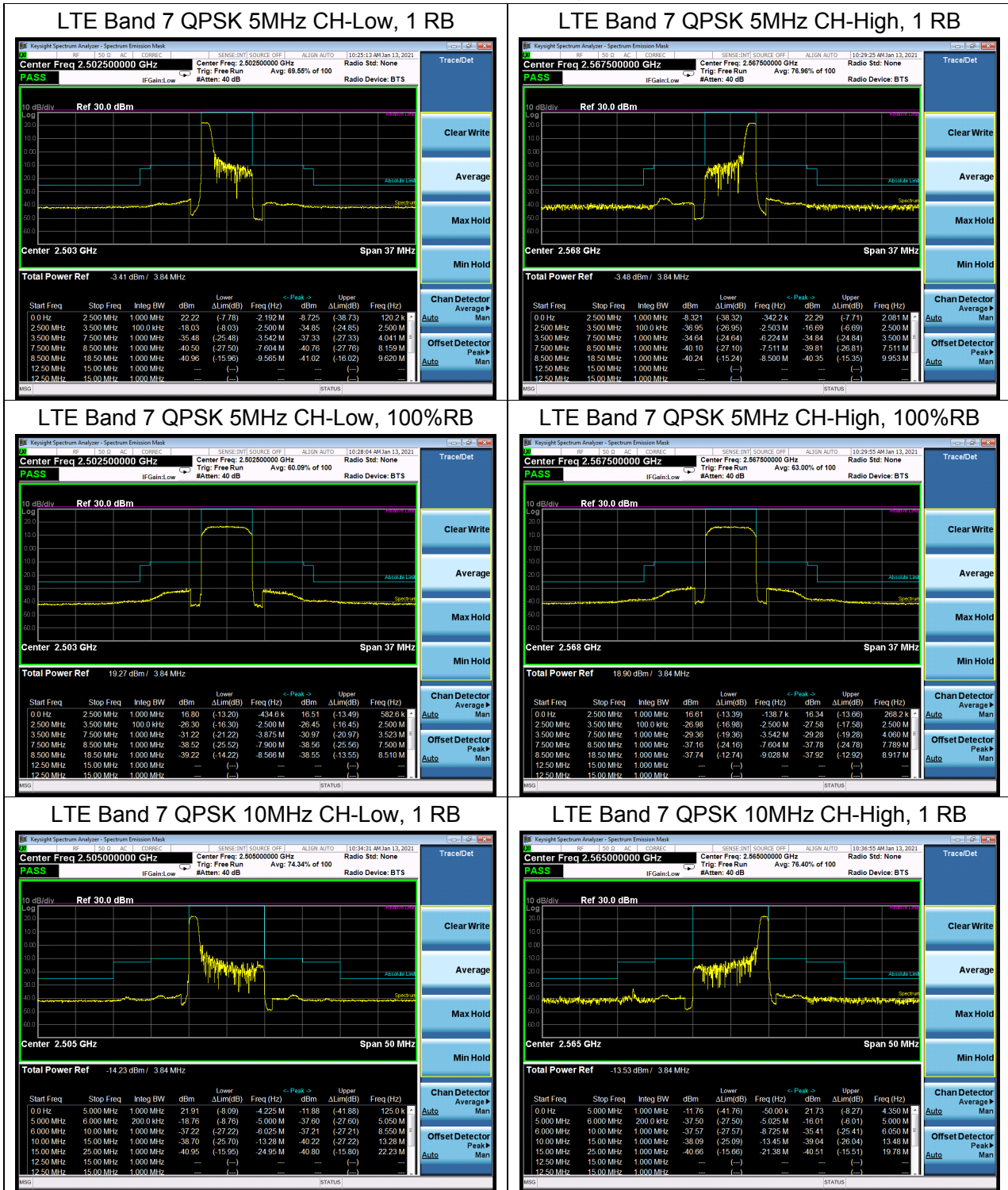



LTE Band 7 QPSK 10MHz CH-Low, 100%RB

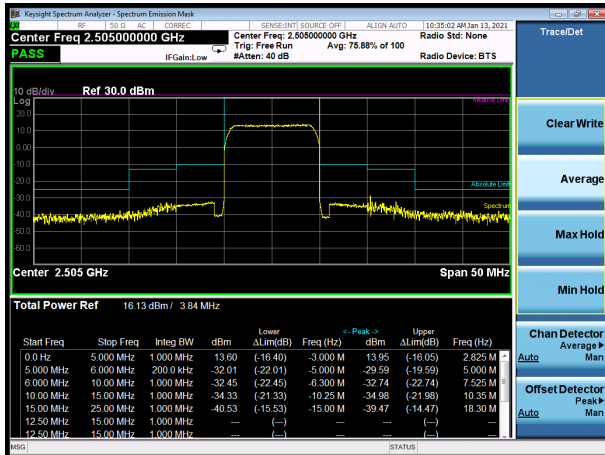

LTE Band 7 QPSK 10MHz CH-High, 100%RB

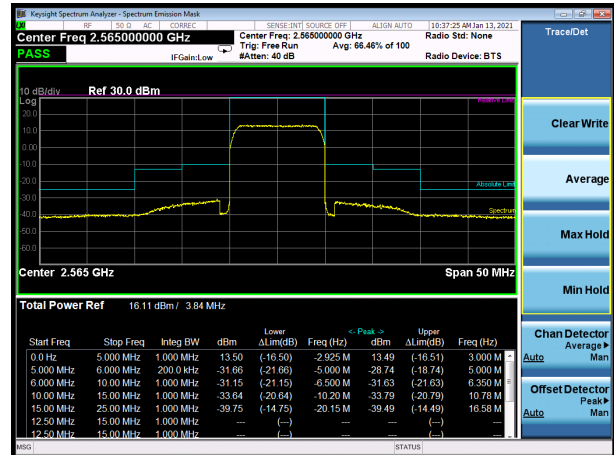

LTE Band 7 QPSK 15MHz CH-Low, 1 RB

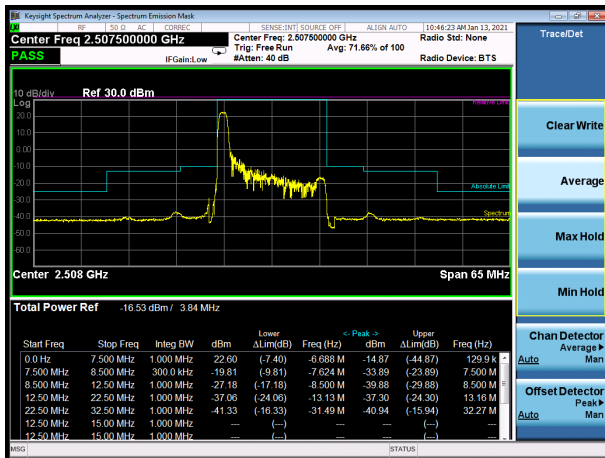

LTE Band 7 QPSK 15MHz CH-High, 1 RB

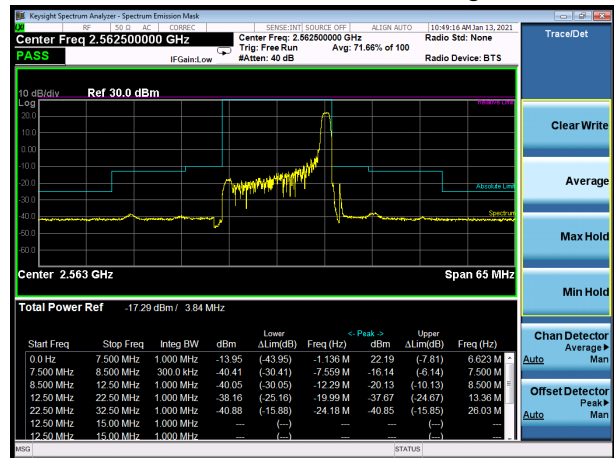

LTE Band 7 QPSK 15MHz CH-Low, 100%RB

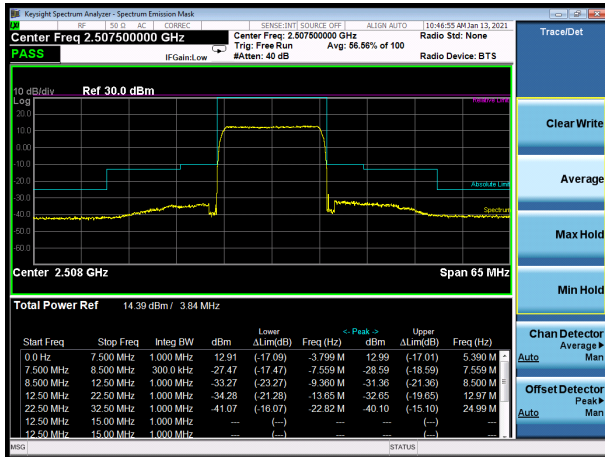

LTE Band 7 QPSK 15MHz CH-High, 100%RB

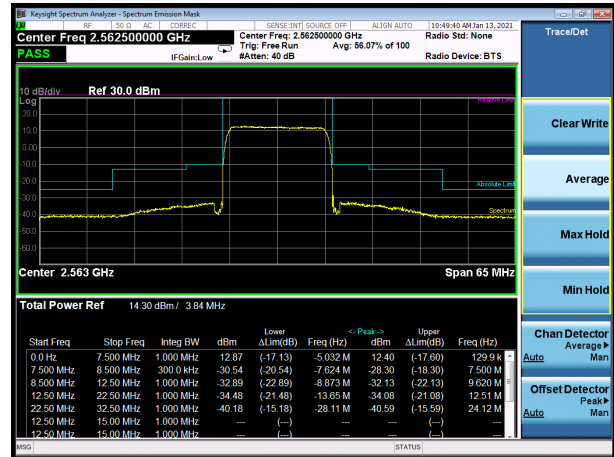



LTE Band 7 QPSK 20MHz CH-Low, 1 RB

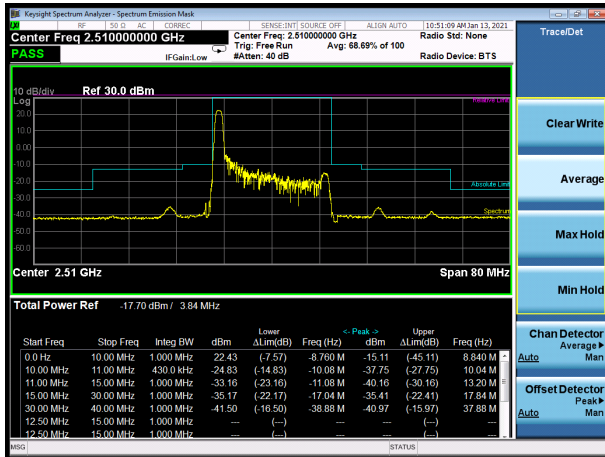

LTE Band 7 QPSK 20MHz CH-High, 1 RB

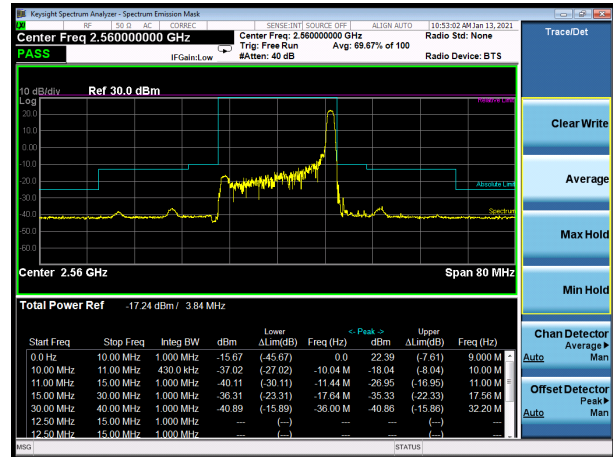

LTE Band 7 QPSK 20MHz CH-Low, 100%RB

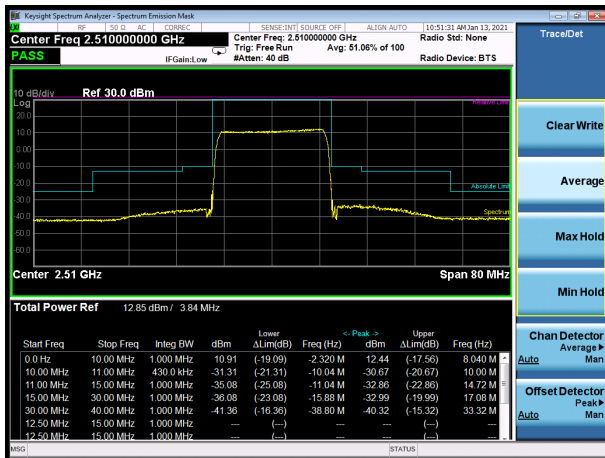

LTE Band 7 QPSK 20MHz CH-High, 100%RB

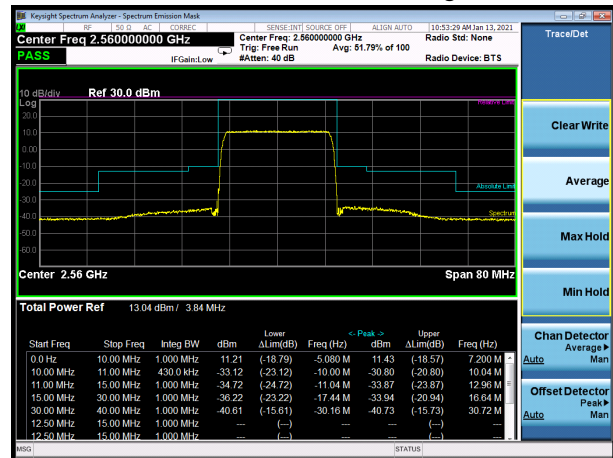

LTE Band 7 16QAM 5MHz CH-Low, 1 RB

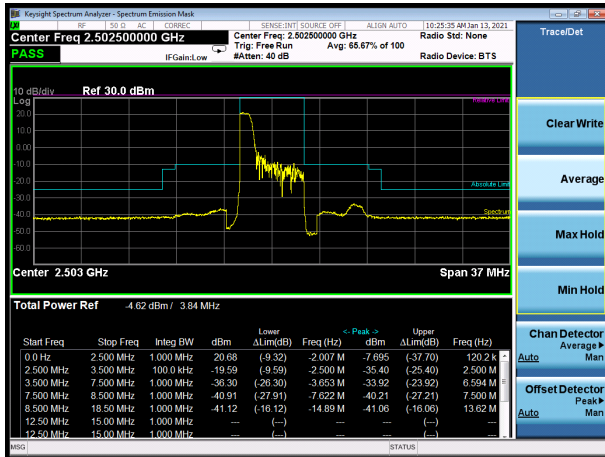

LTE Band 7 16QAM 5MHz CH-High, 1 RB

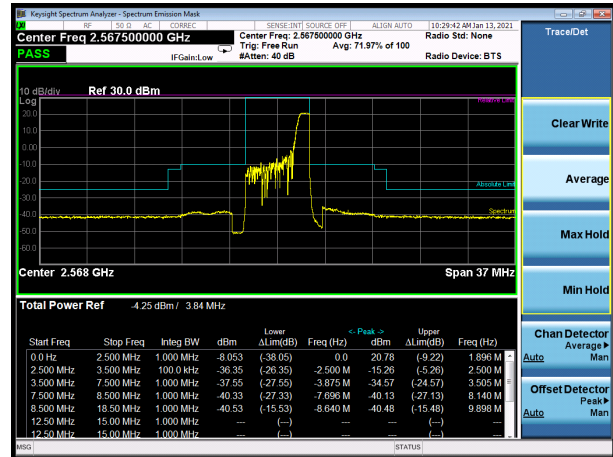



LTE Band 7 16QAM 5MHz CH-Low, 100%RB

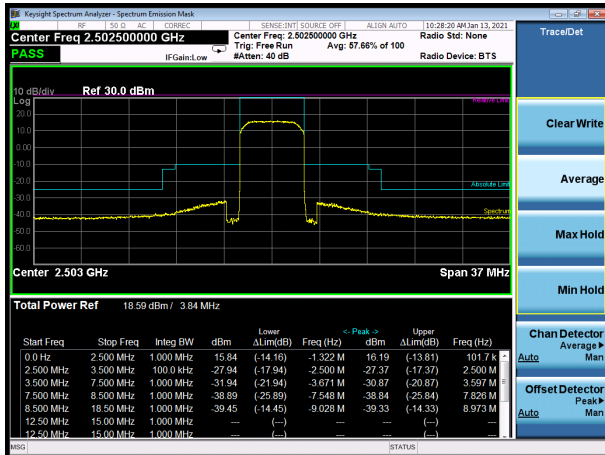

LTE Band 7 16QAM 5MHz CH-High, 100%RB

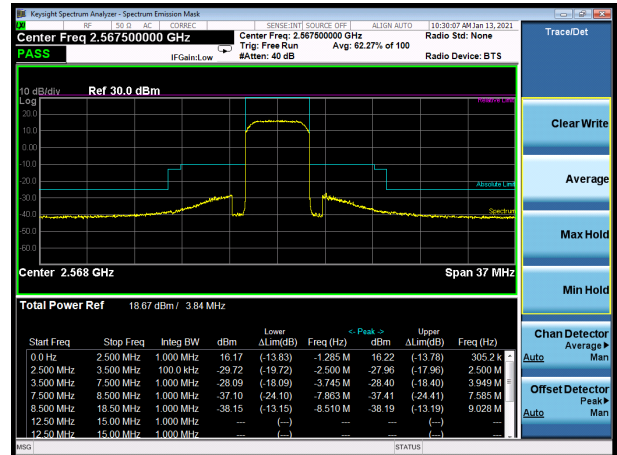

LTE Band 7 16QAM 10MHz CH-Low, 1 RB

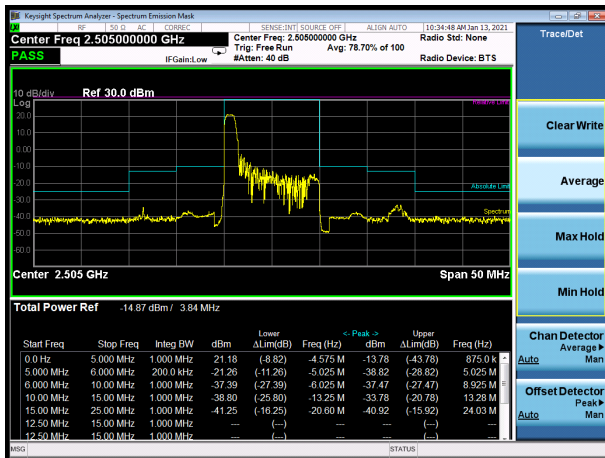

LTE Band 7 16QAM 10MHz CH-High, 1 RB

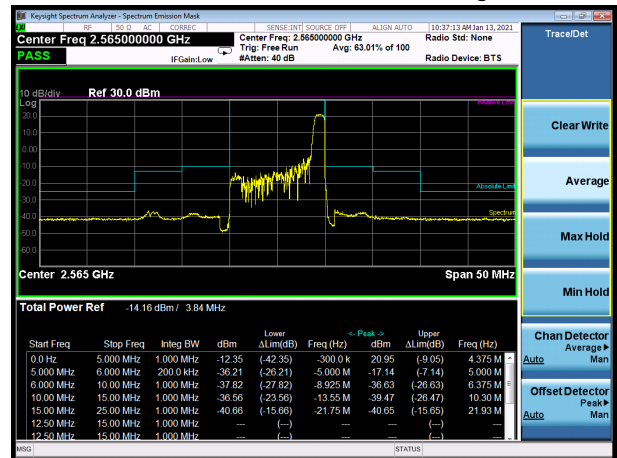

LTE Band 7 16QAM 10MHz CH-Low, 100%RB

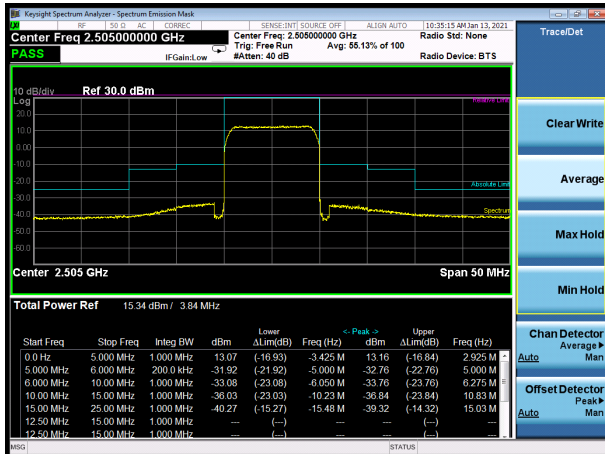

LTE Band 7 16QAM 10MHz CH-High, 100%RB

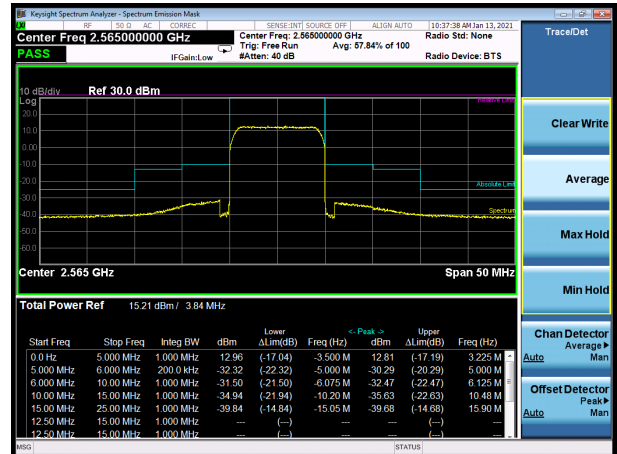



LTE Band 7 16QAM 15MHz CH-Low, 1 RB

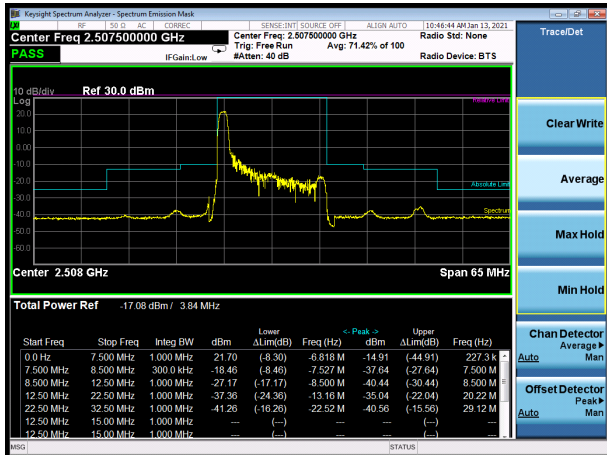

LTE Band 7 16QAM 15MHz CH-High, 1 RB

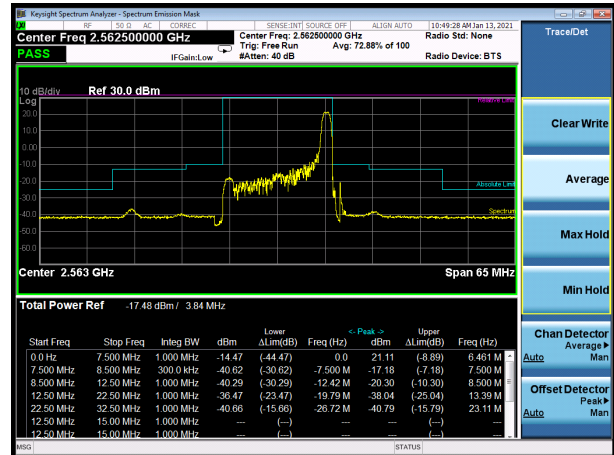

LTE Band 7 16QAM 15MHz CH-Low, 100%RB

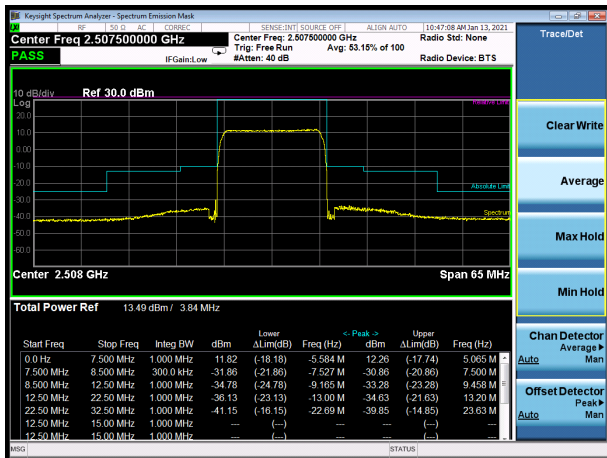

LTE Band 7 16QAM 15MHz CH-High, 100%RB

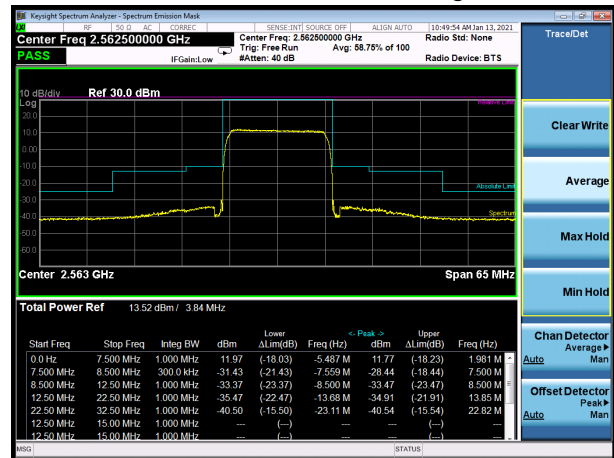

LTE Band 7 16QAM 20MHz CH-Low, 1 RB

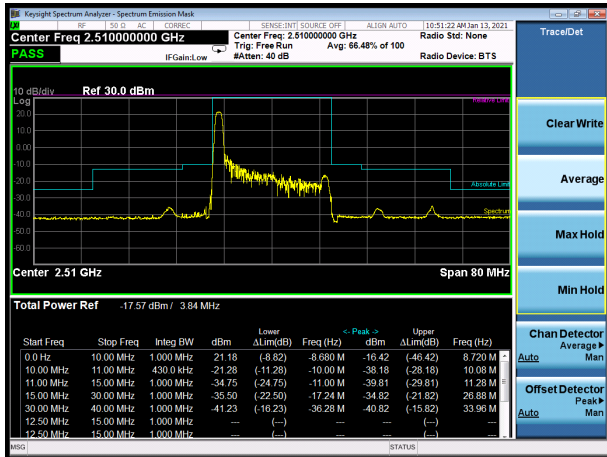

LTE Band 7 16QAM 20MHz CH-High, 1 RB

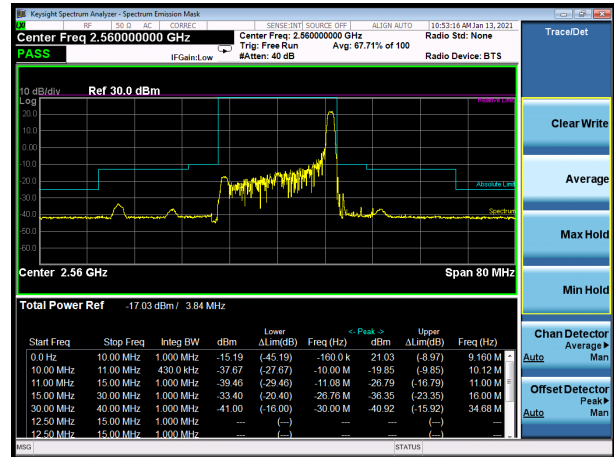

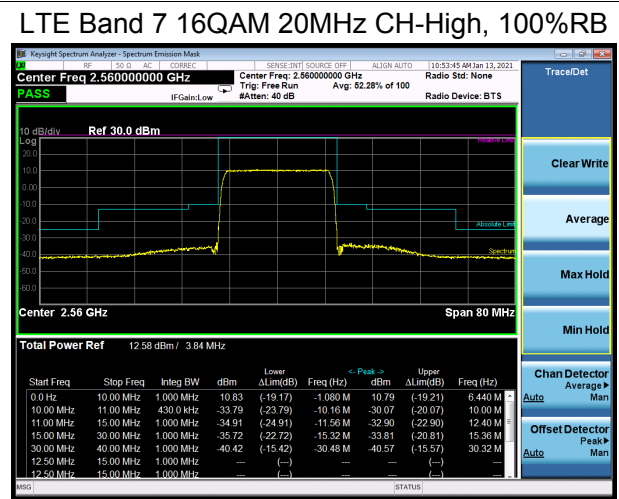
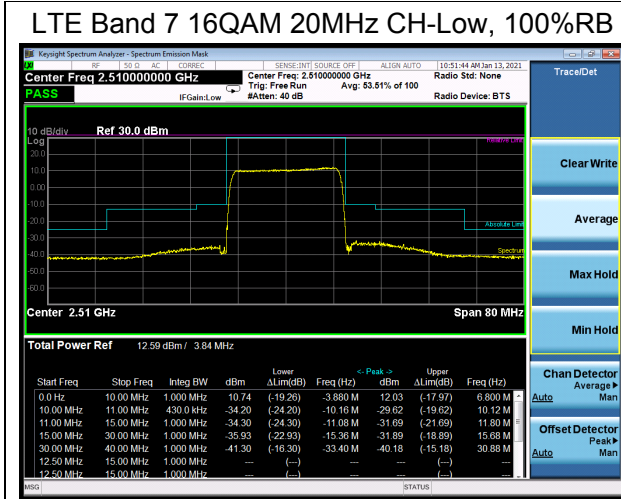

5.4 Peak-to-Average Power Ratio (PAPR)

Ambient condition

Temperature	Relative humidity	Pressure
23°C ~25°C	45%~50%	101.5kPa

Methods of Measurement

Measure the total peak power and record as PPK. And measure the total average power and record as PAvg. Both the peak and average power levels must be expressed in the same logarithmic units (e.g., dBm). Determine the PAPR from:

$$PAPR (dB) = PPK (dBm) - PAvg (dBm).$$

Test Setup

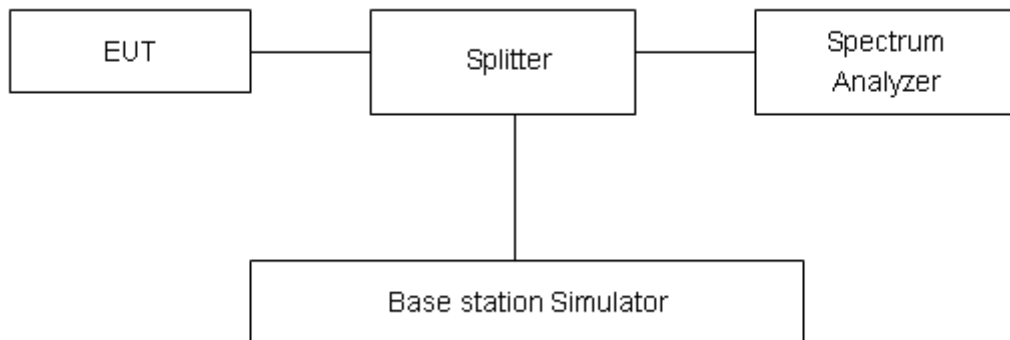

Limits

Rule Part 27.50(d)(5) Equipment employed must be authorized in accordance with the provisions of 24.51. Power measurements for transmissions by stations authorized under this section may be made either in accordance with a Commission-approved average power technique or in compliance with paragraph (d)(6) of this section. In measuring transmissions in this band using an average power technique, the peak-to-average ratio (PAR) of the transmission may not exceed 13 dB.

Measurement Uncertainty

The assessed measurement uncertainty to ensure 95% confidence level for the normal distribution is with the coverage factor $k = 2$, $U = 0.4$ dB.



Test Results

LTE Band 7								
Modulation	Bandwidth (MHz)	Channel	Frequency (MHz)	Peak (dBm)	Avg (dBm)	PAPR (dB)	Limit (dB)	Conclusion
QPSK	5	20775	2502.5	25.87	20.31	5.56	≤13	PASS
		21100	2535	25.89	20.25	5.64	≤13	PASS
		21425	2567.5	25.68	20.13	5.55	≤13	PASS
	10	20800	2505	25.92	20.27	5.65	≤13	PASS
		21100	2535	26.03	20.33	5.70	≤13	PASS
		21400	2565	25.76	20.23	5.53	≤13	PASS
	15	20825	2507.5	26.41	20.39	6.02	≤13	PASS
		21100	2535	26.27	20.26	6.01	≤13	PASS
		21375	2562.5	26.00	20.16	5.84	≤13	PASS
	20	20850	2510	26.19	20.45	5.74	≤13	PASS
		21100	2535	26.16	20.33	5.83	≤13	PASS
		21350	2560	25.79	20.12	5.67	≤13	PASS
16QAM	5	20775	2502.5	25.70	19.34	6.36	≤13	PASS
		21100	2535	25.89	19.56	6.33	≤13	PASS
		21425	2567.5	25.96	19.80	6.16	≤13	PASS
	10	20800	2505	25.86	19.47	6.39	≤13	PASS
		21100	2535	25.71	19.37	6.34	≤13	PASS
		21400	2565	25.56	19.24	6.32	≤13	PASS
	15	20825	2507.5	25.96	19.54	6.42	≤13	PASS
		21100	2535	25.84	19.40	6.44	≤13	PASS
		21375	2562.5	25.56	19.27	6.29	≤13	PASS
	20	20850	2510	26.43	20.07	6.36	≤13	PASS
		21100	2535	25.94	19.48	6.46	≤13	PASS
		21350	2560	26.16	19.88	6.28	≤13	PASS

5.5 Frequency Stability

Ambient condition

Temperature	Relative humidity	Pressure
23°C ~25°C	45%~50%	101.5kPa

Method of Measurement

Frequency Stability (Temperature Variation)

The temperature inside the climate chamber is varied from -30°C to +55°C in 10°C step size.

(1) With all power removed, the temperature was decreased to -10°C and permitted to stabilize for three hours.

(2) Measure the carrier frequency with the test equipment in a “call mode”. These measurements should be made within 1 minute of powering up the mobile station, to prevent significant self warming.

(3) Repeat the above measurements at 10°C increments from -30°C to +55°C. Allow at least 1.5 hours at each temperature, un-powered, before making measurements.

Frequency Stability (Voltage Variation)

The frequency stability shall be measured with variation of primary supply voltage as follows:

Primary Supply Voltage: The primary supply voltage is varied from 85% to 115% of the nominal value for non hand-carried battery and AC powered equipment. For hand-carried, battery-powered equipment, primary supply voltage is reduced to the battery operating end point which shall be specified by the manufacturer.

This transceiver is specified to operate with an input voltage of between 3.23 V and 4.37 V, with a nominal voltage of 3.8V.

Test setup

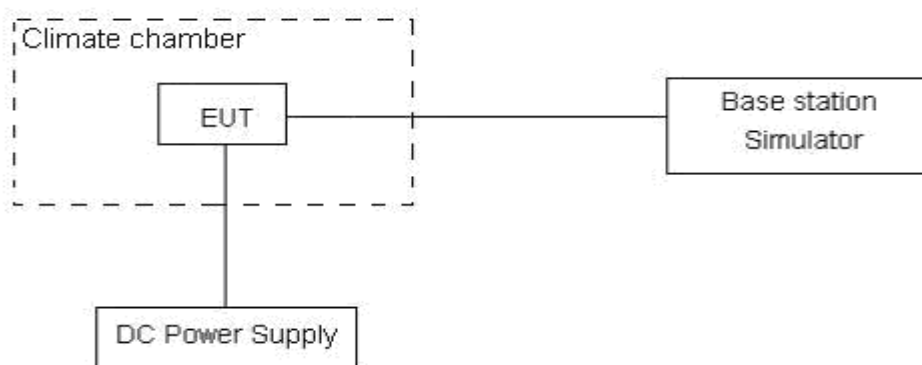

Limits

The frequency stability shall be sufficient to ensure that the fundamental emissions stay within the authorized bands of operation.

Measurement Uncertainty

The assessed measurement uncertainty to ensure 99.75% confidence level for the normal distribution is with the coverage factor $k = 3, U = 0.01\text{ppm}$.



Test Result

LTE Band 7						
Condition		Freq.Error (Hz)	Freq.Error (Hz)	Frequency Stability (ppm)	Frequency Stability (ppm)	Verdict
BANDWIDTH	5MHz	16QAM	QPSK	16QAM	QPSK	
Temperature	Voltage					
Normal (25°C)	Normal	2.26	15.40	0.00120	0.00819	PASS
Extreme (55°C)		5.31	4.35	0.00282	0.00231	PASS
Extreme (50°C)		6.70	9.80	0.00357	0.00521	PASS
Extreme (40°C)		7.82	10.03	0.00416	0.00534	PASS
Extreme (30°C)		17.93	16.17	0.00954	0.00860	PASS
Extreme (20°C)		13.37	8.46	0.00711	0.00450	PASS
Extreme (10°C)		2.53	13.40	0.00134	0.00713	PASS
Extreme (0°C)		1.72	8.47	0.00091	0.00451	PASS
Extreme (-10°C)		3.27	11.04	0.00174	0.00587	PASS
Extreme (-20°C)		7.63	5.69	0.00406	0.00302	PASS
Extreme (-30°C)		5.64	5.81	0.00300	0.00309	PASS
25°C		LV	10.91	14.98	0.00580	0.00797
	HV	16.68	16.50	0.00887	0.00878	PASS
Condition		Freq.Error (Hz)	Freq.Error (Hz)	Frequency Stability (ppm)	Frequency Stability (ppm)	Verdict
BANDWIDTH	10MHz	16QAM	QPSK	16QAM	QPSK	
Temperature	Voltage					
Normal (25°C)	Normal	1.60	11.26	0.00085	0.00599	PASS
Extreme (55°C)		14.31	4.60	0.00761	0.00245	PASS
Extreme (50°C)		4.86	10.04	0.00258	0.00534	PASS
Extreme (40°C)		2.17	2.03	0.00115	0.00108	PASS
Extreme (30°C)		2.77	2.25	0.00147	0.00120	PASS
Extreme (20°C)		17.65	15.66	0.00939	0.00833	PASS
Extreme (10°C)		6.22	16.55	0.00331	0.00880	PASS
Extreme (0°C)		1.82	14.15	0.00097	0.00753	PASS
Extreme (-10°C)		11.23	17.44	0.00597	0.00928	PASS
Extreme (-20°C)		11.76	10.11	0.00626	0.00538	PASS
Extreme (-30°C)		2.22	15.44	0.00118	0.00821	PASS
25°C		LV	4.60	9.35	0.00245	0.00497
	HV	7.60	15.00	0.00404	0.00798	PASS
Condition		Freq.Error (Hz)	Freq.Error (Hz)	Frequency Stability (ppm)	Frequency Stability (ppm)	Verdict
BANDWIDTH	15MHz					



Temperature	Voltage	16QAM	QPSK	16QAM	QPSK	
Normal (25°C)	Normal	8.91	12.15	0.00474	0.00646	PASS
Extreme (55°C)		10.69	9.32	0.00568	0.00496	PASS
Extreme (50°C)		11.19	5.27	0.00595	0.00281	PASS
Extreme (40°C)		16.74	16.26	0.00890	0.00865	PASS
Extreme (30°C)		15.22	5.43	0.00810	0.00289	PASS
Extreme (20°C)		6.12	14.17	0.00325	0.00753	PASS
Extreme (10°C)		16.52	9.37	0.00879	0.00498	PASS
Extreme (0°C)		13.37	6.10	0.00711	0.00325	PASS
Extreme (-10°C)		5.57	6.88	0.00297	0.00366	PASS
Extreme (-20°C)		9.42	4.19	0.00501	0.00223	PASS
Extreme (-30°C)		17.31	2.43	0.00921	0.00129	PASS
25°C		LV	6.47	16.46	0.00344	0.00875
	HV	9.87	4.58	0.00525	0.00244	PASS
Condition		Freq.Error (Hz)	Freq.Error (Hz)	Frequency Stability (ppm)	Frequency Stability (ppm)	Verdict
BANDWIDTH	20MHz					
Temperature	Voltage	16QAM	QPSK	16QAM	QPSK	
Normal (25°C)	Normal	1.56	8.98	0.00083	0.00478	PASS
Extreme (55°C)		12.62	16.07	0.00671	0.00855	PASS
Extreme (50°C)		16.11	5.87	0.00857	0.00312	PASS
Extreme (40°C)		3.27	15.73	0.00174	0.00837	PASS
Extreme (30°C)		6.36	3.48	0.00338	0.00185	PASS
Extreme (20°C)		6.04	5.63	0.00321	0.00299	PASS
Extreme (10°C)		10.98	16.66	0.00584	0.00886	PASS
Extreme (0°C)		13.99	16.32	0.00744	0.00868	PASS
Extreme (-10°C)		8.99	9.81	0.00478	0.00522	PASS
Extreme (-20°C)		8.24	6.01	0.00438	0.00320	PASS
Extreme (-30°C)		6.64	4.69	0.00353	0.00250	PASS
25°C		LV	13.23	6.00	0.00704	0.00319
	HV	6.78	2.82	0.00361	0.00150	PASS

5.6 Spurious Emissions at Antenna Terminals

Ambient condition

Temperature	Relative humidity	Pressure
23°C ~25°C	45%~50%	101.5kPa

Method of Measurement

The EUT was connected to Spectrum Analyzer and Base Station Simulator via power Splitter. The measurement is carried out using a spectrum analyzer. The spectrum analyzer scans from 9kHz to the 10th harmonic of the carrier. The peak detector is used.

RBW is set to 1 kHz (0.009MHz~ 0.15 MHz),

RBW is set to 10 kHz (0.15 MHz~ 30 MHz)

RBW is set to 100 kHz (30MHz~1000 MHz)

RBW is set to 1000 kHz (above 1000MHz)

Sweep is set to ATUO.

Of those disturbances below (limit – 20 dB), the mark is not required for the EUT.

The modulation mode and RB allocation refer to section 5.1, using the maximum output power configuration.

Test setup

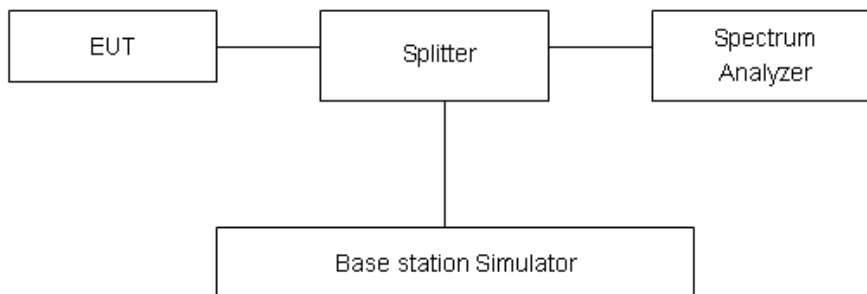

Limits

Rule Part 27.53(m) $55 + 10 \log (P)$ dB on all frequencies more than X megahertz from the channel edge, where X is the greater of 6 megahertz or the actual emission bandwidth as defined in paragraph (m)(4) of this section.

Part 27.53(m) Limit	-25 dBm
---------------------	---------



Measurement Uncertainty

The assessed measurement uncertainty to ensure 99.75% confidence level for the normal distribution is with the coverage factor $k = 1.96$.

Frequency	Uncertainty
9kHz-1GHz	0.684 dB
1GHz-27GHz	1.407 dB

Test Result

Sweep the whole frequency band through the range from 9kHz to the 10th harmonic of the carrier, the emissions more than 20 dB below the limit are not reported.

The signal beyond the limit is carrier.

LTE Band 7 5MHz CH- Low 9kHz~26.5GHz

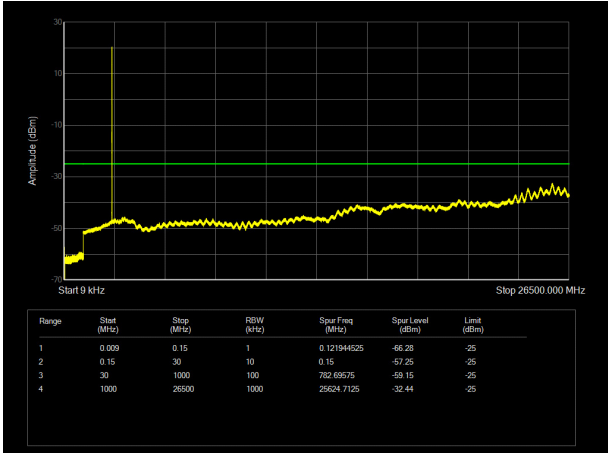

LTE Band 7 10MHz CH-Low 9kHz~26.5GHz

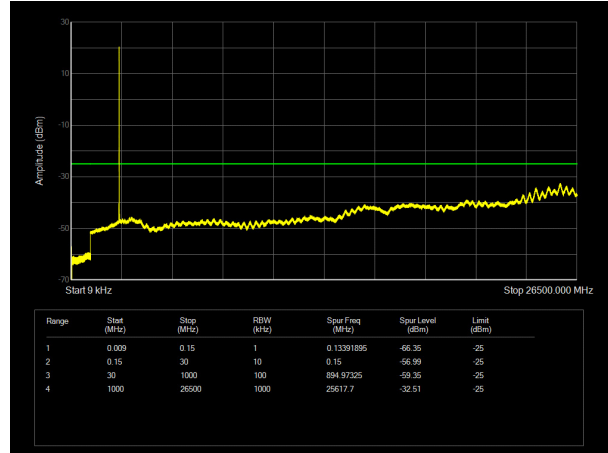

LTE Band 7 5MHz CH- Middle 9kHz~26.5GHz

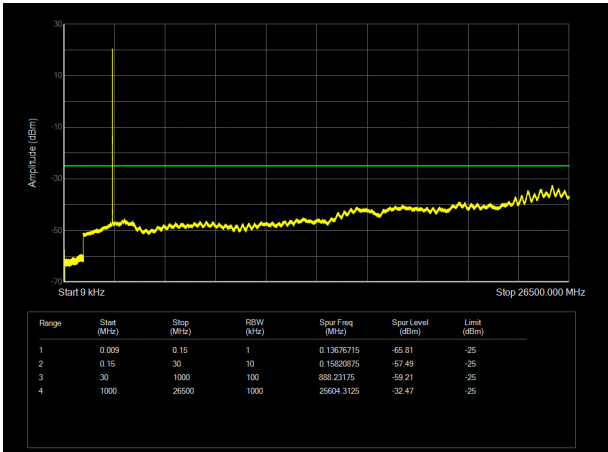

LTE Band 7 10MHz CH- Middle 9kHz~26.5GHz

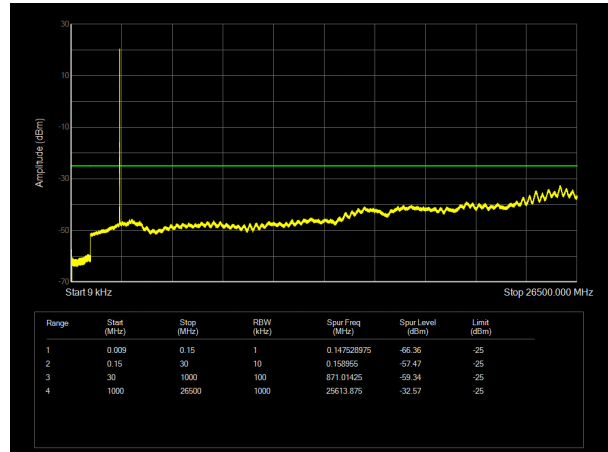

LTE Band 7 5MHz CH-High 9kHz~26.5GHz

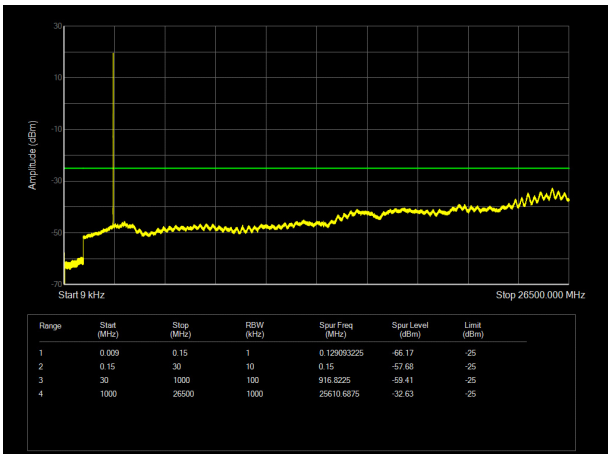

LTE Band 7 10MHz CH- High 9kHz~26.5GHz

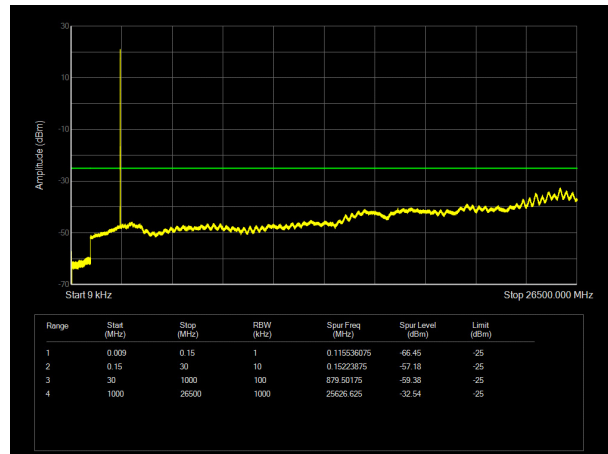



LTE Band 7 15MHz CH- Low 9kHz~26.5GHz

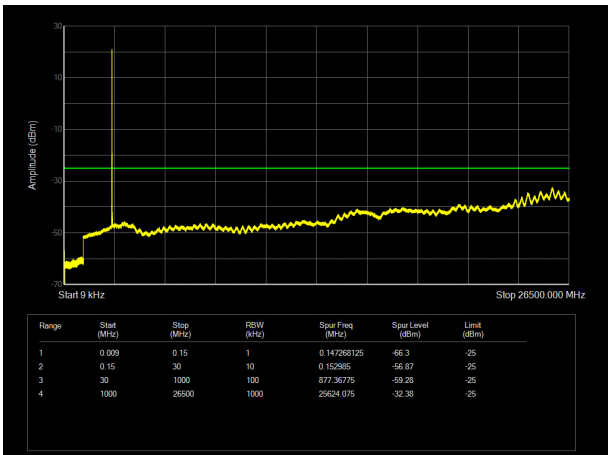

LTE Band 7 20MHz CH-Low 9kHz~26.5GHz

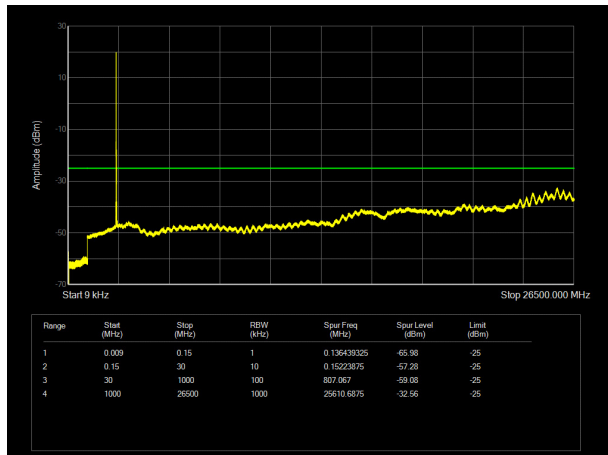

LTE Band 7 15MHz CH- Middle 9kHz~26.5GHz

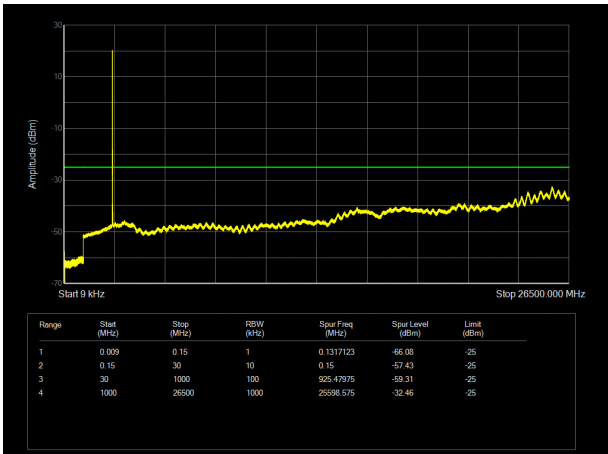

LTE Band 7 20MHz CH- Middle 9kHz~26.5GHz

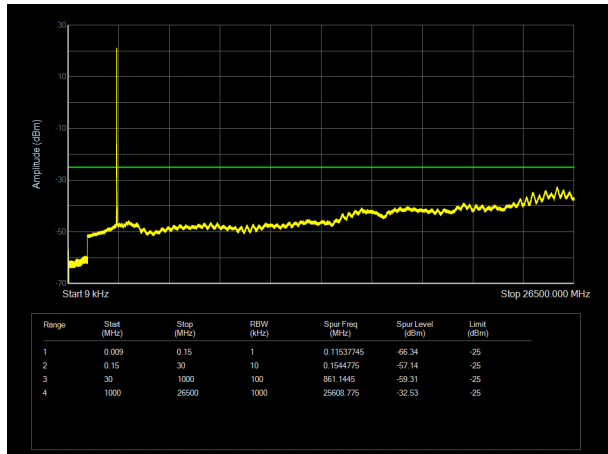

LTE Band 7 15MHz CH-High 9kHz~26.5GHz

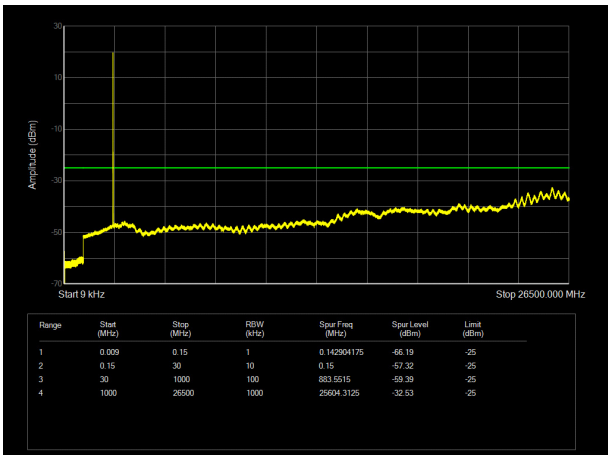

LTE Band 7 20MHz CH- High 9kHz~26.5GHz

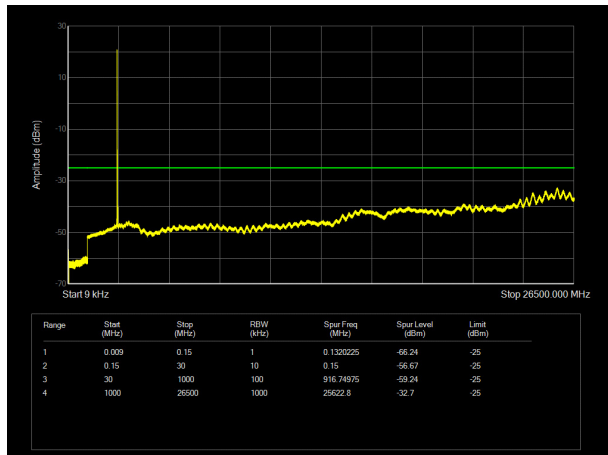

5.7 Radiates Spurious Emission

Ambient condition

Temperature	Relative humidity	Pressure
23°C ~25°C	45%~50%	101.5kPa

Method of Measurement

1. The testing follows FCC KDB 971168 D01 v03r01 Section 5.8 and ANSI C63.26 (2015).
2. Below 1GHz: The EUT is placed on a turntable 0.8 meters above the ground in the chamber, 3 meter away from the antenna. The maximal emission value is acquired by adjusting the antenna height, polarisation and turntable azimuth. Normally, the height range of antenna is 1 m to 4 m, the azimuth range of turntable is 0° to 360°, and the receive antenna has two polarizations Vertical (V) and Horizontal (H). Above 1GHz: (Note: the FCC's permission to use 1.5m as an alternative per TCBC Conf call of Dec. 2, 2014.) The EUT is placed on a turntable 1.5 meters above the ground in the chamber, 3 meter away from the antenna. The maximal emission value is acquired by adjusting the antenna height, polarisation and turntable azimuth. Normally, the height range of antenna is 1 m to 4 m, the azimuth range of turntable is 0° to 360°, and the receive antenna has two polarizations Vertical (V) and Horizontal (H).
3. A loop antenna, A log-periodic antenna or horn antenna shall be substituted in place of the EUT. The log-periodic antenna will be driven by a signal generator and the level will be adjusted till the same power value on the spectrum analyzer or receiver. The level of the spurious emissions can be calculated through the level of the signal generator, cable loss, the gain of the substitution antenna and the reading of the spectrum analyzer or receiver.
4. The EUT is then put into continuously transmitting mode at its maximum power level during the test. Set Test Receiver or Spectrum RBW=200Hz,VBW=600Hz for 9kHz-150kHz , RBW=10kHz, VBW=30kHz 150kHz-30MHz ,RBW=100kHz,VBW=300kHz for 30MHz to 1GHz and RBW=1MHz, VBW=3MHz for above 1GHz And the maximum value of the receiver should be recorded as (Pr).
5. The EUT shall be replaced by a substitution antenna. In the chamber, an substitution antenna for the frequency band of interest is placed at the reference point of the chamber. An RF Signal source for the frequency band of interest is connected to the substitution antenna with a cable that has been constructed to not interfere with the radiation pattern of the antenna. A power (PMea) is applied to the input of the substitution antenna, and adjust the level of the signal generator output until the value of the receiver reach the previously recorded (Pr). The power of signal source (PMea) is recorded. The test should be performed by rotating the test item and adjusting the receiving antenna polarization.
6. A amplifier should be connected to the Signal Source output port. And the cable should be connect between the Amplifier and the Substitution Antenna. The cable loss (Pcl) ,the Substitution Antenna Gain (Ga) and the Amplifier Gain (PAg) should be recorded after test.
7. The measurement results are obtained as described below:
Power(EIRP)=PMea- PAg - Pcl + Ga
The measurement results are amend as described below:
Power(EIRP)=PMea- Pcl + Ga
8. This value is EIRP since the measurement is calibrated using an antenna of known gain (2.15 dBi) and known input power. ERP can be calculated from EIRP by subtracting the gain of the dipole, ERP

= EIRP-2.15dBi.

The modulation mode and RB allocation refer to section 5.1, using the maximum output power configuration.

Test setup

9KHz ~ 30MHz

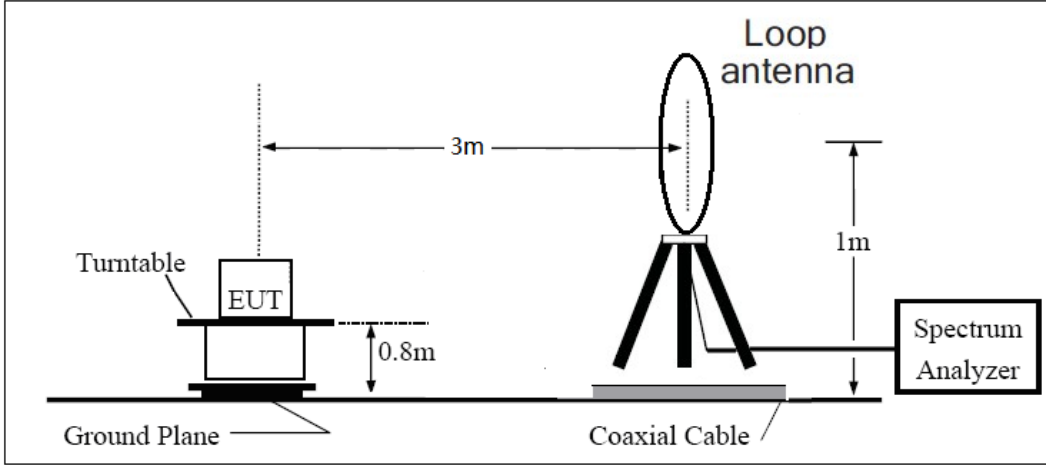

30MHz ~ 1GHz

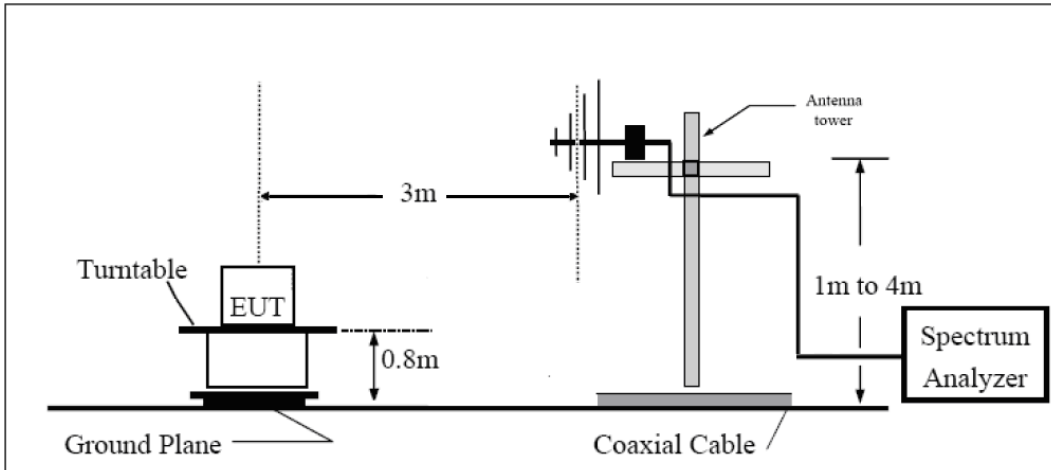

Above 1GHz

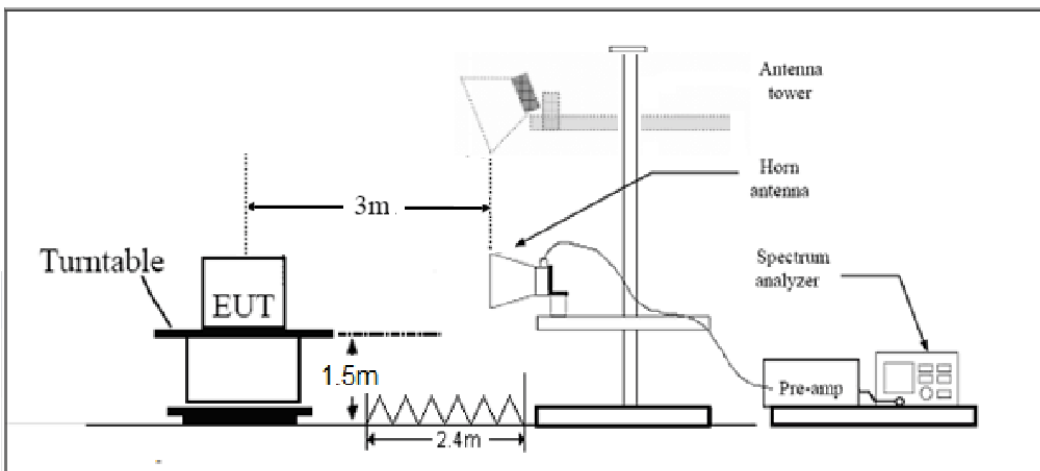

Note: Area side:2.4mX3.6m



Limits

Rule Part 27.53(m) $55 + 10 \log (P)$ dB on all frequencies more than X megahertz from the channel edge, where X is the greater of 6 megahertz or the actual emission bandwidth as defined in paragraph (m)(4) of this section.

Part 27.53(m) Limit	-25 dBm
---------------------	---------

Measurement Uncertainty

The assessed measurement uncertainty to ensure 95% confidence level for the normal distribution is with the coverage factor $k = \pm 1.96$, $U = \pm 3.55$ dB.

**Test Result**

Sweep the whole frequency band through the range from 9kHz to the 10th harmonic of the carrier, the emissions below the noise floor will not be recorded in the report.

LTE Band 7 QPSK 5MHz CH-Middle, RB 1

Harmonic	Frequency (MHz)	SG (dBm)	Cable Loss (dB)	Gain (dBi)	Antenna Polarization	EIRP Level (dBm)	Limit (dBm)	Margin (dB)	Azimuth (deg)
2	5065.80	-51.65	3.40	12.50	Horizontal	-42.55	-25.00	17.55	45
3	7598.60	-50.60	4.40	12.20	Horizontal	-42.80	-25.00	17.80	270
4	10130.63	-47.30	4.70	11.30	Horizontal	-40.70	-25.00	15.70	135
5	12663.75	-39.74	5.40	13.20	Horizontal	-31.94	-25.00	6.94	270
6	15210.00	-49.34	6.10	13.10	Horizontal	-42.34	-25.00	17.34	135
7	17745.00	-47.99	6.10	14.20	Horizontal	-39.89	-25.00	14.89	0
8	20280.00	--	--	--	--	--	--	--	--
9	22815.00	--	--	--	--	--	--	--	--
10	25350.00	--	--	--	--	--	--	--	--

Note: 1.The other Spurious RF Radiated emissions level is no more than noise floor.

2. The worst emission was found in the antenna is Horizontal position.

LTE Band 7 QPSK 20MHz CH-Middle, RB 1

Harmonic	Frequency (MHz)	SG (dBm)	Cable Loss (dB)	Gain (dBi)	Antenna Polarization	EIRP Level (dBm)	Limit (dBm)	Margin (dB)	Azimuth (deg)
2	5052.38	-54.39	3.40	12.50	Horizontal	-45.29	-25.00	20.29	0
3	7578.00	-53.11	4.40	12.20	Horizontal	-45.31	-25.00	20.31	315
4	10104.00	-47.38	4.70	11.30	Horizontal	-40.78	-25.00	15.78	90
5	12630.00	-43.15	5.40	13.20	Horizontal	-35.35	-25.00	10.35	45
6	15210.00	-48.89	6.10	13.10	Horizontal	-41.89	-25.00	16.89	270
7	17745.00	-49.60	6.10	14.20	Horizontal	-41.50	-25.00	16.50	180
8	20280.00	--	--	--	--	--	--	--	--
9	22815.00	--	--	--	--	--	--	--	--
10	25350.00	--	--	--	--	--	--	--	--

Note: 1.The other Spurious RF Radiated emissions level is no more than noise floor.

2. The worst emission was found in the antenna is Horizontal position.



6 Main Test Instruments

Name	Manufacturer	Type	Serial Number	Calibration Date	Expiration Date
Base Station Simulator	R&S	CMW500	113824	2020-05-18	2021-05-17
Power Splitter	Hua Xiang	SHX-GF2-2-13	10120101	/	/
Spectrum Analyzer	Key sight	N9010A	MY50210259	2020-05-18	2021-05-17
Signal Analyzer	R&S	FSV30	100815	2020-12-13	2021-12-12
Loop Antenna	SCHWARZBECK	FMZB1519	1519-047	2020-04-02	2023-04-01
TRILOG Broadband Antenna	SCHWARZBECK	VULB 9163	391	2019-12-16	2021-12-15
Horn Antenna	R&S	HF907	102723	2018-08-11	2021-08-10
Horn Antenna	ETS-Lindgren	3160-09	00102643	2018-06-20	2021-06-19
Signal generator	R&S	SMB 100A	102594	2020-05-18	2021-05-17
Climatic Chamber	ESPEC	SU-242	93000506	2020-12-13	2021-12-12
Preamplifier	R&S	SCU18	102327	2020-05-18	2021-05-17
MOB COMMS DC SUPPLY	Keysight	66319D	MY43004105	2020-05-18	2021-05-17
RF Cable	Agilent	SMA 15cm	0001	2020-12-10	2021-06-09
Software	R&S	EMC32	9.26.0	/	/

*****END OF REPORT *****



ANNEX A: The EUT Appearance

The EUT Appearance are submitted separately.



ANNEX B: Test Setup Photos

The Test Setup Photos are submitted separately.