

FCC RF Test Report

APPLICANT : Bullitt Group
EQUIPMENT : Smart Phone
BRAND NAME : CAT
MODEL NAME : B15
FCC ID : ZL5B15AWS
STANDARD : FCC Part 15 Subpart C §15.247
CLASSIFICATION : (DSS) Spread Spectrum Transmitter

The product was received on Dec. 20, 2012 and completely tested on May 28, 2013. We, SPORTON INTERNATIONAL INC., would like to declare that the tested sample has been evaluated in accordance with the procedures and shown the compliance with the applicable technical standards.

The test results in this report apply exclusively to the tested model / sample. Without written approval of SPORTON INTERNATIONAL INC., the test report shall not be reproduced except in full.



Reviewed by: Joseph Lin / Supervisor

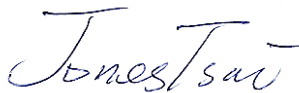

Approved by: Jones Tsai / Manager



SPORTON INTERNATIONAL INC.

No. 52, Hwa Ya 1st Rd., Hwa Ya Technology Park, Kwei-Shan Hsiang, Tao Yuan Hsien, Taiwan, R.O.C.



TABLE OF CONTENTS

REVISION HISTORY 3

SUMMARY OF TEST RESULT 4

1 GENERAL DESCRIPTION 5

 1.1 Applicant 5

 1.2 Manufacturer 5

 1.3 Feature of Equipment Under Test 5

 1.4 Product Specification of Equipment Under Test 6

 1.5 Testing Site 6

 1.6 Applied Standards 6

2 TEST CONFIGURATION OF EQUIPMENT UNDER TEST 7

 2.1 Descriptions of Test Mode 7

 2.2 Test Mode 8

 2.3 Connection Diagram of Test System 9

 2.4 Support Unit used in test configuration and system 10

 2.5 EUT Operation Test Setup 10

 2.6 Measurement Results Explanation Example 11

3 TEST RESULT 13

 3.1 Number of Channel Measurement 13

 3.2 Hopping Channel Separation Measurement 15

 3.3 Dwell Time Measurement 22

 3.4 20dB Bandwidth Measurement 25

 3.5 Peak Output Power Measurement 32

 3.6 Conducted Band Edges Measurement 39

 3.7 Conducted Spurious Emission Measurement 46

 3.8 Radiated Band Edges and Spurious Emission Measurement 56

 3.9 AC Conducted Emission Measurement 68

 3.10 Antenna Requirements 72

4 LIST OF MEASURING EQUIPMENT 73

5 UNCERTAINTY OF EVALUATION 74

APPENDIX A. PHOTOGRAPHS OF EUT

APPENDIX B. SETUP PHOTOGRAPHS

APPENDIX C. PRODUCT EQUALITY DECLARATION



REVISION HISTORY

REPORT NO.	VERSION	DESCRIPTION	ISSUED DATE
FR2D2653-01A	Rev. 01	Initial issue of report	Jun. 04, 2013
FR2D2653-01A	Rev. 02	Adding Loop Antenna for List of Measuring Equipment and changing Product Equality Declaration.	Jul. 19, 2013



SUMMARY OF TEST RESULT

Report Section	FCC Rule	IC Rule	Description	Limit	Result	Remark
3.1	15.247(a)(1)	RSS-210 A8.4(2)	Number of Channels	$\geq 15\text{Chs}$	Pass	-
3.2	15.247(a)(1)	RSS-210 A8.1(b)	Hopping Channel Separation	$\geq 2/3$ of 20dB BW	Pass	-
3.3	15.247(a)(1)	RSS-210 A8.1(d)	Dwell Time of Each Channel	$\leq 0.4\text{sec}$ in 31.6sec period	Pass	-
3.4	15.247(a)(1)	RSS-210 A8.1(a)	20dB Bandwidth	NA	Pass	-
3.5	15.247(b)(1)	RSS-210 A8.1(b)	Peak Output Power	$\leq 1\text{ W}$ for 1Mbps $\leq 125\text{ mW}$ for 2, 3Mbps	Pass	-
3.6	15.247(d)	RSS-210 A8.5	Conducted Band Edges	$\leq 20\text{dBc}$	Pass	-
3.7	15.247(d)	RSS-210 A8.5	Conducted Spurious Emission	$\leq 20\text{dBc}$	Pass	-
3.8	15.247(d)	RSS-210 A8.5	Radiated Band Edges and Radiated Spurious Emission	15.209(a) & 15.247(d)	Pass	Under limit 6.81 dB at 30.270 MHz
3.9	15.207	RSS-Gen 7.2.4	AC Conducted Emission	15.207(a)	Pass	Under limit 7.30 dB at 0.374 MHz
3.10	15.203 & 15.247(b)	RSS-210 A8.4	Antenna Requirement	N/A	Pass	-

Remark: FCC ID ZL5B15AWS WLAN/BT RF circuit design is the same as FCC ID ZL5B15 granted on 2013/02/19, except the differences referring to the Product Equality Declaration in Appendix C. Based on the similarity between two FCC IDs, the Conducted and Radiation test data of FCC ID ZL5B15 granted on 2013/02/19 is referred in this report to show the compliance of the FCC ID ZL5B15AWS.



1 General Description

1.1 Applicant

Bullitt Group

No. 4, The Aquarium, King Street, Reading, RG1 2AN United Kingdom

1.2 Manufacturer

Compal Communications (Nanjing) Co. Ltd.

No. 68-2 Suyuan Road, Nanjing Export, Processing Zone(South Area), P.R. China

1.3 Feature of Equipment Under Test

Product Feature	
Equipment	Smart Phone
Brand Name	CAT
Model Name	B15
FCC ID	ZL5B15AWS
EUT supports Radios application	GSM/EGPRS/WCDMA/HSDPA WLAN 11bgn / Bluetooth 2.1/3.0
EUT Stage	Production Unit

Remark: The above EUT's information was declared by manufacturer. Please refer to the specifications or user's manual for more detailed description.

1.4 Product Specification of Equipment Under Test

Product Specification subjective to this standard	
Tx/Rx Frequency Range	2402 MHz ~ 2480 MHz
Number of Channels	79
Carrier Frequency of Each Channel	2402+n*1 MHz; n=0~78
Maximum Output Power to Antenna	Bluetooth (1Mbps) : 5.79 dBm (0.0038 W) Bluetooth EDR (2Mbps) : 4.93 dBm (0.0031 W) Bluetooth EDR (3Mbps) : 5.14 dBm (0.0033 W)
Antenna Type	PIFA Antenna type with gain 1.73 dBi
Type of Modulation	Bluetooth 2.1 BR (1Mbps) : GFSK Bluetooth 2.1 EDR (2Mbps) : $\pi/4$ -DQPSK Bluetooth 2.1 EDR (3Mbps) : 8-DPSK Bluetooth 3.0 BR (1Mbps) : GFSK Bluetooth 3.0 EDR (2Mbps) : $\pi/4$ -DQPSK Bluetooth 3.0 EDR (3Mbps) : 8-DPSK

1.5 Testing Site

Test Site	SPORTON INTERNATIONAL INC.			
Test Site Location	No. 52, Hwa Ya 1 st Rd., Hwa Ya Technology Park, Kwei-Shan Hsiang, Tao Yuan Hsien, Taiwan, R.O.C. TEL: +886-3-3273456 / FAX: +886-3-3284978			
Test Site No.	Sporton Site No.			FCC/IC Registration No.
	TH02-HY	CO05-HY	03CH06-HY	722060/4086B-1

Note: The test site complies with ANSI C63.4 2003 requirement.

1.6 Applied Standards

According to the specifications of the manufacturer, the EUT must comply with the requirements of the following standards:

- ♦ FCC Part 15 Subpart C §15.247
- ♦ FCC Public Notice DA 00-705
- ♦ ANSI C63.10-2009

Remark:

1. All test items were verified and recorded according to the standards and without any deviation during the test.
2. This EUT has also been tested and complied with the requirements of FCC Part 15, Subpart B, recorded in a separate test report.

2 Test Configuration of Equipment Under Test

2.1 Descriptions of Test Mode

Preliminary tests were performed in different data rates and recorded the RF output power in the following table:

Channel	Frequency	Bluetooth RF Output Power		
		Data Rate / Modulation		
		GFSK	$\pi/4$ -DQPSK	8-DPSK
		1Mbps	2Mbps	3Mbps
Ch00	2402MHz	5.79 dBm	4.93 dBm	5.14 dBm
Ch39	2441MHz	4.18 dBm	3.38 dBm	3.75 dBm
Ch78	2480MHz	5.69 dBm	4.89 dBm	5.14 dBm

Remark:

1. All the test data for each data rate were verified, but only the worst case was reported.
 2. The data rate was set in 1Mbps for all the test items due to the highest RF output power.
- a. The EUT has been associated with peripherals pursuant to ANSI C63.10-2009 and configuration operated in a manner tended to maximize its emission characteristics in a typical application. Frequency range investigated: conduction (150 kHz to 30 MHz), radiation (9 kHz to the 10th harmonic of the highest fundamental frequency or to 40 GHz, whichever is lower).
 - b. AC power line Conducted Emission was tested under maximum output power.

2.2 Test Mode

The following summary table is showing all test modes to demonstrate in compliance with the standard.

Summary table of Test Cases			
Test Item	Data Rate / Modulation		
	Bluetooth 1Mbps GFSK	Bluetooth EDR 2Mbps $\pi/4$ -DQPSK	Bluetooth EDR 3Mbps 8-DPSK
Conducted Test Cases	Mode 1: CH00_2402 MHz Mode 2: CH39_2441 MHz Mode 3: CH78_2480 MHz	Mode 4: CH00_2402 MHz Mode 5: CH39_2441 MHz Mode 6: CH78_2480 MHz	Mode 7: CH00_2402 MHz Mode 8: CH39_2441 MHz Mode 9: CH78_2480 MHz
Radiated Test Cases	Bluetooth 1Mbps GFSK Mode 1: CH00_2402 MHz Mode 2: CH39_2441 MHz Mode 3: CH78_2480 MHz		
AC Conducted Emission	Mode 1 :WCDMA Band V Idle + Bluetooth Link + WLAN Link + MPEG4 + Earphone 2 + Battery + USB Cable (Charging from Adapter)		
Remark: 1. For radiated test cases, the worst mode data rate 1Mbps was reported only, because this data rate has the highest RF output power at preliminary tests, and the conducted spurious emissions and conducted band edge measurement for each data rate are no worse than 1Mbps, and no other significantly frequencies found in conducted spurious emission . 2. All the Radiation tests were performance with Earphone 1.			

2.3 Connection Diagram of Test System

<Bluetooth Tx Mode>

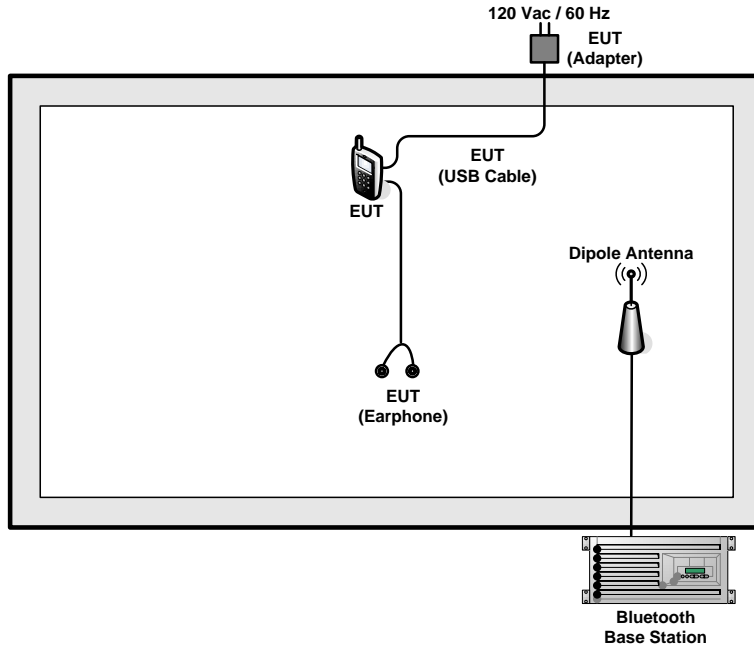

<AC Conducted Emission Mode>

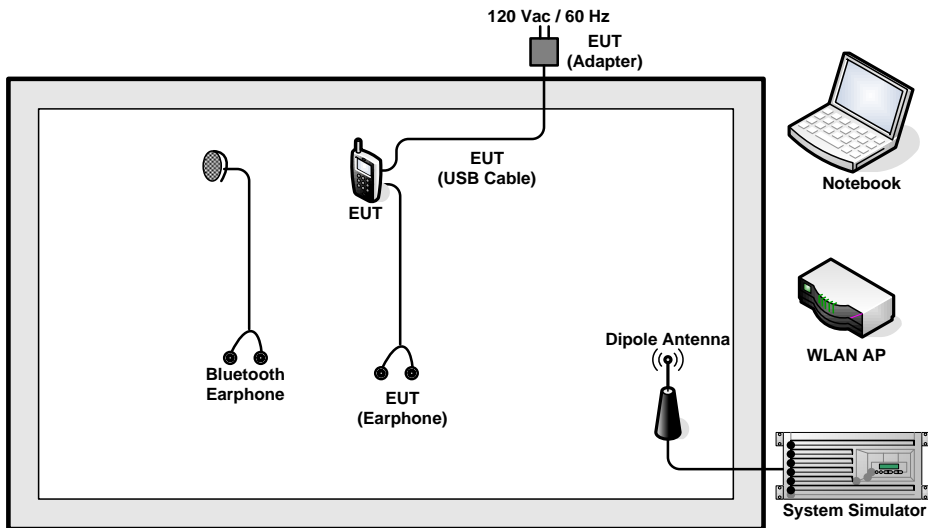

2.4 Support Unit used in test configuration and system

Item	Equipment	Trade Name	Model Name	FCC ID	Data Cable	Power Cord
1.	System Simulator	R&S	CMU 200	N/A	N/A	Unshielded, 1.8 m
2.	GPS Station	Pendulum	GSG-54	N/A	N/A	Unshielded, 1.8 m
3.	WLAN AP	D-Link	DIR-628	KA2DIR628A2	N/A	Unshielded, 1.8 m
4.	Notebook	DELL	Latitude E6320	FCC DoC	N/A	AC I/P: Unshielded, 1.2 m DC O/P: Shielded, 1.8 m
5.	Bluetooth Earphone	Sony Ericsson	MW600	PY7DDA-2029	N/A	N/A
6.	iPod	Apple	A1285	FCC DoC	Shielded, 1.0 m	N/A
7.	LCD Monitor	DELL	U2410	FCC DoC	Shielded, 1.6 m	Unshielded, 1.8 m
8.	MicroSD Card	SanDisk	MicroSD HC	FCC DoC	N/A	N/A
9.	Bluetooth Base Station	R&S	CBT32	N/A	N/A	Unshielded, 1.8 m

2.5 EUT Operation Test Setup

For Bluetooth function, key in “* # * # 3646633 # * # *” on the EUT directly. Then, the EUT will get into the engineering modes to contact with Bluetooth base station for continuous transmitting and receiving signals.



2.6 Measurement Results Explanation Example

For all conducted test items:

The offset level is set in the spectrum analyzer to compensate the RF cable loss and attenuator factor between EUT conducted output port and spectrum analyzer. With the offset compensation, the spectrum analyzer reading level is exactly the EUT RF output level.

The spectrum analyzer offset is derived from RF cable loss and attenuator factor.

Offset = RF cable loss + attenuator factor.

Following shows an offset computation example with cable loss 4.2 dB and 10dB attenuator.

Example :

$$\begin{aligned} \text{Offset(dB)} &= \text{RF cable loss(dB)} + \text{attenuator factor(dB)}. \\ &= 4.2 + 10 = 14.2 \text{ (dB)} \end{aligned}$$



For radiated band edges and spurious emission test :

Per part 15.35(c), the EUT Bluetooth average emission level could be determined by the peak emission level applying duty cycle correction factor, to represent averaging over the whole pulse train.

The average level is derived from the peak level corrected with "Duty cycle correction factor".

$$\text{Average Emission Level(dB}\mu\text{V/m)} = \text{Peak Emission Level(dB}\mu\text{V/m)} + \text{Duty cycle correction factor(dB)}$$

$$\text{Duty cycle correction factor(dB)} = 20 * \log(\text{Duty cycle}).$$

$$\text{Duty cycle} = \text{On time} / 100 \text{ milliseconds}$$

$$\text{On time} = \text{worst case dwell time} * \text{hopping number in 100 ms}$$

For example : bluetooth with worst case dwell time 2.9ms and 2 hops in 100 ms, then

$$\text{Duty cycle correction factor(dB)} = 20 * \log((2.9 * 2) / 100) = -24.73 \text{ dB}$$

Following shows an average computation example with duty cycle correction factor = -24.73dB, and the peak emission level is 45.61 dB μ V/m.

Example :

$$\begin{aligned} \text{Average Emission Level(dB}\mu\text{V/m)} &= \text{Peak Emission Level(dB}\mu\text{V/m)} + \text{duty cycle correction factor(dB)} \\ &= 45.61 + (-24.73) = 20.88 \text{ (dB}\mu\text{V/m)} \end{aligned}$$

3 Test Result

3.1 Number of Channel Measurement

3.1.1 Limits of Number of Hopping Frequency

Frequency hopping systems in the 2400-2483.5 MHz band shall use at least 15 channels.

3.1.2 Measuring Instruments

See list of measuring instruments of this test report.

3.1.3 Test Procedure

1. The testing follows FCC Public Notice DA 00-705 Measurement Guidelines.
2. The RF output of EUT was connected to the spectrum analyzer by RF cable and attenuator. The path loss was compensated to the results for each measurement.
3. Set to the maximum power setting and enable the EUT transmit continuously.
4. Enable the EUT hopping function.
5. Use the following spectrum analyzer settings: Span = the frequency band of operation; RBW \geq 1% of the span; VBW \geq RBW; Sweep = auto; Detector function = peak; Trace = max hold.
6. The number of hopping frequency used is defined as the number of total channel.
7. Record the measurement data derived from spectrum analyzer.

3.1.4 Test Setup

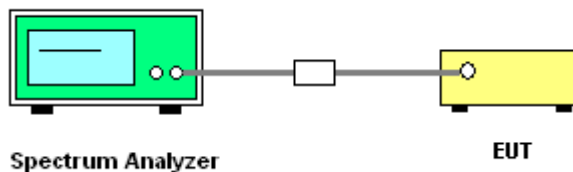

3.1.5 Test Result of Number of Hopping Frequency

Test Mode :	1Mbps	Temperature :	24~26°C
Test Engineer :	Coyote Lin	Relative Humidity :	50~53%

Number of Hopping (Channel)	Adaptive Frequency Hopping (Channel)	Limits (Channel)	Pass/Fail
79	20	> 15	Pass



Number of Hopping Channel Plot on Channel 00 - 78

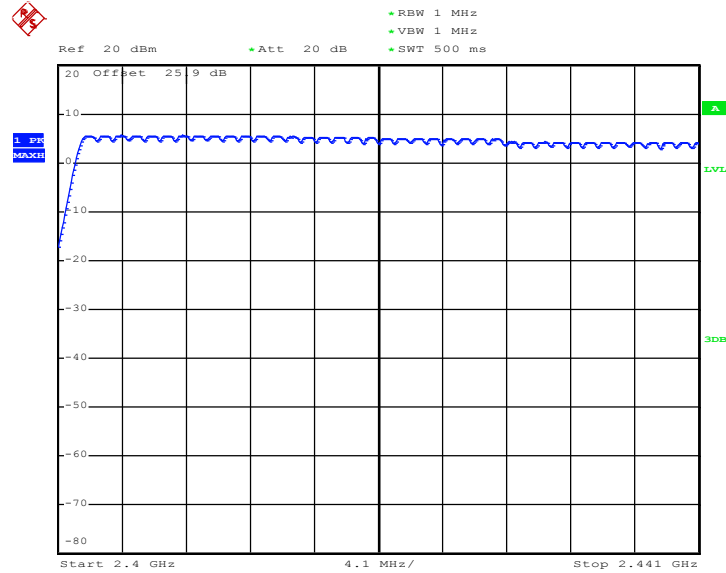

Date: 20.DEC.2012 16:10:30

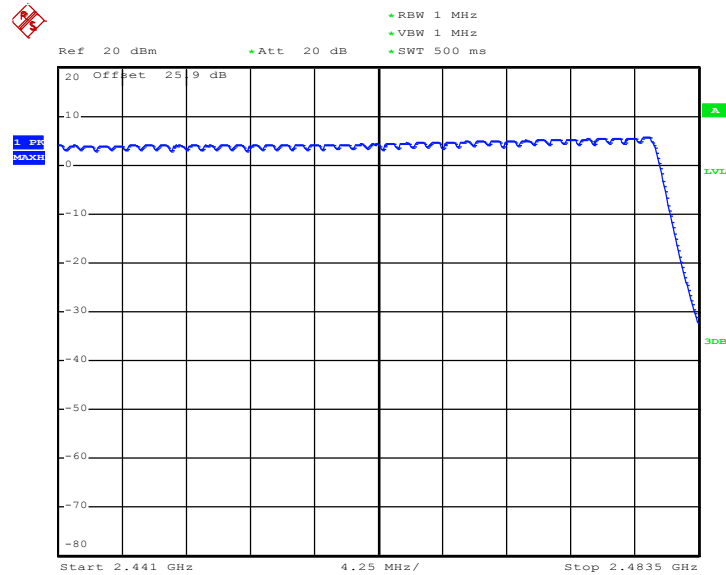

Date: 20.DEC.2012 16:15:32

3.2 Hopping Channel Separation Measurement

3.2.1 Limit of Hopping Channel Separation

Frequency hopping systems operating in the 2400-2483.5 MHz band may have hopping channel carrier frequencies that are separated by 25 kHz or two-thirds of the 20 dB bandwidth of the hopping channel, whichever is greater.

3.2.2 Measuring Instruments

See list of measuring instruments of this test report.

3.2.3 Test Procedures

1. The testing follows FCC Public Notice DA 00-705 Measurement Guidelines.
2. The RF output of EUT was connected to the spectrum analyzer by RF cable and attenuator. The path loss was compensated to the results for each measurement.
3. Set to the maximum power setting and enable the EUT transmit continuously.
4. Enable the EUT hopping function.
5. Use the following spectrum analyzer settings:
Span = wide enough to capture the peaks of two adjacent channels; $RBW \geq 1\%$ of the span;
 $VBW \geq RBW$; Sweep = auto; Detector function = peak; Trace = max hold.
6. Measure and record the results in the test report.

3.2.4 Test Setup

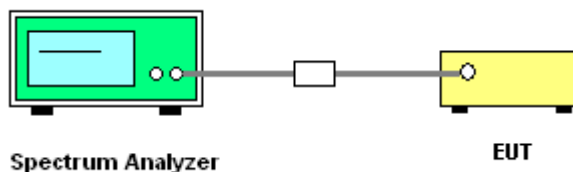



3.2.5 Test Result of Hopping Channel Separation

Test Mode :	1Mbps	Temperature :	24~26°C
Test Engineer :	Coyote Lin	Relative Humidity :	50~53%

Channel	Frequency (MHz)	Frequency Separation (MHz)	(2/3 of 20dB BW) Limits (MHz)	Pass/Fail
00	2402	1.002	0.6080	Pass
39	2441	1.002	0.6080	Pass
78	2480	1.002	0.6053	Pass

Channel Separation Plot on Channel 00 - 01

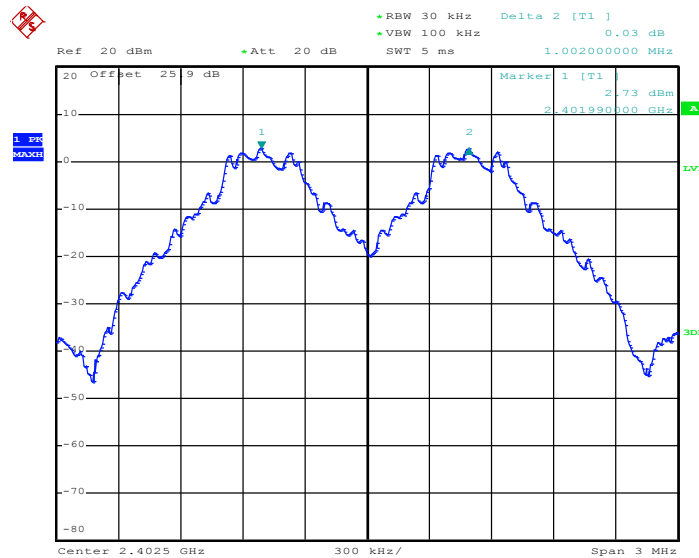

Date: 20.DEC.2012 15:26:55



Channel Separation Plot on Channel 39 - 40

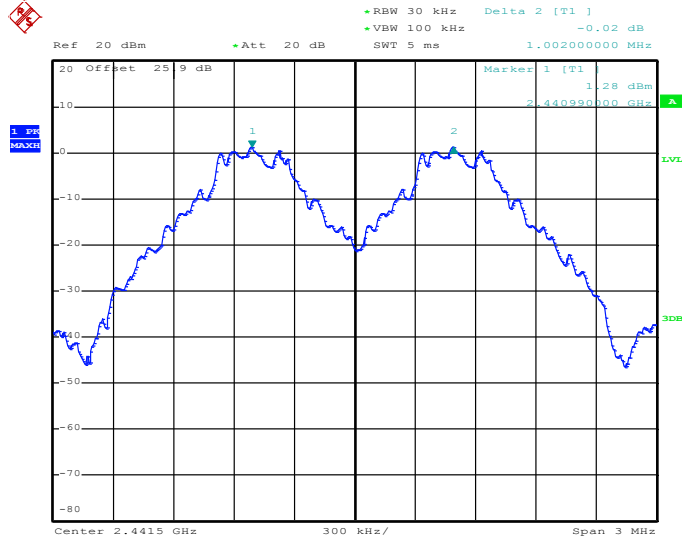

Date: 20.DEC.2012 15:27:35

Channel Separation Plot on Channel 77 - 78

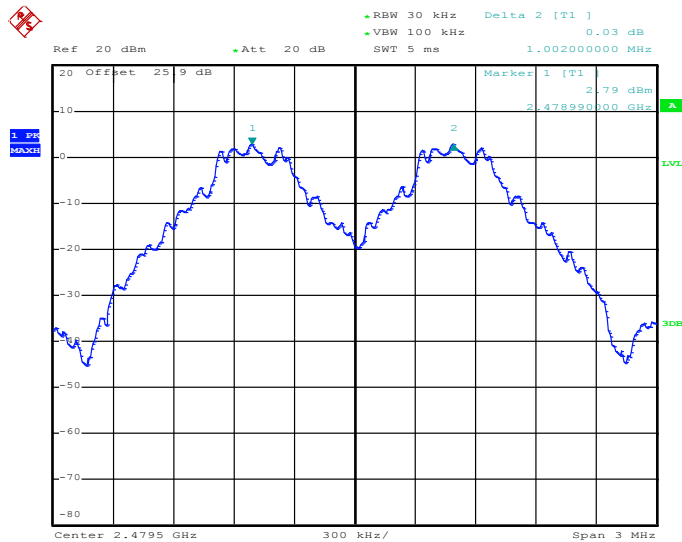

Date: 20.DEC.2012 15:28:15



Test Mode :	2Mbps	Temperature :	24~26°C
Test Engineer :	Coyote Lin	Relative Humidity :	50~53%

Channel	Frequency (MHz)	Frequency Separation (MHz)	(2/3 of 20dB BW) Limits (MHz)	Pass/Fail
00	2402	1.002	0.8520	Pass
39	2441	1.002	0.8560	Pass
78	2480	1.002	0.8520	Pass

Channel Separation Plot on Channel 00 - 01

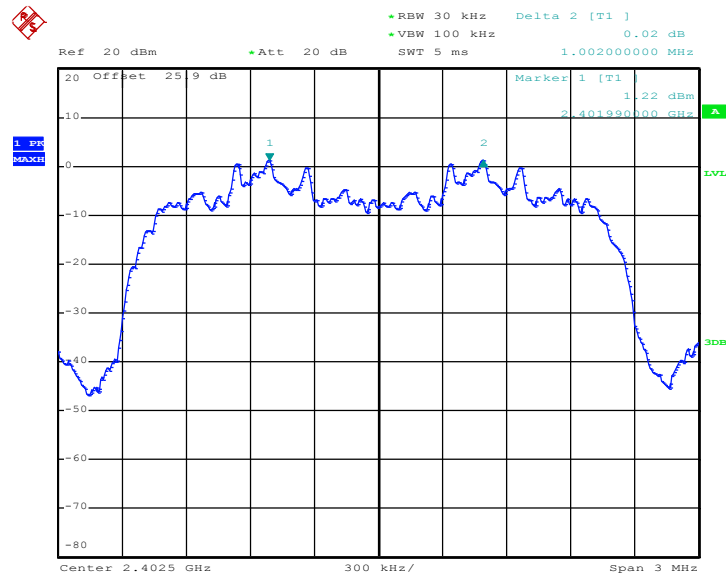

Date: 20.DEC.2012 15:31:25



Channel Separation Plot on Channel 39 - 40

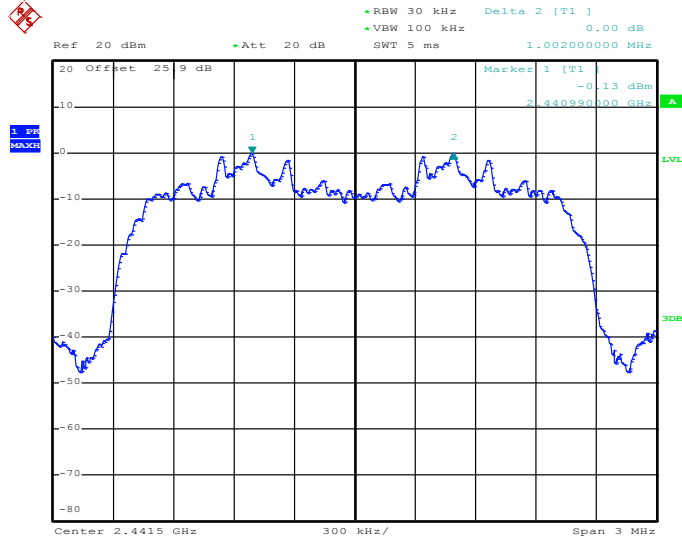

Date: 20.DEC.2012 15:35:40

Channel Separation Plot on Channel 77 - 78

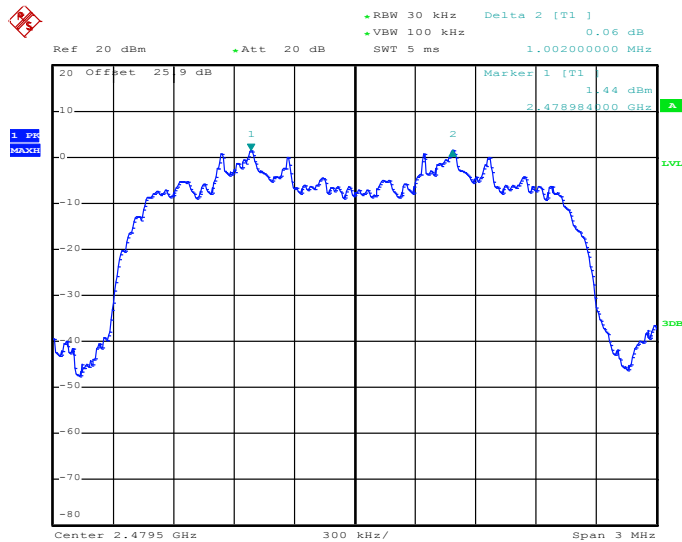

Date: 20.DEC.2012 15:36:56



Test Mode :	3Mbps	Temperature :	24~26°C
Test Engineer :	Coyote Lin	Relative Humidity :	50~53%

Channel	Frequency (MHz)	Frequency Separation (MHz)	(2/3 of 20dB BW) Limits (MHz)	Pass/Fail
00	2402	1.008	0.8200	Pass
39	2441	1.002	0.8200	Pass
78	2480	1.002	0.8240	Pass

Channel Separation Plot on Channel 00 - 01

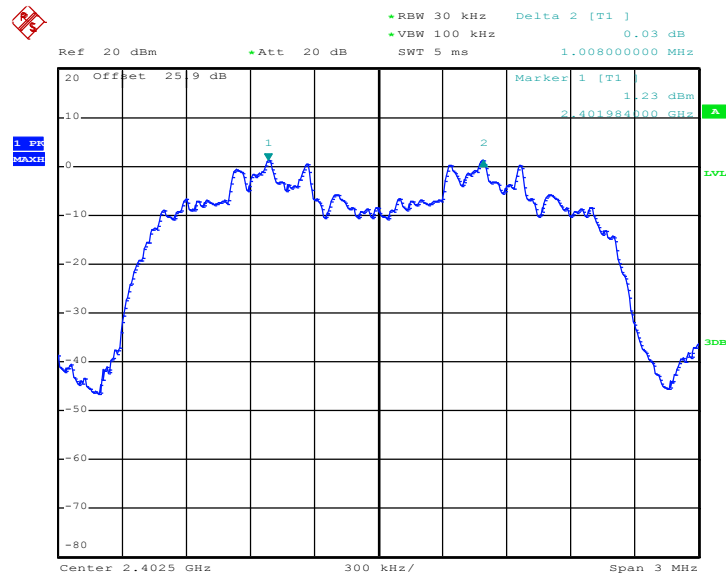

Date: 20.DEC.2012 15:37:39



Channel Separation Plot on Channel 39 - 40

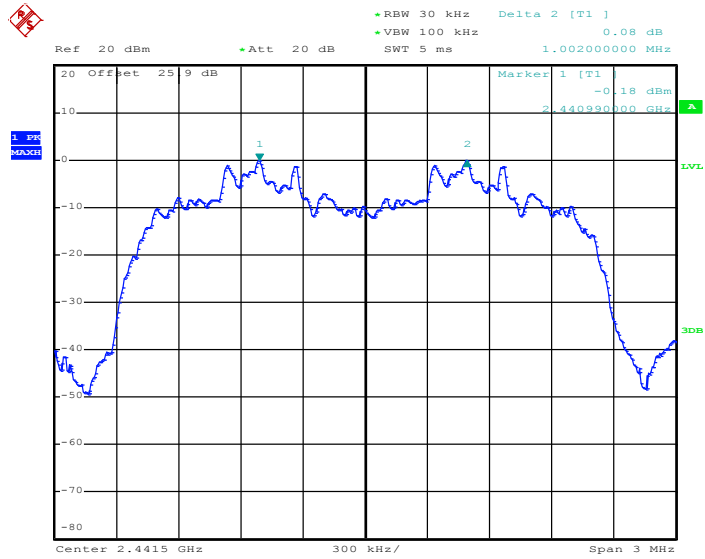

Date: 20.DEC.2012 15:38:43

Channel Separation Plot on Channel 77 - 78

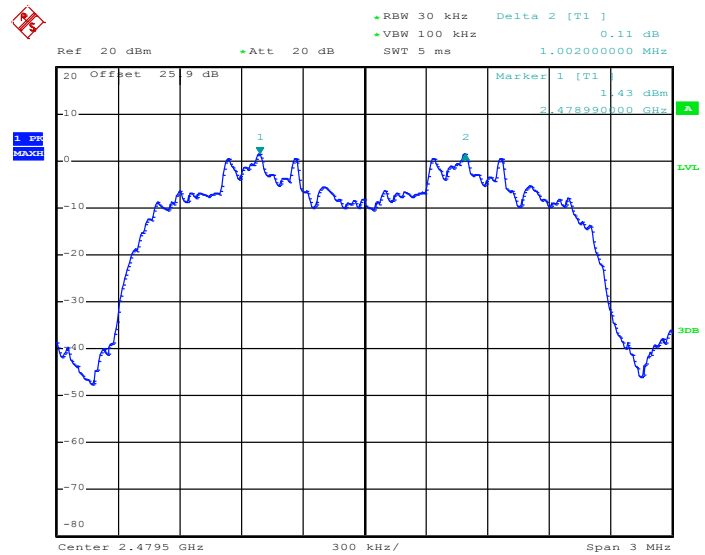

Date: 20.DEC.2012 15:39:24

3.3 Dwell Time Measurement

3.3.1 Limit of Dwell Time

The average time of occupancy on any channel shall not be greater than 0.4 seconds within a period of 0.4 seconds multiplied by the number of hopping channels employed.

3.3.2 Measuring Instruments

See list of measuring instruments of this test report.

3.3.3 Test Procedures

1. The testing follows FCC Public Notice DA 00-705 Measurement Guidelines.
2. The RF output of EUT was connected to the spectrum analyzer by RF cable and attenuator. The path loss was compensated to the results for each measurement.
3. Set to the maximum power setting and enable the EUT transmit continuously.
4. Enable the EUT hopping function.
5. Use the following spectrum analyzer settings: Span = zero span, centered on a hopping channel; RBW = 1 MHz; VBW \geq RBW; Sweep = as necessary to capture the entire dwell time per hopping channel; Detector function = peak; Trace = max hold.
6. Measure and record the results in the test report.

3.3.4 Test Setup

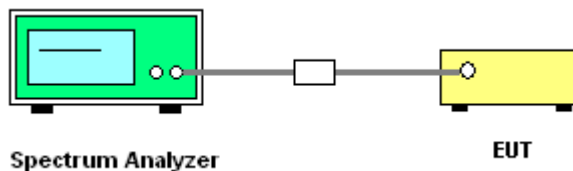



3.3.1 Test Result of Dwell Time

Test Mode :	DH5	Temperature :	24~26°C
Test Engineer :	Coyote Lin	Relative Humidity :	50~53%

Mode	Hopping Channel Number	Hops Over Occupancy Time(hops)	Package Transfer Time (msec)	Dwell Time (sec)	Limits (sec)	Pass/Fail
Normal	79	106.67	2.95	0.31	0.4	Pass
AFH	20	53.33	2.95	0.16	0.4	Pass

Remark:

1. In normal mode, hopping rate is 1600hops/s with 6 slots in 79 hopping channels.
With channel hopping rate (1600 / 6 / 79) in Occupancy Time Limit (0.4 x 79) (s),
Hops Over Occupancy Time comes to (1600 / 6 / 79) x (0.4 x 79) = 106.67 hops.
2. In AFH mode, hopping rate is 800hops/s with 6 slots in 20 hopping channels.
With channel hopping rate (800 / 6 / 20) in Occupancy Time Limit (0.4 x 20) (s),
Hops Over Occupancy Time comes to (800 / 6 / 20) x (0.4 x 20) = 53.33 hops.
3. Dwell Time(s) = Hops Over Occupancy Time (hops) x Package Transfer Time



Package Transfer Time Plot

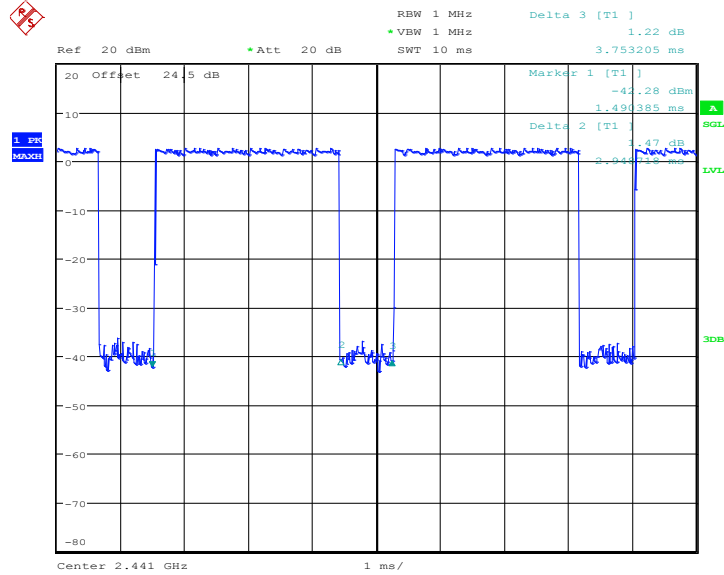

Date: 26.DEC.2012 16:56:24

3.4 20dB Bandwidth Measurement

3.4.1 Limit of 20dB Bandwidth

Reporting only

3.4.2 Measuring Instruments

See list of measuring instruments of this test report.

3.4.3 Test Procedures

1. The testing follows FCC Public Notice DA 00-705 Measurement Guidelines.
2. The RF output of EUT was connected to the spectrum analyzer by RF cable and attenuator. The path loss was compensated to the results for each measurement.
3. Set to the maximum power setting and enable the EUT transmit continuously.
4. Use the following spectrum analyzer settings for 20dB Bandwidth measurement.
Span = approximately 2 to 3 times the 20 dB bandwidth, centered on a hopping channel;
RBW \geq 1% of the 20 dB bandwidth; VBW \geq RBW; Sweep = auto; Detector function = peak;
Trace = max hold.
5. Measure and record the results in the test report.

3.4.4 Test Setup

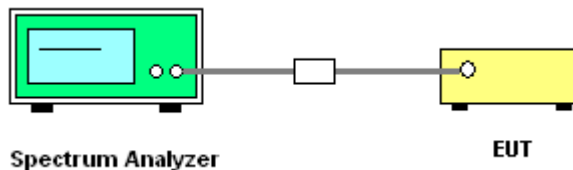



3.4.5 Test Result of 20dB Bandwidth

Test Mode :	1Mbps	Temperature :	24~26°C
Test Engineer :	Coyote Lin	Relative Humidity :	50~53%

Channel	Frequency (MHz)	20dB Bandwidth (MHz)
00	2402	0.912
39	2441	0.912
78	2480	0.908

20 dB Bandwidth Plot on Channel 00

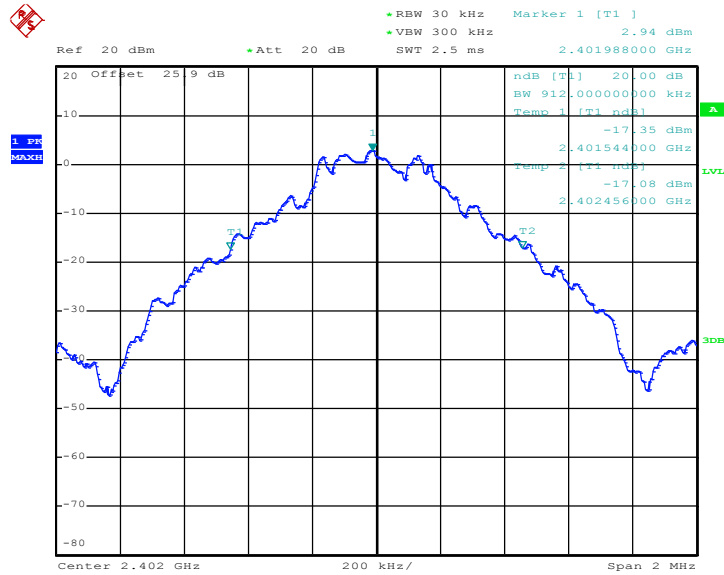

Date: 20.DEC.2012 15:41:55



20 dB Bandwidth Plot on Channel 39

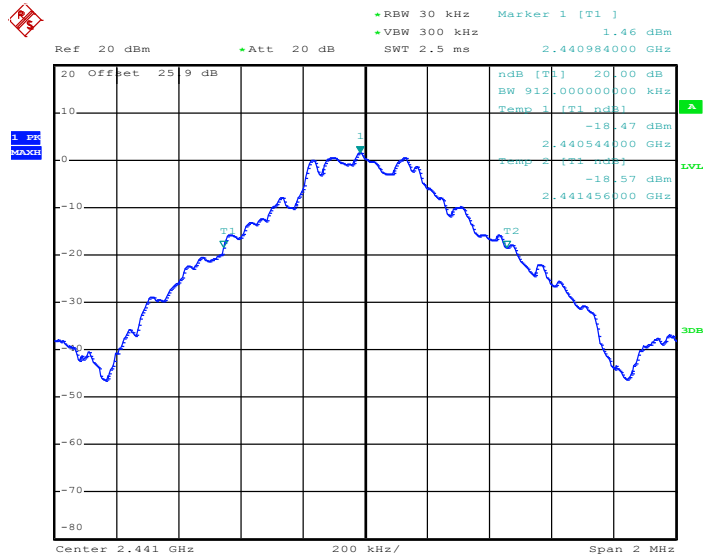

Date: 20.DEC.2012 15:42:40

20 dB Bandwidth Plot on Channel 78

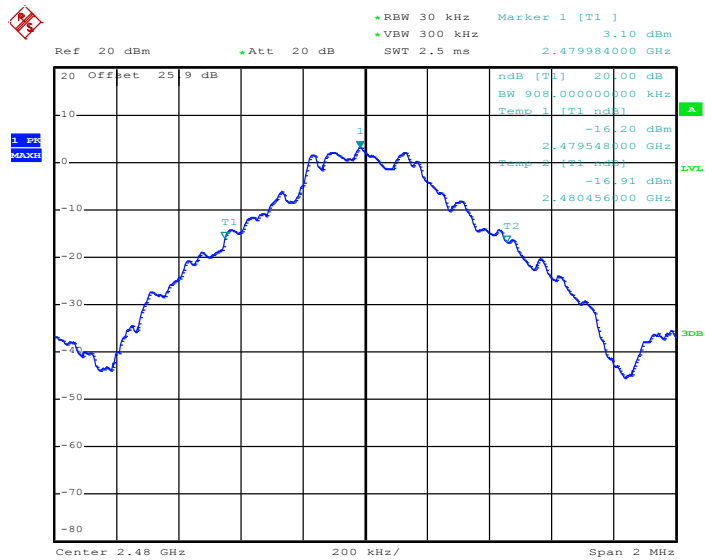

Date: 20.DEC.2012 15:43:54



Test Mode :	2Mbps	Temperature :	24~26°C
Test Engineer :	Coyote Lin	Relative Humidity :	50~53%

Channel	Frequency (MHz)	20dB Bandwidth (MHz)
00	2402	1.278
39	2441	1.284
78	2480	1.278

20 dB Bandwidth Plot on Channel 00

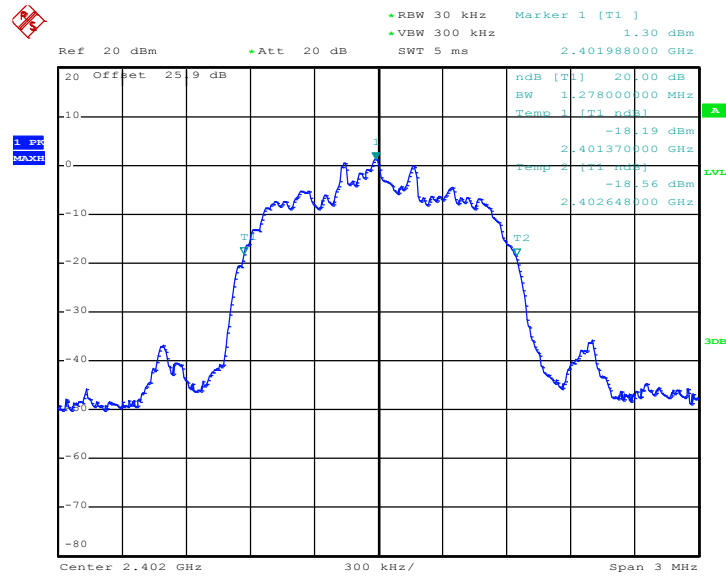

Date: 20.DEC.2012 15:44:35



20 dB Bandwidth Plot on Channel 39

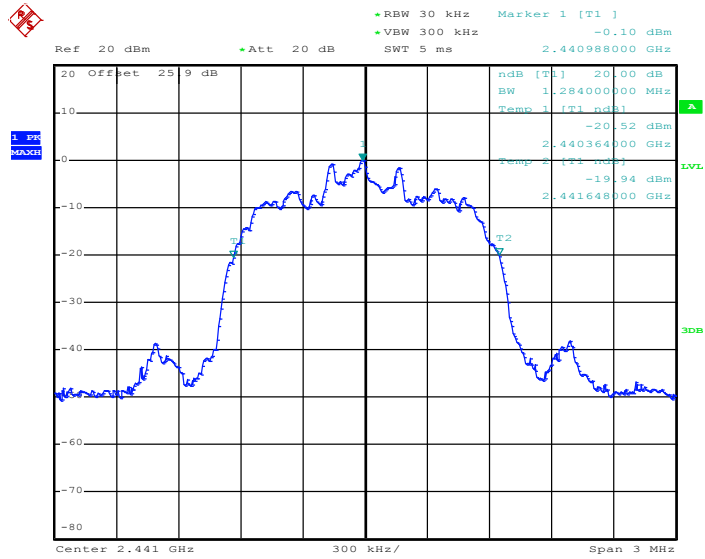

Date: 20.DEC.2012 15:45:22

20 dB Bandwidth Plot on Channel 78

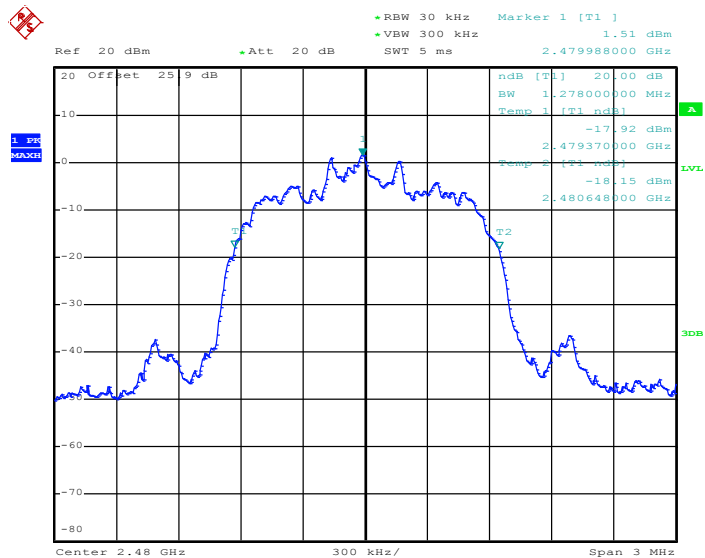

Date: 20.DEC.2012 15:46:24



Test Mode :	3Mbps	Temperature :	24~26°C
Test Engineer :	Coyote Lin	Relative Humidity :	50~53%

Channel	Frequency (MHz)	20dB Bandwidth (MHz)
00	2402	1.230
39	2441	1.230
78	2480	1.236

20 dB Bandwidth Plot on Channel 00

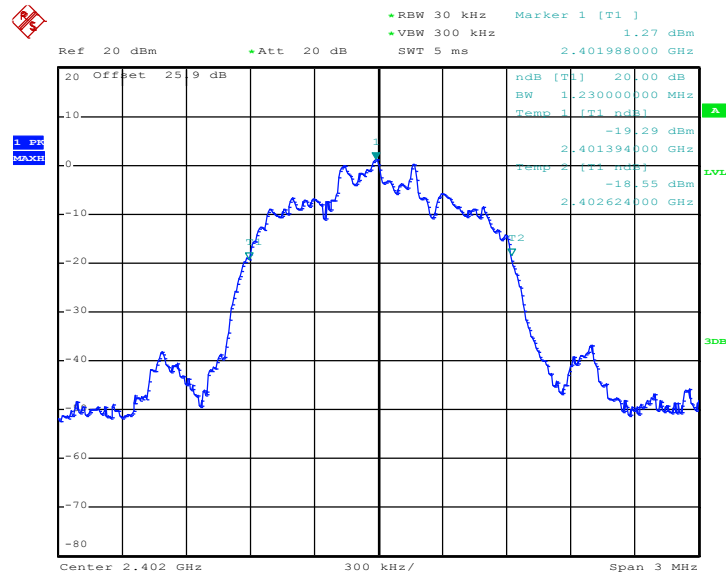

Date: 20.DEC.2012 15:46:43



20 dB Bandwidth Plot on Channel 39

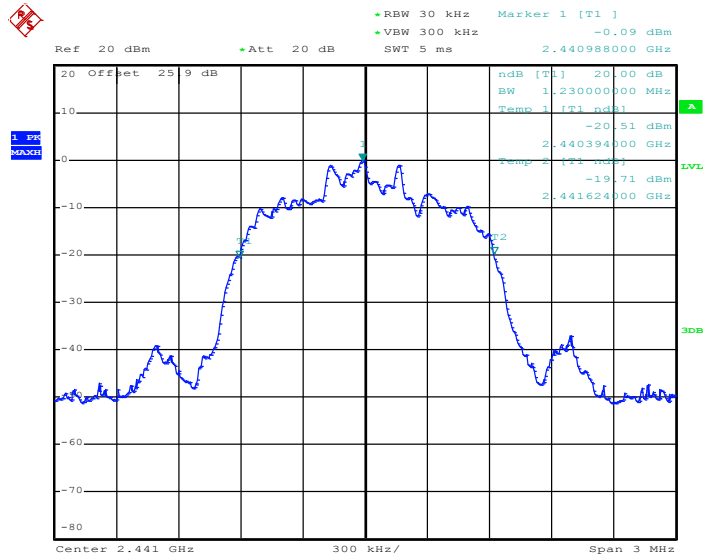

Date: 20.DEC.2012 15:47:10

20 dB Bandwidth Plot on Channel 78

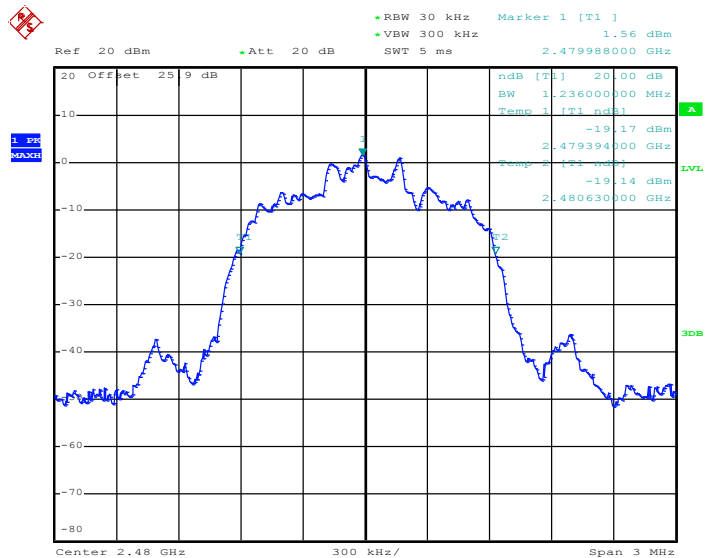

Date: 20.DEC.2012 15:47:37

3.5 Peak Output Power Measurement

3.5.1 Limit of Peak Output Power

Section 15.247 (b) The maximum peak conducted output power of the intentional radiator shall not exceed the following: (1) For frequency hopping systems operating in the 2400-2483.5 MHz band employing at least 75 non-overlapping hopping channels, and all frequency hopping systems in the 5725-5850 MHz band: 1 watt. For all other frequency hopping systems in the 2400-2483.5 MHz band 0.125 watts. The power limit for 1Mbps is 1watt, and for 2Mbps, 3Mbps and AFH are 0.125 watts.

3.5.2 Measuring Instruments

See list of measuring instruments of this test report.

3.5.3 Test Procedures

1. The testing follows FCC Public Notice DA 00-705 Measurement Guidelines.
2. The RF output of EUT was connected to the spectrum analyzer by RF cable and attenuator. The path loss was compensated to the results for each measurement.
3. Set to the maximum power setting and enable the EUT transmit continuously.
4. Measure the conducted output power with cable loss and record the results in the test report.
5. Measure and record the results in the test report.

3.5.4 Test Setup

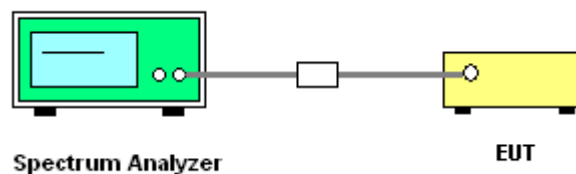



3.5.5 Test Result of Peak Output Power

Test Mode :	1Mbps	Temperature :	24~26°C
Test Engineer :	Coyote Lin	Relative Humidity :	50~53%

Channel	Frequency (MHz)	RF Power (dBm)		
		GFSK	Max. Limits (dBm)	Pass/Fail
		1 Mbps		
00	2402	5.79	20.97	Pass
39	2441	4.18	20.97	Pass
78	2480	5.69	20.97	Pass

Note: For AFH mode using 20 hopping channels, the maximum output power limit is 20.97dBm.

Peak Output Power Plot on Channel 00

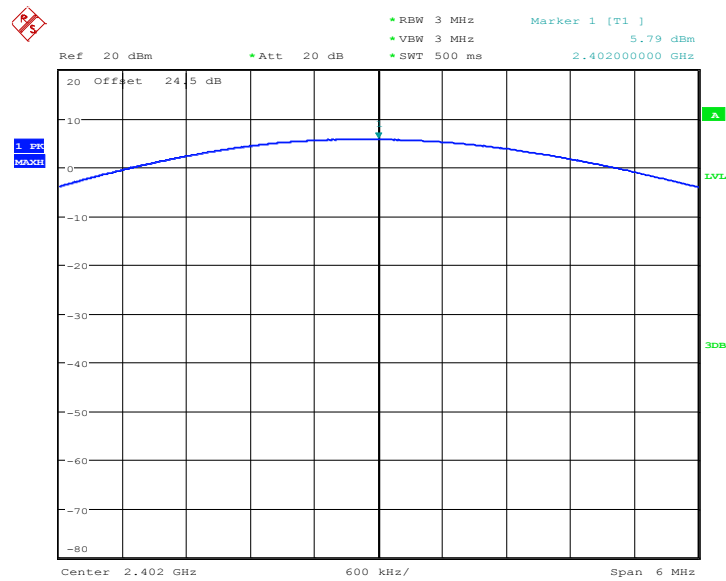

Date: 26.DEC.2012 16:35:20



Peak Output Power Plot on Channel 39

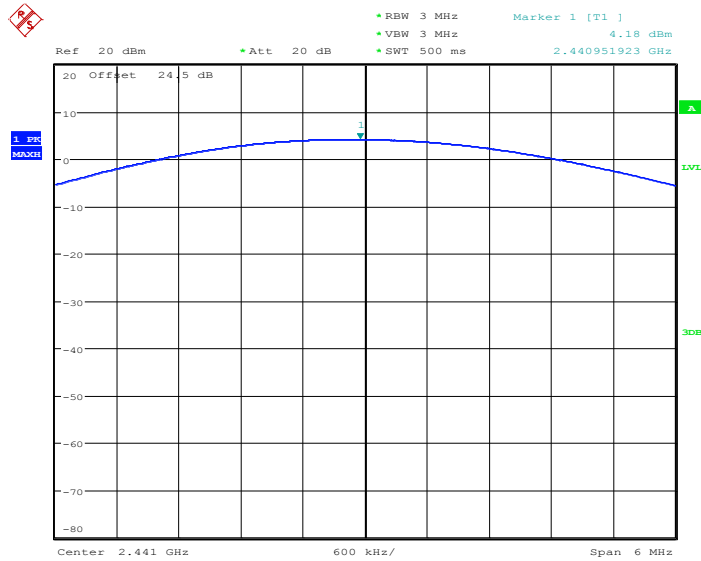

Date: 26.DEC.2012 16:36:33

Peak Output Power Plot on Channel 78

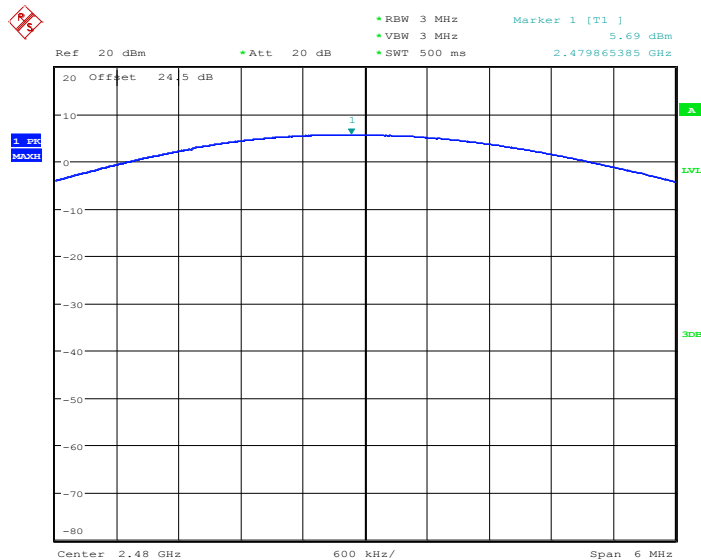

Date: 26.DEC.2012 16:37:46



Test Mode :	2Mbps	Temperature :	24~26°C
Test Engineer :	Coyote Lin	Relative Humidity :	50~53%

Channel	Frequency (MHz)	RF Power (dBm)		
		$\pi/4$ -DQPSK	Max. Limits (dBm)	Pass/Fail
		2 Mbps		
00	2402	4.93	20.97	Pass
39	2441	3.38	20.97	Pass
78	2480	4.89	20.97	Pass

Peak Output Power Plot on Channel 00

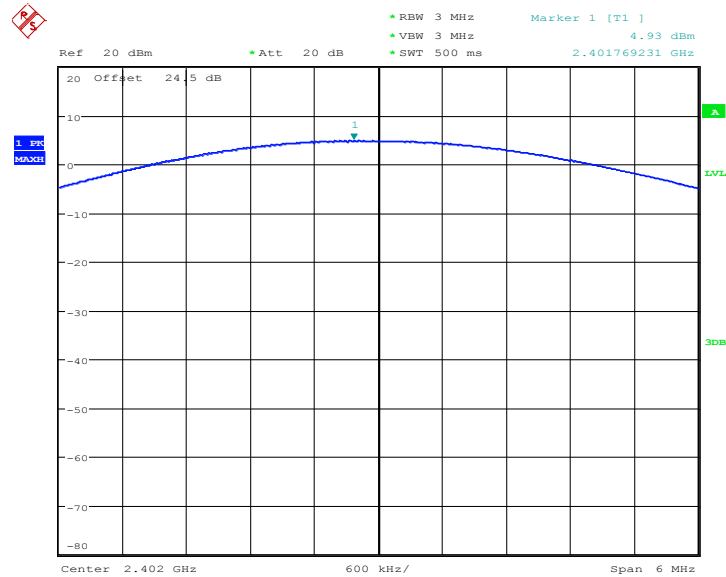

Date: 26.DEC.2012 16:36:01



Peak Output Power Plot on Channel 39

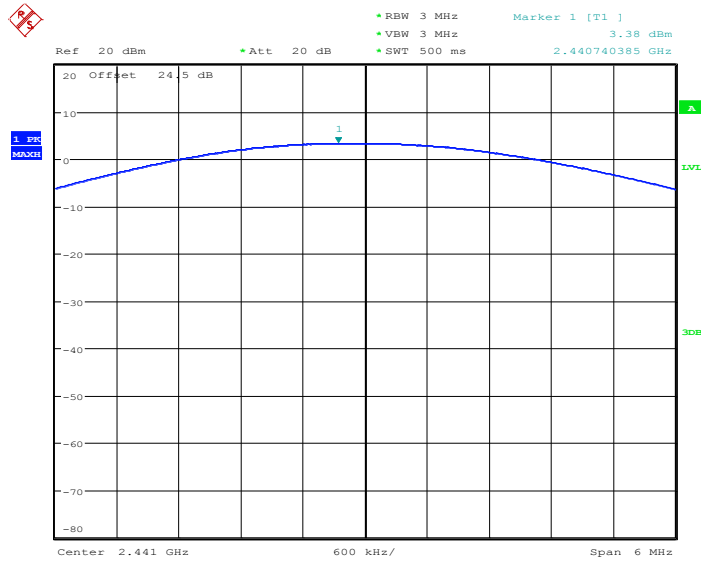

Date: 26.DEC.2012 16:37:13

Peak Output Power Plot on Channel 78

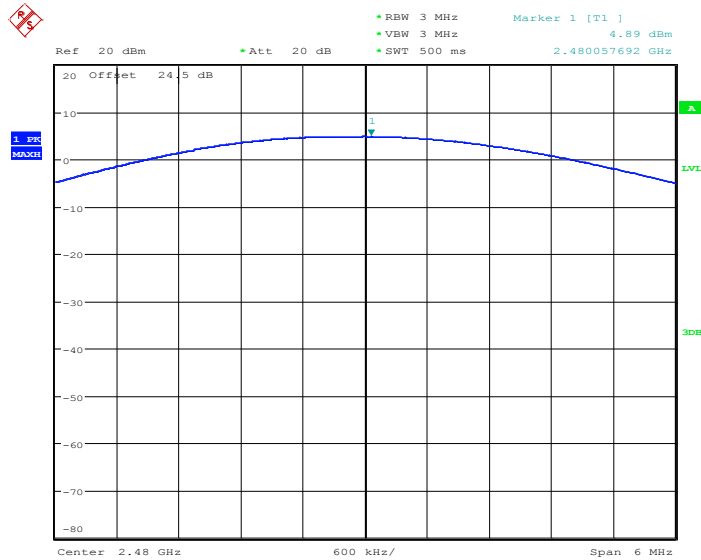

Date: 26.DEC.2012 16:38:26



Test Mode :	3Mbps	Temperature :	24~26°C
Test Engineer :	Coyote Lin	Relative Humidity :	50~53%

Channel	Frequency (MHz)	RF Power (dBm)		
		8-DPSK	Max. Limits (dBm)	Pass/Fail
		3 Mbps		
00	2402	5.14	20.97	Pass
39	2441	3.75	20.97	Pass
78	2480	5.14	20.97	Pass

Peak Output Power Plot on Channel 00

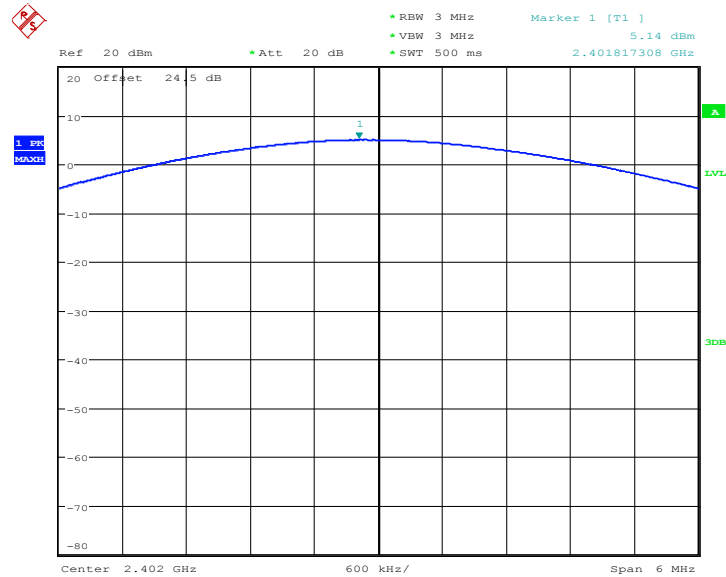

Date: 26.DEC.2012 16:36:09



Peak Output Power Plot on Channel 39

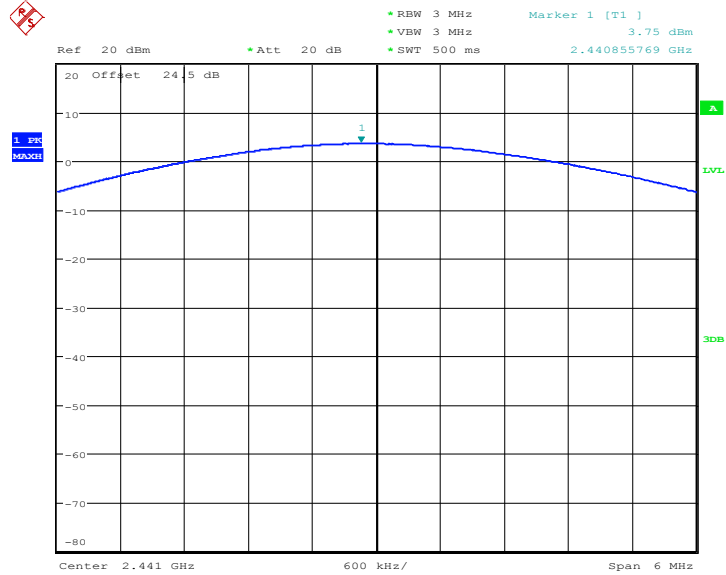

Date: 26.DEC.2012 16:37:22

Peak Output Power Plot on Channel 78

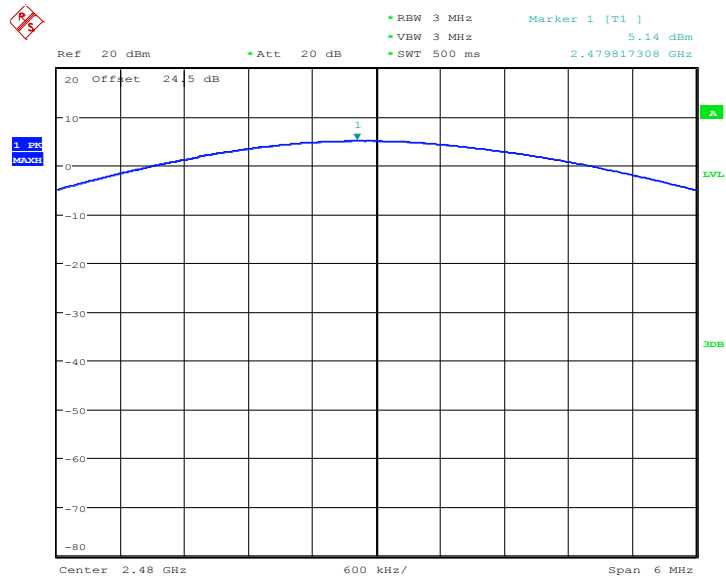

Date: 26.DEC.2012 16:38:34

3.6 Conducted Band Edges Measurement

3.6.1 Limit of Band Edges

In any 100 kHz bandwidth outside the intentional radiation frequency band, the radio frequency power shall be at least 20 dB below the highest level of the radiated power. In addition, radiated emissions which fall in the restricted bands must also comply with the radiated emission limits.

3.6.2 Measuring Instruments

See list of measuring instruments of this test report.

3.6.3 Test Procedures

1. The testing follows the guidelines in Band-edge Compliance of RF Conducted Emissions of FCC Public Notice DA 00-705 Measurement Guidelines.
2. Set to the maximum power setting and enable the EUT transmit continuously.
3. Set RBW = 300kHz ($\geq 1\%$ span=30MHz), VBW = 300kHz (\geq RBW). Band edge emissions must be at least 20 dB down from the highest emission level within the authorized band as measured with a 300kHz RBW. The attenuation shall be 30 dB instead of 20 dB when RMS conducted output power procedure is used.
4. Enable hopping function of the EUT and then repeat step 2. and 3.
5. Measure and record the results in the test report.

3.6.4 Test Setup

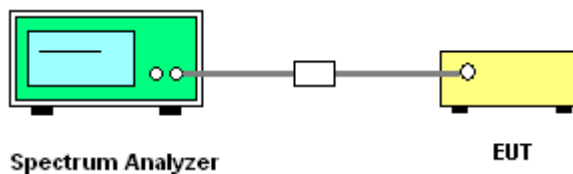



3.6.5 Test Result of Conducted Band Edges

Test Mode :	1Mbps	Temperature :	24~26°C
Test Channel :	00 and 78	Relative Humidity :	50~53%
		Test Engineer :	Coyote Lin

Low Band Edge Plot on Channel 00

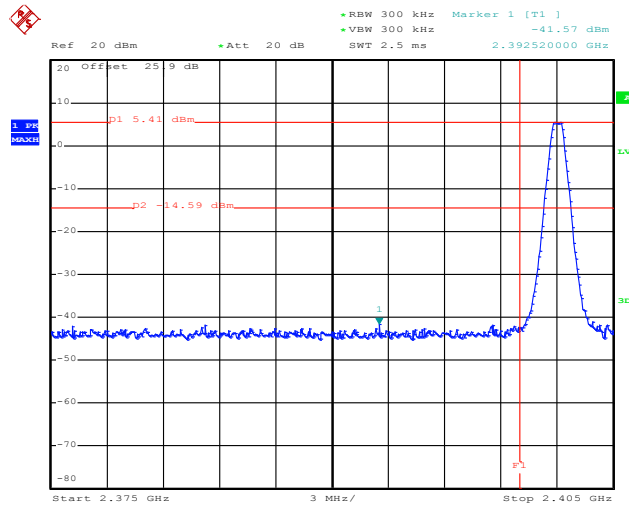

Date: 20.DEC.2012 16:56:58

High Band Edge Plot on Channel 78

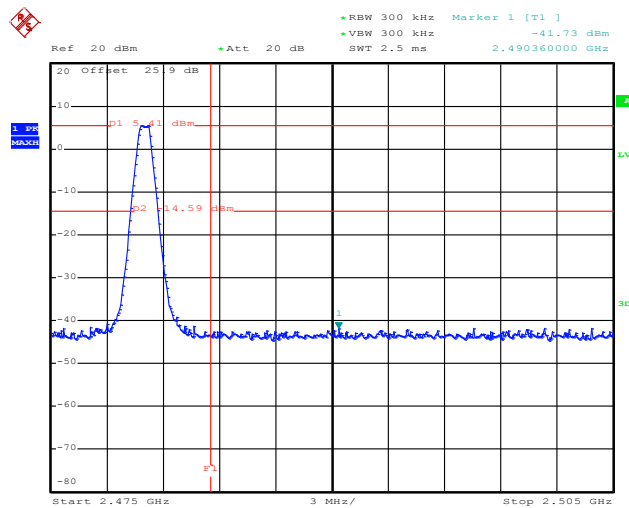

Date: 20.DEC.2012 15:49:34



Test Mode :	2Mbps	Temperature :	24~26°C
Test Channel :	00 and 78	Relative Humidity :	50~53%
		Test Engineer :	Coyote Lin

Low Band Edge Plot on Channel 00

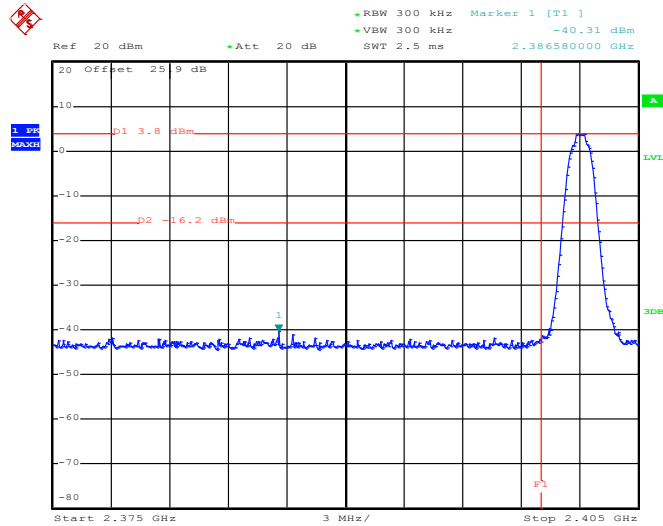

Date: 20.DEC.2012 15:50:26

High Band Edge Plot on Channel 78

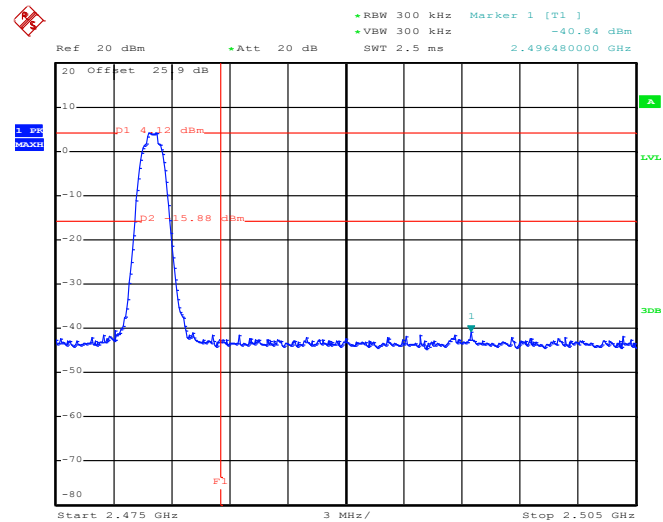

Date: 20.DEC.2012 15:51:29



Test Mode :	3Mbps	Temperature :	24~26°C
Test Channel :	00 and 78	Relative Humidity :	50~53%
		Test Engineer :	Coyote Lin

Low Band Edge Plot on Channel 00

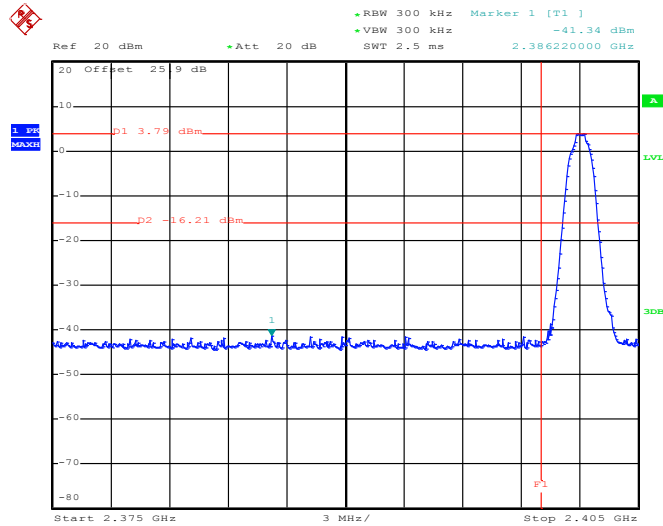

Date: 20.DEC.2012 15:52:21

High Band Edge Plot on Channel 78

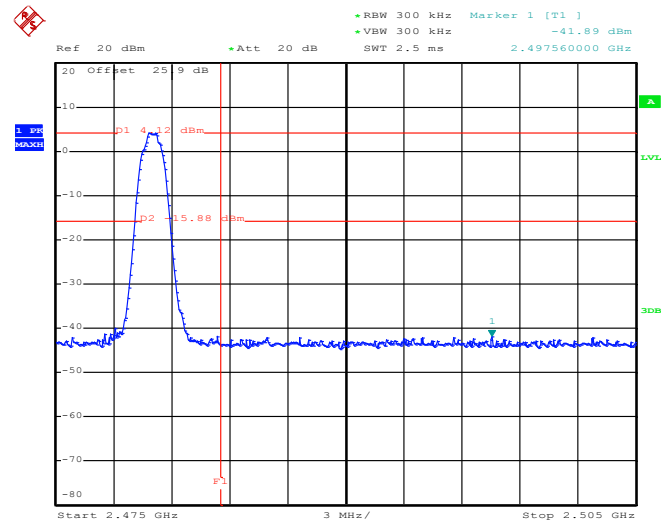

Date: 20.DEC.2012 15:53:24

3.6.6 Test Result of Conducted Hopping Mode Band Edges

Test Mode :	1Mbps	Temperature :	24~26°C
Test Engineer :	Coyote Lin	Relative Humidity :	50~53%

1Mbps Hopping Mode Low Band Edge Plot

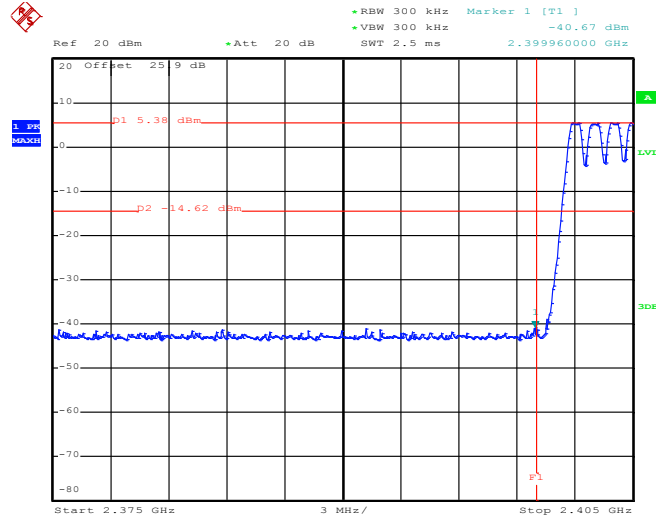

Date: 20.DEC.2012 17:08:10

1Mbps Hopping Mode High Band Edge Plot

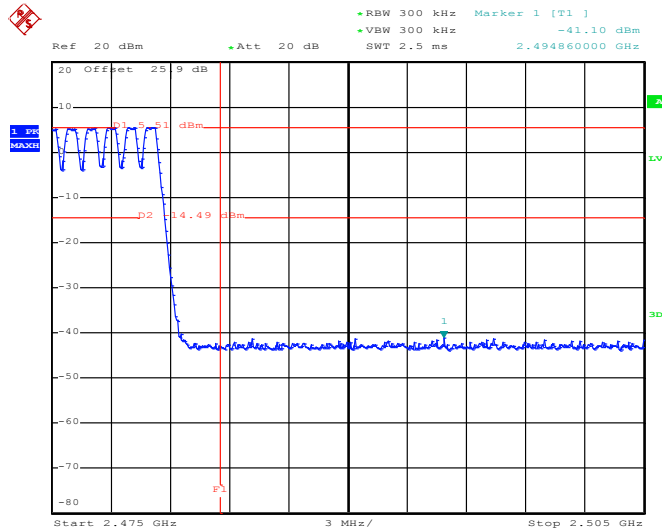

Date: 20.DEC.2012 17:11:31



Test Mode :	2Mbps	Temperature :	24~26°C
Test Engineer :	Coyote Lin	Relative Humidity :	50~53%

2Mbps Hopping Mode Low Band Edge Plot

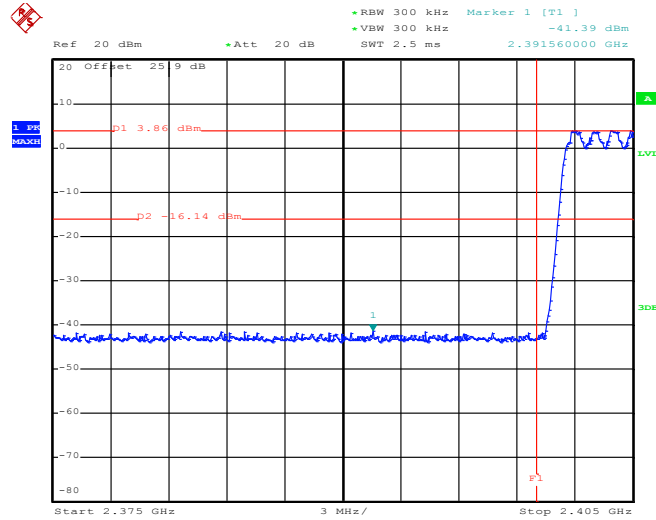

Date: 20.DEC.2012 17:16:52

2Mbps Hopping Mode High Band Edge Plot

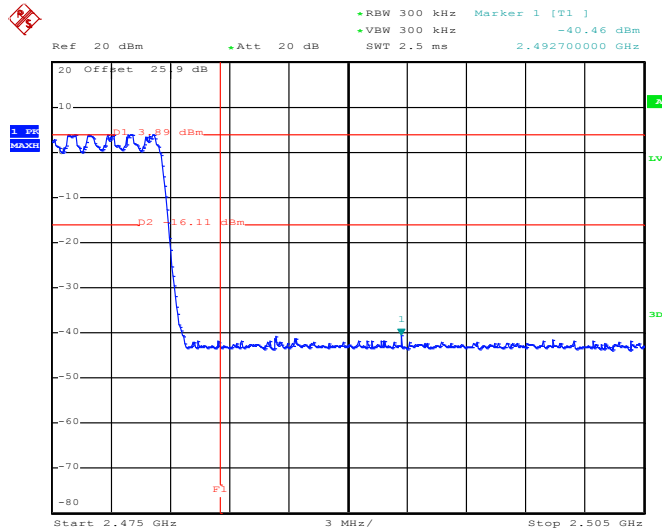

Date: 20.DEC.2012 17:14:43



Test Mode :	3Mbps	Temperature :	24~26°C
Test Engineer :	Coyote Lin	Relative Humidity :	50~53%

3Mbps Hopping Mode Low Band Edge Plot

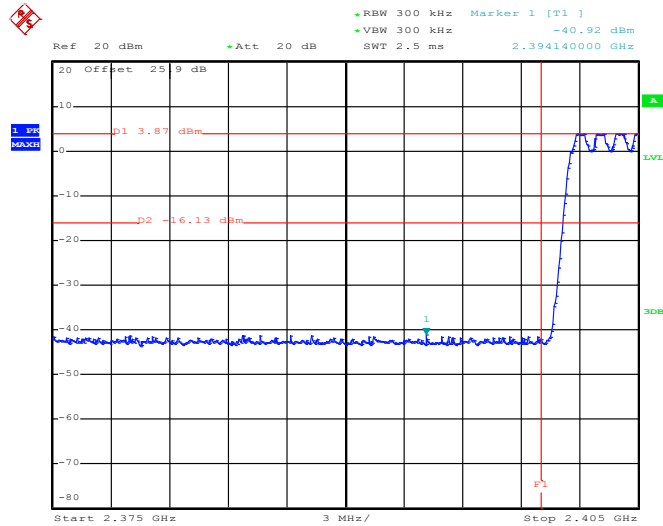

Date: 20.DEC.2012 17:23:18

3Mbps Hopping Mode High Band Edge Plot

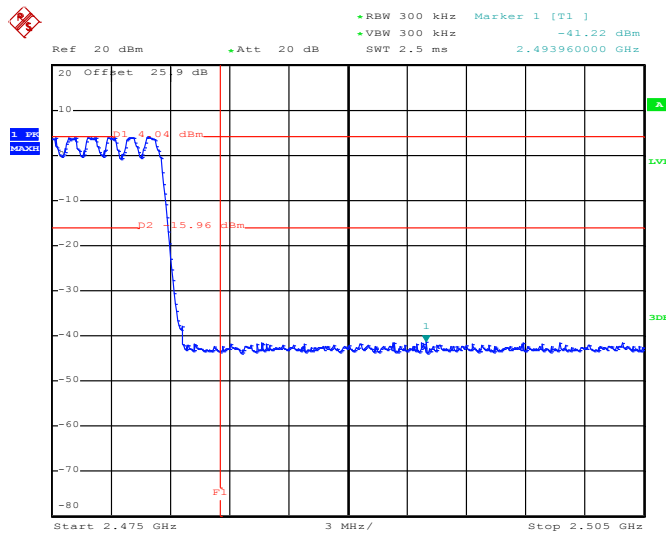

Date: 20.DEC.2012 17:27:50

3.7 Conducted Spurious Emission Measurement

3.7.1 Limit of Spurious Emission Measurement

In any 100 kHz bandwidth outside the intentional radiation frequency band, the radio frequency power shall be at least 20 dB below the highest level of the radiated power. In addition, radiated emissions which fall in the restricted bands must also comply with the radiated emission limits.

3.7.2 Measuring Instruments

See list of measuring instruments of this test report.

3.7.3 Test Procedure

1. The testing follows the guidelines in Spurious RF Conducted Emissions of FCC Public Notice DA 00-705 Measurement Guidelines
2. The RF output of EUT was connected to the spectrum analyzer by RF cable and attenuator. The path loss was compensated to the results for each measurement.
3. Set to the maximum power setting and enable the EUT transmit continuously.
4. Set RBW = 100 kHz, VBW = 300kHz, scan up through 10th harmonic. All harmonics / spurs must be at least 20 dB down from the highest emission level within the authorized band as measured with a 100 kHz RBW.
5. Measure and record the results in the test report.
6. The RF fundamental frequency should be excluded against the limit line in the operating frequency band.

3.7.4 Test Setup

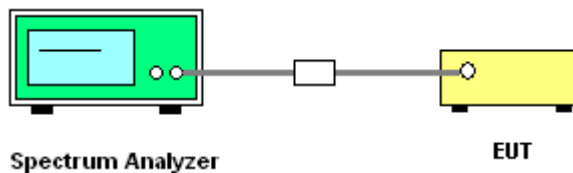



3.7.5 Test Result

Test Mode :	1Mbps	Temperature :	24~26°C
Test Channel :	00	Relative Humidity :	50~53%
		Test Engineer :	Coyote Lin

1Mbps CSE Plot on Ch 00 between 30MHz ~ 3 GHz

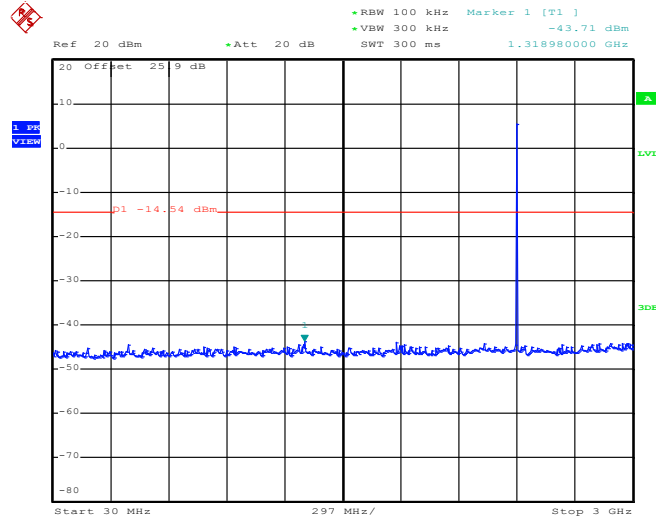

Date: 20.DEC.2012 15:59:44

1Mbps CSE Plot on Ch 00 between 2 GHz ~ 25 GHz

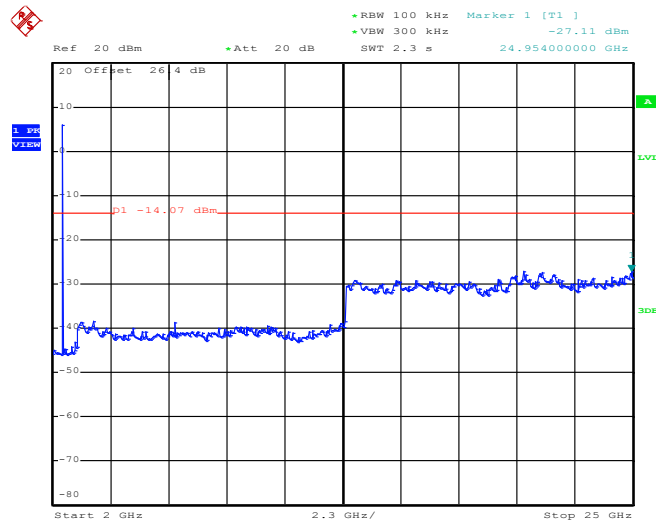

Date: 20.DEC.2012 16:00:36



Test Mode :	1Mbps	Temperature :	24~26°C
Test Channel :	39	Relative Humidity :	50~53%
		Test Engineer :	Coyote Lin

1Mbps CSE Plot on Ch 39 between 30MHz ~ 3 GHz

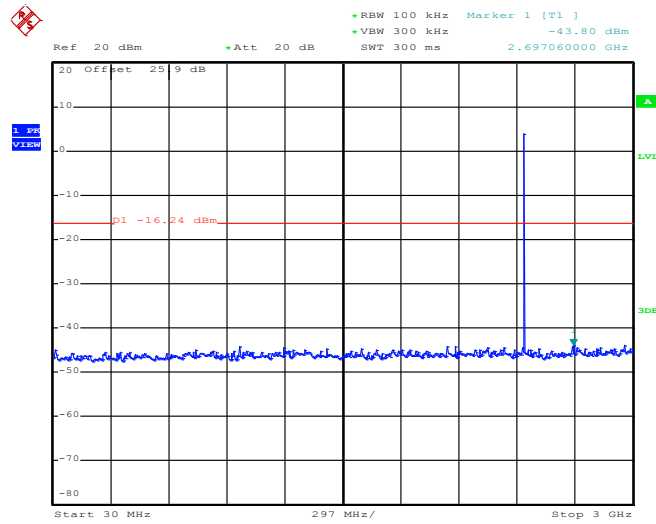

Date: 20.DEC.2012 16:01:28

1Mbps CSE Plot on Ch 39 Plot between 2 GHz ~ 25 GHz

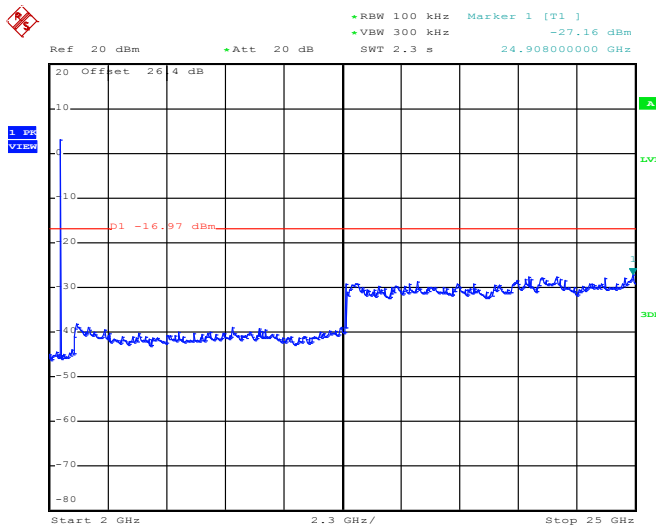

Date: 20.DEC.2012 16:02:20



Test Mode :	1Mbps	Temperature :	24~26°C
Test Channel :	78	Relative Humidity :	50~53%
		Test Engineer :	Coyote Lin

1Mbps CSE Plot on Ch 78 Plot between 30MHz ~ 3 GHz

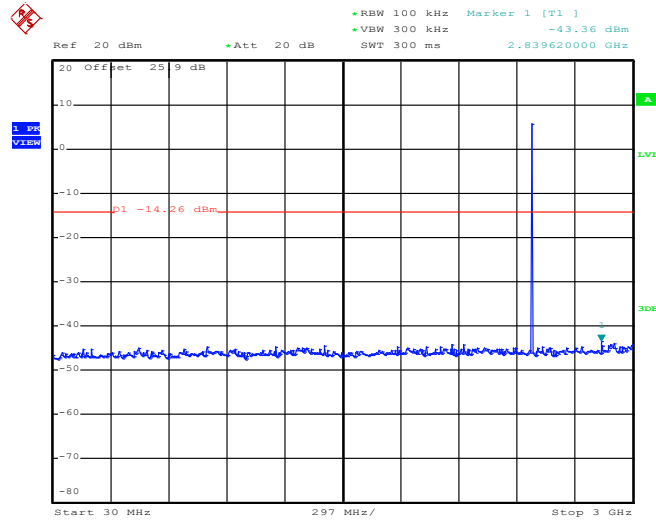

Date: 20.DEC.2012 16:03:13

1Mbps CSE Plot on Ch 78 Plot between 2 GHz ~ 25 GHz

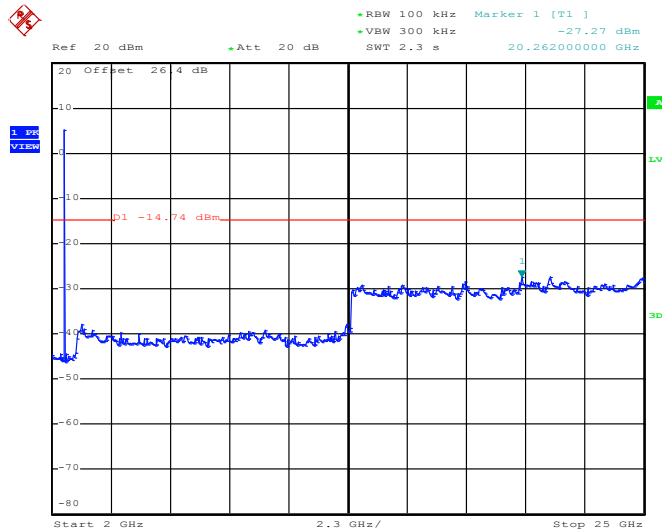

Date: 20.DEC.2012 16:04:05



Test Mode :	2Mbps	Temperature :	24~26°C
Test Channel :	00	Relative Humidity :	50~53%
		Test Engineer :	Coyote Lin

2Mbps CSE Plot on Ch 00 Plot between 30MHz ~ 3 GHz

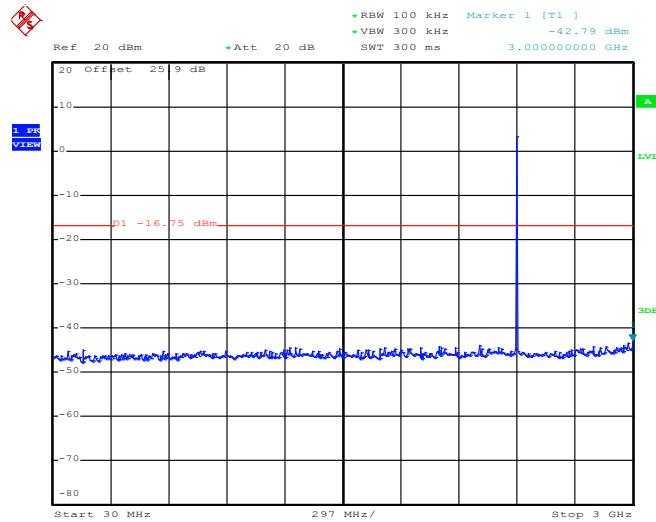

Date: 20.DEC.2012 16:46:14

2Mbps CSE Plot on Ch 00 Plot between 2 GHz ~ 25 GHz

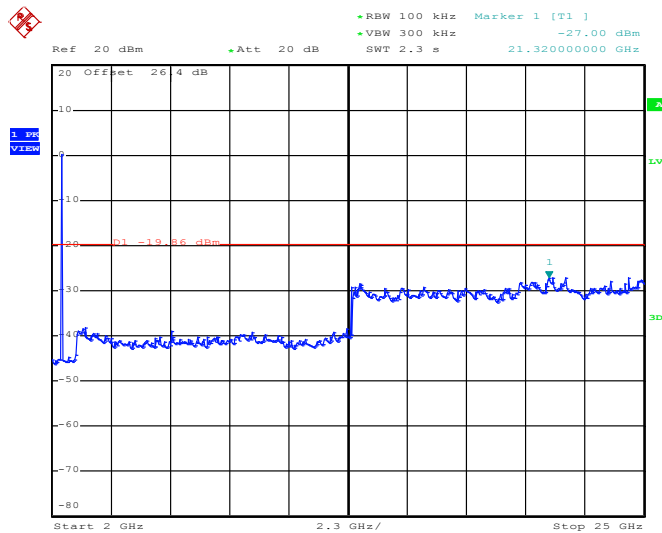

Date: 20.DEC.2012 16:47:06



Test Mode :	2Mbps	Temperature :	24~26°C
Test Channel :	39	Relative Humidity :	50~53%
		Test Engineer :	Coyote Lin

2Mbps CSE Plot on Ch 39 Plot between 30MHz ~ 3 GHz

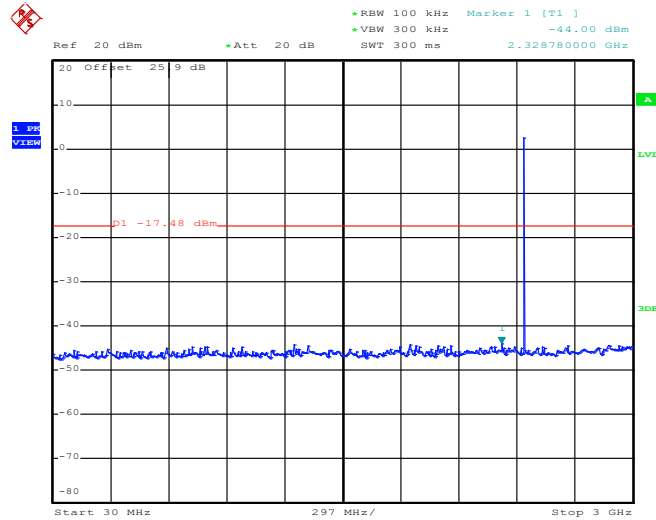

Date: 20.DEC.2012 16:47:59

2Mbps CSE Plot on Ch 39 Plot between 2 GHz ~ 25 GHz

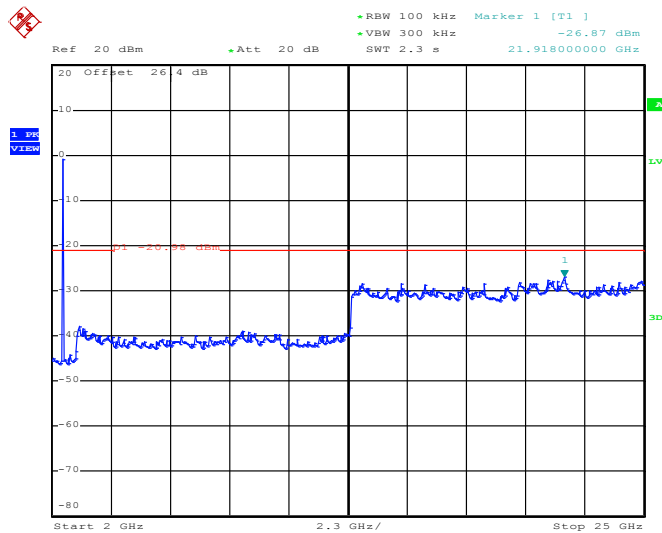

Date: 20.DEC.2012 16:48:51



Test Mode :	2Mbps	Temperature :	24~26°C
Test Channel :	78	Relative Humidity :	50~53%
		Test Engineer :	Coyote Lin

2Mbps CSE Plot on Ch 78 Plot between 30MHz ~ 3 GHz

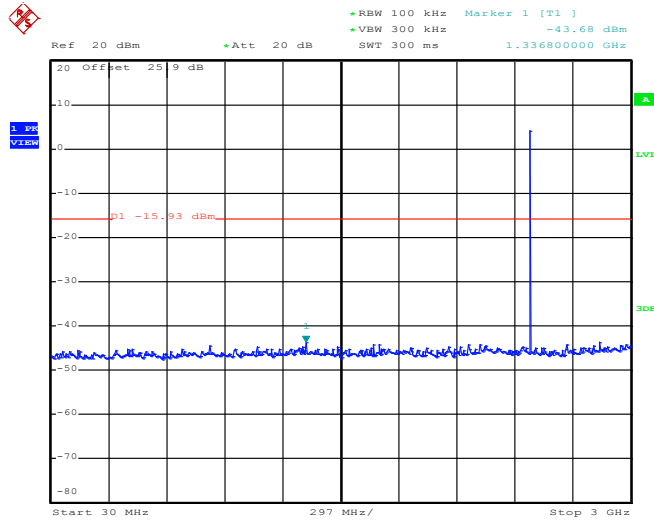

Date: 20.DEC.2012 16:49:43

2Mbps CSE Plot on Ch 78 between 2 GHz ~ 25 GHz

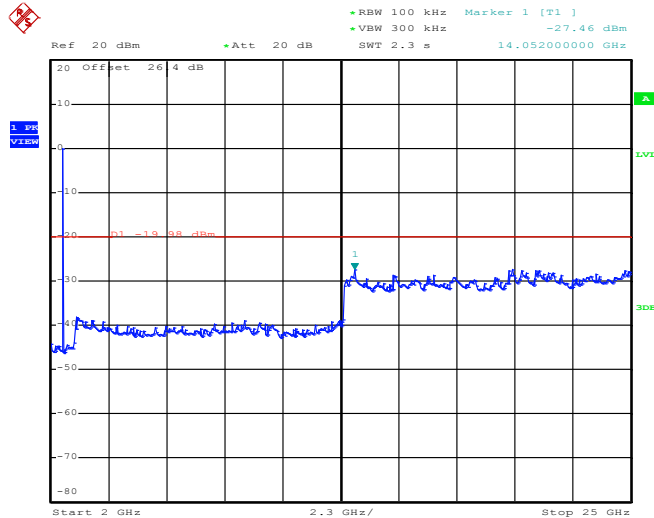

Date: 20.DEC.2012 16:50:35



Test Mode :	3Mbps	Temperature :	24~26°C
Test Channel :	00	Relative Humidity :	50~53%
		Test Engineer :	Coyote Lin

3Mbps CSE Plot on Ch 00 Plot between 30MHz ~ 3 GHz

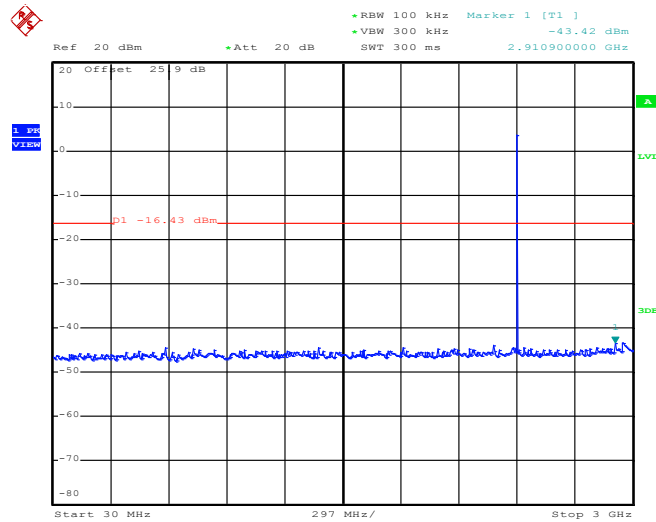

Date: 20.DEC.2012 16:51:46

3Mbps CSE Plot on Ch 00 Plot between 2 GHz ~ 25 GHz

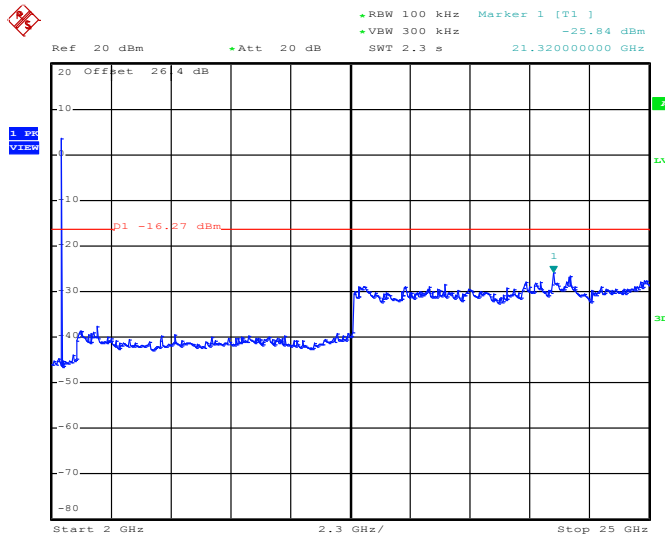

Date: 20.DEC.2012 16:52:38



Test Mode :	3Mbps	Temperature :	24~26°C
Test Channel :	39	Relative Humidity :	50~53%
		Test Engineer :	Coyote Lin

3Mbps CSE Plot on Ch 39 Plot between 30MHz ~ 3 GHz

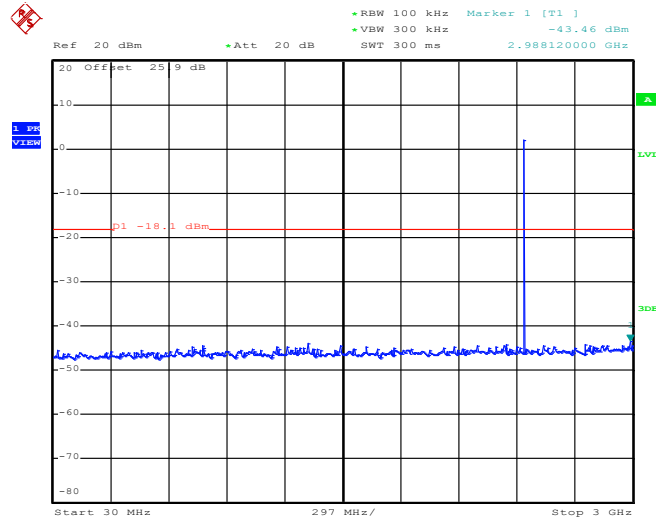

Date: 20.DEC.2012 16:53:30

3Mbps CSE Plot on Ch 39 Plot between 2 GHz ~ 25 GHz

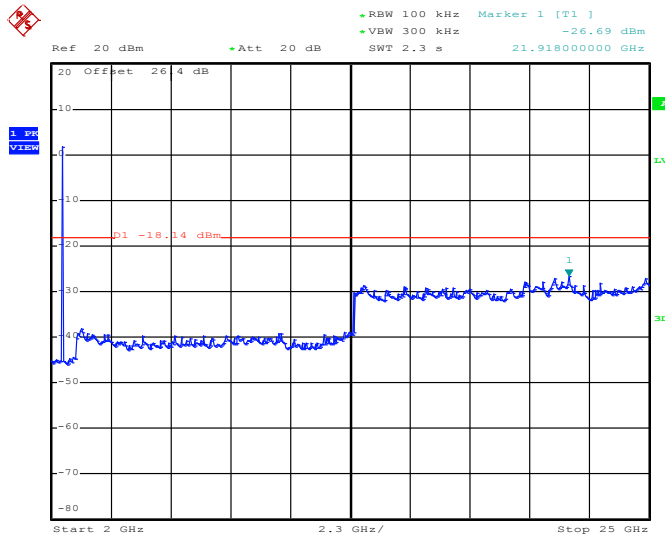

Date: 20.DEC.2012 16:54:22



Test Mode :	3Mbps	Temperature :	24~26°C
Test Channel :	78	Relative Humidity :	50~53%
		Test Engineer :	Coyote Lin

3Mbps CSE Plot on Ch 78 Plot between 30MHz ~ 3 GHz

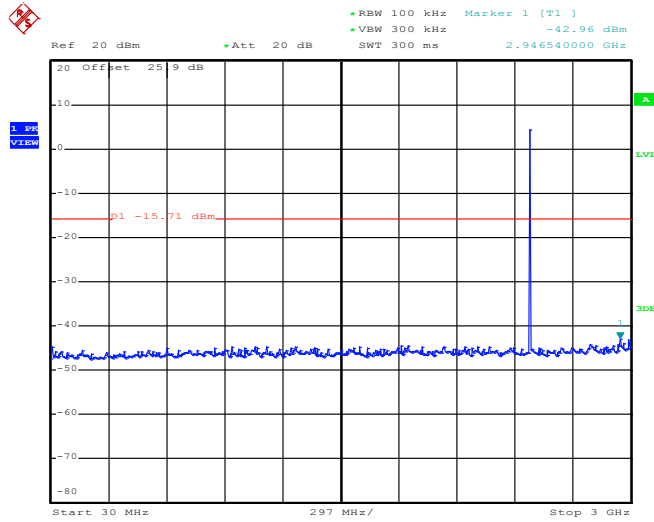

Date: 20.DEC.2012 16:55:14

3Mbps CSE Plot on Ch 78 Plot between 2 GHz ~ 25 GHz

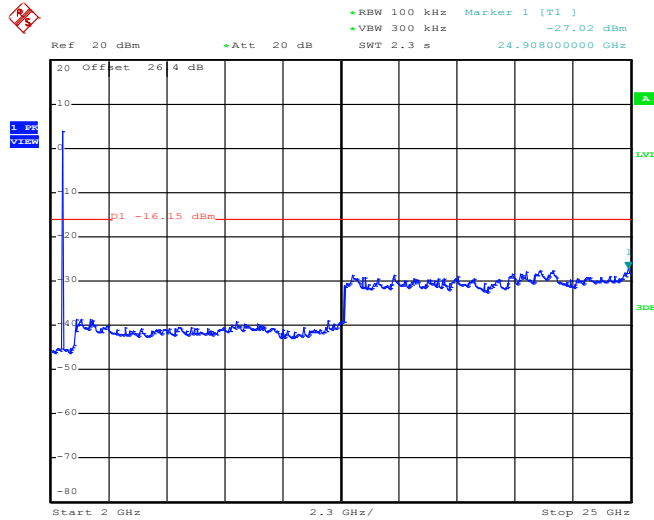

Date: 20.DEC.2012 16:56:07



3.8 Radiated Band Edges and Spurious Emission Measurement

3.8.1 Limit of Radiated Band Edges and Spurious Emission

In any 100 kHz bandwidth outside the intentional radiator frequency band, all harmonics/spurious must be at least 20 dB below the highest emission level within the authorized band. In addition, radiated emissions which fall in the restricted bands must also comply with the FCC section 15.209 limits as below.

Frequency (MHz)	Field Strength (microvolts/meter)	Measurement Distance (meters)
0.009 – 0.490	2400/F(kHz)	300
0.490 – 1.705	24000/F(kHz)	30
1.705 – 30.0	30	30
30 – 88	100	3
88 – 216	150	3
216 - 960	200	3
Above 960	500	3

3.8.2 Measuring Instruments

See list of measuring instruments of this test report.



3.8.3 Test Procedures

1. The testing follows the guidelines in Spurious Radiated Emissions of FCC Public Notice DA 00-705 Measurement Guidelines and the guidelines in ANSI C63.10-2009.
2. The EUT was placed on a turntable with 0.8 meter above ground.
3. The EUT was set 3 meters from the interference receiving antenna, which was mounted on the top of a variable height antenna tower.
4. For each suspected emission, the EUT was arranged to its worst case and then tune the Antenna tower (from 1 m to 4 m) and turntable (from 0 degree to 360 degrees) to find the maximum reading. A pre-amp and a high pass filter are used for the test in order to get better signal level to comply with the guidelines.
5. Set to the maximum power setting and enable the EUT transmit continuously.
6. Use the following spectrum analyzer settings:
 - (1) Span shall wide enough to fully capture the emission being measured;
 - (2) Set RBW=100 kHz for $f < 1$ GHz, RBW=1MHz for $f > 1$ GHz ; VBW \geq RBW; Sweep = auto; Detector function = peak; Trace = max hold for peak
 - (3) For average measurement: use duty cycle correction factor method per 15.35(c).
Duty cycle = On time/100 milliseconds
On time = $N_1 * L_1 + N_2 * L_2 + \dots + N_{n-1} * L_{n-1} + N_n * L_n$
Where N_1 is number of type 1 pulses, L_1 is length of type 1 pulses, etc.
Average Emission Level = Peak Emission Level + $20 * \log(\text{Duty cycle})$
7. Corrected Reading: Antenna Factor + Cable Loss + Read Level - Preamp Factor = Level

Note: The average levels were calculated from the peak level corrected with duty cycle correction factor (24.85dB) derived from $20 \log (\text{dwell time}/100\text{ms})$.

3.8.4 Test Setup

For radiated emissions below 30MHz

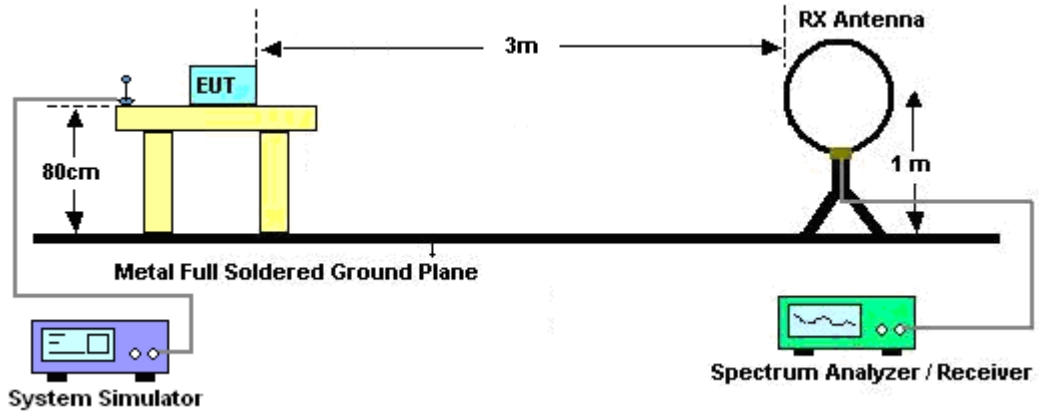

For radiated emissions from 30MHz to 1GHz

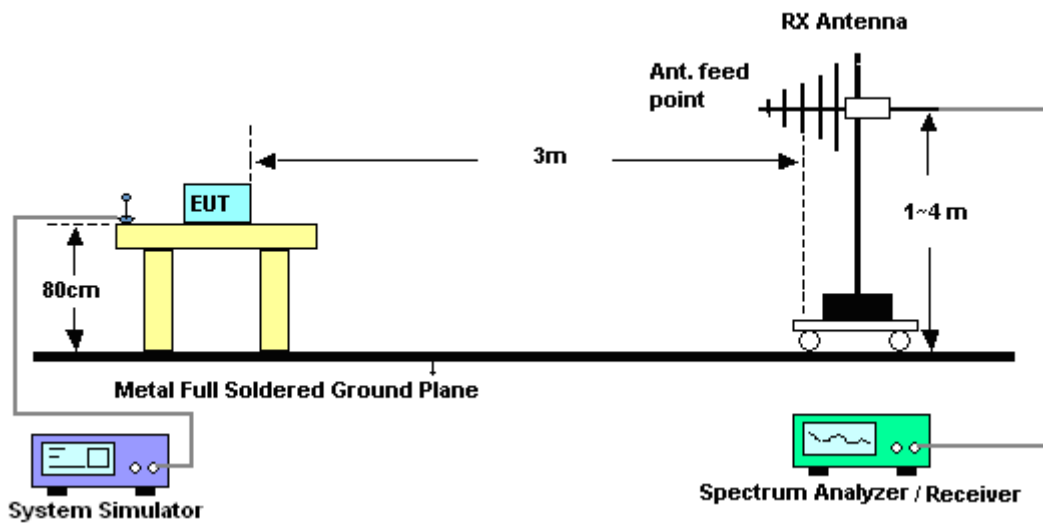

For radiated emissions above 1GHz

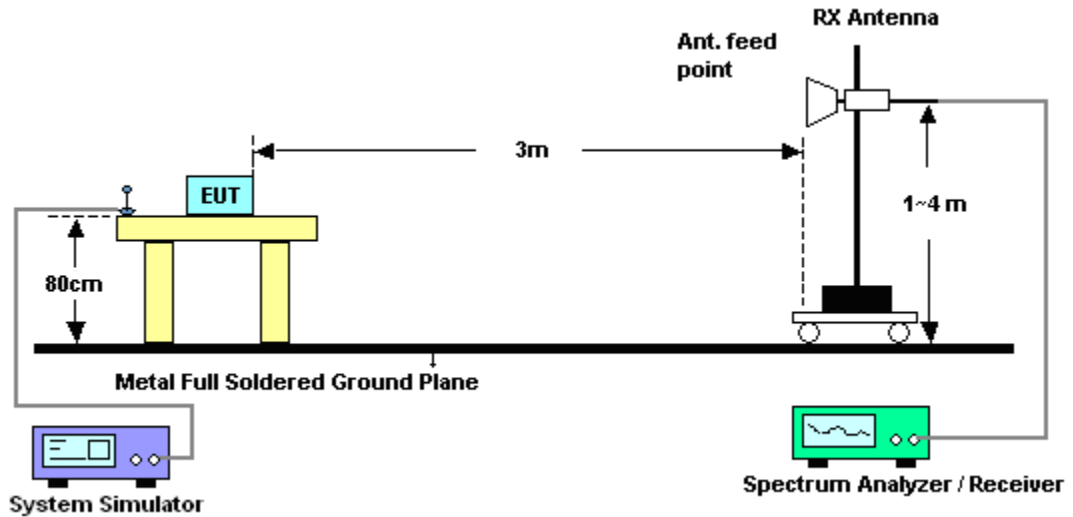

3.8.5 Test Results of Radiated Emissions (9 kHz ~ 30 MHz)

The low frequency, which started from 9 kHz to 30MHz, was pre-scanned and the result which was 20dB lower than the limit line per 15.31(o) was not reported.

3.8.6 Duty cycle correction factor for average measurement

DH5 on time/100ms (One Pulse) Plot on Channel 39

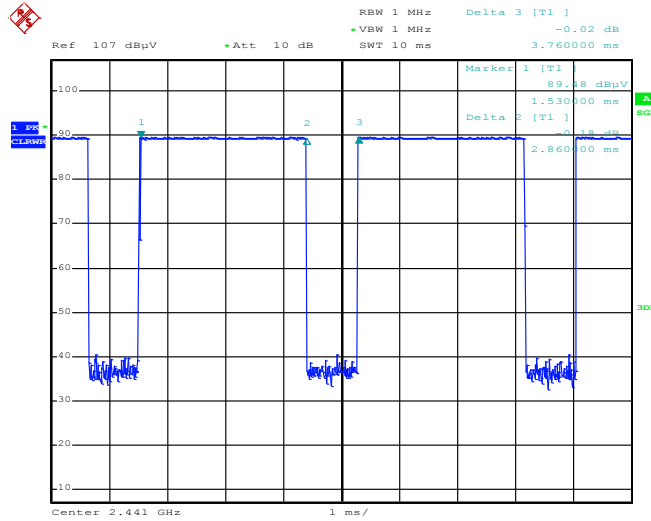

Date: 14.JAN.2013 14:02:47

DH5 on time/100ms (Count Pulses) Plot on Channel 39

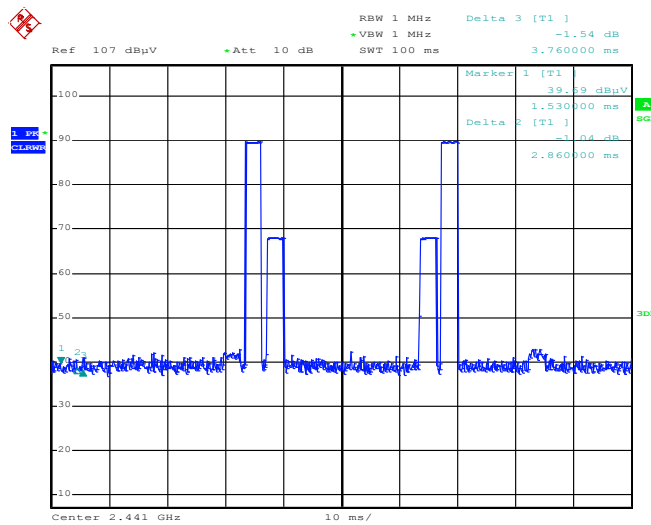

Date: 14.JAN.2013 14:03:49

Note:

1. Worst case Duty cycle = on time/100 milliseconds = $2 * 2.86 / 100 = 5.72 \%$
2. Worst case Duty cycle correction factor = $20 * \log(\text{Duty cycle}) = -24.85 \text{ dB}$
3. DH5 has the highest duty cycle worst case and is reported.



Duty Cycle Correction Factor Consideration for AFH mode:

Bluetooth normal hopping rate is 1600Hz and reduced to 800Hz in AFH mode; due to the reduced number of hopping frequencies, with the same packet configuration the dwell time in each channel frequency within 100msec period is longer in AFH mode than normal mode.

In AFH mode, the minimum hopping frequencies are 20, to get the longest dwell time DH5 packet is observed; the period to have DH5 packet completing one hopping sequence is

$$2.86ms \times 20 \text{ channels} = 57.2ms$$

There cannot be 2 complete hopping sequences within 100ms period, considering the random hopping behavior, maximum 2 hops can be possibly observed within the period. $[100ms / 57.6ms] = 2$ hops

Thus, the maximum possible ON time:

$$2.86ms \times 2 = 5.72ms$$

Worst case Duty Cycle Correction factor, which is derived from the maximum possible ON time,

$$20 \times \log(5.72ms/100ms) = -24.85 \text{ dB}$$



3.8.7 Test Result of Radiated Band Edges

Test Mode :	1Mbps	Temperature :	23~24°C
Test Channel :	00	Relative Humidity :	47~49%
		Test Engineer :	Kai Wang and Timberland Lin

ANTENNA POLARITY : HORIZONTAL										
Frequency (MHz)	Level (dBμV/m)	Over Limit (dB)	Limit Line (dBμV/m)	Read Level (dBμV)	Antenna Factor (dB)	Cable Loss (dB)	Preamp Factor (dB)	Ant Pos (cm)	Table Pos (deg)	Remark
2385.87	48.39	-25.61	74	44.14	32.36	6.45	34.56	122	349	Peak
2385.87	23.54	-30.46	54	-	-	-	-	-	-	Average

ANTENNA POLARITY : VERTICAL										
Frequency (MHz)	Level (dBμV/m)	Over Limit (dB)	Limit Line (dBμV/m)	Read Level (dBμV)	Antenna Factor (dB)	Cable Loss (dB)	Preamp Factor (dB)	Ant Pos (cm)	Table Pos (deg)	Remark
2385.87	48.07	-25.93	74	43.82	32.36	6.45	34.56	108	5	Peak
2385.87	23.22	-30.78	54	-	-	-	-	-	-	Average

Test Mode :	1Mbps	Temperature :	23~24°C
Test Channel :	78	Relative Humidity :	47~49%
		Test Engineer :	Kai Wang and Timberland Lin

ANTENNA POLARITY : HORIZONTAL										
Frequency (MHz)	Level (dBμV/m)	Over Limit (dB)	Limit Line (dBμV/m)	Read Level (dBμV)	Antenna Factor (dB)	Cable Loss (dB)	Preamp Factor (dB)	Ant Pos (cm)	Table Pos (deg)	Remark
2483.5	67.13	-6.87	74	62.61	32.48	6.59	34.55	119	350	Peak
2483.5	42.28	-11.72	54	-	-	-	-	-	-	Average

ANTENNA POLARITY : VERTICAL										
Frequency (MHz)	Level (dBμV/m)	Over Limit (dB)	Limit Line (dBμV/m)	Read Level (dBμV)	Antenna Factor (dB)	Cable Loss (dB)	Preamp Factor (dB)	Ant Pos (cm)	Table Pos (deg)	Remark
2483.5	63.29	-10.71	74	58.77	32.48	6.59	34.55	100	62	Peak
2483.5	38.44	-15.56	54	-	-	-	-	-	-	Average



3.8.8 Test Result of Radiated Emission (30 MHz ~ 10th Harmonic)

Test Mode :	1Mbps	Temperature :	23~24°C
Test Channel :	00	Relative Humidity :	47~49%
Test Engineer :	Kai Wang and Timberland Lin	Polarization :	Horizontal
Remark :	1. 2403 MHz is fundamental signal which can be ignored. 2. 2399 and 7206 MHz are not within a restricted band, and its limit line is 20dB below the highest emission level. For example, 106.13 dBμV/m - 20dB = 86.13 dBμV/m.		

Frequency (MHz)	Level (dBμV/m)	Over Limit (dB)	Limit Line (dBμV/m)	Read Level (dBμV)	Antenna Factor (dB)	Cable Loss (dB)	Preamp Factor (dB)	Ant Pos (cm)	Table Pos (deg)	Remark
2399	67.91	-18.22	86.13	63.66	32.36	6.45	34.56	122	349	Peak
2403	106.13	-	-	101.86	32.38	6.45	34.56	122	349	Peak
2403	81.28	-	-	-	-	-	-	-	-	Average
4806	49.45	-24.55	74	59.96	34.88	10.17	55.56	100	0	Peak
4806	24.6	-29.4	54	-	-	-	-	-	-	Average
7206	49.19	-36.94	86.13	58.55	36.16	10.97	56.49	100	0	Peak

Note: Other harmonics are lower than background noise.



Test Mode :	1Mbps	Temperature :	23~24°C
Test Channel :	00	Relative Humidity :	47~49%
Test Engineer :	Kai Wang and Timberland Lin	Polarization :	Vertical
Remark :	1. 2403 MHz is fundamental signal which can be ignored. 2. 2399 and 7206 MHz are not within a restricted band, and its limit line is 20dB below the highest emission level.		

Frequency (MHz)	Level (dBμV/m)	Over Limit (dB)	Limit Line (dBμV/m)	Read Level (dBμV)	Antenna Factor (dB)	Cable Loss (dB)	Preamp Factor (dB)	Ant Pos (cm)	Table Pos (deg)	Remark
2399	63.45	-18.23	81.68	59.2	32.36	6.45	34.56	108	5	Peak
2403	101.68	-	-	97.41	32.38	6.45	34.56	108	5	Peak
2403	76.83	-	-	-	-	-	-	-	-	Average
4806	48.71	-25.29	74	59.22	34.88	10.17	55.56	100	0	Peak
4806	23.86	-30.14	54	-	-	-	-	-	-	Average
7206	49.55	-32.13	81.68	58.91	36.16	10.97	56.49	100	0	Peak

Note: Other harmonics are lower than background noise.



Test Mode :	1Mbps	Temperature :	23~24°C
Test Channel :	39	Relative Humidity :	47~49%
Test Engineer :	Kai Wang and Timberland Lin	Polarization :	Horizontal
Remark :	2442 MHz is fundamental signal which can be ignored.		

Frequency (MHz)	Level (dBμV/m)	Over Limit (dB)	Limit Line (dBμV/m)	Read Level (dBμV)	Antenna Factor (dB)	Cable Loss (dB)	Preamp Factor (dB)	Ant Pos (cm)	Table Pos (deg)	Remark
2442	106.66	-	-	102.27	32.43	6.52	34.56	121	349	Peak
2442	81.81	-	-	-	-	-	-	-	-	Average
4884	47.71	-26.29	74	58.35	34.85	10.19	55.68	100	0	Peak
4884	22.86	-31.14	54	-	-	-	-	-	-	Average
7323	48.69	-25.31	74	57.86	36.13	10.94	56.24	100	0	Peak
7323	23.84	-30.16	54	-	-	-	-	-	-	Average

Note: Other harmonics are lower than background noise.

Test Mode :	1Mbps	Temperature :	23~24°C
Test Channel :	39	Relative Humidity :	47~49%
Test Engineer :	Kai Wang and Timberland Lin	Polarization :	Vertical
Remark :	2442 MHz is fundamental signal which can be ignored.		

Frequency (MHz)	Level (dBμV/m)	Over Limit (dB)	Limit Line (dBμV/m)	Read Level (dBμV)	Antenna Factor (dB)	Cable Loss (dB)	Preamp Factor (dB)	Ant Pos (cm)	Table Pos (deg)	Remark
2442	101.83	-	-	97.44	32.43	6.52	34.56	102	5	Peak
2442	76.98	-	-	-	-	-	-	-	-	Average
4884	47.36	-26.64	74	58	34.85	10.19	55.68	100	0	Peak
4884	22.51	-31.49	54	-	-	-	-	-	-	Average
7323	48.25	-25.75	74	57.42	36.13	10.94	56.24	100	0	Peak
7323	23.4	-30.6	54	-	-	-	-	-	-	Average

Note: Other harmonics are lower than background noise.



Test Mode :	1Mbps	Temperature :	23~24°C
Test Channel :	78	Relative Humidity :	47~49%
Test Engineer :	Kai Wang and Timberland Lin	Polarization :	Horizontal
Remark :	2480 MHz is fundamental signal which can be ignored.		

Frequency (MHz)	Level (dBμV/m)	Over Limit (dB)	Limit Line (dBμV/m)	Read Level (dBμV)	Antenna Factor (dB)	Cable Loss (dB)	Preamp Factor (dB)	Ant Pos (cm)	Table Pos (deg)	Remark
51.06	25.22	-14.78	40	48.27	7.88	0.77	31.7	118	65	Peak
117.75	23.78	-19.72	43.5	41.83	12.46	1.2	31.71	-	-	Peak
197.4	20.66	-22.84	43.5	41.53	9.22	1.56	31.65	-	-	Peak
399.4	17.38	-28.62	46	31.28	15.7	2.19	31.79	-	-	Peak
648.6	18.88	-27.12	46	28.83	19.2	2.82	31.97	-	-	Peak
896.4	20.67	-25.33	46	28.44	20.56	3.29	31.62	-	-	Peak
2480	107	-	-	102.48	32.48	6.59	34.55	119	350	Peak
2480	82.15	-	-	-	-	-	-	-	-	Average
4962	46.78	-27.22	74	57.6	34.81	10.21	55.84	100	0	Peak
4962	21.93	-32.07	54	-	-	-	-	-	-	Average
7440	49.12	-24.88	74	58.11	36.11	10.9	56	100	0	Peak
7440	24.27	-29.73	54	-	-	-	-	-	-	Average

Note: Other harmonics are lower than background noise.



Test Mode :	1Mbps	Temperature :	23~24°C
Test Channel :	78	Relative Humidity :	47~49%
Test Engineer :	Kai Wang and Timberland Lin	Polarization :	Vertical
Remark :	2481 MHz is fundamental signal which can be ignored.		

Frequency (MHz)	Level (dBμV/m)	Over Limit (dB)	Limit Line (dBμV/m)	Read Level (dBμV)	Antenna Factor (dB)	Cable Loss (dB)	Preamp Factor (dB)	Ant Pos (cm)	Table Pos (deg)	Remark
30.27	33.19	-6.81	40	45.41	18.9	0.6	31.72	100	117	Peak
55.38	32.37	-7.63	40	56.64	6.6	0.8	31.67	-	-	Peak
108.3	21.39	-22.11	43.5	40	11.94	1.15	31.7	-	-	Peak
329.4	19.51	-26.49	46	35.51	13.6	1.99	31.59	-	-	Peak
678	18.16	-27.84	46	28.27	19.02	2.86	31.99	-	-	Peak
900.6	20.5	-25.5	46	28.19	20.6	3.3	31.59	-	-	Peak
2481	102.91	-	-	98.39	32.48	6.59	34.55	100	62	Peak
2481	78.06	-	-	-	-	-	-	-	-	Average
4962	47.42	-26.58	74	58.24	34.81	10.21	55.84	100	0	Peak
4962	22.57	-31.43	54	-	-	-	-	-	-	Average
7440	48.33	-25.67	74	57.32	36.11	10.9	56	100	0	Peak
7440	23.48	-30.52	54	-	-	-	-	-	-	Average

Note: Other harmonics are lower than background noise.

3.9 AC Conducted Emission Measurement

3.9.1 Limit of AC Conducted Emission

For equipment that is designed to be connected to the public utility (AC) power line, the radio frequency voltage that is conducted back onto the AC power line on any frequency or frequencies within the band 150 kHz to 30 MHz shall not exceed the limits in the following table.

Frequency of emission (MHz)	Conducted limit (dB μ V)	
	Quasi-peak	Average
0.15-0.5	66 to 56*	56 to 46*
0.5-5	56	46
5-30	60	50

*Decreases with the logarithm of the frequency.

3.9.2 Measuring Instruments

See list of measuring instruments of this test report.

3.9.3 Test Procedures

1. The test follows the guidelines in ANSI C63.10-2009 test site requirement.
2. The EUT was placed 0.4 meter from the conducting wall of the shielding room was kept at least 80 centimeters from any other grounded conducting surface.
3. Connect EUT to the power mains through a line impedance stabilization network (LISN).
4. All the support units are connecting to the other LISN.
5. The LISN provides 50 ohm coupling impedance for the measuring instrument.
6. The FCC states that a 50 ohm, 50 microhenry LISN should be used.
7. Both sides of AC line were checked for maximum conducted interference.
8. The frequency range from 150 kHz to 30 MHz was searched.
9. Set the test-receiver system to Peak Detect Function and specified bandwidth with Maximum Hold Mode.

3.9.4 Test Setup

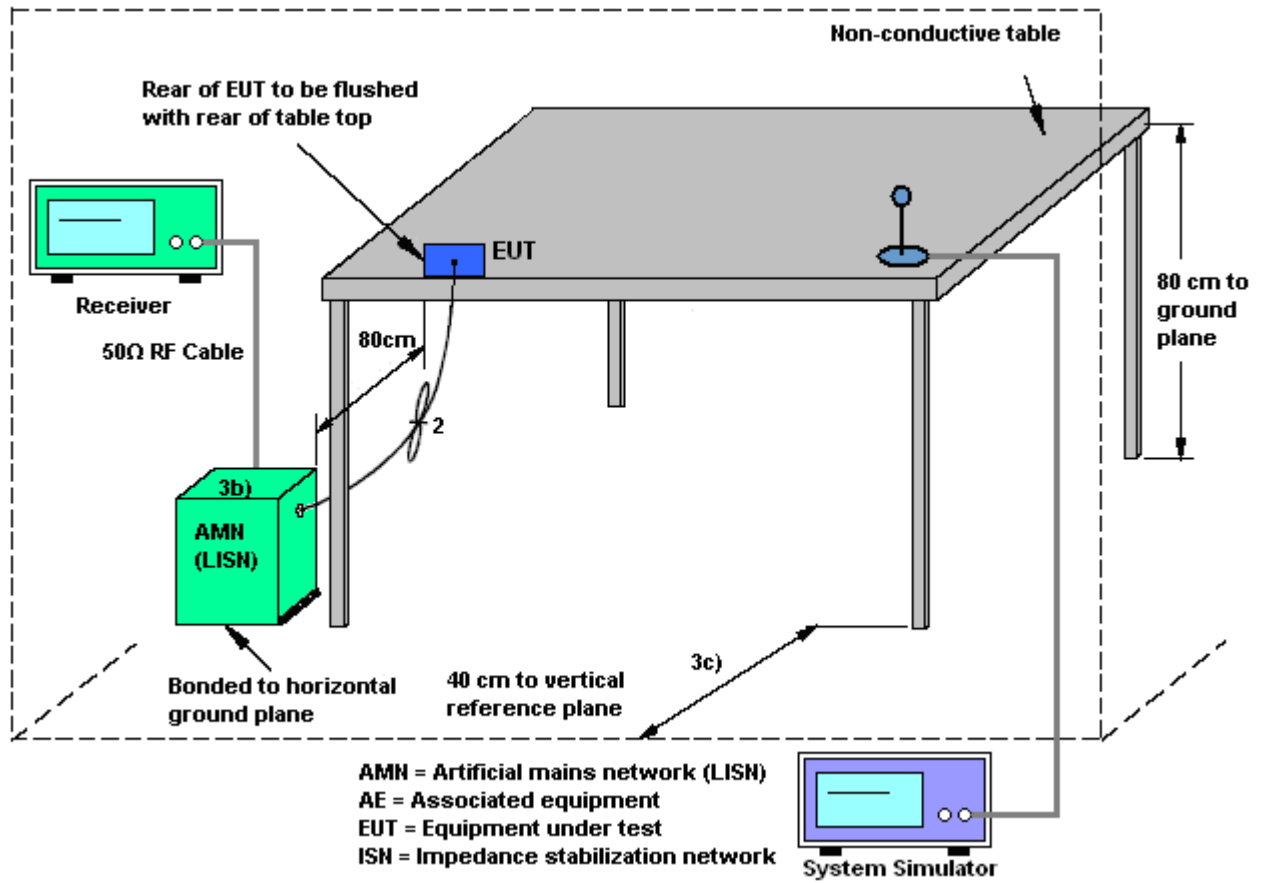

3.9.5 Test Result of AC Conducted Emission

Test Mode :	Mode 1	Temperature :	20~22°C
Test Engineer :	Slash Huang	Relative Humidity :	45~47%
Test Voltage :	120Vac / 60Hz	Phase :	Line
Function Type :	WCDMA Band V Idle + Bluetooth Link + WLAN Link + MPEG4 + Earphone 2 + Battery + USB Cable (Charging from Adapter)		
Remark :	All emissions not reported here are more than 10 dB below the prescribed limit.		

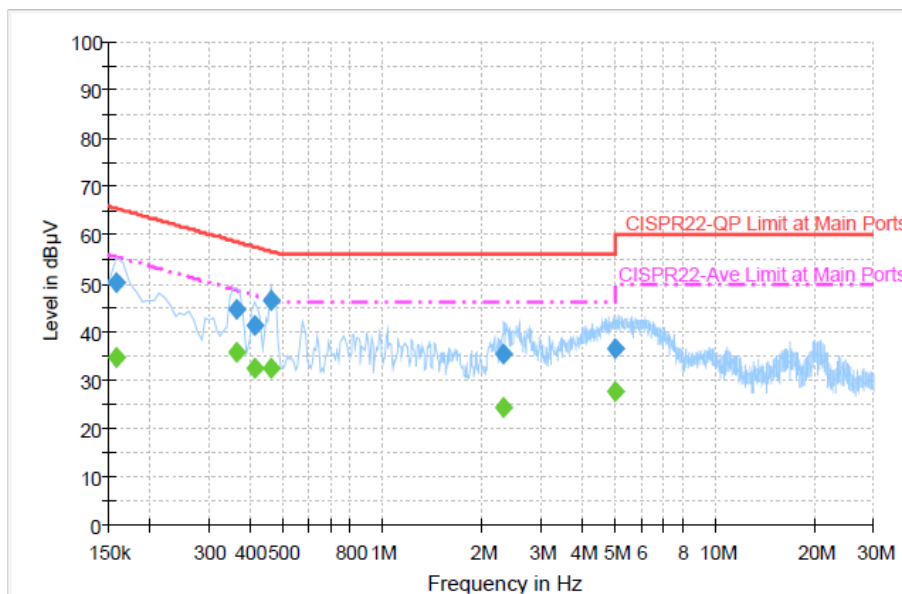

Final Result : Quasi-Peak

Frequency (MHz)	Quasi-Peak (dBµV)	Filter	Line	Corr. (dB)	Margin (dB)	Limit (dBµV)
0.158000	50.3	Off	L1	19.3	15.3	65.6
0.366000	44.8	Off	L1	19.4	13.8	58.6
0.414000	41.2	Off	L1	19.4	16.4	57.6
0.462000	46.5	Off	L1	19.3	10.2	56.7
2.318000	35.4	Off	L1	19.6	20.6	56.0
5.038000	36.6	Off	L1	19.6	23.4	60.0

Final Result : Average

Frequency (MHz)	Average (dBµV)	Filter	Line	Corr. (dB)	Margin (dB)	Limit (dBµV)
0.158000	34.5	Off	L1	19.3	21.1	55.6
0.366000	35.9	Off	L1	19.4	12.7	48.6
0.414000	32.5	Off	L1	19.4	15.1	47.6
0.462000	32.5	Off	L1	19.3	14.2	46.7
2.318000	24.2	Off	L1	19.6	21.8	46.0
5.038000	27.7	Off	L1	19.6	22.3	50.0

Test Mode :	Mode 1	Temperature :	20~22°C
Test Engineer :	Slash Huang	Relative Humidity :	45~47%
Test Voltage :	120Vac / 60Hz	Phase :	Neutral
Function Type :	WCDMA Band V Idle + Bluetooth Link + WLAN Link + MPEG4 + Earphone 2 + Battery + USB Cable (Charging from Adapter)		
Remark :	All emissions not reported here are more than 10 dB below the prescribed limit.		

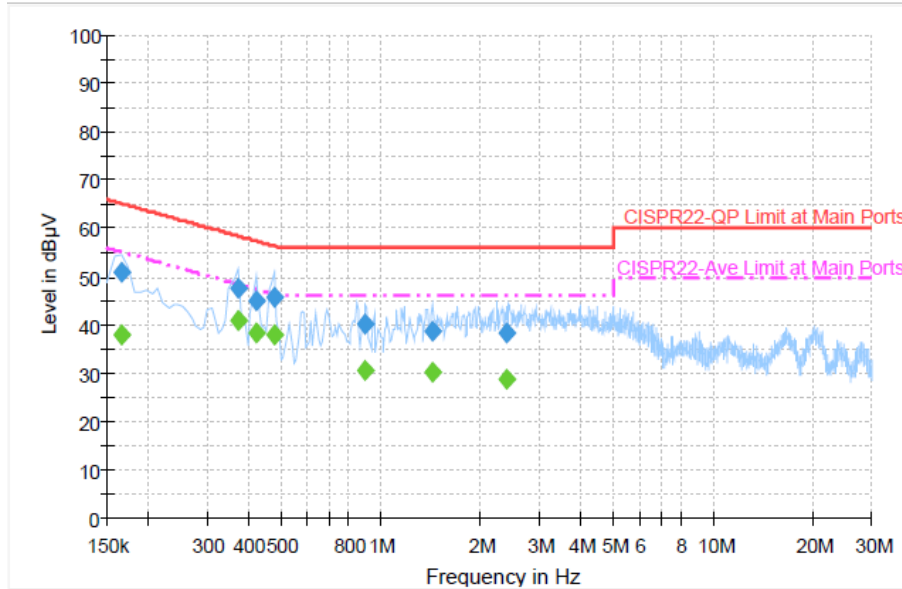

Final Result : Quasi-Peak

Frequency (MHz)	Quasi-Peak (dBµV)	Filter	Line	Corr. (dB)	Margin (dB)	Limit (dBµV)
0.166000	51.0	Off	N	19.4	14.2	65.2
0.374000	47.5	Off	N	19.4	10.9	58.4
0.422000	45.0	Off	N	19.4	12.4	57.4
0.478000	45.7	Off	N	19.4	10.7	56.4
0.902000	40.2	Off	N	19.5	15.8	56.0
1.430000	38.9	Off	N	19.5	17.1	56.0
2.398000	38.3	Off	N	19.7	17.7	56.0

Final Result : Average

Frequency (MHz)	Average (dBµV)	Filter	Line	Corr. (dB)	Margin (dB)	Limit (dBµV)
0.166000	38.0	Off	N	19.4	17.2	55.2
0.374000	41.1	Off	N	19.4	7.3	48.4
0.422000	38.2	Off	N	19.4	9.2	47.4
0.478000	38.2	Off	N	19.4	8.2	46.4
0.902000	30.7	Off	N	19.5	15.3	46.0
1.430000	30.1	Off	N	19.5	15.9	46.0
2.398000	28.8	Off	N	19.7	17.2	46.0



3.10 Antenna Requirements

3.10.1 Standard Applicable

If directional gain of transmitting antennas is greater than 6dBi, the power shall be reduced by the same level in dB comparing to gain minus 6dBi. The use of a permanently attached antenna or of an antenna that uses a unique coupling to the intentional radiator shall be considered sufficient to comply with the FCC rule.

3.10.2 Antenna Connected Construction

Non-standard connector used.

3.10.3 Antenna Gain

The antenna peak gain of EUT is less than 6 dBi. Therefore, it is not necessary to reduce maximum peak output power limit.



4 List of Measuring Equipment

Instrument	Manufacturer	Model No.	Serial No.	Characteristics	Calibration Date	Test Date	Due Date	Remark
Spectrum Analyzer	R&S	FSP40	100055	9kHz~40GHz	Jun. 06, 2012	Dec. 20, 2012 ~ Dec. 26, 2012	Jun. 05, 2013	Conducted (TH02-HY)
EMI Test Receiver	Rohde & Schwarz	ESCS 30	100356	9kHz ~ 2.75GHz	Nov. 13, 2012	May 28, 2013	Nov. 12, 2013	Conduction (CO05-HY)
Two-LISN (for auxiliary equipment)	Rohde & Schwarz	ENV216	100081	9kHz ~ 30MHz	Dec. 12, 2012	May 28, 2013	Dec. 11, 2013	Conduction (CO05-HY)
Two-LISN	Rohde & Schwarz	ENV216	100080	9kHz ~ 30MHz	Dec. 06, 2012	May 28, 2013	Dec. 05, 2013	Conduction (CO05-HY)
AC Power Source	APC	APC-1000W	N/A	N/A	N/A	May 28, 2013	N/A	Conduction (CO05-HY)
Spectrum Analyzer	R&S	FSP30	101352	9kHz~30GHz	Nov. 07, 2012	Jan. 14, 2013 ~ Jan. 15, 2013	Nov. 06, 2013	Radiation (03CH06-HY)
Spectrum Analyzer	Agilent	E4408B	MY44211030	9kHz ~ 26.5GHz	Nov. 26, 2012	Jan. 14, 2013 ~ Jan. 15, 2013	Nov. 25, 2013	Radiation (03CH06-HY)
EMI Test Receiver	R&S	ESVS10	834468/0003	20MHz ~ 1000MHz	May 04, 2012	Jan. 14, 2013 ~ Jan. 15, 2013	May 03, 2013	Radiation (03CH06-HY)
Loop Antenna	R&S	HFH2-Z2	860004/001	9kHz ~ 30MHz	Jul. 03, 2012	Jan. 14, 2013 ~ Jan. 15, 2013	Jul. 02, 2013	Radiation (03CH06-HY)
Bilog Antenna	SCHAFFNER	CBL6112B	2885	30MHz ~ 2GHz	Oct. 06, 2012	Jan. 14, 2013 ~ Jan. 15, 2013	Oct. 05, 2013	Radiation (03CH06-HY)
Double Ridge Horn Antenna	EMCO	3117	00066583	1GHz ~ 18GHz	Aug. 01, 2012	Jan. 14, 2013 ~ Jan. 15, 2013	Jul. 31, 2013	Radiation (03CH06-HY)
Double Ridge Horn Antenna	COM-POWER	AH-118	071025	1GHz~18GHz	Aug. 09, 2012	Jan. 14, 2013 ~ Jan. 15, 2013	Aug. 08, 2013	Radiation (03CH06-HY)
SHF-EHF Horn Antenna	SCHWARZBECK	BBHA 9170	BBHA9170251	15GHz ~ 40GHz	Sep. 28, 2012	Jan. 14, 2013 ~ Jan. 15, 2013	Sep. 27, 2013	Radiation (03CH06-HY)
Preamplifier	Agilent	8449B	3008A01917	1GHz ~ 26.5GHz	Apr. 13, 2012	Jan. 14, 2013 ~ Jan. 15, 2013	Apr. 12, 2013	Radiation (03CH06-HY)
Amplifier	Agilent	310N	186713	9kHz ~ 1GHz	Apr. 11, 2012	Jan. 14, 2013 ~ Jan. 15, 2013	Apr. 10, 2013	Radiation (03CH06-HY)
Pre Amplifier	EMCI	EMC051845	SN980048	1GHz ~ 18GHz	Jul. 21, 2012	Jan. 14, 2013 ~ Jan. 15, 2013	Jul. 20, 2013	Radiation (03CH06-HY)
Pre Amplifier	MITEQ	AMF-7D-0010 1800-30-10P	159087	1GHz~18GHz	Feb. 27, 2012	Jan. 14, 2013 ~ Jan. 15, 2013	Feb. 26, 2013	Radiation (03CH06-HY)
Turn Table	INN-CO	DS2000	420/650/00	0 - 360 degree	N/A	Jan. 14, 2013 ~ Jan. 15, 2013	N/A	Radiation (03CH06-HY)
Antenna Mast	MF	MF-7802	MF780208212	1 m ~ 4 m	N/A	Jan. 14, 2013 ~ Jan. 15, 2013	N/A	Radiation (03CH06-HY)



5 Uncertainty of Evaluation

Uncertainty of Conducted Emission Measurement (150 kHz ~ 30 MHz)

Measuring Uncertainty for a Level of Confidence of 95% ($U = 2Uc(y)$)	2.26
---	------

Uncertainty of Radiated Emission Measurement (30 MHz ~ 1000 MHz)

Measuring Uncertainty for a Level of Confidence of 95% ($U = 2Uc(y)$)	2.54
---	------

Uncertainty of Radiated Emission Measurement (1 GHz ~ 40 GHz)

Measuring Uncertainty for a Level of Confidence of 95% ($U = 2Uc(y)$)	4.72
---	------



Appendix A. Photographs of EUT

Please refer to Sporton report number EP2D2653-01 as below.



Appendix C. Product Equality Declaration

Bullitt Group

No. 4, The Aquarium, King Street, Reading RG1 2AN, United Kingdom
Tel: +44 (0) 7818 413 871 ; Fax: +44 (0) 7818 413 871

Federal Communications Commission
Authorization and Evaluation Division
1435 Oakland Mills Road
Columbia, MD 21046

To whom it may concern:

The differences between devices FCC ID: ZL5B15 and FCC ID: ZL5B15AWS are outlined as below.

- Antenna design is the same.
- PCB: DDR1 change to DDR2 memory (Layout modification)
- PCB: Add HAC inductor at receiver for HAC t-coil (Layout modification, A case modification)
- PCB: Add WCDMA Band 4 hardware.
- PCB: Introduce some 2nd source passive components
- Assembly: LCM module change new driver IC (FPC layout modification), module outline is the same as FCC ID ZL5B15.
(SW change new LCM driver and HW add one GPIO for auto configuration new/old LCM..)
- Add 2nd source earphone

Based on the similarity between two FCC IDs, we hereby request permission to use Part 15C/22H/24E test data of FCC ID: ZL5B15 granted on 2013/02/19, verifying the worst cases found in ZL5B15 on ZL5B15AWS, to show the compliance of FCC ID ZL5B15AWS regarding Part 15C/22H/24E requirements. As for Part 27, the RF and SAR assessment will be fully tested in accordance with Part 27 and SAR requirements.

Sincerely,

Richard Wharton
rwharton@bullitt-group.com