



FCC SAR Test Report

APPLICANT : Bullitt Group
EQUIPMENT : Smart Phone
BRAND NAME : CAT
MODEL NAME : B15
FCC ID : ZL5B15
STANDARD : FCC 47 CFR Part 2 (2.1093)
ANSI/IEEE C95.1-1992
IEEE 1528-2003
FCC OET Bulletin 65 Supplement C (Edition 01-01)

The product was completely tested on Jan. 15, 2013 We, SPORTON INTERNATIONAL INC., would like to declare that the tested sample has been evaluated in accordance with the procedures and shown the compliance with the applicable technical standards.

The test results in this report apply exclusively to the tested model / sample. Without written approval of SPORTON INTERNATIONAL INC., the test report shall not be reproduced except in full.

Reviewed by:

Jones Tsai / Manager



SPORTON INTERNATIONAL INC.

No. 52, Hwa Ya 1st Rd., Hwa Ya Technology Park, Kwei-Shan Hsiang, Tao Yuan Hsien, Taiwan, R.O.C.



Table of Contents

1. Statement of Compliance 4
2. Administration Data 5
2.1 Testing Laboratory 5
2.2 Applicant 5
2.3 Manufacturer 5
2.4 Application Details 5
3. General Information 6
3.1 Description of Equipment Under Test (EUT) 6
3.2 Maximum RF output power among production units 7
3.3 Product Photos 8
3.4 Applied Standard 8
3.5 Device Category and SAR Limits 8
3.6 Test Conditions 8
4. Specific Absorption Rate (SAR) 9
4.1 Introduction 9
4.2 SAR Definition 9
5. SAR Measurement System 10
5.1 E-Field Probe 11
5.2 Data Acquisition Electronics (DAE) 12
5.3 Robot 12
5.4 Measurement Server 12
5.5 Phantom 13
5.6 Device Holder 14
5.7 Data Storage and Evaluation 15
5.8 Test Equipment List 17
6. Tissue Simulating Liquids 18
7. SAR System Verification 20
7.1 Purpose of System Performance check 20
7.2 System Setup 20
7.3 SAR System Verification Results 21
8. EUT Testing Position 22
8.1 Define two imaginary lines on the handset 22
8.2 Cheek Position 23
8.3 Tilted Position 23
8.4 Body Worn Position 24
9. Measurement Procedures 25
9.1 Spatial Peak SAR Evaluation 25
9.2 Power Reference Measurement 26
9.3 Area & Zoom Scan Procedures 26
9.4 Volume Scan Procedures 27
9.5 SAR Averaged Methods 27
9.6 Power Drift Monitoring 27
10. Exposure Positions Consideration 28
11. Conducted RF Output Power (Unit: dBm) 30
12. SAR Test Results 36
12.1 Test Records for Head SAR Test 36
12.2 Test Records for Hotspot SAR Test 38
12.3 Test Records for Body-worn SAR Test 40
12.4 Repeated SAR Measurement 41
12.5 Highest SAR Plot 42
12.6 Simultaneous Multi-band Transmission Analysis 46
13. Uncertainty Assessment 51
14. References 53
Appendix A. Plots of System Performance Check
Appendix B. Plots of SAR Measurement
Appendix C. DASY Calibration Certificate
Appendix D. Product Photos
Appendix E. Test Setup Photos



Revision History

REPORT NO.	VERSION	DESCRIPTION	ISSUED DATE
FA2D2653	Rev. 01	Initial issue of report	Feb. 06, 2013



1. Statement of Compliance

The maximum results of Specific Absorption Rate (SAR) found during testing for **Bullitt Group Smart Phone, CAT, B15**, are as follows.

<Highest Reported standalone SAR Summary>

Exposure Position	Frequency Band	Highest Reported 1g-SAR (W/kg)	Equipment Class	Highest Reported 1g-SAR (W/kg)
Head	GSM850	0.62	PCE	0.74
	GSM1900	0.54		
	WCDMA Band V	0.55		
	WCDMA Band II	0.74		
	WLAN 2.4GHz Band	0.23	DTS	0.23
Hotspot (1cm Gap)	GSM850	0.93	PCE	0.93
	GSM1900	0.61		
	WCDMA Band V	0.83		
	WCDMA Band II	0.90		
	WLAN 2.4GHz Band	0.10	DTS	0.10
Body-worn (1cm Gap)	GSM850	0.90	PCE	0.90
	GSM1900	0.61		
	WCDMA Band V	0.83		
	WCDMA Band II	0.90		
	WLAN 2.4GHz Band	0.10	DTS	0.10

<Highest Simultaneous transmission SAR>

Frequency Band	Equipment Class	Exposure Position	Highest Reported Simultaneous Transmission 1g-SAR (W/kg)
GSM850	PCE	Hotspot (1cm Gap)	1.01
Bluetooth 2.4GHz Band	DSS		

Frequency Band	Equipment Class	Exposure Position	Highest Reported Simultaneous Transmission 1g-SAR (W/kg)
GSM850	PCE	Hotspot (1cm Gap)	1.02
WLAN 2.4GHz Band	DTS		

Remark:

The highest simultaneous transmission is scalar summation of reported standalone SAR per FCC KDB 690783 D01 v01r02, and scalar SAR summation of all possible simultaneous transmission scenarios are < 1.6W/kg.

This device is in compliance with Specific Absorption Rate (SAR) for general population/uncontrolled exposure limits (1.6 W/kg) specified in FCC 47 CFR part 2 (2.1093) and ANSI/IEEE C95.1-1992, and had been tested in accordance with the measurement methods and procedures specified in IEEE 1528-2003 and FCC OET Bulletin 65 Supplement C (Edition 01-01).



2. Administration Data

2.1 Testing Laboratory

Test Site	SPORTON INTERNATIONAL INC.
Test Site Location	No. 52, Hwa Ya 1 st Rd., Hwa Ya Technology Park, Kwei-Shan Hsiang, Tao Yuan Hsien, Taiwan, R.O.C. TEL: +886-3-327-3456 FAX: +886-3-328-4978

2.2 Applicant

Company Name	Bullitt Group
Address	No. 4, The Aquarium, King Street, Reading, RG1 2AN United Kingdom

2.3 Manufacturer

Company Name	Compal Communications(Nanjing) Co. Ltd.
Address	No. 68-2 Suyuan Road, Nanjing Export, Processing Zone (South Area), P. R. China

2.4 Application Details

Date of Start during the Test	Jan. 12, 2013
Date of End during the Test	Jan. 15, 2013



3. General Information

3.1 Description of Equipment Under Test (EUT)

Product Feature & Specification	
EUT	Smart Phone
Brand Name	CAT
Model Name	B15
FCC ID	ZL5B15
HW Version	DVT
SW Version	VT58_EMEA_DS.0.008.01
TX Frequency	GSM850: 824.2 MHz ~ 848.8 MHz GSM1900: 1850.2 MHz ~ 1909.8 MHz WCDMA Band V: 826.4 MHz ~ 846.6 MHz WCDMA Band II: 1852.4 MHz ~ 1907.6 MHz WLAN 2.4GHz Band: 2412 MHz ~ 2462 MHz Bluetooth: 2402 MHz ~ 2480 MHz
Antenna Type	WWAN: PIFA Antenna WLAN: PIFA Antenna Bluetooth: PIFA Antenna
Uplink Modulations	GSM: GMSK GPRS: GMSK EDGE: GMSK / 8PSK WCDMA (Rel 99): QPSK HSDPA (Rel 5): QPSK 802.11b: DSSS (DBPSK / DQPSK / CCK) 802.11g/n: OFDM (BPSK / QPSK / 16QAM / 64QAM) Bluetooth : GFSK Bluetooth EDR : $\pi/4$ -DQPSK, 8-DPSK
Transfer Mode Category	Class B – EUT cannot support Packet Switched and Circuit Switched Network simultaneously but can automatically switch between Packet and Circuit Switched Network.
Remark: 1. The above EUT's information was declared by manufacturer. Please refer to the specifications or user's manual for more detailed description. 2. This device supports WLAN 2.4GHz hotspot operation 3. This product had single SIM and dual SIM versions, and the only difference in single SIM version is that the 2 nd SIM slot is blocked with a plastic plate inserted. RF exposure assessment was performed on dual SIM version, and represent RF exposure compliance of both versions.	

3.2 Maximum RF output power among production units

Mode	Average power(dBm)	
	GSM 850	GSM 1900
GSM (GMSK, 1 Tx slot)	33.5	31
GPRS/EDGE (GMSK, 1 Tx slot)	33.5	31
GPRS/EDGE (GMSK, 2 Tx slots)	29.5	27
GPRS/EDGE (GMSK, 3 Tx slots)	28.5	25.5
GPRS/EDGE (GMSK, 4 Tx slots)	27.5	24.5
EDGE (8PSK, 1 Tx slot)	26.5	25.5
EDGE (8PSK, 2 Tx slots)	23	22.5
EDGE (8PSK, 3 Tx slots)	21.5	20.5
EDGE (8PSK, 4 Tx slots)	20	19.5

Mode	Average power(dBm)	
	WCDMA Band V	WCDMA Band II
RMC 12.2Kbps	24.5	23.5
HSDPA Subtest-1	24.5	23.5
HSUPA Subtest-5	24.5	23.5

IEEE 802.11 average power(dBm)				
Normal				
Mode/Band	b	g	n(HT20)	n(HT40)
WLAN 2.4 GHz Band	14	12.2	12.3	12.1

Mode / Band	Bluetooth Average power(dBm)		
	1Mbps (GFSK)	2Mbps ($\pi/4$ -DQPSK)	3Mbps (8-DPSK)
2.4 GHz Bluetooth	6	4	3



3.3 Product Photos

Please refer to Appendix D.

3.4 Applied Standard

The Specific Absorption Rate (SAR) testing specification, method, and procedure for this device is in accordance with the following standards:

- FCC 47 CFR Part 2 (2.1093)
- ANSI/IEEE C95.1-1992
- IEEE 1528-2003
- FCC OET Bulletin 65 Supplement C (Edition 01-01)
- FCC KDB 447498 D01 v05
- FCC KDB 648474 D04v01
- FCC KDB 248227 D01 v01r02
- FCC KDB 941225 D01 v02
- FCC KDB 941225 D03 v01
- FCC KDB 941225 D06 v01

3.5 Device Category and SAR Limits

This device belongs to portable device category because its radiating structure is allowed to be used within 20 centimeters of the body of the user. Limit for General Population/Uncontrolled exposure should be applied for this device, it is 1.6 W/kg as averaged over any 1 gram of tissue.

3.6 Test Conditions

3.6.1 Ambient Condition

Ambient Temperature	20 to 24 °C
Humidity	< 60 %

3.6.2 Test Configuration

For WWAN SAR testing, the device was controlled by using a base station emulator. Communication between the device and the emulator was established by air link. The distance between the EUT and the antenna of the emulator is larger than 50 cm and the output power radiated from the emulator antenna is at least 30 dB smaller than the output power of EUT.

During WLAN SAR testing EUT is configured with the WLAN continuous TX tool, and the transmission duty factor was monitored on the spectrum analyzer with zero-span setting

Duty factor observed as below:

802.11b, 1Mbps: 100%

For WLAN SAR testing, WLAN engineering testing software installed on the EUT can provide continuous transmitting RF signal.

4. Specific Absorption Rate (SAR)

4.1 Introduction

SAR is related to the rate at which energy is absorbed per unit mass in an object exposed to a radio field. The SAR distribution in a biological body is complicated and is usually carried out by experimental techniques or numerical modeling. The standard recommends limits for two tiers of groups, occupational/controlled and general population/uncontrolled, based on a person's awareness and ability to exercise control over his or her exposure. In general, occupational/controlled exposure limits are higher than the limits for general population/uncontrolled.

4.2 SAR Definition

The SAR definition is the time derivative (rate) of the incremental energy (dW) absorbed by (dissipated in) an incremental mass (dm) contained in a volume element (dv) of a given density (ρ). The equation description is as below:

$$SAR = \frac{d}{dt} \left(\frac{dW}{dm} \right) = \frac{d}{dt} \left(\frac{dW}{\rho dv} \right)$$

SAR is expressed in units of Watts per kilogram (W/kg)

SAR measurement can be either related to the temperature elevation in tissue by

$$SAR = c \left(\frac{\delta T}{\delta t} \right)$$

Where: C is the specific heat capacity, δT is the temperature rise and δt is the exposure duration, or related to the electrical field in the tissue by

$$SAR = \frac{\sigma |E|^2}{\rho}$$

Where: σ is the conductivity of the tissue, ρ is the mass density of the tissue and E is the RMS electrical field strength.

However for evaluating SAR of low power transmitter, electrical field measurement is typically applied.

5. SAR Measurement System



Fig 5.1 SPEAG DASY System Configurations

The DASY system for performance compliance tests is illustrated above graphically. This system consists of the following items:

- A standard high precision 6-axis robot with controller, a teach pendant and software
- A data acquisition electronic (DAE) attached to the robot arm extension
- A dosimetric probe equipped with an optical surface detector system
- The electro-optical converter (EOC) performs the conversion between optical and electrical signals
- A measurement server performs the time critical tasks such as signal filtering, control of the robot operation and fast movement interrupts.
- A probe alignment unit which improves the accuracy of the probe positioning
- A computer operating Windows XP
- DASY software
- Remote control with teach pendant and additional circuitry for robot safety such as warning lamps, etc.
- The SAM twin phantom
- A device holder
- Tissue simulating liquid
- Dipole for evaluating the proper functioning of the system

Component details are described in in the following sub-sections.

5.1 E-Field Probe

The SAR measurement is conducted with the dosimetric probe (manufactured by SPEAG). The probe is specially designed and calibrated for use in liquid with high permittivity. The dosimetric probe has special calibration in liquid at different frequency. This probe has a built in optical surface detection system to prevent from collision with phantom.

5.1.1 E-Field Probe Specification

<ES3DV3 Probe >

Construction	Symmetrical design with triangular core Built-in optical fiber for surface detection system. Built-in shielding against static charges. PEEK enclosure material (resistant to organic solvents, e.g., DGBE)
Frequency	10 MHz to 3 GHz; Linearity: ± 0.2 dB
Directivity	± 0.2 dB in HSL (rotation around probe axis) ± 0.4 dB in HSL (rotation normal to probe axis)
Dynamic Range	10 μ W/g to 100 mW/g; Linearity: ± 0.2 dB
Dimensions	Overall length: 337 mm (Tip: 10 mm) Tip diameter: 4 mm (Body: 10 mm) Distance from probe tip to dipole centers: 3 mm



Fig 5.2 Photo of ES3DV3

5.1.2 E-Field Probe Calibration

Each probe needs to be calibrated according to a dosimetric assessment procedure with accuracy better than $\pm 10\%$. The spherical isotropy shall be evaluated and within ± 0.25 dB. The sensitivity parameters (NormX, NormY, and NormZ), the diode compression parameter (DCP) and the conversion factor (ConvF) of the probe are tested. The calibration data can be referred to appendix C of this report.

5.2 Data Acquisition Electronics (DAE)

The data acquisition electronics (DAE) consists of a highly sensitive electrometer-grade preamplifier with auto-zeroing, a channel and gain-switching multiplexer, a fast 16 bit AD-converter and a command decoder and control logic unit. Transmission to the measurement server is accomplished through an optical downlink for data and status information as well as an optical uplink for commands and the clock. The input impedance of the DAE is 200 MOhm; the inputs are symmetrical and floating. Common mode rejection is above 80 dB.



Fig 5.3 Photo of DAE

5.3 Robot

The SPEAG DASY system uses the high precision robots (DASY4: RX90BL; DASY5: TX90XL) type from Stäubli SA (France). For the 6-axis controller system, the robot controller version (DASY4: CS7MB; DASY5: CS8c) from Stäubli is used. The Stäubli robot series have many features that are important for our application:

- High precision (repeatability ± 0.035 mm)
- High reliability (industrial design)
- Jerk-free straight movements
- Low ELF interference (the closed metallic construction shields against motor control fields)

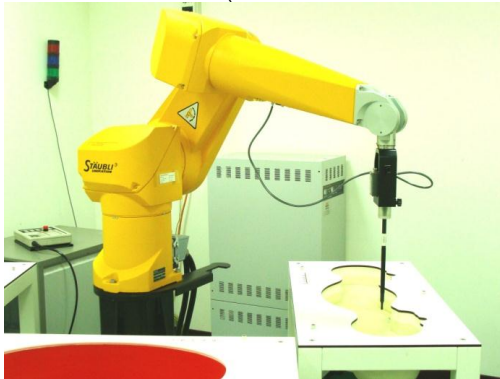

Fig 5.4 Photo of DASY4



Fig 5.5 Photo of DASY5

5.4 Measurement Server

The measurement server is based on a PC/104 CPU board with CPU (DASY4: 166 MHz, Intel Pentium; DASY5: 400 MHz, Intel Celeron), chipdisk (DASY4: 32 MB; DASY5: 128 MB), RAM (DASY4: 64 MB, DASY5: 128 MB). The necessary circuits for communication with the DAE electronic box, as well as the 16 bit AD converter system for optical detection and digital I/O interface are contained on the DASY I/O board, which is directly connected to the PC/104 bus of the CPU board.

The measurement server performs all the real-time data evaluation for field measurements and surface detection, controls robot movements and handles safety operations.



Fig 5.6 Photo of Server for DASY4



Fig 5.7 Photo of Server for DASY5

5.5 Phantom

<SAM Twin Phantom>

Shell Thickness	2 ± 0.2 mm; Center ear point: 6 ± 0.2 mm
Filling Volume	Approx. 25 liters
Dimensions	Length: 1000 mm; Width: 500 mm; Height: adjustable feet
Measurement Areas	Left Hand, Right Hand, Flat Phantom

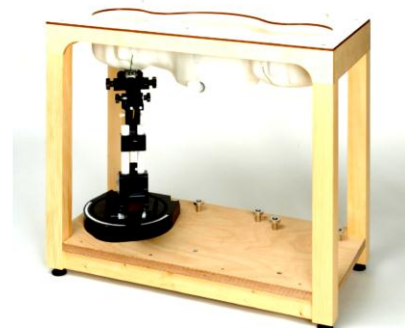

Fig 5.8 Photo of SAM Phantom

The bottom plate contains three pair of bolts for locking the device holder. The device holder positions are adjusted to the standard measurement positions in the three sections. A white cover is provided to tap the phantom during off-periods to prevent water evaporation and changes in the liquid parameters. On the phantom top, three reference markers are provided to identify the phantom position with respect to the robot.

<ELI4 Phantom>

Shell Thickness	2 ± 0.2 mm (sagging: <1%)
Filling Volume	Approx. 30 liters
Dimensions	Major ellipse axis: 600 mm Minor axis: 400 mm

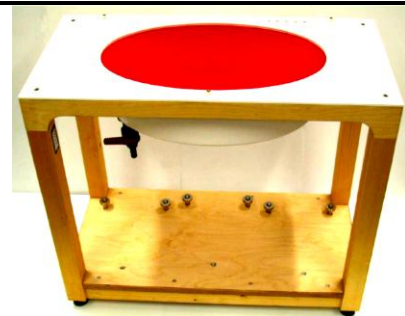

Fig 5.9 Photo of ELI4 Phantom

The ELI4 phantom is intended for compliance testing of handheld and body-mounted wireless devices in the frequency range of 30 MHz to 6 GHz. ELI4 is fully compatible with standard and all known tissue simulating liquids.

5.6 Device Holder

<Device Holder for SAM Twin Phantom>

The SAR in the phantom is approximately inversely proportional to the square of the distance between the source and the liquid surface. For a source at 5 mm distance, a positioning uncertainty of ± 0.5 mm would produce a SAR uncertainty of ± 20 %. Accurate device positioning is therefore crucial for accurate and repeatable measurements. The positions in which the devices must be measured are defined by the standards.

The DASY device holder is designed to cope with different positions given in the standard. It has two scales for the device rotation (with respect to the body axis) and the device inclination (with respect to the line between the ear reference points). The rotation center for both scales is the ear reference point (ERP). Thus the device needs no repositioning when changing the angles.

The DASY device holder is constructed of low-loss POM material having the following dielectric parameters: relative permittivity $\epsilon = 3$ and loss tangent $\delta = 0.02$. The amount of dielectric material has been reduced in the closest vicinity of the device, since measurements have suggested that the influence of the clamp on the test results could thus be lowered.



Fig 5.10 Device Holder

<Laptop Extension Kit>

The extension is lightweight and made of POM, acrylic glass and foam. It fits easily on the upper part of the mounting device in place of the phone positioned. The extension is fully compatible with the SAM Twin and ELI phantoms.

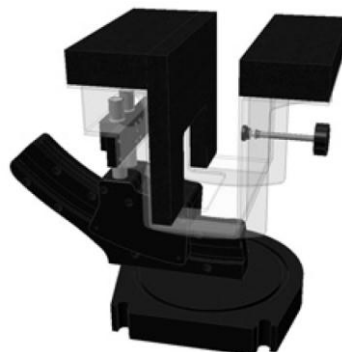

Fig 5.11 Laptop Extension Kit



5.7 Data Storage and Evaluation

5.7.1 Data Storage

The DASY software stores the assessed data from the data acquisition electronics as raw data (in microvolt readings from the probe sensors), together with all the necessary software parameters for the data evaluation (probe calibration data, liquid parameters and device frequency and modulation data) in measurement files. The post-processing software evaluates the desired unit and format for output each time the data is visualized or exported. This allows verification of the complete software setup even after the measurement and allows correction of erroneous parameter settings. For example, if a measurement has been performed with an incorrect crest factor parameter in the device setup, the parameter can be corrected afterwards and the data can be reevaluated.

The measured data can be visualized or exported in different units or formats, depending on the selected probe type (e.g., [V/m], [A/m], [mW/g]). Some of these units are not available in certain situations or give meaningless results, e.g., a SAR-output in a non-lose media, will always be zero. Raw data can also be exported to perform the evaluation with other software packages.

5.7.2 Data Evaluation

The DASY post-processing software (SEMCAD) automatically executes the following procedures to calculate the field units from the microvolt readings at the probe connector. The parameters used in the evaluation are stored in the configuration modules of the software :

Probe parameters :	- Sensitivity	Norm _i , a _{i0} , a _{i1} , a _{i2}
	- Conversion factor	ConvF _i
	- Diode compression point	dcp _i
Device parameters :	- Frequency	f
	- Crest factor	cf
Media parameters :	- Conductivity	σ
	- Density	ρ

These parameters must be set correctly in the software. They can be found in the component documents or they can be imported into the software from the configuration files issued for the DASY components. In the direct measuring mode of the multi-meter option, the parameters of the actual system setup are used. In the scan visualization and export modes, the parameters stored in the corresponding document files are used.

The first step of the evaluation is a linearization of the filtered input signal to account for the compression characteristics of the detector diode. The compensation depends on the input signal, the diode type and the DC-transmission factor from the diode to the evaluation electronics. If the exciting field is pulsed, the crest factor of the signal must be known to correctly compensate for peak power.

The formula for each channel can be given as :

$$V_i = U_i + U_i^2 \cdot \frac{cf}{dcp_i}$$

with V_i = compensated signal of channel i, (i = x, y, z)
 U_i = input signal of channel i, (i = x, y, z)
 cf = crest factor of exciting field (DASY parameter)
 dcp_i = diode compression point (DASY parameter)

From the compensated input signals, the primary field data for each channel can be evaluated :

$$\text{E-field Probes : } E_i = \sqrt{\frac{V_i}{\text{Norm}_i \cdot \text{ConvF}}}$$

$$\text{H-field Probes : } H_i = \sqrt{V_i \cdot \frac{a_{i0} + a_{i1}f + a_{i2}f^2}{f}}$$

with V_i = compensated signal of channel i, (i = x, y, z)
 Norm_i = sensor sensitivity of channel i, (i = x, y, z), $\mu\text{V}/(\text{V/m})^2$ for E-field Probes
 ConvF = sensitivity enhancement in solution
 a_{ij} = sensor sensitivity factors for H-field probes
 f = carrier frequency [GHz]
 E_i = electric field strength of channel i in V/m
 H_i = magnetic field strength of channel i in A/m

The RSS value of the field components gives the total field strength (Hermitian magnitude) :

$$E_{\text{tot}} = \sqrt{E_x^2 + E_y^2 + E_z^2}$$

The primary field data are used to calculate the derived field units.

$$\text{SAR} = E_{\text{tot}}^2 \cdot \frac{\sigma}{\rho \cdot 1000}$$

with SAR = local specific absorption rate in mW/g
 E_{tot} = total field strength in V/m
 σ = conductivity in [mho/m] or [Siemens/m]
 ρ = equivalent tissue density in g/cm^3

Note that the density is set to 1, to account for actual head tissue density rather than the density of the tissue simulating liquid.



5.8 Test Equipment List

Manufacturer	Name of Equipment	Type/Model	Serial Number	Calibration	
				Last Cal.	Due Date
SPEAG	835MHz System Validation Kit	D835V2	499	Mar. 22, 2010	Mar. 21, 2013
SPEAG	1900MHz System Validation Kit	D1900V2	5d041	Mar. 23, 2010	Mar. 22, 2013
SPEAG	2450MHz System Validation Kit	D2450V2	736	Jul. 25, 2011	Jul. 24, 2013
SPEAG	Data Acquisition Electronics	DAE4	778	Aug. 27, 2012	Aug. 26, 2013
SPEAG	Dosimetric E-Field Probe	ES3DV3	3270	Sep. 28, 2012	Sep. 27, 2013
Wisewind	Thermometer	ETP-101	TM560	Nov. 13, 2012	Nov. 12, 2013
SPEAG	SAM Phantom	QD 000 P40 C	TP-1446	NCR	NCR
SPEAG	SAM Phantom	QD 000 P40 C	TP-1478	NCR	NCR
Agilent	Network Analyzer	E5071C	MY46101588	May. 11, 2012	May. 10, 2013
Agilent	ESG Vector Series Signal Generator	E4438C	MY49070755	Oct. 02, 2012	Oct. 01, 2013
Anritsu	Power Meter	ML2495A	1132003	Aug. 14, 2012	Aug. 13, 2013
Agilent	Wireless Communication Test Set	E5515C	MY48360820	Jan. 05, 2012	Jan. 04, 2014
Agilent	Dual Directional Coupler	778D	50422	Note 4	
Woken	Attenuator 1	WK0602-XX	N/A	Note 4	
PE	Attenuator 2	PE7005-10	N/A	Note 4	
PE	Attenuator 3	PE7005- 3	N/A	Note 4	
Agilent	Dielectric Probe Kit	85070D	US01440205	Note 5	
AR	Power Amplifier	5S1G4M2	328767	Note 6	
R&S	Spectrum Analyzer	FSP	101131	Jul. 23, 2012	Jul. 22, 2013

Table 5.1 Test Equipment List

Note:

1. The calibration certificate of DASY can be referred to appendix C of this report.
2. Referring to KDB 865664 D01v01, the dipole calibration interval can be extended to 3 years with justification. The dipoles are also not physically damaged, or repaired during the interval.
3. The justification data of dipole D835V2, SN: 499, D1900V2, SN: 5d041, D2450V2, SN: 736, can be found in appendix C. The return loss is < -20dB, within 20% of prior calibration, the impedance is within 5 ohm of prior calibration.
4. The Insertion Loss calibration of Dual Directional Coupler and Attenuator were characterized via the network analyzer and compensated during system check.
5. The dielectric probe kit was calibrated via the network analyzer, with the specified procedure (calibrated in pure water) and calibration kit (standard) short circuit, before the dielectric measurement. The specific procedure and calibration kit are provided by Agilent.
6. In system check we need to monitor the level on the power meter, and adjust the power amplifier level to have precise power level to the dipole; the measured SAR will be normalized to 1W input power according to the ratio of 1W to the input power to the dipole. For system check, the calibration of the power amplifier is deemed not critically required for correct measurement; the power meter is critical and we do have calibration for it
7. Attenuator 1 insertion loss is calibrated by the network Analyzer, which the calibration is valid, before system check.

6. Tissue Simulating Liquids

For the measurement of the field distribution inside the SAM phantom with DASY, the phantom must be filled with around 25 liters of homogeneous body tissue simulating liquid. For head SAR testing, the liquid height from the ear reference point (ERP) of the phantom to the liquid top surface is larger than 15 cm, which is shown in Fig. 6.1. For body SAR testing, the liquid height from the center of the flat phantom to the liquid top surface is larger than 15 cm, which is shown in Fig. 6.2.

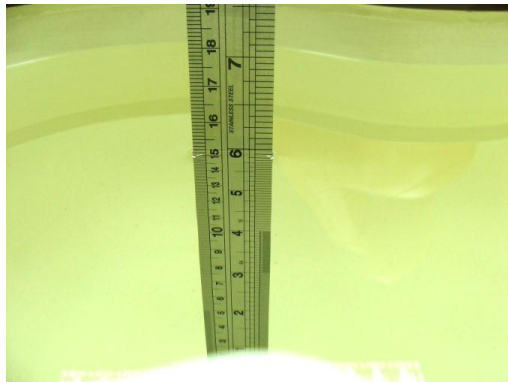

Fig 6.1 Photo of Liquid Height for Head SAR



Fig 6.2 Photo of Liquid Height for Body SAR

The following table gives the recipes for tissue simulating liquid.

Frequency (MHz)	Water (%)	Sugar (%)	Cellulose (%)	Salt (%)	Preventol (%)	DGBE (%)	Conductivity (σ)	Permittivity (ϵ_r)
For Head								
750	41.1	57.0	0.2	1.4	0.2	0	0.89	41.9
835	40.3	57.9	0.2	1.4	0.2	0	0.90	41.5
900	40.3	57.9	0.2	1.4	0.2	0	0.97	41.5
1800, 1900, 2000	55.2	0	0	0.3	0	44.5	1.40	40.0
2450	55.0	0	0	0	0	45.0	1.80	39.2
For Body								
750	51.7	47.2	0	0.9	0.1	0	0.96	55.5
835	50.8	48.2	0	0.9	0.1	0	0.97	55.2
900	50.8	48.2	0	0.9	0.1	0	1.05	55.0
1800, 1900, 2000	70.2	0	0	0.4	0	29.4	1.52	53.3
2450	68.6	0	0	0	0	31.4	1.95	52.7

Table 6.1 Recipes of Tissue Simulating Liquid

Simulating Liquid for 5G, Manufactured by SPEAG

Ingredients	(% by weight)
Water	64~78%
Mineral oil	11~18%
Emulsifiers	9~15%
Additives and Salt	2~3%



The dielectric parameters of the liquids were verified prior to the SAR evaluation using an Agilent 85070D Dielectric Probe Kit and an Agilent Network Analyzer.

The following table shows the measuring results for simulating liquid.

Frequency (MHz)	Liquid Type	Liquid Temp. (°C)	Conductivity (σ)	Permittivity (ϵ_r)	Conductivity Target (σ)	Permittivity Target (ϵ_r)	Delta (σ) (%)	Delta (ϵ_r) (%)	Limit (%)	Date
835	Head	21.7	0.889	43.271	0.90	41.5	-1.22	4.27	±5	Jan. 15, 2013
835	Body	21.5	0.964	54.532	0.97	55.2	-0.62	-1.21	±5	Jan. 13, 2013
1900	Head	21.6	1.395	38.929	1.4	40	-0.36	-2.68	±5	Jan. 15, 2013
1900	Body	21.5	1.531	52.652	1.52	53.3	0.72	-1.22	±5	Jan. 14, 2013
2450	Head	21.6	1.825	38.673	1.8	39.2	1.39	-1.34	±5	Jan. 19, 2013
2450	Body	21.6	1.904	51.836	1.95	52.7	-2.36	-1.64	±5	Jan. 19, 2013

Table 6.2 Measuring Results for Simulating Liquid

7. SAR System Verification

Each DASY system is equipped with one or more system validation kits. These units, together with the predefined measurement procedures within the DASY software, enable the user to conduct the system performance check and system validation. System validation kit includes a dipole, tripod holder to fix it underneath the flat phantom and a corresponding distance holder.

7.1 Purpose of System Performance check

The system performance check verifies that the system operates within its specifications. System and operator errors can be detected and corrected. It is recommended that the system performance check be performed prior to any usage of the system in order to guarantee reproducible results. The system performance check uses normal SAR measurements in a simplified setup with a well characterized source. This setup was selected to give a high sensitivity to all parameters that might fail or vary over time. The system check does not intend to replace the calibration of the components, but indicates situations where the system uncertainty is exceeded due to drift or failure.

7.2 System Setup

In the simplified setup for system evaluation, the EUT is replaced by a calibrated dipole and the power source is replaced by a continuous wave that comes from a signal generator. The calibrated dipole must be placed beneath the flat phantom section of the SAM twin phantom with the correct distance holder. The distance holder should touch the phantom surface with a light pressure at the reference marking and be oriented parallel to the long side of the phantom. The equipment setup is shown below:

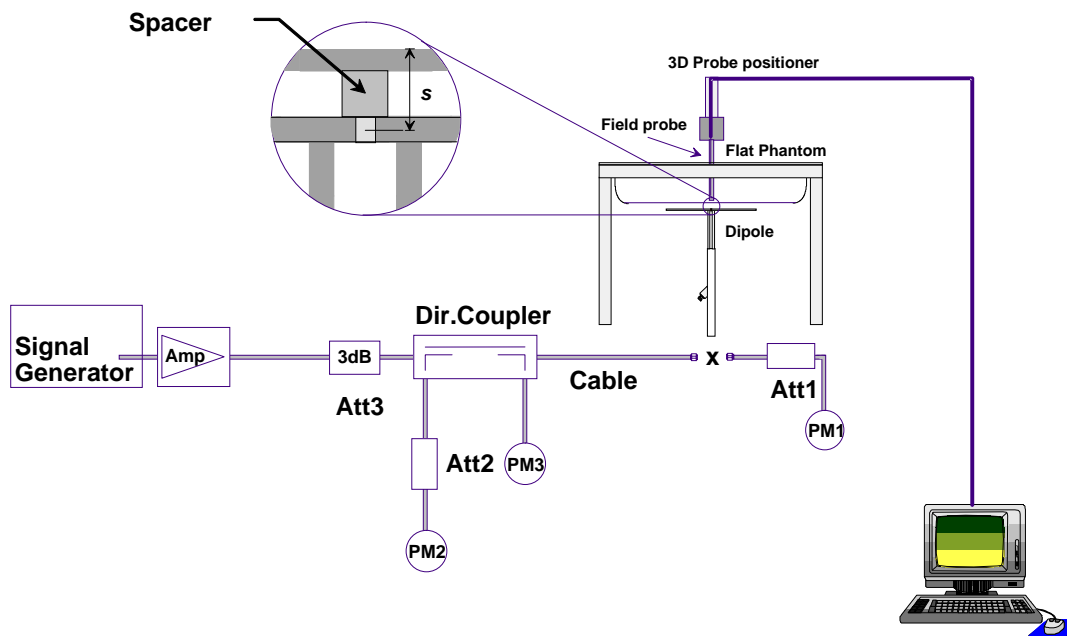

Fig 7.1 System Setup for System Evaluation

1. Signal Generator
2. Amplifier
3. Directional Coupler
4. Power Meter
5. Calibrated Dipole



Fig 7.2 Photo of Dipole Setup

7.3 SAR System Verification Results

Comparing to the original SAR value provided by SPEAG, the verification data should be within its specification of 10 %. Table 7.1 shows the target SAR and measured SAR after normalized to 1W input power. The table below indicates the system performance check can meet the variation criterion and the plots can be referred to Appendix A of this report.

Frequency (MHz)	Liquid Type	Power fed onto reference dipole (mW)	Targeted SAR (W/kg)	Measured SAR (W/kg)	Normalized SAR (W/kg)	Deviation (%)
835	Head	250	9.71	2.53	10.12	4.22
835	Body	250	9.82	2.39	9.56	-2.65
1900	Head	250	39.8	9.34	37.36	-6.13
1900	Body	250	40	9.75	39	-2.50
2450	Head	250	54.8	14.6	58.4	6.57
2450	Body	250	52.3	12.5	50	-4.40

Table 7.1 Target and Measurement SAR after Normalized

8. EUT Testing Position

This EUT was tested in ten different positions. They are right cheek, right tilted, left cheek, left tilted, Front of the EUT with phantom 1 cm gap, Back of the EUT with phantom 1 cm gap, Top Side of the EUT with phantom 1 cm gap, Bottom Side of the EUT with phantom 1 cm gap, Right Side of the EUT with phantom 1 cm gap, and Left Side of the EUT with phantom 1 cm gap, as illustrated below.

8.1 Define two imaginary lines on the handset

- The vertical centerline passes through two points on the front side of the handset - the midpoint of the width w_t of the handset at the level of the acoustic output, and the midpoint of the width w_b of the bottom of the handset.
- The horizontal line is perpendicular to the vertical centerline and passes through the center of the acoustic output. The horizontal line is also tangential to the face of the handset at point A.
- The two lines intersect at point A. Note that for many handsets, point A coincides with the center of the acoustic output; however, the acoustic output may be located elsewhere on the horizontal line. Also note that the vertical centerline is not necessarily parallel to the front face of the handset, especially for clamshell handsets, handsets with flip covers, and other irregularly shaped handsets.

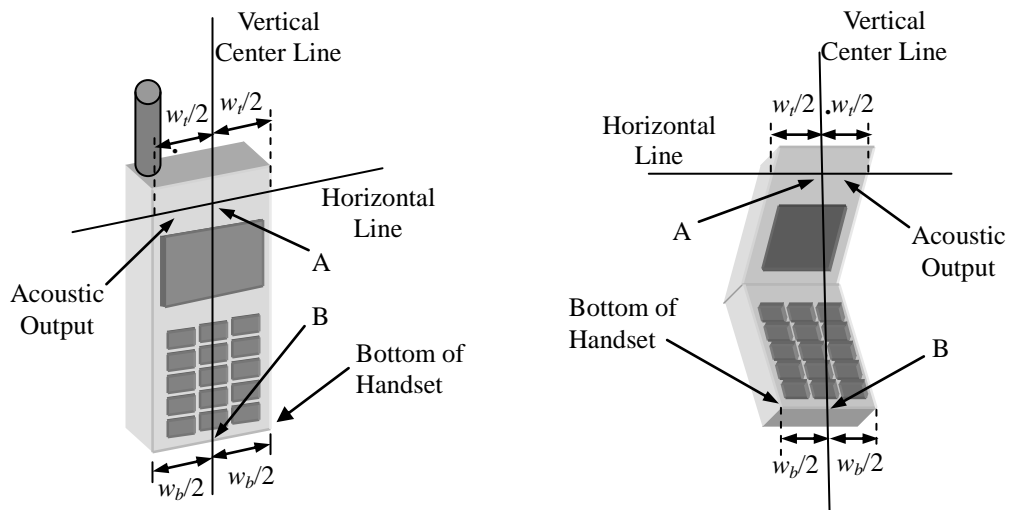

Fig 8.1 Illustration for Handset Vertical and Horizontal Reference Lines

8.2 Cheek Position

- (a) To position the device with the vertical center line of the body of the device and the horizontal line crossing the center piece in a plane parallel to the sagittal plane of the phantom. While maintaining the device in this plane, align the vertical center line with the reference plane containing the three ear and mouth reference point (M: Mouth, RE: Right Ear, and LE: Left Ear) and align the center of the ear piece with the line RE-LE.
- (b) To move the device towards the phantom with the ear piece aligned with the line LE-RE until the phone touched the ear. While maintaining the device in the reference plane and maintaining the phone contact with the ear, move the bottom of the phone until any point on the front side is in contact with the cheek of the phantom or until contact with the ear is lost (see Fig. 8.2).

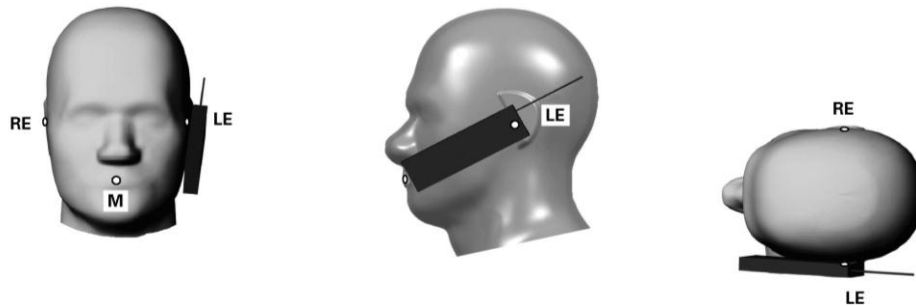

Fig 8.2 Illustration for Cheek Position

8.3 Tilted Position

- (a) To position the device in the “cheek” position described above.
- (b) While maintaining the device the reference plane described above and pivoting against the ear, moves it outward away from the mouth by an angle of 15 degrees or until contact with the ear is lost (see Fig. 8.3).

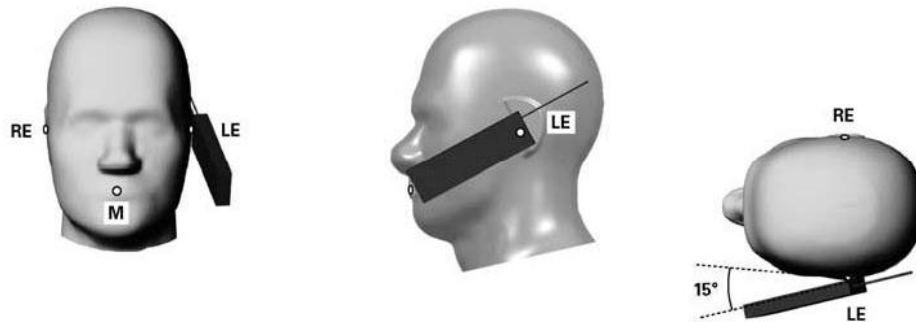

Fig 8.3 Illustration for Tilted Position

8.4 Body Worn Position

- To position the device parallel to the phantom surface with either keypad up or down.
- To adjust the device parallel to the flat phantom.
- To adjust the distance between the device surface and the flat phantom to 1 cm.

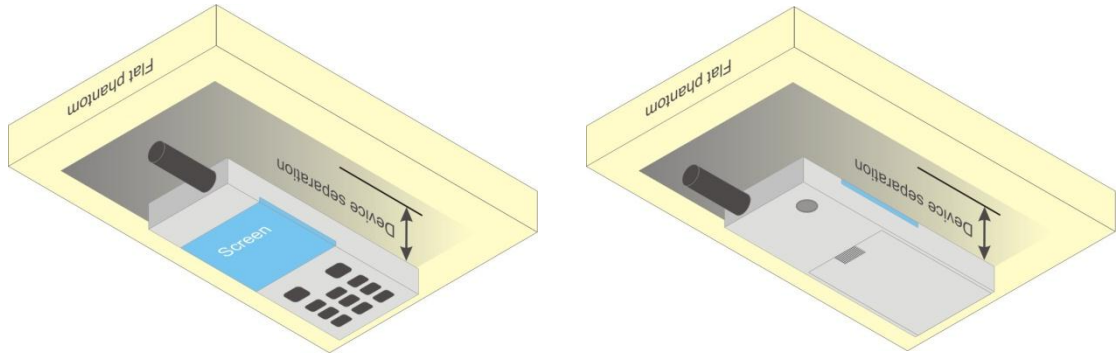

Fig 8.4 Illustration for Body Worn Position

8.5 Hotspot Position

- To position the device parallel to the phantom surface with all sides and either keypad up or down.
- To adjust the device parallel to the flat phantom.
- To adjust the distance between the device and the flat phantom to 1 cm.

<EUT Setup Photos>

Please refer to Appendix E for the test setup photos.

9. Measurement Procedures

The measurement procedures are as follows:

<Conducted power measurement>

- (a) For WWAN power measurement, use base station simulator to configure EUT WWAN transmission in conducted connection with RF cable, at maximum power in each supported wireless interface and frequency band.
- (b) Read the WWAN RF power level from the base station simulator.
- (c) For WLAN/BT power measurement, use engineering software to configure EUT WLAN/BT continuously transmission, at maximum RF power in each supported wireless interface and frequency band
- (d) Connect EUT RF port through RF cable to the power meter, and measure WLAN/BT output power

<SAR measurement>

- (a) Use base station simulator to configure EUT WWAN transmission in radiated connection, and engineering software to configure EUT WLAN/BT continuously transmission, at maximum RF power, in the highest power channel.
- (b) Place the EUT in the positions as Appendix E demonstrates.
- (c) Set scan area, grid size and other setting on the DASY software.
- (d) Measure SAR results for the highest power channel on each testing position.
- (e) Find out the largest SAR result on these testing positions of each band
- (f) Measure SAR results for other channels in worst SAR testing position if the reported SAR of highest power channel is larger than 0.8 W/kg

According to the test standard, the recommended procedure for assessing the peak spatial-average SAR value consists of the following steps:

- (a) Power reference measurement
- (b) Area scan
- (c) Zoom scan
- (d) Power drift measurement

9.1 Spatial Peak SAR Evaluation

The procedure for spatial peak SAR evaluation has been implemented according to the test standard. It can be conducted for 1g and 10g, as well as for user-specific masses. The DASY software includes all numerical procedures necessary to evaluate the spatial peak SAR value.

The base for the evaluation is a "cube" measurement. The measured volume must include the 1g and 10g cubes with the highest averaged SAR values. For that purpose, the center of the measured volume is aligned to the interpolated peak SAR value of a previously performed area scan.

The entire evaluation of the spatial peak values is performed within the post-processing engine (SEMCAD). The system always gives the maximum values for the 1g and 10g cubes. The algorithm to find the cube with highest averaged SAR is divided into the following stages:

- (a) Extraction of the measured data (grid and values) from the Zoom Scan
- (b) Calculation of the SAR value at every measurement point based on all stored data (A/D values and measurement parameters)
- (c) Generation of a high-resolution mesh within the measured volume
- (d) Interpolation of all measured values from the measurement grid to the high-resolution grid
- (e) Extrapolation of the entire 3-D field distribution to the phantom surface over the distance from sensor to surface
- (f) Calculation of the averaged SAR within masses of 1g and 10g

9.2 Power Reference Measurement

The Power Reference Measurement and Power Drift Measurements are for monitoring the power drift of the device under test in the batch process. The minimum distance of probe sensors to surface determines the closest measurement point to phantom surface. This distance cannot be smaller than the distance of sensor calibration points to probe tip as defined in the probe properties.

9.3 Area & Zoom Scan Procedures

First Area Scan is used to locate the approximate location(s) of the local peak SAR value(s). The measurement grid within an Area Scan is defined by the grid extent, grid step size and grid offset. Next, in order to determine the EM field distribution in a three-dimensional spatial extension, Zoom Scan is required. The Zoom Scan is performed around the highest E-field value to determine the averaged SAR-distribution over 10 g. Area scan and zoom scan resolution setting follows KDB 865664 D01v01 quoted below.

For any secondary peaks found in the area scan which are within 2 dB of the maximum peak and are not within this Zoom scan, the zoom scan should be repeated.

		≤ 3 GHz	> 3 GHz
Maximum distance from closest measurement point (geometric center of probe sensors) to phantom surface		5 ± 1 mm	$\frac{1}{2} \cdot \delta \cdot \ln(2) \pm 0.5$ mm
Maximum probe angle from probe axis to phantom surface normal at the measurement location		30° ± 1°	20° ± 1°
Maximum area scan spatial resolution: $\Delta x_{Area}, \Delta y_{Area}$		≤ 2 GHz: ≤ 15 mm 2 – 3 GHz: ≤ 12 mm	3 – 4 GHz: ≤ 12 mm 4 – 6 GHz: ≤ 10 mm
		When the x or y dimension of the test device, in the measurement plane orientation, is smaller than the above, the measurement resolution must be ≤ the corresponding x or y dimension of the test device with at least one measurement point on the test device.	
Maximum zoom scan spatial resolution: $\Delta x_{Zoom}, \Delta y_{Zoom}$		≤ 2 GHz: ≤ 8 mm 2 – 3 GHz: ≤ 5 mm*	3 – 4 GHz: ≤ 5 mm* 4 – 6 GHz: ≤ 4 mm*
Maximum zoom scan spatial resolution, normal to phantom surface	uniform grid: $\Delta z_{Zoom}(n)$	≤ 5 mm	3 – 4 GHz: ≤ 4 mm 4 – 5 GHz: ≤ 3 mm 5 – 6 GHz: ≤ 2 mm
	graded grid	$\Delta z_{Zoom}(1)$: between 1 st two points closest to phantom surface	≤ 4 mm 3 – 4 GHz: ≤ 3 mm 4 – 5 GHz: ≤ 2.5 mm 5 – 6 GHz: ≤ 2 mm
		$\Delta z_{Zoom}(n>1)$: between subsequent points	≤ 1.5 · $\Delta z_{Zoom}(n-1)$
Minimum zoom scan volume	x, y, z	≥ 30 mm	3 – 4 GHz: ≥ 28 mm 4 – 5 GHz: ≥ 25 mm 5 – 6 GHz: ≥ 22 mm
Note: δ is the penetration depth of a plane-wave at normal incidence to the tissue medium; see draft standard IEEE P1528-2011 for details. * When zoom scan is required and the <u>reported</u> SAR from the area scan based 1-g SAR estimation procedures of KDB 447498 is ≤ 1.4 W/kg, ≤ 8 mm, ≤ 7 mm and ≤ 5 mm zoom scan resolution may be applied, respectively, for 2 GHz to 3 GHz, 3 GHz to 4 GHz and 4 GHz to 6 GHz.			



9.4 Volume Scan Procedures

The volume scan is used for assess overlapping SAR distributions for antennas transmitting in different frequency bands. It is equivalent to an oversized zoom scan used in standalone measurements. The measurement volume will be used to enclose all the simultaneous transmitting antennas. For antennas transmitting simultaneously in different frequency bands, the volume scan is measured separately in each frequency band. In order to sum correctly to compute the 1g aggregate SAR, the EUT remain in the same test position for all measurements and all volume scan use the same spatial resolution and grid spacing. When all volume scan were completed, the software, SEMCAD postprocessor can combine and subsequently superpose these measurement data to calculating the multiband SAR.

9.5 SAR Averaged Methods

In DASYS, the interpolation and extrapolation are both based on the modified Quadratic Shepard's method. The interpolation scheme combines a least-square fitted function method and a weighted average method which are the two basic types of computational interpolation and approximation.

Extrapolation routines are used to obtain SAR values between the lowest measurement points and the inner phantom surface. The extrapolation distance is determined by the surface detection distance and the probe sensor offset. The uncertainty increases with the extrapolation distance. To keep the uncertainty within 1% for the 1 g and 10 g cubes, the extrapolation distance should not be larger than 5 mm.

9.6 Power Drift Monitoring

All SAR testing is under the EUT install full charged battery and transmit maximum output power. In DASYS measurement software, the power reference measurement and power drift measurement procedures are used for monitoring the power drift of EUT during SAR test. Both these procedures measure the field at a specified reference position before and after the SAR testing. The software will calculate the field difference in dB. If the power drifts more than 5%, the SAR will be retested.

10. Exposure Positions Consideration

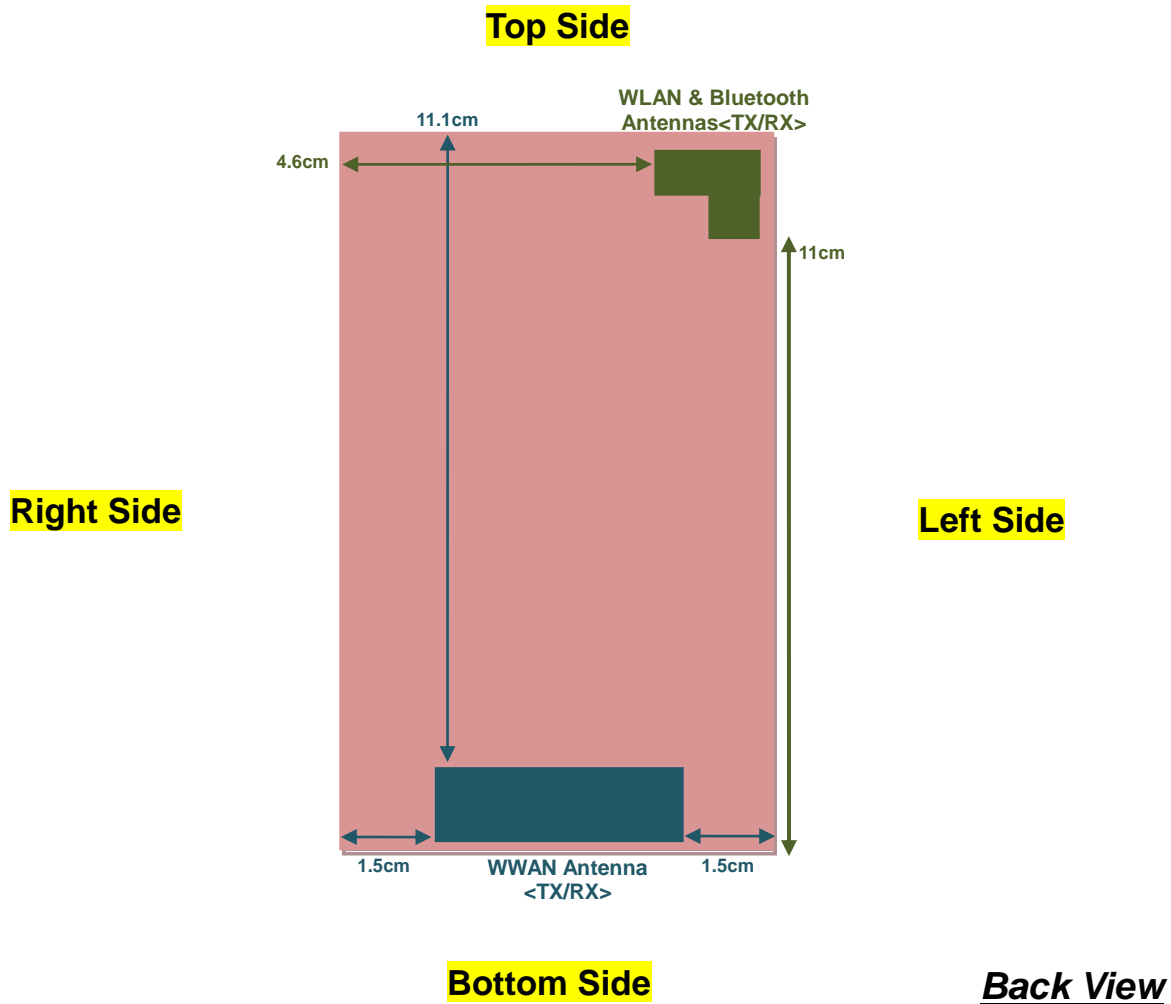

Antennas	Wireless Interface
WWAN Main Antenna (Tx / Rx)	GSM850 GSM1900 WCDMA Band V WCDMA Band II
BT&WLAN Antenna (Tx / Rx)	WLAN 2.4GHz Bluetooth



Distance of the Antenna to the EUT surface/edge Test distance: 10 mm						
Antennas	Back	Front	Top Side	Bottom Side	Right Side	Left Side
WWAN Main	≤ 25mm	≤ 25mm	111mm	≤ 25mm	≤ 25mm	≤ 25mm
BT&WLAN	≤ 25mm	≤ 25mm	≤ 25mm	110mm	46.mm	≤ 25mm

Positions for SAR tests; Hotspot mode Test distance: 10 mm						
Antennas	Back	Front	Top Side	Bottom Side	Right Side	Left Side
WWAN Main	Yes	Yes	NO	Yes	Yes	Yes
BT&WLAN	Yes	Yes	Yes	NO	NO	Yes

- Referring to KDB 941225 D06 v01, when the overall device length and width are ≥ 9cm*5cm, the test distance is 10 mm. SAR must be measured for all sides and surfaces with a transmitting antenna located within 25mm from that surface or edge.
- Per KDB 447498 D01v05, for handsets the *test separation distance* is determined by the smallest distance between the outer surface of the device and the user; which is 0mm for head SAR, 10mm for hotspot SAR and body-worn SAR.
- If the test separation distance (antenna-user) is < 5mm, 5mm is used for excluded SAR calculation
- For minimum test separation distance ≤50mm, Bluetooth standalone SAR test exclusion power threshold is determined by: $[(max. \text{ power of channel, including tune-up tolerance, mW}) / (min. \text{ test separation distance, mm})] \cdot [\sqrt{f(\text{GHz})}] \leq 3.0$ for 1-g SAR and ≤ 7.5 for 10-g extremity SAR. The formula sets the maximum RF power threshold, and the transmitter with RF power equal or less than the power threshold, SAR testing is not required

Exposure Position	Wireless Interface	Bluetooth
	Tune-up Maximum power (dBm)	6
Tune-up Maximum rated power (mW)	3.98	
Head	Antenna to user (mm)	5
	SAR exclusion threshold (mW)	10
	SAR testing required?	NO
Body 1 cm(Hotspot)	Antenna to user (mm)	10
	SAR exclusion threshold (mW)	19
	SAR testing required?	NO
Body 1 cm(Body Worn)	Antenna to user (mm)	10
	SAR exclusion threshold (mW)	19
	SAR testing required?	NO



11. Conducted RF Output Power (Unit: dBm)

<GSM Conducted Power>

Note:

1. Per KDB 447498 D01v05, the maximum output power channel is used for SAR testing and for further SAR test reduction.
2. The EUT do not support DTM function.

Band: GSM850 Channel	Burst Average Power (dBm)			Frame-Average Power (dBm)		
	128	189	251	128	189	251
Frequency (MHz)	824.2	836.4	848.8	824.2	836.4	848.8
GSM (GMSK, 1 Tx slot)	33.28	33.29	33.26	24.28	24.29	24.26
GPRS (GMSK, 1 Tx slot) – CS1	33.25	33.26	33.22	24.25	24.26	24.22
GPRS (GMSK, 2 Tx slots) – CS1	29.24	29.28	29.21	23.24	23.28	23.21
GPRS (GMSK, 3 Tx slots) – CS1	27.89	27.93	27.86	23.63	23.67	23.60
GPRS (GMSK, 4 Tx slots) – CS1	26.88	26.93	26.86	23.88	23.93	23.86
EDGE (GMSK, 1 Tx slot) – MCS1	33.21	33.24	33.18	24.21	24.24	24.18
EDGE (GMSK, 2 Tx slots) – MCS1	29.21	29.24	29.21	23.21	23.24	23.21
EDGE (GMSK, 3 Tx slots) – MCS1	27.88	27.93	27.86	23.62	23.67	23.60
EDGE (GMSK, 4 Tx slots) – MCS1	26.88	26.92	26.85	23.88	23.92	23.85
EDGE (8PSK, 1 Tx slot) – MCS5	26.04	26.24	25.82	17.04	17.24	16.82
EDGE (8PSK, 2 Tx slots) – MCS5	22.34	22.54	22.13	16.34	16.54	16.13
EDGE (8PSK, 3 Tx slots) – MCS5	20.76	20.95	20.51	16.50	16.69	16.25
EDGE (8PSK, 4 Tx slots) – MCS5	19.64	19.84	19.49	16.64	16.84	16.49

Remark: The frame-averaged power is linearly scaled the maximum burst averaged power over 8 time slots.
The calculated method are shown as below:
 Frame-averaged power = Maximum burst averaged power (1 Tx Slot) - 9 dB
 Frame-averaged power = Maximum burst averaged power (2 Tx Slots) - 6 dB
 Frame-averaged power = Maximum burst averaged power (3 Tx Slots) - 4.26 dB
 Frame-averaged power = Maximum burst averaged power (4 Tx Slots) - 3 dB

Note:

1. For Head SAR testing, GSM should be evaluated, therefore the EUT was set in GSM Voice for GSM850 due to its highest frame-average power.
2. For Body worn SAR testing, GSM Voice should be evaluated, therefore the EUT was set in GSM Voice for GSM800 due to its highest frame-average power.
3. For hotspot mode SAR testing, GPRS and EDGE should be evaluated, therefore the EUT was set in GPRS 1 Tx slot for GSM850 due to its highest frame-average power.



Band: GSM1900	Burst Average Power (dBm)			Frame-Average Power (dBm)		
Channel	512	661	810	512	661	810
Frequency (MHz)	1850.2	1880.0	1909.8	1850.2	1880.0	1909.8
GSM (GMSK, 1 Tx slot)	30.45	30.49	30.47	21.45	21.49	21.47
GPRS (GMSK, 1 Tx slot) – CS1	30.35	30.46	30.43	21.35	21.46	21.43
GPRS (GMSK, 2 Tx slots) – CS1	26.56	26.71	26.63	20.56	20.71	20.63
GPRS (GMSK, 3 Tx slots) – CS1	25.21	25.37	25.29	20.95	21.11	21.03
GPRS (GMSK, 4 Tx slots) – CS1	24.17	24.33	24.24	21.17	21.33	21.24
EDGE (GMSK, 1 Tx slot) – MCS1	30.38	30.44	30.41	21.38	21.44	21.41
EDGE (GMSK, 2 Tx slots) – MCS1	26.55	26.70	26.62	20.55	20.70	20.62
EDGE (GMSK, 3 Tx slots) – MCS1	25.21	25.31	25.28	20.95	21.05	21.02
EDGE (GMSK, 4 Tx slots) – MCS1	24.17	24.32	24.24	21.17	21.32	21.24
EDGE (8PSK, 1 Tx slot) – MCS5	25.21	25.38	25.31	16.21	16.38	16.31
EDGE (8PSK, 2 Tx slots) – MCS5	21.83	21.97	21.88	15.83	15.97	15.88
EDGE (8PSK, 3 Tx slots) – MCS5	20.22	20.38	20.28	15.96	16.12	16.02
EDGE (8PSK, 4 Tx slots) – MCS5	19.12	19.18	19.13	16.12	16.18	16.13

Remark: The frame-averaged power is linearly scaled the maximum burst averaged power over 8 time slots.
The calculated method are shown as below:
Frame-averaged power = Maximum burst averaged power (1 Tx Slot) - 9 dB
Frame-averaged power = Maximum burst averaged power (2 Tx Slots) - 6 dB
Frame-averaged power = Maximum burst averaged power (3 Tx Slots) - 4.26 dB
Frame-averaged power = Maximum burst averaged power (4 Tx Slots) - 3 dB

Note

1. For Head SAR testing, GSM should be evaluated, therefore the EUT was set in GSM Voice for GSM1900 due to its highest frame-average power.
2. For Body worn SAR testing, GSM Voice should be evaluated, therefore the EUT was set in GPRS 1 Tx slot for GSM1900 due to its highest frame-average power.
3. For hotspot mode SAR testing, GPRS and EDGE should be evaluated, therefore the EUT was set in GPRS 1 Tx slot for GSM1900 due to its highest frame-average power.

<WCDMA Conducted Power>

The following tests were conducted according to the test requirements outlines in 3GPP TS 34.121 specification. A summary of these settings are illustrated below:

HSDPA Setup Configuration:

- a. The EUT was connected to Base Station Agilent E5515C referred to the Setup Configuration.
- b. The RF path losses were compensated into the measurements.
- c. A call was established between EUT and Base Station with following setting:
 - i. Set Gain Factors (β_c and β_d) and parameters were set according to each
 - ii. Specific sub-test in the following table, C10.1.4, quoted from the TS 34.121
 - iii. Set RMC 12.2Kbps + HSDPA mode.
 - iv. Set Cell Power = -86 dBm
 - v. Set HS-DSCH Configuration Type to FRC (H-set 1, QPSK)
 - vi. Select HSDPA Uplink Parameters
 - vii. Set Delta ACK, Delta NACK and Delta CQI = 8
 - viii. Set Ack-Nack Repetition Factor to 3
 - ix. Set CQI Feedback Cycle (k) to 4 ms
 - x. Set CQI Repetition Factor to 2
 - xi. Power Ctrl Mode = All Up bits
- d. The transmitted maximum output power was recorded.

Table C.10.1.4: β values for transmitter characteristics tests with HS-DPCCH

Sub-test	β_c	β_d	β_d (SF)	β_c/β_d	β_{hs} (Note 1, Note 2)	CM (dB) (Note 3)	MPR (dB) (Note 3)
1	2/15	15/15	64	2/15	4/15	0.0	0.0
2	12/15 (Note 4)	15/15 (Note 4)	64	12/15 (Note 4)	24/15	1.0	0.0
3	15/15	8/15	64	15/8	30/15	1.5	0.5
4	15/15	4/15	64	15/4	30/15	1.5	0.5

Note 1: $\Delta_{ACK}, \Delta_{NACK}$ and $\Delta_{CQI} = 30/15$ with $\beta_{hs} = 30/15 * \beta_c$.

Note 2: For the HS-DPCCH power mask requirement test in clause 5.2C, 5.7A, and the Error Vector Magnitude (EVM) with HS-DPCCH test in clause 5.13.1A, and HSDPA EVM with phase discontinuity in clause 5.13.1AA, Δ_{ACK} and $\Delta_{NACK} = 30/15$ with $\beta_{hs} = 30/15 * \beta_c$, and $\Delta_{CQI} = 24/15$ with $\beta_{hs} = 24/15 * \beta_c$.

Note 3: CM = 1 for $\beta_c/\beta_d = 12/15, \beta_{hs}/\beta_c = 24/15$. For all other combinations of DPDCH, DPCCH and HS-DPCCH the MPR is based on the relative CM difference. This is applicable for only UEs that support HSDPA in release 6 and later releases.

Note 4: For subtest 2 the β_c/β_d ratio of 12/15 for the TFC during the measurement period (TF1, TF0) is achieved by setting the signalled gain factors for the reference TFC (TF1, TF1) to $\beta_c = 11/15$ and $\beta_d = 15/15$.

Setup Configuration

HSUPA Setup Configuration:

- a. The EUT was connected to Base Station Agilent E5515C referred to the Setup Configuration.
- b. The RF path losses were compensated into the measurements.
- c. A call was established between EUT and Base Station with following setting * :
 - i. Call Configs = 5.2B, 5.9B, 5.10B, and 5.13.2B with QPSK
 - ii. Set the Gain Factors (β_c and β_d) and parameters (AG Index) were set according to each specific sub-test in the following table, C11.1.3, quoted from the TS 34.121
 - iii. Set Cell Power = -86 dBm
 - iv. Set Channel Type = 12.2k + HSPA
 - v. Set UE Target Power
 - vi. Power Ctrl Mode= Alternating bits
 - vii. Set and observe the E-TFCl
 - viii. Confirm that E-TFCl is equal to the target E-TFCl of 75 for sub-test 1, and other subtest's E-TFCl
- d. The transmitted maximum output power was recorded.

Table C.11.1.3: β values for transmitter characteristics tests with HS-DPCCH and E-DCH

Sub-test	β_c	β_d	β_d (SF)	β_c/β_d	β_{HS} (Note 1)	β_{ec}	β_{ed} (Note 5) (Note 6)	β_{ed} (SF)	β_{ed} (Codes)	CM (dB) (Note 2)	MPR (dB) (Note 2)	AG Index (Note 6)	E-TFCl
1	11/15 (Note 3)	15/15 (Note 3)	64	11/15 (Note 3)	22/15	209/225	1309/225	4	1	1.0	0.0	20	75
2	6/15	15/15	64	6/15	12/15	12/15	94/75	4	1	3.0	2.0	12	67
3	15/15	9/15	64	15/9	30/15	30/15	$\beta_{ed1}: 47/15$ $\beta_{ed2}: 47/15$	4	2	2.0	1.0	15	92
4	2/15	15/15	64	2/15	4/15	2/15	56/75	4	1	3.0	2.0	17	71
5	15/15 (Note 4)	15/15 (Note 4)	64	15/15 (Note 4)	30/15	24/15	134/15	4	1	1.0	0.0	21	81

Note 1: $\Delta_{ACK}, \Delta_{NACK}$ and $\Delta_{CQI} = 30/15$ with $\beta_{hs} = 30/15 * \beta_c$.

Note 2: CM = 1 for $\beta_c/\beta_d = 12/15, \beta_{hs}/\beta_c = 24/15$. For all other combinations of DPDCH, DPCCH, HS-DPCCH, E-DPDCH and E-DPCCH the MPR is based on the relative CM difference.

Note 3: For subtest 1 the β_c/β_d ratio of 11/15 for the TFC during the measurement period (TF1, TF0) is achieved by setting the signalled gain factors for the reference TFC (TF1, TF1) to $\beta_c = 10/15$ and $\beta_d = 15/15$.

Note 4: For subtest 5 the β_c/β_d ratio of 15/15 for the TFC during the measurement period (TF1, TF0) is achieved by setting the signalled gain factors for the reference TFC (TF1, TF1) to $\beta_c = 14/15$ and $\beta_d = 15/15$.

Note 5: In case of testing by UE using E-DPDCH Physical Layer category 1, Sub-test 3 is omitted according to TS25.306 Table 5.1g.

Note 6: β_{ed} can not be set directly, it is set by Absolute Grant Value.

Setup Configuration



<WCDMA Conducted Power>

Note:

1. Per KDB 941225 D01, RMC 12.2kbps setting is used to evaluate SAR. If AMR 12.2kbps power is < 0.25dB higher than RMC 12.2kbps, SAR tests with AMR 12.2kbps can be excluded.
2. By design, AMR, HSDPA RF power will not be larger than RMC 12.2kbps., detailed information is included in Tune-up Procure exhibit.
3. It is expected by the manufacturer that MPR for some HSDPA subtests may differ from the specification of 3GPP, according to the chipset implementation in this model. The implementation and expected deviation are detailed in tune-up procedure exhibit.

WCDMA Average power (dBm)							
Band		WCDMA Band V			WCDMA Band II		
Channel		4132	4182	4233	9262	9400	9538
Frequency (MHz)		826.4	836.4	846.6	1852.4	1880.0	1907.6
3GPP Rel 99	AMR 12.2Kbps	23.92	24.13	24.28	23.40	23.10	23.06
3GPP Rel 99	RMC 12.2Kbps	23.93	24.14	24.29	23.42	23.12	23.07
3GPP Rel 6	HSDPA Subtest-1	23.99	24.13	24.28	23.39	23.18	23.14
3GPP Rel 6	HSDPA Subtest-2	22.97	23.13	23.28	22.39	22.13	22.10
3GPP Rel 6	HSDPA Subtest-3	22.49	22.66	22.82	21.92	21.69	21.64
3GPP Rel 6	HSDPA Subtest-4	22.48	22.66	22.81	21.89	21.65	21.60

MPR (dB)							
3GPP MPR specification	Subtest	WCDMA Band V			WCDMA Band II		
0	HSDPA Subtest-1	0.00	0.00	0.00	0.00	0.00	0.00
0	HSDPA Subtest-2	1.02	1.00	1.00	1.00	1.05	1.04
≤ 0.5	HSDPA Subtest-3	1.50	1.47	1.46	1.47	1.49	1.50
≤ 0.5	HSDPA Subtest-4	1.51	1.47	1.47	1.50	1.53	1.54



<WLAN 2.4GHz Conducted Power>

WLAN 2.4GHz 802.11b Average Power (dBm)						
Power vs. Channel			Power vs. Data Rate			
Channel	Freq. (MHz)	Data Rate (bps)	Channel	Data Rate (bps)		
		1M		2M	5.5M	11M
CH 1	2412	13.69	CH 6	13.68	13.74	13.76
CH 6	2437	13.7				
CH 11	2462	13.68				

WLAN 2.4GHz 802.11g Average Power (dBm)										
Power vs. Channel			Power vs. Data Rate							
Channel	Frequency (MHz)	Data Rate (bps)	Channel	Data Rate (bps)						
		6M		9M	12M	18M	24M	36M	48M	54M
CH 1	2412	12.12	CH 11	12.08	12.16	12.16	12.16	12.15	12.15	12.16
CH 6	2437	12.09								
CH 11	2462	12.17								

WLAN 2.4GHz 802.11n-HT20 Average Power (dBm)										
Power vs. Channel			Power vs. Data Rate							
Channel	Frequency (MHz)	MCS Index	Channel	MCS Index						
		MCS0		MCS1	MCS2	MCS3	MCS4	MCS5	MCS6	MCS7
CH 1	2412	11.99	CH 11	12.09	12.12	12.15	12.15	12.15	12.15	12.14
CH 6	2437	11.97								
CH 11	2462	12.24								

WLAN 2.4GHz 802.11n-HT40 Average Power (dBm)										
Power vs. Channel			Power vs. Data Rate							
Channel	Frequency (MHz)	MCS Index	Channel	MCS Index						
		MCS0		MCS1	MCS2	MCS3	MCS4	MCS5	MCS6	MCS7
CH 3	2422	11.71	CH 6	11.77	11.77	11.53	11.64	11.68	11.67	11.75
CH 6	2437	12.02								
CH 9	2452	11.55								

Note:

1. Per KDB 248227 D01 v01r02, choose the highest output power channel to test SAR and determine further SAR exclusion
2. For each frequency band, testing at higher data rates and higher order modulations is not required when the maximum average output power for each of these configurations is less than 1/4dB higher than those measured at the lowest data rate
3. Per KDB 248227 D01 v01r02, 11g, 11n-HT20 and 11n-HT40 output power is less than 1/4dB higher than 11b mode, thus the SAR can be excluded.

<Bluetooth Conducted Power>

Channel	Frequency (MHz)	Average power (dBm)		
		Mode		
		GFSK	π/4-DQPSK	8-DPSK
CH 0	2402	5.71	2.97	2.92
CH 39	2441	4.16	1.51	1.48
CH 78	2480	5.61	3.03	2.98

12. SAR Test Results

Note:

- Per KDB 447498 D01v05, the reported SAR is the measured SAR value adjusted for maximum tune-up tolerance.
 $Scaling\ Factor = \frac{tune-up\ limit\ power\ (mW)}{EUT\ RF\ power\ (mW)}$, where tune-up limit is the maximum rated power among all production units.
 $Reported\ SAR(W/kg) = Measured\ SAR(W/kg) * Scaling\ Factor$
- Per KDB 447498 D01v05, for each exposure position, if the highest output channel reported SAR $\leq 0.8W/kg$, other channels SAR testing are not necessary
- For Hotspot SAR testing, per KDB 941225 D06, for EUT dimension $\geq 9cm*5cm$, the test distance is 1cm. SAR must be measured for all surfaces and sides with a transmitting antenna located within 2.5cm from that surface or edge.

12.1 Test Records for Head SAR Test

<GSM SAR>

Plot No.	Band	Mode	Test Position	Ch.	Freq. (MHz)	Burst Average Power (dBm)	Tune-Up Limit (dBm)	Scaling Factor	Power Drift (dB)	Measured SAR1g (W/kg)	Reported SAR1g (W/kg)
73	GSM850	GSM Voice	Right Cheek	189	836.4	33.29	33.5	1.050	0.09	0.593	0.622
74	GSM850	GSM Voice	Right Tilted	189	836.4	33.29	33.5	1.050	0.05	0.375	0.394
75	GSM850	GSM Voice	Left Cheek	189	836.4	33.29	33.5	1.050	-0.04	0.564	0.592
76	GSM850	GSM Voice	Left Tilted	189	836.4	33.29	33.5	1.050	0.04	0.36	0.378
61	GSM1900	GSM Voice	Right Cheek	661	1880	30.49	31	1.125	-0.01	0.481	0.541
62	GSM1900	GSM Voice	Right Tilted	661	1880	30.49	31	1.125	-0.05	0.319	0.359
63	GSM1900	GSM Voice	Left Cheek	661	1880	30.49	31	1.125	0.03	0.455	0.512
64	GSM1900	GSM Voice	Left Tilted	661	1880	30.49	31	1.125	0	0.363	0.408

<WCDMA SAR>

Plot No.	Band	Mode	Test Position	Ch.	Freq. (MHz)	Average Power (dBm)	Tune-Up Limit (dBm)	Scaling Factor	Power Drift (dB)	Measured SAR1g (W/kg)	Reported SAR1g (W/kg)
69	WCDMA V	RMC 12.2Kbps	Right Cheek	4233	846.6	24.29	24.5	1.050	0.01	0.526	0.552
70	WCDMA V	RMC 12.2Kbps	Right Tilted	4233	846.6	24.29	24.5	1.050	0.02	0.321	0.337
71	WCDMA V	RMC 12.2Kbps	Left Cheek	4233	846.6	24.29	24.5	1.050	0.04	0.509	0.534
72	WCDMA V	RMC 12.2Kbps	Left Tilted	4233	846.6	24.29	24.5	1.050	0.02	0.322	0.338
65	WCDMA II	RMC 12.2Kbps	Right Cheek	9262	1852.4	23.42	23.5	1.019	-0.03	0.727	0.741
66	WCDMA II	RMC 12.2Kbps	Right Tilted	9262	1852.4	23.42	23.5	1.019	-0.01	0.532	0.542
67	WCDMA II	RMC 12.2Kbps	Left Cheek	9262	1852.4	23.42	23.5	1.019	0.04	0.709	0.722
68	WCDMA II	RMC 12.2Kbps	Left Tilted	9262	1852.4	23.42	23.5	1.019	0	0.573	0.584

Note:

- Per KDB 941225 D01, RMC 12.2kbps setting is used to evaluate SAR. If HSDPA/HSUPA, output power is $< 0.25dB$ higher than RMC, or reported SAR with RMC 12.2kbps setting is $\leq 1.2W/kg$, HSDPA SAR evaluation can be excluded.



<WLAN SAR DTS>

Plot No.	Band	Mode	Data Rate	Test Position	Ch.	Freq. (MHz)	Average Power (dBm)	Tune-Up Limit (dBm)	Scaling Factor	Power Drift (dB)	Measured SAR1g (W/kg)	Reported SAR1g (W/kg)
51	WLAN2.4GHz	802.11b	1M	Right Cheek	6	2437	13.78	14	1.052	0.02	0.201	0.211
52	WLAN2.4GHz	802.11b	1M	Right Tilted	6	2437	13.78	14	1.052	0.01	0.216	0.227
53	WLAN2.4GHz	802.11b	1M	Left Cheek	6	2437	13.78	14	1.052	0.1	0.096	0.101
54	WLAN2.4GHz	802.11b	1M	Left Tilted	6	2437	13.78	14	1.052	0.05	0.101	0.106

12.2 Test Records for Hotspot SAR Test

<GSM SAR>

Plot No.	Band	Mode	Test Position	Gap (cm)	Ch.	Freq. (MHz)	Average Power (dBm)	Tune-Up Limit (dBm)	Scaling Factor	Power Drift (dB)	Measured SAR1g (W/kg)	Reported SAR1g (W/kg)
1	GSM850	GPRS (1 Tx slots)	Front	1cm	189	836.4	33.26	33.5	1.057	-0.06	0.715	0.756
9	GSM850	GPRS (1 Tx slots)	Front	1cm	128	824.2	33.25	33.5	1.059	0.01	0.782	0.828
10	GSM850	GPRS (1 Tx slots)	Front	1cm	251	848.8	33.22	33.5	1.067	-0.02	0.653	0.696
2	GSM850	GPRS (1 Tx slots)	Back	1cm	189	836.4	33.26	33.5	1.057	-0.03	0.807	0.853
3	GSM850	GPRS (1 Tx slots)	Back	1cm	128	824.2	33.25	33.5	1.059	-0.04	0.873	0.925
8	GSM850	GPRS (1 Tx slots)	Back	1cm	128	824.2	33.25	33.5	1.059	-0.04	0.852	0.902
4	GSM850	GPRS (1 Tx slots)	Back	1cm	251	848.8	33.22	33.5	1.067	0.05	0.735	0.784
5	GSM850	GPRS (1 Tx slots)	Left Side	1cm	189	836.4	33.26	33.5	1.057	0.06	0.43	0.454
6	GSM850	GPRS (1 Tx slots)	Right Side	1cm	189	836.4	33.26	33.5	1.057	-0.05	0.468	0.495
7	GSM850	GPRS (1 Tx slots)	Bottom Side	1cm	189	836.4	33.26	33.5	1.057	0.03	0.103	0.109
12	GSM1900	GPRS (1 Tx slots)	Front	1cm	661	1880	30.46	31	1.132	-0.03	0.511	0.579
11	GSM1900	GPRS (1 Tx slots)	Back	1cm	661	1880	30.46	31	1.132	0.04	0.477	0.540
13	GSM1900	GPRS (1 Tx slots)	Left Side	1cm	661	1880	30.46	31	1.132	-0.02	0.134	0.152
14	GSM1900	GPRS (1 Tx slots)	Right Side	1cm	661	1880	30.46	31	1.132	0.01	0.133	0.151
25	GSM1900	GPRS (1 Tx slots)	Bottom Side	1cm	661	1880	30.46	31	1.132	0.03	0.536	0.607

<WCDMA SAR>

Plot No.	Band	Mode	Test Position	Gap (cm)	Ch.	Freq. (MHz)	Average Power (dBm)	Tune-Up Limit (dBm)	Scaling Factor	Power Drift (dB)	Measured SAR1g (W/kg)	Reported SAR1g (W/kg)
18	WCDMA V	RMC 12.2Kbps	Front	1cm	4233	846.6	24.29	24.5	1.050	0.02	0.664	0.697
15	WCDMA V	RMC 12.2Kbps	Back	1cm	4233	846.6	24.29	24.5	1.050	0.01	0.786	0.825
16	WCDMA V	RMC 12.2Kbps	Back	1cm	4132	826.4	23.93	24.5	1.140	0.02	0.71	0.810
17	WCDMA V	RMC 12.2Kbps	Back	1cm	4182	836.4	24.14	24.5	1.086	-0.01	0.749	0.814
19	WCDMA V	RMC 12.2Kbps	Left Side	1cm	4233	846.6	24.29	24.5	1.050	0	0.36	0.378
20	WCDMA V	RMC 12.2Kbps	Right Side	1cm	4233	846.6	24.29	24.5	1.050	0.01	0.474	0.497
21	WCDMA V	RMC 12.2Kbps	Bottom Side	1cm	4233	846.6	24.29	24.5	1.050	0.02	0.093	0.098
26	WCDMA II	RMC 12.2Kbps	Front	1cm	9262	1852.4	23.42	23.5	1.019	-0.01	0.881	0.897
35	WCDMA II	RMC 12.2Kbps	Front	1cm	9262	1852.4	23.42	23.5	1.019	0	0.83	0.845
28	WCDMA II	RMC 12.2Kbps	Front	1cm	9400	1880	23.12	23.5	1.091	0.02	0.808	0.882
29	WCDMA II	RMC 12.2Kbps	Front	1cm	9538	1907.6	23.07	23.5	1.104	-0.01	0.756	0.835
27	WCDMA II	RMC 12.2Kbps	Back	1cm	9262	1852.4	23.42	23.5	1.019	-0.02	0.802	0.817
30	WCDMA II	RMC 12.2Kbps	Back	1cm	9400	1880	23.12	23.5	1.091	0.01	0.701	0.765
31	WCDMA II	RMC 12.2Kbps	Back	1cm	9538	1907.6	23.07	23.5	1.104	0.01	0.633	0.699
32	WCDMA II	RMC 12.2Kbps	Left Side	1cm	9262	1852.4	23.42	23.5	1.019	0.02	0.227	0.231
33	WCDMA II	RMC 12.2Kbps	Right Side	1cm	9262	1852.4	23.42	23.5	1.019	-0.06	0.192	0.196
34	WCDMA II	RMC 12.2Kbps	Bottom Side	1cm	9262	1852.4	23.42	23.5	1.019	0.01	0.764	0.778

Note:

1. Body SAR, per KDB 941225 D01, RMC 12.2kbps setting is used to evaluate SAR. If HSDPA/HSUPA output power is < 0.25dB higher than RMC, or Reported SAR with RMC 12.2kbps setting is ≤ 1.2W/kg, HSDPA SAR evaluation can be excluded.



<WLAN SAR DTS>

Plot No.	Band	Mode	Test Position	Gap (cm)	Ch.	Freq. (MHz)	Average Power (dBm)	Tune-Up Limit (dBm)	Scaling Factor	Power Drift (dB)	Measured SAR1g (W/kg)	Reported SAR1g (W/kg)
55	WLAN2.4GHz	802.11b	Front	1cm	6	2437	13.78	14	1.052	0.03	0.041	0.043
56	WLAN2.4GHz	802.11b	Back	1cm	6	2437	13.78	14	1.052	0	0.094	0.099
57	WLAN2.4GHz	802.11b	Left Side	1cm	6	2437	13.78	14	1.052	0.08	0.026	0.027
59	WLAN2.4GHz	802.11b	Top Side	1cm	6	2437	13.78	14	1.052	0.04	0.073	0.077

12.3 Test Records for Body-worn SAR Test

Note:

1. Per KDB 941225 D06, when the same wireless modes and device transmission configurations are required for testing body-worn accessories and hotspot mode, it is not necessary to test body-worn accessory SAR for the same device orientation if the test separation distance for hotspot mode is more conservative than that used for body-worn accessories. In this report, the worst exposure position is the back and front exposure position of the device.
2. Body-worn exposure conditions are intended to voice call operations, therefore GSM voice call is selected to be tested at the back and front exposure position.
3. Per KDB 648474 D04v01, when the *reported* SAR for a body-worn accessory measured without a headset connected to the handset is ≤ 1.2 W/kg, SAR testing with a headset connected to the handset is not required.

<GSM SAR>

Plot No.	Band	Mode	Test Position	Gap (cm)	Ch.	Freq. (MHz)	Average Power (dBm)	Tune-Up Limit (dBm)	Scaling Factor	Power Drift (dB)	Measured SAR1g (W/kg)	Reported SAR1g (W/kg)
22	GSM850	GSM Voice	Back	1cm	189	836.4	33.29	33.5	1.050	-0.02	0.8	0.840
23	GSM850	GSM Voice	Back	1cm	128	824.2	33.28	33.5	1.052	0.04	0.858	0.903
24	GSM850	GSM Voice	Back	1cm	251	848.8	33.26	33.5	1.057	0.01	0.752	0.795
77	GSM1900	GSM Voice	Front	1cm	661	1880	30.46	31	1.132	-0.01	0.537	0.608

<WCDMA SAR>

Plot No.	Band	Mode	Test Position	Gap (cm)	Ch.	Freq. (MHz)	Average Power (dBm)	Tune-Up Limit (dBm)	Scaling Factor	Power Drift (dB)	Measured SAR1g (W/kg)	Reported SAR1g (W/kg)
15	WCDMA V	RMC 12.2Kbps	Back	1cm	4233	846.6	24.29	24.5	1.050	0.01	0.786	0.825
16	WCDMA V	RMC 12.2Kbps	Back	1cm	4132	826.4	23.93	24.5	1.140	0.02	0.71	0.810
17	WCDMA V	RMC 12.2Kbps	Back	1cm	4182	836.4	24.14	24.5	1.086	-0.01	0.749	0.814
26	WCDMA II	RMC 12.2Kbps	Front	1cm	9262	1852.4	23.42	23.5	1.019	-0.01	0.881	0.897
28	WCDMA II	RMC 12.2Kbps	Front	1cm	9400	1880	23.12	23.5	1.091	0.02	0.808	0.882
29	WCDMA II	RMC 12.2Kbps	Front	1cm	9538	1907.6	23.07	23.5	1.104	-0.01	0.756	0.835

<WLAN SAR - DTS>

Plot No.	Band	Mode	Test Position	Gap (cm)	Ch.	Freq. (MHz)	Average Power (dBm)	Tune-Up Limit (dBm)	Scaling Factor	Power Drift (dB)	Measured SAR1g (W/kg)	Reported SAR1g (W/kg)
56	WLAN2.4G	802.11b	Back	1cm	6	2437	13.78	14	1.052	0	0.094	0.099



12.4 Repeated SAR Measurement

Plot No.	Band	Mode	Test Position	Gap (cm)	Ch.	Freq. (MHz)	Burst Average Power (dBm)	Tune-up Limit (dBm)	Tune-up Scaling Factor	Power Drift (dB)	Measured SAR1g (W/kg)	Reported SAR1g (W/kg)
3	GSM850	GPRS (1 Tx slots)	Back	1cm	128	824.2	33.25	33.5	1.059	-0.04	0.873	0.925
8	GSM850	GPRS (1 Tx slots)	Back	1cm	128	824.2	33.25	33.5	1.059	-0.04	0.852	0.902
26	WCDMA II	RMC 12.2Kbps	Front	1cm	9262	1852.4	23.42	23.5	1.019	-0.01	0.881	0.897
35	WCDMA II	RMC 12.2Kbps	Front	1cm	9262	1852.4	23.42	23.5	1.019	0	0.83	0.845

Note:

1. Per KDB 865664 D01v01, for each frequency band, repeated SAR measurement is required only when the measured SAR is $\geq 0.8W/kg$
2. Per KDB 865664 D01v01, if the deviation among the repeated measurement is $\leq 20\%$ and the measured SAR $< 1.45W/kg$, only one repeated measurement is required.
3. The deviation is the difference in percentage between original and repeated *measured SAR*.
4. All measurement SAR result is scaled-up to account for tune-up tolerance and is compliant.

12.5 Highest SAR Plot

Test Laboratory: Sporton International Inc. SAR/HAC Testing Lab

Date: 2013/1/13

#03_GSM850_GPRS (1 Tx slots)_Back_1cm_Ch128

DUT: 2D2653

Communication System: GSM850; Frequency: 824.2 MHz; Duty Cycle: 1:8.3
 Medium: MSL_850_130113 Medium parameters used: $f = 824.2$ MHz; $\sigma = 0.954$ mho/m; $\epsilon_r = 54.652$; $\rho = 1000$ kg/m³
 Ambient Temperature : 22.5 °C; Liquid Temperature : 21.5 °C

DASY5 Configuration:

- Probe: ES3DV3 - SN3270; ConvF(6.16, 6.16, 6.16); Calibrated: 2012/9/28;
- Sensor-Surface: 3mm (Mechanical Surface Detection)
- Electronics: DAE4 Sn778; Calibrated: 2012/8/27
- Phantom: SAM-Right; Type: QD 000 P40 C; Serial: TP-1446
- Measurement SW: DASY52, Version 52.8 (2); SEMCAD X Version 14.6.6 (6477)

Configuration/Ch128/Area Scan (61x101x1): Measurement grid: dx=15mm, dy=15mm
 Maximum value of SAR (interpolated) = 0.974 mW/g

Configuration/Ch128/Zoom Scan (5x5x7)/Cube 0: Measurement grid: dx=8mm, dy=8mm, dz=5mm
 Reference Value = 32.967 V/m; Power Drift = -0.04 dB
 Peak SAR (extrapolated) = 1.135 mW/g
SAR(1 g) = 0.873 mW/g; SAR(10 g) = 0.643 mW/g
 Maximum value of SAR (measured) = 0.972 mW/g

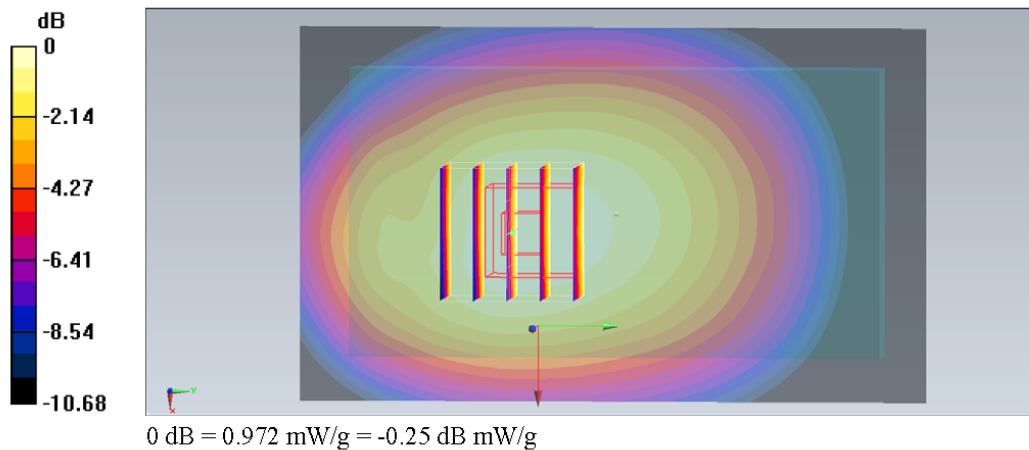

Test Laboratory: Sporton International Inc. SAR/HAC Testing Lab

Date: 2013/1/13

#15_WCDMA V_RMC 12.2Kbps_Back_1cm_Ch4233

DUT: 2D2653

Communication System: WCDMA; Frequency: 846.6 MHz; Duty Cycle: 1:1
 Medium: MSL_850_130113 Medium parameters used: $f = 847$ MHz; $\sigma = 0.975$ mho/m; $\epsilon_r = 54.418$; $\rho = 1000$ kg/m³
 Ambient Temperature : 22.5 °C ; Liquid Temperature : 21.5 °C

DASY5 Configuration:

- Probe: ES3DV3 - SN3270; ConvF(6.16, 6.16, 6.16); Calibrated: 2012/9/28;
- Sensor-Surface: 3mm (Mechanical Surface Detection)
- Electronics: DAE4 Sn778; Calibrated: 2012/8/27
- Phantom: SAM-Right; Type: QD 000 P40 C; Serial: TP-1446
- Measurement SW: DASY52, Version 52.8 (2); SEMCAD X Version 14.6.6 (6477)

Configuration/Ch4233/Area Scan (61x101x1): Measurement grid: dx=15mm, dy=15mm
 Maximum value of SAR (interpolated) = 0.863 mW/g

Configuration/Ch4233/Zoom Scan (5x5x7)/Cube 0: Measurement grid: dx=8mm, dy=8mm, dz=5mm
 Reference Value = 30.730 V/m; Power Drift = 0.01 dB
 Peak SAR (extrapolated) = 1.016 mW/g
SAR(1 g) = 0.786 mW/g; SAR(10 g) = 0.579 mW/g
 Maximum value of SAR (measured) = 0.872 mW/g

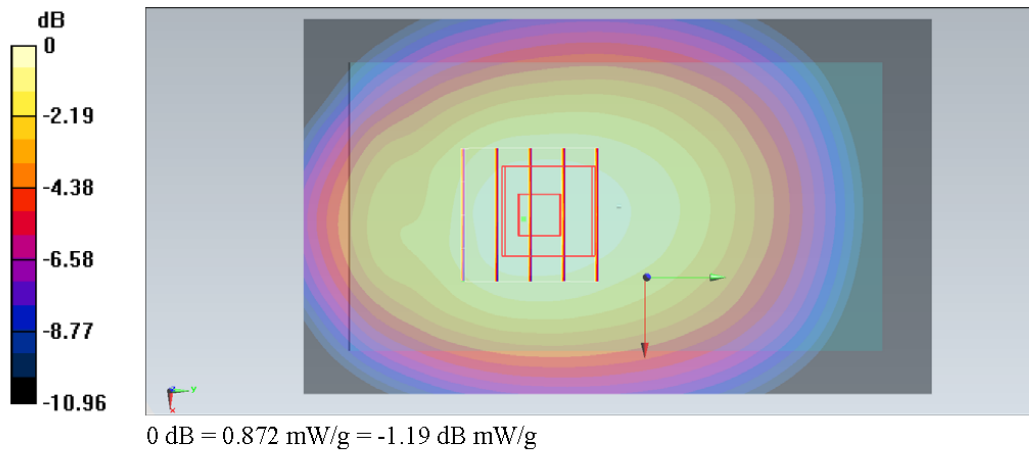

Test Laboratory: Sporton International Inc. SAR/HAC Testing Lab

Date: 2013/1/14

#26_WCDMA II_RMC 12.2Kbps_Front_1cm_Ch9262

DUT: 2D2653

Communication System: WCDMA; Frequency: 1852.4 MHz; Duty Cycle: 1:1
 Medium: MSL_1900_130114 Medium parameters used : $f = 1852.4$ MHz; $\sigma = 1.49$ mho/m; $\epsilon_r = 52.867$;
 $\rho = 1000$ kg/m³
 Ambient Temperature : 22.5 °C; Liquid Temperature : 21.5 °C

DASY5 Configuration:

- Probe: ES3DV3 - SN3270; ConvF(4.67, 4.67, 4.67); Calibrated: 2012/9/28;
- Sensor-Surface: 3mm (Mechanical Surface Detection)
- Electronics: DAE4 Sn778; Calibrated: 2012/8/27
- Phantom: SAM-Left; Type: QD 000 P40 C; Serial: TP-1478
- Measurement SW: DASY52, Version 52.8 (2); SEMCAD X Version 14.6.6 (6477)

Configuration/Ch9262/Area Scan (61x101x1): Measurement grid: dx=15mm, dy=15mm
 Maximum value of SAR (interpolated) = 1.16 mW/g

Configuration/Ch9262/Zoom Scan (5x5x7)/Cube 0: Measurement grid: dx=8mm, dy=8mm, dz=5mm

Reference Value = 27.577 V/m; Power Drift = -0.01 dB

Peak SAR (extrapolated) = 1.468 mW/g

SAR(1 g) = 0.881 mW/g; SAR(10 g) = 0.529 mW/g

Maximum value of SAR (measured) = 1.06 mW/g

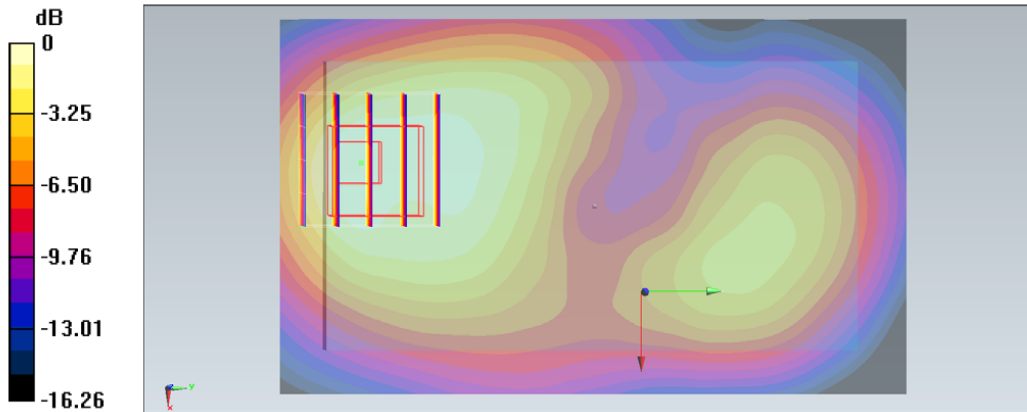

0 dB = 1.06 mW/g = 0.51 dB mW/g

Test Laboratory: Sporton International Inc. SAR/HAC Testing Lab

Date: 2013/1/19

#79_WLAN2.4G_802.11b_Right Tilted_Ch6

DUT: 2D2653

Communication System: 802.11b; Frequency: 2437 MHz; Duty Cycle: 1:1
 Medium: HSL_2450_130119 Medium parameters used: $f = 2437 \text{ MHz}$; $\sigma = 1.812 \text{ mho/m}$; $\epsilon_r = 38.74$; $\rho = 1000 \text{ kg/m}^3$
 Ambient Temperature : 22.6 °C; Liquid Temperature : 21.6 °C

DASY5 Configuration:

- Probe: ES3DV3 - SN3270; ConvF(4.45, 4.45, 4.45); Calibrated: 2012/9/28;
- Sensor-Surface: 3mm (Mechanical Surface Detection)
- Electronics: DAE4 Sn778; Calibrated: 2012/8/27
- Phantom: SAM-Left; Type: QD 000 P40 C; Serial: TP-1478
- Measurement SW: DASY52, Version 52.8 (2); SEMCAD X Version 14.6.6 (6477)

Configuration/Ch6/Area Scan (71x121x1): Measurement grid: dx=12mm, dy=12mm
 Maximum value of SAR (interpolated) = 0.273 mW/g

Configuration/Ch6/Zoom Scan (7x7x7)/Cube 0: Measurement grid: dx=5mm, dy=5mm, dz=5mm
 Reference Value = 13.178 V/m; Power Drift = 0.01 dB
 Peak SAR (extrapolated) = 0.492 mW/g
SAR(1 g) = 0.216 mW/g; SAR(10 g) = 0.088 mW/g
 Maximum value of SAR (measured) = 0.290 mW/g

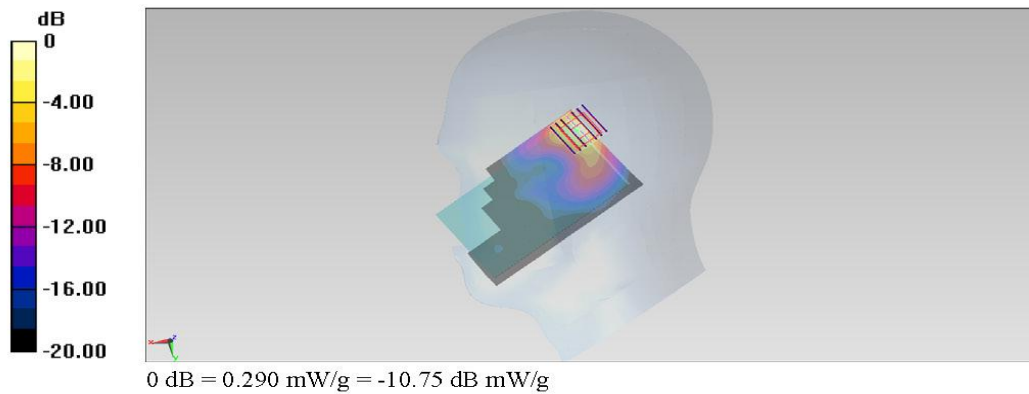

12.6 Simultaneous Multi-band Transmission Analysis

No.	Applicable Simultaneous Transmission Combination
1.	GSM/WCDMA(Voice) + BT
2.	GSM/WCDMA(Voice) + WLAN 2.4GHz(data)
3.	GPRS/EDGE/WCDMA(data) + WLAN 2.4GHz (router)

Note:

1. WLAN and Bluetooth share the same antenna, and cannot transmit simultaneously.
2. GSM/WCDMA share the same antenna, and cannot transmit simultaneously
3. The Scaled SAR summation is calculated based on the same configuration and test position.
4. Simultaneous transmission analysis for hotspot mode 1cm separation to the body represents the compliance for hand-held and near-body use conditions. Simultaneous transmission of Hotspot mode for head and body-worn conditions was covered under simultaneous transmission analysis of head and body-worn positions, due to the possible WWAN voice call and data transmission SAR was considered in standalone SAR measurement for those exposure positions
5. For simultaneous transmission analysis, Bluetooth SAR is estimated per KDB 447498 D01v05 based on the formula below.
 - i) $(\text{max. power of channel, including tune-up tolerance, mW}) / (\text{min. test separation distance, mm}) \cdot [\sqrt{f(\text{GHz})} \cdot x] \text{ W/kg}$ for test separation distances $\leq 50 \text{ mm}$; where $x = 7.5$ for 1-g SAR, and $x = 18.75$ for 10-g SAR.
 - ii) 0.4 W/kg for 1-g SAR and 1.0 W/kg for 10-g SAR, when the test separation distances is $> 50 \text{ mm}$.

Max Power Average Power	Exposure Position	Head	Body 1cm
	Test separation	5 mm	10 mm
6 dBm	Antenna to user distance	5 mm	10 mm
	Estimated SAR (W/kg)	0.167 W/kg	0.084 W/kg

6. Per KDB 447498 D01v05, simultaneous transmission SAR is compliant if,
 - (i) Scalar SAR summation $< 1.6 \text{ W/kg}$.
 - (ii) $\text{SPLSR} = (\text{SAR1} + \text{SAR2}) \cdot 1.5 / (\text{min. separation distance, mm})$, and the peak separation distance is determined from the square root of $[(x1-x2)^2 + (y1-y2)^2 + (z1-z2)^2]$, where $(x1, y1, z1)$ and $(x2, y2, z2)$ are the coordinates of the extrapolated peak SAR locations in the zoom scan
If $\text{SPLSR} \leq 0.04$, simultaneously transmission SAR measurement is not necessary
 - (iii) Simultaneously transmission SAR measurement, and the reported multi-band SAR $< 1.6 \text{ W/kg}$



<Head SAR Summation >

Position	WWAN			WLAN2.4GHz-DTS		WWAN + WLAN	SPLSR	Case No
	WWAN Band	Plot No	Max. Reported SAR (W/kg)	Plot No	Max. Reported SAR (W/kg)			
Right Cheek	GSM850	73	0.622	78	0.211	0.83		
	GSM1900	61	0.541	78	0.211	0.75		
	WCDMA V	69	0.552	78	0.211	0.76		
	WCDMA II	65	0.741	78	0.211	0.95		
Right Tilted	GSM850	74	0.394	79	0.227	0.62		
	GSM1900	62	0.359	79	0.227	0.59		
	WCDMA V	70	0.337	79	0.227	0.56		
	WCDMA II	66	0.542	79	0.227	0.77		
Left Cheek	GSM850	75	0.592	80	0.101	0.69		
	GSM1900	63	0.512	80	0.101	0.61		
	WCDMA V	71	0.534	80	0.101	0.64		
	WCDMA II	67	0.722	80	0.101	0.82		
Left Tilted	GSM850	76	0.378	81	0.106	0.48		
	GSM1900	64	0.408	81	0.106	0.51		
	WCDMA V	72	0.338	81	0.106	0.44		
	WCDMA II	68	0.584	81	0.106	0.69		

Position	WWAN			Bluetooth-DSS	WWAN + Bluetooth	SPLSR	Case No
	WWAN Band	Plot No	Max. Reported SAR (W/kg)	Estimated SAR (W/kg)			
Right Cheek	GSM850	73	0.622	0.167	0.79		
	GSM1900	61	0.541	0.167	0.71		
	WCDMA V	69	0.552	0.167	0.72		
	WCDMA II	65	0.741	0.167	0.91		
Right Tilted	GSM850	74	0.394	0.167	0.56		
	GSM1900	62	0.359	0.167	0.53		
	WCDMA V	70	0.337	0.167	0.50		
Left Cheek	GSM850	75	0.592	0.167	0.76		
	GSM1900	63	0.512	0.167	0.68		
	WCDMA V	71	0.534	0.167	0.70		
	WCDMA II	67	0.722	0.167	0.89		
Left Tilted	GSM850	76	0.378	0.167	0.55		
	GSM1900	64	0.408	0.167	0.58		
	WCDMA V	72	0.338	0.167	0.51		
	WCDMA II	68	0.584	0.167	0.75		



<Hotspot SAR Summation>

Position	WWAN			WLAN2.4GHz-DTS		WWAN + WLAN	SPLSR	Case No
	WWAN Band	Plot No	Max. Reported SAR (W/kg)	Plot No	Max. Reported SAR (W/kg)			
Front	GSM850	1	0.756	82	0.043	0.80		
	GSM1900	12	0.579	82	0.043	0.62		
	WCDMA V	18	0.697	82	0.043	0.74		
	WCDMA II	26	0.897	82	0.043	0.94		
Back	GSM850	3	0.925	83	0.099	1.02		
	GSM1900	11	0.54	83	0.099	0.64		
	WCDMA V	15	0.825	83	0.099	0.92		
	WCDMA II	27	0.817	83	0.099	0.92		
Left Side	GSM850	5	0.454	84	0.027	0.48		
	GSM1900	13	0.152	84	0.027	0.18		
	WCDMA V	19	0.378	84	0.027	0.41		
	WCDMA II	32	0.231	84	0.027	0.26		
Right Side	GSM850	6	0.495			0.50		
	GSM1900	14	0.151			0.15		
	WCDMA V	20	0.497			0.50		
	WCDMA II	33	0.196			0.20		
Top Side	GSM850			86	0.077	0.08		
	GSM1900			86	0.077	0.08		
	WCDMA V			86	0.077	0.08		
	WCDMA II			86	0.077	0.08		
Bottom Side	GSM850	7	0.109			0.11		
	GSM1900	25	0.607			0.61		
	WCDMA V	21	0.098			0.10		
	WCDMA II	34	0.778			0.78		



Position	WWAN			Bluetooth-DSS	WWAN + Bluetooth	SPLSR	Case No
	WWAN Band	Plot No	Max. Reported SAR (W/kg)	Estimated SAR (W/kg)			
Front	GSM850	1	0.756	0.084	0.84		
	GSM1900	12	0.579	0.084	0.66		
	WCDMA V	18	0.697	0.084	0.78		
	WCDMA II	26	0.897	0.084	0.98		
Back	GSM850	3	0.925	0.084	1.01		
	GSM1900	11	0.54	0.084	0.62		
	WCDMA V	15	0.825	0.084	0.91		
	WCDMA II	27	0.817	0.084	0.90		
Left Side	GSM850	5	0.454	0.084	0.54		
	GSM1900	13	0.152	0.084	0.24		
	WCDMA V	19	0.378	0.084	0.46		
Right Side	WCDMA II	32	0.231	0.084	0.32		
	GSM850	6	0.495		0.50		
	GSM1900	14	0.151		0.15		
	WCDMA V	20	0.497		0.50		
Top Side	WCDMA II	33	0.196		0.20		
	GSM850			0.084	0.08		
	GSM1900			0.084	0.08		
	WCDMA V			0.084	0.08		
Bottom Side	WCDMA II			0.084	0.08		
	GSM850	7	0.109		0.11		
	GSM1900	25	0.607		0.61		
	WCDMA V	21	0.098		0.10		
	WCDMA II	34	0.778		0.78		



<Body-worn SAR Summation>

Position	WWAN			WLAN2.4GHz-DTS		WWAN + WLAN	SPLSR	Case No
	WWAN Band	Plot No	Max. Reported SAR (W/kg)	Plot No	Max. Reported SAR (W/kg)			
Front	GSM850					0.00		
	GSM1900	77	0.608			0.61		
	WCDMA V					0.00		
	WCDMA II	26	0.897			0.90		
Back	GSM850	23	0.903	83	0.099	1.00		
	GSM1900			83	0.099	0.10		
	WCDMA V	15	0.825	83	0.099	0.92		
	WCDMA II			83	0.099	0.10		

Position	WWAN			Bluetooth-DSS	WWAN + Bluetooth	SPLSR	Case No
	WWAN Band	Plot No	Max. Reported SAR (W/kg)	Estimated SAR (W/kg)			
Front	GSM850			0.084	0.08		
	GSM1900	77	0.608	0.084	0.69		
	WCDMA V			0.084	0.08		
	WCDMA II	26	0.897	0.084	0.98		
Back	GSM850	23	0.903	0.084	0.99		
	GSM1900			0.084	0.08		
	WCDMA V	15	0.825	0.084	0.91		
	WCDMA II			0.084	0.08		

Test Engineer : Vic Yang and Aaron Chen

13. Uncertainty Assessment

The component of uncertainty may generally be categorized according to the methods used to evaluate them. The evaluation of uncertainty by the statistical analysis of a series of observations is termed a Type A evaluation of uncertainty. The evaluation of uncertainty by means other than the statistical analysis of a series of observations is termed a Type B evaluation of uncertainty. Each component of uncertainty, however evaluated, is represented by an estimated standard deviation, termed standard uncertainty, which is determined by the positive square root of the estimated variance.

A Type A evaluation of standard uncertainty may be based on any valid statistical method for treating data. This includes calculating the standard deviation of the mean of a series of independent observations; using the method of least squares to fit a curve to the data in order to estimate the parameter of the curve and their standard deviations; or carrying out an analysis of variance in order to identify and quantify random effects in certain kinds of measurement.

A type B evaluation of standard uncertainty is typically based on scientific judgment using all of the relevant information available. These may include previous measurement data, experience, and knowledge of the behavior and properties of relevant materials and instruments, manufacture’s specification, data provided in calibration reports and uncertainties assigned to reference data taken from handbooks. Broadly speaking, the uncertainty is either obtained from an outdoor source or obtained from an assumed distribution, such as the normal distribution, rectangular or triangular distributions indicated in Table 12.1

Uncertainty Distributions	Normal	Rectangular	Triangular	U-Shape
Multi-plying Factor ^(a)	1/k ^(b)	1/√3	1/√6	1/√2

(a) standard uncertainty is determined as the product of the multiplying factor and the estimated range of variations in the measured quantity

(b) κ is the coverage factor

Table 12.1 Standard Uncertainty for Assumed Distribution

The combined standard uncertainty of the measurement result represents the estimated standard deviation of the result. It is obtained by combining the individual standard uncertainties of both Type A and Type B evaluation using the usual “root-sum-squares” (RSS) methods of combining standard deviations by taking the positive square root of the estimated variances.

Expanded uncertainty is a measure of uncertainty that defines an interval about the measurement result within which the measured value is confidently believed to lie. It is obtained by multiplying the combined standard uncertainty by a coverage factor. Typically, the coverage factor ranges from 2 to 3. Using a coverage factor allows the true value of a measured quantity to be specified with a defined probability within the specified uncertainty range. For purpose of this document, a coverage factor two is used, which corresponds to confidence interval of about 95 %. The DASy uncertainty Budget is shown in the following tables.



Error Description	Uncertainty Value (±%)	Probability Distribution	Divisor	Ci (1g)	Ci (10g)	Standard Uncertainty (1g)	Standard Uncertainty (10g)
Measurement System							
Probe Calibration	6.0	Normal	1	1	1	± 6.0 %	± 6.0 %
Axial Isotropy	4.7	Rectangular	√3	0.7	0.7	± 1.9 %	± 1.9 %
Hemispherical Isotropy	9.6	Rectangular	√3	0.7	0.7	± 3.9 %	± 3.9 %
Boundary Effects	1.0	Rectangular	√3	1	1	± 0.6 %	± 0.6 %
Linearity	4.7	Rectangular	√3	1	1	± 2.7 %	± 2.7 %
System Detection Limits	1.0	Rectangular	√3	1	1	± 0.6 %	± 0.6 %
Readout Electronics	0.3	Normal	1	1	1	± 0.3 %	± 0.3 %
Response Time	0.8	Rectangular	√3	1	1	± 0.5 %	± 0.5 %
Integration Time	2.6	Rectangular	√3	1	1	± 1.5 %	± 1.5 %
RF Ambient Noise	3.0	Rectangular	√3	1	1	± 1.7 %	± 1.7 %
RF Ambient Reflections	3.0	Rectangular	√3	1	1	± 1.7 %	± 1.7 %
Probe Positioner	0.4	Rectangular	√3	1	1	± 0.2 %	± 0.2 %
Probe Positioning	2.9	Rectangular	√3	1	1	± 1.7 %	± 1.7 %
Max. SAR Eval.	1.0	Rectangular	√3	1	1	± 0.6 %	± 0.6 %
Test Sample Related							
Device Positioning	2.9	Normal	1	1	1	± 2.9 %	± 2.9 %
Device Holder	3.6	Normal	1	1	1	± 3.6 %	± 3.6 %
Power Drift	5.0	Rectangular	√3	1	1	± 2.9 %	± 2.9 %
Phantom and Setup							
Phantom Uncertainty	4.0	Rectangular	√3	1	1	± 2.3 %	± 2.3 %
Liquid Conductivity (Target)	5.0	Rectangular	√3	0.64	0.43	± 1.8 %	± 1.2 %
Liquid Conductivity (Meas.)	2.5	Normal	1	0.64	0.43	± 1.6 %	± 1.1 %
Liquid Permittivity (Target)	5.0	Rectangular	√3	0.6	0.49	± 1.7 %	± 1.4 %
Liquid Permittivity (Meas.)	2.5	Normal	1	0.6	0.49	± 1.5 %	± 1.2 %
Combined Standard Uncertainty						± 11.0 %	± 10.8 %
Coverage Factor for 95 %						K=2	
Expanded Uncertainty						± 22.0 %	± 21.5 %

Table 12.2 Uncertainty Budget of DASY for frequency range 300 MHz to 3 GHz



14. References

- [1] FCC 47 CFR Part 2 “Frequency Allocations and Radio Treaty Matters; General Rules and Regulations”
- [2] ANSI/IEEE Std. C95.1-1992, “IEEE Standard for Safety Levels with Respect to Human Exposure to Radio Frequency Electromagnetic Fields, 3 kHz to 300 GHz”, September 1992
- [3] IEEE Std. 1528-2003, “Recommended Practice for Determining the Peak Spatial-Average Specific Absorption Rate (SAR) in the Human Head from Wireless Communications Devices: Measurement Techniques”, December 2003
- [4] FCC OET Bulletin 65 (Edition 97-01) Supplement C (Edition 01-01), “Evaluating Compliance with FCC Guidelines for Human Exposure to Radiofrequency Electromagnetic Fields”, June 2001
- [5] SPEAG DASY System Handbook
- [6] FCC KDB 248227 D01 v01r02, “SAR Measurement Procedures for 802.11 a/b/g Transmitters”, May 2007
- [7] FCC KDB 447498 D01 v04, “Mobile and Portable Device RF Exposure Procedures and Equipment Authorization Policies”, November 2009
- [8] FCC KDB 648474 D01 v01r05, “SAR Evaluation Considerations for Handsets with Multiple Transmitters and Antennas”, September 2008
- [9] FCC KDB 941225 D01 v02, “SAR Measurement Procedures for 3G Devices – CDMA 2000 / Ev-Do / WCDMA / HSDPA / HSPA”, October 2007
- [10] FCC KDB 941225 D02 v02 "3GPP R6 HSPA and R7 HSPA+ SAR Guidance", December 2009.
- [11] FCC KDB 941225 D03 v01, “Recommended SAR Test Reduction Procedures for GSM / GPRS / EDGE”, December 2008
- [12] FCC KDB 941225 D04 v01, “Evaluating SAR for GSM/(E)GPRS Dual Transfer Mode”, January 27 2010
- [13] FCC KDB 941225 D05 v01, “SAR Test Considerations for LTE Handsets and Data Modems”, December 15 2010
- [14] FCC KDB 941225 D06 v01, "SAR Evaluation Procedures for Portable Devices with Wireless Router Capabilities", April 2011
- [15] FCC KDB 388624 D02, "Permit But Ask List", December 2011.



Appendix A. Plots of System Performance Check

The plots are shown as follows.



Appendix B. Plots of SAR Measurement

The plots are shown as follows.



Appendix C. DASYS Calibration Certificate

The DASYS calibration certificates are shown as follows.