



# RF TEST REPORT

**Applicant** Micron Electronics LLC.  
**FCC ID** ZKQ-VZM  
**Product** Tracker  
**Brand** Prime  
**Model** VZM  
**Report No.** R1803A0120-R2  
**Issue Date** May 17, 2018

TA Technology (Shanghai) Co., Ltd. tested the above equipment in accordance with the requirements in **FCC CFR47 Part 2 (2017)/ FCC CFR47 Part 27C (2017)**. The test results show that the equipment tested is capable of demonstrating compliance with the requirements as documented in this report.

*Jiang peng Lan*

*Performed by: Jiangpeng Lan*

*Kai Xu*

*Approved by: Kai Xu*

## TA Technology (Shanghai) Co., Ltd.

No.145, Jintang Rd, Tangzhen Industry Park, Pudong Shanghai, China

TEL: +86-021-50791141/2/3

FAX: +86-021-50791141/2/3-8000

## Table of Contents

1	Test Laboratory.....	4
1.1	Notes of the Test Report.....	4
1.2	Test facility.....	4
1.3	Testing Location.....	5
2	General Description of Equipment under Test.....	6
3	Applied Standards.....	7
4	Test Configuration.....	8
5	Test Case Results.....	9
5.1	RF Power Output.....	9
5.2	Effective Isotropic Radiated Power.....	12
5.3	Occupied Bandwidth.....	16
5.4	Band Edge Compliance.....	21
5.5	Peak-to-Average Power Ratio (PAPR).....	39
5.6	Frequency Stability.....	41
5.7	Spurious Emissions at Antenna Terminals.....	44
5.8	Radiates Spurious Emission.....	56
6	Main Test Instruments.....	71
ANNEX A:	EUT Appearance and Test Setup.....	72
A.1	EUT Appearance.....	72
A.2	Test Setup.....	73

## Summary of Measurement Results

Number	Test Case	Clause in FCC rules	Verdict
1	RF power output	2.1046	PASS
2	Effective Isotropic Radiated power	27.50(d)(4) 27.50(b)(10)	PASS
3	Occupied Bandwidth	2.1049	PASS
4	Band Edge Compliance	27.53(h) /27.53(f) /27.53(c)	PASS
5	Peak-to-Average Power Ratio	27.50(d)/KDB971168 D01(5.7)	PASS
6	Frequency Stability	2.1055 / 27.54	PASS
7	Spurious Emissions at Antenna Terminals	2.1051 /27.53(h) /27.53(f)	PASS
8	Radiates Spurious Emission	2.1053 /27.53(h) /27.53(f)	PASS
Date of Testing: March 29, 2018 ~ May 8, 2018			
Note: PASS: The EUT complies with the essential requirements in the standard. FAIL: The EUT does not comply with the essential requirements in the standard.			

# 1 Test Laboratory

## 1.1 Notes of the Test Report

This report shall not be reproduced in full or partial, without the written approval of **TA technology (shanghai) co., Ltd.** The results documented in this report apply only to the tested sample, under the conditions and modes of operation as described herein. Measurement Uncertainties were not taken into account and are published for informational purposes only. This report is written to support regulatory compliance of the applicable standards stated above.

## 1.2 Test facility

### **CNAS (accreditation number: L2264)**

TA Technology (Shanghai) Co., Ltd. has obtained the accreditation of China National Accreditation Service for Conformity Assessment (CNAS).

### **FCC (Designation number: CN1179, Test Firm Registration Number: 446626)**

TA Technology (Shanghai) Co., Ltd. has been listed on the US Federal Communications Commission list of test facilities recognized to perform electromagnetic emissions measurements.

### **IC (recognition number is 8510A)**

TA Technology (Shanghai) Co., Ltd. has been listed by industry Canada to perform electromagnetic emission measurement.

### **VCCI (recognition number is C-4595, T-2154, R-4113, G-10766)**

TA Technology (Shanghai) Co., Ltd. has been listed by industry Japan to perform electromagnetic emission measurement.

### **A2LA (Certificate Number: 3857.01)**

TA Technology (Shanghai) Co., Ltd. has been listed by American Association for Laboratory Accreditation to perform electromagnetic emission measurement.

### 1.3 Testing Location

Company: TA Technology (Shanghai) Co., Ltd.  
Address: No.145, Jintang Rd, Tangzhen Industry Park, Pudong Shanghai, China  
City: Shanghai  
Post code: 201201  
Country: P. R. China  
Contact: Xu Kai  
Telephone: +86-021-50791141/2/3  
Fax: +86-021-50791141/2/3-8000  
Website: <http://www.ta-shanghai.com>  
E-mail: [xukai@ta-shanghai.com](mailto:xukai@ta-shanghai.com)

## 2 General Description of Equipment under Test

### Client Information

<b>Applicant</b>	Micron Electronics LLC.
<b>Applicant address</b>	1001 Yamato Road, Suite 400, Boca Raton, FL 33431, USA
<b>Manufacturer</b>	Micron Electronics LLC.
<b>Manufacturer address</b>	1001 Yamato Road, Suite 400, Boca Raton, FL 33431, USA

### General information

EUT Description			
Model	VZM		
IMEI	866908030003567		
Hardware Version	F302_V1		
Software Version	F302V01.01B01		
Power Supply	Non-rechargeable Battery		
Antenna Type	Monopole Antenna		
Test Mode(s)	LTE Band 4; LTE Band 13		
Test Modulation	(LTE)QPSK 16QAM;		
LTE Category	M1		
Maximum E.I.R.P./ E.R.P.	LTE Band 4:	21.46dBm	
	LTE Band 13:	19.18dBm	
Rated Power Supply Voltage:	3.5V		
Extreme Voltage	Minimum: 3.1V    Maximum: 3.8V		
Extreme Temperature	Lowest: -40°C    Highest: +50°C		
Operating Frequency Range(s)	Mode	Tx (MHz)	Rx (MHz)
	LTE Band 4	1710 ~ 1755	2110 ~ 2155
	LTE Band 13	777 ~ 787	746 ~ 756
EUT Accessory			
Non-rechargeable Battery	Manufacturer: EVE Energy Co., Ltd Model: ER14505-2+SPC1550/W		
\Note: 1. The information of the EUT is declared by the manufacturer.			

### **3 Applied Standards**

According to the specifications of the manufacturer, it must comply with the requirements of the following standards:

#### **Test standards**

**FCC CFR47 Part 2 (2017)**

**FCC CFR47 Part 27C (2017)**

**ANSI/TIA-603-E (2016)**

**KDB 971168 D01 Power Meas License Digital Systems v03r01**

## 4 Test Configuration

Radiated measurements are performed by rotating the EUT in three different orthogonal test planes. EUT stand-up position (Z axis), lie-down position (X, Y axis). Receiver antenna polarization (horizontal and vertical), the worst emission was found in position (Z axis, horizontal polarization) and the worst case was recorded.

All mode and data rates and positions and RB size and modulations were investigated. Subsequently, only the worst case emissions are reported.

The following testing in LTE is set based on the maximum RF Output Power.

The following testing in different Bandwidth is set to detail in the following table:

Test modes are chosen to be reported as the worst case configuration below for LTE Band 4/13:

Test items	Modes	Bandwidth (MHz)						Modulation		RB			Test Channel			
		1.4	3	5	10	15	20	QPSK	16QAM	1	50%	100%	L	M	H	
RF power output	LTE 4	O	O	O	O	O	O	O	O	O	O	O	O	O	O	O
	LTE 13	-	-	O	O	-	-	O	O	O	O	O	O	O	O	O
Effective Isotropic Radiated power	LTE 4	O	O	O	O	O	O	O	O	-	-	O	O	O	O	
	LTE 13	-	-	O	O	-	-	O	O	-	-	O	O	O	O	
Occupied Bandwidth	LTE 4	O	O	O	O	O	O	O	O	-	-	O	O	O	O	
	LTE 13	-	-	O	O	-	-	O	O	-	-	O	O	O	O	
Band Edge Compliance	LTE 4	O	O	O	O	O	O	O	O	O	-	O	O	-	O	
	LTE 13	-	-	O	O	-	-	O	O	O	-	O	O	-	O	
Peak-to-Average Power Ratio	LTE 4	O	O	O	O	O	O	O	O	-	-	O	O	O	O	
	LTE 13	-	-	O	O	-	-	O	O	-	-	O	O	O	O	
Frequency Stability	LTE 4	O	O	O	O	O	O	O	O	-	-	O	-	O	-	
	LTE 13	-	-	O	O	-	-	O	O	-	-	O	-	O	-	
Spurious Emissions at Antenna Terminals	LTE 4	O	O	O	O	O	O	O	-	O	-	-	O	O	O	
	LTE 13	-	-	O	O	-	-	O	-	O	-	-	O	O	O	
Radiates Spurious Emission	LTE 4	O	O	O	O	O	O	O	-	O	-	-	O	O	O	
	LTE 13	-	-	O	O	-	-	O	-	O	-	-	O	O	O	
Note	1. The mark "O" means that this configuration is chosen for testing. 2. The mark "-" means that this configuration is not testing.															



## 5 Test Case Results

### 5.1 RF Power Output

#### Ambient condition

Temperature	Relative humidity	Pressure
23°C ~25°C	45%~50%	101.5kPa

#### Methods of Measurement

During the process of the testing, The EUT is controlled by the Base Station Simulator to ensure max power transmission and proper modulation.

#### Test Setup

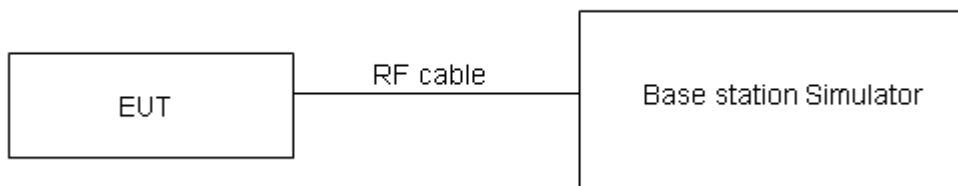

The loss between RF output port of the EUT and the input port of the tester has been taken into consideration.

#### Limits

No specific RF power output requirements in part 2.1046.

#### Measurement Uncertainty

The assessed measurement uncertainty to ensure 95% confidence level for the normal distribution is with the coverage factor  $k = 2$ ,  $U=0.4$  dB.

**Test Results**

Mode	Bandwidth	Channel/ Frequency(MHz)	RB	Index	Conducted Power (dBm)	
					QPSK	16QAM
LTE Band 4	1.4MHz	19957 1710.7	1#0	0	21.81	20.19
			6#0	0	19.74	20.05
		20175/1732.5	1#0	0	21.89	21.18
			6#0	0	20.15	20.24
		20393/1754.3	1#5	0	22.12	20.51
			6#0	0	20.11	20.53
	3MHz	19965/1711.5	1#0	0	21.75	20.11
			6#0	0	19.72	19.85
		20175/1732.5	1#0	0	21.75	21.13
			6#0	0	19.99	20.07
		20385/1753.5	1#5	1	22.08	20.49
			6#0	1	20.15	20.56
	5MHz	19975/1712.5	1#0	0	21.89	21.73
			6#0	0	20.60	20.06
		20175/1732.5	1#0	0	21.75	22.19
			6#0	0	20.89	20.22
		20375/1752.5	1#5	3	22.08	21.46
			6#0	3	21.07	20.31
	10MHz	20000/1715	1#0	0	21.84	21.47
			4#0	0	21.96	21.27
		20175/1732.5	1#0	0	21.32	21.98
			4#0	0	21.71	20.55
		20350/1750	1#5	7	22.05	21.53
			4#2	7	22.04	21.71
	15MHz	20025/1717.5	1#0	0	22.00	21.39
			6#0	0	21.74	22.16
		20175/1732.5	1#0	0	21.33	21.85
			6#0	0	21.46	21.76
		20325/1747.5	1#5	11	22.17	21.62
			6#0	11	22.14	22.23
	20MHz	20050/1720	1#0	0	22.02	21.39
			6#0	0	21.82	22.07
20175/1732.5		1#0	0	21.03	21.99	
		6#0	0	21.36	21.67	
20300/1745		1#5	15	22.19	22.38	
		6#0	15	22.32	22.42	



Mode	Bandwidth	Channel/ Frequency(MHz)	RB	Index	Conducted Power (dBm)	
					QPSK	16QAM
LTE Band 13	5MHz	23205/779.5	1#0	0	21.80	22.31
			6#0	0	21.15	20.32
		23230/782	1#0	0	21.92	21.74
			6#0	0	21.69	20.16
		23255/784.5	1#5	3	21.78	21.50
			6#0	3	20.58	19.89
	10MHz	23230/782	1#0	0	22.11	22.76
			4#0	0	22.34	21.22

## 5.2 Effective Isotropic Radiated Power

### Ambient condition

Temperature	Relative humidity	Pressure
23°C ~25°C	45%~50%	101.5kPa

### Methods of Measurement

1. The testing follows FCC KDB 971168 D01 v03r01 Section 5.8 and ANSI/TIA-603-E (2016).

a) Connect the equipment as illustrated. Mount the equipment with the manufacturer specified antenna in a vertical orientation on a manufacturer specified mounting surface located on a non-conducting rotating platform of a RF anechoic chamber (preferred) or a standard radiation site.

b) Key the transmitter, then rotate the EUT 360° azimuthally and record spectrum analyzer power level (LVL) measurements at angular increments that are sufficiently small to permit resolution of all peaks. If a standard radiation test site is used, raise and lower the test antenna to obtain a maximum reading at each angular increment. (Note: several batteries may be needed to offset the effect of battery voltage droop, which should not exceed 5% of the manufactured specified battery voltage during transmission).

c) Replace the transmitter under test with a vertically polarized half-wave dipole (or an antenna whose gain is known relative to an ideal half-wave dipole). The center of the antenna should be at the same location as the center of the antenna under test.

d) Connect the antenna to a signal generator with a known output power and record the path loss (in dB) as LOSS. If a standard radiation test site is used, raise and lower the test antenna to obtain a maximum reading.  $LOSS = \text{Generator Output Power (dBm)} - \text{Analyzer reading (dBm)}$

e) Determine the effective radiated output power at each angular position from the readings in steps b) and d) using the following equation:  $ERP \text{ (dBm)} = LVL \text{ (dBm)} + LOSS \text{ (dB)}$

f) The maximum ERP is the maximum value determined in the preceding step.

g) When calculating ERP, in addition to knowing the antenna radiation and matching characteristics, it is necessary to know the loss values of all elements (e.g. transmission line attenuation, mismatches, filters, combiners) interposed between the point where transmitter output power is measured, and the point where power is applied to the antenna. ERP can then be calculated as follows:

$$ERP \text{ (dBm)} = \text{Output Power (dBm)} - \text{Losses (dB)} + \text{Antenna Gain (dBd)}$$

where: dBd refers to gain relative to an ideal dipole.

$$EIRP \text{ (dBm)} = ERP \text{ (dBm)} + 2.15 \text{ (dB.)}$$

**Test setup**

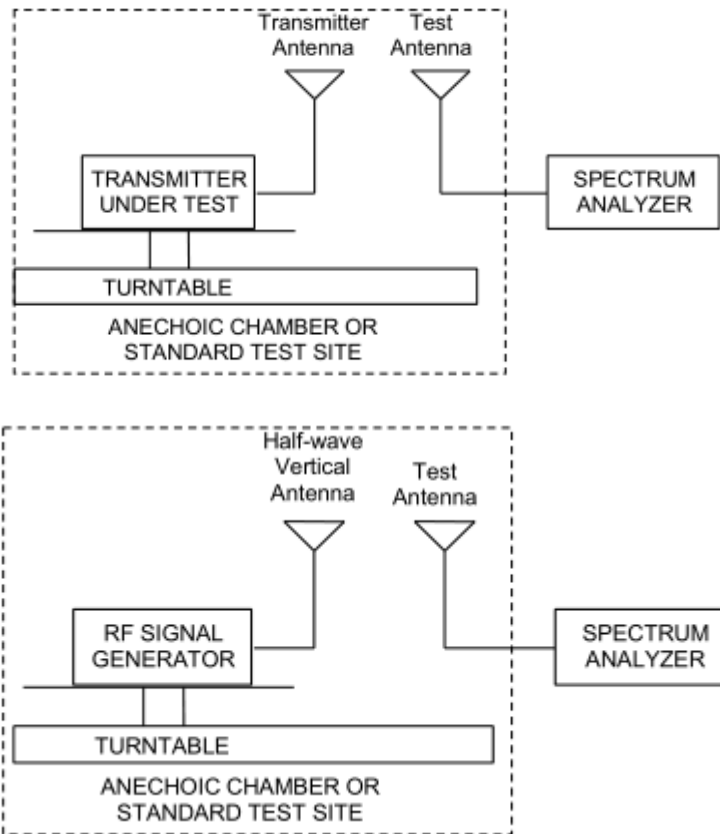

Note: Area side:2.4mX3.6m

The radiated emission was measured in the following position: EUT stand-up position (Z axis), lie-down position (X, Y axis). The worst emission was found in stand-up position (Z axis) and the worst case was recorded.

**Limits**

Rule Part 27.50(b) (10) specifies that “Portable stations (hand-held devices) transmitting in the 746-757 MHz, 776-788 MHz, and 805-806 MHz bands are limited to 3 watts ERP”

Rule Part 27.50(d) (4) specifies that “Fixed, mobile and portable (hand-held) stations operating in the 1710–1755 MHz band are limited to 1 watt EIRP”

Part 27.50(b)(10)Limit	≤ 3 W (34.77 dBm)
Part 27.50(d)(4)Limit	≤ 1 W (30 dBm)

**Measurement Uncertainty**

The assessed measurement uncertainty to ensure 95% confidence level for the normal distribution is with the coverage factor  $k = 2$ ,  $U = 1.19$  dB

**Test Results**

The measurement is performed for both of horizontal and vertical antenna Polarization, and only the data of worst mode is recorded in this report.

LTE Band 4							
Band width	Frequency (MHz)	Ant Pot (H/V)	RB	Index	EIRP (dBm)	Limit (dBm)	Conclusion
1.4MHz (QPSK)	1710.7	H	1#0	0	20.24	30	Pass
	1732.5	H	1#2	0	21.46	30	Pass
	1754.3	H	1#5	0	20.43	30	Pass
1.4MHz (16QAM)	1710.7	H	1#0	0	20.05	30	Pass
	1732.5	H	1#2	0	21.27	30	Pass
	1754.3	H	1#5	0	20.24	30	Pass
3MHz (QPSK)	1711.5	H	1#0	0	20.31	30	Pass
	1732.5	H	1#5	0	21.32	30	Pass
	1753.5	H	1#5	1	20.28	30	Pass
3MHz (16QAM)	1711.5	H	1#0	0	20.12	30	Pass
	1732.5	H	1#5	0	20.87	30	Pass
	1753.5	H	1#5	1	20.09	30	Pass
5MHz (QPSK)	1712.5	H	1#0	0	20.97	30	Pass
	1732.5	H	1#5	1	20.36	30	Pass
	1752.5	H	1#5	3	20.99	30	Pass
5MHz (16QAM)	1712.5	H	1#0	0	20.78	30	Pass
	1732.5	H	1#5	1	20.17	30	Pass
	1752.5	H	1#5	3	20.80	30	Pass
10MHz (QPSK)	1715	H	4#0	0	20.88	30	Pass
	1732.5	H	4#2	3	20.28	30	Pass
	1750	H	4#2	7	21.08	30	Pass
10MHz (16QAM)	1715	H	4#0	0	20.69	30	Pass
	1732.5	H	4#2	3	20.09	30	Pass
	1750	H	4#2	7	20.89	30	Pass
15MHz (QPSK)	1717.5	H	1#0	0	20.34	30	Pass
	1732.5	H	1#5	5	20.87	30	Pass
	1747.5	H	1#5	11	20.36	30	Pass
15MHz (16QAM)	1717.5	H	1#0	0	20.15	30	Pass
	1732.5	H	1#5	5	20.68	30	Pass
	1747.5	H	1#5	11	20.17	30	Pass
20MHz (QPSK)	1720	H	6#0	0	20.54	30	Pass
	1732.5	H	6#0	7	21.02	30	Pass
	1745	H	6#0	15	20.66	30	Pass
20MHz (16QAM)	1720	H	6#0	0	20.35	30	Pass
	1732.5	H	6#0	7	20.83	30	Pass
	1745	H	6#0	15	20.47	30	Pass



LTE Band 13							
Band width	Frequency (MHz)	Ant Pot (H/V)	RB	Index	ERP (dBm)	Limit (dBm)	Conclusion
5MHz (QPSK)	779.5	H	1#0	0	19.18	34.77	Pass
	782	H	1#5	1	19.04	34.77	Pass
	784.5	H	1#5	3	18.93	34.77	Pass
10MHz (QPSK)	782	H	4#2	3	18.16	34.77	Pass
5MHz (16QAM)	779.5	H	1#0	0	18.87	34.77	Pass
	782	H	1#5	1	18.92	34.77	Pass
	784.5	H	1#5	3	18.64	34.77	Pass
10MHz (16QAM)	782	H	4#2	3	17.88	34.77	Pass

Note: 1. EIRP= E.R.P+2.15

### 5.3 Occupied Bandwidth

#### Ambient condition

Temperature	Relative humidity	Pressure
23°C ~25°C	45%~50%	101.5kPa

#### Method of Measurement

The EUT was connected to Spectrum Analyzer and Base Station Simulator via power Splitter. The occupied bandwidth is measured using spectrum analyzer.

RBW is set to 51 kHz, VBW is set to 160 kHz for LTE Band 4.

RBW is set to 51kHz, VBW is set to 160kHz for LTE Band 13

99% power and -26dBc occupied bandwidths are recorded. Spectrum analyzer plots are included on the following pages.

#### Test Setup

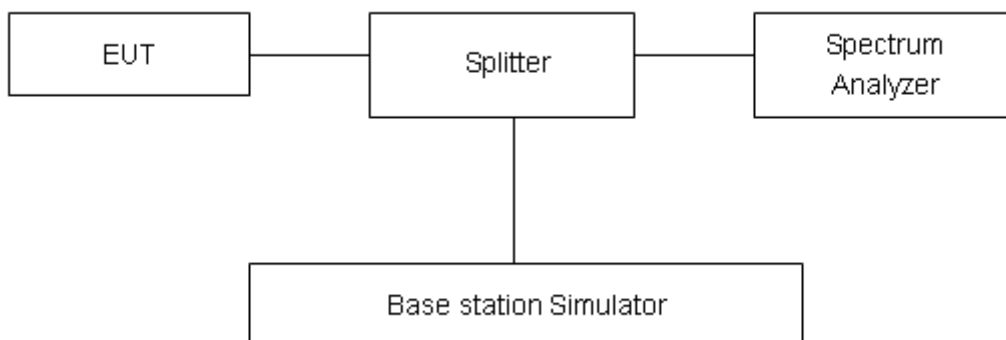

#### Limits

No specific occupied bandwidth requirements in part 2.1049.

#### Measurement Uncertainty

The assessed measurement uncertainty to ensure 95% confidence level for the normal distribution is with the coverage factor  $k = 2$ ,  $U=624\text{Hz}$ .



**Test Result**

Mode	Bandwidth	Modulation	Channel/ Frequency(MHz)	RB	Index	Bandwidth(MHz)	
						99% Power	-26dBc
LTE Band 4	1.4MHz	QPSK	20175/1732.5	6#0	0	1.1148	1.397
		16QAM	20175/1732.5	6#0	0	0.94189	1.384
	3MHz	QPSK	20175/1732.5	6#0	0	1.1521	1.580
		16QAM	20175/1732.5	6#0	0	0.98945	1.437
	5MHz	QPSK	20175/1732.5	6#0	0	1.1545	1.538
		16QAM	20175/1732.5	6#0	0	0.98896	1.593
	10MHz	QPSK	20175/1732.5	6#0	0	1.2237	2.222
		16QAM	20175/1732.5	6#0	0	1.1401	1.803
	15MHz	QPSK	20175/1732.5	6#0	0	1.2458	2.340
		16QAM	20175/1732.5	6#0	0	1.1128	1.891
	20MHz	QPSK	20175/1732.5	6#0	0	1.2113	2.031
		16QAM	20175/1732.5	6#0	0	1.1127	1.920

Mode	Bandwidth	Modulation	Channel/ Frequency(MHz)	RB	Index	Bandwidth(MHz)	
						99% Power	-26dBc
LTE Band 13	5MHz	QPSK	23230/782	6#0	0	1.1543	1.507
		16QAM	23230/782	6#0	0	0.99325	1.421
	10MHz	QPSK	23230/782	6#0	0	1.2047	1.900
		16QAM	23230/782	6#0	0	1.0753	1.626



### LTE Band 4 QPSK 1.4MHz CH-Middle

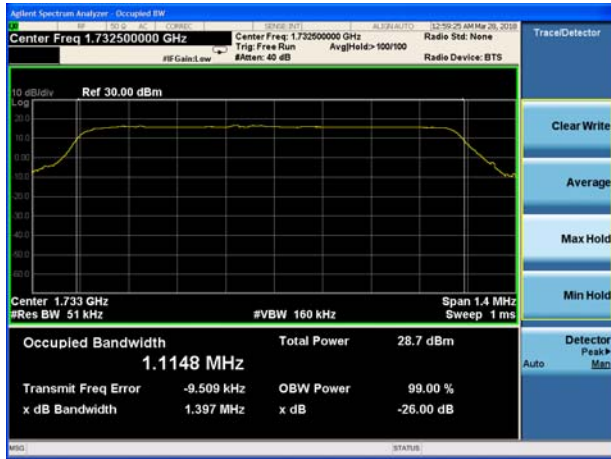

### LTE Band 4 QPSK 3MHz CH-Middle



### LTE Band 4 QPSK 5MHz CH-Middle

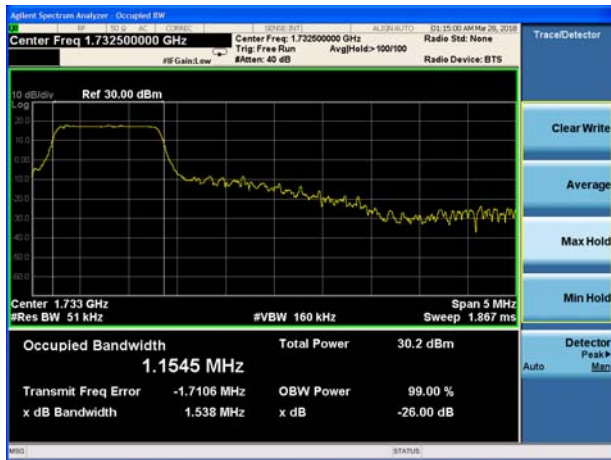

### LTE Band 4 QPSK 10MHz CH-Middle



### LTE Band 4 QPSK 15MHz CH-Middle

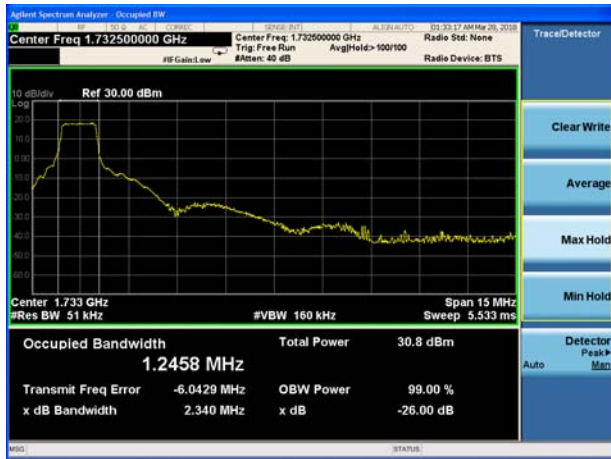

### LTE Band 4 QPSK 20MHz CH-Middle



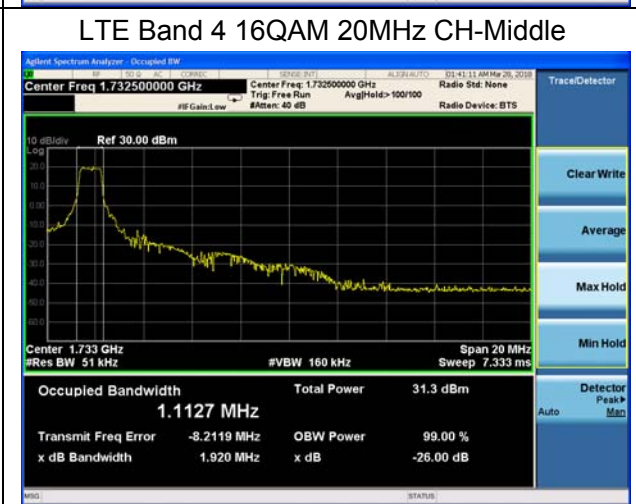
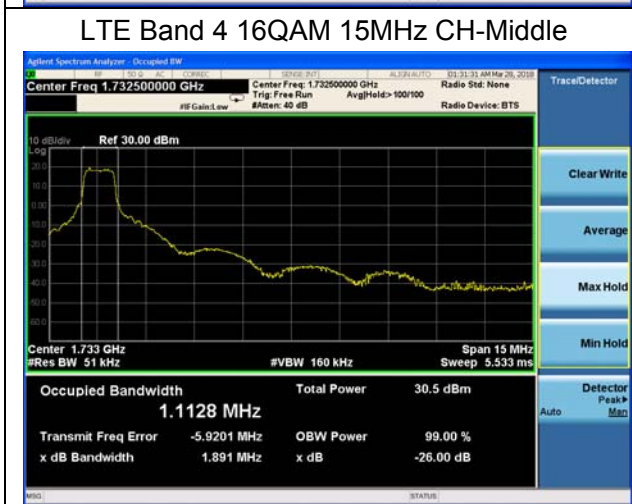
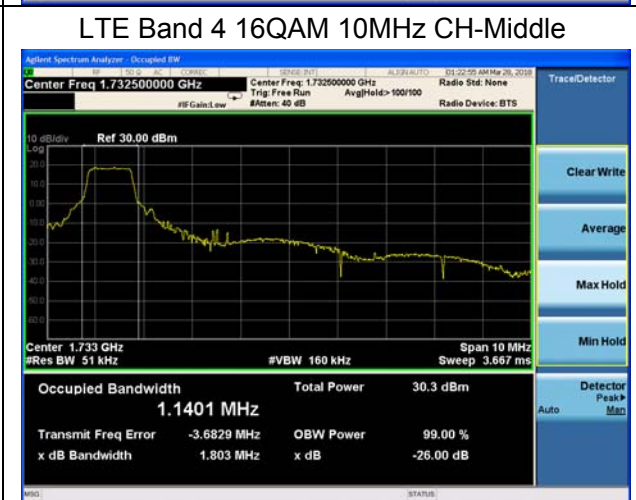
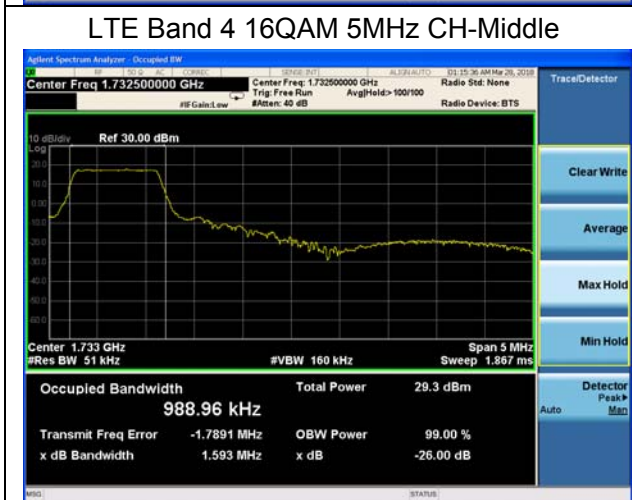
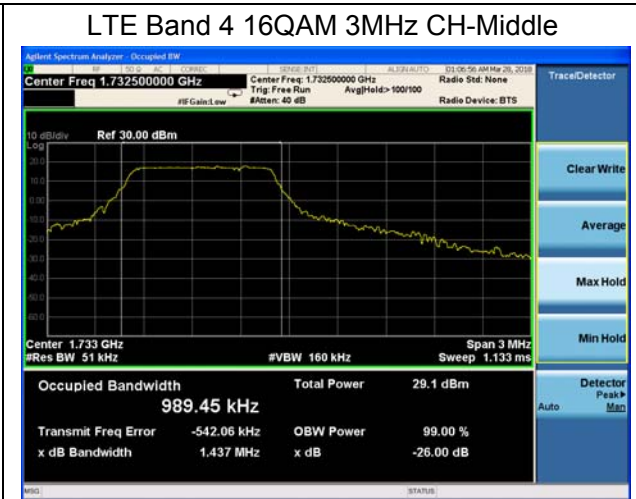
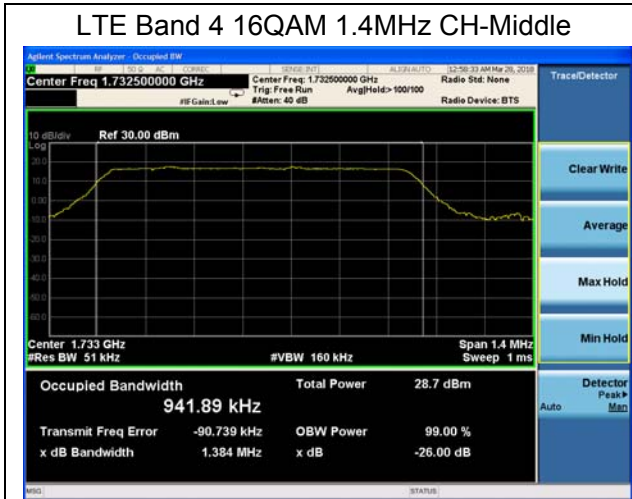

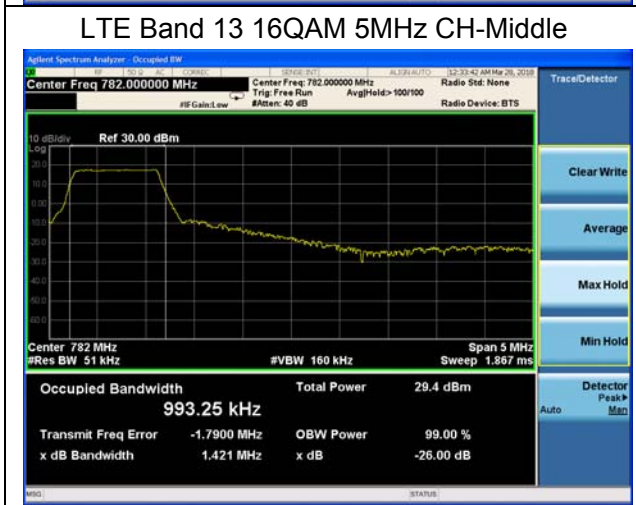
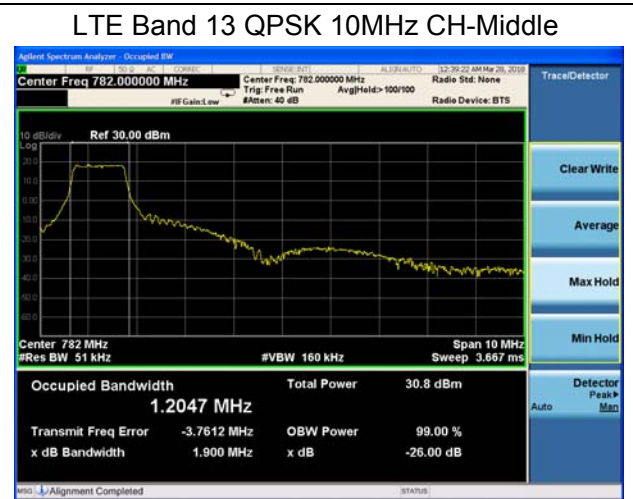
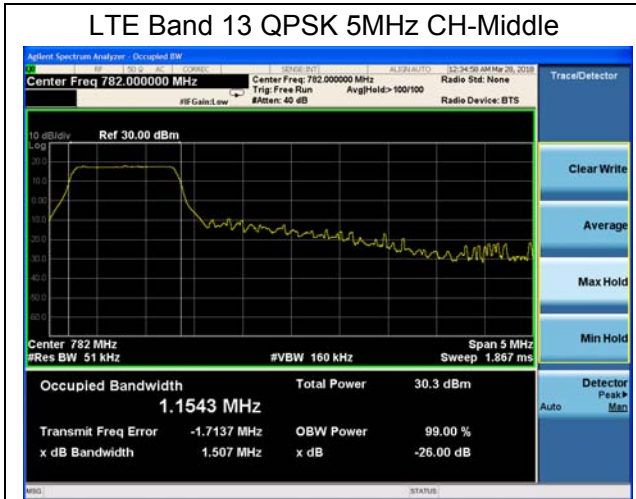

## 5.4 Band Edge Compliance

### Ambient condition

Temperature	Relative humidity	Pressure
23°C ~25°C	45%~50%	101.5kPa

### Method of Measurement

The EUT was connected to Spectrum Analyzer and Base Station Simulator via power Splitter. The band edge of the lowest and highest channels were measured.

The testing follows KDB 971168 D01 v03r01 Section 6.0

1.The EUT was connected to spectrum analyzer and system simulator via a power divider.

2. The band edges of low and high channels for the highest RF powers were measured.

3. RBW is set to 51 kHz, VBW is set to 160 kHz for LTE Band 4

RBW is set to 10 kHz, VBW is set to 30 kHz for LTE Band 13 (763MHz~775MHz).

RBW is set to 100 kHz, VBW is set to 300 kHz for LTE Band 13 (775MHz~777MHz).

RBW is set to 100 kHz, VBW is set to 300 kHz for LTE Band 13 (787MHz~793MHz).

RBW is set 10 kHz, VBW is set to 30 kHz for LTE Band 13 (793MHz~805MHz).

on spectrum analyzer.

4. Set spectrum analyzer with RMS detector.

5. The RF fundamental frequency should be excluded against the limit line in the operating frequency band.

6. Checked that all the results comply with the emission limit line.

### Test Setup

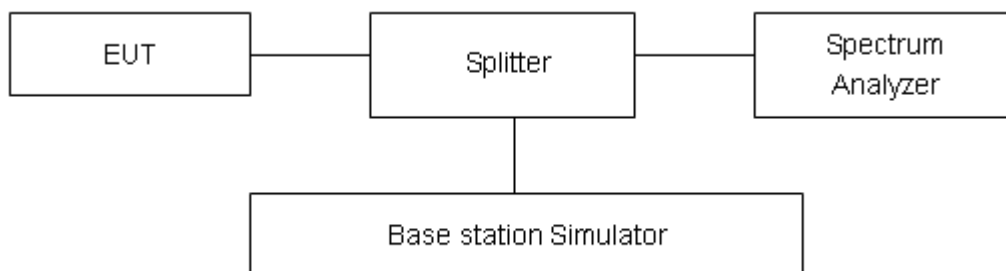

### Limits

Rule Part 27.53(h)/ specifies that “ for operations in the 1695-1710 MHz, 1710-1755 MHz, 1755-1780 MHz, 1915-1920 MHz, 1995-2000 MHz, 2000-2020 MHz, 2110-2155 MHz, 2155-2180 MHz, and 2180-2200 bands, the power of any emission outside a licensee’s frequency block shall be attenuated below the transmitter power (P) in watts by at least  $43 + 10 \log_{10} (P)$  dB”

Rule Part 27.53(f) For operations in the 746-758 MHz, 775-788 MHz, and 805-806 MHz bands, emissions in the band 1559-1610 MHz shall be limited to  $-70$  dBW/MHz equivalent isotropically radiated power (EIRP) for wideband signals, and  $-80$  dBW EIRP for discrete emissions of less than 700 Hz bandwidth. For the purpose of equipment authorization, a transmitter shall be tested with an antenna that is representative of the type that will be used with the equipment in normal operation.

Part 27.53 (c) For operations in the 746-758 MHz band and the 776-788 MHz band, the power of any emission outside the licensee's frequency band(s) of operation shall be attenuated below the transmitter power ( $P$ ) within the licensed band(s) of operation, measured in watts, in accordance with the following:

- (1) On any frequency outside the 746-758 MHz band, the power of any emission shall be attenuated outside the band below the transmitter power ( $P$ ) by at least  $43 + 10 \log (P)$  dB;
- (2) On any frequency outside the 776-788 MHz band, the power of any emission shall be attenuated outside the band below the transmitter power ( $P$ ) by at least  $43 + 10 \log (P)$  dB;
- (3) On all frequencies between 763-775 MHz and 793-805 MHz, by a factor not less than  $76 + 10 \log (P)$  dB in a 6.25 kHz band segment, for base and fixed stations;
- (4) On all frequencies between 763-775 MHz and 793-805 MHz, by a factor not less than  $65 + 10 \log (P)$  dB in a 6.25 kHz band segment, for mobile and portable stations;
- (5) Compliance with the provisions of paragraphs (c)(1) and (c)(2) of this section is based on the use of measurement instrumentation employing a resolution bandwidth of 100 kHz or greater. However, in the 100 kHz bands immediately outside and adjacent to the frequency block, a resolution bandwidth of at least 30 kHz may be employed;

### Measurement Uncertainty

The assessed measurement uncertainty to ensure 95% confidence level for the normal distribution is with the coverage factor  $k = 1.96$ ,  $U=0.684$ dB.

**Test Result**

All the test traces in the plots shows the test results clearly.

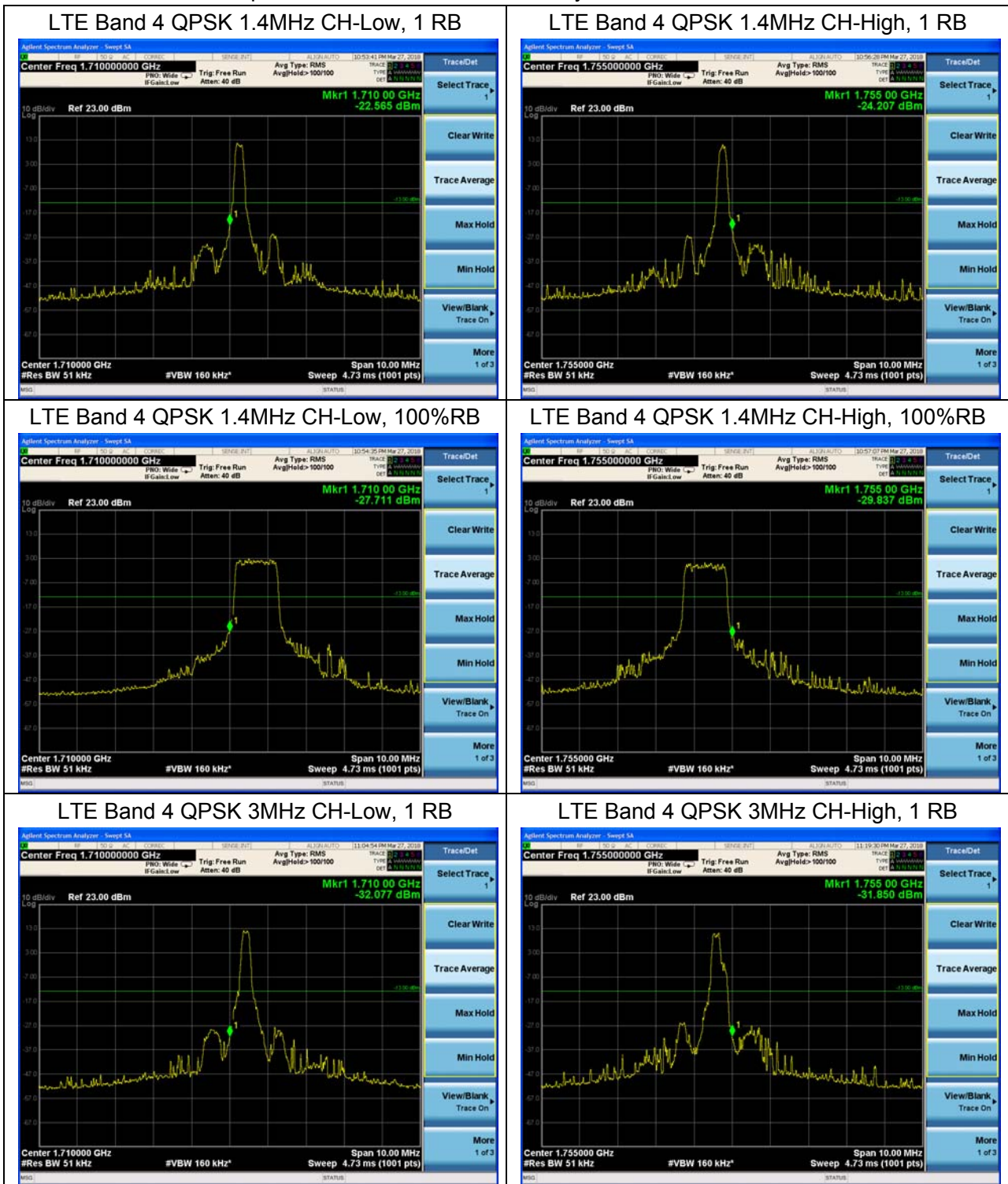

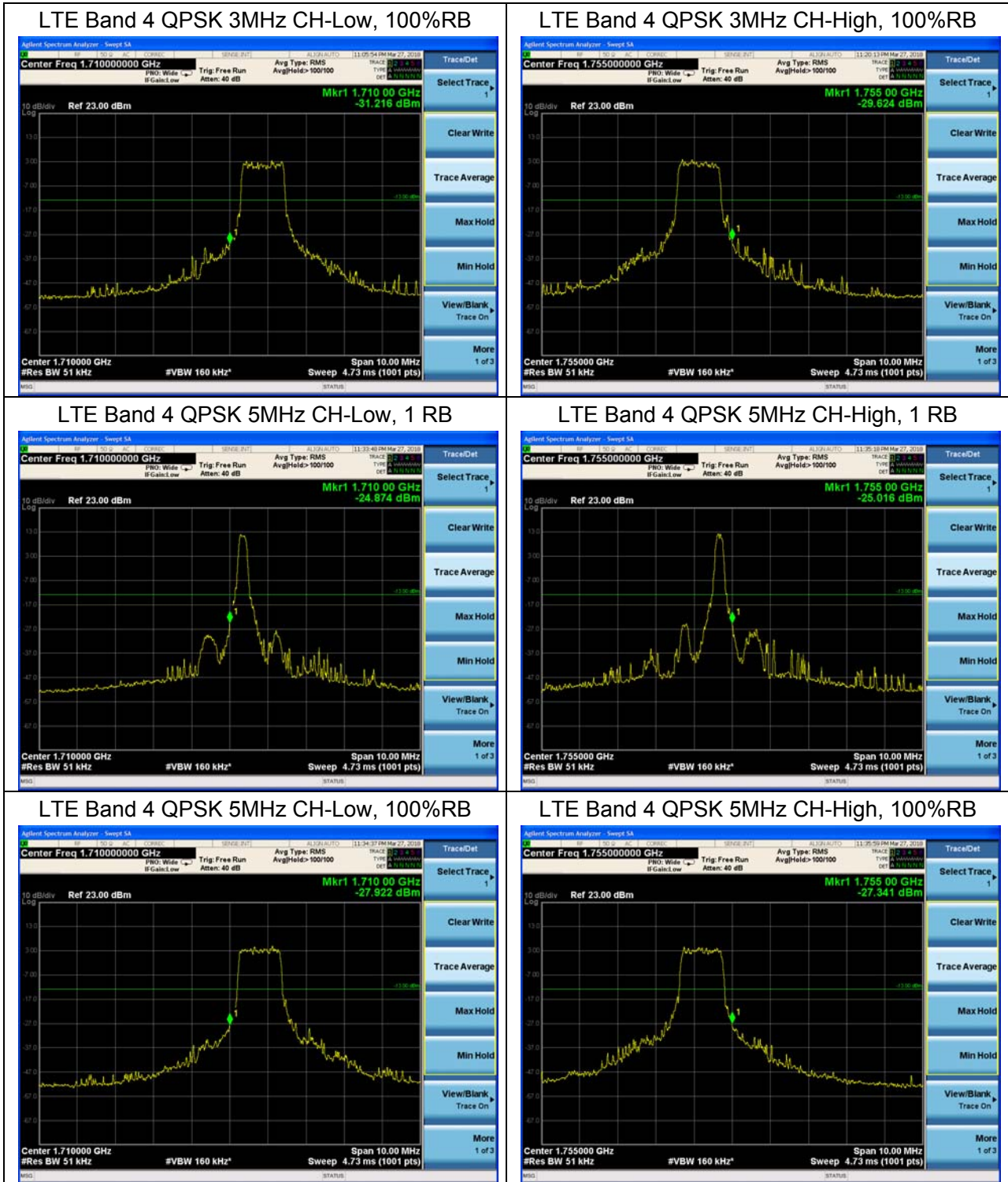



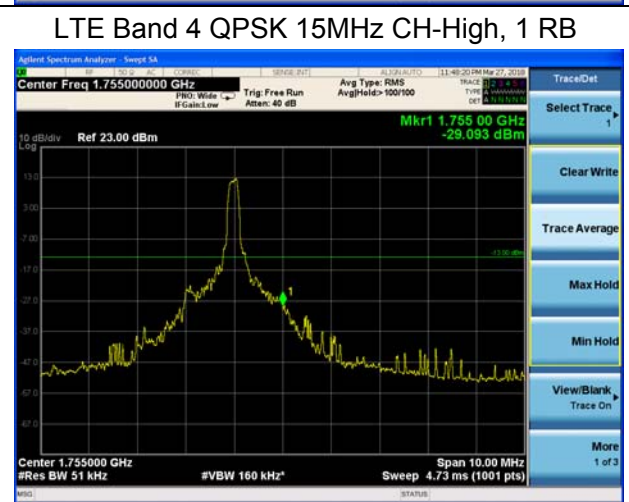
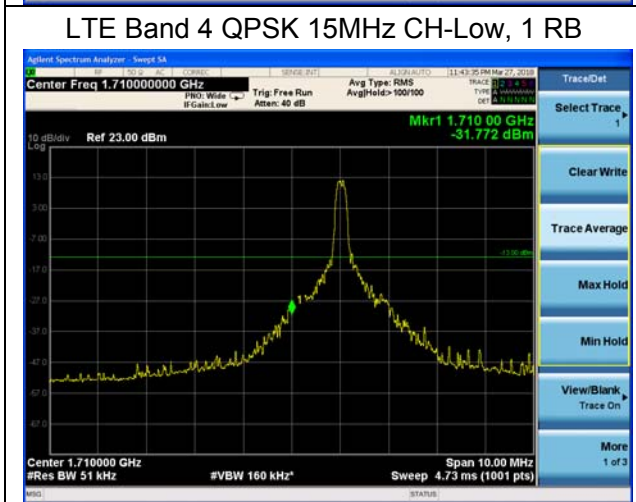
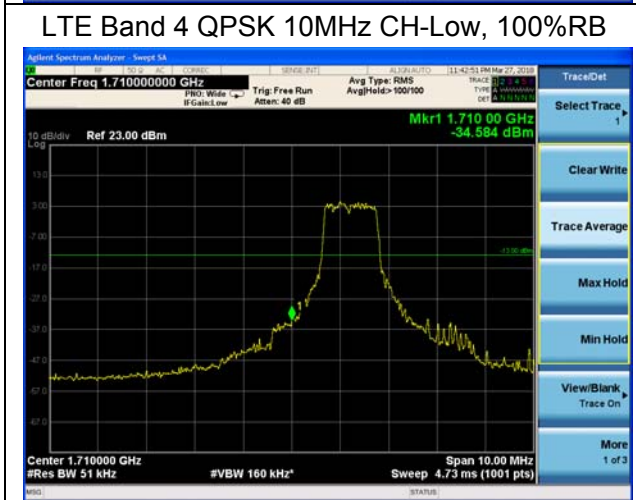
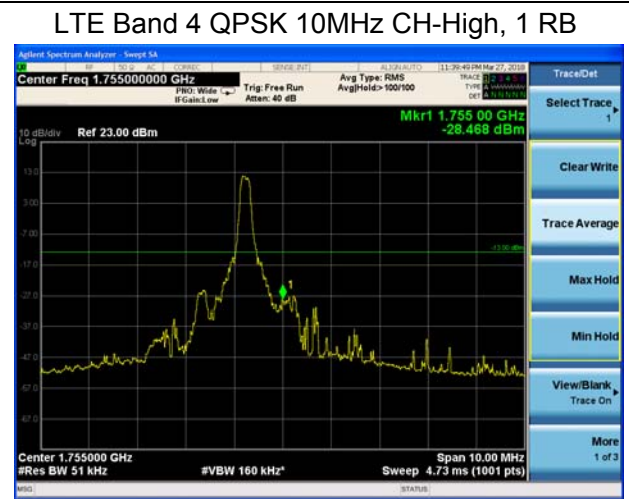
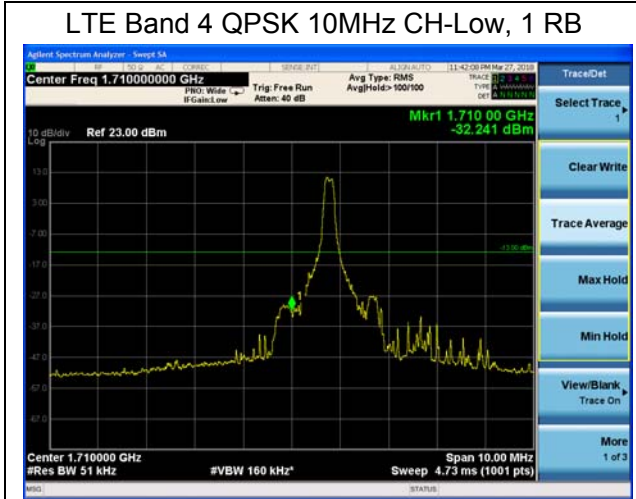

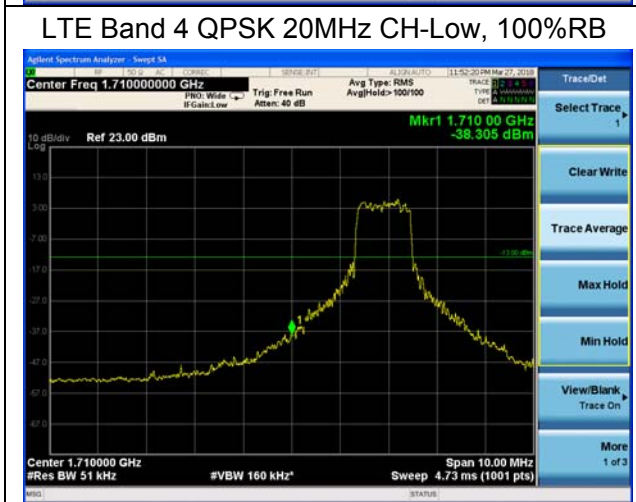
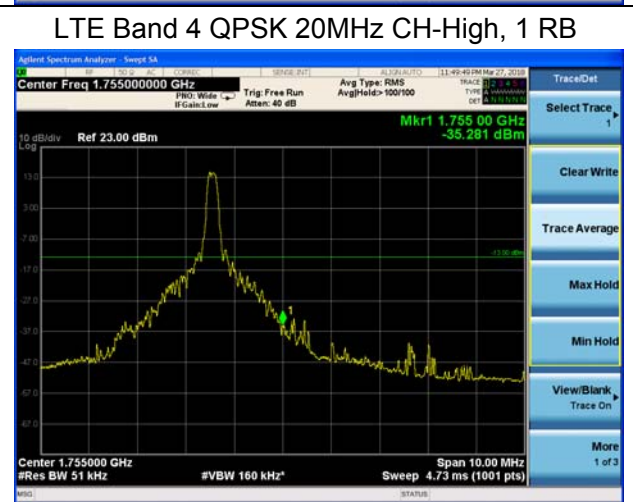
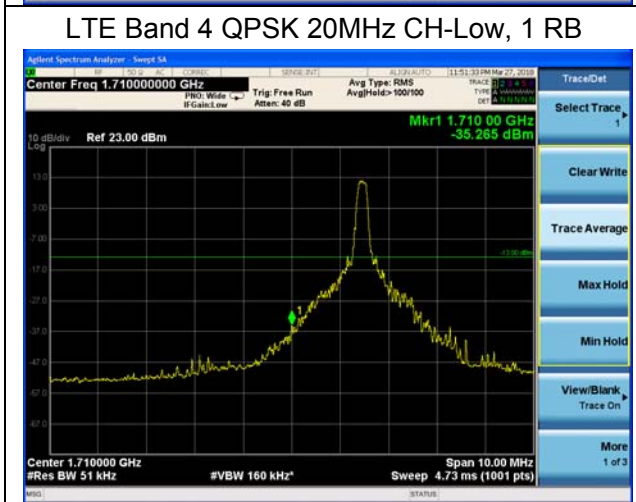
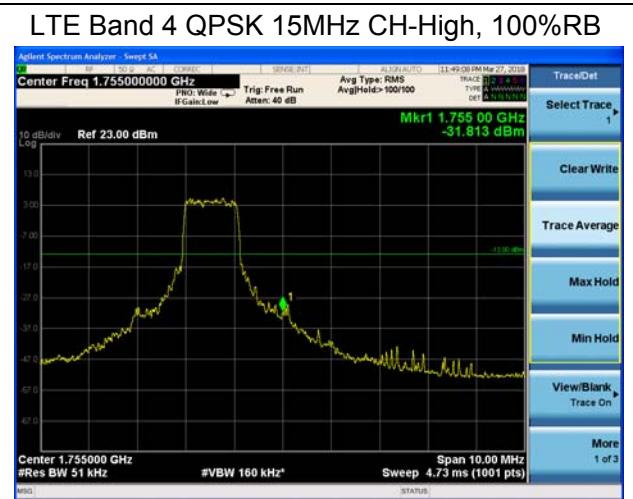
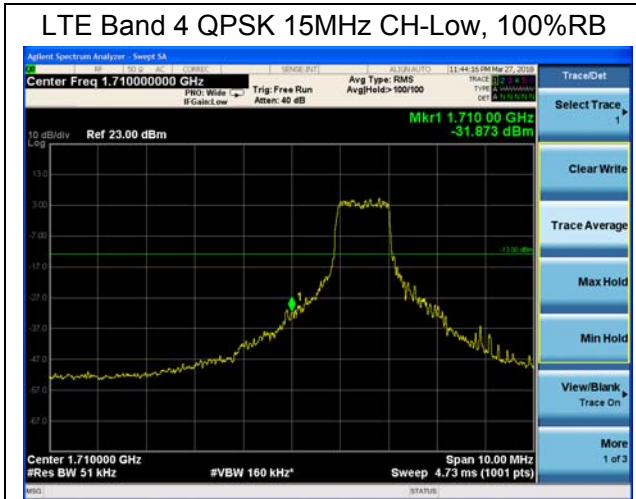

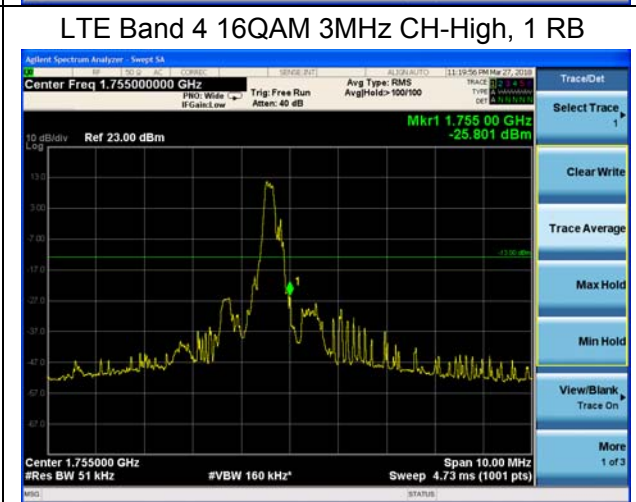
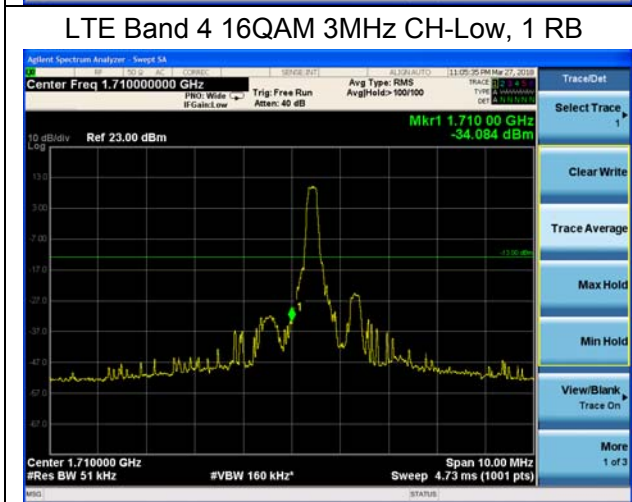
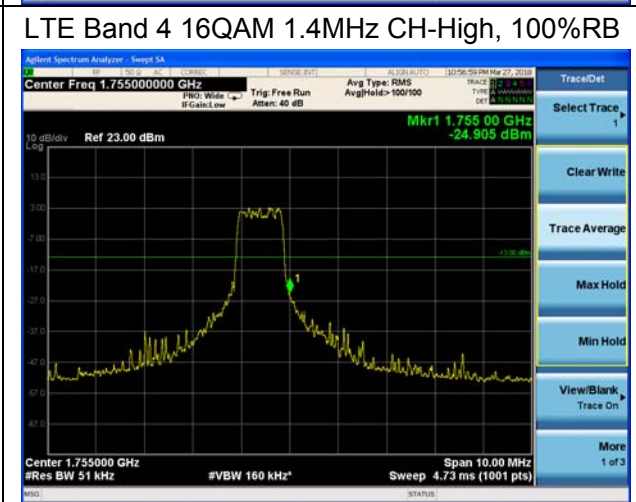
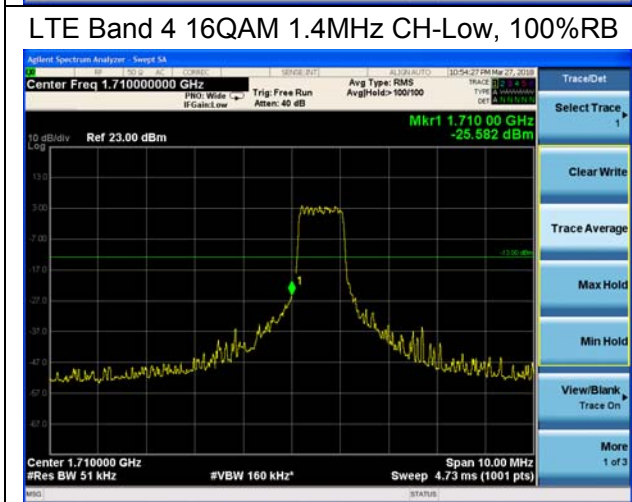
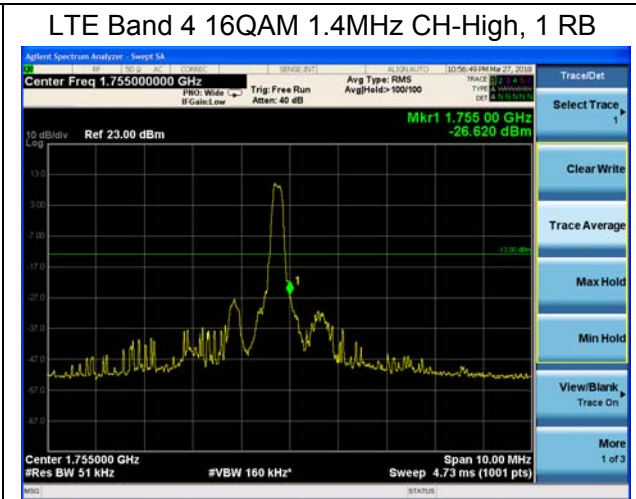
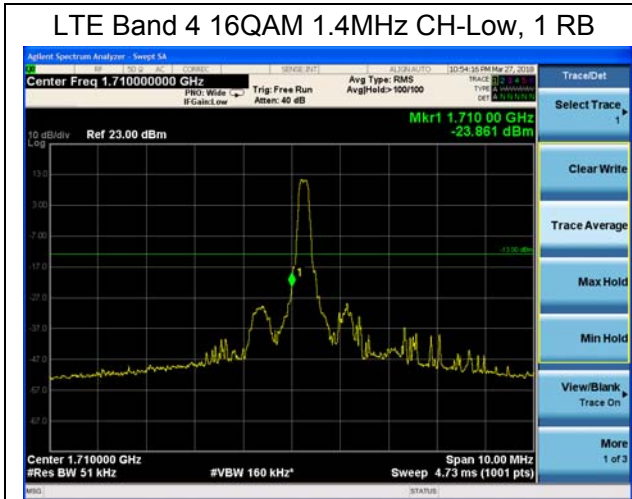

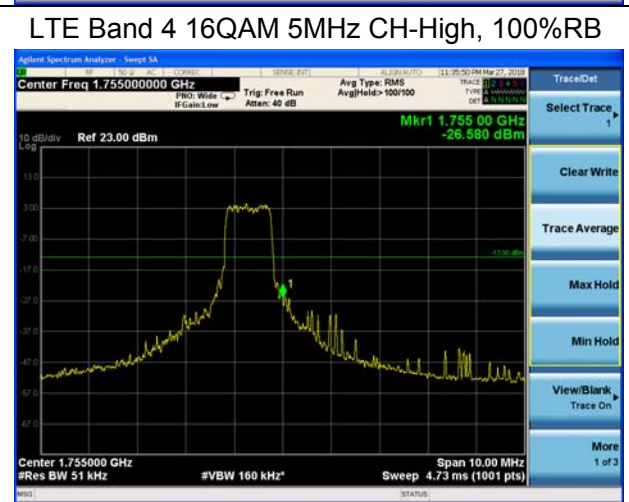
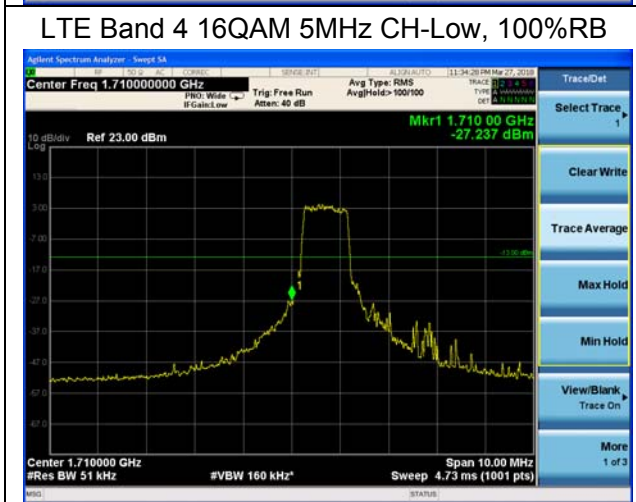
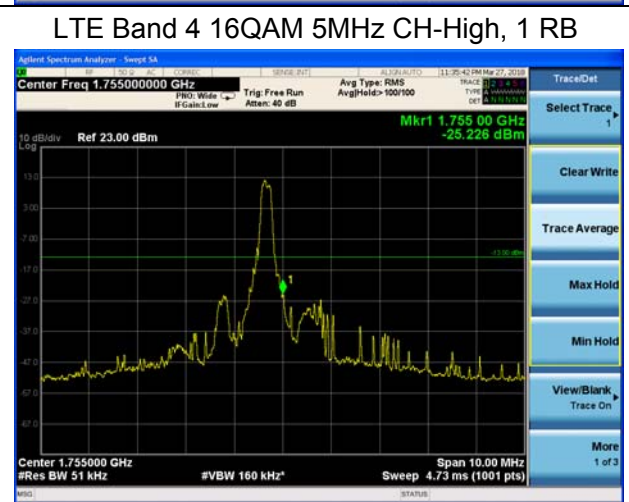
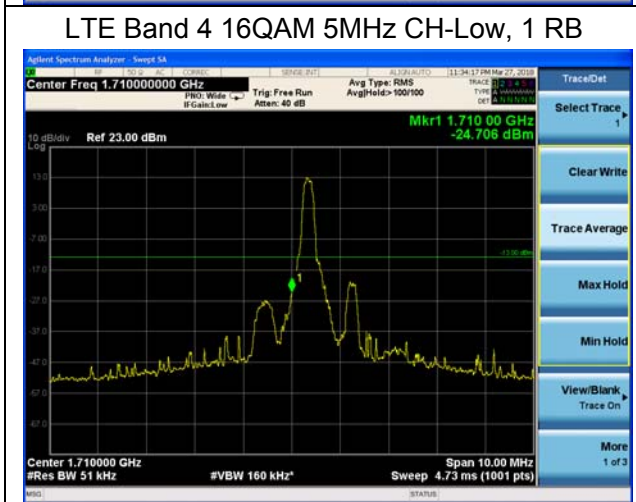
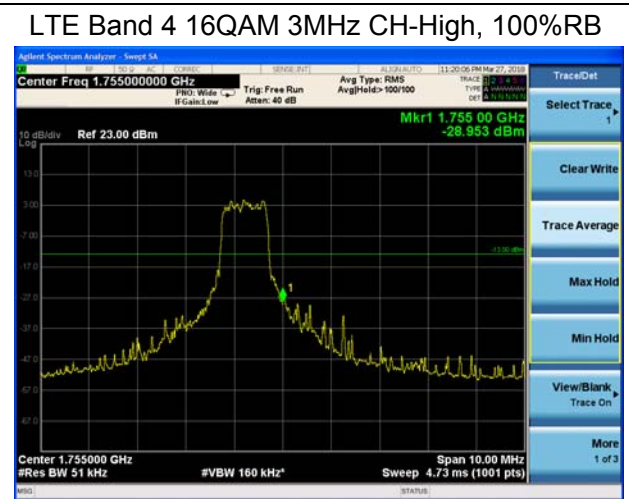
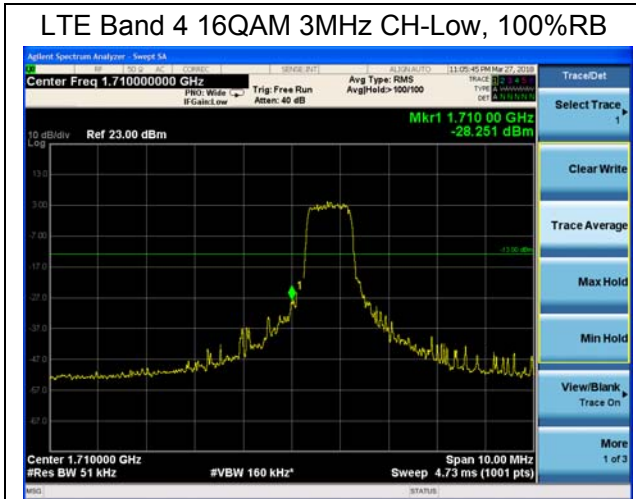

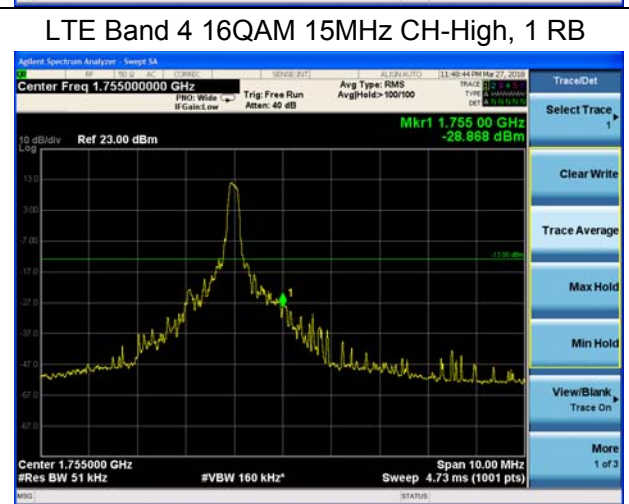
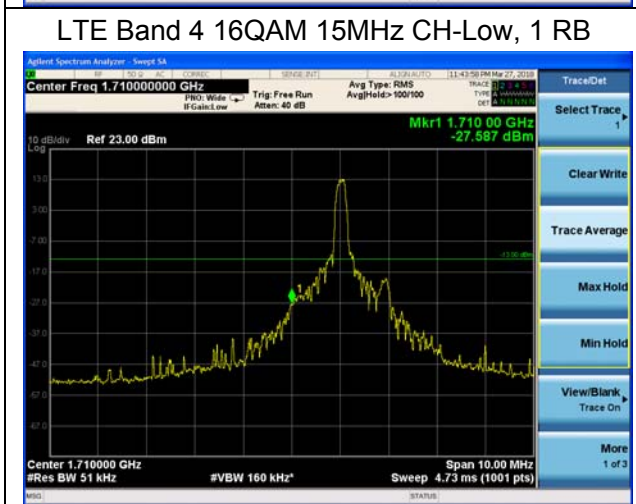
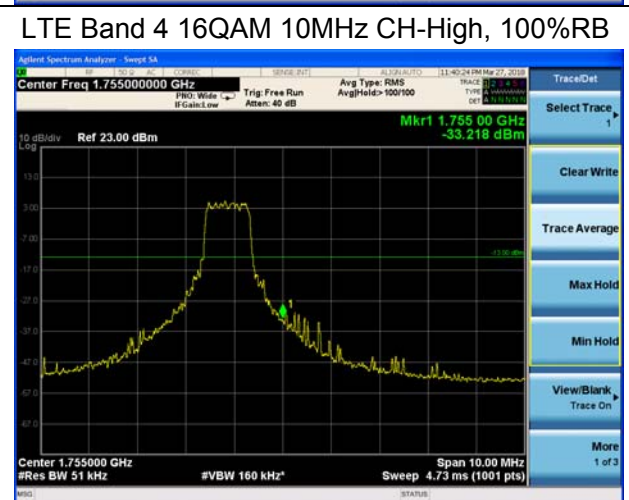
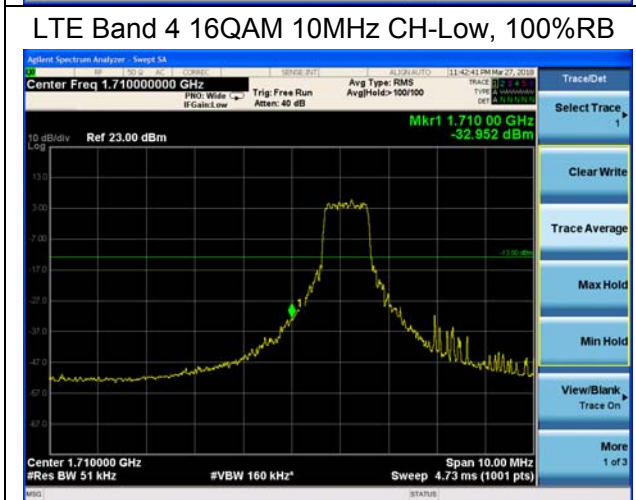
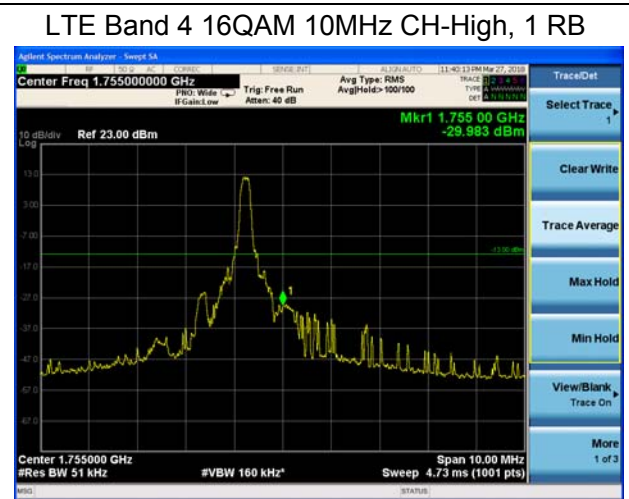
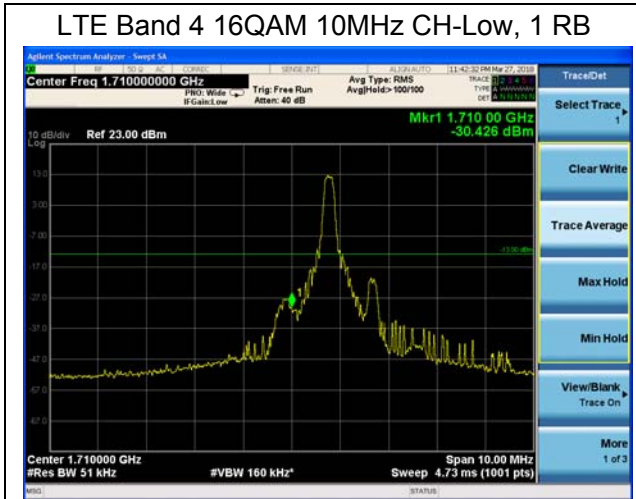

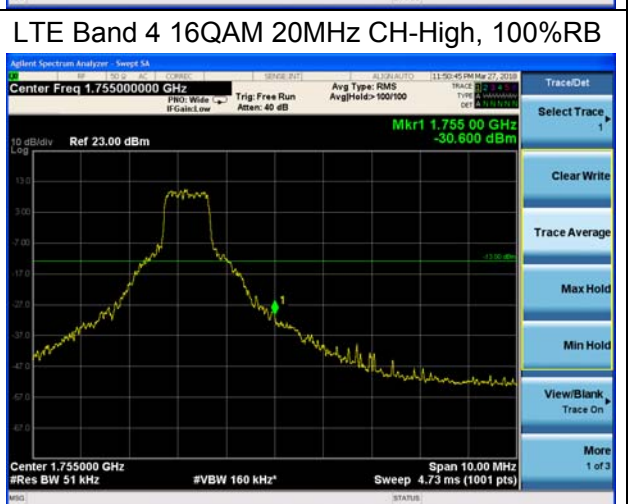
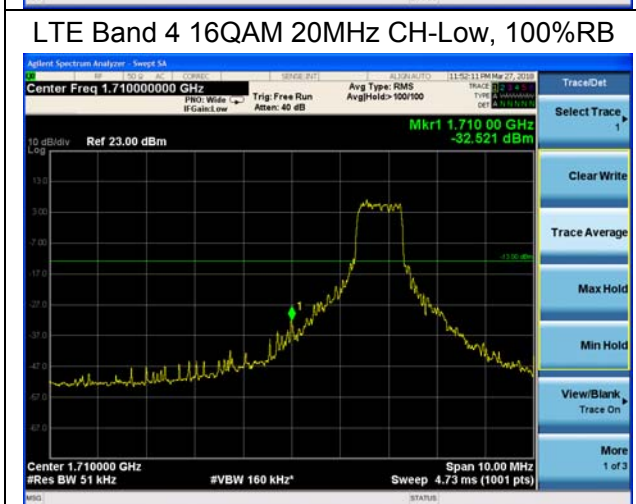
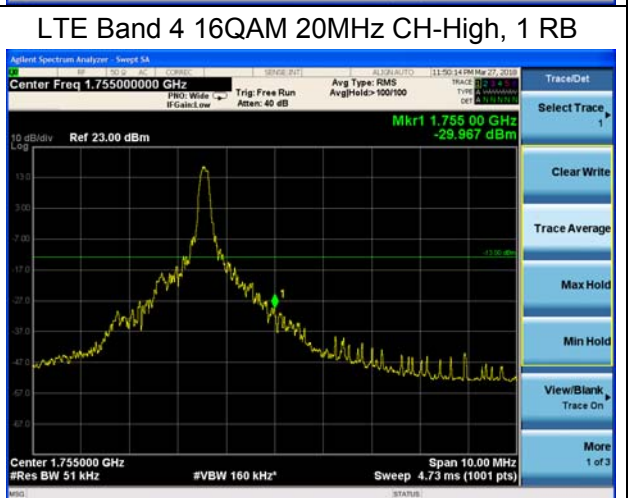
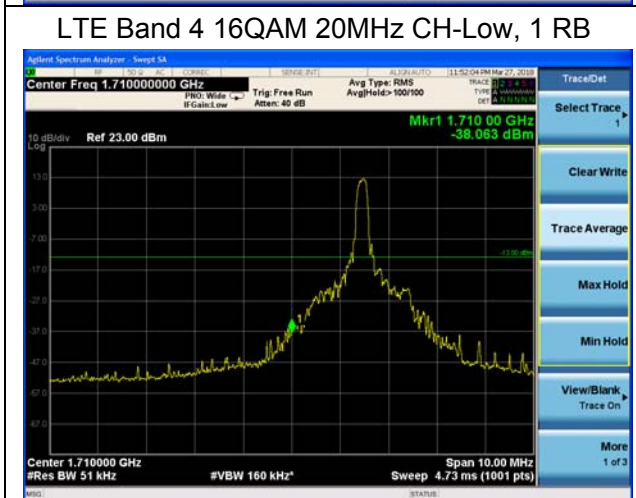
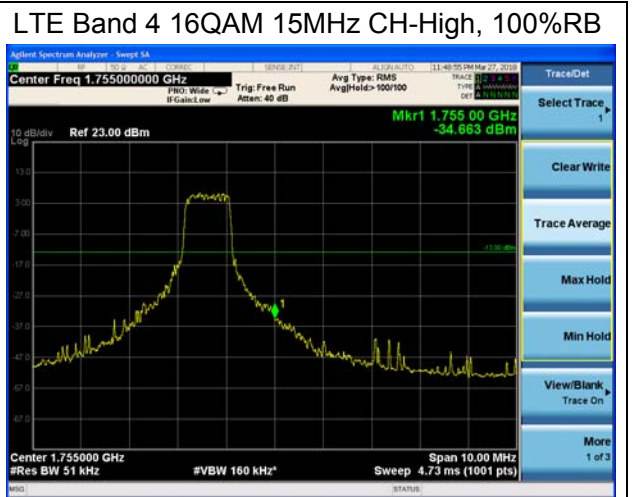
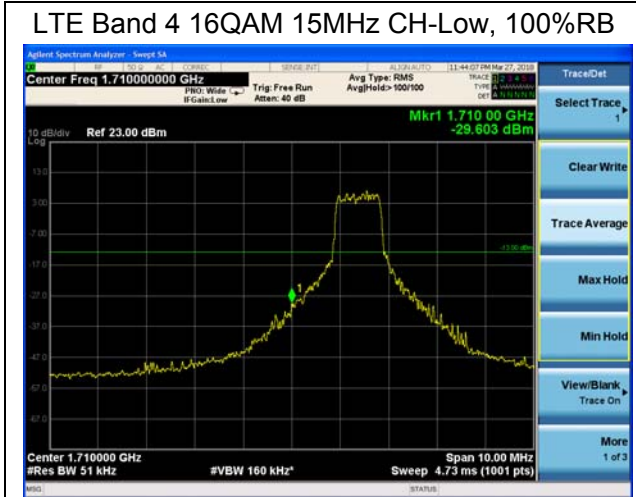



LTE Band 13 QPSK 5MHz CH-Low, 1 RB  
(763MHz ~775MHz)



LTE Band 13 QPSK 5MHz CH-Low, 1 RB  
(775MHz ~777MHz)

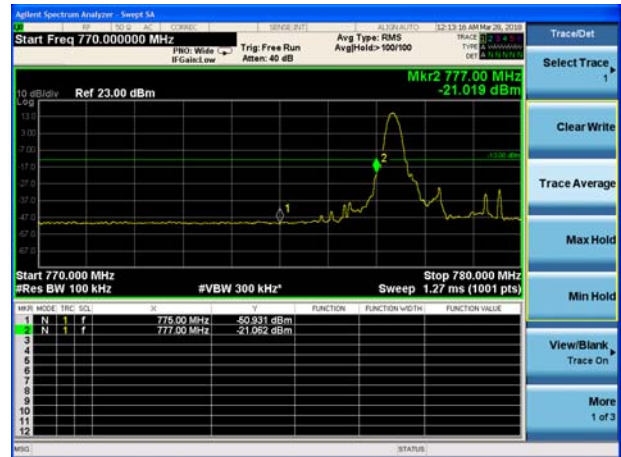

LTE Band 13 QPSK 5MHz CH-High, 1 RB  
(787MHz ~793MHz)



LTE Band 13 QPSK 5MHz CH-High, 1 RB  
(793MHz ~805MHz)

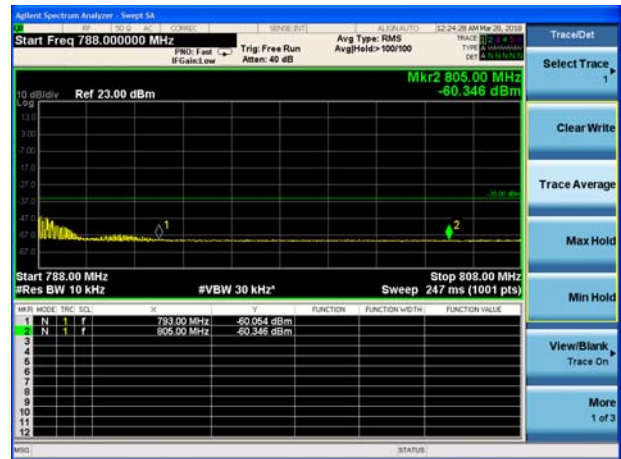

LTE Band 13 QPSK 5MHz CH-Low, 100%RB  
(763MHz ~775MHz)



LTE Band 13 QPSK 5MHz CH-Low, 100%RB  
(775MHz ~777MHz)



LTE Band 13 QPSK 5MHz CH-High, 100%RB  
(787MHz ~793MHz)



LTE Band 13 QPSK 5MHz CH-High, 100%RB  
(793MHz ~805MHz)





LTE Band 13 QPSK 10MHz CH-Low, 1 RB  
(763MHz ~775MHz)

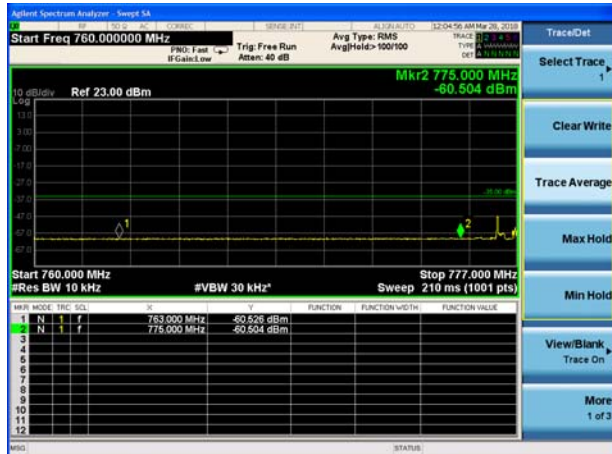

LTE Band 13 QPSK 10MHz CH-Low, 1 RB  
(775MHz ~777MHz)



LTE Band 13 QPSK 10MHz CH-High, 1 RB  
(787MHz ~793MHz)

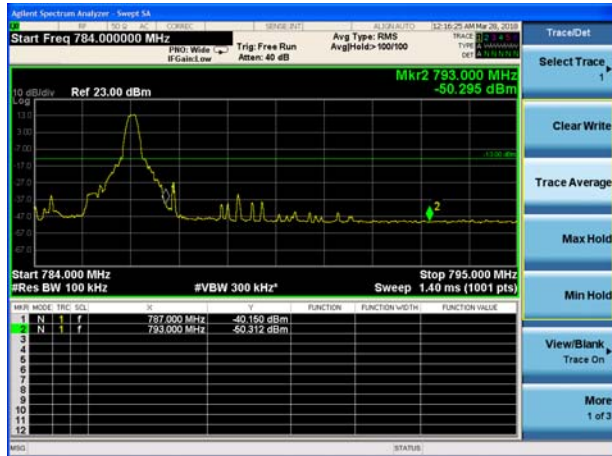

LTE Band 13 QPSK 10MHz CH-High, 1 RB  
(793MHz ~805MHz)



LTE Band 13 QPSK 10MHz CH-Low, 100%RB  
(763MHz ~775MHz)



LTE Band 13 QPSK 10MHz CH-Low, 100%RB  
(775MHz ~777MHz)



LTE Band 13 QPSK 10MHz CH-High, 100%RB  
(787MHz ~793MHz)



LTE Band 13 QPSK 10MHz CH-High, 100%RB  
(793MHz ~805MHz)

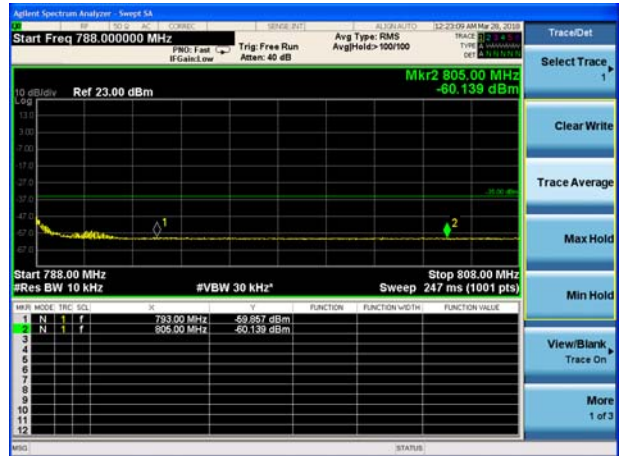

LTE Band 13 16QAM 5MHz CH-Low, 1 RB  
(763MHz ~775MHz)

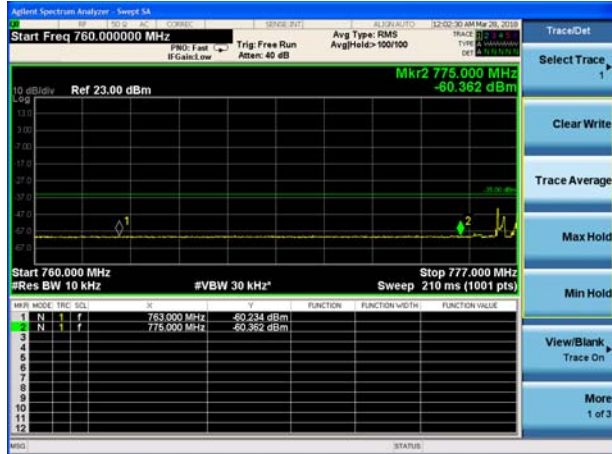

LTE Band 13 16QAM 5MHz CH-Low, 1 RB  
(775MHz ~777MHz)



LTE Band 13 16QAM 5MHz CH-High, 1 RB  
(787MHz ~793MHz)



LTE Band 13 16QAM 5MHz CH-High, 1 RB  
(793MHz ~805MHz)

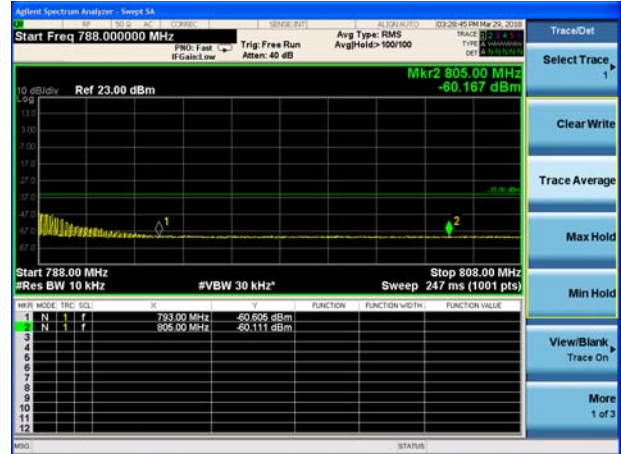

LTE Band 13 16QAM 5MHz CH-Low, 100%RB  
(763MHz ~775MHz)

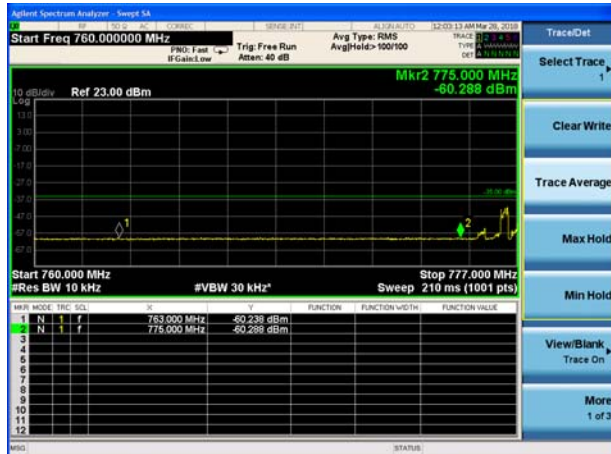

LTE Band 13 16QAM 5MHz CH-Low, 100%RB  
(775MHz ~777MHz)

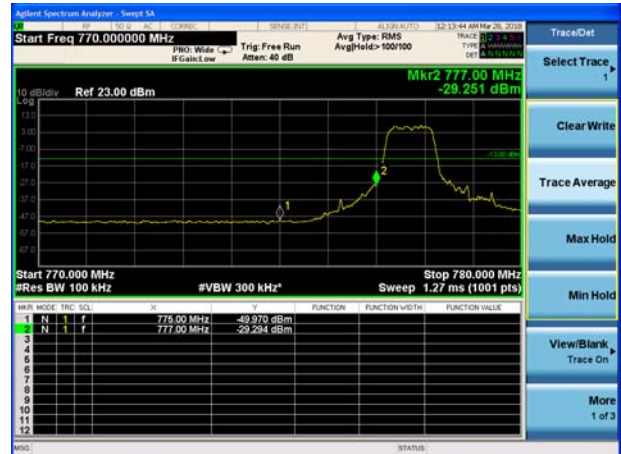

LTE Band 13 16QAM 5MHz CH-High, 100%RB  
(787MHz ~793MHz)



LTE Band 13 16QAM 5MHz CH-High, 100%RB  
(793MHz ~805MHz)



LTE Band 13 16QAM 10MHz CH-Low, 1 RB  
(763MHz ~775MHz)

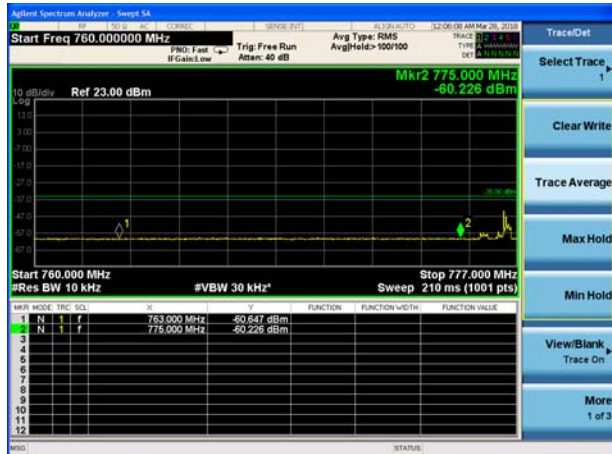

LTE Band 13 16QAM 10MHz CH-Low, 1 RB  
(775MHz ~777MHz)



LTE Band 13 16QAM 10MHz CH-High, 1 RB  
(787MHz ~793MHz)



LTE Band 13 16QAM 10MHz CH-High, 1 RB  
(793MHz ~805MHz)



LTE Band 13 16QAM 10MHz CH-Low, 100%RB  
(763MHz ~775MHz)



LTE Band 13 16QAM 10MHz CH-Low, 100%RB  
(775MHz ~777MHz)



LTE Band 13 16QAM 10MHz CH-High, 100%RB  
(787MHz ~793MHz)



LTE Band 13 16QAM 10MHz CH-High, 100%RB  
(793MHz ~805MHz)



### 5.5 Peak-to-Average Power Ratio (PAPR)

#### Ambient condition

Temperature	Relative humidity	Pressure
23°C ~25°C	45%~50%	101.5kPa

#### Methods of Measurement

Measure the total peak power and record as PPK. And measure the total average power and record as PAvg. Both the peak and average power levels must be expressed in the same logarithmic units (e.g., dBm). Determine the PAPR from:

$$PAPR (dB) = PPK (dBm) - PAvg (dBm).$$

#### Test Setup

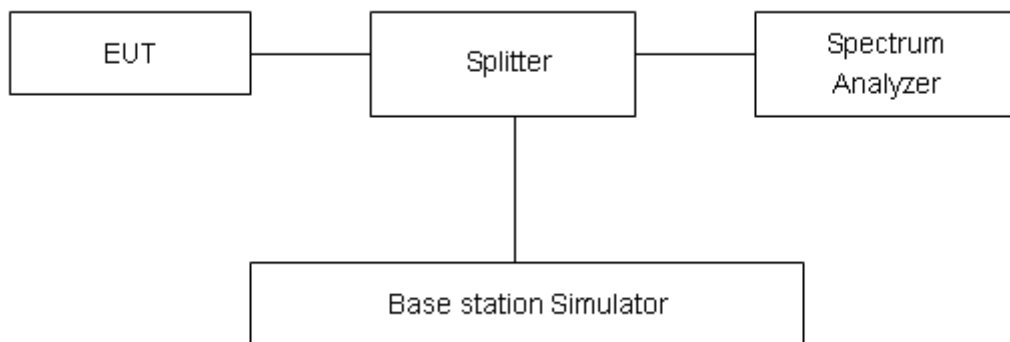

#### Limits

Rule Part 27.50(d)(5) Equipment employed must be authorized in accordance with the provisions of 24.51. Power measurements for transmissions by stations authorized under this section may be made either in accordance with a Commission-approved average power technique or in compliance with paragraph (d)(6) of this section. In measuring transmissions in this band using an average power technique, the peak-to-average ratio (PAR) of the transmission may not exceed 13 dB.

#### Measurement Uncertainty

The assessed measurement uncertainty to ensure 95% confidence level for the normal distribution is with the coverage factor k = 2, U= 0.4 dB.

**Test Results**

Mode	Bandwidth	Modulation	Channel/ Frequency(MHz)	Peak-to-Average Power Ratio (PAPR)		
				Peak(dBm)	Avg(dBm)	PAPR(dB)
LTE Band 4	1.4MHz	QPSK	20175/1732.5	32.76	21.89	10.87
		16QAM	20175/1732.5	32.54	21.18	11.36
	3MHz	QPSK	20175/1732.5	30.66	21.75	8.91
		16QAM	20175/1732.5	30.25	21.13	9.12
	5MHz	QPSK	20175/1732.5	30.06	21.75	8.31
		16QAM	20175/1732.5	32.40	22.19	10.21
	10MHz	QPSK	20175/1732.5	29.96	21.32	8.64
		16QAM	20175/1732.5	31.43	21.98	9.45
	15MHz	QPSK	20175/1732.5	30.06	21.33	8.73
		16QAM	20175/1732.5	31.10	21.85	9.25
20MHz	QPSK	20175/1732.5	30.80	21.03	9.77	
	16QAM	20175/1732.5	31.34	21.99	9.35	

Mode	Bandwidth	Modulation	Channel/ Frequency(MHz)	Peak-to-Average Power Ratio (PAPR)		
				Peak(dBm)	Avg(dBm)	PAPR(dB)
LTE Band 13	5MHz	QPSK	23230/782	31.53	21.92	9.61
		16QAM	23230/782	31.95	21.74	10.21
	10MHz	QPSK	23230/782	31.13	22.11	9.02
		16QAM	23230/782	31.85	22.76	9.09



## 5.6 Frequency Stability

### Ambient condition

Temperature	Relative humidity	Pressure
23°C ~25°C	45%~50%	101.5kPa

### Method of Measurement

#### Frequency Stability (Temperature Variation)

The temperature inside the climate chamber is varied from -40°C to +50°C in 10°C step size.

(1) With all power removed, the temperature was decreased to -10°C and permitted to stabilize for three hours.

(2) Measure the carrier frequency with the test equipment in a “call mode”. These measurements should be made within 1 minute of powering up the mobile station, to prevent significant self warming.

(3) Repeat the above measurements at 10°C increments from -40°C to +50°C. Allow at least 1.5 hours at each temperature, un-powered, before making measurements.

#### Frequency Stability (Voltage Variation)

The frequency stability shall be measured with variation of primary supply voltage as follows:

(1) Vary primary supply voltage from 85 to 115 percent of the nominal value for other than hand carried battery equipment.

(2) For hand carried, battery powered equipment, reduce primary supply voltage to the battery-operating end point which shall be specified by the manufacturer.

This transceiver is specified to operate with an input voltage of between 3.1 V and 3.8 V, with a nominal voltage of 3.5V.

### Test setup

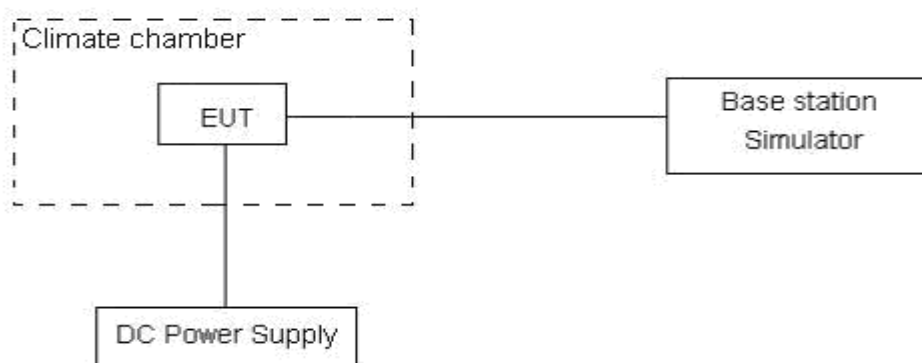

### Limits

No specific frequency stability requirements in part 27.54

### Measurement Uncertainty

The assessed measurement uncertainty to ensure 99.75% confidence level for the normal distribution is with the coverage factor  $k = 3, U=0.01\text{ppm}$ .

**Test Result**

LTE Band 4						
(QPSK, 20MHz BANDWIDTH)						
Condition		1710	1755	Delta (Hz)	Frequency Stability(ppm)	
Temperature	Voltage	F low@-13dBm(MHz)	F high@-13dBm(MHz)			
Normal (25°C)	Normal	1711.2582	1753.7896	4.40	0.00265	
Extreme (50°C)		1711.2582	1753.7896	-2.07	-0.00109	
Extreme (40°C)		1711.2582	1753.7896	-3.76	-0.00206	
Extreme (30°C)		1711.2582	1753.7896	4.37	0.00263	
Extreme (20°C)		1711.2582	1753.7896	-6.95	-0.00390	
Extreme (10C)		1711.2582	1753.7896	-0.17	0.00001	
Extreme (0°C)		1711.2582	1753.7896	7.28	0.00431	
Extreme (-10°C)		1711.2582	1753.7896	-2.89	-0.00156	
Extreme (-20°C)		1711.2582	1753.7896	-2.72	-0.00146	
Extreme (-30°C)		1711.2582	1753.7896	-9.14	-0.00517	
Extreme (-40°C)		1711.2582	1753.7896	3.81	0.00231	
25°C		LV	1711.2582	1753.7896	-6.17	-0.00345
		HV	1711.2582	1753.7896	-6.08	-0.00340
(16QAM,20MHz BANDWIDTH)						
Condition		1710	1755	Delta (Hz)	Frequency Stability(ppm)	
Temperature	Voltage	F low@-13dBm(MHz)	F high@-13dBm(MHz)			
Normal (25°C)	Normal	1711.2603	1753.7884	-6.22	-0.00348	
Extreme (50°C)		1711.2603	1753.7884	0.19	0.00022	
Extreme (40°C)		1711.2603	1753.7884	-4.42	-0.00244	
Extreme (30°C)		1711.2603	1753.7884	-9.58	-0.00542	
Extreme (20°C)		1711.2603	1753.7884	-3.11	-0.00169	
Extreme (10C)		1711.2603	1753.7884	-2.14	-0.00113	
Extreme (0°C)		1711.2603	1753.7884	-2.67	-0.00143	
Extreme (-10°C)		1711.2603	1753.7884	-9.10	-0.00514	
Extreme (-20°C)		1711.2603	1753.7884	-4.27	-0.00235	
Extreme (-30°C)		1711.2603	1753.7884	-1.23	-0.00060	
Extreme (-40°C)		1711.2603	1753.7884	0.47	0.00038	
25°C		LV	1711.2603	1753.7884	4.51	0.00271
		HV	1711.2603	1753.7884	-9.65	-0.00546

LTE Band 13					
(QPSK, 20MHz BANDWIDTH)					
Condition		777	787	Delta (Hz)	Frequency Stability(ppm)
Temperature	Voltage	F low@-13dBm(MHz)	F high@-13dBm(MHz)		
Normal (25°C)	Normal	777.5599	786.5335	-2.38	-0.00280
Extreme (50°C)		777.5599	786.5335	1.57	0.00225
Extreme (40°C)		777.5599	786.5335	-1.35	-0.00148
Extreme (30°C)		777.5599	786.5335	-1.88	-0.00216
Extreme (20°C)		777.5599	786.5335	1.79	0.00253
Extreme (10C)		777.5599	786.5335	-3.32	-0.00400
Extreme (0°C)		777.5599	786.5335	-0.26	-0.00009
Extreme (-10°C)		777.5599	786.5335	3.10	0.00421
Extreme (-20°C)		777.5599	786.5335	-1.49	-0.00166
Extreme (-30°C)		777.5599	786.5335	-3.79	-0.00460
Extreme (-40°C)		777.5599	786.5335	1.36	0.00198
25°C		LV	777.5599	786.5335	2.87
	HV	777.5599	786.5335	1.24	0.00183
(16QAM,20MHz BANDWIDTH)					
Condition		777	787	Delta (Hz)	Frequency Stability(ppm)
Temperature	Voltage	F low@-13dBm(MHz)	F high@-13dBm(MHz)		
Normal (25°C)	Normal	777.5603	786.5326	-4.47	-0.00547
Extreme (50°C)		777.5603	786.5326	-3.22	-0.00387
Extreme (40°C)		777.5603	786.5326	-0.33	-0.00018
Extreme (30°C)		777.5603	786.5326	-2.41	-0.00284
Extreme (20°C)		777.5603	786.5326	-4.74	-0.00582
Extreme (10C)		777.5603	786.5326	-1.82	-0.00208
Extreme (0°C)		777.5603	786.5326	-1.38	-0.00152
Extreme (-10°C)		777.5603	786.5326	-1.62	-0.00183
Extreme (-20°C)		777.5603	786.5326	-4.52	-0.00554
Extreme (-30°C)		777.5603	786.5326	-3.18	-0.00382
Extreme (-40°C)		777.5603	786.5326	1.06	0.00160
25°C		LV	777.5603	786.5326	-4.30
	HV	777.5603	786.5326	-2.62	-0.00311

### 5.7 Spurious Emissions at Antenna Terminals

**Ambient condition**

Temperature	Relative humidity	Pressure
23°C ~25°C	45%~50%	101.5kPa

**Method of Measurement**

The EUT was connected to Spectrum Analyzer and Base Station Simulator via power Splitter. The measurement is carried out using a spectrum analyzer. The spectrum analyzer scans from 9kHz to the 10th harmonic of the carrier. The peak detector is used.

RBW is set to 100kHz, VBW is set to 300kHz for 30MHz~1GHz

RBW is set to 1MHz, VBW is set to 3MHz for above 1GHz, Sweep is set to ATUO.

Of those disturbances below (limit – 20 dB), the mark is not required for the EUT.

**Test setup**

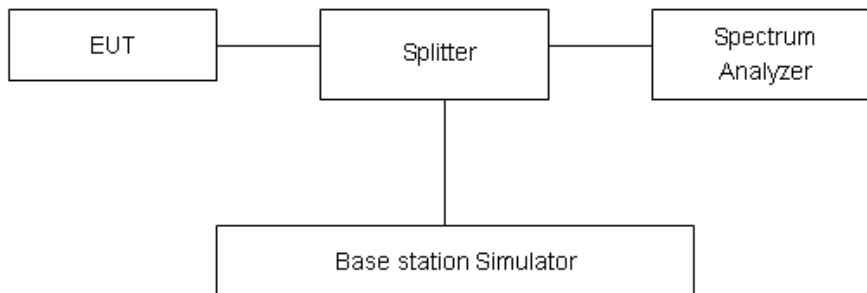

**Limits**

Rule Part 27.53(h) specifies that “for operations in the 1695-1710 MHz, 1710-1755 MHz, 1755-1780 MHz, 1915-1920 MHz, 1995-2000 MHz, 2000-2020 MHz, 2110-2155 MHz, 2155-2180 MHz, and 2180-2200 bands, the power of any emission outside a licensee's frequency block shall be attenuated below the transmitter power (P) in watts by at least 43 + 10 log10 (P) dB..”

Rule Part 27.53(f) For operations in the 746-758 MHz, 775-788 MHz, and 805-806 MHz bands, emissions in the band 1559-1610 MHz shall be limited to –70 dBW/MHz equivalent isotropically radiated power (EIRP) for wideband signals, and –80 dBW EIRP for discrete emissions of less than 700 Hz bandwidth. For the purpose of equipment authorization, a transmitter shall be tested with an antenna that is representative of the type that will be used with the equipment in normal operation.

Part 27.53(h) Limit		-13 dBm
Part 27.53(f) Limit	Limit out of the band 1559-1610 MHz	-13 dBm
	Limit in the band 1559-1610 MHz	-40 dBm

### Measurement Uncertainty

The assessed measurement uncertainty to ensure 99.75% confidence level for the normal distribution is with the coverage factor  $k = 1.96$ .

Frequency	Uncertainty
9kHz-1GHz	0.684 dB
1GHz-27GHz	1.407 dB

**Test Result**

Sweep from 9 kHz to 30MHz, and the emissions more than 20 dB below the permissible value are not reported.

If disturbances were found more than 20dB below limit line, the mark is not required for the EUT. The signal beyond the limit is carrier.

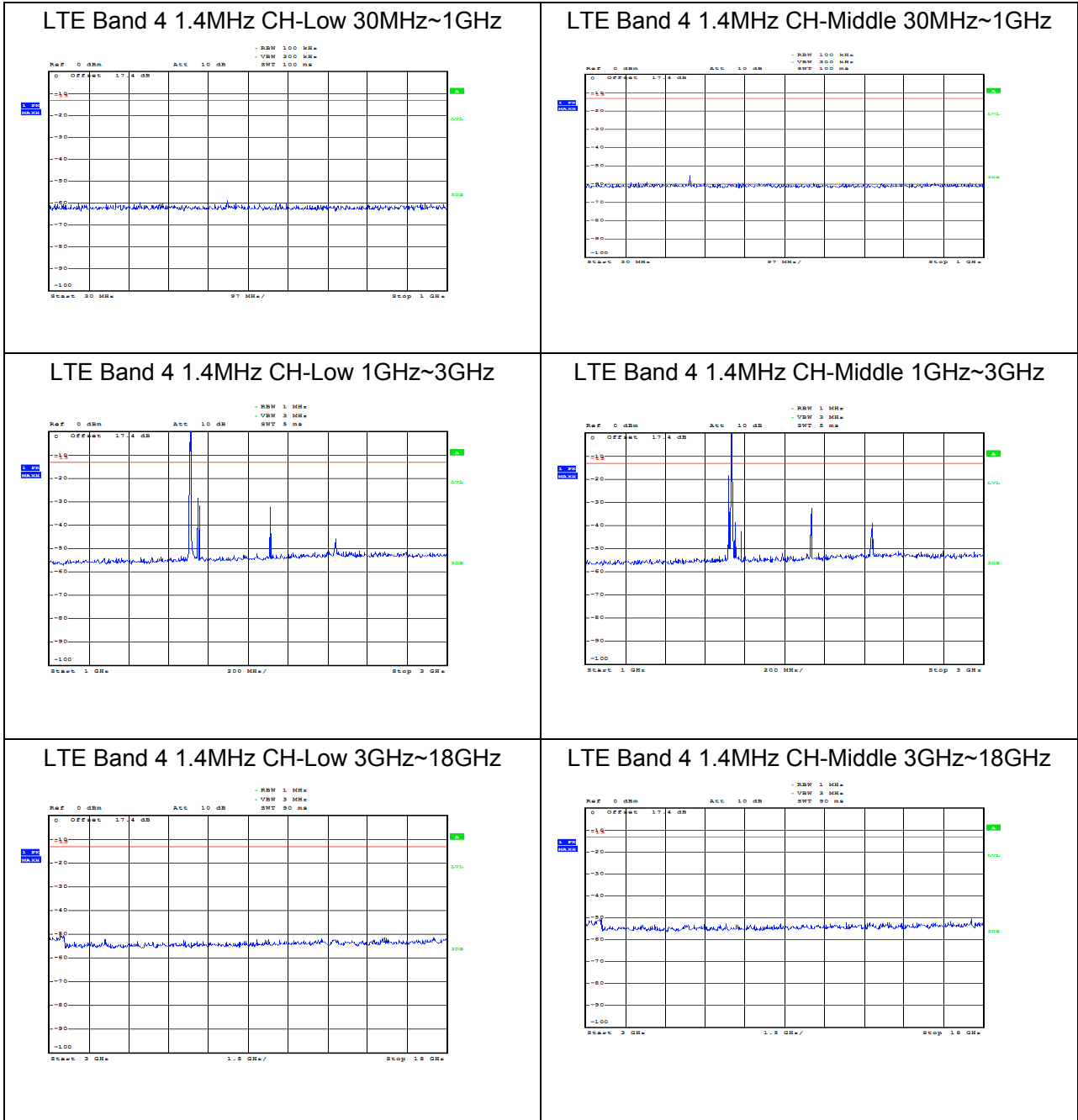



### LTE Band 4 1.4MHz CH-High 30MHz~1GHz

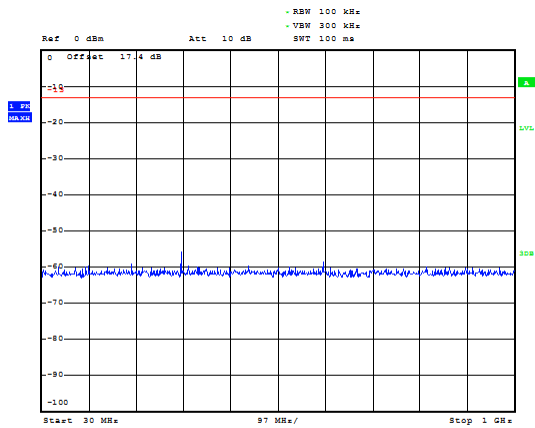

### LTE Band 4 3MHz CH-Low 30MHz~1GHz

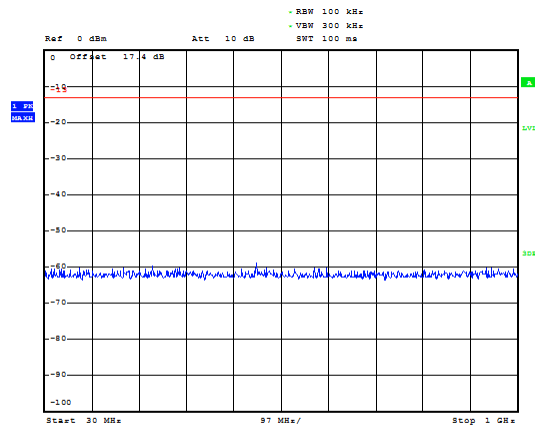

### LTE Band 4 1.4MHz CH-High 1GHz~3GHz

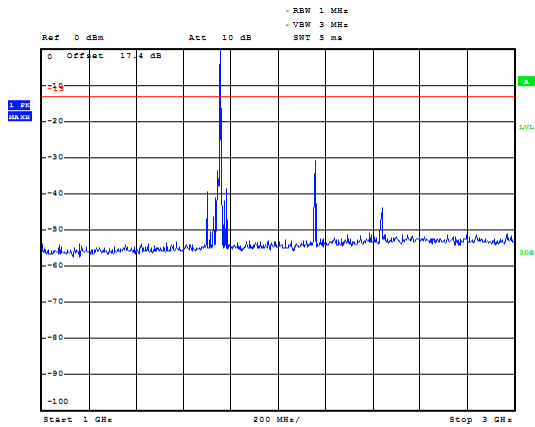

### LTE Band 4 3MHz CH-Low 1GHz~3GHz

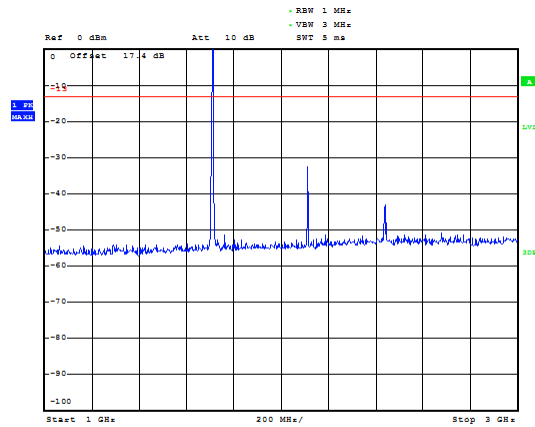

### LTE Band 4 1.4MHz CH-High 3GHz~18GHz

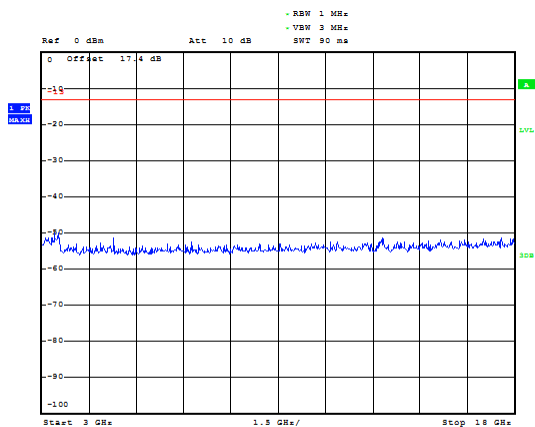

### LTE Band 4 3MHz CH-Low 3GHz~18GHz

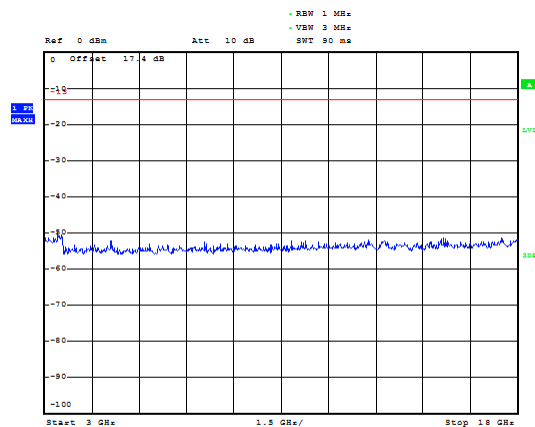



### LTE Band 4 3MHz CH-Middle 30MHz~1GHz

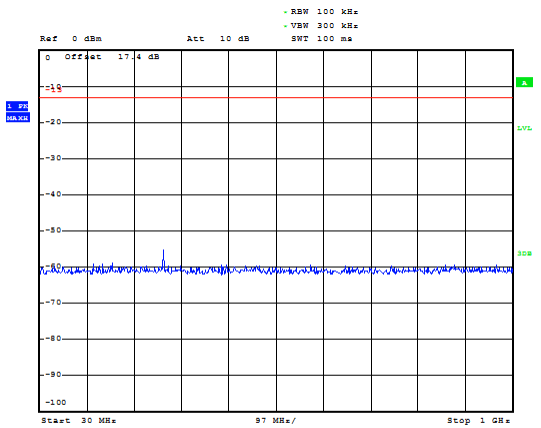

### LTE Band 4 3MHz CH-High 30MHz~1GHz

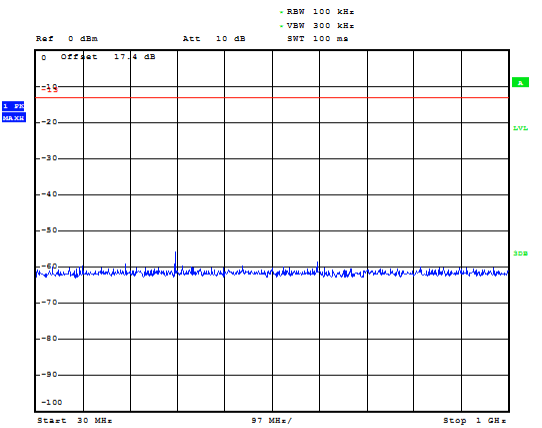

### LTE Band 4 3MHz CH-Middle 1GHz~3GHz

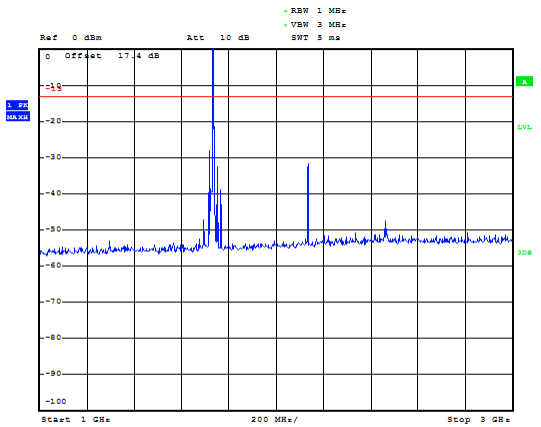

### LTE Band 4 3MHz CH-High 1GHz~3GHz

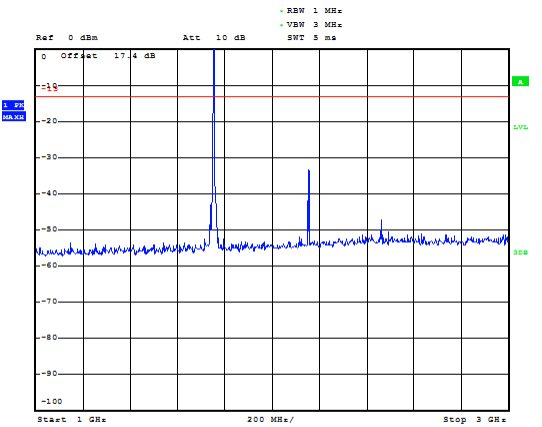

### LTE Band 4 3MHz CH-Middle 3GHz~18GHz

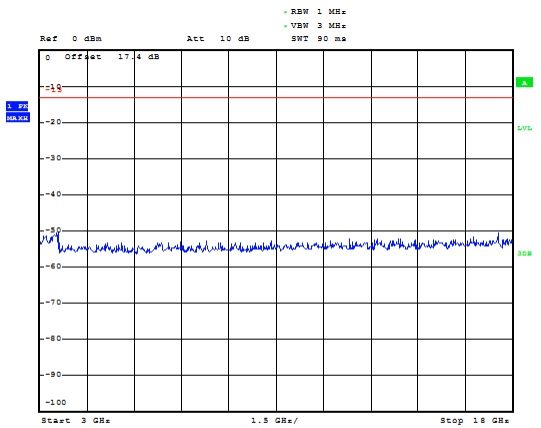

### LTE Band 4 3MHz CH-High 3GHz~18GHz

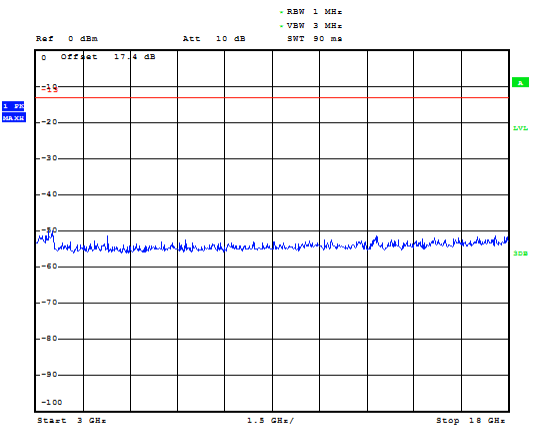





### LTE Band 4 5MHz CH-Low 30MHz~1GHz

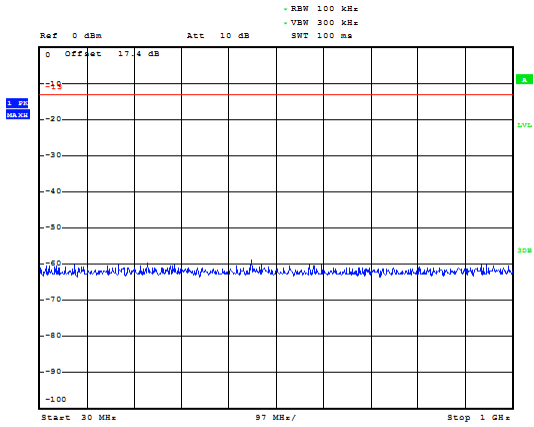

### LTE Band 4 5MHz CH-Middle 30MHz~1GHz

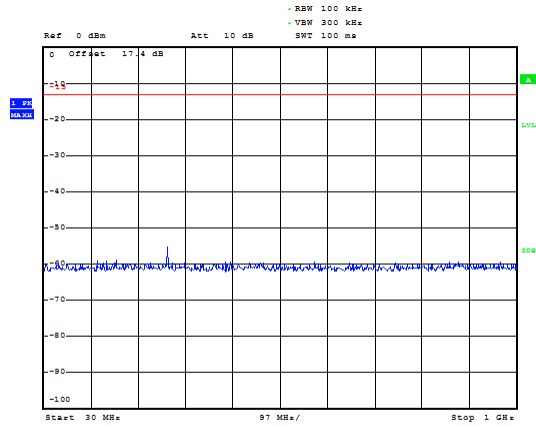

### LTE Band 4 5MHz CH-Low 1GHz~3GHz

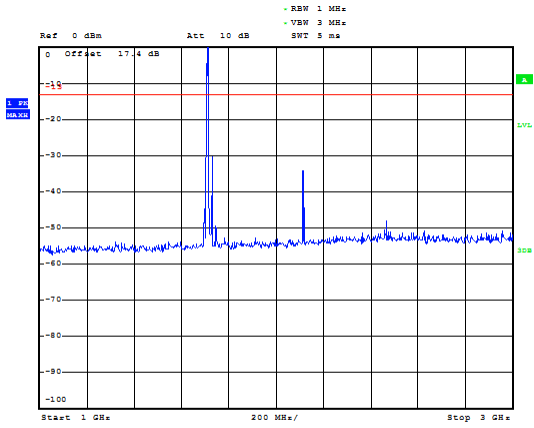

### LTE Band 4 5MHz CH-Middle 1GHz~3GHz

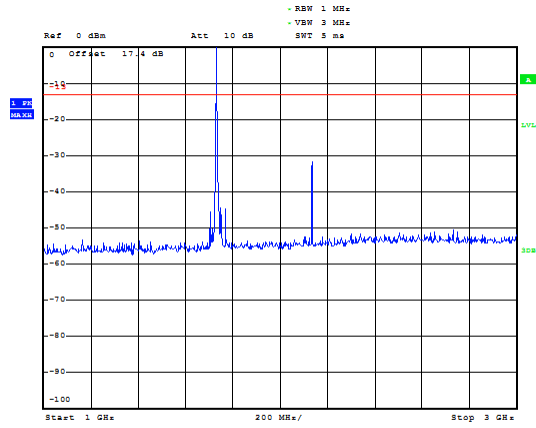

### LTE Band 4 5MHz CH-Low 3GHz~18GHz

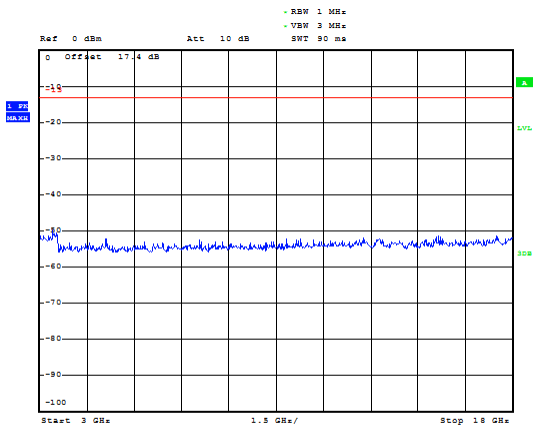

### LTE Band 4 5MHz CH-Middle 3GHz~18GHz

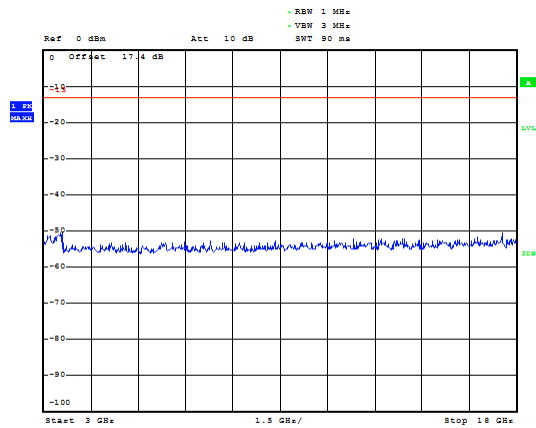



### LTE Band 4 5MHz CH-High 30MHz~1GHz

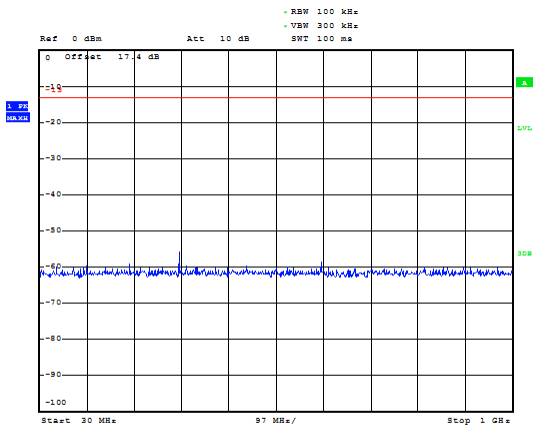

### LTE Band 4 10MHz CH-Low 30MHz~1GHz

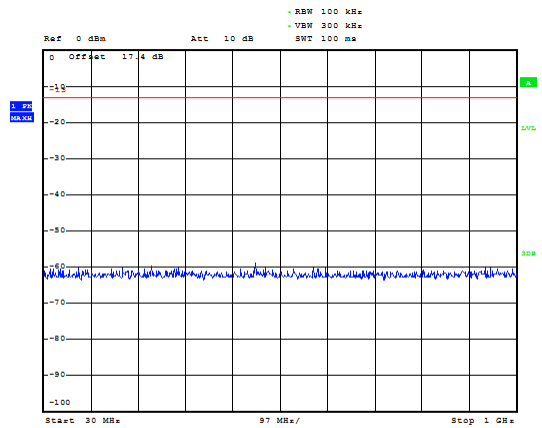

### LTE Band 4 5MHz CH-High 1GHz~3GHz

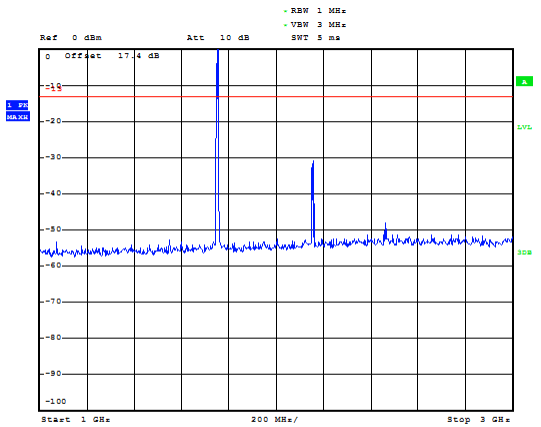

### LTE Band 4 10MHz CH-Low 1GHz~3GHz

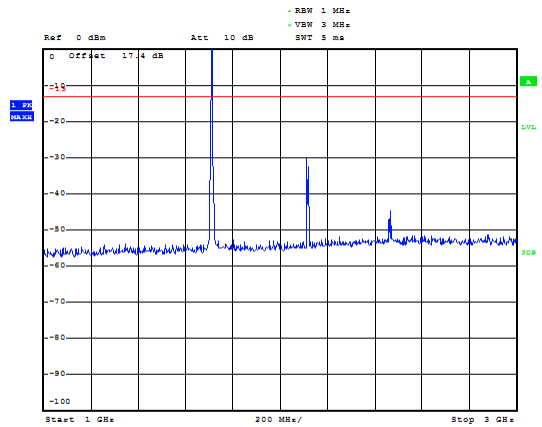

### LTE Band 4 5MHz CH-High 3GHz~18GHz

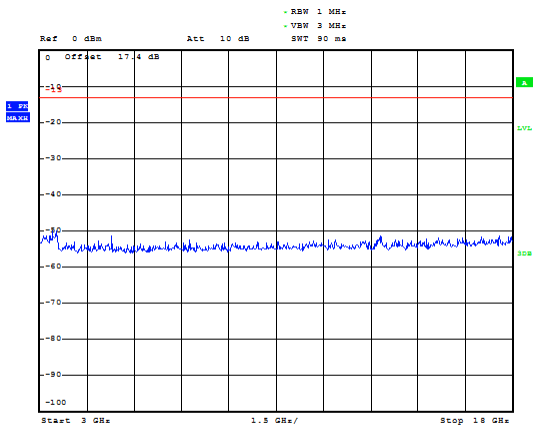

### LTE Band 4 10MHz CH-Low 3GHz~18GHz

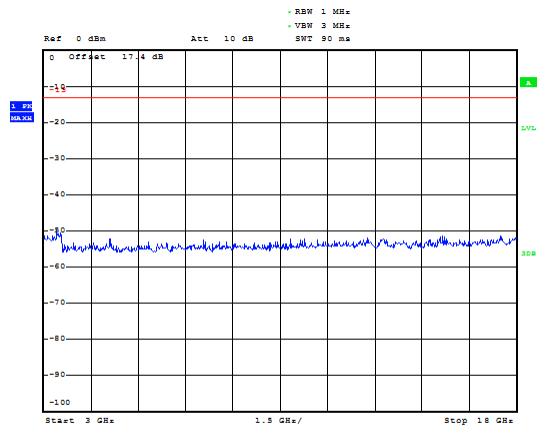



LTE Band 4 10MHz CH-Middle 30MHz~1GHz

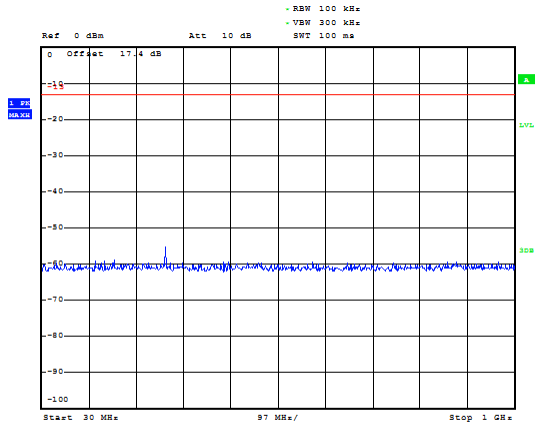

LTE Band 4 10MHz CH-High 30MHz~1GHz

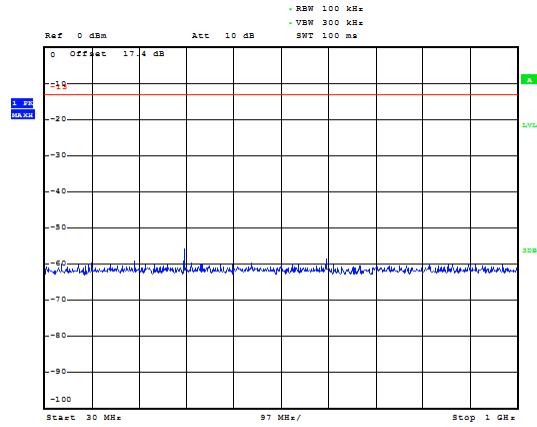

LTE Band 4 10MHz CH-Middle 1GHz~3GHz

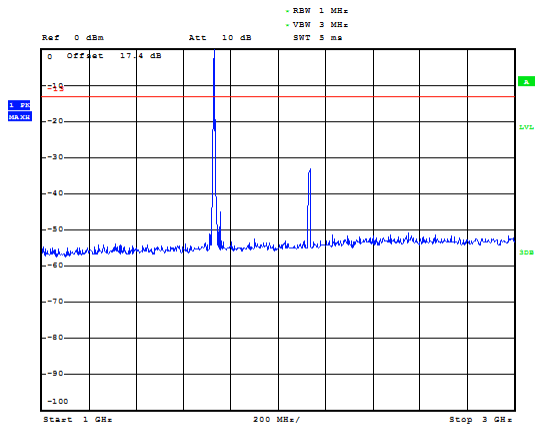

LTE Band 4 10MHz CH-High 1GHz~3GHz

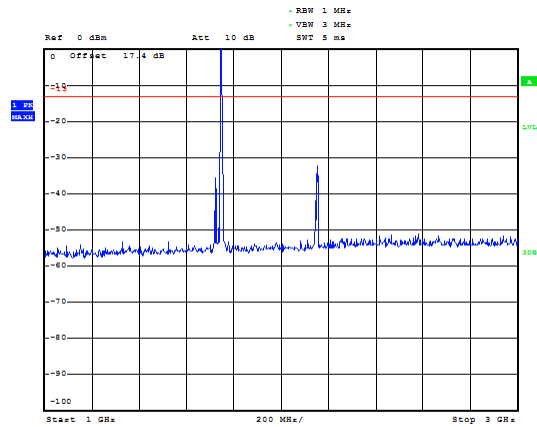

LTE Band 4 10MHz CH-Middle 3GHz~18GHz

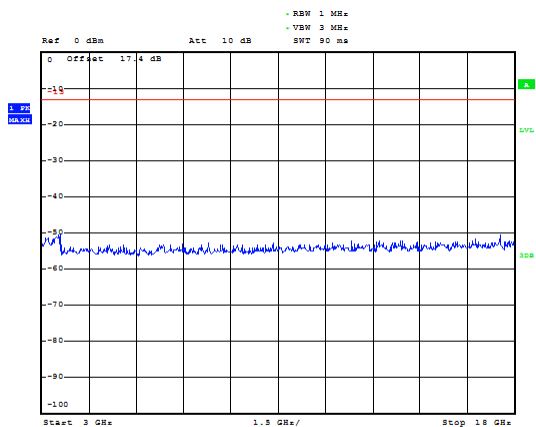

LTE Band 4 10MHz CH-High 3GHz~18GHz

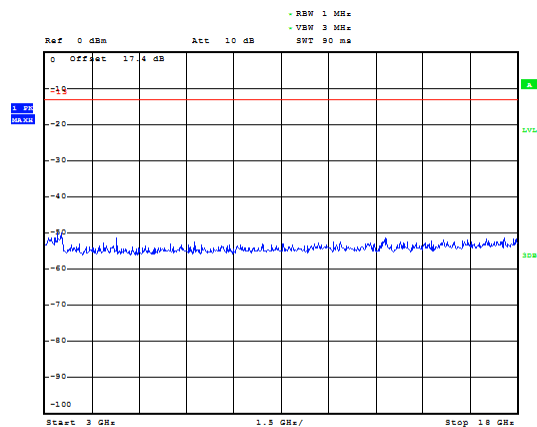



### LTE Band 4 15MHz CH-Low 30MHz~1GHz

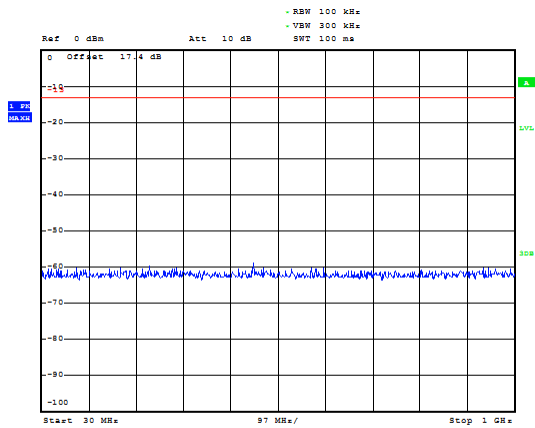

### LTE Band 4 15MHz CH-Middle 30MHz~1GHz

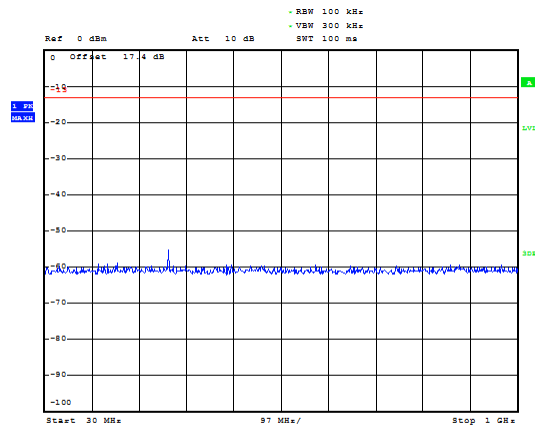

### LTE Band 4 15MHz CH-Low 1GHz~3GHz

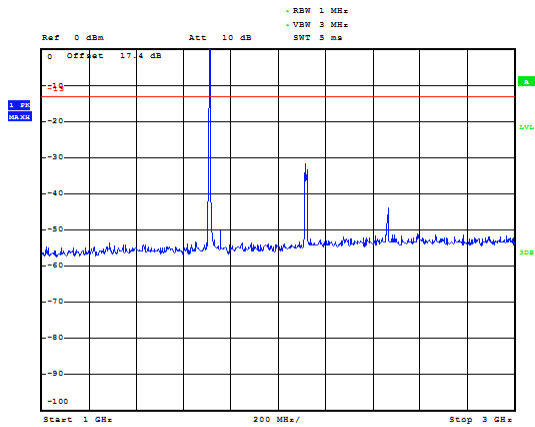

### LTE Band 4 15MHz CH-Middle 1GHz~3GHz

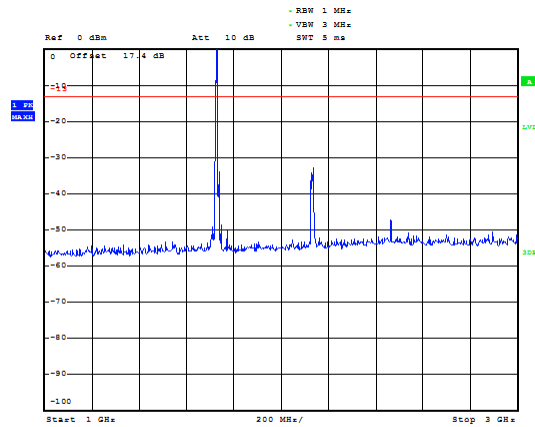

### LTE Band 4 15MHz CH-Low 3GHz~18GHz

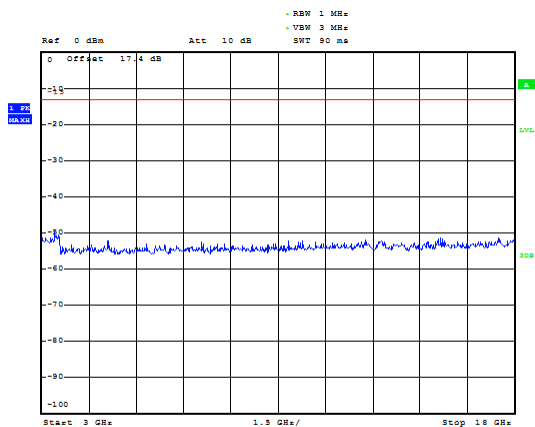

### LTE Band 4 15MHz CH-Middle 3GHz~18GHz

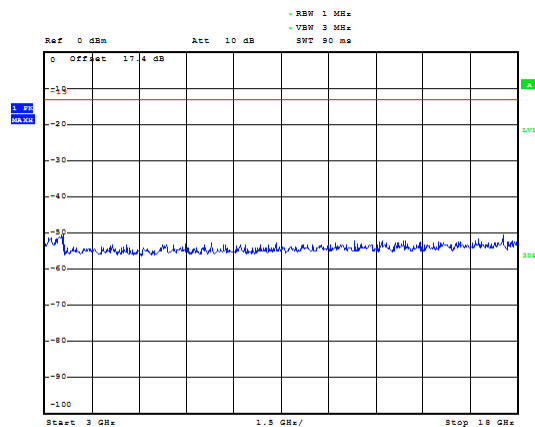



LTE Band 4 15MHz CH-High 30MHz~1GHz

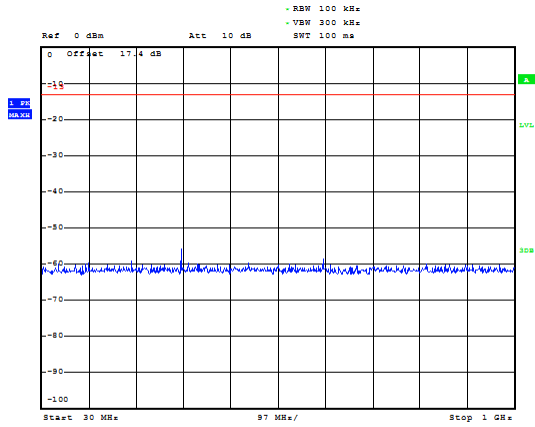

LTE Band 4 20MHz CH-Low 30MHz~1GHz

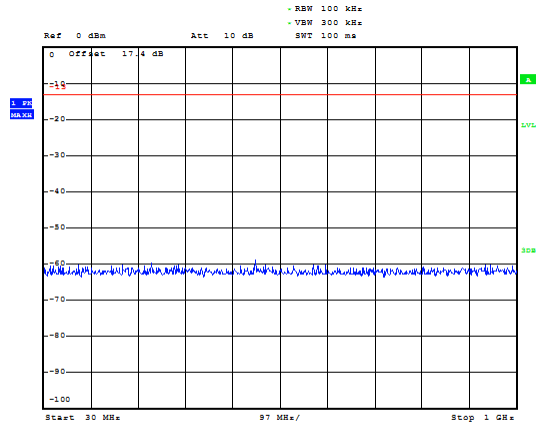

LTE Band 4 15MHz CH-High 1GHz~3GHz

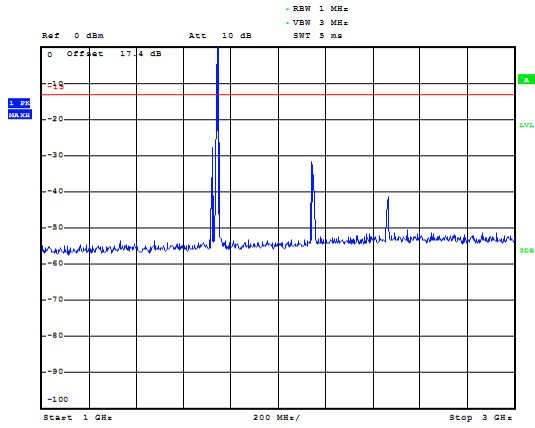

LTE Band 4 20MHz CH-Low 1GHz~3GHz

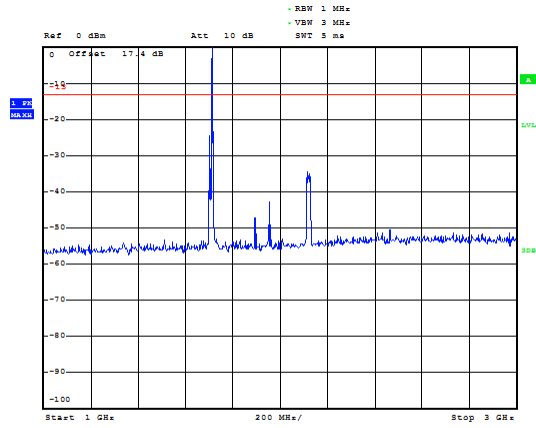

LTE Band 4 15MHz CH-High 3GHz~18GHz

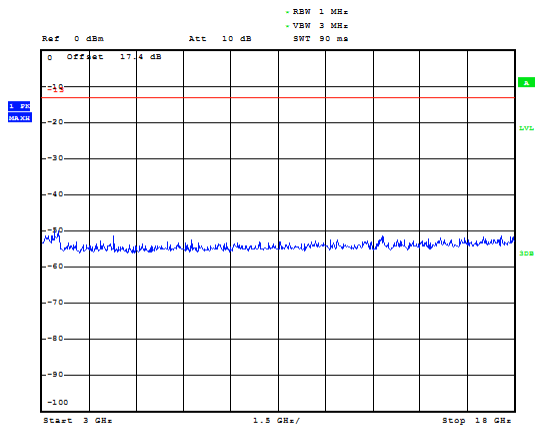

LTE Band 4 20MHz CH-Low 3GHz~18GHz

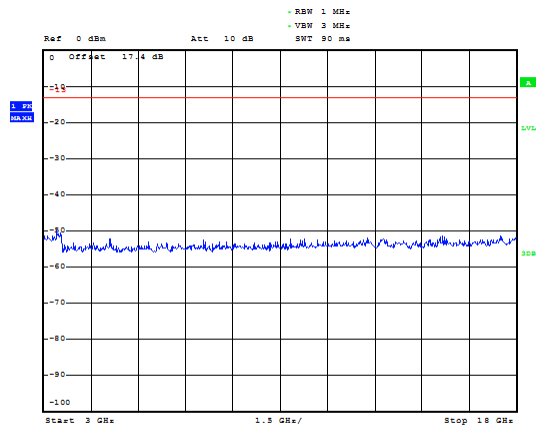



LTE Band 4 20MHz CH-Middle 30MHz~1GHz

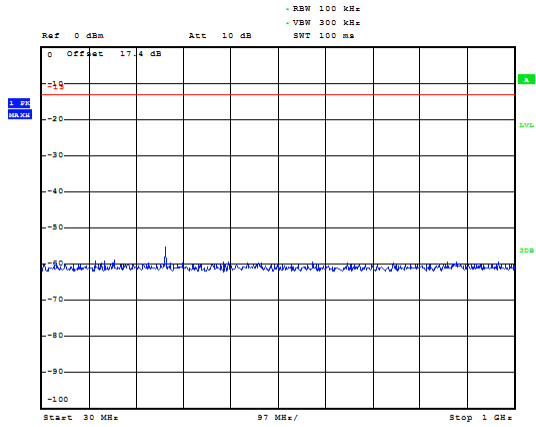

LTE Band 4 20MHz CH- High 30MHz~1GHz

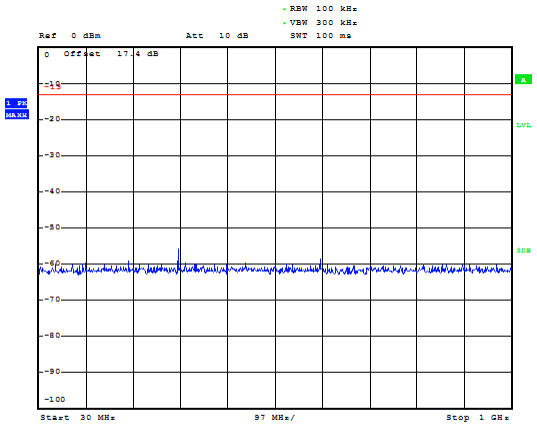

LTE Band 4 20MHz CH-Middle 1GHz~3GHz

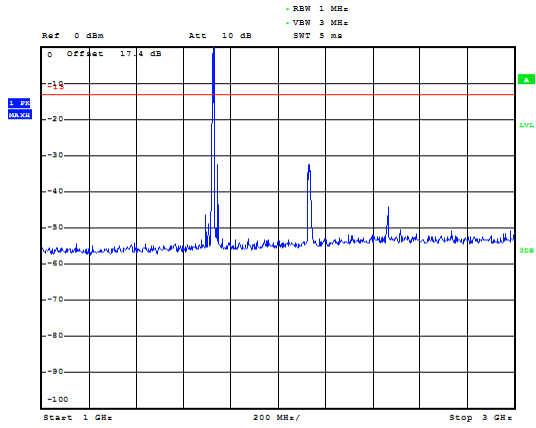

LTE Band 4 20MHz CH- High 1GHz~3GHz

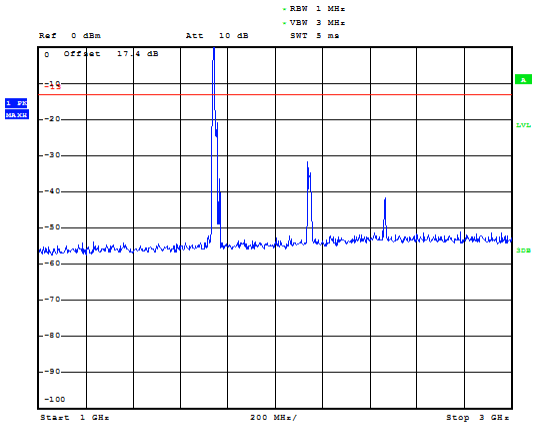

LTE Band 4 20MHz CH-Middle 3GHz~18GHz

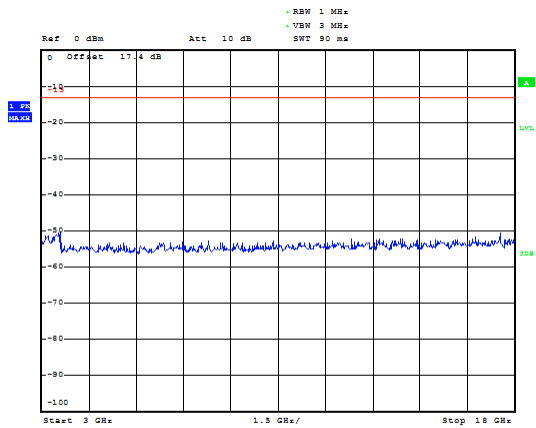

LTE Band 4 20MHz CH- High 3GHz~18GHz

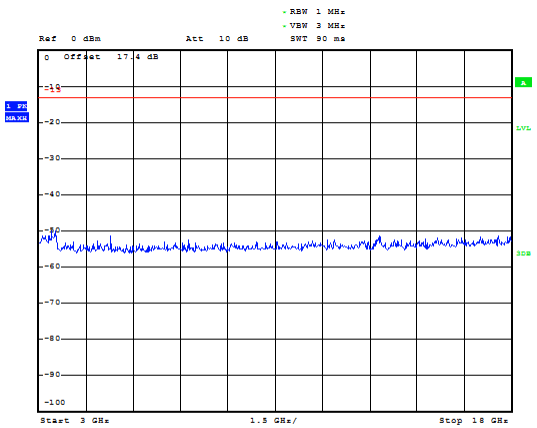

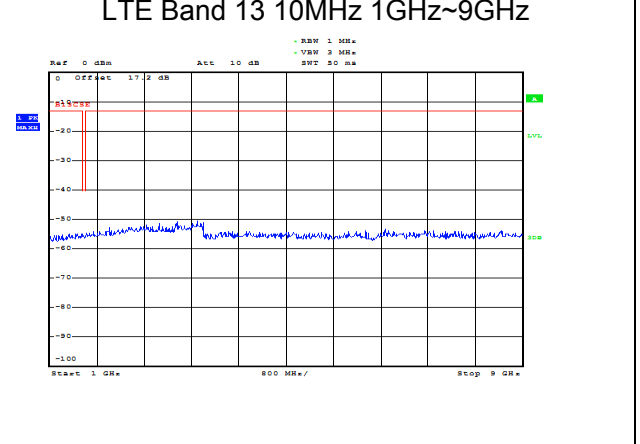
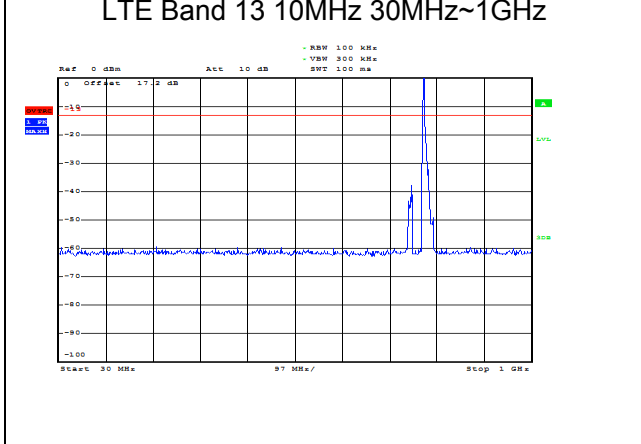
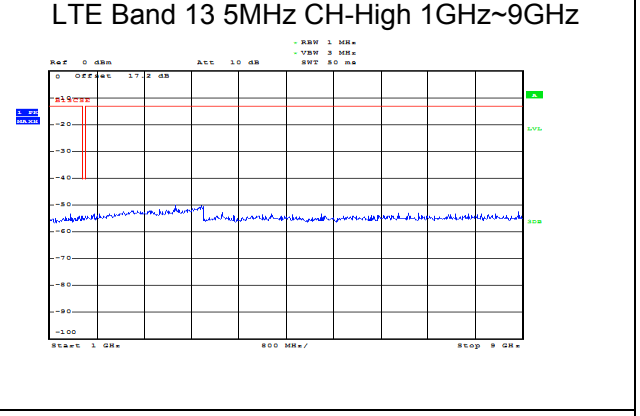
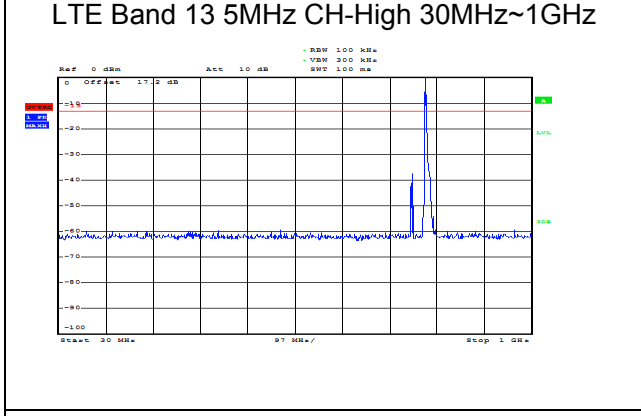
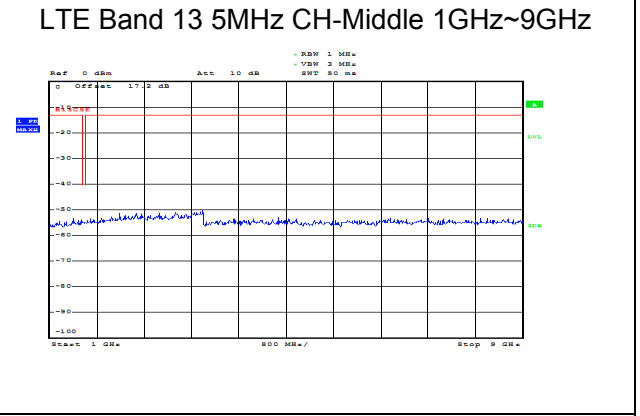
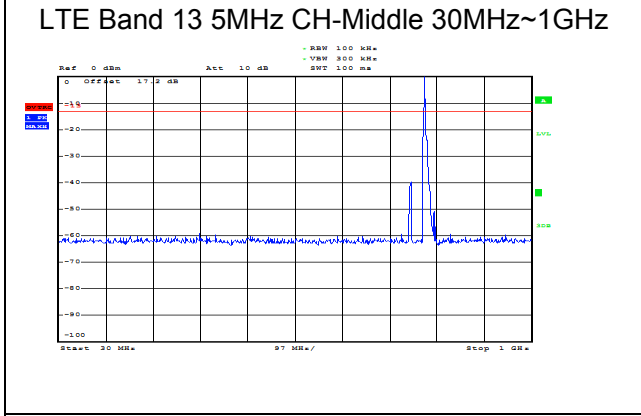
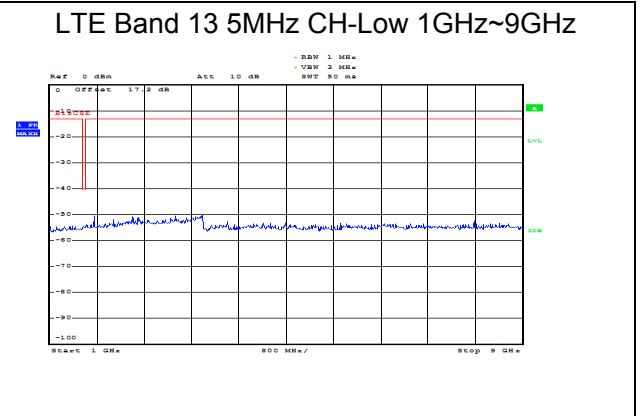
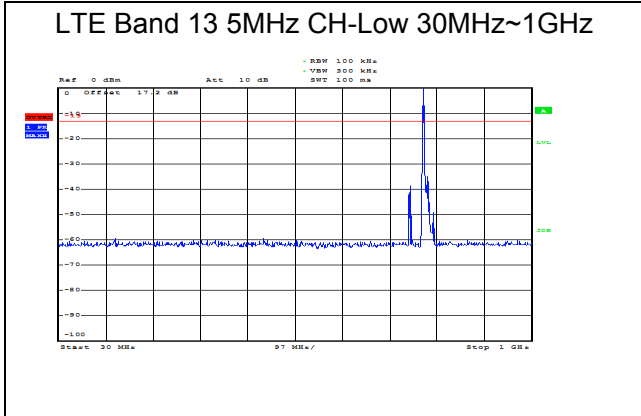

## 5.8 Radiates Spurious Emission

### Ambient condition

Temperature	Relative humidity	Pressure
23°C ~25°C	45%~50%	101.5kPa

### Method of Measurement

1. The testing follows FCC KDB 971168 D01 v03r01 Section 5.8 and ANSI/TIA-603-E (2016).
2. The EUT is placed on a turntable 0.8 meters above the ground in the chamber, 3 meter away from the antenna. The maximal emission value is acquired by adjusting the antenna height, polarisation and turntable azimuth. Normally, the height range of antenna is 1 m to 4 m, the azimuth range of turntable is 0° to 360°, and the receive antenna has two polarizations Vertical (V) and Horizontal (H).
3. A log-periodic antenna or double-ridged waveguide horn antenna shall be substituted in place of the EUT. The log-periodic antenna will be driven by a signal generator and the level will be adjusted till the same power value on the spectrum analyzer or receiver. The level of the spurious emissions can be calculated through the level of the signal generator, cable loss, the gain of the substitution antenna and the reading of the spectrum analyzer or receiver.
4. The EUT is then put into continuously transmitting mode at its maximum power level during the test. Set Test Receiver or Spectrum RBW=1MHz, VBW=3MHz, And the maximum value of the receiver should be recorded as (Pr).
5. The EUT shall be replaced by a substitution antenna. In the chamber, an substitution antenna for the frequency band of interest is placed at the reference point of the chamber. An RF Signal source for the frequency band of interest is connected to the substitution antenna with a cable that has been constructed to not interfere with the radiation pattern of the antenna. A power (PMea) is applied to the input of the substitution antenna, and adjust the level of the signal generator output until the value of the receiver reach the previously recorded (Pr). The power of signal source (PMea) is recorded. The test should be performed by rotating the test item and adjusting the receiving antenna polarization.
6. A amplifier should be connected to the Signal Source output port. And the cable should be connect between the Amplifier and the Substitution Antenna. The cable loss (Pcl) ,the Substitution Antenna Gain (Ga) and the Amplifier Gain (PAg) should be recorded after test.
7. The measurement results are obtained as described below:  

$$\text{Power(EIRP)} = \text{PMea} - \text{PAg} - \text{Pcl} + \text{Ga}$$
 The measurement results are amend as described below:  

$$\text{Power(EIRP)} = \text{PMea} - \text{Pcl} + \text{Ga}$$
8. This value is EIRP since the measurement is calibrated using an antenna of known gain (2.15 dBi) and known input power. ERP can be calculated from EIRP by subtracting the gain of the dipole,  $\text{ERP} = \text{EIRP} - 2.15\text{dBi}$ .



**Test setup**

**30MHz~~~ 1GHz**

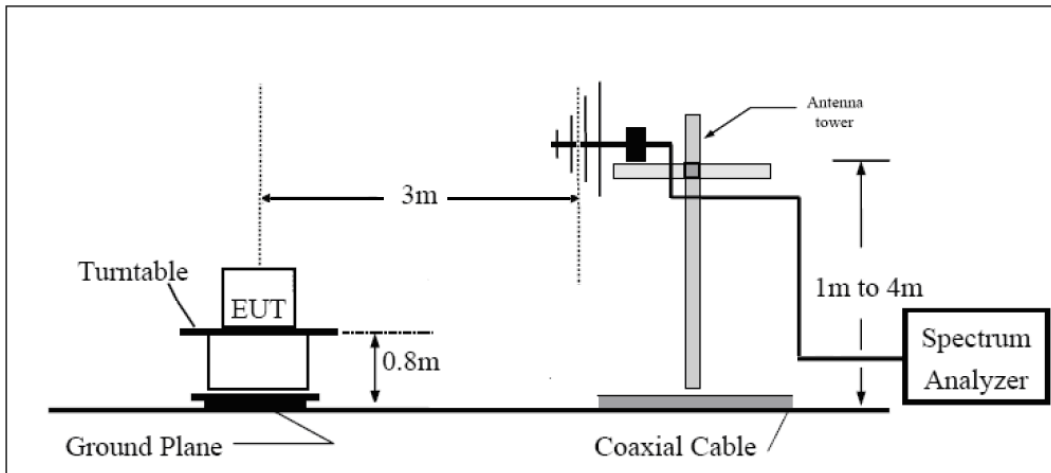

**Above 1GHz**

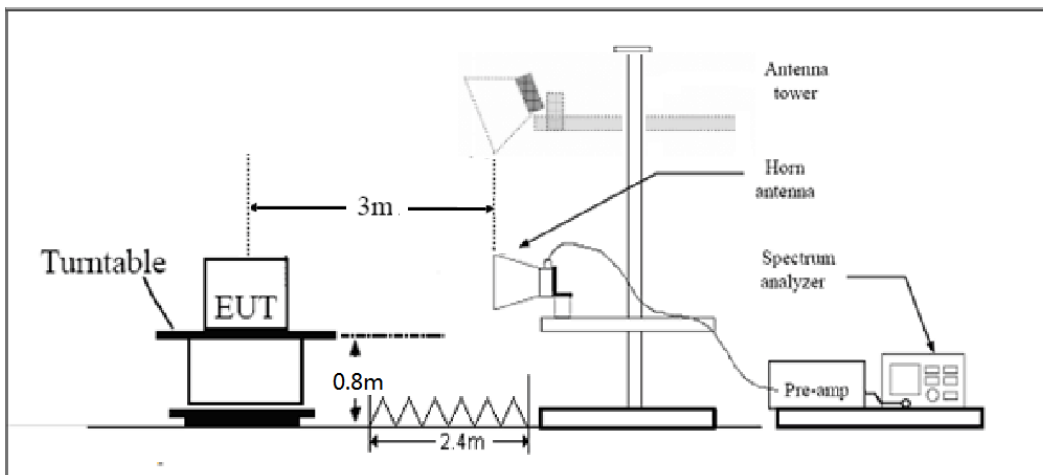

Note: Area side:2.4mX3.6m

The radiated emission was measured in the following position: EUT stand-up position (Z axis), lie-down position (X, Y axis). The worst emission was found in lie-down position (z axis) and the worst case was recorded.

**Limits**

Rule Part 27.53(h) specifies that “for operations in the 1695-1710 MHz, 1710-1755 MHz, 1755-1780 MHz, 1915-1920 MHz, 1995-2000 MHz, 2000-2020 MHz, 2110-2155 MHz, 2155-2180 MHz, and 2180-2200 bands, the power of any emission outside a licensee's frequency block shall be attenuated below the transmitter power (P) in watts by at least  $43 + 10 \log_{10} (P)$  dB..”

Rule Part 27.53(f) For operations in the 746-758 MHz, 775-788 MHz, and 805-806 MHz bands, emissions in the band 1559-1610 MHz shall be limited to  $-70$  dBW/MHz equivalent isotropically radiated power (EIRP) for wideband signals, and  $-80$  dBW EIRP for discrete emissions of less than 700 Hz bandwidth. For the purpose of equipment authorization, a transmitter shall be tested with an antenna that is representative of the type that will be used with the equipment in normal operation.



LTE B4 Limit		-13 dBm
LTE B13 Limit	Limit out of the band 1559-1610 MHz	-13 dBm
	Limit in the band 1559-1610 MHz	-40 dBm

**Measurement Uncertainty**

The assessed measurement uncertainty to ensure 95% confidence level for the normal distribution is with the coverage factor  $k = \pm 1.96$ ,  $U = \pm 3.55$  dB.

**Test Result**

Sweep above 18 GHz and the emissions more than 20 dB below the permissible value are not reported.

LTE Band 4 QPSK 1.4MHz CH-Low, RB 1

Harmonic	Frequency (MHz)	SG (dBm)	Cable Loss (dB)	Gain (dBi)	Antenna Polarization	EIRP Level (dBm)	Limit (dBm)	Margin (dB)	Azimuth (deg)
2	3421.4	-57.85	2.6	10.15	Horizontal	-50.3	-13.0	37.3	135
3	5131.1	-51.25	2.4	11.35	Horizontal	-42.3	-13.0	29.3	270
4	6842.8	-48.85	4.5	10.85	Horizontal	-42.5	-13.0	29.5	225
5	8553.5	-47.75	5.1	11.35	Horizontal	-41.5	-13.0	28.5	270
6	10264.2	-45.85	5.3	11.95	Horizontal	-39.2	-13.0	26.2	90
7	11974.9	-44.95	5.5	13.55	Horizontal	-36.9	-13.0	23.9	180
8	13685.6	-44.05	6.3	13.75	Horizontal	-36.6	-13.0	23.6	135
9	15396.3	-44.65	6.7	13.85	Horizontal	-37.5	-13.0	24.5	0
10	17107.0	-41.95	6.8	14.25	Horizontal	-34.5	-13.0	21.5	45

Note: 1.The other Spurious RF Radiated emissions level is no more than noise floor.  
2. The worst emission was found in the antenna is Horizontal position.

LTE Band 4 QPSK 1.4MHz CH-Middle, RB 1

Harmonic	Frequency (MHz)	SG (dBm)	Cable Loss (dB)	Gain (dBi)	Antenna Polarization	EIRP Level (dBm)	Limit (dBm)	Margin (dB)	Azimuth (deg)
2	3464.3	-56.85	2.6	10.75	Horizontal	-48.7	-13.0	35.7	45
3	5197.5	-45.85	2.4	11.05	Horizontal	-37.2	-13.0	24.2	315
4	6930.0	-41.55	4.5	11.15	Horizontal	-34.9	-13.0	21.9	90
5	8662.5	-46.25	5.1	11.35	Horizontal	-40.0	-13.0	27.0	315
6	10395.0	-43.65	5.3	11.95	Horizontal	-37.0	-13.0	24.0	315
7	12127.5	-45.65	5.5	13.55	Horizontal	-37.6	-13.0	24.6	315
8	13860.0	-43.15	6.3	13.75	Horizontal	-35.7	-13.0	22.7	0
9	15592.5	-44.55	6.7	13.85	Horizontal	-37.4	-13.0	24.4	180
10	17325.0	-41.95	6.8	14.25	Horizontal	-34.5	-13.0	21.5	135

Note: 1.The other Spurious RF Radiated emissions level is no more than noise floor.  
2. The worst emission was found in the antenna is Horizontal position.

**LTE Band 4 QPSK 1.4MHz CH-High, RB 1**

Harmonic	Frequency (MHz)	SG (dBm)	Cable Loss (dB)	Gain (dBi)	Antenna Polarization	EIRP Level (dBm)	Limit (dBm)	Margin (dB)	Azimuth (deg)
2	3507.8	-54.35	2.6	10.15	Horizontal	-46.8	-13.0	33.8	45
3	5261.6	-52.45	2.4	11.05	Horizontal	-43.8	-13.0	30.8	90
4	7017.2	-49.15	4.5	11.15	Horizontal	-42.5	-13.0	29.5	135
5	8771.5	-46.65	5.1	11.35	Horizontal	-40.4	-13.0	27.4	315
6	10525.8	-44.85	5.3	11.95	Horizontal	-38.2	-13.0	25.2	225
7	12280.1	-45.85	5.5	13.55	Horizontal	-37.8	-13.0	24.8	135
8	14034.4	-43.45	6.3	13.75	Horizontal	-36.0	-13.0	23.0	270
9	15788.7	-44.45	6.7	13.85	Horizontal	-37.3	-13.0	24.3	180
10	17543.0	-41.05	6.8	14.25	Horizontal	-33.6	-13.0	20.6	135

Note: 1.The other Spurious RF Radiated emissions level is no more than noise floor.  
2. The worst emission was found in the antenna is Horizontal position.

**LTE Band 4 QPSK 3MHz CH-Low, RB 1**

Harmonic	Frequency (MHz)	SG (dBm)	Cable Loss (dB)	Gain (dBi)	Antenna Polarization	EIRP Level (dBm)	Limit (dBm)	Margin (dB)	Azimuth (deg)
2	3423.0	-57.15	2.6	10.15	Horizontal	-49.6	-13.0	36.6	45
3	5134.5	-51.95	2.4	11.35	Horizontal	-43.0	-13.0	30.0	45
4	6846.0	-48.35	4.5	10.85	Horizontal	-42.0	-13.0	29.0	315
5	8557.5	-47.35	5.1	11.35	Horizontal	-41.1	-13.0	28.1	135
6	10269.0	-44.55	5.3	11.95	Horizontal	-37.9	-13.0	24.9	315
7	11980.5	-41.65	5.5	13.55	Horizontal	-33.6	-13.0	20.6	135
8	13692.0	-44.35	6.3	13.75	Horizontal	-36.9	-13.0	23.9	135
9	15403.5	-44.55	6.7	13.85	Horizontal	-37.4	-13.0	24.4	135
10	17115.0	-42.65	6.8	14.25	Horizontal	-35.2	-13.0	22.2	45

Note: 1.The other Spurious RF Radiated emissions level is no more than noise floor.  
2. The worst emission was found in the antenna is Horizontal position.

**LTE Band 4 QPSK 3MHz CH-Middle, RB 1**

Harmonic	Frequency (MHz)	SG (dBm)	Cable Loss (dB)	Gain (dBi)	Antenna Polarization	EIRP Level (dBm)	Limit (dBm)	Margin (dB)	Azimuth (deg)
2	3465.0	-57.05	2.6	10.75	Horizontal	-48.9	-13.0	35.9	225
3	5197.5	-46.35	2.4	11.05	Horizontal	-37.7	-13.0	24.7	45
4	6930.0	-41.45	4.5	11.15	Horizontal	-34.8	-13.0	21.8	135
5	8662.5	-46.15	5.1	11.35	Horizontal	-39.9	-13.0	26.9	180
6	10395.0	-43.85	5.3	11.95	Horizontal	-37.2	-13.0	24.2	180
7	12127.5	-45.15	5.5	13.55	Horizontal	-37.1	-13.0	24.1	45
8	13860.0	-43.25	6.3	13.75	Horizontal	-35.8	-13.0	22.8	270
9	15592.5	-45.15	6.7	13.85	Horizontal	-38.0	-13.0	25.0	315
10	17325.0	-41.75	6.8	14.25	Horizontal	-34.3	-13.0	21.3	180

Note: 1. The other Spurious RF Radiated emissions level is no more than noise floor.  
2. The worst emission was found in the antenna is Horizontal position.

**LTE Band 4 QPSK 3MHz CH-High, RB 1**

Harmonic	Frequency (MHz)	SG (dBm)	Cable Loss (dB)	Gain (dBi)	Antenna Polarization	EIRP Level (dBm)	Limit (dBm)	Margin (dB)	Azimuth (deg)
2	3504.8	-52.35	2.6	10.15	Horizontal	-44.8	-13.0	31.8	90
3	5256.8	-54.55	2.4	11.05	Horizontal	-45.9	-13.0	32.9	135
4	7014.0	-49.05	4.5	11.15	Horizontal	-42.4	-13.0	29.4	45
5	8767.5	-47.15	5.1	11.35	Horizontal	-40.9	-13.0	27.9	135
6	10521.0	-44.05	5.3	11.95	Horizontal	-37.4	-13.0	24.4	225
7	12274.5	-45.45	5.5	13.55	Horizontal	-37.4	-13.0	24.4	135
8	14028.0	-43.25	6.3	13.75	Horizontal	-35.8	-13.0	22.8	0
9	15781.5	-44.75	6.7	13.85	Horizontal	-37.6	-13.0	24.6	90
10	17535.0	-42.85	6.8	14.25	Horizontal	-35.4	-13.0	22.4	315

Note: 1. The other Spurious RF Radiated emissions level is no more than noise floor.  
2. The worst emission was found in the antenna is Horizontal position.

**LTE Band 4 QPSK 5MHz CH-Low, RB 1**

Harmonic	Frequency (MHz)	SG (dBm)	Cable Loss (dB)	Gain (dBi)	Antenna Polarization	EIRP Level (dBm)	Limit (dBm)	Margin (dB)	Azimuth (deg)
2	3425.0	-56.95	2.6	10.15	Horizontal	-49.4	-13.0	36.4	315
3	5131.1	-55.95	2.4	11.35	Horizontal	-47.0	-13.0	34.0	225
4	6850.0	-47.05	4.5	10.85	Horizontal	-40.7	-13.0	27.7	0
5	8562.5	-46.95	5.1	11.35	Horizontal	-40.7	-13.0	27.7	270
6	10275.0	-44.05	5.3	11.95	Horizontal	-37.4	-13.0	24.4	0
7	11987.5	-47.55	5.5	13.55	Horizontal	-39.5	-13.0	26.5	270
8	13700.0	-42.25	6.3	13.75	Horizontal	-34.8	-13.0	21.8	90
9	15412.5	-44.75	6.7	13.85	Horizontal	-37.6	-13.0	24.6	225
10	17125.0	-42.25	6.8	14.25	Horizontal	-34.8	-13.0	21.8	315

Note: 1. The other Spurious RF Radiated emissions level is no more than noise floor.  
2. The worst emission was found in the antenna is Horizontal position.

**LTE Band 4 QPSK 5MHz CH-Middle, RB 1**

Harmonic	Frequency (MHz)	SG (dBm)	Cable Loss (dB)	Gain (dBi)	Antenna Polarization	EIRP Level (dBm)	Limit (dBm)	Margin (dB)	Azimuth (deg)
2	3460.5	-56.65	2.6	10.75	Horizontal	-48.5	-13.0	35.5	0
3	5191.5	-49.55	2.4	11.05	Horizontal	-40.9	-13.0	27.9	45
4	6930.0	-42.25	4.5	11.15	Horizontal	-35.6	-13.0	22.6	45
5	8662.5	-46.35	5.1	11.35	Horizontal	-40.1	-13.0	27.1	225
6	10395.0	-45.75	5.3	11.95	Horizontal	-39.1	-13.0	26.1	90
7	12127.5	-46.35	5.5	13.55	Horizontal	-38.3	-13.0	25.3	270
8	13860.0	-45.15	6.3	13.75	Horizontal	-37.7	-13.0	24.7	90
9	15592.5	-45.35	6.7	13.85	Horizontal	-38.2	-13.0	25.2	315
10	17325.0	-41.35	6.8	14.25	Horizontal	-33.9	-13.0	20.9	90

Note: 1. The other Spurious RF Radiated emissions level is no more than noise floor.  
2. The worst emission was found in the antenna is Horizontal position.



## LTE Band 4 QPSK 5MHz CH-High, RB 1

Harmonic	Frequency (MHz)	SG (dBm)	Cable Loss (dB)	Gain (dBi)	Antenna Polarization	EIRP Level (dBm)	Limit (dBm)	Margin (dB)	Azimuth (deg)
2	3505.0	-53.15	2.6	10.15	Horizontal	-45.6	-13.0	32.6	315
3	5257.5	-54.95	2.4	11.05	Horizontal	-46.3	-13.0	33.3	135
4	7010.0	-48.15	4.5	11.15	Horizontal	-41.5	-13.0	28.5	0
5	8762.5	-46.65	5.1	11.35	Horizontal	-40.4	-13.0	27.4	135
6	10515.0	-43.85	5.3	11.95	Horizontal	-37.2	-13.0	24.2	135
7	12267.5	-46.65	5.5	13.55	Horizontal	-38.6	-13.0	25.6	90
8	14020.0	-41.75	6.3	13.75	Horizontal	-34.3	-13.0	21.3	135
9	15772.5	-45.05	6.7	13.85	Horizontal	-37.9	-13.0	24.9	270
10	17525.0	-41.35	6.8	14.25	Horizontal	-33.9	-13.0	20.9	180

Note: 1.The other Spurious RF Radiated emissions level is no more than noise floor.  
2. The worst emission was found in the antenna is Horizontal position.

## LTE Band 4 QPSK 10MHz CH-Low, RB 1

Harmonic	Frequency (MHz)	SG (dBm)	Cable Loss (dB)	Gain (dBi)	Antenna Polarization	EIRP Level (dBm)	Limit (dBm)	Margin (dB)	Azimuth (deg)
2	3430.0	-56.55	2.6	10.15	Horizontal	-49.0	-13.0	36.0	0
3	5145.0	-54.45	2.4	11.35	Horizontal	-45.5	-13.0	32.5	180
4	6860.0	-50.05	4.5	10.85	Horizontal	-43.7	-13.0	30.7	180
5	8575.0	-47.15	5.1	11.35	Horizontal	-40.9	-13.0	27.9	315
6	10290.0	-44.25	5.3	11.95	Horizontal	-37.6	-13.0	24.6	135
7	12005.0	-45.85	5.5	13.55	Horizontal	-37.8	-13.0	24.8	270
8	13720.0	-42.85	6.3	13.75	Horizontal	-35.4	-13.0	22.4	0
9	15435.0	-44.95	6.7	13.85	Horizontal	-37.8	-13.0	24.8	270
10	17150.0	-41.85	6.8	14.25	Horizontal	-34.4	-13.0	21.4	135

Note: 1.The other Spurious RF Radiated emissions level is no more than noise floor.  
2. The worst emission was found in the antenna is Horizontal position.

**LTE Band 4 QPSK 10MHz CH-Middle, RB 1**

Harmonic	Frequency (MHz)	SG (dBm)	Cable Loss (dB)	Gain (dBi)	Antenna Polarization	EIRP Level (dBm)	Limit (dBm)	Margin (dB)	Azimuth (deg)
2	3465.0	-58.25	2.6	10.75	Horizontal	-50.1	-13.0	37.1	0
3	5197.5	-46.75	2.4	11.05	Horizontal	-38.1	-13.0	25.1	135
4	6930.0	-42.25	4.5	11.15	Horizontal	-35.6	-13.0	22.6	225
5	8662.5	-45.95	5.1	11.35	Horizontal	-39.7	-13.0	26.7	45
6	10395.0	-45.25	5.3	11.95	Horizontal	-38.6	-13.0	25.6	315
7	12127.5	-46.85	5.5	13.55	Horizontal	-38.8	-13.0	25.8	0
8	13860.0	-44.35	6.3	13.75	Horizontal	-36.9	-13.0	23.9	180
9	15592.5	-45.05	6.7	13.85	Horizontal	-37.9	-13.0	24.9	135
10	17325.0	-42.15	6.8	14.25	Horizontal	-34.7	-13.0	21.7	90

Note: 1.The other Spurious RF Radiated emissions level is no more than noise floor.  
2. The worst emission was found in the antenna is Horizontal position.

**LTE Band 4 QPSK 10MHz CH-High, RB 1**

Harmonic	Frequency (MHz)	SG (dBm)	Cable Loss (dB)	Gain (dBi)	Antenna Polarization	EIRP Level (dBm)	Limit (dBm)	Margin (dB)	Azimuth (deg)
2	3500.0	-54.85	2.6	10.15	Horizontal	-47.3	-13.0	34.3	225
3	5250.0	-54.95	2.4	11.05	Horizontal	-46.3	-13.0	33.3	135
4	7000.0	-49.95	4.5	11.15	Horizontal	-43.3	-13.0	30.3	0
5	8750.0	-47.05	5.1	11.35	Horizontal	-40.8	-13.0	27.8	225
6	10500.0	-44.35	5.3	11.95	Horizontal	-37.7	-13.0	24.7	135
7	12250.0	-46.35	5.5	13.55	Horizontal	-38.3	-13.0	25.3	45
8	14000.0	-42.85	6.3	13.75	Horizontal	-35.4	-13.0	22.4	180
9	15750.0	-44.65	6.7	13.85	Horizontal	-37.5	-13.0	24.5	90
10	17500.0	-42.45	6.8	14.25	Horizontal	-35.0	-13.0	22.0	180

Note: 1.The other Spurious RF Radiated emissions level is no more than noise floor.  
2. The worst emission was found in the antenna is Horizontal position.



**LTE Band 4 QPSK 15MHz CH Low, RB 1**

Harmonic	Frequency (MHz)	SG (dBm)	Cable Loss (dB)	Gain (dBi)	Antenna Polarization	EIRP Level (dBm)	Limit (dBm)	Margin (dB)	Azimuth (deg)
2	3435.0	-56.75	2.6	10.15	Horizontal	-49.2	-13.0	36.2	0
3	5152.5	-55.25	2.4	11.35	Horizontal	-46.3	-13.0	33.3	135
4	6870.0	-49.15	4.5	10.85	Horizontal	-42.8	-13.0	29.8	180
5	8587.5	-46.45	5.1	11.35	Horizontal	-40.2	-13.0	27.2	90
6	10305.0	-43.65	5.3	11.95	Horizontal	-37.0	-13.0	24.0	0
7	12022.5	-46.95	5.5	13.55	Horizontal	-38.9	-13.0	25.9	0
8	13740.0	-43.45	6.3	13.75	Horizontal	-36.0	-13.0	23.0	45
9	15457.5	-44.45	6.7	13.85	Horizontal	-37.3	-13.0	24.3	315
10	17175.0	-42.45	6.8	14.25	Horizontal	-35.0	-13.0	22.0	180

Note: 1.The other Spurious RF Radiated emissions level is no more than noise floor.  
2. The worst emission was found in the antenna is Horizontal position.

**LTE Band 4 QPSK 15MHz CH-Middle, RB 1**

Harmonic	Frequency (MHz)	SG (dBm)	Cable Loss (dB)	Gain (dBi)	Antenna Polarization	EIRP Level (dBm)	Limit (dBm)	Margin (dB)	Azimuth (deg)
2	3465.0	-55.75	2.6	10.75	Horizontal	-47.6	-13.0	34.6	0
3	5197.5	-48.55	2.4	11.05	Horizontal	-39.9	-13.0	26.9	45
4	6930.0	-45.75	4.5	11.15	Horizontal	-39.1	-13.0	26.1	315
5	8662.5	-47.25	5.1	11.35	Horizontal	-41.0	-13.0	28.0	225
6	10395.0	-44.55	5.3	11.95	Horizontal	-37.9	-13.0	24.9	315
7	12127.5	-46.75	5.5	13.55	Horizontal	-38.7	-13.0	25.7	225
8	13860.0	-44.25	6.3	13.75	Horizontal	-36.8	-13.0	23.8	135
9	15592.5	-44.45	6.7	13.85	Horizontal	-37.3	-13.0	24.3	0
10	17325.0	-42.45	6.8	14.25	Horizontal	-35.0	-13.0	22.0	90

Note: 1.The other Spurious RF Radiated emissions level is no more than noise floor.  
2. The worst emission was found in the antenna is Horizontal position.

**LTE Band 4 QPSK 15MHz CH-High, RB 1**

Harmonic	Frequency (MHz)	SG (dBm)	Cable Loss (dB)	Gain (dBi)	Antenna Polarization	EIRP Level (dBm)	Limit (dBm)	Margin (dB)	Azimuth (deg)
2	3495.0	-54.05	2.6	10.15	Horizontal	-46.5	-13.0	33.5	225
3	5242.5	-55.05	2.4	11.05	Horizontal	-46.4	-13.0	33.4	315
4	6990.0	-50.25	4.5	11.15	Horizontal	-43.6	-13.0	30.6	180
5	8737.5	-46.95	5.1	11.35	Horizontal	-40.7	-13.0	27.7	0
6	10485.0	-44.95	5.3	11.95	Horizontal	-38.3	-13.0	25.3	180
7	12232.5	-46.65	5.5	13.55	Horizontal	-38.6	-13.0	25.6	225
8	13980.0	-43.85	6.3	13.75	Horizontal	-36.4	-13.0	23.4	0
9	15727.5	-44.65	6.7	13.85	Horizontal	-37.5	-13.0	24.5	315
10	17475.0	-42.55	6.8	14.25	Horizontal	-35.1	-13.0	22.1	90

Note: 1. The other Spurious RF Radiated emissions level is no more than noise floor.  
2. The worst emission was found in the antenna is Horizontal position.

**LTE Band 4 QPSK 20MHz CH-Low, RB 1**

Harmonic	Frequency (MHz)	SG (dBm)	Cable Loss (dB)	Gain (dBi)	Antenna Polarization	EIRP Level (dBm)	Limit (dBm)	Margin (dB)	Azimuth (deg)
2	3440.0	-57.05	2.6	10.15	Horizontal	-49.5	-13.0	36.5	45
3	5160.0	-50.55	2.4	11.35	Horizontal	-41.6	-13.0	28.6	315
4	6880.0	-48.75	4.5	10.85	Horizontal	-42.4	-13.0	29.4	90
5	8600.0	-46.65	5.1	11.35	Horizontal	-40.4	-13.0	27.4	315
6	10320.0	-43.65	5.3	11.95	Horizontal	-37.0	-13.0	24.0	315
7	12040.0	-45.95	5.5	13.55	Horizontal	-37.9	-13.0	24.9	270
8	13760.0	-43.25	6.3	13.75	Horizontal	-35.8	-13.0	22.8	315
9	15480.0	-43.95	6.7	13.85	Horizontal	-36.8	-13.0	23.8	270
10	17200.0	-42.25	6.8	14.25	Horizontal	-34.8	-13.0	21.8	225

Note: 1. The other Spurious RF Radiated emissions level is no more than noise floor.  
2. The worst emission was found in the antenna is Horizontal position.

**LTE Band 4 QPSK 20MHz CH-Middle, RB 1**

Harmonic	Frequency (MHz)	SG (dBm)	Cable Loss (dB)	Gain (dBi)	Antenna Polarization	EIRP Level (dBm)	Limit (dBm)	Margin (dB)	Azimuth (deg)
2	3465.0	-55.25	2.6	10.75	Horizontal	-47.1	-13.0	34.1	180
3	5197.5	-50.25	2.4	11.05	Horizontal	-41.6	-13.0	28.6	135
4	6930.0	-49.85	4.5	11.15	Horizontal	-43.2	-13.0	30.2	90
5	8662.5	-47.35	5.1	11.35	Horizontal	-41.1	-13.0	28.1	45
6	10395.0	-44.45	5.3	11.95	Horizontal	-37.8	-13.0	24.8	0
7	12127.5	-46.15	5.5	13.55	Horizontal	-38.1	-13.0	25.1	90
8	13860.0	-45.65	6.3	13.75	Horizontal	-38.2	-13.0	25.2	90
9	15592.5	-45.05	6.7	13.85	Horizontal	-37.9	-13.0	24.9	270
10	17325.0	-42.45	6.8	14.25	Horizontal	-35.0	-13.0	22.0	180

Note: 1.The other Spurious RF Radiated emissions level is no more than noise floor.  
2. The worst emission was found in the antenna is Horizontal position.

**LTE Band 4 QPSK 20MHz CH-High, RB 1**

Harmonic	Frequency (MHz)	SG (dBm)	Cable Loss (dB)	Gain (dBi)	Antenna Polarization	EIRP Level (dBm)	Limit (dBm)	Margin (dB)	Azimuth (deg)
2	3490.0	-51.55	2.6	10.15	Horizontal	-44.0	-13.0	31.0	45
3	5235.0	-51.35	2.4	11.05	Horizontal	-42.7	-13.0	29.7	90
4	6980.0	-47.65	4.5	11.15	Horizontal	-41.0	-13.0	28.0	225
5	8725.0	-46.25	5.1	11.35	Horizontal	-40.0	-13.0	27.0	315
6	10470.0	-44.45	5.3	11.95	Horizontal	-37.8	-13.0	24.8	90
7	12215.0	-46.55	5.5	13.55	Horizontal	-38.5	-13.0	25.5	180
8	13960.0	-43.05	6.3	13.75	Horizontal	-35.6	-13.0	22.6	90
9	15705.0	-44.95	6.7	13.85	Horizontal	-37.8	-13.0	24.8	225
10	17450.0	-42.55	6.8	14.25	Horizontal	-35.1	-13.0	22.1	270

Note: 1.The other Spurious RF Radiated emissions level is no more than noise floor.  
2. The worst emission was found in the antenna is Horizontal position.

**LTE Band 13 QPSK 5MHz CH-Low, RB 1**

Harmonic	Frequency (MHz)	SG (dBm)	Cable Loss (dB)	Gain (dBi)	Antenna Polarization	ERP Level (dBm)	Limit (dBm)	Margin (dB)	Azimuth (deg)
2	1555.8	-60.70	2.00	10.15	Horizontal	-54.7	-13.0	41.7	225
3	2338.5	-57.70	2.50	11.35	Horizontal	-51.0	-13.0	38.0	180
4	3118.0	-55.00	4.20	10.85	Horizontal	-50.5	-13.0	37.5	180
5	3897.5	-51.60	5.20	11.35	Horizontal	-47.6	-13.0	34.6	135
6	4677.0	-52.50	5.50	11.95	Horizontal	-48.2	-13.0	35.2	135
7	5456.5	-52.00	5.70	13.55	Horizontal	-46.3	-13.0	33.3	0
8	6236.0	-51.00	6.30	13.75	Horizontal	-45.7	-13.0	32.7	315
9	7015.5	-45.90	6.80	13.85	Horizontal	-41.0	-13.0	28.0	90
10	7795.0	-46.20	6.90	14.25	Horizontal	-41.0	-13.0	28.0	135

Note: 1.The other Spurious RF Radiated emissions level is no more than noise floor.  
2. The worst emission was found in the antenna is Horizontal position.

**LTE Band 13 QPSK 5MHz CH-Middle, RB 1**

Harmonic	Frequency (MHz)	SG (dBm)	Cable Loss (dB)	Gain (dBi)	Antenna Polarization	ERP Level (dBm)	Limit (dBm)	Margin (dB)	Azimuth (deg)
2	1564.0	-61.10	2.00	10.75	Horizontal	-54.5	-40.0	14.5	315
3	2346.0	-57.49	2.51	11.05	Horizontal	-51.1	-13.0	38.1	0
4	3128.0	-54.80	4.20	11.15	Horizontal	-50.0	-13.0	37.0	45
5	3910.0	-52.30	5.20	11.15	Horizontal	-48.5	-13.0	35.5	45
6	4692.0	-51.80	5.50	11.95	Horizontal	-47.5	-13.0	34.5	315
7	5474.0	-52.30	5.70	13.55	Horizontal	-46.6	-13.0	33.6	270
8	6256.0	-51.00	6.30	13.75	Horizontal	-45.7	-13.0	32.7	45
9	7038.0	-44.90	6.80	13.85	Horizontal	-40.0	-13.0	27.0	0
10	7820.0	-46.50	6.90	14.25	Horizontal	-41.3	-13.0	28.3	270

Note: 1.The other Spurious RF Radiated emissions level is no more than noise floor.  
2. The worst emission was found in the antenna is Horizontal position.

**LTE Band 13 QPSK 5MHz CH-High, RB 1**

Harmonic	Frequency (MHz)	SG (dBm)	Cable Loss (dB)	Gain (dBi)	Antenna Polarization	ERP Level (dBm)	Limit (dBm)	Margin (dB)	Azimuth (deg)
2	1569.0	-60.10	2.00	10.15	Horizontal	-54.1	-40.0	14.1	225
3	2353.5	-57.79	2.51	11.05	Horizontal	-51.4	-13.0	38.4	315
4	3138.0	-55.70	4.20	11.15	Horizontal	-50.9	-13.0	37.9	270
5	3922.5	-53.00	5.20	11.15	Horizontal	-49.2	-13.0	36.2	315
6	4707.0	-52.00	5.50	11.95	Horizontal	-47.7	-13.0	34.7	315
7	5491.5	-52.80	5.70	13.55	Horizontal	-47.1	-13.0	34.1	270
8	6276.0	-50.80	6.30	13.75	Horizontal	-45.5	-13.0	32.5	45
9	7060.5	-45.80	6.80	13.85	Horizontal	-40.9	-13.0	27.9	90
10	7845.0	-45.80	6.90	14.25	Horizontal	-40.6	-13.0	27.6	180

Note: 1.The other Spurious RF Radiated emissions level is no more than noise floor.  
2. The worst emission was found in the antenna is Horizontal position.

**LTE Band 13 QPSK 10MHz CH-Low, RB 1**

Harmonic	Frequency (MHz)	SG (dBm)	Cable Loss (dB)	Gain (dBi)	Antenna Polarization	ERP Level (dBm)	Limit (dBm)	Margin (dB)	Azimuth (deg)
2	1564.0	-61.20	2.00	10.15	Horizontal	-55.2	-40.0	15.2	315
3	2346.0	-57.29	2.51	11.35	Horizontal	-50.6	-13.0	37.6	45
4	3128.0	-55.50	4.20	10.85	Horizontal	-51.0	-13.0	38.0	0
5	3910.0	-51.00	5.20	11.35	Horizontal	-47.0	-13.0	34.0	270
6	4692.0	-52.60	5.50	11.95	Horizontal	-48.3	-13.0	35.3	45
7	5474.0	-54.00	5.70	13.55	Horizontal	-48.3	-13.0	35.3	270
8	6256.0	-49.90	6.30	13.75	Horizontal	-44.6	-13.0	31.6	90
9	7038.0	-43.80	6.80	13.85	Horizontal	-38.9	-13.0	25.9	315
10	7820.0	-46.20	6.90	14.25	Horizontal	-41.0	-13.0	28.0	225

Note: 1.The other Spurious RF Radiated emissions level is no more than noise floor.  
2. The worst emission was found in the antenna is Horizontal position.



## LTE Band 13 QPSK 10MHz CH-Middle, RB 1

Harmonic	Frequency (MHz)	SG (dBm)	Cable Loss (dB)	Gain (dBi)	Antenna Polarization	ERP Level (dBm)	Limit (dBm)	Margin (dB)	Azimuth (deg)
2	1564.0	-60.80	2.00	10.75	Horizontal	-54.2	-40.0	14.2	45
3	2346.0	-57.99	2.51	11.05	Horizontal	-51.6	-13.0	38.6	45
4	3128.0	-55.30	4.20	11.15	Horizontal	-50.5	-13.0	37.5	180
5	3910.0	-51.80	5.20	11.15	Horizontal	-48.0	-13.0	35.0	225
6	4692.0	-52.00	5.50	11.95	Horizontal	-47.7	-13.0	34.7	225
7	5474.0	-53.20	5.70	13.55	Horizontal	-47.5	-13.0	34.5	45
8	6256.0	-50.40	6.30	13.75	Horizontal	-45.1	-13.0	32.1	315
9	7038.0	-44.40	6.80	13.85	Horizontal	-39.5	-13.0	26.5	45
10	7820.0	-46.50	6.90	14.25	Horizontal	-41.3	-13.0	28.3	45

Note: 1. The other Spurious RF Radiated emissions level is no more than noise floor.  
2. The worst emission was found in the antenna is Horizontal position.

## LTE Band 13 QPSK 10MHz CH-High, RB 1

Harmonic	Frequency (MHz)	SG (dBm)	Cable Loss (dB)	Gain (dBi)	Antenna Polarization	ERP Level (dBm)	Limit (dBm)	Margin (dB)	Azimuth (deg)
2	1564.0	-60.10	2.00	10.15	Horizontal	-54.1	-40.0	14.1	45
3	2346.0	-57.89	2.51	11.05	Horizontal	-51.5	-13.0	38.5	0
4	3128.0	-54.60	4.20	11.15	Horizontal	-49.8	-13.0	36.8	45
5	3910.0	-51.60	5.20	11.15	Horizontal	-47.8	-13.0	34.8	270
6	4692.0	-51.50	5.50	11.95	Horizontal	-47.2	-13.0	34.2	180
7	5474.0	-53.90	5.70	13.55	Horizontal	-48.2	-13.0	35.2	270
8	6256.0	-50.00	6.30	13.75	Horizontal	-44.7	-13.0	31.7	135
9	7038.0	-44.90	6.80	13.85	Horizontal	-40.0	-13.0	27.0	270
10	7820.0	-45.50	6.90	14.25	Horizontal	-40.3	-13.0	27.3	180

Note: 1. The other Spurious RF Radiated emissions level is no more than noise floor.  
2. The worst emission was found in the antenna is Horizontal position.

## 6 Main Test Instruments

Name	Manufacturer	Type	Serial Number	Calibration Date	Expiration Date
Base Station Simulator	R&S	CMW500	113645	2017-05-14	2018-05-13
Power Splitter	Hua Xiang	SHX-GF2-2-13	10120101	2017-05-14	2018-05-13
Spectrum Analyzer	Agilent	N9010A	MY47191109	2017-05-14	2018-05-13
Signal Analyzer	R&S	FSV30	100815	2017-12-17	2018-12-16
Signal generator	R&S	SMB 100A	102594	2017-05-14	2018-05-13
EMI Test Receiver	R&S	ESCI	100948	2017-05-20	2018-05-19
Loop Antenna	SCHWARZBECK	FMZB1519	1519-047	2014-12-06	2019-12-05
Trilog Antenna	SCHWARZBECK	VUBL 9163	9163-201	2017-11-18	2020-11-17
Horn Antenna	R&S	HF907	100126	2014-12-06	2019-12-05
Horn Antenna	ETS-Lindgren	3160-09	00102643	2015-01-30	2020-01-29
Climatic Chamber	Re Ce	PT-30B	20101891	2015-07-18	2018-07-17
RF Cable	Agilent	SMA 15cm	0001	NA	NA
Preamplifier	R&S	SCU18	102327	2017-06-18	2018-06-17
MOB COMMS DC SUPPLY	Keysight	66319D	MY43004105	2017-05-14	2018-05-13
Software	R&S	EMC32	V 8.52.0	NA	NA

\*\*\*\*\*END OF REPORT \*\*\*\*\*

# ANNEX A: EUT Appearance and Test Setup

## A.1 EUT Appearance



a: EUT

Picture 1 EUT and Accessory



## A.2 Test Setup

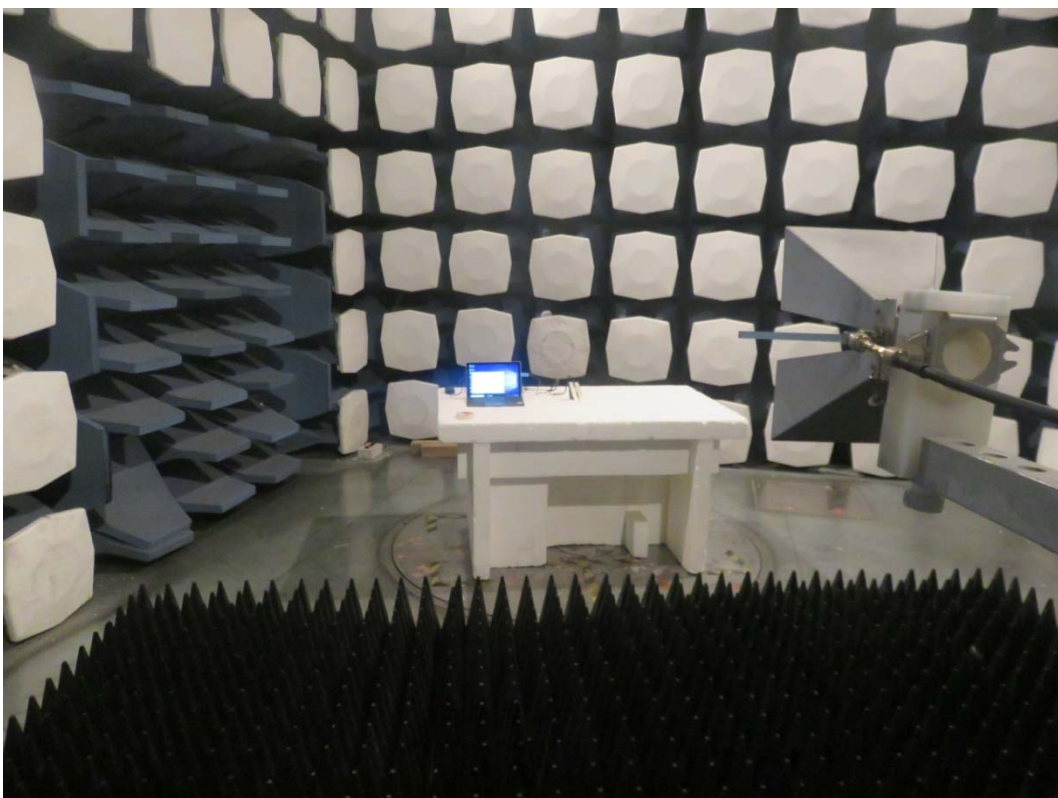
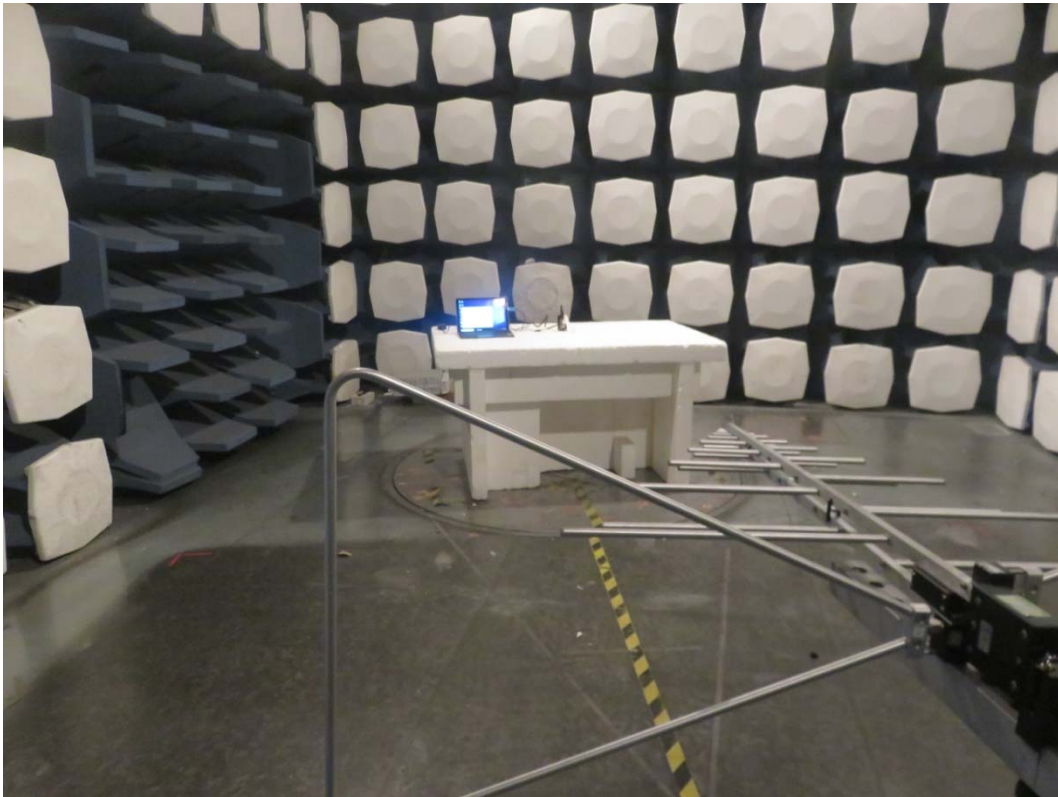

Picture 2: Radiated Spurious Emissions Test setup