



RF TEST REPORT

Applicant Micron Electronics LLC.
FCC ID ZKQ-VZM
Product Tracker
Brand Prime
Model VZM
Report No. R1803A0120-R1V1
Issue Date June 4, 2018

TA Technology (Shanghai) Co., Ltd. tested the above equipment in accordance with the requirements in **FCC CFR47 Part 15C (2017)**. The test results show that the equipment tested is capable of demonstrating compliance with the requirements as documented in this report.

Performed by: Xianqing Li

Approved by: Kai Xu

TA Technology (Shanghai) Co., Ltd.

No.145, Jintang Rd, Tangzhen Industry Park, Pudong Shanghai, China

TEL: +86-021-50791141/2/3

FAX: +86-021-50791141/2/3-8000



TABLE OF CONTENT

1. Test Laboratory	4
1.1. Notes of the test report.....	4
1.2. Test facility	4
1.3. Testing Location.....	5
2. General Description of Equipment under Test.....	6
3. Applied Standards	7
4. Test Configuration	8
5. Test Case Results	9
5.1. Maximum conducted output power	9
5.2. 6dB Bandwidth	11
5.3. Band Edge	15
5.4. Power Spectral Density	17
5.5. Spurious RF Conducted Emissions.....	21
5.6. Radiated Emissions in the Restricted Band	25
5.7. Radiates Emission	30
5.8. Conducted Emission	58
6. Main Test Instruments.....	60
ANNEX A: EUT Appearance and Test Setup	61
A.1 EUT Appearance	61
A.2 Test Setup	62

Summary of measurement results

Number	Summary of measurements of results	Clause in FCC rules	Verdict
1	Maximum conducted output power	15.247(b)(3)	PASS
2	6 dB bandwidth	15.247(a)(2)	PASS
3	Power spectral density	15.247(e)	PASS
4	Band Edge	15.247(d)	PASS
5	Spurious RF Conducted Emissions	15.247(d)	PASS
6	Radiated Emissions in restricted frequency bands	15.247(d),15.205,15.209	PASS
7	Radiated Emissions	15.247(d),15.205,15.209	PASS
8	Conducted Emissions	15.207	PASS
Date of Testing: March 29, 2018 ~ May 8, 2018			

1. Test Laboratory

1.1. Notes of the test report

This report shall not be reproduced in full or partial, without the written approval of **TA technology (shanghai) co., Ltd.** The results documented in this report apply only to the tested sample, under the conditions and modes of operation as described herein .Measurement Uncertainties were not taken into account and are published for informational purposes only. This report is written to support regulatory compliance of the applicable standards stated above.

1.2. Test facility

CNAS (accreditation number: L2264)

TA Technology (Shanghai) Co., Ltd. has obtained the accreditation of China National Accreditation Service for Conformity Assessment (CNAS).

FCC (Designation number: CN1179, Test Firm Registration Number: 446626)

TA Technology (Shanghai) Co., Ltd. has been listed on the US Federal Communications Commission list of test facilities recognized to perform electromagnetic emissions measurements.

IC (recognition number is 8510A)

TA Technology (Shanghai) Co., Ltd. has been listed by industry Canada to perform electromagnetic emission measurement.

VCCI (recognition number is C-4595, T-2154, R-4113, G-10766)

TA Technology (Shanghai) Co., Ltd. has been listed by industry Japan to perform electromagnetic emission measurement.

A2LA (Certificate Number: 3857.01)

TA Technology (Shanghai) Co., Ltd. has been listed by American Association for Laboratory Accreditation to perform electromagnetic emission measurement.



1.3. Testing Location

Company: TA Technology (Shanghai) Co., Ltd.
Address: No.145, Jintang Rd, Tangzhen Industry Park, Pudong
City: Shanghai
Post code: 201201
Country: P. R. China
Contact: Xu Kai
Telephone: +86-021-50791141/2/3
Fax: +86-021-50791141/2/3-8000
Website: <http://www.ta-shanghai.com>
E-mail: xukai@ta-shanghai.com

2. General Description of Equipment under Test

Client Information

Applicant	Micron Electronics LLC.
Applicant address	1001 Yamato Road, Suite 400, Boca Raton, FL 33431, USA
Manufacturer	Micron Electronics LLC.
Manufacturer address	1001 Yamato Road, Suite 400, Boca Raton, FL 33431, USA

General information

EUT Description	
Model	VZM
IMEI	8669080030002312
Hardware Version	F302_V1
Software Version	F302V01.01B01
Power Supply	Non-rechargeable Battery
Antenna Type	monopole Antenna
Antenna Connector	A permanently attached antenna (meet with the standard FCC Part 15.203 requirement)
Antenna Gain	-3.00 dBi
additional beamforming gain	0 dB
Test Mode	802.11b 802.11g, 802.11n(HT20/HT40);
Modulation Type	802.11b: DSSS; 802.11g/n(HT20/HT40): OFDM
Max. Conducted Power	Wi-Fi 2.4G :15.95dBm
Operating Frequency Range(s)	802.11b/g/n(HT20): 2412 ~ 2462 MHz 802.11n(HT40): 2422 ~ 2452 MHz
EUT Accessory	
Non-rechargeable Battery	Manufacturer: EVE Energy Co., Ltd Model: ER14505-2+SPC1550/W
Note: The information of the EUT is declared by the manufacturer.	



3. Applied Standards

According to the specifications of the manufacturer, it must comply with the requirements of the following standards:

Test standards

- **FCC CFR47 Part 15C (2017) Radio Frequency Devices**
- **ANSI C63.10 (2013)**
- **KDB 558074 D01 DTS Meas Guidance v04**

4. Test Configuration

Test Mode

The EUT was programmed to be in continuously transmitting mode and the transmit duty cycle is 100%.

The EUT has been associated with peripherals and configuration operated in a manner tended to maximize its emission characteristics in a typical application.

The radiated emission was measured in the following position: EUT stand-up position (Z axis), lie-down position (X, Y axis). The worst emission was found in lie-down position (X axis) and the worst case was recorded.

In order to find the worst case condition, Pre-tests are needed at the presence of different data rate. Preliminary tests have been done on all the configuration for confirming worst case. Data rate below means worst-case rate of each test item.

Worst-case data rates are shown as following table.

Band	Data Rate
802.11b	1 Mbps
802.11g	6 Mbps
802.11n HT20	MCS0
802.11n HT40	MCS0

5. Test Case Results

5.1. Maximum conducted output power

Ambient condition

Temperature	Relative humidity	Pressure
23°C ~25°C	45%~50%	101.5kPa

Methods of Measurement

During the process of the testing, The EUT was connected to Average Power meter with a known loss. The EUT is max power transmission with proper modulation. The signal transmission is continuous.

Test Setup

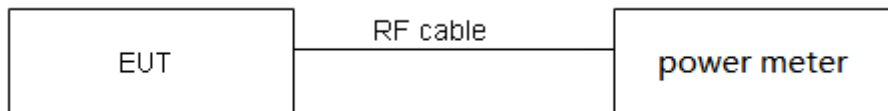

Limits

Rule Part 15.247 (b) (3) specifies that " For systems using digital modulation in the 902–928 MHz, 2400–2483.5 MHz: 1 Watt."

Average Output Power	≤ 1W (30dBm)
----------------------	--------------

Measurement Uncertainty

The assessed measurement uncertainty to ensure 95% confidence level for the normal distribution is with the coverage factor $k = 2$, $U = 0.44$ dB.

Test Results

Single Antenna Power Index			
Packet Type	CH1	CH6	CH11
802.11b	38	38	38
802.11g	36	36	36
802.11n HT20	32	32	32
Packet Type	CH3	CH6	CH9
802.11n HT40	32	32	32

Network Standards	T _{on} (ms)	T _(on+off) (ms)	Duty cycle (%)	Duty cycle correction Factor (dB)
802.11b	2.00	2.00	100%	NA
802.11g	2.00	2.00	100%	NA
802.11n HT20	2.00	2.00	100%	NA
802.11n HT40	2.00	2.00	100%	NA

Network Standards	Carrier frequency (MHz)	Average Power Measured (dBm)	Average Power with duty factor (dBm)	Limit (dBm)	Conclusion
802.11b	2412	13.12	13.12	30	PASS
	2437	15.04	15.04	30	PASS
	2462	15.95	15.95	30	PASS
802.11g	2412	11.61	11.61	30	PASS
	2437	13.68	13.68	30	PASS
	2462	14.78	14.78	30	PASS
802.11n HT20	2412	10.05	10.05	30	PASS
	2437	11.93	11.93	30	PASS
	2462	12.97	12.97	30	PASS
802.11n HT40	2422	10.70	10.70	30	PASS
	2437	11.49	11.49	30	PASS
	2452	12.29	12.29	30	PASS

Note: Average Power with duty factor = Average Power Measured +Duty cycle correction factor

5.2. 6dB Bandwidth

Ambient condition

Temperature	Relative humidity	Pressure
23°C ~25°C	45%~50%	101.5kPa

Method of Measurement

The EUT was connected to the spectrum analyzer through an external attenuator (20dB) and a known loss cable. RBW is set to 100 kHz; VBW is set to 300 kHz on spectrum analyzer. Dector=Peak, Trace mode=max hold.

Test Setup

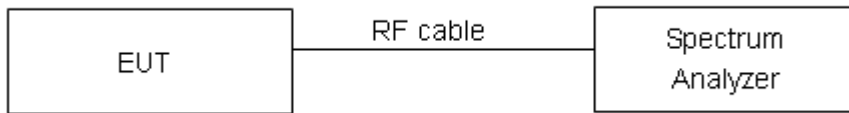

Limits

Rule Part 15.247 (a) (2) specifies that “Systems using digital modulation techniques may operate in the 902–928 MHz, 2400–2483.5 MHz bands. The minimum 6 dB bandwidth shall be at least 500 kHz.”

minimum 6 dB bandwidth	≥ 500 kHz
------------------------	-----------

Measurement Uncertainty

The assessed measurement uncertainty to ensure 95% confidence level for the normal distribution is with the coverage factor $k = 2$, $U = 936$ Hz.

**Test Results:**

Network Standards	Carrier frequency (MHz)	99% bandwidth (MHz)	Minimum 6 dB bandwidth (MHz)	Limit (kHz)	Conclusion
802.11b	2412	11.983	9.135	500	PASS
	2437	12.018	9.136	500	PASS
	2462	12.090	9.138	500	PASS
802.11g	2412	16.585	16.62	500	PASS
	2437	16.585	16.62	500	PASS
	2462	16.599	16.61	500	PASS
802.11n HT20	2412	17.705	17.84	500	PASS
	2437	17.701	17.85	500	PASS
	2462	17.701	17.85	500	PASS
802.11n HT40	2422	36.121	36.52	500	PASS
	2437	36.105	36.51	500	PASS
	2452	36.106	36.54	500	PASS



802.11b, Carrier frequency (MHz): 2412



802.11g, Carrier frequency (MHz): 2412

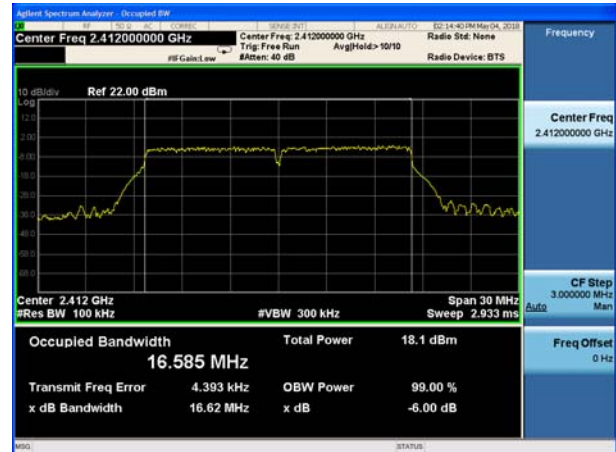

802.11b, Carrier frequency (MHz): 2437



802.11g, Carrier frequency (MHz): 2437

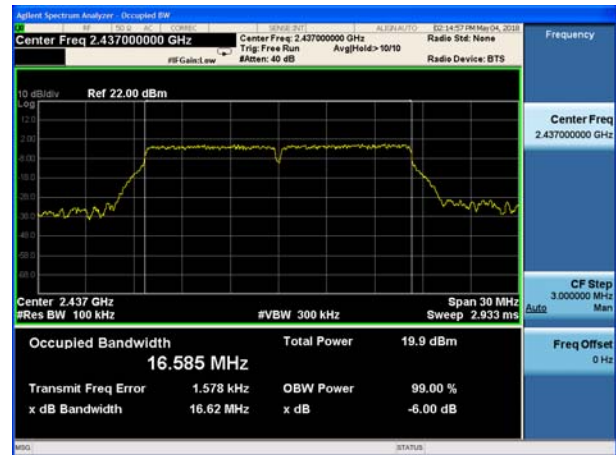

802.11b, Carrier frequency (MHz): 2462



802.11g, Carrier frequency (MHz): 2462

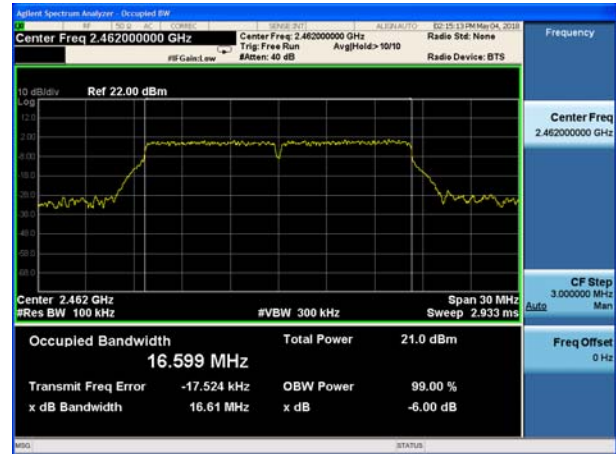



802.11n(HT20), Carrier frequency (MHz): 2412



802.11n(HT40), Carrier frequency (MHz): 2422

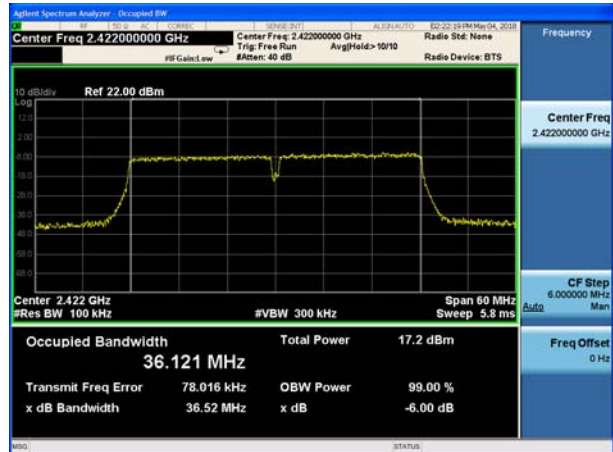

802.11n(HT20), Carrier frequency (MHz): 2437

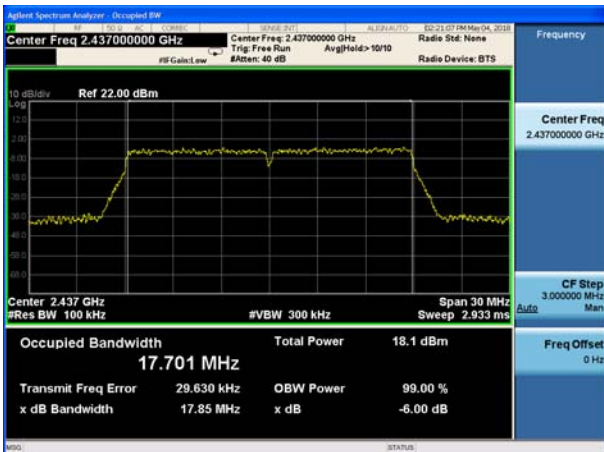

802.11n(HT40), Carrier frequency (MHz): 2437

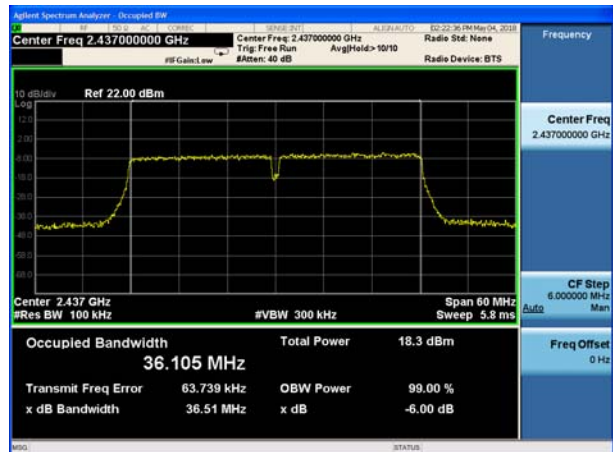

802.11n(HT20), Carrier frequency (MHz):2462

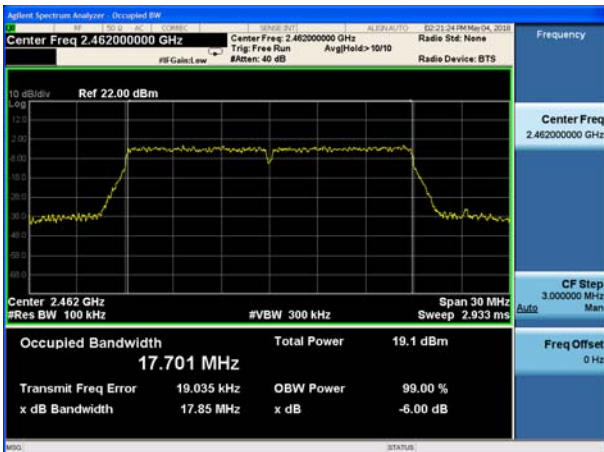

802.11n(HT40), Carrier frequency (MHz):2452

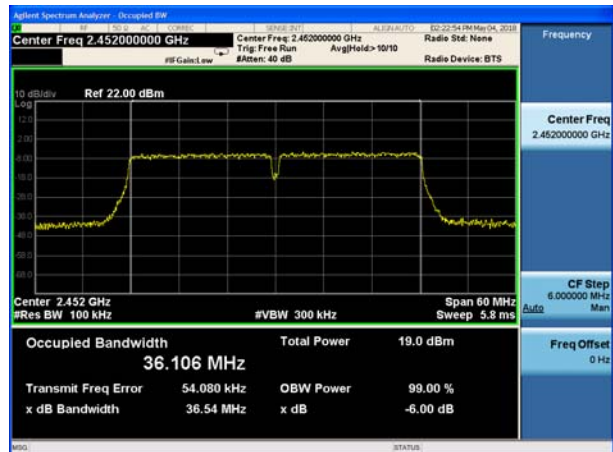

5.3. Band Edge

Ambient condition

Temperature	Relative humidity	Pressure
23°C ~25°C	45%~50%	101.5kPa

Method of Measurement

The EUT was connected to the spectrum analyzer through an external attenuator (20dB) and a known loss cable the band edge of the lowest and highest channels were measured. The peak detector is used and RBW is set to 100 kHz and VBW is set to 300 kHz on spectrum analyzer. Spectrum analyzer plots are included on the following pages.

Test Setup

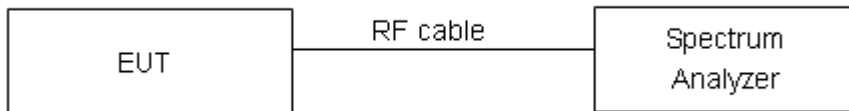

Limits

Rule Part 15.247(d) specifies that “In any 100 kHz bandwidth outside the frequency band in which the spread spectrum or digitally modulated intentional radiator is operating, the radio frequency power that is produced by the intentional radiator shall be at least 20 dB below that in the 100 kHz bandwidth within the band that contains the highest level of the desired power, based on either an RF conducted or a radiated measurement, provided the transmitter demonstrates compliance with the peak conducted power limits.” If the transmitter complies with the conducted power limits based on the use of RMS averaging over a time interval, as permitted under paragraph (b)(3) of this section, the attenuation required under this paragraph shall be 30 dB instead of 20 dB.”

Measurement Uncertainty

The assessed measurement uncertainty to ensure 95% confidence level for the normal distribution is with the coverage factor $k = 1.96$.

Frequency	Uncertainty
2GHz-3GHz	1.407 dB



Test Results: PASS

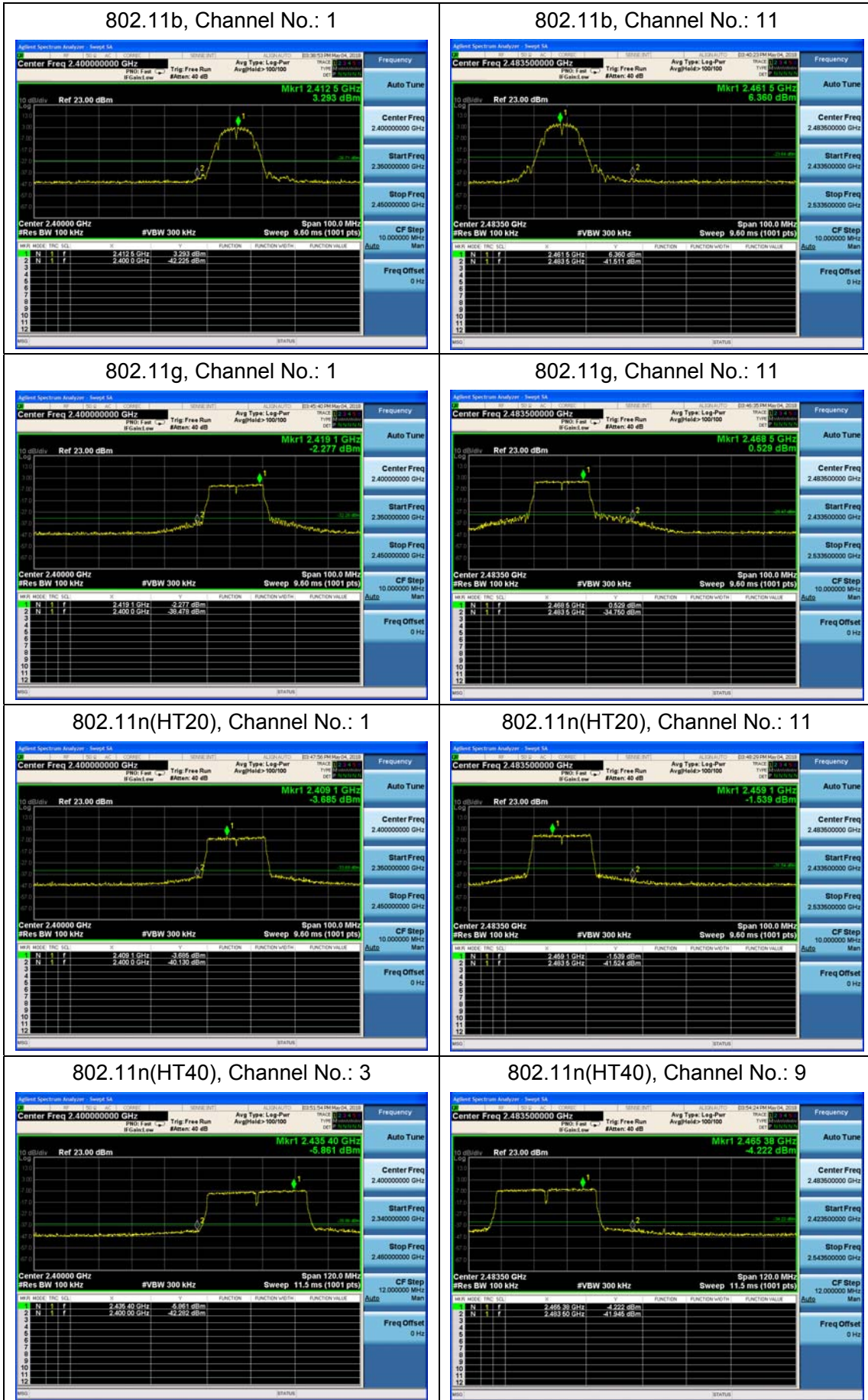

5.4. Power Spectral Density

Ambient condition

Temperature	Relative humidity	Pressure
23°C ~25°C	45%~50%	101.5kPa

Method of Measurement

During the process of the testing, The EUT was connected to Spectrum Analyzer with a known loss. The EUT is max power transmission with proper modulation. Method AVGPSD-2 in KDB558074 D01 was used for this test.

Test setup

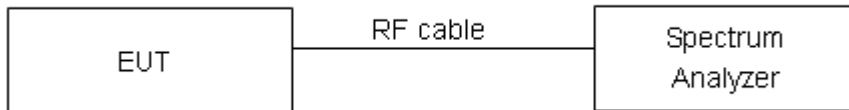

Limits

Rule Part 15.247(e) specifies that” For digitally modulated systems, the power spectral density conducted from the intentional radiator to the antenna shall not be greater than 8 dBm in any 3 kHz band during any time interval of continuous transmission. ”

Limits	≤ 8 dBm / 3kHz
--------	----------------

Measurement Uncertainty

The assessed measurement uncertainty to ensure 95% confidence level for the normal distribution is with the coverage factor $k = 2$, $U = 0.75\text{dB}$.

**Test Results:**

Network Standards	Channel Number	Read Value (dBm / 3kHz)	Power Spectral Density (dBm / 3kHz)	Limit (dBm / 3kHz)	Conclusion
802.11b	1	-19.52	-19.52	8	PASS
	6	-18.08	-18.08	8	PASS
	11	-16.85	-16.85	8	PASS
802.11g	1	-22.68	-22.68	8	PASS
	6	-20.83	-20.83	8	PASS
	11	-19.98	-19.98	8	PASS
802.11n HT20	1	-24.69	-24.69	8	PASS
	6	-23.21	-23.21	8	PASS
	11	-22.38	-22.38	8	PASS
802.11n HT40	3	-27.06	-27.06	8	PASS
	6	-26.18	-26.18	8	PASS
	9	-25.68	-25.68	8	PASS

Note: Power Spectral Density =Read Value+Duty cycle correction factor

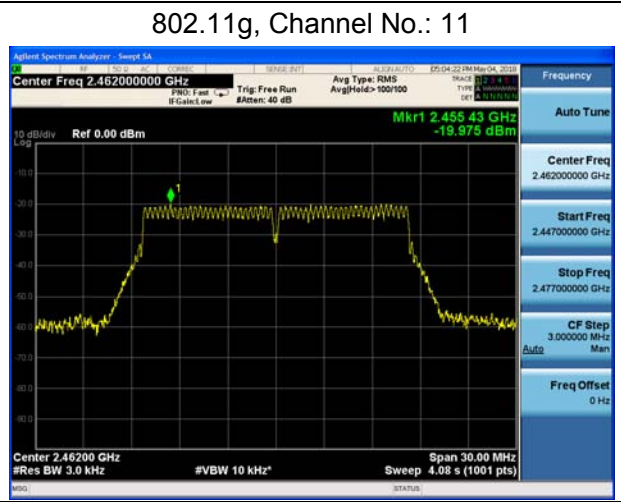
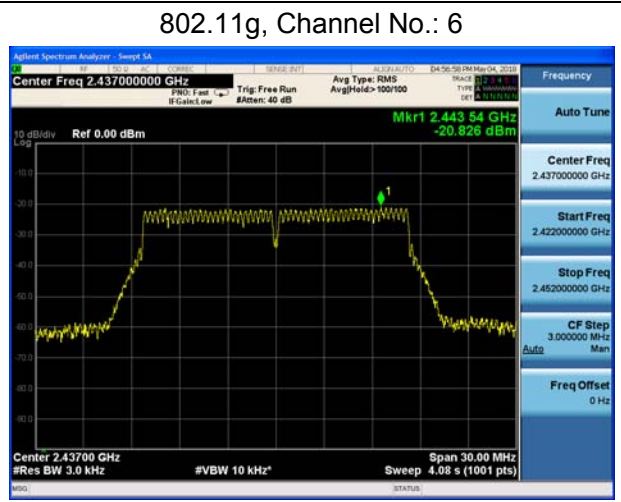
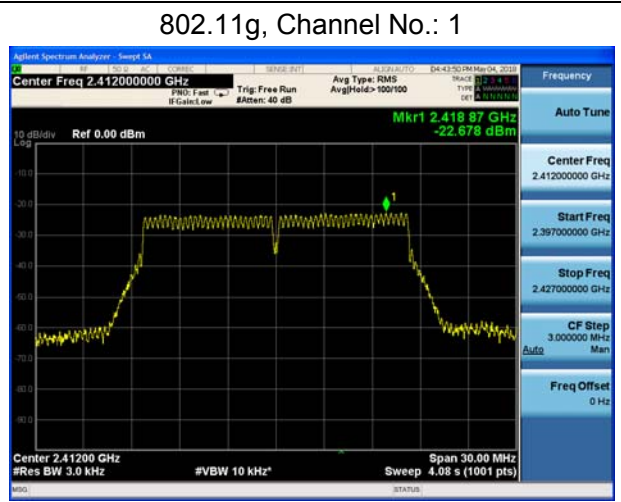



802.11n(HT20), Channel No. 1

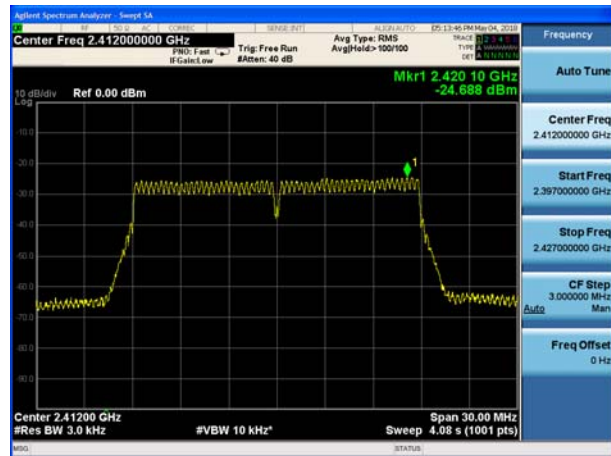

802.11n(HT40), Channel No. 3

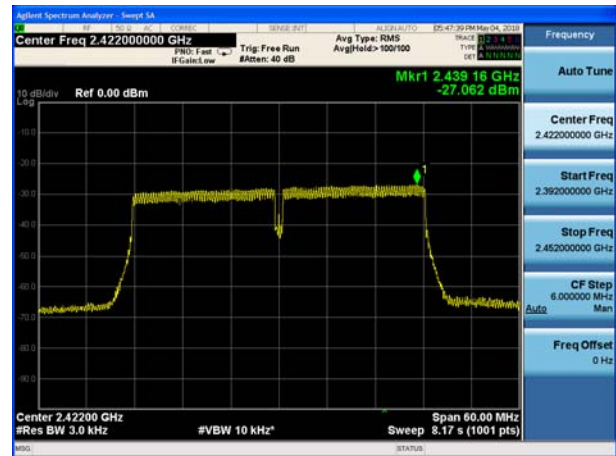

802.11n(HT20), Channel No. 6

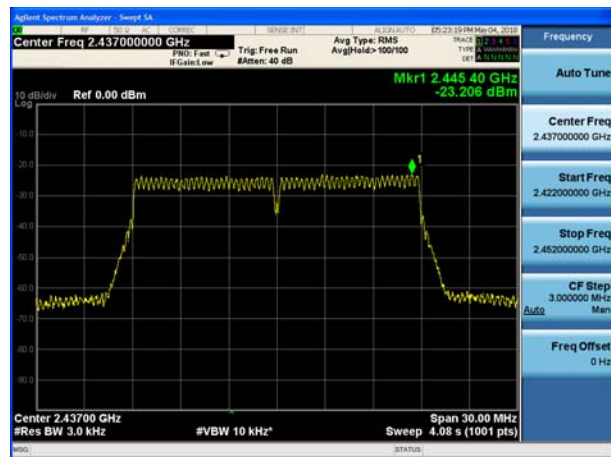

802.11n(HT40), Channel No. 6

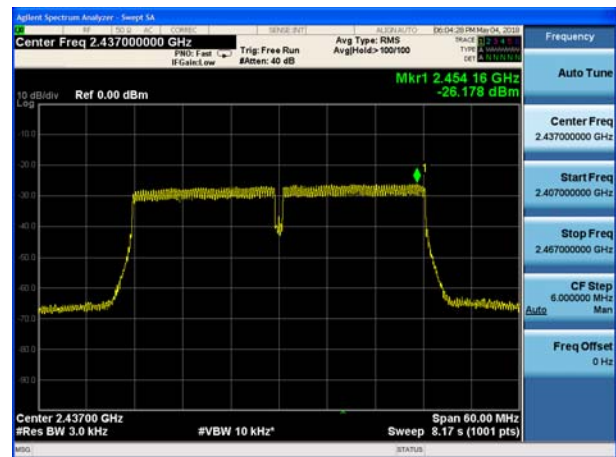

802.11n(HT20), Channel No. 11

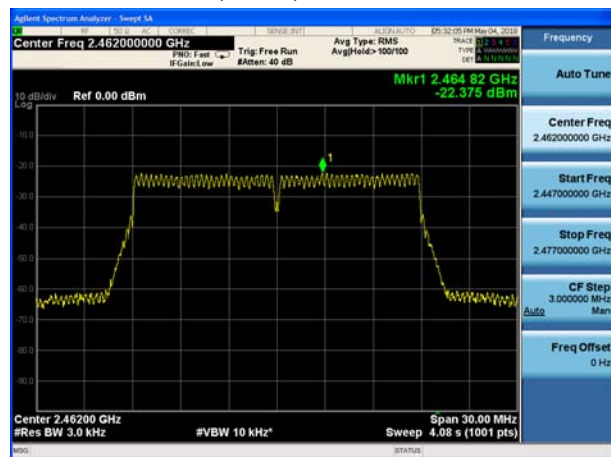

802.11n(HT40), Channel No. 9

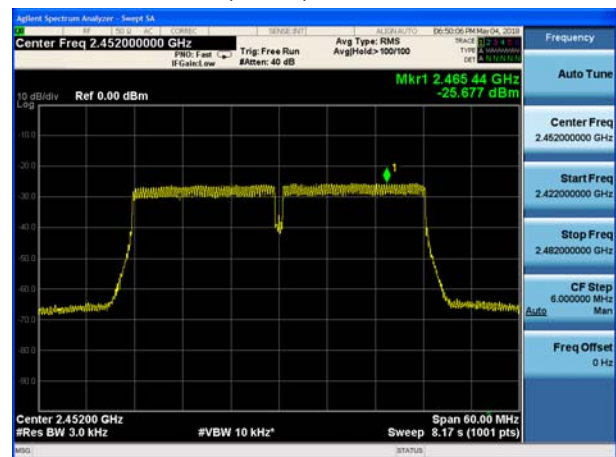

5.5. Spurious RF Conducted Emissions

Ambient condition

Temperature	Relative humidity	Pressure
23°C ~25°C	45%~50%	101.5kPa

Method of Measurement

The EUT was connected to the spectrum analyzer with a known loss. The spectrum analyzer scans from 30MHz to the 10th harmonic of the carrier. The peak detector is used. Set RBW to100kHz and VBW to 300 kHz, Sweep is set to ATUO.

The test is in transmitting mode.

Test setup



Limits

Rule Part 15.247(d) pacifies that “In any 100 kHz bandwidth outside the frequency band in which the spread spectrum intentional radiator is operating, the radio frequency power that is produced by the intentional radiator shall be at least 30 dB below that in the 100 kHz bandwidth within the band that contains the highest level of the desired power.” If the transmitter complies with the conducted power limits based on the use of RMS averaging over a time interval, as permitted under paragraph (b)(3) of this section, the attenuation required under this paragraph shall be 30 dB instead of 20 dB.”

Network Standards	Carrier frequency (MHz)	Reference value (dBm)	Limit
802.11b	2412	3.21	-26.79
	2437	4.80	-25.20
	2462	5.87	-24.13
802.11g	2412	-2.80	-32.80
	2437	-1.38	-31.38
	2462	-0.14	-30.14
802.11n HT20	2412	-4.35	-34.35
	2437	-3.00	-33.00
	2462	-1.87	-31.87
802.11n HT40	2422	-6.53	-36.53
	2437	-6.14	-36.14
	2452	-5.19	-35.19

**Measurement Uncertainty**

The assessed measurement uncertainty to ensure 95% confidence level for the normal distribution is with the coverage factor $k = 1.96$.

Frequency	Uncertainty
100kHz-2GHz	0.684 dB
2GHz-26GHz	1.407 dB



Test Results:

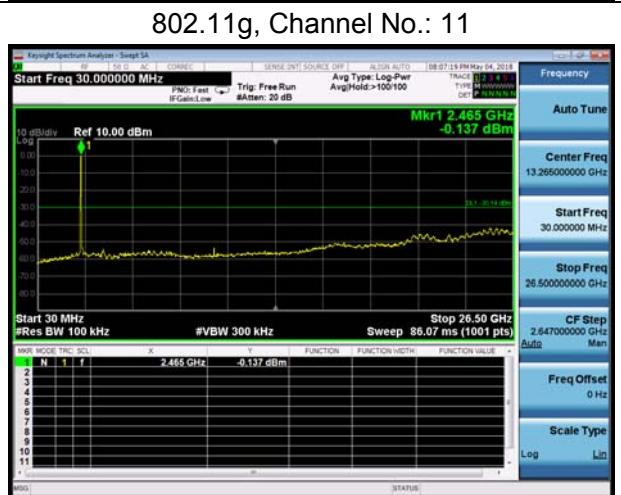
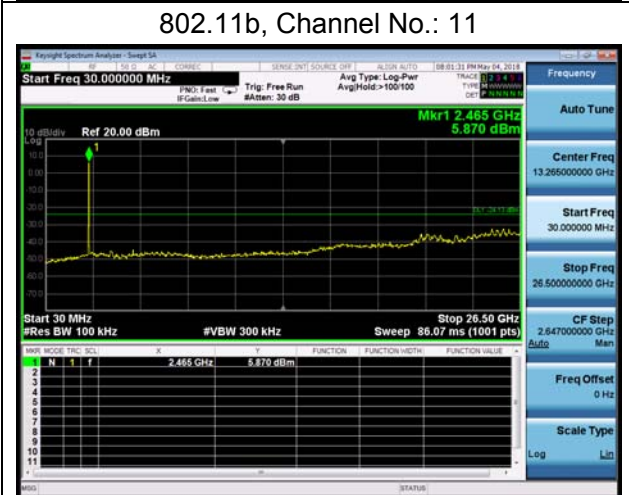
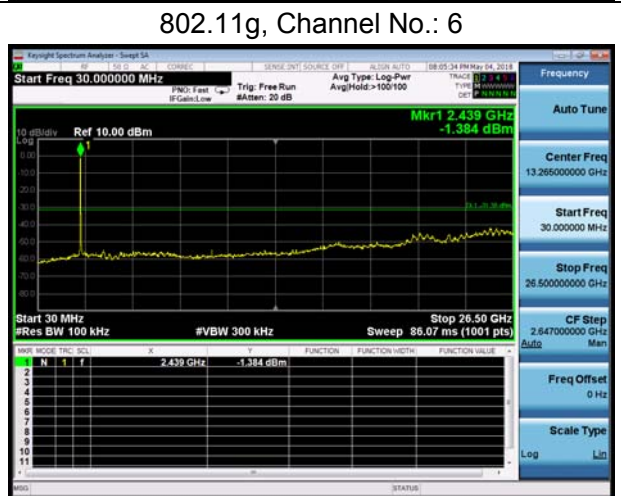
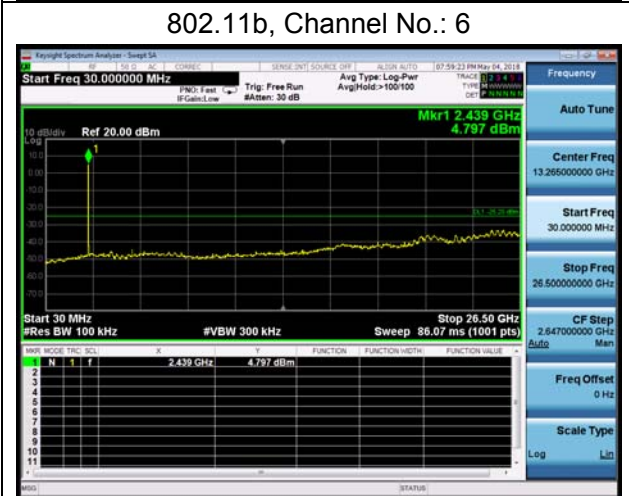
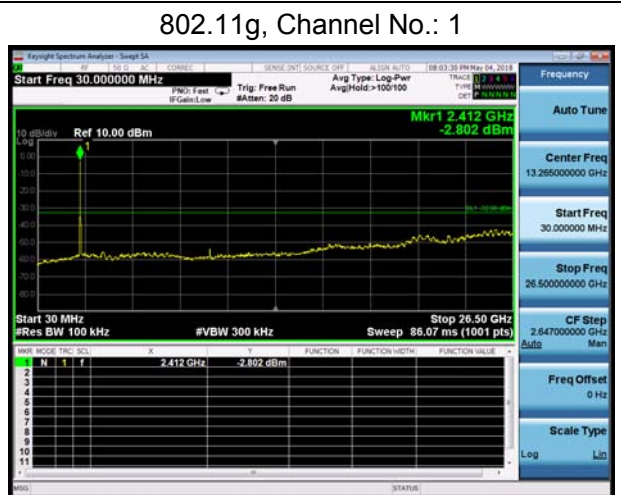
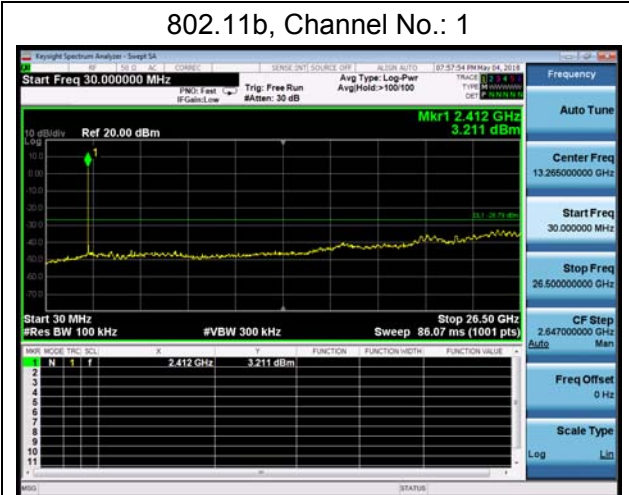



802.11n(HT20), Channel No. 1

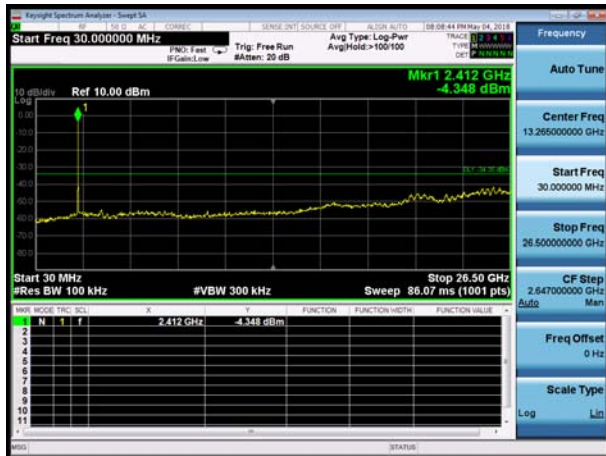

802.11n(HT40), Channel No. 3



802.11n(HT20), Channel No. 6

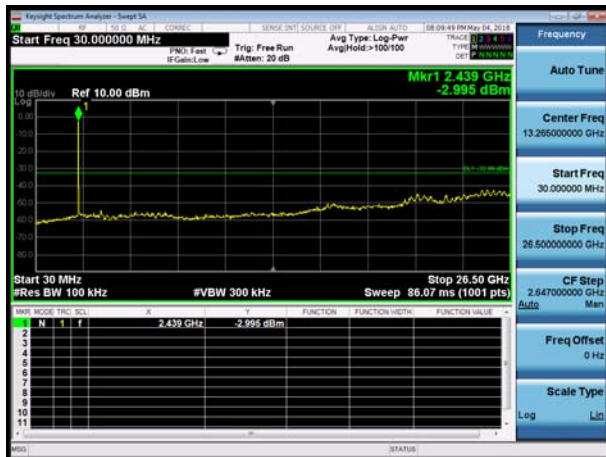

802.11n(HT40), Channel No. 6

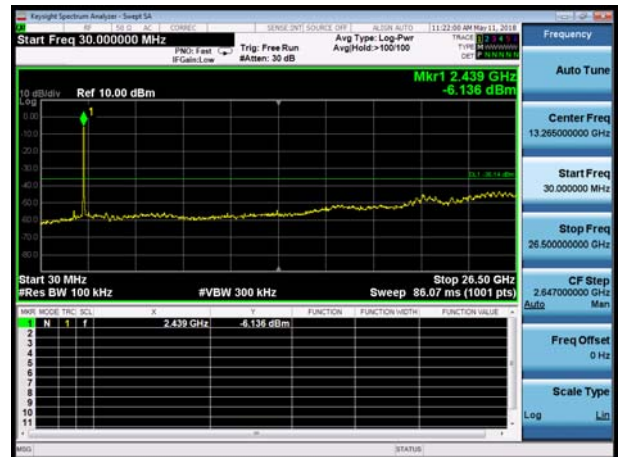

802.11n(HT20), Channel No. 11

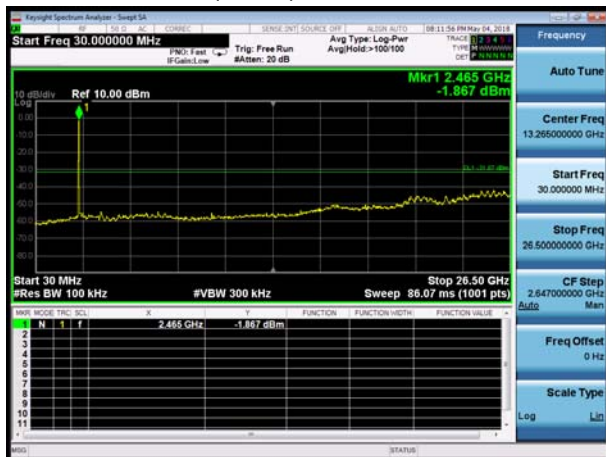

802.11n(HT40), Channel No. 9

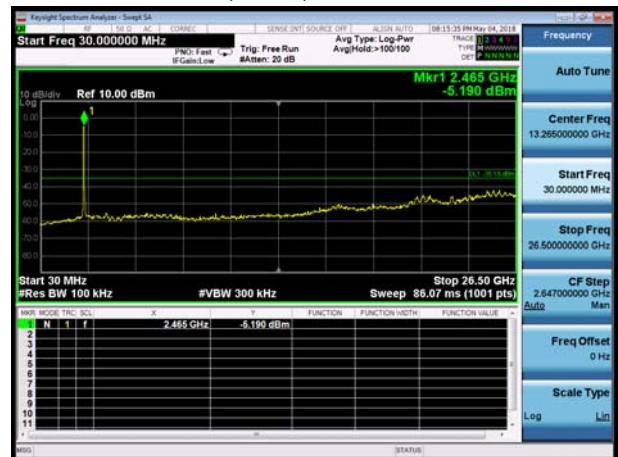

5.6. Radiated Emissions in the Restricted Band

Ambient condition

Temperature	Relative humidity	Pressure
23°C ~25°C	45%~50%	101.5kPa

Method of Measurement

The Equipment Under Test (EUT) was set up on a non-conductive table in the semi-anechoic chamber. The test was performed at the distance of 3 m between the EUT and the receiving antenna. The turntable shall be rotated from 0 to 360 degrees for detecting the maximum of radiated spurious signal level. The measurements shall be repeated with orthogonal polarization of the test antenna. The data of cable loss and antenna factor has been calibrated in full testing frequency range before the testing. Sweep the Restricted Band and the emissions less than 20 dB below the permissible value are reported.

This method refer to KDB 558074.

The procedure for peak unwanted emissions measurements above 1000 MHz is as follows:

I) Peak emission levels are measured by setting the instrument as follows:

- 1) RBW = 1 MHz.
- 2) VBW \geq [3 × RBW]
- 3) Detector = peak.
- 4) Sweep time = auto.
- 5) Trace mode = max hold.
- 6) Allow sweeps to continue until the trace stabilizes. Note that if the transmission is not continuous, then the time required for the trace to stabilize will increase by a factor of approximately 1 / D, where D is the duty cycle.

II) Average emission levels are measured by setting the instrument as follows:

- a) RBW = 1 MHz.
- b) VBW \geq [3 × RBW].
- c) Detector = RMS (power averaging), if [span / (# of points in sweep)] \leq RBW / 2. Satisfying this condition can require increasing the number of points in the sweep or reducing the span. If the condition is not satisfied, then the detector mode shall be set to peak.
- d) Averaging type = power (i.e., rms) (As an alternative, the detector and averaging type may be set for linear voltage averaging. Some instruments require linear display mode to use linear voltage averaging. Log or dB averaging shall not be used.)
- e) Sweep time = auto.
- f) Perform a trace average of at least 100 traces if the transmission is continuous. If the transmission is not continuous, then the number of traces shall be increased by a factor of 1 / D, where D is the duty cycle. For example, with 50% duty cycle, at least 200 traces shall be averaged. (If a specific emission is demonstrated to be continuous—i.e., 100% duty cycle—then rather than turning ON and OFF with the transmit cycle, at least 100 traces shall be averaged.)
- g) If tests are performed with the EUT transmitting at a duty cycle less than 98%, then a correction

factor shall be added to the measurement results prior to comparing with the emission limit, to compute the emission level that would have been measured had the test been performed at 100% duty cycle. The correction factor is computed as follows:

- 1) If power averaging (rms) mode was used in the preceding step e), then the correction factor is $[10 \log (1 / D)]$, where D is the duty cycle. For example, if the transmit duty cycle was 50%, then 3 dB shall be added to the measured emission levels.
- 2) If linear voltage averaging mode was used in the preceding step e), then the correction factor is $[20 \log (1 / D)]$, where D is the duty cycle. For example, if the transmit duty cycle was 50%, then 6 dB shall be added to the measured emission levels.
- 3) If a specific emission is demonstrated to be continuous (100% duty cycle) rather than turning ON and OFF with the transmit cycle, then no duty cycle correction is required for that emission.

The field strength of spurious emission was measured in the following position: EUT stand-up position (Z axis), lie-down position (X, Y axis). The worst emission was found in stand-up position (X axis) and the antenna is vertical.

The test is in transmitting mode.

Test setup

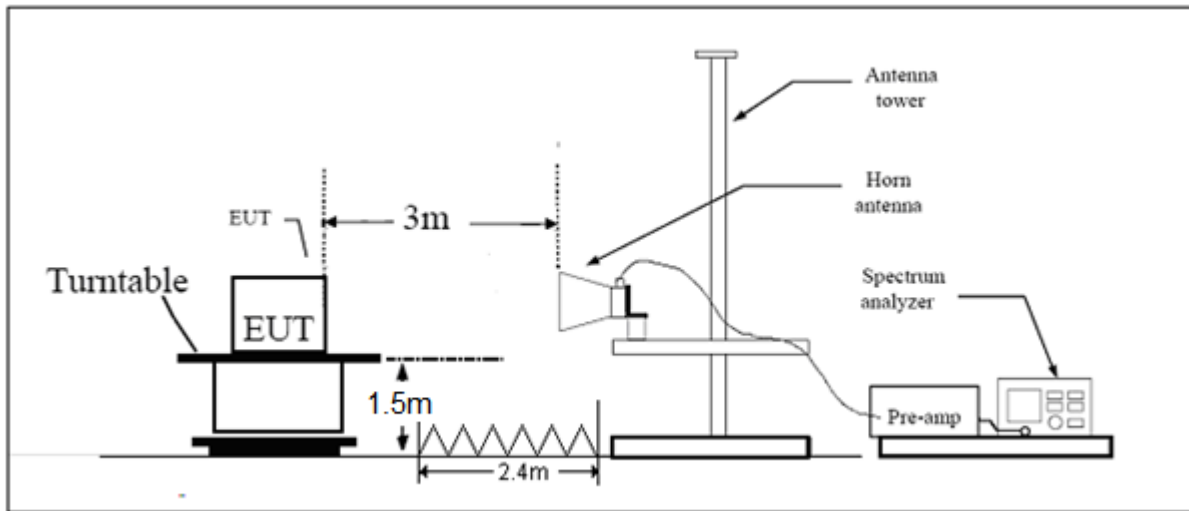

Note: Area side: 2.4mX3.6m

Limits

Spurious Radiated Emissions are permitted in any of the frequency bands listed below:

MHz	MHz	MHz	GHz
0.090 - 0.110	16.42 - 16.423	399.9 - 410	4.5 - 5.15
¹ 0.495 - 0.505	16.69475 - 16.69525	608 - 614	5.35 - 5.46
2.1735 - 2.1905	16.80425 - 16.80475	960 - 1240	7.25 - 7.75
4.125 - 4.128	25.5 - 25.67	1300 - 1427	8.025 - 8.5
4.17725 - 4.17775	37.5 - 38.25	1435 - 1626.5	9.0 - 9.2
4.20725 - 4.20775	73 - 74.6	1645.5 - 1646.5	9.3 - 9.5
6.215 - 6.218	74.8 - 75.2	1660 - 1710	10.6 - 12.7
6.26775 - 6.26825	108 - 121.94	1718.8 - 1722.2	13.25 - 13.4
6.31175 - 6.31225	123 - 138	2200 - 2300	14.47 - 14.5
8.291 - 8.294	149.9 - 150.05	2310 - 2390	15.35 - 16.2
8.362 - 8.366	156.52475 - 156.52525	2483.5 - 2500	17.7 - 21.4
8.37625 - 8.38675	156.7 - 156.9	2690 - 2900	22.01 - 23.12
8.41425 - 8.41475	162.0125 - 167.17	3260 - 3267	23.6 - 24.0
12.29 - 12.293	167.72 - 173.2	3332 - 3339	31.2 - 31.8
12.51975 - 12.52025	240 - 285	3345.8 - 3358	36.43 - 36.5
12.57675 - 12.57725	322 - 335.4	3600 - 4400	(²)
13.36 - 13.41			

Limit in restricted band

Frequency of emission (MHz)	Field strength(uV/m)	Field strength(dBuV/m)
30-88	100	40
88-216	150	43.5
216-960	200	46
Above960	500	54

§15.35(b)

There is also a limit on the radio frequency emissions, as measured using instrumentation with a peak detector function, corresponding to 20 dB above the maximum permitted average limit.

Peak Limit=74 dBuV/m

Average Limit=54 dBuV/m

Measurement Uncertainty

The assessed measurement uncertainty to ensure 95% confidence level for the normal distribution is with the coverage factor $k = 1.96$, $U = 3.55$ dB.

**Test Results:****802.11b-Channel 1**

Frequency (MHz)	Peak (dBuV/m)	Average (dBuV/m)	Height (cm)	Polarization	Azimuth (deg)	Duty cycle correction Factor(dB)	conclusion value (dBuV/m)	Margin (dB)	Limit (dBuV/m)
2390	47.391	--	200.0	V	135	0	47.391	26.609	74
2390	--	36.635	200.0	V	135	0	36.635	17.365	54

802.11b-Channel 11

Frequency (MHz)	Peak (dBuV/m)	Average (dBuV/m)	Height (cm)	Polarization	Azimuth (deg)	Duty cycle correction Factor(dB)	conclusion value (dBuV/m)	Margin (dB)	Limit (dBuV/m)
2483.5	40.990	--	200.0	V	135	0	40.99	33.01	74
2483.5	--	33.012	200.0	V	135	0	33.012	20.988	54

802.11g-Channel 1

Frequency (MHz)	Peak (dBuV/m)	Average (dBuV/m)	Height (cm)	Polarization	Azimuth (deg)	Duty cycle correction Factor(dB)	conclusion value (dBuV/m)	Margin (dB)	Limit (dBuV/m)
2390	55.702	--	150	V	65	0	55.702	18.298	74
2390	--	30.455	150	V	65	0	30.455	23.545	54

802.11g-Channel 11

Frequency (MHz)	Peak (dBuV/m)	Average (dBuV/m)	Height (cm)	Polarization	Azimuth (deg)	Duty cycle correction Factor(dB)	conclusion value (dBuV/m)	Margin (dB)	Limit (dBuV/m)
2483.5	62.482	--	150	V	78	0	62.482	11.518	74
2483.5	--	47.271	150	V	78	0	47.271	6.729	54

**802.11n HT20 -Channel 1**

Frequency (MHz)	Peak (dBuV/m)	Average (dBuV/m)	Height (cm)	Polarization	Azimuth (deg)	Duty cycle correction Factor(dB)	conclusion value (dBuV/m)	Margin (dB)	Limit (dBuV/m)
2390	50.977	--	200	V	90	0	50.977	23.023	74
2390	--	36.954	200	V	90	0	36.954	17.046	54

802.11n HT20-Channel 11

Frequency (MHz)	Peak (dBuV/m)	Average (dBuV/m)	Height (cm)	Polarization	Azimuth (deg)	Duty cycle correction Factor(dB)	conclusion value (dBuV/m)	Margin (dB)	Limit (dBuV/m)
2483.5	55.673	--	200	V	90	0	55.673	18.327	74
2483.5	--	45.386	200	V	90	0	45.386	8.614	54

802.11n HT40 -Channel 3

Frequency (MHz)	Peak (dBuV/m)	Average (dBuV/m)	Height (cm)	Polarization	Azimuth (deg)	Duty cycle correction Factor(dB)	conclusion value (dBuV/m)	Margin (dB)	Limit (dBuV/m)
2390	57.171	--	150	V	46	0	57.171	16.829	74
2390	--	42.186	150	V	46	0	42.186	11.814	54

802.11n HT40-Channel 9

Frequency (MHz)	Peak (dBuV/m)	Average (dBuV/m)	Height (cm)	Polarization	Azimuth (deg)	Duty cycle correction Factor(dB)	conclusion value (dBuV/m)	Margin (dB)	Limit (dBuV/m)
2483.5	56.198	--	150	V	46	0	56.198	17.802	74
2483.5	--	43.792	150	V	46	0	43.792	10.208	54

5.7. Radiates Emission

Ambient condition

Temperature	Relative humidity	Pressure
23°C ~25°C	45%~50%	102.5kPa

Method of Measurement

The test set-up was made in accordance to the general provisions of ANSI C63.10-2013. The Equipment Under Test (EUT) was set up on a non-conductive table in the semi-anechoic chamber. The test was performed at the distance of 3 m between the EUT and the receiving antenna. The radiated emissions measurements were made in a typical installation configuration.

Sweep the whole frequency band through the range from 9 kHz to the 10th harmonic of the carrier, and the emissions less than 20 dB below the permissible value are reported.

During the test, below 30MHz, the center of the loop shall be 1 meters; above 30MHz, the height of receive antenna shall be moved from 1 to 4 meters, and the antenna shall be performed under horizontal and vertical polarization. The turntable shall be rotated from 0 to 360 degrees for detecting the maximum of radiated spurious signal level. The measurements shall be repeated with orthogonal polarization of the test antenna. The data of cable loss and antenna factor has been calibrated in full testing frequency range before the testing.

Set the spectrum analyzer in the following:

Below 1GHz (detector: Peak and Quasi-Peak)

RBW=100 kHz / VBW=300 kHz / Sweep=AUTO

Above 1GHz (detector: Peak):

(a) PEAK: RBW=1MHz / VBW=3MHz/ Sweep=AUTO

(b) AVERAGE: RBW=1MHz / VBW=10Hz, when duty cycle is not less than 98%

VBW \geq 1/T when duty cycle is less than 98%, where T is transmit on time

Sweep=AUTO

The radiated emission was measured in the following position: EUT stand-up position (Z axis), lie-down position (X, Y axis). The worst emission was found in lie-down position (X axis) and the worst case was recorded.

The test is in transmitting mode.

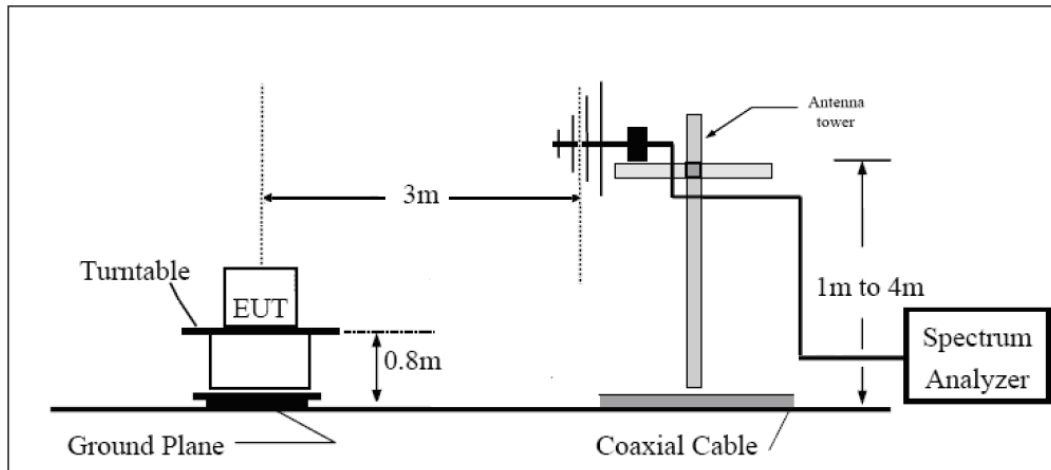
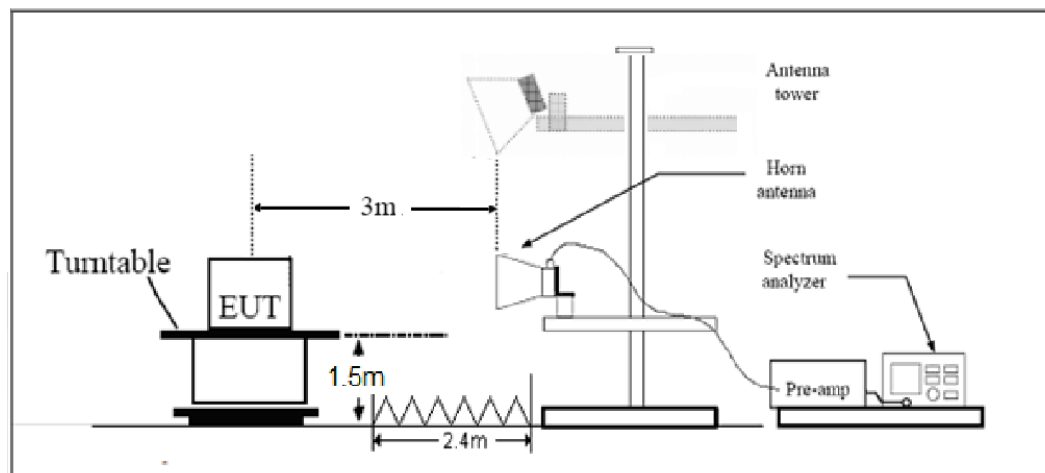
Test setup**30MHz ~ 1GHz****Above 1GHz**

Note: Area side:2.4mX3.6m

Limits

Rule Part 15.247(d) specifies that “In addition, radiated emissions which fall in the restricted bands, as defined in § 15.205(a), must also comply with the radiated emission limits specified in § 15.209(a) (see § 15.205(c)).”

Limit in restricted band

Frequency of emission (MHz)	Field strength(uV/m)	Field strength(dBuV/m)
0.009–0.490	2400/F(kHz)	/
0.490–1.705	24000/F(kHz)	/
1.705–30.0	30	/
30-88	100	40
88-216	150	43.5
216-960	200	46
Above960	500	54

§15.35(b)

There is also a limit on the radio frequency emissions, as measured using instrumentation with a peak detector function, corresponding to 20 dB above the maximum permitted average limit.

Measurement Uncertainty

The assessed measurement uncertainty to ensure 95% confidence level for the normal distribution is with the coverage factor $k = 1.96$.

Frequency	Uncertainty
9KHz-30MHz	3.55 dB
30MHz-200MHz	4.19 dB
200MHz-1GHz	3.63 dB
Above 1GHz	3.68 dB

Test result

Sweep from 9 kHz to 30MHz, 18GHz to 26.5GHz, and the emissions more than 20 dB below the permissible value are not reported.

The following graphs display the maximum values of horizontal and vertical by software.

For above 1GHz, Blue trace uses the peak detection, Green trace uses the average detection.

During the test, the Radiates Emission from 30MHz to 1GHz was performed in all modes with all channels, 802.11n (HT20), Channel 11 are selected as the worst condition. The test data of the worst-case condition was recorded in this report.

Continuous TX mode:

RE 0.03-1GHz QP Class B

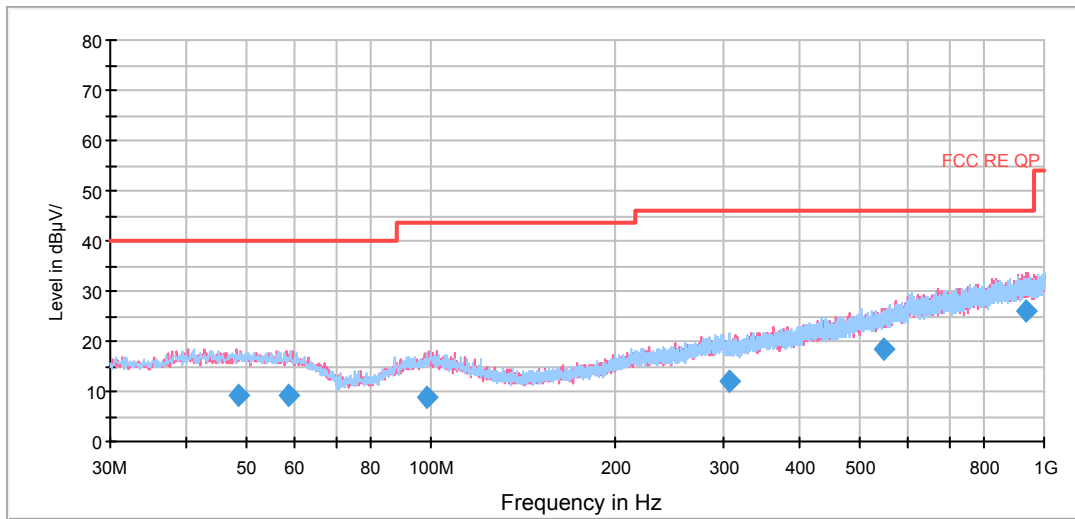

Radiates Emission from 30MHz to 1GHz

Frequency (MHz)	Quasi-Peak (dBuV/m)	Reading value (dBuV/m)	Height (cm)	Polarization	Azimuth (deg)	Correct Factor (dB)	Margin (dB)	Limit (dBuV/m)
48.308750	18.5	5.4	100	V	240.0	13.1	21.5	40.0
58.978750	18.0	5.3	100	H	16.0	12.7	22.0	40.0
98.991250	18.1	4.9	100	V	0.0	13.2	25.4	43.5
307.056250	21.6	6.0	100	H	229.0	15.6	24.4	46.0
546.888750	26.5	5.0	100	V	153.0	21.5	19.5	46.0
935.495000	33.7	6.7	100	V	93.0	27.0	12.3	46.0

- Remark:**
1. Quasi-Peak = Reading value + Correction factor
 2. Correction Factor = Antenna factor+ Insertion loss(cable loss+amplifier gain)
 3. Margin = Limit – Quasi-Peak

802.11b CH1

FCC RE 1G-18GHz PK+AV Class B

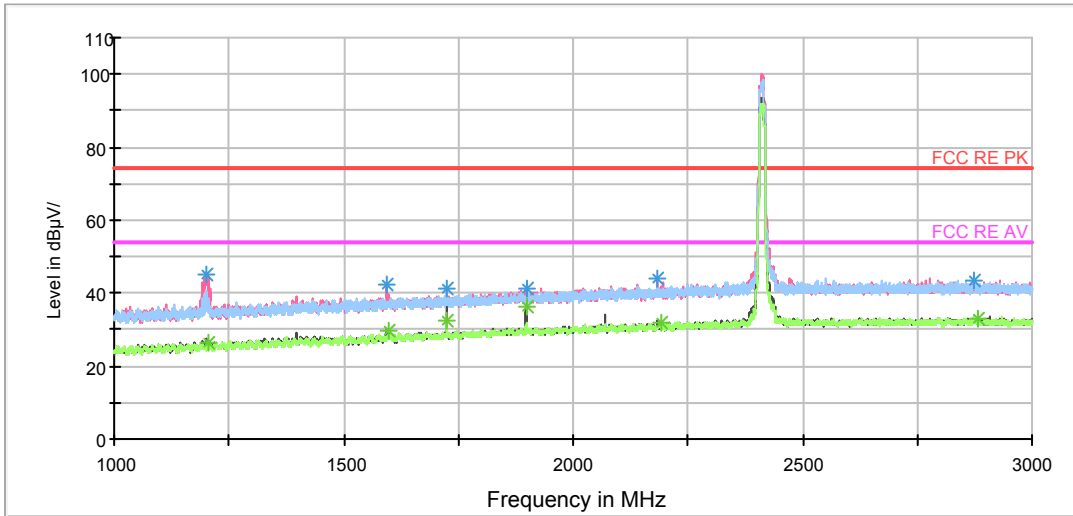

Note: The signal beyond the limit is carrier.
Radiates Emission from 1GHz to 3GHz

FCC RE 1G-18GHz PK+AV Class B

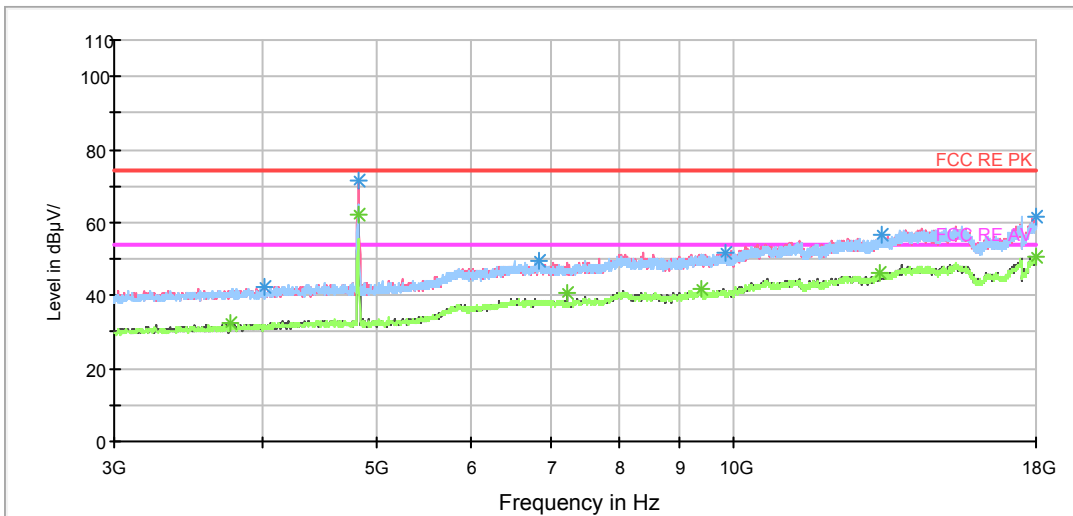

Note: The signal beyond the limit is harmonic.
Radiates Emission from 3GHz to 18GHz



Frequency (MHz)	Peak (dBuV/m)	Height (cm)	Polarization	Azimuth (deg)	Reading value (dBuV/m)	Correct Factor (dB)	Margin (dB)	Limit (dBuV/m)
1199.750000	45.1	100.0	V	158.0	53.3	-8.2	28.9	74
1594.500000	42.5	100.0	V	341.0	48.4	-5.9	31.5	74
1725.000000	41.5	100.0	V	76.0	46.6	-5.1	32.5	74
1897.500000	41.4	100.0	V	50.0	45.5	-4.1	32.6	74
2185.250000	43.8	100.0	V	21.0	46.2	-2.4	30.2	74
2874.750000	43.3	100.0	H	192.0	43.7	-0.4	30.7	74

Remark: 1. Correction Factor = Antenna factor+ Insertion loss (cable loss + amplifier gain)

Frequency (MHz)	Average (dBuV/m)	Height (cm)	Polarization	Azimuth (deg)	Reading value (dBuV/m)	Correct Factor (dB)	Margin (dB)	Limit (dBuV/m)
1206.000000	26.6	100.0	V	0.0	34.7	-8.1	27.4	54
1599.250000	29.5	100.0	V	358.0	35.3	-5.8	24.5	54
1725.000000	32.7	100.0	H	47.0	37.8	-5.1	21.3	54
1897.500000	36.5	100.0	V	50.0	40.6	-4.1	17.5	54
2190.000000	31.9	100.0	H	0.0	34.3	-2.4	22.1	54
2882.000000	32.7	100.0	V	358.0	33.1	-0.4	21.3	54

Remark: 1. Correction Factor = Antenna factor+ Insertion loss (cable loss + amplifier gain)

802.11b CH6

FCC RE 1G-18GHz PK+AV Class B

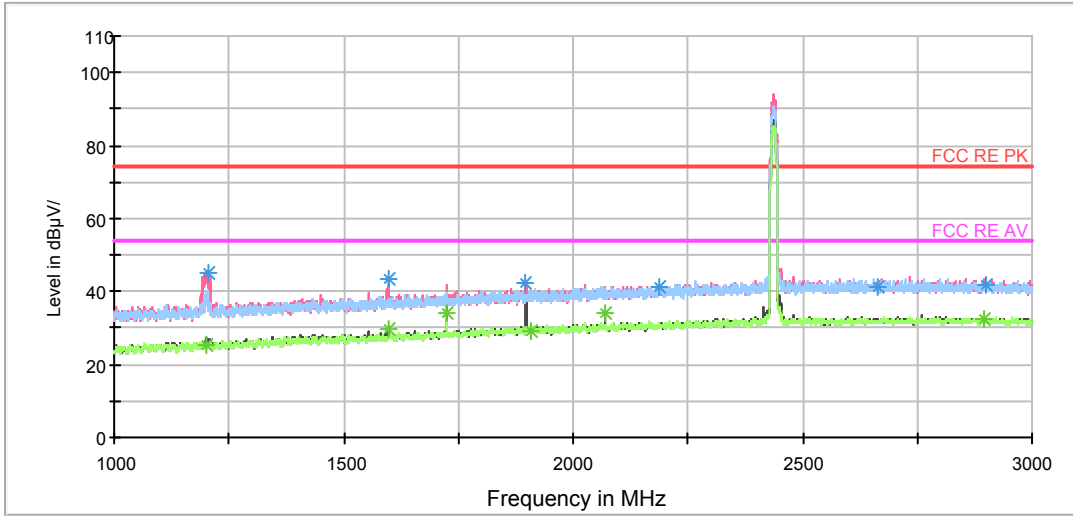

Note: The signal beyond the limit is carrier.
Radiates Emission from 1GHz to 3GHz

FCC RE 1G-18GHz PK+AV Class B

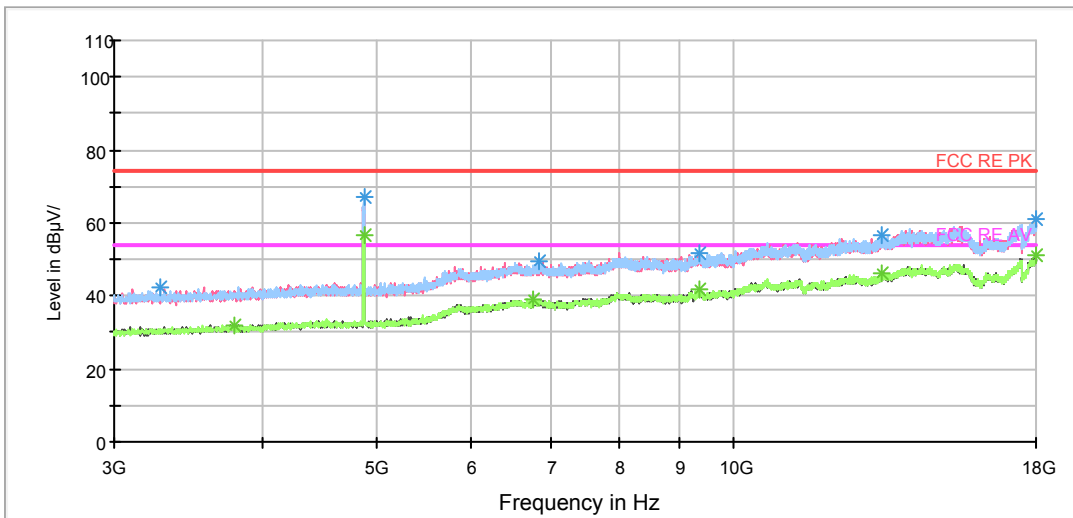

Note: The signal beyond the limit is harmonic.
Radiates Emission from 3GHz to 18GHz



Frequency (MHz)	Peak (dBuV/m)	Height (cm)	Polarization	Azimuth (deg)	Reading value (dBuV/m)	Correct Factor (dB)	Margin (dB)	Limit (dBuV/m)
1204.000000	45.0	100.0	V	222.0	53.1	-8.1	29.0	74
1598.750000	43.4	100.0	V	352.0	49.3	-5.9	30.6	74
1897.250000	42.4	100.0	V	47.0	46.5	-4.1	31.6	74
2186.750000	41.4	100.0	V	8.0	43.8	-2.4	32.6	74
2662.000000	41.4	100.0	H	4.0	42.1	-0.7	32.6	74
2899.750000	41.6	100.0	V	347.0	42.1	-0.5	32.4	74

Remark: 1. Correction Factor = Antenna factor+ Insertion loss (cable loss + amplifier gain)

Frequency (MHz)	Average (dBuV/m)	Height (cm)	Polarization	Azimuth (deg)	Reading value (dBuV/m)	Correct Factor (dB)	Margin (dB)	Limit (dBuV/m)
1202.250000	25.3	100.0	V	151.0	33.5	-8.2	28.7	54
1598.000000	29.7	100.0	V	359.0	35.6	-5.9	24.3	54
1725.500000	34.2	100.0	V	84.0	39.3	-5.1	19.8	54
1908.750000	28.9	100.0	V	95.0	32.9	-4.0	25.1	54
2070.000000	34.3	100.0	V	254.0	37.3	-3.0	19.7	54
2895.000000	32.5	100.0	H	115.0	33.1	-0.6	21.5	54

Remark: 1. Correction Factor = Antenna factor+ Insertion loss (cable loss + amplifier gain)

802.11b CH11

FCC RE 1G-18GHz PK+AV Class B

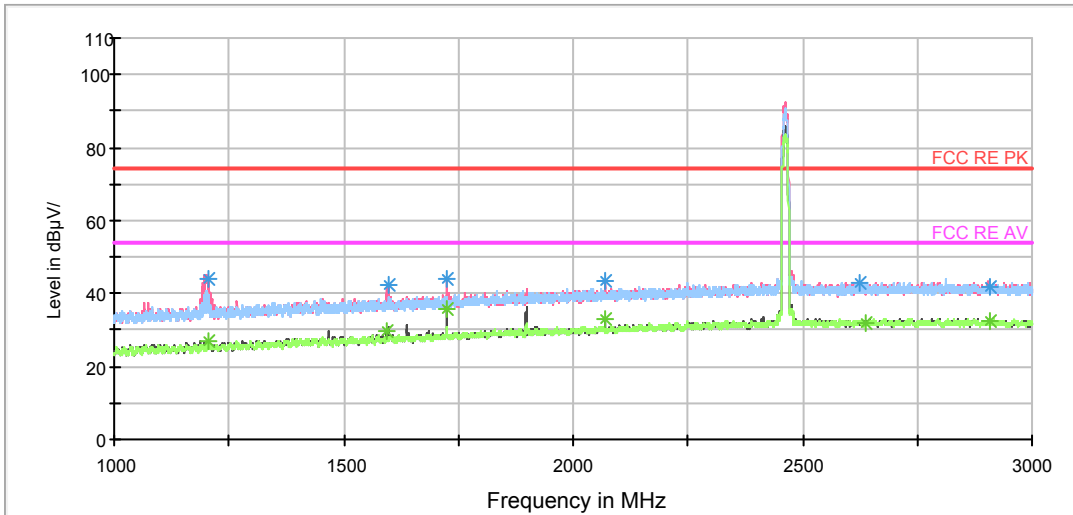

Note: The signal beyond the limit is carrier.
Radiates Emission from 1GHz to 3GHz

FCC RE 1G-18GHz PK+AV Class B

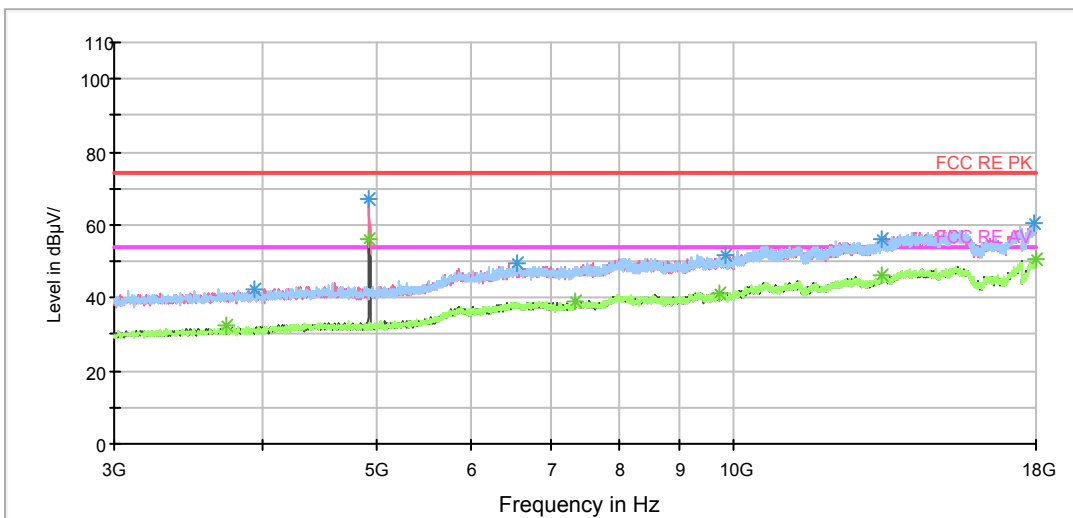

Note: The signal beyond the limit is harmonic.
Radiates Emission from 3GHz to 18GHz



Frequency (MHz)	Peak (dBuV/m)	Height (cm)	Polarization	Azimuth (deg)	Reading value (dBuV/m)	Correct Factor (dB)	Margin (dB)	Limit (dBuV/m)
1205.000000	43.8	100.0	V	0.0	51.9	-8.1	30.2	74
1596.250000	42.1	100.0	V	358.0	48.0	-5.9	31.9	74
1725.000000	43.7	100.0	V	73.0	48.8	-5.1	30.3	74
2069.500000	43.3	100.0	V	61.0	46.3	-3.0	30.7	74
2625.250000	43.0	100.0	H	13.0	43.7	-0.7	31.0	74
2909.500000	41.6	100.0	H	124.0	42.0	-0.4	32.4	74

Remark: 1. Correction Factor = Antenna factor+ Insertion loss (cable loss + amplifier gain)

Frequency (MHz)	Average (dBuV/m)	Height (cm)	Polarization	Azimuth (deg)	Reading value (dBuV/m)	Correct Factor (dB)	Margin (dB)	Limit (dBuV/m)
1203.250000	26.7	100.0	V	0.0	34.8	-8.1	27.3	54
1594.750000	29.7	100.0	V	349.0	35.6	-5.9	24.3	54
1724.500000	35.5	100.0	V	73.0	40.6	-5.1	18.5	54
2069.750000	32.8	100.0	V	61.0	35.8	-3.0	21.2	54
2636.750000	32.2	100.0	V	355.0	32.9	-0.7	21.8	54
2908.000000	32.3	100.0	V	291.0	32.7	-0.4	21.7	54

Remark: 1. Correction Factor = Antenna factor+ Insertion loss (cable loss + amplifier gain)

802.11g CH1

FCC RE 1G-18GHz PK+AV Class B

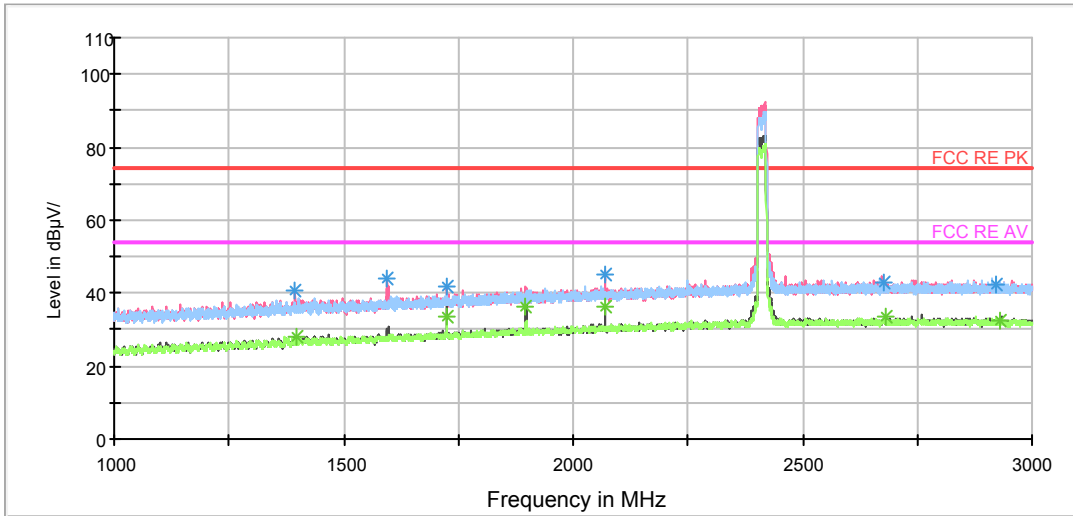

Note: The signal beyond the limit is carrier.
Radiates Emission from 1GHz to 3GHz

FCC RE 1G-18GHz PK+AV Class B

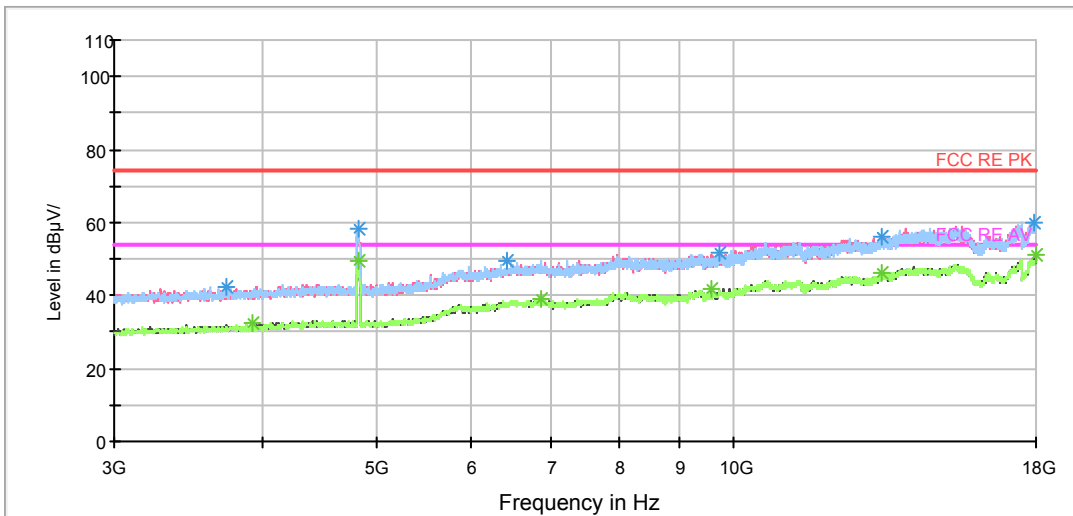

Radiates Emission from 3GHz to 18GHz



Frequency (MHz)	Peak (dBuV/m)	Height (cm)	Polarization	Azimuth (deg)	Reading value (dBuV/m)	Correct Factor (dB)	Margin (dB)	Limit (dBuV/m)
1395.000000	40.8	100.0	V	49.0	47.8	-7.0	33.2	74
1596.000000	43.7	100.0	V	354.0	49.6	-5.9	30.3	74
1724.750000	41.7	100.0	V	75.0	46.8	-5.1	32.3	74
2069.750000	44.9	100.0	V	62.0	47.9	-3.0	29.1	74
2678.000000	42.7	100.0	H	2.0	43.3	-0.6	31.3	74
2920.750000	42.4	100.0	V	146.0	42.7	-0.3	31.6	74

Remark: 1. Correction Factor = Antenna factor+ Insertion loss (cable loss + amplifier gain)

Frequency (MHz)	Average (dBuV/m)	Height (cm)	Polarization	Azimuth (deg)	Reading value (dBuV/m)	Correct Factor (dB)	Margin (dB)	Limit (dBuV/m)
1399.500000	27.8	100.0	V	215.0	34.8	-7.0	26.2	54
1725.500000	33.7	100.0	V	319.0	38.8	-5.1	20.3	54
1897.250000	36.3	100.0	V	62.0	40.4	-4.1	17.7	54
2070.000000	36.4	100.0	V	62.0	39.4	-3.0	17.6	54
2679.250000	33.3	100.0	V	276.0	33.9	-0.6	20.7	54
2931.750000	32.4	100.0	V	336.0	32.8	-0.4	21.6	54

Remark: 1. Correction Factor = Antenna factor+ Insertion loss (cable loss + amplifier gain)

802.11g CH6

FCC RE 1G-18GHz PK+AV Class B

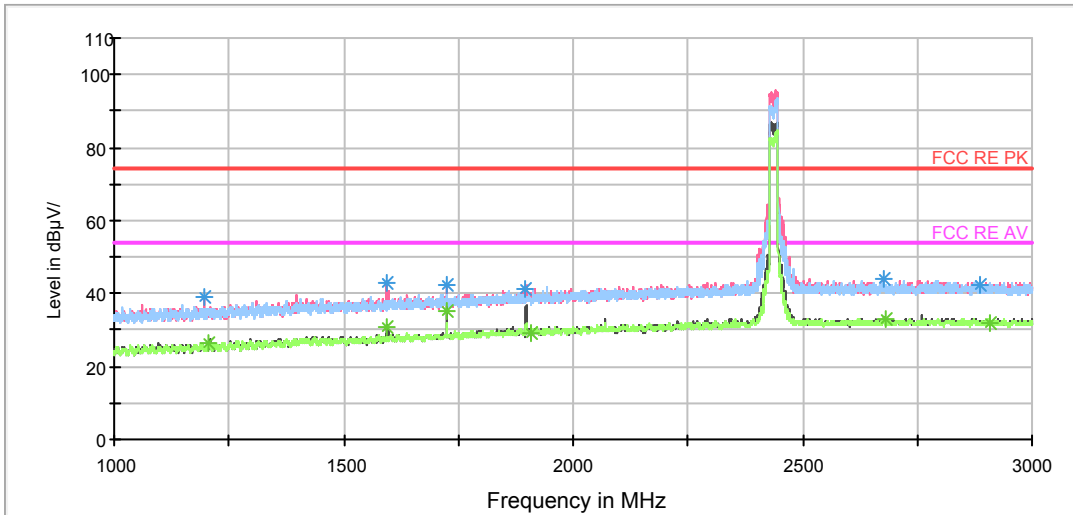

Note: The signal beyond the limit is carrier.
Radiates Emission from 1GHz to 3GHz

FCC RE 1G-18GHz PK+AV Class B

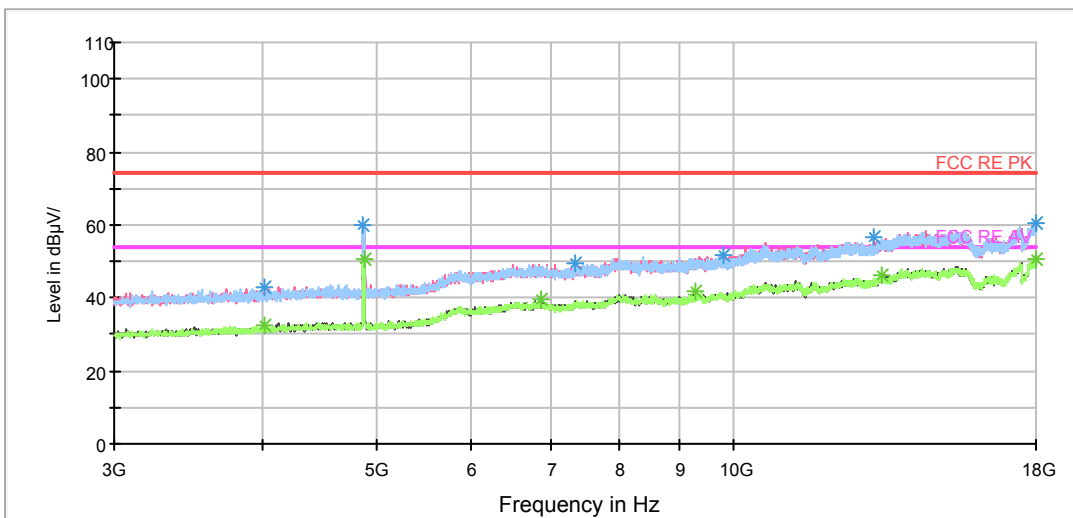

Radiates Emission from 3GHz to 18GHz



Frequency (MHz)	Peak (dBuV/m)	Height (cm)	Polarization	Azimuth (deg)	Reading value (dBuV/m)	Correct Factor (dB)	Margin (dB)	Limit (dBuV/m)
1196.500000	39.1	100.0	V	0.0	47.3	-8.2	34.9	74
1594.500000	42.6	100.0	V	357.0	48.5	-5.9	31.4	74
1725.000000	42.1	100.0	V	259.0	47.2	-5.1	31.9	74
1896.750000	41.1	100.0	V	324.0	45.2	-4.1	32.9	74
2674.750000	44.0	100.0	V	204.0	44.6	-0.6	30.0	74
2887.750000	42.1	100.0	V	20.0	42.6	-0.5	31.9	74

Remark: 1. Correction Factor = Antenna factor+ Insertion loss (cable loss + amplifier gain)

Frequency (MHz)	Average (dBuV/m)	Height (cm)	Polarization	Azimuth (deg)	Reading value (dBuV/m)	Correct Factor (dB)	Margin (dB)	Limit (dBuV/m)
1207.000000	26.3	100.0	H	100.0	34.4	-8.1	27.7	54
1594.000000	30.6	100.0	V	0.0	36.5	-5.9	23.4	54
1725.250000	35.2	100.0	V	76.0	40.3	-5.1	18.8	54
1907.000000	29.0	100.0	H	89.0	33.0	-4.0	25.0	54
2681.000000	32.8	100.0	V	357.0	33.4	-0.6	21.2	54
2908.000000	31.9	100.0	V	135.0	32.3	-0.4	22.1	54

Remark: 1. Correction Factor = Antenna factor+ Insertion loss (cable loss + amplifier gain)

802.11g CH11

FCC RE 1G-18GHz PK+AV Class B

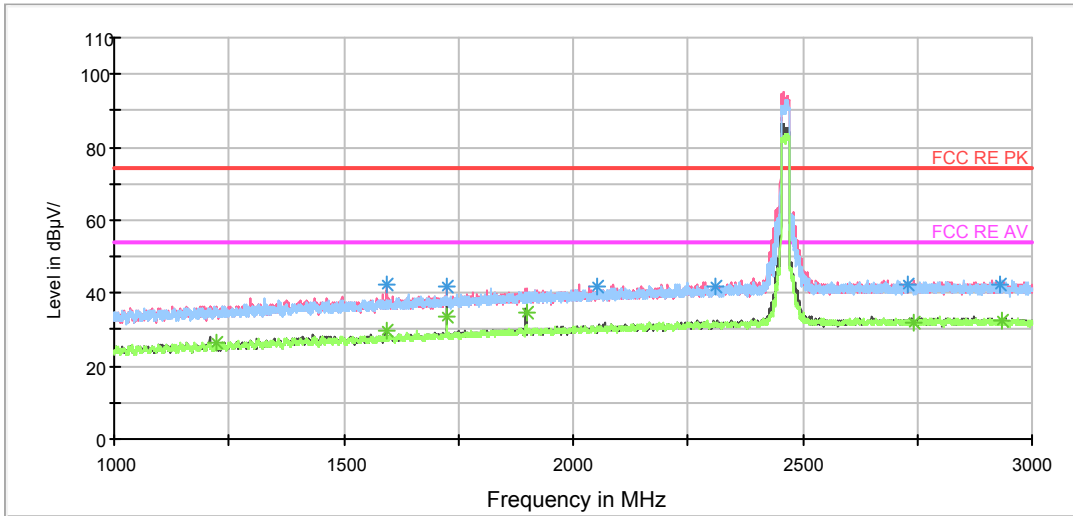

Note: The signal beyond the limit is carrier.
Radiates Emission from 1GHz to 3GHz

FCC RE 1G-18GHz PK+AV Class B

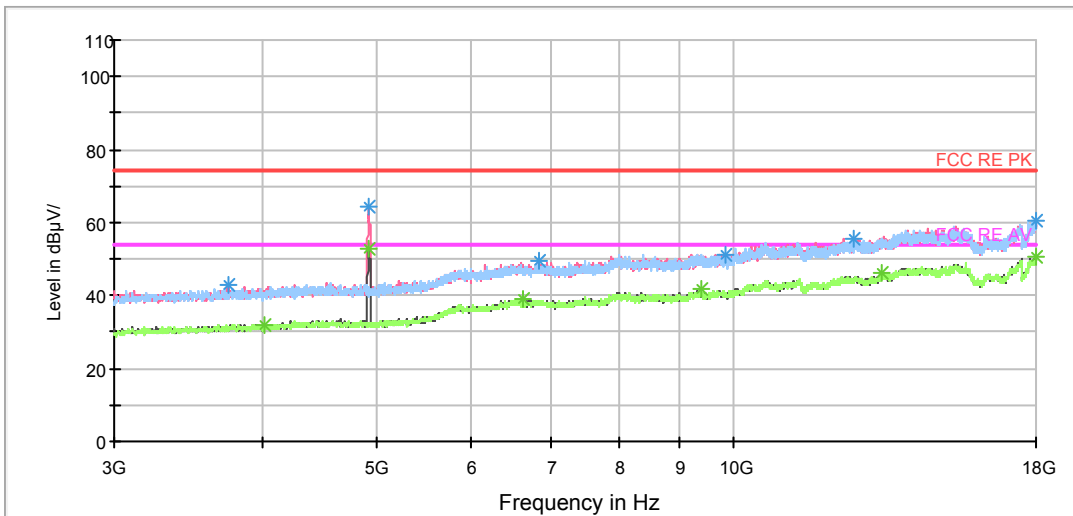

Radiates Emission from 3GHz to 18GHz



Frequency (MHz)	Peak (dBuV/m)	Height (cm)	Polarization	Azimuth (deg)	Reading value (dBuV/m)	Correct Factor (dB)	Margin (dB)	Limit (dBuV/m)
1595.000000	42.5	100.0	V	0.0	48.4	-5.9	31.5	74
1724.500000	41.9	100.0	V	123.0	47.0	-5.1	32.1	74
2054.000000	41.9	100.0	H	12.0	45.0	-3.1	32.1	74
2308.000000	41.9	100.0	H	3.0	43.6	-1.7	32.1	74
2728.750000	42.5	100.0	V	309.0	43.0	-0.5	31.5	74
2928.000000	42.2	100.0	H	8.0	42.6	-0.4	31.8	74

Remark: 1. Correction Factor = Antenna factor+ Insertion loss (cable loss + amplifier gain)

Frequency (MHz)	Average (dBuV/m)	Height (cm)	Polarization	Azimuth (deg)	Reading value (dBuV/m)	Correct Factor (dB)	Margin (dB)	Limit (dBuV/m)
1221.000000	26.4	100.0	V	7.0	34.5	-8.1	27.6	54
1594.500000	29.4	100.0	V	0.0	35.3	-5.9	24.6	54
1725.500000	33.7	100.0	V	76.0	38.8	-5.1	20.3	54
1897.750000	34.6	100.0	V	63.0	38.7	-4.1	19.4	54
2742.750000	32.1	100.0	V	0.0	32.7	-0.6	21.9	54
2936.500000	32.5	100.0	V	342.0	33.0	-0.5	21.5	54

Remark: 1. Correction Factor = Antenna factor+ Insertion loss (cable loss + amplifier gain)

802.11n (HT20) CH1

FCC RE 1G-18GHz PK+AV Class B

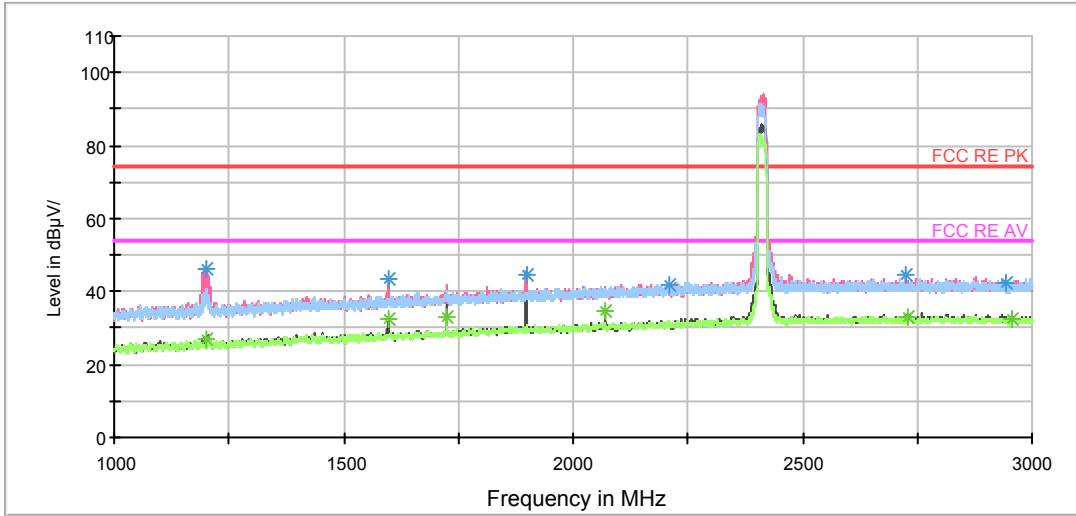

Note: The signal beyond the limit is carrier.
Radiates Emission from 1GHz to 3GHz

FCC RE 1G-18GHz PK+AV Class B

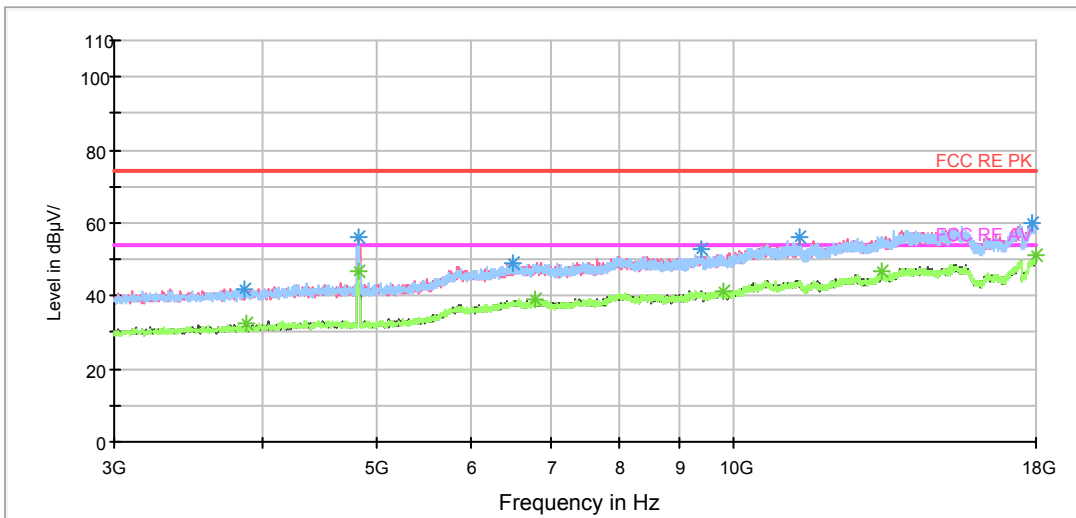

Radiates Emission from 3GHz to 18GHz



Frequency (MHz)	Peak (dBuV/m)	Height (cm)	Polarization	Azimuth (deg)	Reading value (dBuV/m)	Correct Factor (dB)	Margin (dB)	Limit (dBuV/m)
1200.500000	46.4	100.0	V	20.0	54.6	-8.2	27.6	74
1598.500000	43.6	100.0	V	358.0	49.5	-5.9	30.4	74
1897.750000	44.7	100.0	V	259.0	48.8	-4.1	29.3	74
2208.000000	41.7	100.0	V	0.0	44.0	-2.3	32.3	74
2725.500000	44.8	100.0	V	349.0	45.3	-0.5	29.2	74
2945.250000	42.3	100.0	V	112.0	42.8	-0.5	31.7	74

Remark: 1. Correction Factor = Antenna factor+ Insertion loss (cable loss + amplifier gain)

Frequency (MHz)	Average (dBuV/m)	Height (cm)	Polarization	Azimuth (deg)	Reading value (dBuV/m)	Correct Factor (dB)	Margin (dB)	Limit (dBuV/m)
1201.750000	27.0	100.0	V	20.0	35.2	-8.2	27.0	54
1599.500000	32.7	100.0	V	0.0	38.5	-5.8	21.3	54
1725.500000	33.1	100.0	V	314.0	38.2	-5.1	20.9	54
2069.750000	34.6	100.0	V	259.0	37.6	-3.0	19.4	54
2727.500000	33.2	100.0	V	20.0	33.7	-0.5	20.8	54
2955.500000	32.6	100.0	V	349.0	33.1	-0.5	21.4	54

Remark: 1. Correction Factor = Antenna factor+ Insertion loss (cable loss + amplifier gain)

802.11n (HT20) CH6

FCC RE 1G-18GHz PK+AV Class B

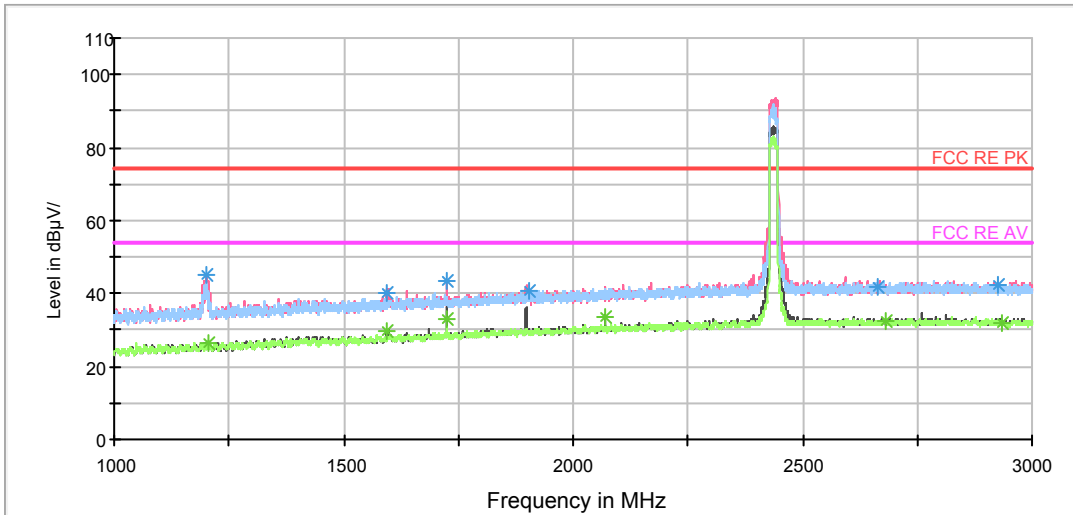

Note: The signal beyond the limit is carrier.
Radiates Emission from 1GHz to 3GHz

FCC RE 1G-18GHz PK+AV Class B

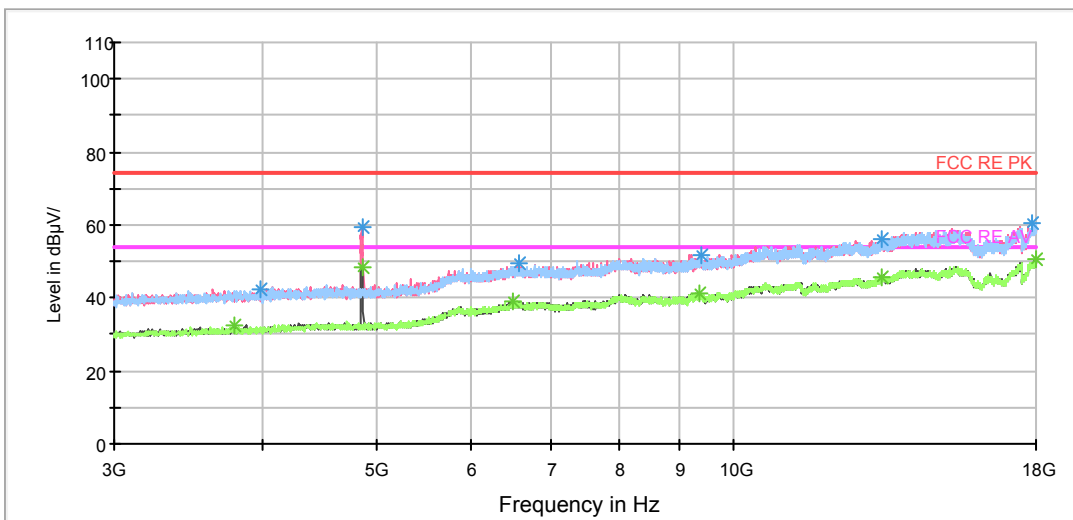

Radiates Emission from 3GHz to 18GHz



Frequency (MHz)	Peak (dBuV/m)	Height (cm)	Polarization	Azimuth (deg)	Reading value (dBuV/m)	Correct Factor (dB)	Margin (dB)	Limit (dBuV/m)
1200.500000	45.0	100.0	V	147.0	53.2	-8.2	29.0	74
1593.750000	40.0	100.0	V	0.0	45.9	-5.9	34.0	74
1724.750000	43.4	100.0	V	64.0	48.5	-5.1	30.6	74
1905.500000	40.5	100.0	H	272.0	44.5	-4.0	33.5	74
2665.500000	41.7	100.0	H	247.0	42.4	-0.7	32.3	74
2926.250000	42.4	100.0	V	0.0	42.8	-0.4	31.6	74

Remark: 1. Correction Factor = Antenna factor+ Insertion loss (cable loss + amplifier gain)

Frequency (MHz)	Average (dBuV/m)	Height (cm)	Polarization	Azimuth (deg)	Reading value (dBuV/m)	Correct Factor (dB)	Margin (dB)	Limit (dBuV/m)
1205.250000	26.3	100.0	V	239.0	34.4	-8.1	27.7	54
1594.250000	29.8	100.0	V	359.0	35.7	-5.9	24.2	54
1725.500000	33.2	100.0	V	64.0	38.3	-5.1	20.8	54
2070.250000	33.3	100.0	V	272.0	36.3	-3.0	20.7	54
2679.750000	32.7	100.0	H	223.0	33.3	-0.6	21.3	54
2933.500000	31.8	100.0	V	316.0	32.2	-0.4	22.2	54

Remark: 1. Correction Factor = Antenna factor+ Insertion loss (cable loss + amplifier gain)

802.11n (HT20) CH11

FCC RE 1G-18GHz PK+AV Class B

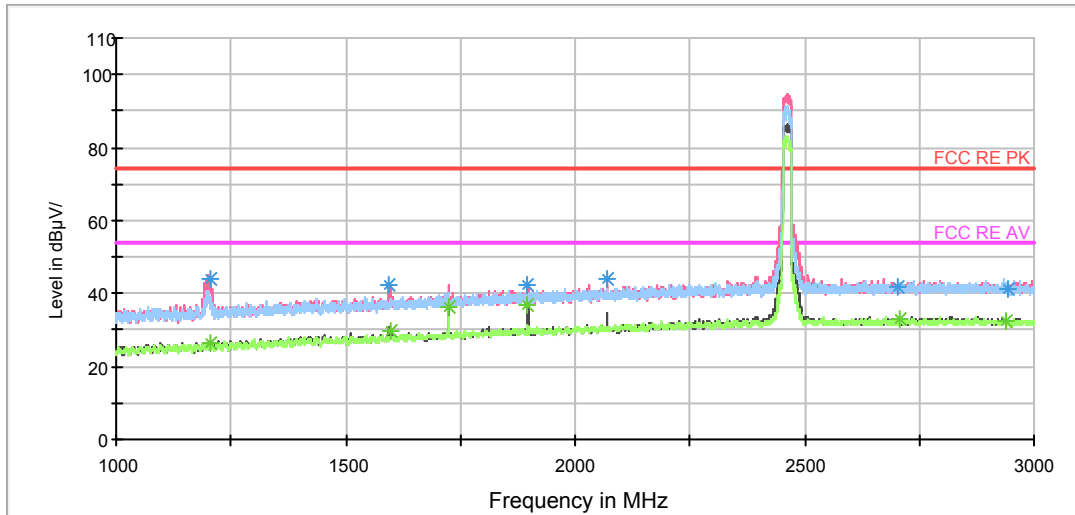

Note: The signal beyond the limit is carrier.
Radiates Emission from 1GHz to 3GHz

FCC RE 1G-18GHz PK+AV Class B

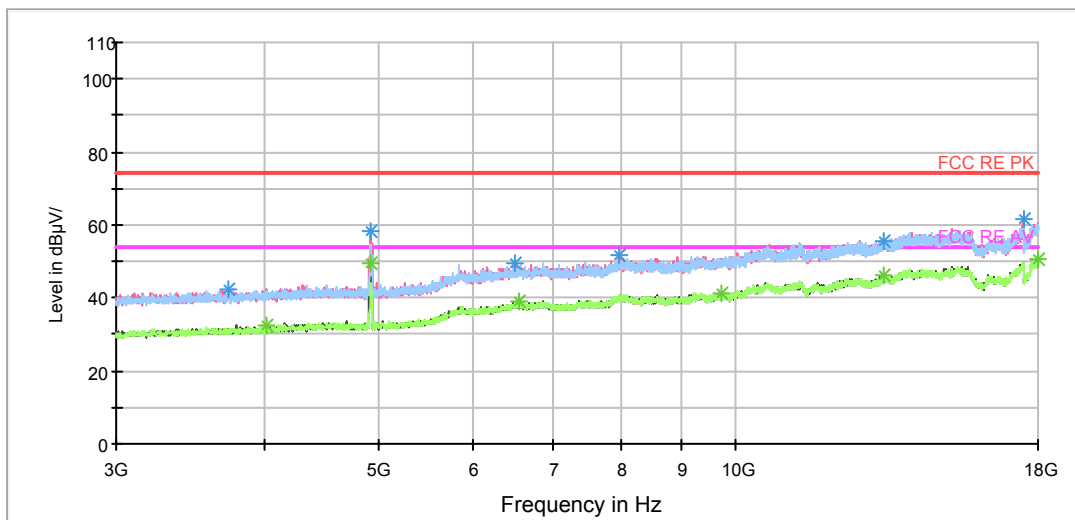

Radiates Emission from 3GHz to 18GHz



Frequency (MHz)	Peak (dBuV/m)	Height (cm)	Polarization	Azimuth (deg)	Reading value (dBuV/m)	Correct Factor (dB)	Margin (dB)	Limit (dBuV/m)
1204.750000	44.2	100.0	V	21.0	52.3	-8.1	29.8	74
1594.500000	42.6	100.0	V	0.0	48.5	-5.9	31.4	74
1897.250000	42.4	100.0	V	63.0	46.5	-4.1	31.6	74
2070.000000	43.8	100.0	V	249.0	46.8	-3.0	30.2	74
2703.250000	42.0	100.0	V	325.0	42.7	-0.7	32.0	74

Remark: 1. Correction Factor = Antenna factor+ Insertion loss (cable loss + amplifier gain)

Frequency (MHz)	Average (dBuV/m)	Height (cm)	Polarization	Azimuth (deg)	Reading value (dBuV/m)	Correct Factor (dB)	Margin (dB)	Limit (dBuV/m)
1204.500000	26.2	100.0	V	216.0	34.3	-8.1	27.8	54
1599.500000	29.8	100.0	V	316.0	35.6	-5.8	24.2	54
1724.750000	36.2	100.0	V	100.0	41.3	-5.1	17.8	54
1897.250000	36.8	100.0	V	63.0	40.9	-4.1	17.2	54
2706.500000	32.8	100.0	V	345.0	33.5	-0.7	21.2	54

Remark: 1. Correction Factor = Antenna factor+ Insertion loss (cable loss + amplifier gain)

802.11n (HT40) CH3

FCC RE 1G-18GHz PK+AV Class B

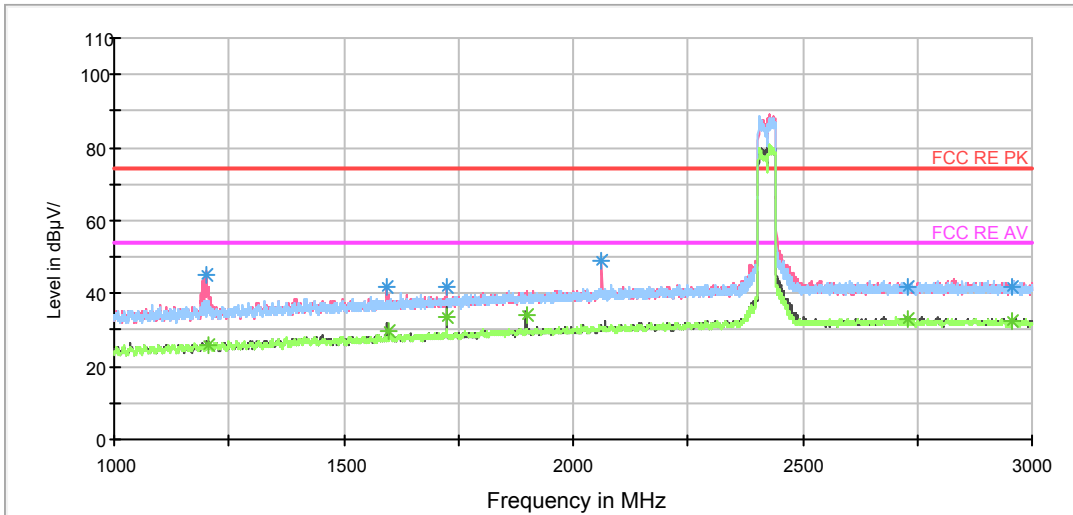

Note: The signal beyond the limit is carrier.
Radiates Emission from 1GHz to 3GHz

FCC RE 1G-18GHz PK+AV Class B

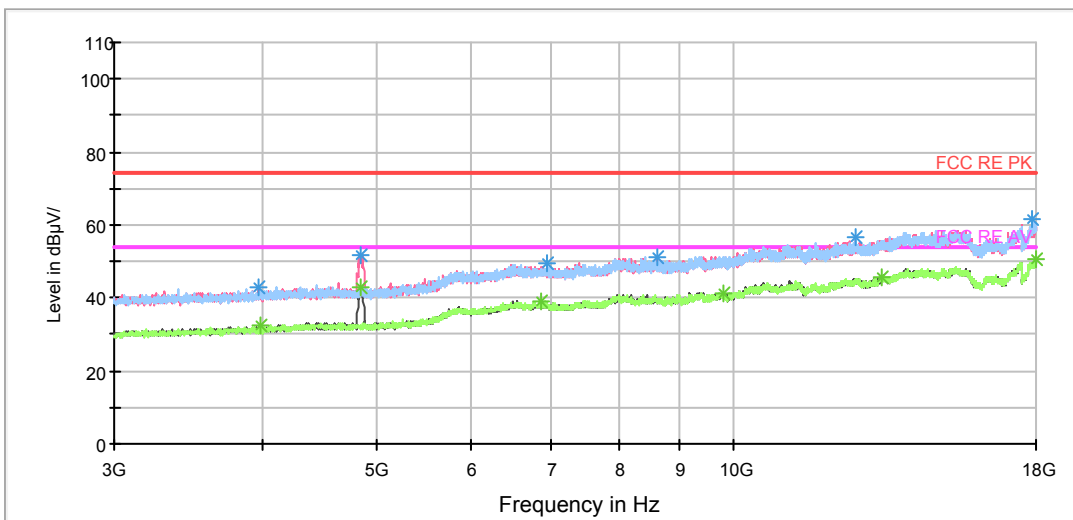

Radiates Emission from 3GHz to 18GHz



Frequency (MHz)	Peak (dBuV/m)	Height (cm)	Polarization	Azimuth (deg)	Reading value (dBuV/m)	Correct Factor (dB)	Margin (dB)	Limit (dBuV/m)
1199.250000	45.3	100.0	V	135.0	53.5	-8.2	28.7	74
1595.250000	41.8	100.0	V	354.0	47.7	-5.9	32.2	74
1725.250000	41.7	100.0	V	238.0	46.8	-5.1	32.3	74
2063.250000	48.9	100.0	V	0.0	51.9	-3.0	25.1	74
2727.500000	41.9	100.0	V	170.0	42.4	-0.5	32.1	74

Remark: 1. Correction Factor = Antenna factor+ Insertion loss (cable loss + amplifier gain)

Frequency (MHz)	Average (dBuV/m)	Height (cm)	Polarization	Azimuth (deg)	Reading value (dBuV/m)	Correct Factor (dB)	Margin (dB)	Limit (dBuV/m)
1203.500000	26.0	100.0	H	8.0	34.1	-8.1	28.0	54
1597.000000	29.6	100.0	V	348.0	35.5	-5.9	24.4	54
1724.500000	33.5	100.0	V	238.0	38.6	-5.1	20.5	54
1897.500000	34.3	100.0	V	261.0	38.4	-4.1	19.7	54
2729.250000	32.9	100.0	V	88.0	33.5	-0.6	21.1	54

Remark: 1. Correction Factor = Antenna factor+ Insertion loss (cable loss + amplifier gain)

802.11n (HT40) CH6

FCC RE 1G-18GHz PK+AV Class B

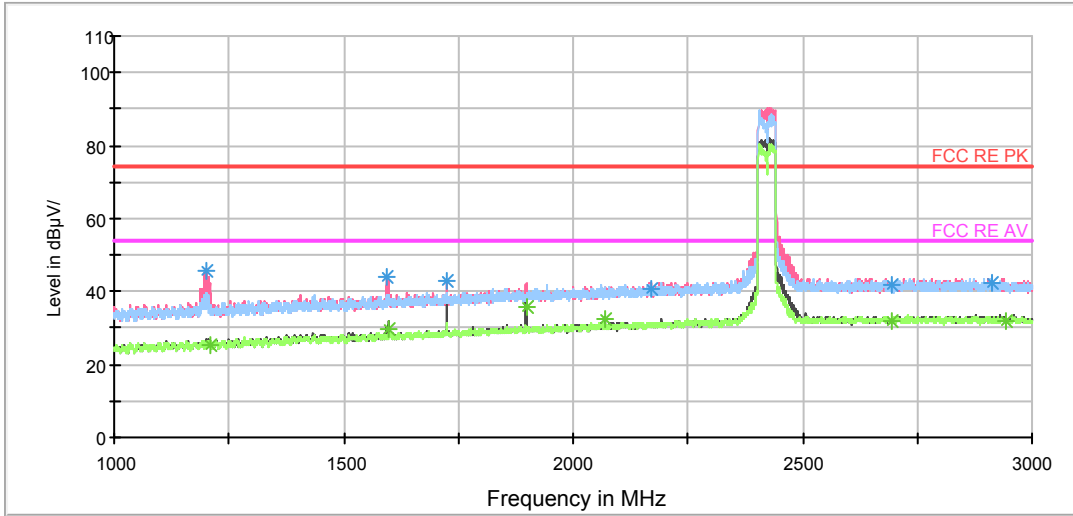

Note: The signal beyond the limit is carrier.
Radiates Emission from 1GHz to 3GHz

FCC RE 1G-18GHz PK+AV Class B

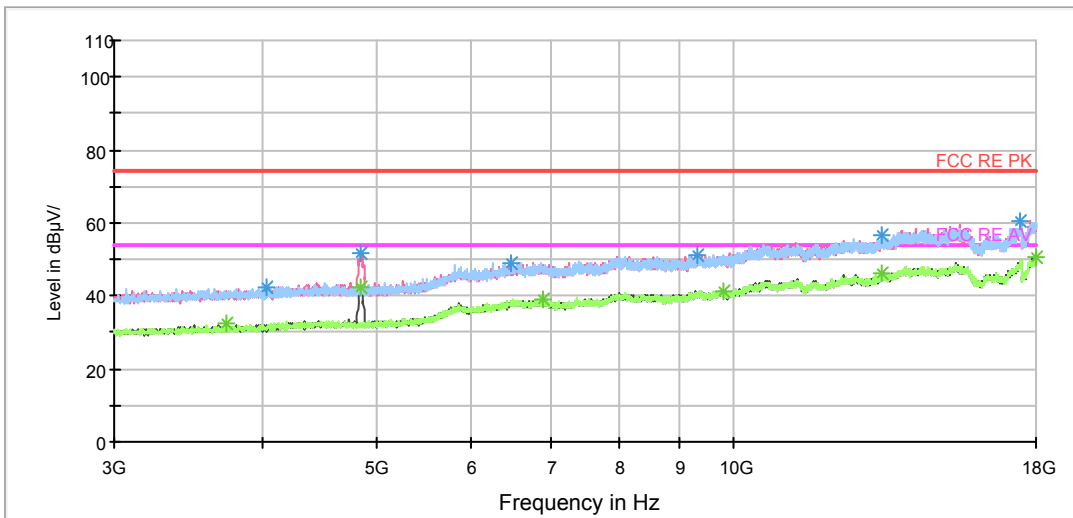

Radiates Emission from 3GHz to 18GHz



Frequency (MHz)	Peak (dBuV/m)	Height (cm)	Polarization	Azimuth (deg)	Reading value (dBuV/m)	Correct Factor (dB)	Margin (dB)	Limit (dBuV/m)
1199.250000	45.8	100.0	V	22.0	54.0	-8.2	28.2	74
1594.750000	44.0	100.0	V	0.0	49.9	-5.9	30.0	74
1725.000000	43.0	100.0	V	77.0	48.1	-5.1	31.0	74
2168.250000	40.9	100.0	V	358.0	43.4	-2.5	33.1	74
2693.500000	42.0	100.0	H	141.0	42.7	-0.7	32.0	74
2912.750000	42.3	100.0	V	273.0	42.7	-0.4	31.7	74

Remark: 1. Correction Factor = Antenna factor+ Insertion loss (cable loss + amplifier gain)

Frequency (MHz)	Average (dBuV/m)	Height (cm)	Polarization	Azimuth (deg)	Reading value (dBuV/m)	Correct Factor (dB)	Margin (dB)	Limit (dBuV/m)
1210.750000	25.2	100.0	V	0.0	33.3	-8.1	28.8	54
1598.000000	29.7	100.0	V	318.0	35.6	-5.9	24.3	54
1897.750000	35.9	100.0	V	90.0	40.0	-4.1	18.1	54
2069.750000	32.3	100.0	V	262.0	35.3	-3.0	21.7	54
2694.500000	32.2	100.0	V	353.0	32.9	-0.7	21.8	54
2943.500000	32.1	100.0	V	334.0	32.6	-0.5	21.9	54

Remark: 1. Correction Factor = Antenna factor+ Insertion loss (cable loss + amplifier gain)

802.11n (HT40) CH9

FCC RE 1G-18GHz PK+AV Class B

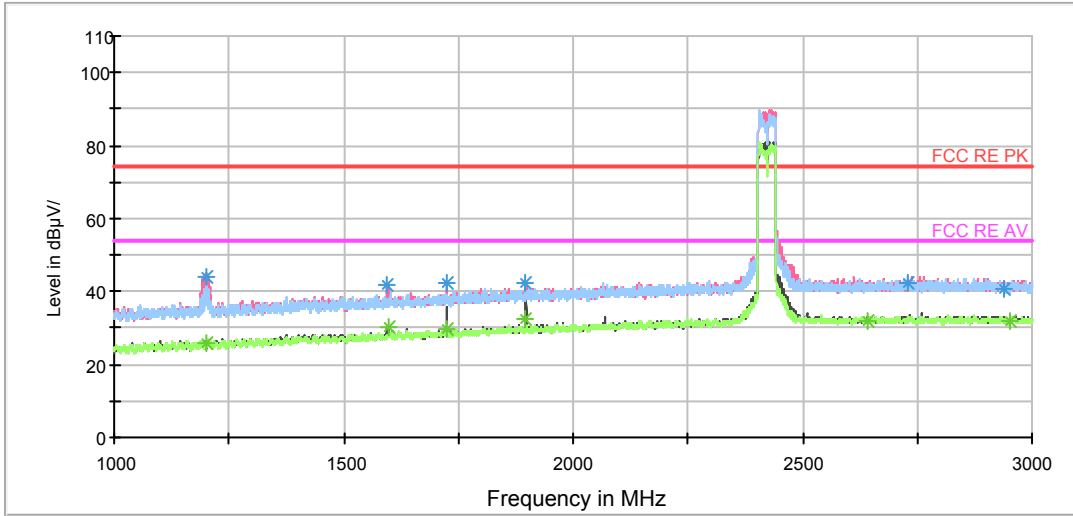

Note: The signal beyond the limit is carrier.
Radiates Emission from 1GHz to 3GHz

FCC RE 1G-18GHz PK+AV Class B

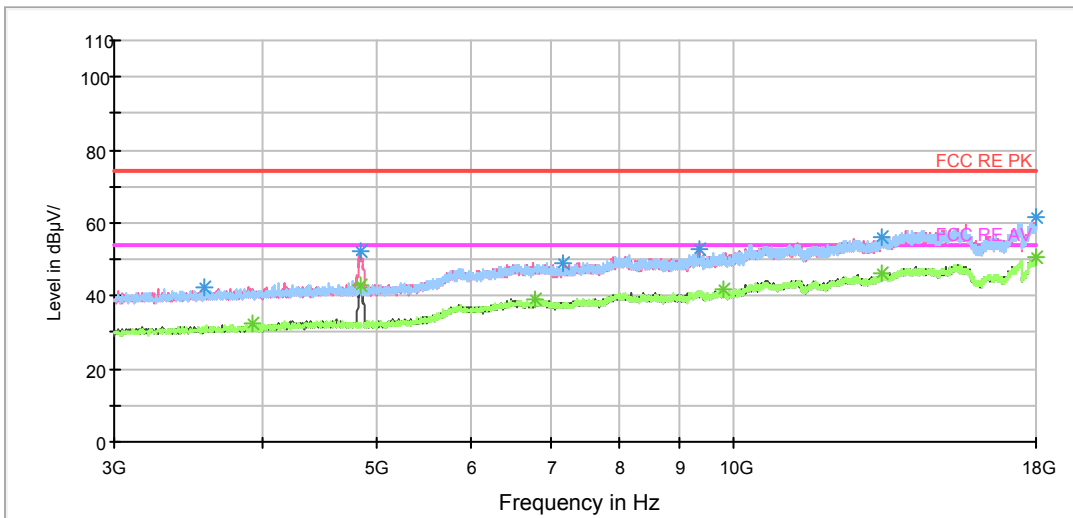

Radiates Emission from 3GHz to 18GHz



Frequency (MHz)	Peak (dBuV/m)	Height (cm)	Polarization	Azimuth (deg)	Reading value (dBuV/m)	Correct Factor (dB)	Margin (dB)	Limit (dBuV/m)
1202.750000	44.2	100.0	V	152.0	52.3	-8.1	29.8	74
1595.000000	41.9	100.0	V	356.0	47.8	-5.9	32.1	74
1724.750000	42.1	100.0	V	105.0	47.2	-5.1	31.9	74
1897.250000	42.4	100.0	V	93.0	46.5	-4.1	31.6	74
2727.750000	42.6	100.0	H	223.0	43.1	-0.5	31.4	74
2939.250000	40.8	100.0	V	337.0	41.3	-0.5	33.2	74

Remark: 1. Correction Factor = Antenna factor+ Insertion loss (cable loss + amplifier gain)

Frequency (MHz)	Average (dBuV/m)	Height (cm)	Polarization	Azimuth (deg)	Reading value (dBuV/m)	Correct Factor (dB)	Margin (dB)	Limit (dBuV/m)
1200.750000	26.0	100.0	V	9.0	34.2	-8.2	28.0	54
1599.250000	30.2	100.0	V	358.0	36.0	-5.8	23.8	54
1724.000000	29.4	100.0	V	105.0	34.5	-5.1	24.6	54
1896.750000	32.2	100.0	V	93.0	36.3	-4.1	21.8	54
2644.000000	31.8	100.0	V	352.0	32.6	-0.8	22.2	54
2952.000000	32.1	100.0	V	0.0	32.7	-0.6	21.9	54

Remark: 1. Correction Factor = Antenna factor+ Insertion loss (cable loss + amplifier gain)

5.8. Conducted Emission

Ambient condition

Temperature	Relative humidity	Pressure
23°C ~25°C	45%~50%	101.5kPa

Methods of Measurement

The EUT is placed on a non-metallic table of 80cm height above the horizontal metal reference ground plane. During the test, the EUT was operating in its typical mode. The test method is according to ANSI C63.10-2013. Connect the AC power line of the EUT to the L.I.S.N. Use EMI receiver to detect the average and Quasi-peak value. RBW is set to 9 kHz, VBW is set to 30kHz. The measurement result should include both L line and N line.

The test is in transmitting mode.

Test Setup

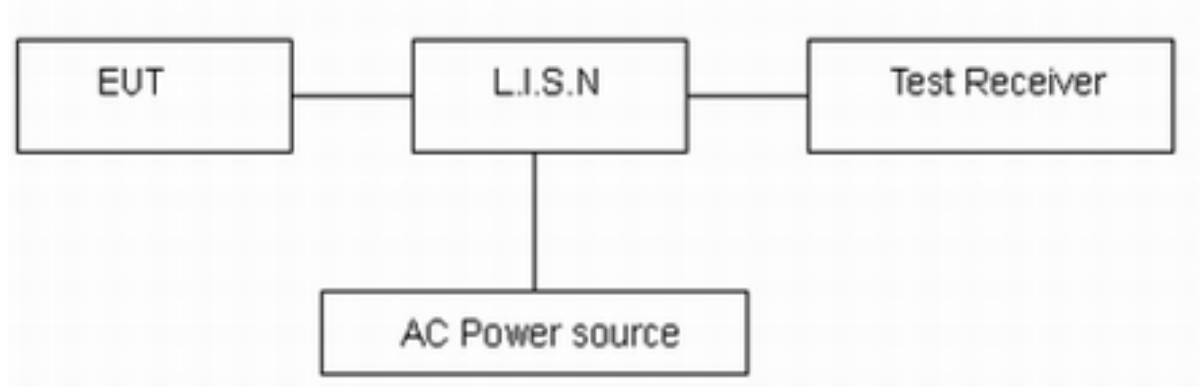

Note: AC Power source is used to change the voltage 110V/60Hz.

Limits

Frequency (MHz)	Conducted Limits(dBμV)	
	Quasi-peak	Average
0.15 - 0.5	66 to 56 *	56 to 46*
0.5 - 5	56	46
5 - 30	60	50

*: Decreases with the logarithm of the frequency.

Measurement Uncertainty

The assessed measurement uncertainty to ensure 95% confidence level for the normal distribution is with the coverage factor $k = 1.96$, $U = 2.69$ dB.



Test Results:

Following plots, Blue trace uses the peak detection and Green trace uses the average detection. During the test, the Conducted Emission was performed in all modes (WIFI 2.4G) with all channels, 802.11n (HT20), Channel 11 are selected as the worst condition. The test data of the worst-case condition was recorded in this report.

802.11n (HT20), Channel No.: 11

L Line

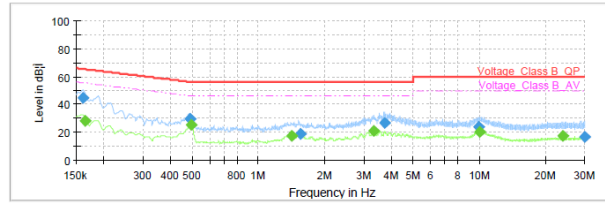

Frequency (MHz)	QuasiPeak (dB μ V)	Average (dB μ V)	Limit (dB μ V)	Margin (dB)	Meas. Time (ms)	Bandwidth (kHz)	Line	Filter	Corr. (dB)
0.161250	44.29	---	65.40	21.11	1000.0	9,000	L1	ON	19.6
0.163500	---	28.21	55.28	27.07	1000.0	9,000	L1	ON	19.6
0.492000	29.42	---	56.13	26.72	1000.0	9,000	L1	ON	19.6
0.496500	---	25.23	46.06	20.83	1000.0	9,000	L1	ON	19.6
1.412250	---	17.24	46.00	28.76	1000.0	9,000	L1	ON	19.6
1.551750	18.81	---	56.00	37.19	1000.0	9,000	L1	ON	19.6
3.331500	---	20.80	46.00	25.10	1000.0	9,000	L1	ON	19.6
3.719500	26.83	---	56.00	29.17	1000.0	9,000	L1	ON	19.6
3.989750	23.69	---	60.00	36.31	1000.0	9,000	L1	ON	19.9
10.059000	---	20.42	50.00	29.58	1000.0	9,000	L1	ON	19.9
24.000000	---	17.30	50.00	32.70	1000.0	9,000	L1	ON	20.0
29.940000	16.50	---	60.00	43.50	1000.0	9,000	L1	ON	20.1

N Line

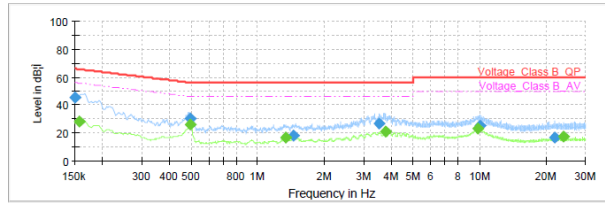

Frequency (MHz)	QuasiPeak (dB μ V)	Average (dB μ V)	Limit (dB μ V)	Margin (dB)	Meas. Time (ms)	Bandwidth (kHz)	Line	Filter	Corr. (dB)
0.150000	45.36	---	66.00	20.64	1000.0	9,000	N	ON	19.7
0.156750	---	28.15	56.63	27.49	1000.0	9,000	N	ON	19.7
0.494250	---	25.55	46.10	20.55	1000.0	9,000	N	ON	19.6
0.498500	---	58.06	25.97	1000.0	9,000	N	ON	19.6	
1.335750	---	16.49	46.00	29.51	1000.0	9,000	N	ON	19.6
1.452750	18.23	---	56.00	37.77	1000.0	9,000	N	ON	19.6
3.525000	26.29	---	56.00	29.71	1000.0	9,000	N	ON	19.6
3.752250	---	20.57	46.00	25.43	1000.0	9,000	N	ON	19.6
9.865500	---	22.71	60.00	27.29	1000.0	9,000	N	ON	19.9
10.092750	25.44	---	60.00	34.56	1000.0	9,000	N	ON	19.9
21.696000	16.25	---	60.00	43.75	1000.0	9,000	N	ON	19.9
24.000000	---	17.34	50.00	32.66	1000.0	9,000	N	ON	19.9

6. Main Test Instruments

Name	Manufacturer	Type	Serial Number	Calibration Date	Expiration Date
Spectrum Analyzer	R&S	FSV30	100815	2017-12-17	2018-12-16
EMI Test Receiver	R&S	ESCI	100948	2017-05-20	2018-05-19
TRILOG Broadband Antenna	Schwarzbeck	VULB 9163	9163-201	2017-11-18	2020-11-17
Double Ridged Waveguide Horn Antenna	R&S	HF907	100126	2014-12-06	2019-12-05
Loop Antenna	SCHWARZBECK	FMZB1519	1519-047	2017-11-18	2020-11-17
Standard Gain Horn	ETS-Lindgren	3160-09	00102644	2015-01-30	2020-01-29
EMI Test Receiver	R&S	ESR	101667	2017-09-06	2018-09-05
LISN	R&S	ENV216	101171	2016-12-16	2019-12-15
Spectrum Analyzer	Agilent	N9010A	MY47191109	2017-05-20	2018-05-19
Power Meter	R&S	NRP2	1144.1374K02 -104306-EX	2017-05-24	2018-05-23
Power Sensor	R&S	NRP-Z21	104799	2017-05-24	2018-05-23
RF Cable	Agilent	SMA 15cm	0001	/	/
Software (CE)	ROHDE&SCHW ARZ	EMC32	9.26.0	/	/
Software (RE/RSE)	ROHDE&SCHW ARZ	EMC32	8.52.0	/	/

*****END OF REPORT *****

A.2 Test Setup



30M Hz-1GHz

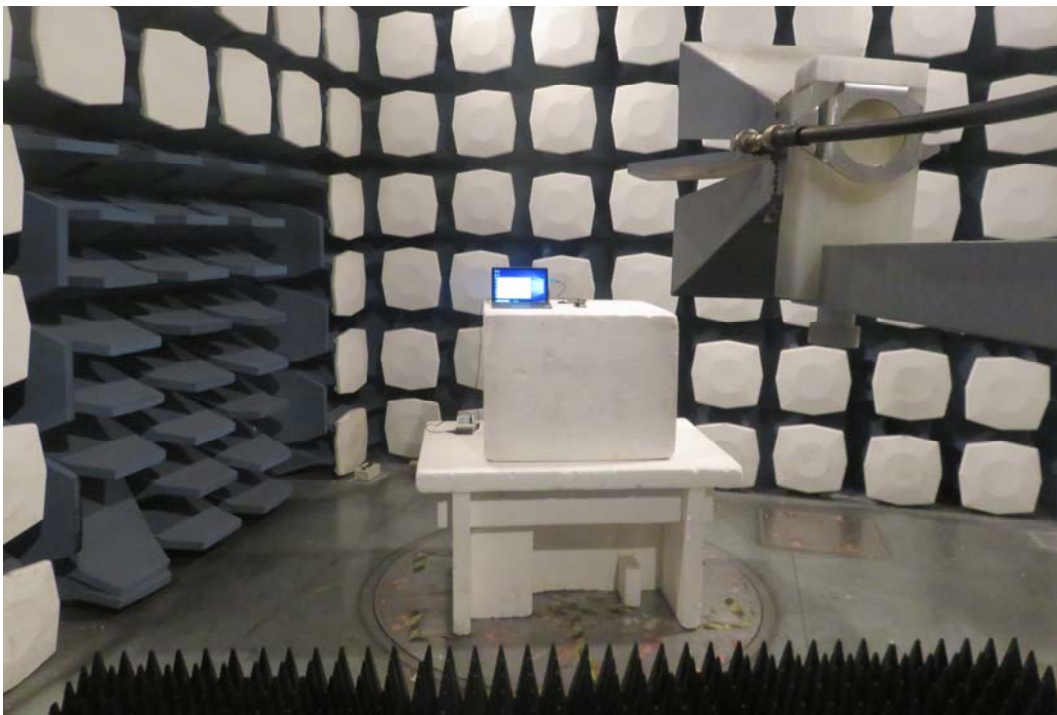

Above 1GHz

Picture 2 Radiated Emission Test Setup



Picture 3 Conducted Emission Test Setup