

TEST REPORT

REPORT NUMBER: B19W50651-BLE_Rev2

ON

Type of Equipment: Tracker
Model Name: PT200LSV
Manufacturer: Micron Electronics LLC.

ACCORDING TO

FCC Part 15, Subpart C, 2019:

15.205 Restricted bands of operation,

15.209 Radiated emission limits; general requirements,

15.247 Operation within the bands 902–928 MHz, 2400–2483.5 MHz, and 5725–5850 MHz

ANSI C63.10-2013: American National Standard of Procedures for Compliance Testing of Unlicensed Wireless Devices

Chongqing Academy of Information and Communications Technology

Month date, year

Jan, 14, 2020

Signature

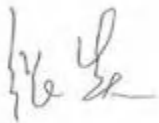

Zhang Yan
Director

Chongqing Academy of Information and Communications Technology

Report No.:B19W50651-BLE_Rev2

Note:

The test results in this test report relate only to the devices specified in this report. This report shall not be reproduced except in full without the written approval of Chongqing Academy of Information and Communications Technology.

Revision Version

Report Number	Revision	Date	Memo
B19W50651-BLE	V0.0	2019-12-27	--
B19W50651-BLE	V1.0	2020-01-08	--
B19W50651-BLE	V2.0	2020-01-14	--

Chongqing Academy of Information and Communications Technology

Report No.:B19W50651-BLE_Rev2

FCC ID: ZKQ-PT200LSV

Report Date: 2020-01-14

Test Firm Name: Chongqing Academy of Information and
Communications Technology

FCC Registration Number: CN1239

Statement

The measurements shown in this report were made in accordance with the procedures described on test pages. All reported tests were carried out on a sample equipment to demonstrate limited compliance with FCC Parts 15, subpart C. The sample tested was found to comply with the requirements defined in the applied rules.

Chongqing Academy of Information and Communications Technology

Report No.:B19W50651-BLE_Rev2

CONTENTS

1 GENERAL INFORMATION.....	4
1.1 NOTES.....	4
1.2 TESTERS.....	5
1.3 TESTING LABORATORY INFORMATION.....	6
1.4 DETAILS OF APPLICANT OR MANUFACTURER.....	7
2 TEST ITEM.....	8
2.1 GENERAL INFORMATION.....	8
2.2 OUTLINE OF EQUIPMENT UNDER TEST.....	8
2.3 MODIFICATIONS INCORPORATED IN EUT.....	8
2.4 EQUIPMENT CONFIGURATION.....	9
2.5 OTHER INFORMATION.....	9
3 SUMMARY OF TEST RESULTS.....	10
4 TEST EQUIPMENTS AND ANCILLARIES USED FOR TESTS.....	11
5 TEST RESULTS.....	12
5.1 MAXIMUM PEAK OUTPUT POWER.....	12
5.2 PEAK POWER SPECTRAL DENSITY.....	14
5.3 6DB OCCUPIED BANDWIDTH.....	19
5.4 BAND EDGES COMPLIANCE.....	23
5.5 TRANSMITTER SPURIOUS EMISSION-CONDUCTED.....	25
5.6 TRANSMITTER SPURIOUS EMISSION-RADIATED.....	30
5.7 POWER LINE CONDUCTED EMISSIONS.....	40
ANNEX A EUT PHOTOS.....	40
ANNEX B DEVIATIONS FROM PRESCRIBED TEST METHODS.....	44

Chongqing Academy of Information and Communications Technology

Report No.:B19W50651-BLE_Rev2

1 General Information

1.1 Notes

All reported tests were carried out on a sample equipment to demonstrate limited compliance with FCC Parts 15, subpart C and ANSI C63.10-2013 and KDB 558074.

The test results of this test report relate exclusively to the item(s) tested as specified in section 2.

The following deviation from, additions to, or exclusions from the test specifications have been made. See Annex B.

Chongqing Academy of Information and Communications Technology authorizes the applicant or manufacturer (see section 1.4) to reproduce this report provided, and the test report may only be reproduced or published in full. Reproduction or publication of extracts from the report requires the prior written approval of Chongqing Academy of Information and Communications Technology. Mr. Zhang Yan.

Any use which a third party makes of this report, or any reliance on or decisions to be made based on it, are the responsibility of such third parties. Chongqing Institute of Telecommunications accepts no responsibility for damages, if any, suffered by any third party as a result of decisions made or actions based on this report.

Chongqing Academy of Information and Communications Technology

Report No.:B19W50651-BLE_Rev2

1.2 Testers

Name: Li Xu
Position: Engineer
Department: Department of RF test
Date: 2019-12-10 to 2019-12-20

Signature:

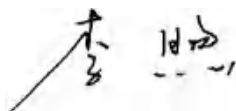

Editor of this test report:

Name: Chen Wen
Position: Engineer
Department: Department of RF test
Date: 2020-01-14

Signature:

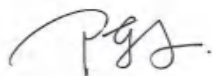

Technical responsibility for area of testing:

Name: Zhang Yan
Position: Manager
Department: Director of the laboratory
Date: 2020-01-14

Signature:

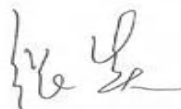

Chongqing Academy of Information and Communications Technology

Report No.:B19W50651-BLE_Rev2

1.3 Testing Laboratory information

1.3.1 Location

Name: Chongqing Academy of Information and Communications Technology

Address: Building B, Technology Innovation Center, No.8, Yuma Road, Chayuan New Area, Nan'an District, Chongqing, People's Republic of China, 401336

Tel: +86-23-88069965

Fax: +86-23-88608777

Email: liqiao@caict.ac.cn

1.3.2 Test location, where different from section 1.3.1

Name: -----

Street: -----

City: -----

Country: -----

Telephone: -----

Fax: -----

Postcode: -----

Chongqing Academy of Information and Communications Technology

Report No.:B19W50651-BLE_Rev2

1.4 Details of applicant or manufacturer

1.4.1 Applicant

Name: Micron Electronics LLC.
Address: 1001 Yamato Road,Suite 400,Boca Raton,Florida,United States 33431
Country: USA
Telephone: +18885383489
Fax: +18885501805
Contact: Ping Cheng
Email: pcheng@micron-electronics.com

1.4.2 Manufacturer (if different from applicant in section 1.4.1)

Name: --
Address: --
Country: --
Telephone: --
Fax: --
Contact: --
Email: --

2 Test Item

2.1 General Information

Manufacturer:	Micron Electronics LLC.
Type of Equipment:	Tracker
Model Name:	PT200LSV
Production Status:	Product
Hardware Version:	A506_V1_PCB
Software Version:	--
Normal Voltages	3.80 V
High Voltages	4.20 V
Low Voltages	3.40 V
Receipt date of test item:	2019-12-10

2.2 Outline of Equipment under Test

The PT200LSV, referred to as “EUT” hereafter, is a a multi-Band wireless modem operating on the LTE/Wi-Fi/Bluetooth networks. The table below shows the supported bands for the EUT.

Technology	Freq.(MHz)	Note
Bluetooth	2402-2480	--

2.3 Modifications Incorporated in EUT

The EUT has not been modified from what is described by the brand name and unique type identification stated above.

Chongqing Academy of Information and Communications Technology

Report No.:B19W50651-BLE_Rev2

2.4 Equipment Configuration

Equipment configuration list:

Item	Generic Description	Manufacturer	Type	Serial No.	Remarks
A	Modules	Micron Electronics LLC.	AT Plus 4E	--	None
B	Modules	Micron Electronics LLC.	AT Plus 4E	--	None
C	Adapter	--	--	--	--
D	Battery	--	--	--	--

2.5 Other Information

--

3 Summary of Test Results

A brief summary of the tests carried out is shown as following.

FCC Rules	Name of Test	Result
15.247(b)	Maximum Peak Output Power	Pass
15.247(e)	Peak Power Spectral Density	Pass
15.247(a)	6dB Occupied Bandwidth	Pass
15.247(d)	Band Edges Compliance	Pass
15.247 (d)	Transmitter Spurious Emission-Conducted	Pass
15.247, 15.205, 15.209	Transmitter Spurious Emission-Radiated	Pass
ANSI C63.10 voltage mains test	Power line Conducted Emissions	Pass
Note:--		

Chongqing Academy of Information and Communications Technology

Report No.:B19W50651-BLE_Rev2

4 Test Equipments and Ancillaries Used For Tests

The test equipments and ancillaries used are as follows.

No.	Equipment	Model	SN	Manufacture	Cal. Due Date
1	EMI Test Receiver	ESU26	100367	R&S	2020-03-01
2	Trilog super broad band test antenna	VULB 9163	9163-544	R&S	2020-11-23
3	Double-Ridged Horn Antenna	HF907	100357	R&S	2021-06-22
4	Fully-Anechoic Chamber	11.8m×6.5m×6.3m	--	ETS	2020-10-22
5	Universal Radio Communication Tester	SP8315	SP8315-1249	StarPoint	2020-03-01
6	Signal Generator	SMU200A	104517	R&S	2020-03-01
7	Spectrum analyzer	FSQ 26	201137/026	R&S	2020-03-01
8	spectrum analyzer	N9020A	MY50200376	Agilent	2020-03-01
9	DC Power Supply	N6705B	MY50000919	Agilent	2020-12-04
10	Climate chamber	SH-241	92010759	ESPEC	2020-03-01

5 Test Results

5.1 Maximum Peak Output Power

Specifications:	FCC Part 15.247(b)
DUT Serial Number:	--
Test conditions:	Ambient Temperature:15°C-35°C Relative Humidity:30%-60% Air pressure: 86-106kPa
Test Results:	Pass

Limit Level Construction:

The maximum peak output power of the intentional radiator shall not exceed the following:

1. For systems using digital modulation in the bands of 902 - 928 MHz, 2400 - 2483.5 MHz, and 5725 - 5850 MHz: 1 watt.
2. Except as shown in paragraphs (b)(3) (i), (ii) and (iii) of this section, if transmitting antennas of directional gain greater than 6 dBi are used the peak output power from the intentional radiator shall be reduced below the stated values in paragraphs (b)(1) or (b)(2) of this section, as appropriate, by the amount in dB that the directional gain of the antenna exceeds 6 dBi.

Measurement Uncertainty:

Measurement Uncertainty	±1.0dB
-------------------------	--------

Test Method:

The measurement is according to ANSI C63.10 clause 11.2

1. The output power of EUT was connected to the spectrum analyzer. The path loss was compensated to the results for each measurement.
2. Enable EUT transmitter maximum power continuously.
3. Set RBW \geq OBW, Set the appropriate VBW
4. Detector : Peak.
5. Trace mode: Max Hold

Note: --

Chongqing Academy of Information and Communications Technology

Report No.:B19W50651-BLE_Rev2

Measurement Results:

Channel No.	Output Power (dBm)	Limit (dBm)	Result
Low: 0	-0.32	30	Pass
Middle: 19	-3.85		Pass
High: 39	-3.86		Pass

Conclusion: PASS

5.2 Peak Power Spectral Density

Specifications:	FCC CFR Part 15.247(e)
DUT Serial Number:	--
Test conditions:	Ambient Temperature:15°C-35°C Relative Humidity:30%-60% Air pressure: 86-106kPa
Test Results:	--

Limit Level Construction:

Standard	Limit
FCC CFR Part 15.247(e)	< 8dBm/3 KHz

Measurement Uncertainty:

Measurement Uncertainty	±0.82dBm/KHz
-------------------------	--------------

Test procedure:

The measurement is according to ANSI C63.10 clause 11.10.

1. The output power of EUT was connected to the spectrum analyzer. The path loss was compensated to the results for each measurement.
2. Enable EUT transmitter maximum power continuously.
3. Set analyzer center frequency to DTS channel center frequency.
4. Set the span to 1.5 times the DTS bandwidth.
5. Set the RBW to $3 \text{ kHz} \leq \text{RBW} \leq 100 \text{ kHz}$.
6. Set the VBW $\geq [3 \times \text{RBW}]$.
7. Detector = peak.
8. Sweep time = auto couple.
9. Trace mode = max hold.
10. Allow trace to fully stabilize.
11. Use the peak marker function to determine the maximum amplitude level within the RBW.
12. If measured value exceeds requirement, then reduce RBW (but no less than 3 kHz) and repeat.

Note: --

Test Results:

Power Spectral Density(dBm/3kHz)			Conclusion
Ch0	Ch19	Ch39	
-14.25	-17.12	-17.39	Pass
Power Spectral Density(dBm/100kHz)			Conclusion
Ch0	Ch19	Ch39	
-0.67	-3.67	-3.81	Pass

Conclusion: PASS

Test figure as below:

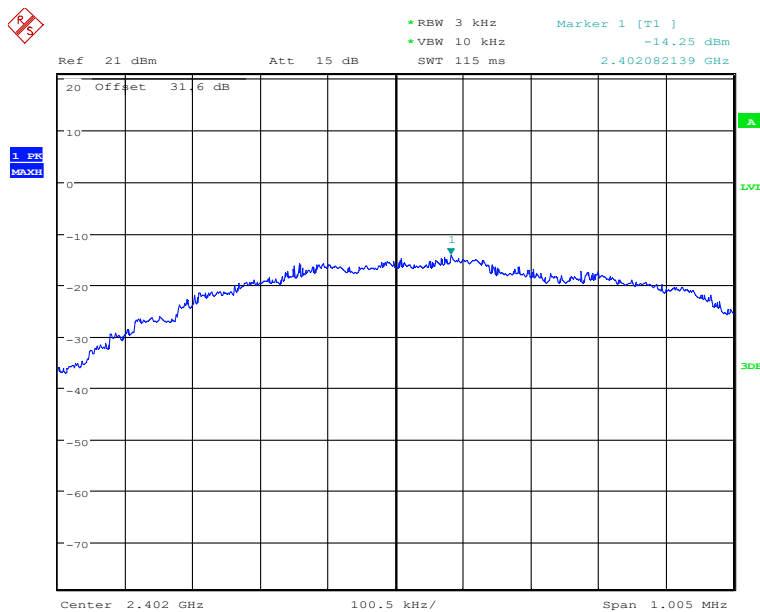

Date: 8.DEC.2019 03:42:31

Fig.1 Power spectral density: CH0 PSD/3KHz

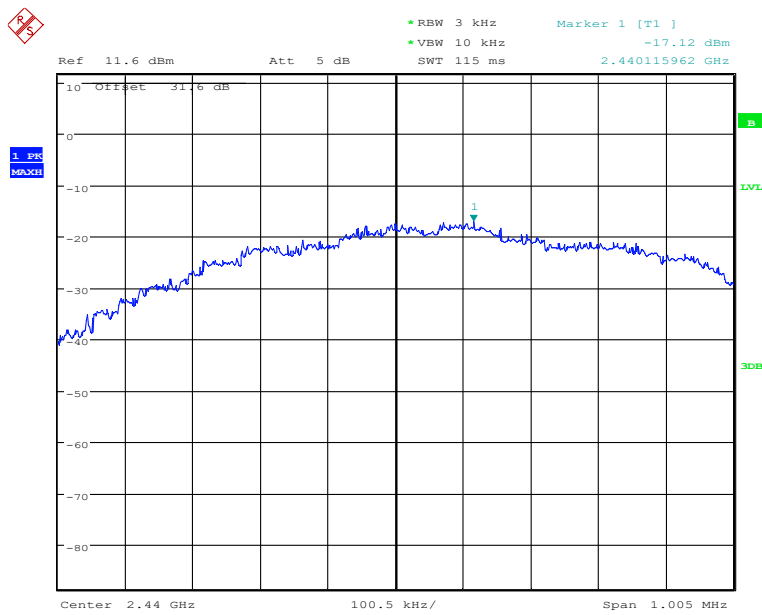

Date: 8.DEC.2019 04:09:33

Fig.2 Power spectral density: CH19 PSD/3KHz

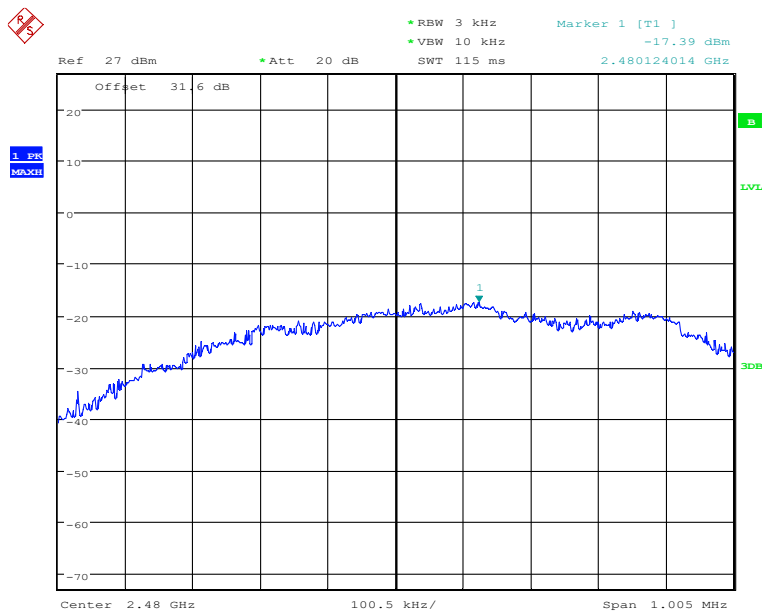

Date: 8.DEC.2019 04:16:07

Fig.3 Power spectral density: CH39 PSD/3KHz

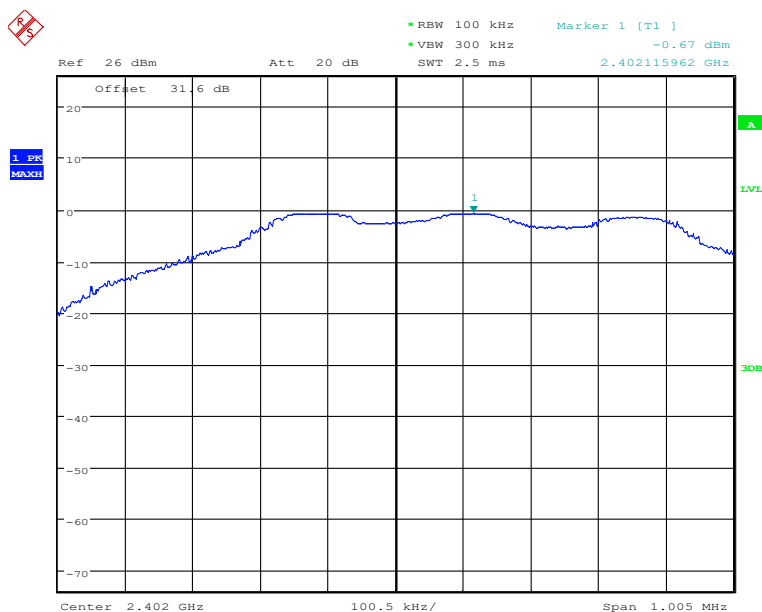

Date: 8.DEC.2019 03:43:16

Fig.4 Power spectral density: CH0 PSD/100KHz

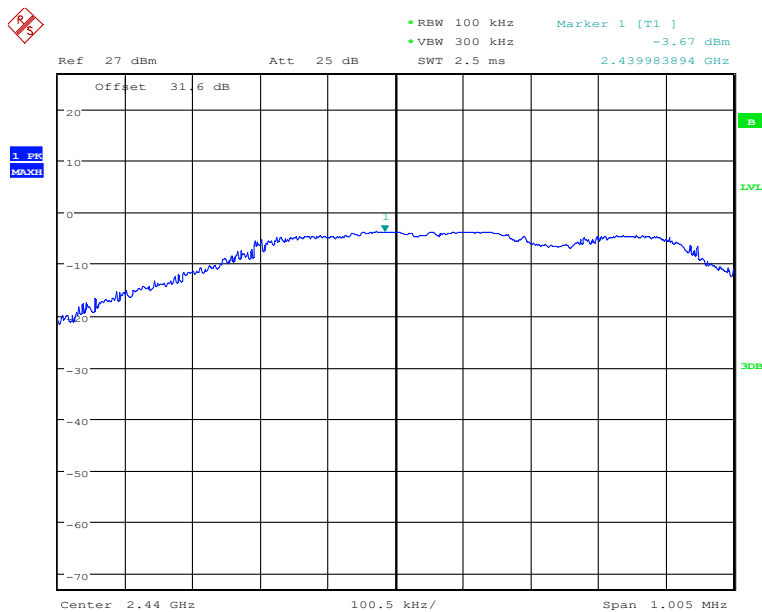

Date: 8.DEC.2019 04:10:13

Fig.5 Power spectral density: CH19 PSD/100KHz

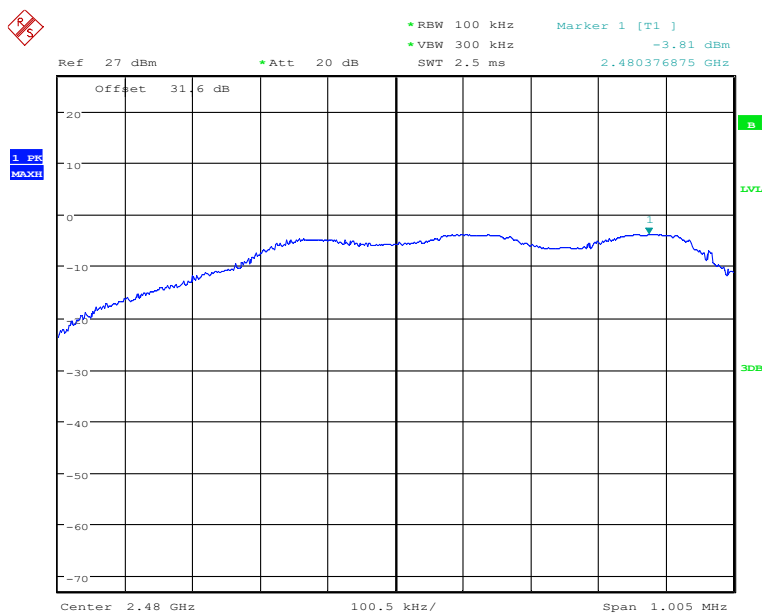

Date: 8.DEC.2019 04:16:38

Fig.6 Power spectral density: CH39 PSD/100KHz

5.3 6dB Occupied Bandwidth

Specifications:	FCC 47 CFR Part 15.247(a)
DUT Serial Number:	--
Test conditions:	Ambient Temperature:15°C-35°C Relative Humidity:30%-60% Air pressure: 86-106kPa
Test Results:	--

Limit Level Construction:

Standard	Limit(KHz)
FCC 47 CFR Part 15.247(a)	≥500

Measurement Uncertainty:

Measurement Uncertainty	±1.1KHz
-------------------------	---------

Test Procedure

The measurement is according to ANSI C63.10 clause 11.8.

1. The output power of EUT was connected to the spectrum analyzer. The path loss was compensated to the results for each measurement.
2. Enable EUT transmitter maximum power continuously.
3. Set RBW = 100 kHz.
4. Set the VBW $\geq [3 \times \text{RBW}]$.
5. Detector = peak.
6. Trace mode = max hold.
7. Sweep = auto couple.
8. Allow the trace to stabilize.
9. Measure the maximum width of the emission that is constrained by the frequencies associated with the two outermost amplitude points (upper and lower frequencies) that are attenuated by 6 dB relative to the maximum level measured in the fundamental emission.

Note: --

Chongqing Academy of Information and Communications Technology

Report No.:B19W50651-BLE_Rev2

Test Result:

Occupied 6dB Bandwidth(MHz)			Conclusion
Ch0	Ch19	Ch39	
0.702	0.695	0.705	Pass

Conclusion: PASS

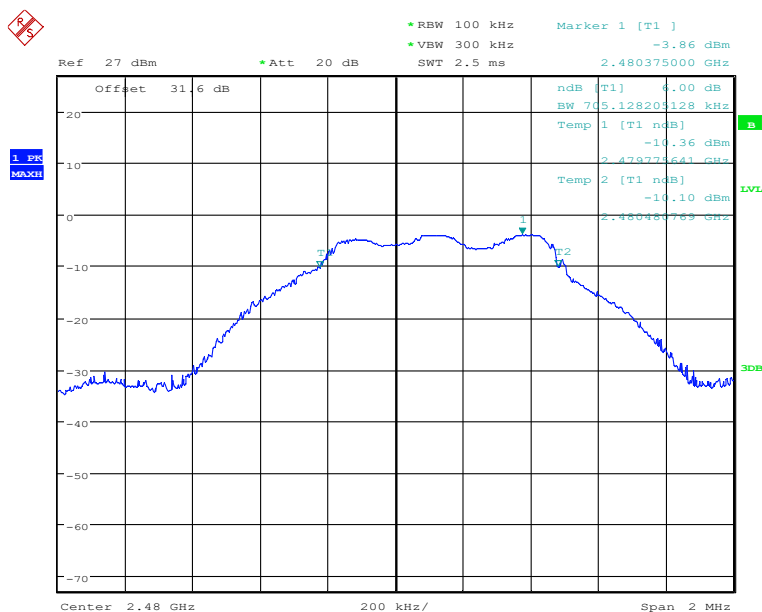

Date: 8.DEC.2019 04:17:20

Fig.9 6dB Bandwidth: Ch39

5.4 Band Edges Compliance

Specifications:	FCC 47 CFR Part 15.247(d)
DUT Serial Number:	--
Test conditions:	Ambient Temperature:15°C-35°C Relative Humidity:30%-60% Air pressure: 86-106kPa
Test Results:	--

Limit Level Construction:

Standard	Limited(dBuV/m)	
FCC 47 CFR Part 15.247(d)	Peak	74
	Average	54

Measurement Uncertainty:

Frequency Range	Uncertainty
1 GHz to 6 GHz	4.68

Test Procedure

The measurement is according to ANSI C63.10 clause11.13.

1. Span: Wide enough to capture the peak level of the emission operating on the channel closest to the band edge, as well as any modulation products that fall outside of the authorized band of operation.
2. Reference level offset: Corrected for gains and losses of test antenna factor, preamp gain and cable loss, so as to indicate field strength, in units of dB μ V/m at 3 m, directly on the instrument display. Alternatively, the reference level offset may be set to zero and calculations shall be provided showing the conversion of raw measured data to the field strength in dB μ V/m at 3 m.
3. Reference level: As required to keep the signal from exceeding the maximum spectrum analyzer input mixer level for linear operation. In general, the peak of the spectral envelope shall be more than [10 log (OBW/RBW)] below the reference level. Specific guidance is given in 4.1.5.2..
4. Attenuation: Auto (at least 10 dB preferred).
5. Sweep time: Coupled.
6. Resolution bandwidth: Above 1 GHz: 1 MHz
7. Video bandwidth: VBW for Peak, Quasi-peak, or Average Detector Function: 3 \times RBW
8. Detector (unless specified otherwise): Peak and average above 1 GHz
9. Trace: Max hold for final measurement; a combination of two traces, clear-write and max hold, is recommended for maximizing the emission.

Note: --

Address: No. 8,Yuma Road, Chayuan New City, Nan'an District, Chongqing, P. R. China,401336
Tel: 0086-23-88069965 FAX: 0086-23-88608777

Test Result:

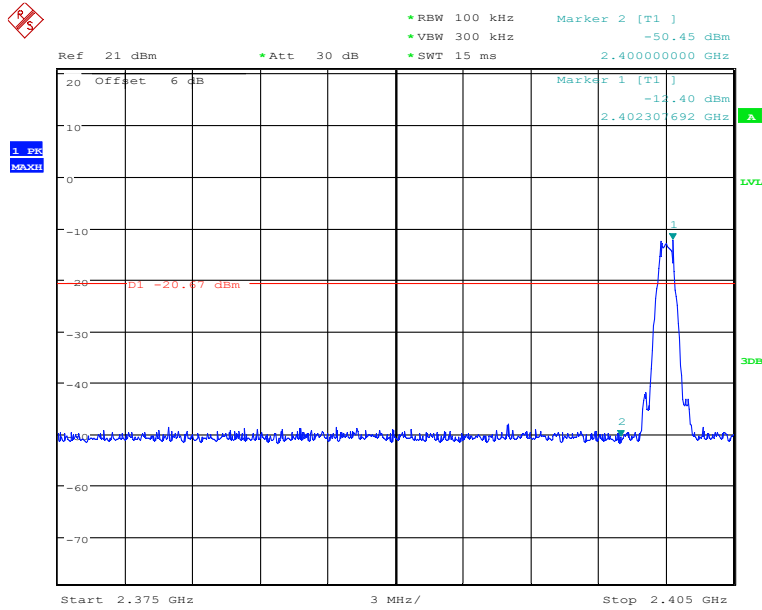

Date: 3.JAN.2020 00:26:02

Fig.10 Frequency Band Edge: Ch0

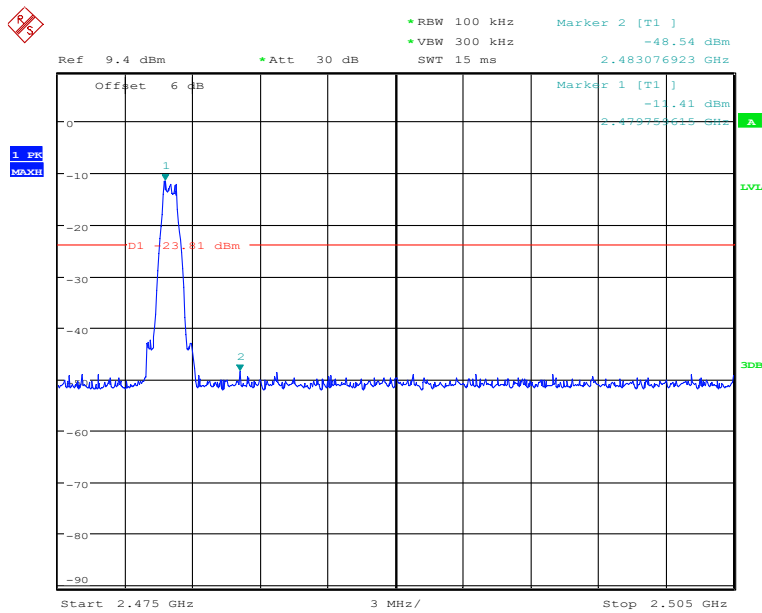

Date: 8.DEC.2019 18:03:38

Fig.11 Frequency Band Edge: Ch39

Conclusion: PASS

5.5 Transmitter Spurious Emission-Conducted

Specifications:	FCC 47 CFR Part15.247 (d)
DUT Serial Number:	--
Test conditions:	Ambient Temperature:15°C-35°C Relative Humidity:30%-60% Air pressure: 86-106kPa
Test Results:	--

Limit

Standard	Limit
FCC 47 CFR Part15.247 (d)	20dB below peak output power in 100KHz bandwidth

Measurement Uncertainty:

Frequency Range	Uncertainty
$30\text{MHz} \leq f \leq 26\text{GHz}$	± 2.7

Test Procedure

This measurement is according to ANSI C63.10 clause 11.11.

1. The output power of EUT was connected to the spectrum analyzer. The path loss was compensated to the results for each measurement.
2. Enable EUT transmitter maximum power continuously.

Reference level measurement

3. Set instrument center frequency to DTS channel center frequency.
4. Set the span to ≥ 1.5 times the DTS bandwidth.
5. Set the RBW = 100 kHz.
6. Set the VBW $\geq [3 \times \text{RBW}]$.
7. Detector = peak.
8. Sweep time = auto couple.
9. Trace mode = max hold.
10. Allow trace to fully stabilize.
11. Use the peak marker function to determine the maximum PSD level.

Emission level measurement

12. Set the center frequency and span to encompass frequency range to be measured.
13. Set the RBW = 100 kHz.
14. Set the VBW $\geq [3 \times \text{RBW}]$.
15. Detector = peak.
16. Sweep time = auto couple.
17. Trace mode = max hold.
18. Allow trace to fully stabilize.
19. Use the peak marker function to determine the maximum amplitude level.

Chongqing Academy of Information and Communications Technology

Report No.:B19W50651-BLE_Rev2

Test Result:

Channel	Frequency Range	Test Results	Conclusion
0	30MHz~3GHz	Fig.12	Pass
	3GHz~26.5GHz	Fig.13	Pass
19	30MHz~3GHz	Fig.14	Pass
	3GHz~26.5GHz	Fig.15	Pass
39	30MHz~3GHz	Fig.16	Pass
	3GHz~26.5GHz	Fig.17	Pass

Conclusion: PASS

Test figure as below:

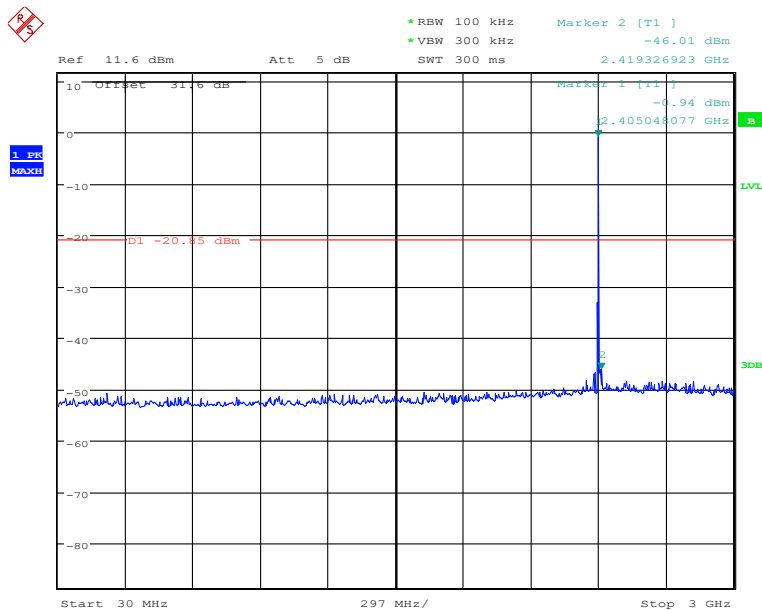

Date: 8.DEC.2019 04:05:24

Fig.12 Conducted spurious emission: Ch0, 30MHz~3GHz

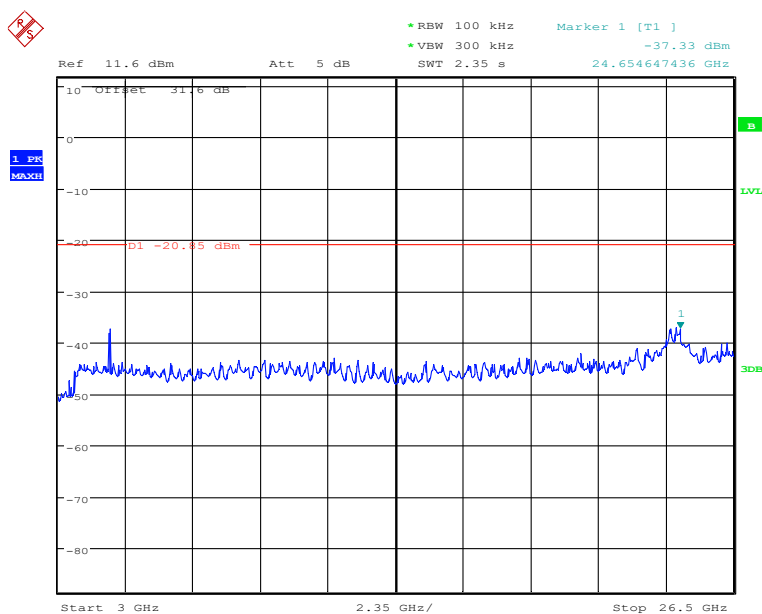

Date: 8.DEC.2019 04:06:27

Fig.13 Conducted spurious emission: Ch0, 3GHz~26.5GHz

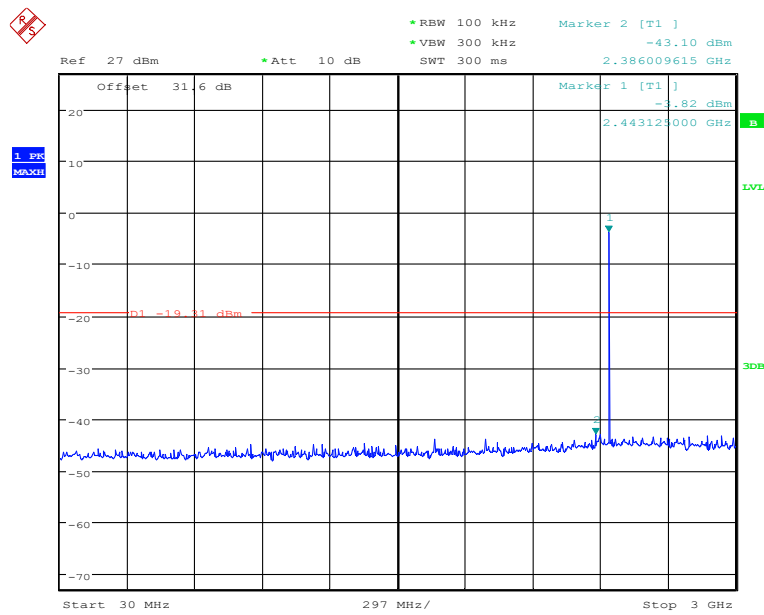

Date: 8.DEC.2019 04:12:59

Fig.14 Conducted spurious emission: Ch19, 30MHz~3GHz

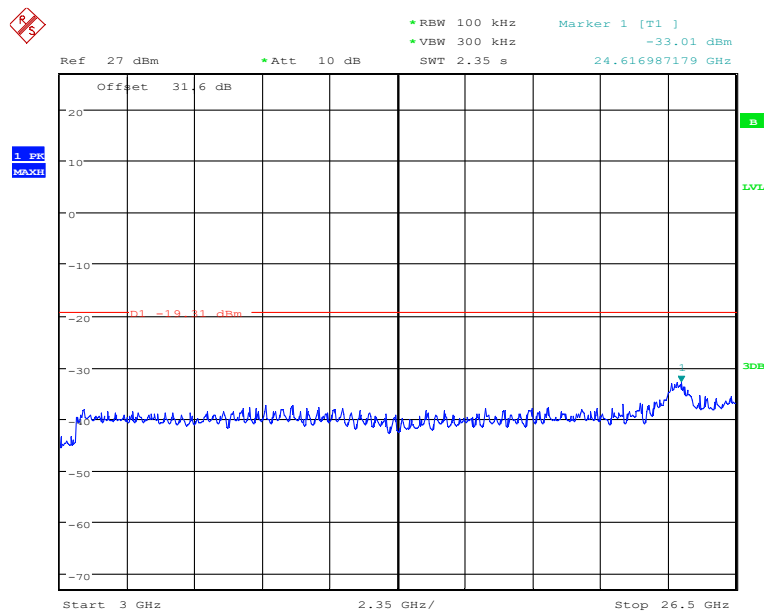

Date: 8.DEC.2019 04:13:48

Fig.15 Conducted spurious emission: Ch19, 3GHz~26.5GHz

Report No.:B19W50651-BLE_Rev2

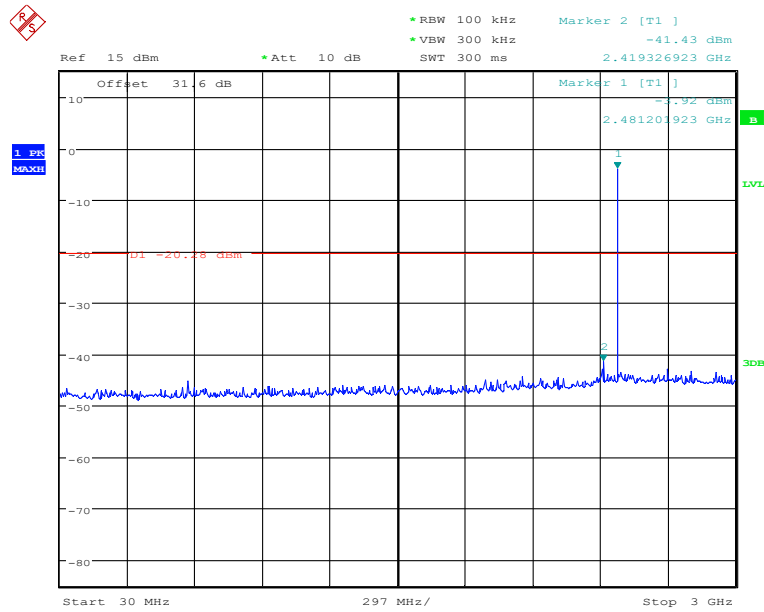

Date: 8.DEC.2019 04:19:59

Fig.16 Conducted spurious emission: Ch39, 30MHz~3GHz

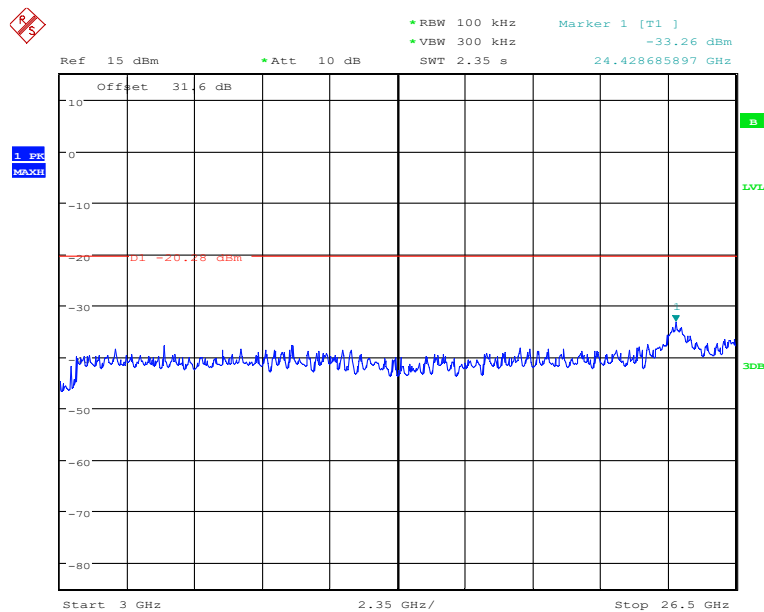

Date: 8.DEC.2019 04:20:25

Fig.17 Conducted spurious emission: Ch39, 3GHz~26.5GHz

5.6 Transmitter Spurious Emission-Radiated

Specifications:	FCC 47 CFR Part 15.247, 15.205, 15.209
DUT Serial Number:	--
Test conditions:	Ambient Temperature:15°C-35°C Relative Humidity:30%-60% Air pressure: 86-106kPa
Test Results:	--

Limit

Standard	Limit
FCC 47 CFR Part 15.247, 15.205, 15.209	20dB below peak output power

In addition, radiated emissions which fall in the restricted bands, as defined in 15.205(a), must also comply with the radiated emission limits specified in 15.209(a) (see 15.205(c)).

Measurement Uncertainty:

Frequency Range	Uncertainty
$30\text{MHz} \leq f \leq 2\text{GHz}$	± 1.13
$2\text{GHz} \leq f \leq 3.6\text{GHz}$	± 1.16
$3.6\text{GHz} \leq f \leq 8\text{GHz}$	± 2.45
$8\text{GHz} \leq f \leq 12.75\text{GHz}$	± 2.99

Limit in restricted band:

Frequency of emission (MHz)	Field strength (uV/m)	Field strength (dBuV/m)
30~88	100	40
88~216	150	43.5
216~960	200	46
Above 960	500	54

Test Procedure

Portable, small, lightweight, or modular devices that may be handheld, worn on the body, or placed on a table during operation shall be positioned on a non-conducting platform, the top of which is 80 cm above the reference ground plane. The preferred area occupied by the EUT arrangement is 1 m by 1.5 m, but it may be larger or smaller to accommodate various sized EUTs.

Chongqing Academy of Information and Communications Technology

Report No.:B19W50651-BLE_Rev2

For testing purposes, ceiling- and wall-mounted devices also shall be positioned on a tabletop (see also ANSI C63.10-2013 section 6.3.4 and 6.3.5). In making any tests involving handheld, body-worn, or ceiling-mounted equipment, it is essential to recognize that the measured levels may be dependent on the orientation (attitude) of the three orthogonal axes of the EUT. Thus, exploratory tests as specified in 8.3.1 shall be carried out for various axes orientations to determine the attitude having maximum or near-maximum emission level.

The EUT was placed on a non-conductive table. The measurement antenna was placed at a distance of 3 meters from the EUT. During the tests, the antenna height and the EUT azimuth were varied in order to identify the maximum level of emissions from the EUT. This maximization process was repeated with the EUT positioned in each of its three orthogonal orientations.

Frequency of emission (MHz)	RBW/VBW	Sweep Time (s)
30~1000	100KHz/300KHz	5
1000~4000	1MHz/1MHz	15
4000~18000	1MHz/1MHz	40
18000~26500	1MHz/1MHz	20

Test Result:

A “reference path loss” is established and AR_{pi} is the attenuation of “reference path loss”, and including the gain of receive antenna , the gain of the preamplifier, the cable loss.

The measurement results are obtained as described below:

$$AR_{pi} = \text{Cable loss} + \text{Antenna Gain} - \text{Preamplifier gain}$$

$$\text{Result} = PM_{ea} + AR_{pi}$$

Channel	Frequency Range	Test Results	Conclusion
Ch0	30MH-1GHz	Fig.18	Pass
	1GHz-3GHz	Fig.19	Pass
	3GHz-18GHz	Fig.20	Pass

Channel	Frequency Range	Test Results	Conclusion
Ch19	30MH-1GHz	Fig.21	Pass
	1GHz-3GHz	Fig.22	Pass

Chongqing Academy of Information and Communications Technology

Report No.:B19W50651-BLE_Rev2

	3GHz-18GHz	Fig.23	Pass
--	------------	--------	------

Channel	Frequency Range	Test Results	Conclusion
Ch39	30MH-1GHz	Fig.24	Pass
	1GHz-3GHz	Fig.25	Pass
	3GHz-18GHz	Fig.26	Pass
All channels	18GHz-26GHz	Fig.27	Pass

Note: all the test data shown was peak detected.

Conclusion: PASS

Test graphs as below:

RE 30MHz-1GHz

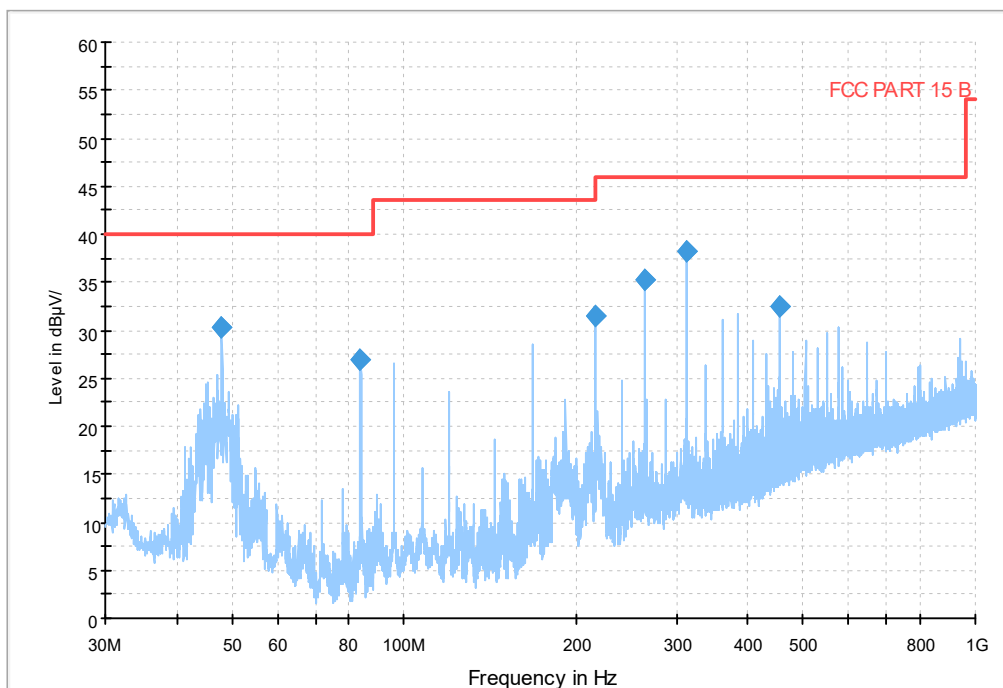

Fig.18 Radiated emission: Ch1, 30MHz-1GHz

Final Result

Frequency (MHz)	QuasiPeak (dBµV/m)	Height (cm)	Polarization	Azimuth (deg)	Margin (dB)	Limit (dBµV/m)
47.993500	30.3	200.0	V	0.0	9.7	40.0
83.980500	26.9	200.0	H	180.0	13.1	40.0
215.997500	31.5	100.0	H	0.0	12.0	43.5
264.012500	35.3	100.0	H	0.0	10.7	46.0
312.027500	38.1	100.0	H	0.0	7.9	46.0
456.024000	32.5	100.0	V	270.0	13.5	46.0

RE 1GHz-3GHz

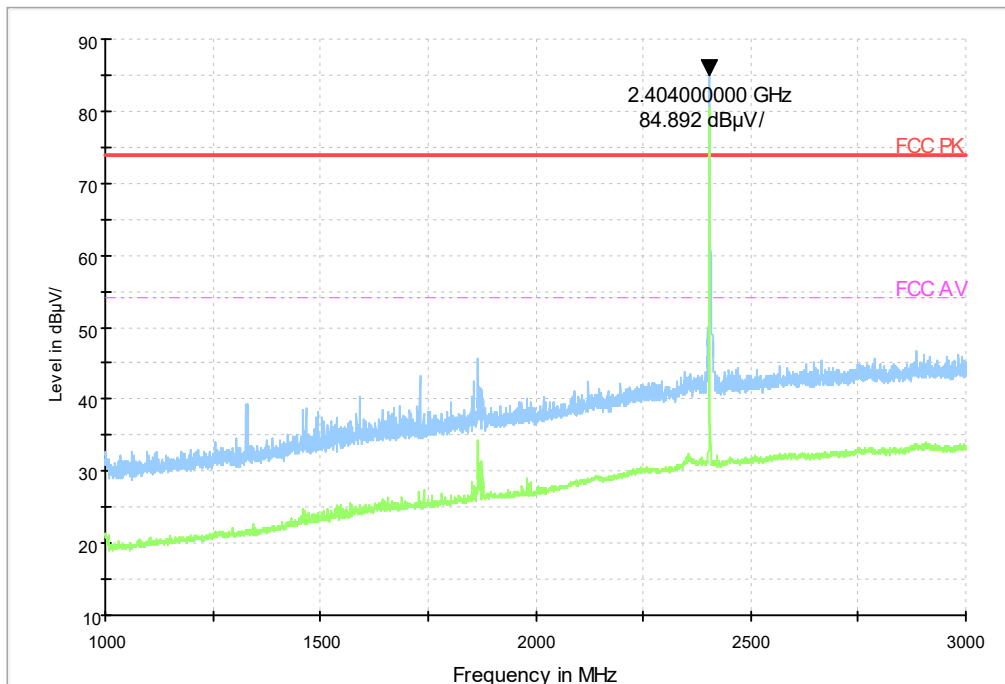

Fig.19 Radiated emission: Ch1, 1GHz-3GHz

RE 3GHz-18GHz

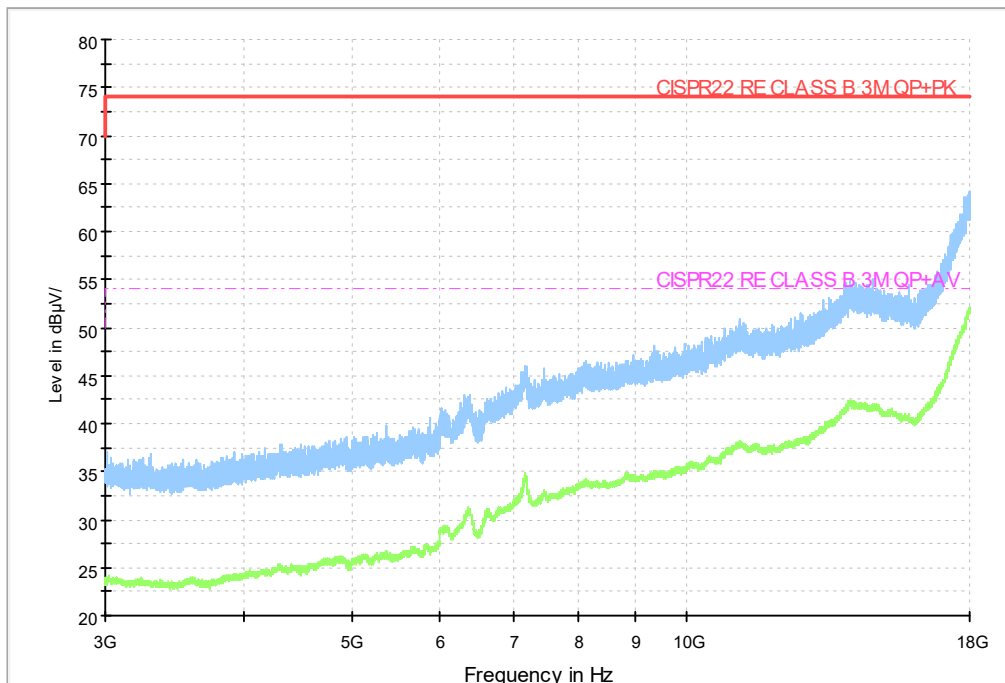

Fig.20 Radiated emission: Ch1, 3GHz-18GHz

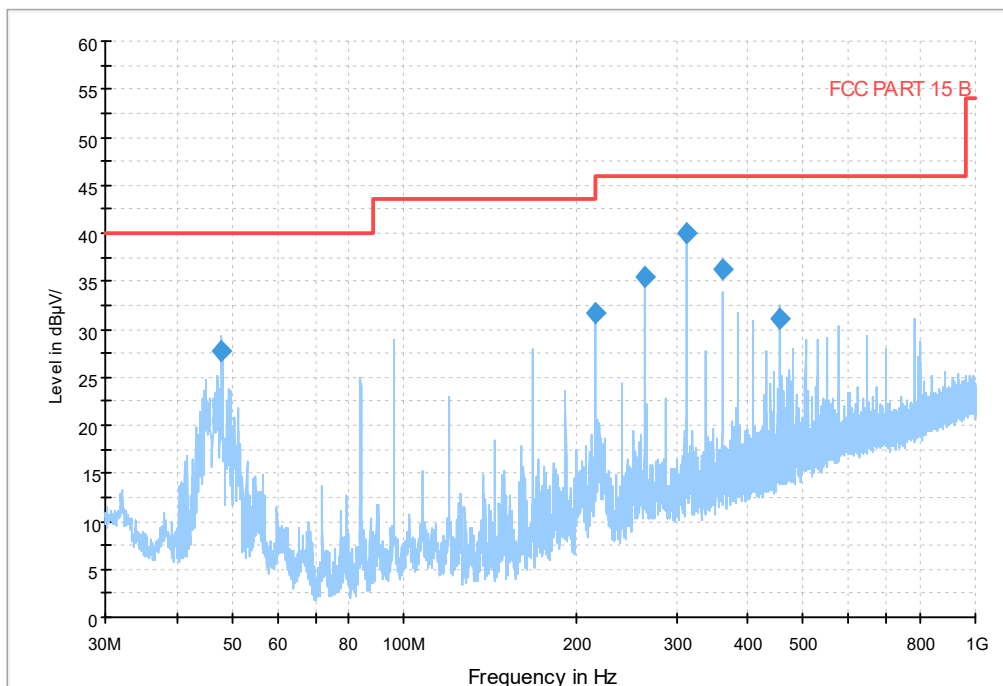

Fig.21 Radiated emission:Ch20, 30MHz-1GHz

Final Result

Frequency (MHz)	QuasiPeak (dBµV/m)	Height (cm)	Polarization	Azimuth (deg)	Margin (dB)	Limit (dBµV/m)
47.993500	27.6	100.0	V	0.0	12.4	40.0
215.997500	31.8	100.0	H	0.0	11.7	43.5
264.012500	35.5	100.0	H	0.0	10.5	46.0
311.979000	39.9	100.0	H	0.0	6.1	46.0
359.994000	36.3	100.0	H	0.0	9.7	46.0
455.975500	31.1	100.0	V	270.0	14.9	46.0

RE 1GHz-3GHz

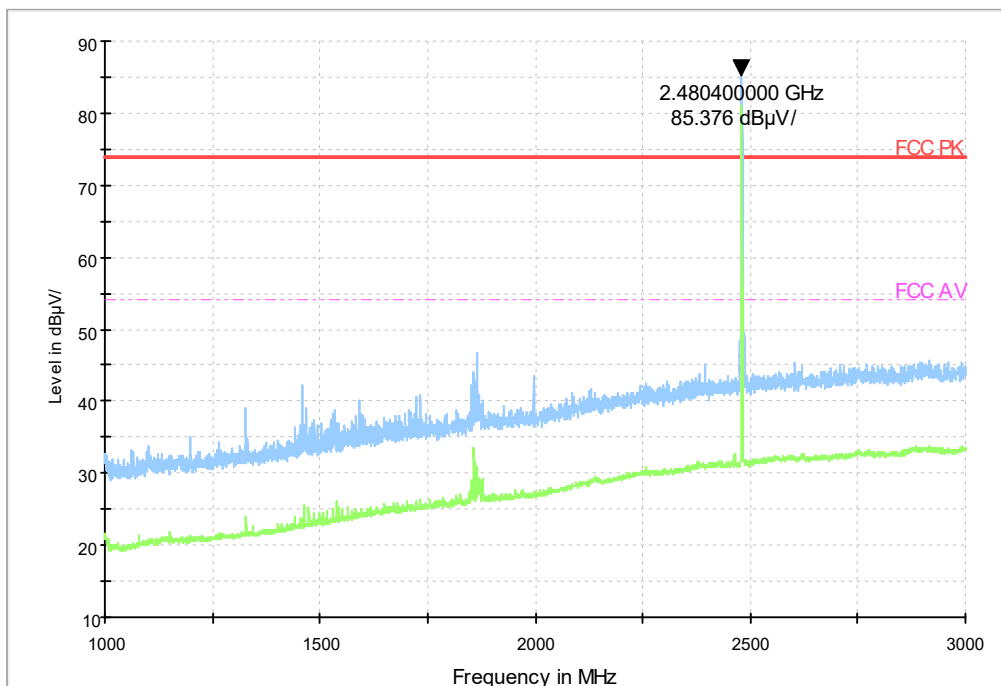

Fig.22 Radiated emission: Ch20, 1GHz-3GHz

RE 3GHz-18GHz

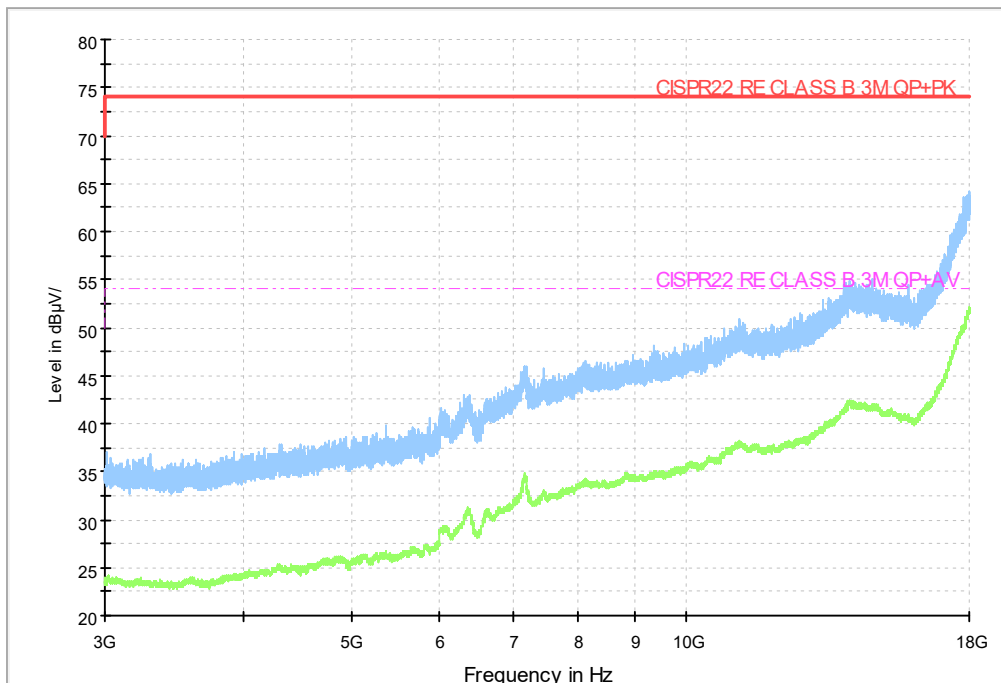

Fig.23 Radiated emission: Ch20, 3GHz-18GHz

RE 30MHz-1GHz

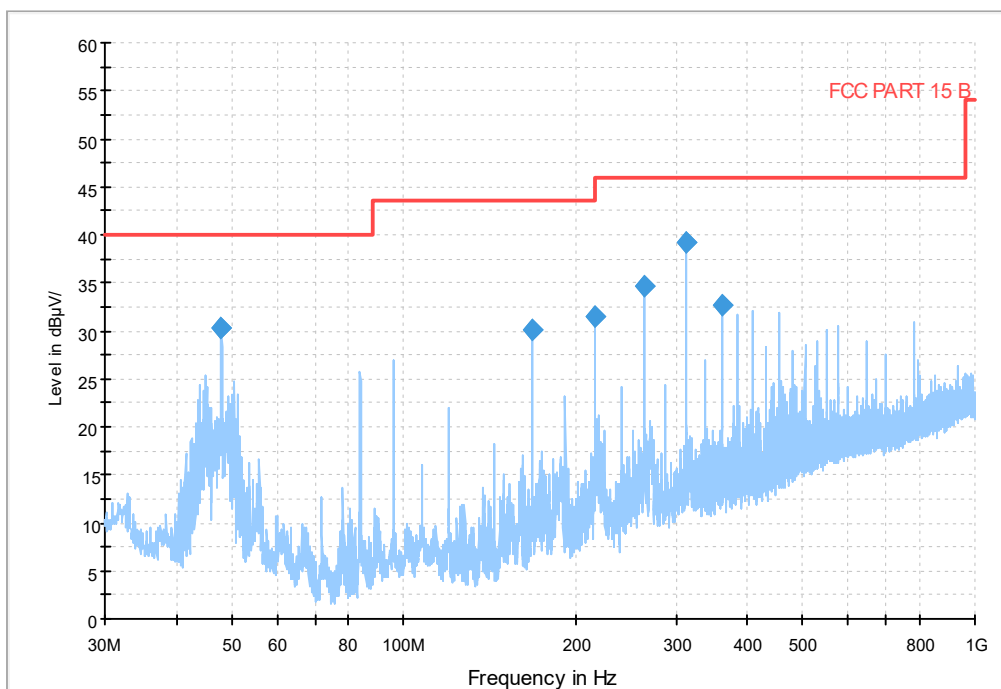

Fig.24 Radiated emission: Ch39, 30MHz-1GHz

Final Result

Frequency (MHz)	QuasiPeak (dBµV/m)	Height (cm)	Polarization	Azimuth (deg)	Margin (dB)	Limit (dBµV/m)
47.993500	30.3	200.0	V	270.0	9.7	40.0
167.982500	30.2	200.0	H	0.0	13.3	43.5
215.997500	31.5	100.0	H	0.0	12.0	43.5
264.012500	34.6	100.0	H	180.0	11.4	46.0
312.027500	39.2	100.0	H	0.0	6.8	46.0
359.994000	32.6	100.0	H	270.0	13.4	46.0

RE 1GHz-3GHz

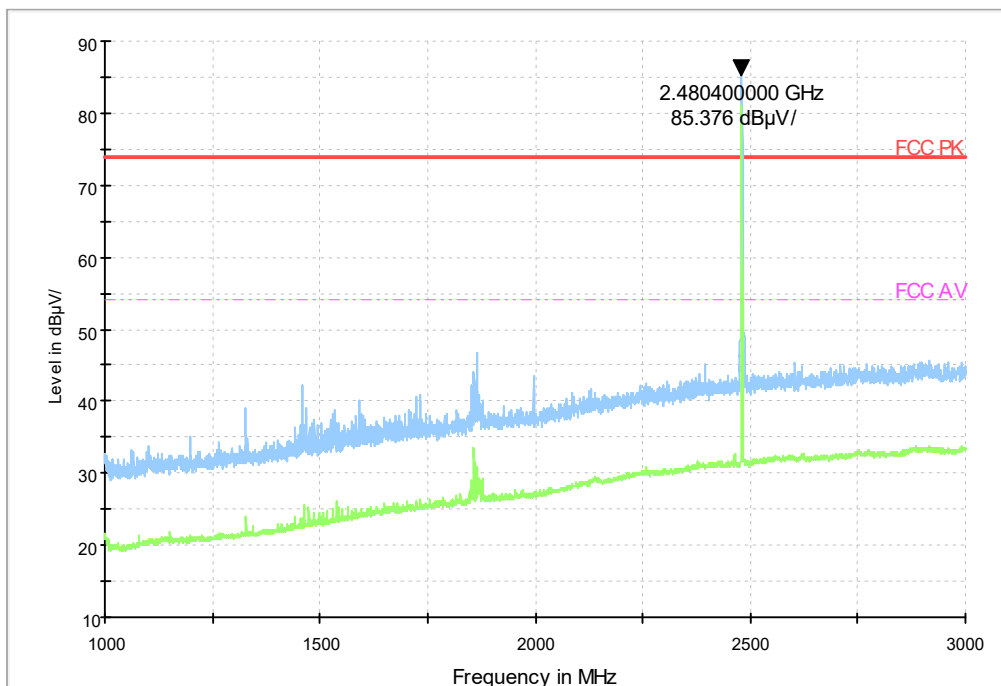

Fig.25 Radiated emission: Ch39, 1GHz-3GHz

RE 3GHz-18GHz

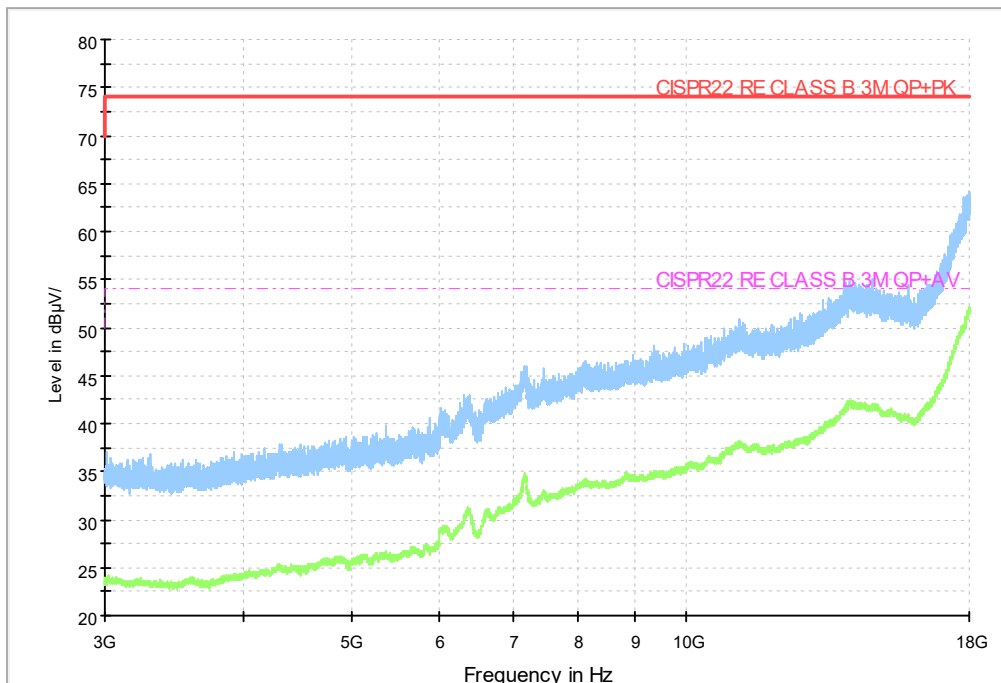

Fig.26 Radiated emission: Ch39, 3GHz-18GHz

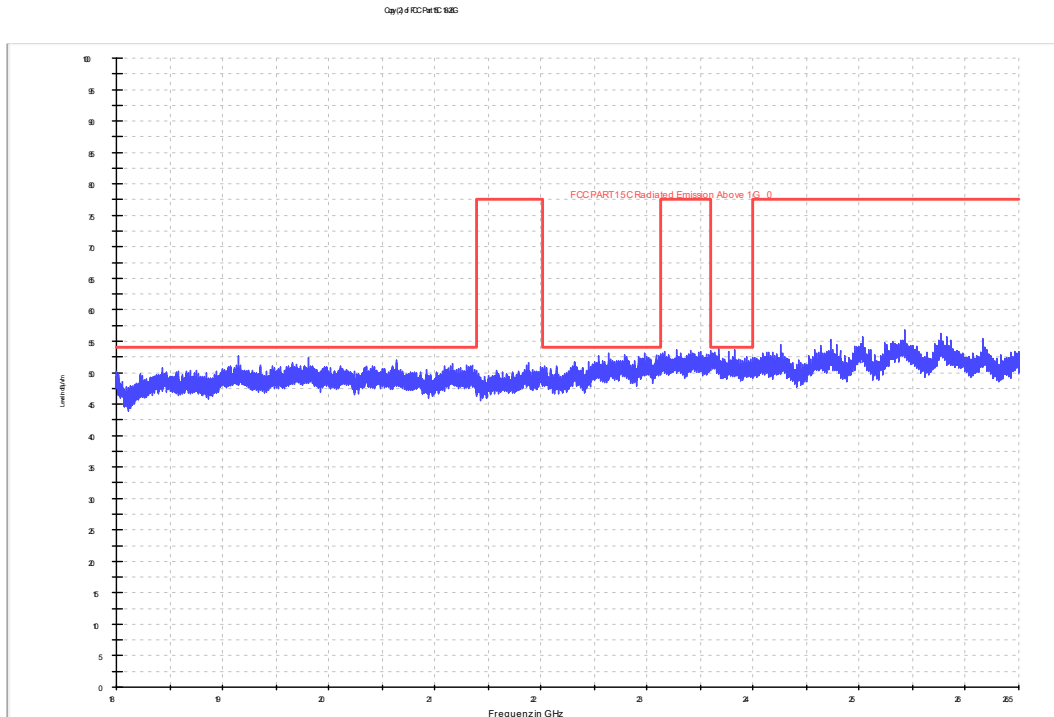

Fig.27 Radiated emission: 18 GHz - 26 GHz

Test photo

See the Pic1- Pic 2 in document" PT200LSV _Wifi_BT_ Test Setup Photos".

5.7 Power line Conducted Emissions

Specifications:	ANSI C63.10 voltage mains test
DUT Serial Number:	--
Test conditions:	Ambient Temperature:15°C-35°C Relative Humidity:30%-60% Air pressure: 86-106kPa
Test Results:	--

Limit

The EUT meets the requirement of having a peak to average ratio of less than 13dB.

For an intentional radiator which is designed to be connected to the public utility (AC) power line, the radio frequency voltage that is conducted back onto the AC power line on any frequency or frequencies within the band 150 kHz to 30 MHz shall not exceed 250 microvolt (The limit decreases linearly with the logarithm of the frequency in the range 0.15 MHz to 0.50 MHz). The limits at specific frequency range are listed as follows:

Measurement Uncertainty:

Frequency Range	Uncertainty
150 kHz to 30 MHz	1.83

Limits of the conducted disturbance at the AC mains ports:

Frequency range	Limit(Quasi-peak)	Limit(Average)
0.15 MHz to 0.5 MHz	66 dB μ V – 56 dB μ V	56 dB μ V – 46 dB μ V
>0.5 MHz to 5MHz	56 dB μ V	46 dB μ V
>5 MHz to 30 MHz	60 dB μ V	50 dB μ V

NOTE: The limit decreases linearly with the logarithm of the frequency in the range 0.15 MHz to 0.50 MHz.

Compliance with this provision shall be based on the measurement of the radio frequency voltage between each power line (LINE and NEUTRAL) and ground at the power terminals.

Test Setup

The EUT was placed in a shielding room. The WLAN TESTER was used to set the TX channel and power level. The ac adapter output is connected to Receiver through an AMN (Artificial Mains Network).

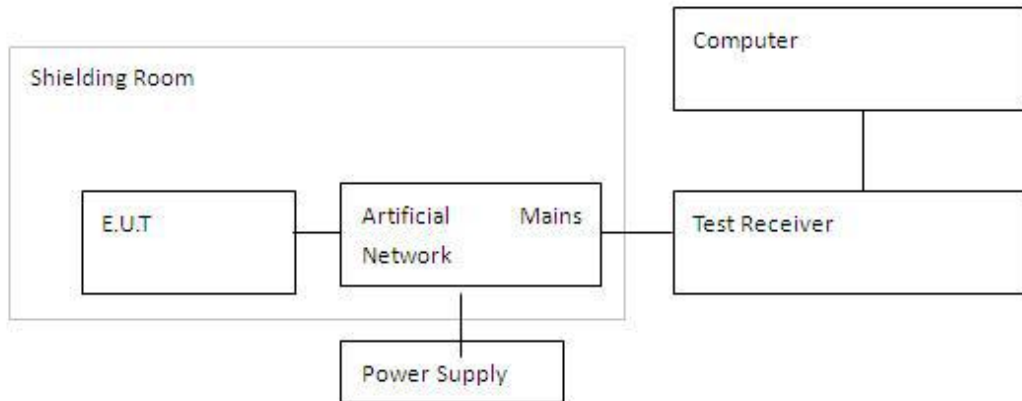

Test Procedure

1. The EUT is placed on a wooden table 80 cm above the reference ground plane.
2. The EUT is connected via LISN to a test power supply.
3. The measurement results are obtained as described below:
4. Detectors – Quasi Peak and Average Detector.

The measurement is made according to KDB 558074, and ANSI C63.10-2013.

Test Result:

Line L&N

Frequency (MHz)	QuasiPeak (dB μ V)	Meas. Time (ms)	Bandwidth (kHz)	Filter	Line	Corr. (dB)	Margin (dB)	Limit (dB μ V)
0.545362	39.8	1000.0	9.000	On	L1	9.7	16.2	56.0
0.571275	28.1	1000.0	9.000	On	N	9.7	27.9	56.0
17.281394	32.1	1000.0	9.000	On	L1	9.9	27.9	60.0
18.198744	32.7	1000.0	9.000	On	L1	9.9	27.3	60.0
18.919144	34.6	1000.0	9.000	On	L1	9.9	25.4	60.0
24.001881	42.4	1000.0	9.000	On	N	10.0	17.6	60.0

Frequency (MHz)	CAverage (dB μ V)	Meas. Time (ms)	Bandwidth (kHz)	Filter	Line	Corr. (dB)	Margin (dB)	Limit (dB μ V)
0.539275	31.5	1000.0	9.000	On	L1	9.7	14.5	46.0
0.545362	33.1	1000.0	9.000	On	L1	9.7	12.9	46.0
20.319406	24.6	1000.0	9.000	On	L1	9.9	25.4	50.0
20.477938	24.9	1000.0	9.000	On	L1	9.9	25.1	50.0
20.959869	26.0	1000.0	9.000	On	L1	9.9	24.0	50.0
24.001881	39.3	1000.0	9.000	On	L1	9.9	10.7	50.0

Conclusion: PASS

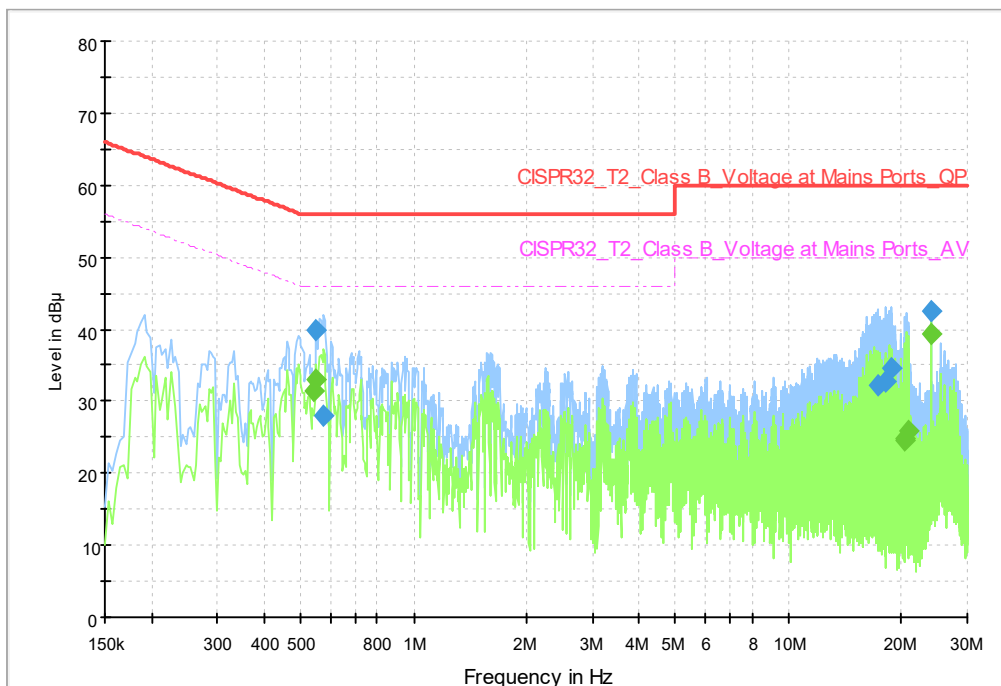

Line L&N

Test photo

See the Pic3 in document" PT200LSV _Wifi_BT_Test Setup Photos".

Annex A EUT Photos

See the document” PT200LSV -External Photos”.

See the document” PT200LSV -Internal Photos”.

ANNEX B Deviations from Prescribed Test Methods

No deviation from Prescribed Test Methods.

*****End Of Report*****